

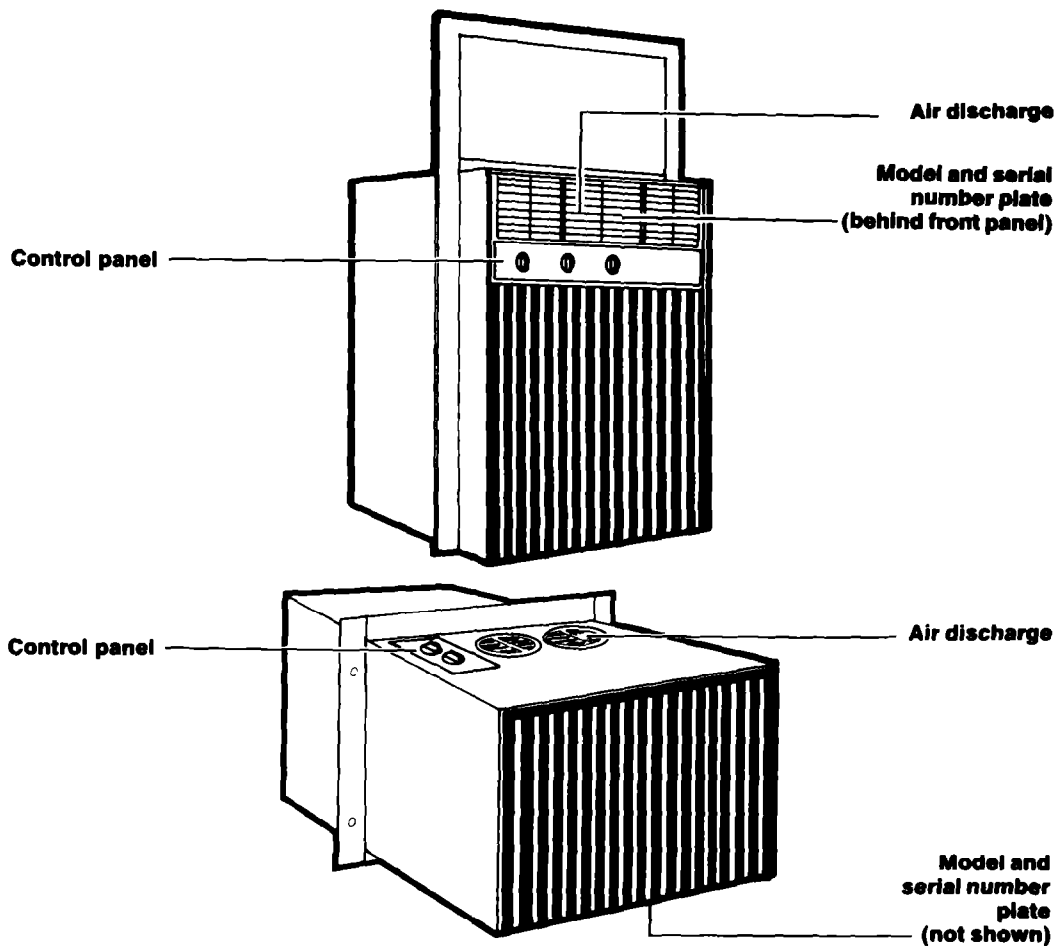

Installation Instructions and Use & Care Guide



AIR CONDITIONERS
Models ACS602 ACS802 ACS102 ACC602

2-93

Contents

	Page
Important Safety Instructions	2
Electrical Requirements	3
Receptacle wiring	3
Electrical requirements	3
Electrical connection	3
Installation Instructions	4
Installation instructions for models ACS602, ACS802 and ACS102	4
Installation instructions for model ACC602	8
Operating Instructions	11
Starting your air conditioner	11
The exhaust control	11
Changing air direction	11
Cleaning and caring for your air conditioner	12
If You Need Service Or Assistance	15
Whirlpool Room Air Conditioner Warranty	16

©1990 Whirlpool Corporation

Thank you for buying a Whirlpool appliance. Please complete and mail the Owner Registration Card provided with this product. Then complete the form below. Have this information ready if you need service or call with a question.

- Copy model and serial numbers from plate (see diagram on page 12) and purchase date from sales slip.
- Keep this book and sales slip together in a handy place.

Model Number

Serial Number

Purchase Date

Service Company Phone Number

Important Safety Instructions

⚠ WARNING

To reduce the risk of fire, electrical shock or personal injury when using your air conditioner, follow these basic precautions:

- Read all instructions before using your air conditioner.
- Complete the installation requirements as described in the Installation Instructions.
- Never allow children to operate or play with the air conditioner.
- Do Not operate the air conditioner with the front panel removed.
- Never clean air conditioner parts with flammable fluids. The fumes can create a fire hazard or explosion.

• FOR YOUR SAFETY •

DO NOT STORE OR USE GASOLINE OR OTHER FLAMMABLE VAPORS AND LIQUIDS IN THE VICINITY OF THIS OR ANY OTHER APPLIANCE. THE FUMES CAN CREATE A FIRE HAZARD OR EXPLOSION.

It is your responsibility to be sure your air conditioner:

- Is installed in a window that will hold the weight, and is secured according to the Installation Instructions.
- Is connected only to the proper kind of outlet, with the correct electrical supply and grounding. (See Installation Instructions.)
- Is the right size for the area you want to cool.
- Is used only to do what window air conditioners are designed to do.
- Is not used by anyone unable to operate it properly.
- Is properly maintained.
- Also, remove the Energy Label and Buy Guide. Use a damp cloth to take off any glue residue. Do not use sharp instruments, flammable fluids or abrasive cleaners. These can damage the material.

– SAVE THESE INSTRUCTIONS –

Electrical Requirements

Electrical requirements are different for the two models pictured on the cover, depending on the ampere rating of your unit. The number of amperes is printed on the serial plate, which is attached to the front of the unit behind the front panel. (See diagram on page 12.)

Observe all local governing codes and ordinances.

Do not, under any circumstances, remove the power supply cord grounding prong.

Receptacle wiring

Receptacle wiring should be a minimum of 14 gauge. Use copper wire only. It is the responsibility of the consumer to provide proper and adequate receptacle wiring installed by a qualified electrician. Observe National Electrical Code and all local governing codes and ordinances.

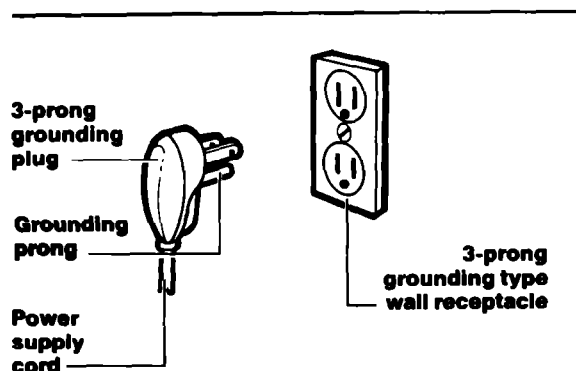

Electrical requirements

⚠ WARNING

Electrical Shock Hazard

- Check with a qualified electrician if you are in doubt as to whether the appliance is properly grounded. Do not modify the power supply cord plug – if it will not fit the outlet, have a proper outlet installed by a qualified electrician. Improper connection of the equipment-grounding conductor can result in a risk of electrical shock.
- Do not use an extension cord with this appliance. Such use may result in a fire, electrical shock or other personal injury.
- Do not have a fuse in the neutral or grounding circuit. This could result in a risk of electrical shock.

A 115 volt, 60 Hz AC only, 15 ampere fused electrical supply is required (time delay fuse or time delay circuit breaker required). It is recommended that a separate circuit, serving only this appliance, be provided for models with serial plate amperes up through 7.5. A separate circuit is **required** for models with serial plate amperes of 7.6 through 12.0.

Electrical connection

Electrical ground is required on this appliance.

Recommended grounding method

For your personal safety, this appliance must be grounded. This air conditioner is equipped with a power supply cord having a 3-prong grounding plug. To minimize possible shock hazard, the cord must be plugged into a mating 3-prong grounding type wall receptacle, grounded in accordance with the National Electrical Code, ANSI/NFPA 70-1987 (or to the latest), and local codes and ordinances. If a mating wall receptacle is not available, it is the responsibility of the customer to have a properly grounded 3-prong wall receptacle installed by a qualified electrician.

Electrical Requirements Continued

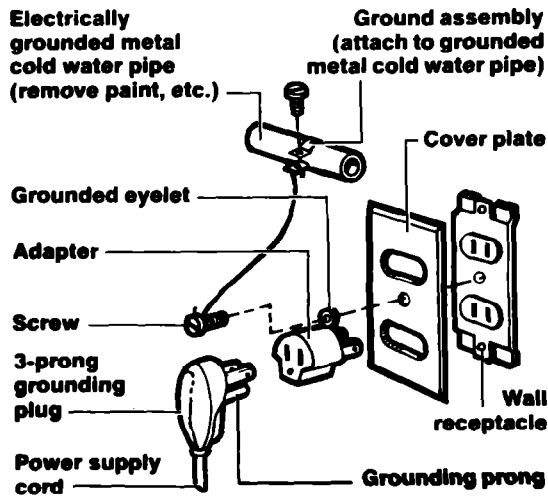

Temporary grounding method

If changing and properly grounding the wall receptacle is impossible and where local codes permit (consult your electrical inspector), a temporary adapter may be plugged into the existing 2-prong wall receptacle to mate with the 3-prong power supply cord. This, however, is **not** recommended.

If this is done, however, you **must** connect the grounded eyelet on the adapter to the wall receptacle cover plate screw and from this same screw, you must connect a separate copper ground wire (#14 minimum) to a grounded cold water pipe.

*Do not ground to a gas supply pipe. Do not connect to electrical supply until appliance is grounded. Do **not**, under any circumstances, remove the power supply cord grounding prong.

*Cold water pipe must have metal continuity to electrical ground and not be interrupted by plastic, rubber or other electrically insulating connectors (including water meter or pump) without adding a jumper wire at these connections.

Installation Instructions

For models ACS602, ACS802 and ACS102, follow installation instructions below. For model ACC602, follow installation instructions on page 8.

Installation Instructions for models ACS602, ACS802 and ACS102

To help avoid any installation problems and to help assure trouble-free performance of your new air conditioner, read these installation instructions, as well as the operating instructions and electrical requirements before installing your unit.

⚠ WARNING

Personal Injury Hazard

- Because this air conditioner weighs about 90 to 105 pounds, it is recommended that you have someone help you install your new unit and that you both use proper lifting techniques.
- Inspect the condition of the window where the air conditioner will be installed. Be sure it will support the weight of the unit.
- This appliance must be installed according to all applicable codes and ordinances.
- Handle the air conditioner with care. Watch out for the sharp metal fins on the front and rear coils.
- Be sure air conditioner does not fall out of window during or after installation.
- Do not use the collected water for drinking purposes. It is not sanitary.

Failure to follow the above precautions could result in personal injury.

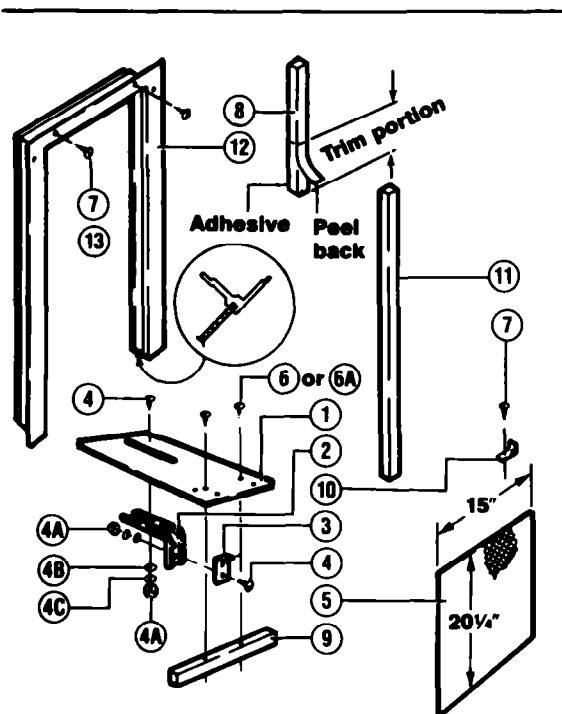

1. Unpack mounting parts before installing your air conditioner. Make sure you have all the necessary parts. A normal installation can be made with a screwdriver, saw, small level, pocket knife, tape measure, drill and $\frac{1}{8}$ " , $\frac{3}{64}$ " and $\frac{3}{16}$ " drill bits.

Description of parts

- 1 Shelf (1)
- 2 Support bracket (1)
- 3 Sill bracket (1)
- 4 $\frac{5}{16}$ " bolt (2)
- 4A $\frac{5}{16}$ " nut (2)
- 4B $\frac{5}{16}$ " flat washer (2)
- 4C $\frac{5}{16}$ " lockwasher (2)
- 5 Translucent panel (1)
- 6 Screw – 10 x 1" (2)
- 6A Screw – 10 x 1 $\frac{3}{4}$ " (2)
- 7 Screw – 8 x $\frac{3}{4}$ " (5)
- 8 Side seal strip (1)
- 9 Lower track seal (1)
- 10 Locking bracket (1)
- 11 Foam seal strip (1)
- 12 Panel frame (1)
- 13 Thread cutting screw # $\frac{8}{32}$ x $\frac{3}{4}$ " (4)

If using Item 13 for fastening Item 10 or 12 to metal or plastic, use $\frac{3}{64}$ " dia. or #28 drill.

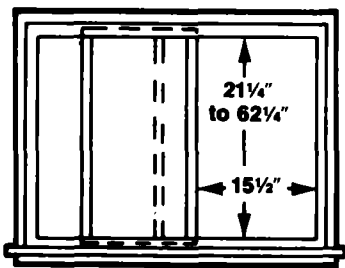

2. Pick the correct window. First, decide what room(s) you want to cool. Then choose a window that will allow the air-conditioned air to flow freely and directly into the room(s) you want cooled. Remember, it's difficult to move air around corners. If the inner sliding window slides to the left, the unit will be installed on the right. Remove window screen if there is one. Choose a sliding window that's also near an electrical outlet. (Refer to "Electrical Requirements" on page 3 for type of receptacle and wiring needed.) **Do not use an extension cord.**

The sliding window in which you place your air conditioner should have an opening of at least 15 $\frac{1}{2}$ " wide and 21 $\frac{1}{4}$ " to 40 $\frac{7}{8}$ " high (see diagram). For installations up to 62 $\frac{1}{4}$ " high, a special kit (Part No. 977449) is available. For windows as low as 20 $\frac{7}{16}$ ", you must install without filler frame and remove top angle on unit, reinstalling 3 screws into top of cabinet.

This model may also be installed in steel hinged casement windows. The steel hinged casement window must have an opening of at least 15 $\frac{1}{2}$ " wide and no more than 16 $\frac{1}{2}$ " wide.

3. Place shelf in window with tabs down against the track surface.

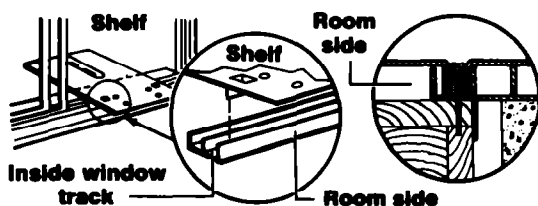

**Installation Instructions
Continued**

Room side

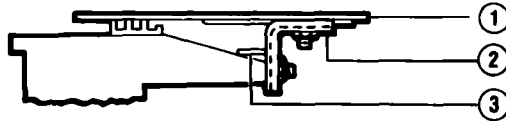

4. Attach support bracket (Item 2) loosely to the underside of shelf with either short or long leg down and with end of bracket either toward or away from window, depending upon construction and depth of wall and window sill (see diagram). Attach sill bracket (Item 3). Each bracket is attached using one $\frac{5}{16}$ " bolt, nut and washers (Items 4, 4A, 4B and 4C).

5. With the assembled shelf and brackets still in the window opening, adjust brackets until shelf is firmly seated and sloping down to outside. If you use a level, be sure you have $\frac{1}{2}$ bubble of slope. Without a level, place the translucent panel (Item 5) on shelf. The top of long side of the panel will be $\frac{5}{16}$ " back from the window line (see diagram).

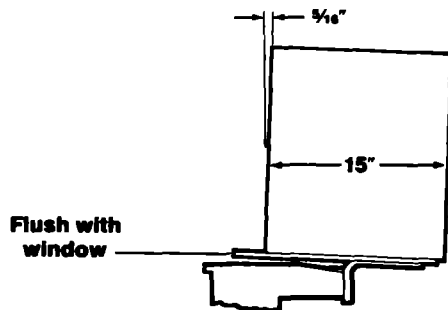

6. If slope back is correct, tighten all nuts securely. Install lower track seal (Item 9) shown in diagram. This track seal has two holes which line up with matching screw holes in shelf.

Use screws 6 or 6A

Shelf
Room side

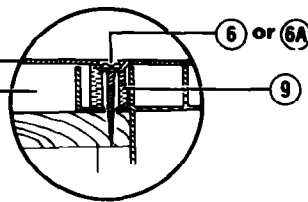

Predrill $\frac{1}{4}$ " holes
if tracks are metal

7. Install shelf $2\frac{3}{8}$ " from side of window opening, securing it in place with screws 6 or 6A.

8. Measure height of opening (see diagram). Subtract $20\frac{5}{16}$ " from measured height. This will be the actual height of translucent panel.

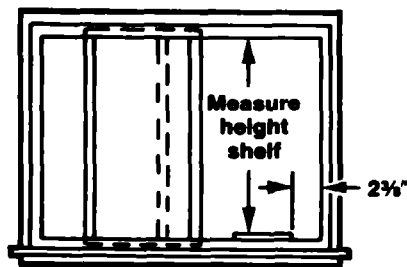

9. Measure out the distance determined in Step 8 and mark it along the $20\frac{3}{4}$ " side of translucent panel. Clamp panel between a board and an appropriate supporting surface close to the mark and cut with fine tooth saw. Remove burrs.

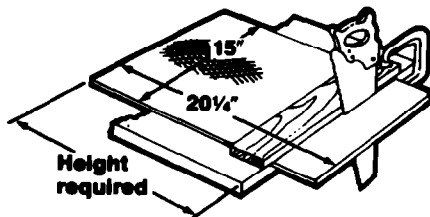

10. Lift vertically removing panel frame from unit. Slide translucent panel into groove in frame, keeping honeycomb side to the face side of frame (see diagram). Slide frame back into place on unit. Panel should enter the top angle groove.

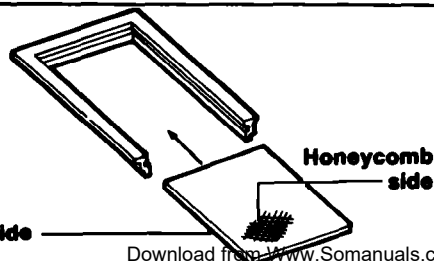

Butt to bottom of filler frame. Cut off excess length below unit.

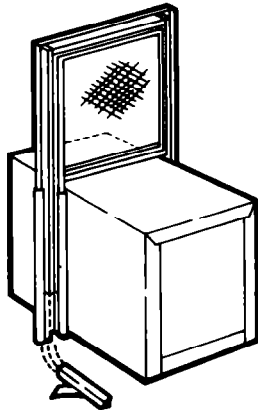

11. Peel backing from seal strip (Item 8) and press it onto side filler frame guides on each side of unit.

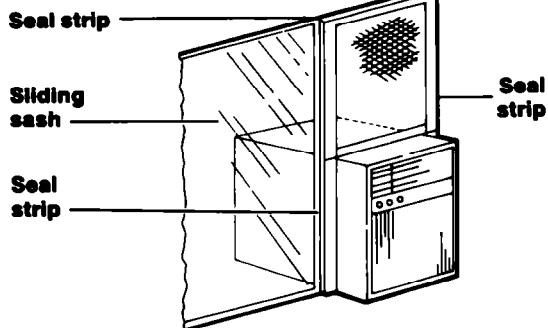

12. Place unit in window by resting unit on shelf. Push unit toward window so side angles are sealing against the side jamb stop (see diagram). Slide the opened window sash firmly to make certain the frame and unit sealing strips are sealing.

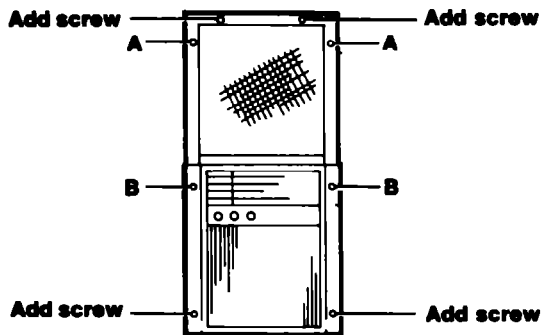

13. Using $\frac{1}{8}$ " drill, install locking screws (Item 7). Use two screws in top jamb and in the side bottom flanges. If you need additional holding strength, add two more screws at upper sides of filler frame (marked "A"). Also, two screws can be added at unit sides (marked "B"). However, if you add screws at "B," you must use a $\frac{3}{16}$ " drill bit to predrill through the plastic sides of air conditioner.

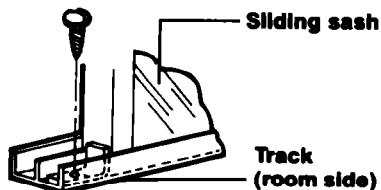

14. Lock the sliding sash at bottom using lock bracket (Item 10) and screw (Item 7) as shown in diagram at left. Use a $\frac{1}{8}$ " drill bit to drill through track before inserting screw.

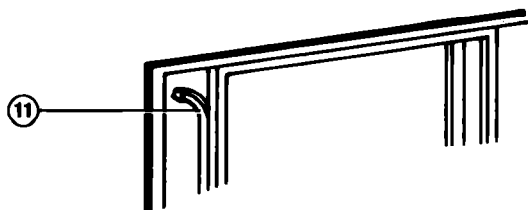

15. Cut seal strip (Item 11) to length. Install it between space of opened sash and glass of the closed sash (see diagram).

Installation Instructions Continued

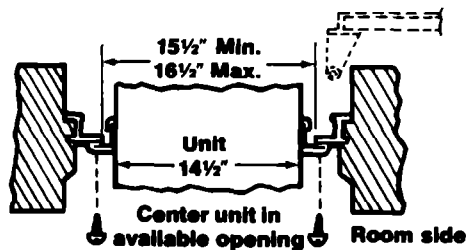
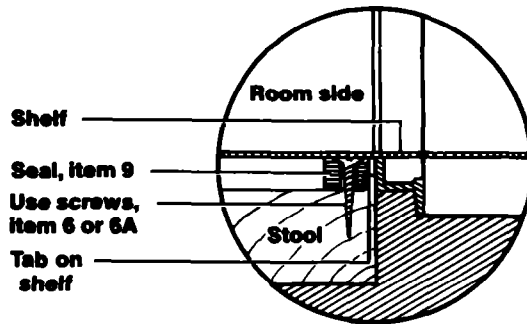
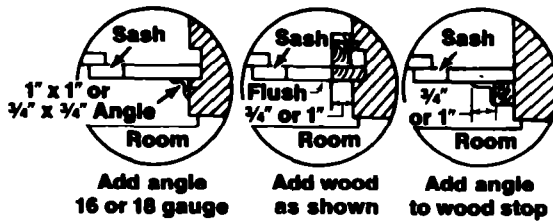

16. For installation in windows having no side flanges or with wood stops.

The flanges (top and two sides) on the air conditioner must mate against companion flanges on the window, not more than 1/16" (.2 cm) in thickness. On the side with the opened sash, the leading edge of the sash becomes the flange. On the top and jamb side of most metal windows, the flange is there.

In windows where there are no flanges or where there are thick wood flanges or stops, use metal angles or wood to provide a stop for the unit flange. Diagrams at left show three suggested methods.

17. For installation in steel casement windows.

Follow Steps 2 and 3 on page 5. **NOTE:** In Step 3, the shelf tabs must butt to the front of the bottom angle on the casement (see diagram at left).

When Step 3 is finished, follow Steps 4 through 10 on page 6, and Steps 11 and 12 on page 7. Then proceed with the final two paragraphs in this Step 17, which immediately follow.

Open window at least 180° to allow room for unit cabinet. If necessary, remove window crank handle so the window will open wide enough. Tie opened window to the wall or frame to prevent the window from swinging.

Drill 3/16" holes in the window jamb top to line up with holes in filler frame (see diagram at left). Use two thread cutting screws (Item 13) to secure unit. If you need additional holding strength, add screws at the bottom of the unit side channels (see Step 13 diagram).

Installation instructions for model ACC602

To help avoid any installation problems and to help assure trouble-free performance of your new air conditioner, read these installation instructions, as well as the operating instructions and electrical requirements before installing your unit.

Inspect the condition of the window where the air conditioner will be installed. Be sure it will support the weight of the unit.

⚠ WARNING

Personal Injury Hazard

Be sure air conditioner does not fall out of window during installation. Personal Injury or damage could result.

⚠ WARNING

Personal Injury Hazard

- Because this air conditioner weighs about 70 to 75 pounds, it is recommended that you have someone help you install your new unit and that you both use proper lifting techniques.
 - This appliance must be installed according to all applicable codes and ordinances.
 - Handle the air conditioner with care. Watch out for the sharp metal fins on the front and rear coils.
 - Do not use the collected water for drinking purposes. It is not sanitary.
- Failure to follow the above precautions could result in personal injury.

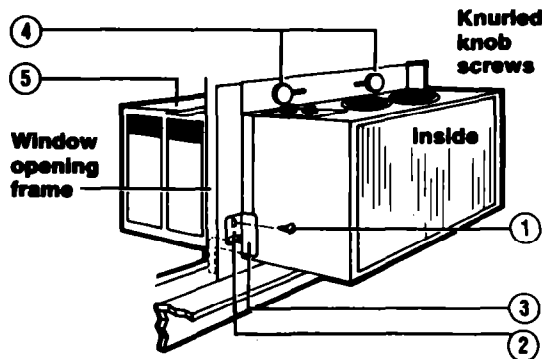

1. Unpack mounting parts before installing your air conditioner. Be sure you have all the necessary parts (see top two diagrams at left). This air conditioner will fit most steel casement windows. A normal installation can be made with a screwdriver, $\frac{5}{16}$ " socket driver, tape measure and drill.

Description of parts (top two diagrams at left)

- 1 #10 x $\frac{3}{8}$ " long s.m. screw
- 2 #10-32 x $\frac{3}{8}$ " long mach. screw
- 3 Bottom mounting bracket
- 4 Knurled knob screw
- 5 Top mounting bracket

NOTE: Above parts (not shipped loose) installed on unit by factory.

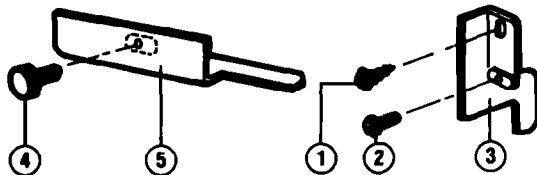

2. Pick the correct window. First, decide what room(s) you want to cool. Then choose a window that will allow the air-conditioned air to flow freely and directly into the room(s) you want cooled. Remember, it's difficult to move air around corners. Choose a window that's also near an electrical outlet. (Refer to "Electrical Requirements" on page 3 for type of receptacle and wiring needed.) **Do not use an extension cord.**

To be able to use the window mounting parts shown in the diagram to the left of Step 1 above, the window should have a minimum width of $14\frac{1}{2}$ " and a maximum width of 16" (see "A" in bottom diagram). The window should have a minimum height of $10\frac{5}{8}$ " and a maximum height of $11\frac{1}{4}$ " (see "B" in bottom diagram).

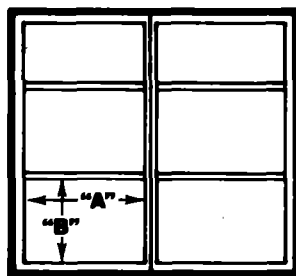

3. Remove the glass from the frame opening selected. Clear away any hardened putty.

4. Before sliding unit through the casement opening, remove the bottom window bracket (Item 3) on both sides of the unit. **NOTE:** Only the top screws (Item 1) need to be removed.

**Installation Instructions
Continued**

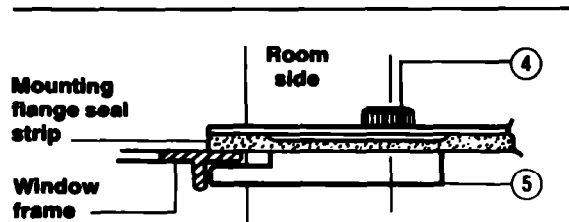

5. Check the knurled knob screws to see that the top mounting brackets (Item 5) are retracted to the center of the unit. They must not interfere with the window frame when the unit is installed.

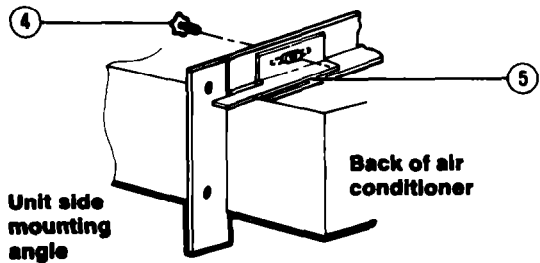

6. Lift the unit into the window opening and slide it back until the mounting frame comes into contact with the window frame.

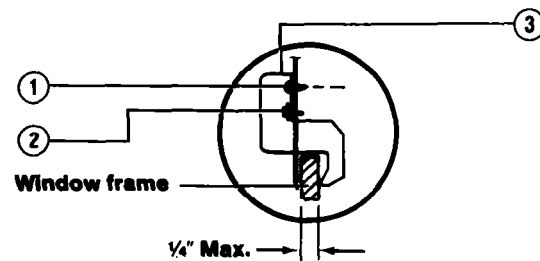

7. Replace the bottom mounting brackets (Item 3) by hooking the bracket over the window frame. Replace the top screws (Item 1) in the mounting bracket, leaving them loose enough so there is about $\frac{1}{16}$ " of play. Tighten the bottom screws (Item 2). This will pull the unit mounting flange tightly to the window frame, sealing and locking the air conditioner in place.

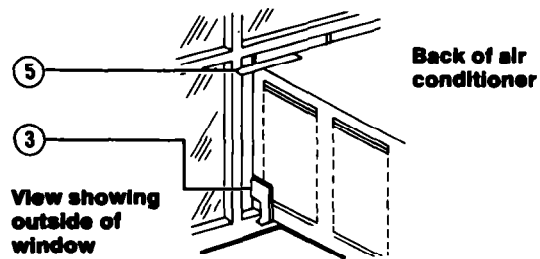

8. Loosen the two knurled knob screws and slide the top mounting bracket (Item 5) toward the outside of the unit, engaging the window frame. Tighten the knurled knob screw in this position. This will lock the unit in place so it cannot tilt into the room. **The installation is now complete.**

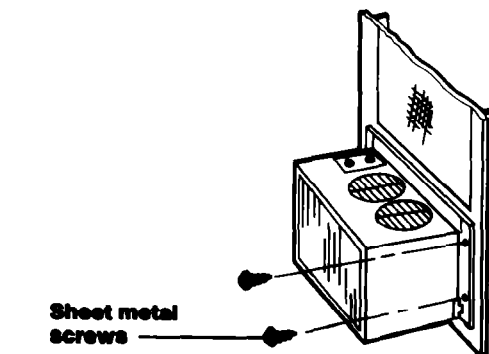

9. Optional mounting instructions. If the window thickness will not allow you to use the four mounting brackets provided with the unit, remove brackets and fasten flanges of unit with sheet metal screws. These screws are not included with your air conditioner. The window opening for your installation must not be wider than 15".

Operating Instructions

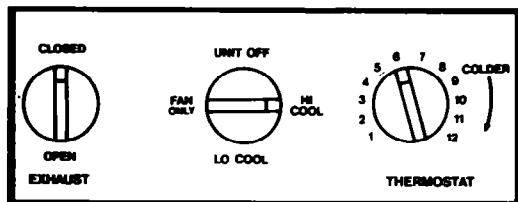

Models
ACS602
ACS802
ACS102

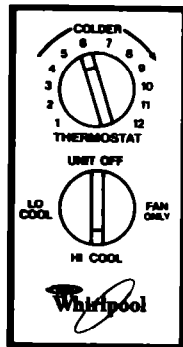

Model
ACC802

Starting your air conditioner

1. Set exhaust control (if your unit is so equipped) to CLOSED for maximum cooling.
2. Choose either LO COOL or HI COOL fan speed setting.

LO COOL for sleeping comfort
 HI COOL for maximum cooling
 FAN ONLY for circulating room air
 when no cooling is desired

3. Turn the thermostat control to number 6 (mid-setting). You can adjust the air conditioner's cooling performance by resetting the thermostat control to a higher number for maximum cooling. Lower the number setting for less cooling. You will need to experiment to find the setting which suits you best.

NOTE: If you turn your air conditioner off or if the compressor shuts off, wait at least three minutes before turning it back on or you may blow a fuse or trip a circuit breaker.

The exhaust control

The exhaust control setting draws stale or smoky air from the room.

1. To exhaust room air

Set exhaust control to OPEN. Adjust fan control to speed desired. If no cooling is desired, use FAN ONLY setting.

2. To circulate room air

Set exhaust control to CLOSED. Adjust fan control to FAN ONLY.



Open

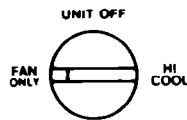

Fan only

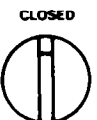

Closed

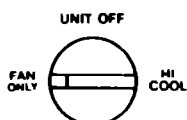

Fan only

Changing air direction

The louvers in the grille area at the top of the air conditioner control the direction of the cooled air

If your unit looks like Figure A, move the lever at the top of the grille to the right, left or straight ahead. Simply move the lever in the direction you want the air to go. The rear vertical louvers in the grille can be adjusted left, right or straight ahead. The front set is fixed and directed upward.

If your unit looks like Figure B, turn the circular air discharge grilles on top of the unit. Both grilles can be adjusted to the right or left, or adjusted individually.

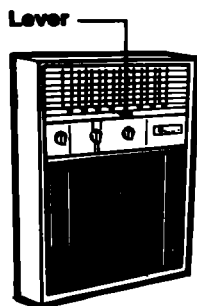

Figure A

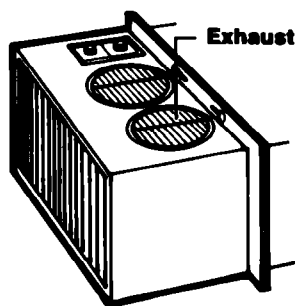
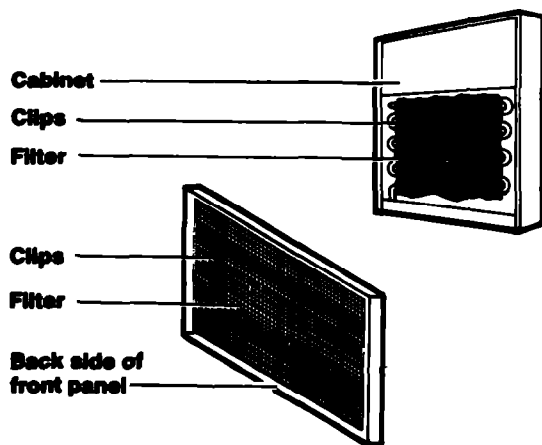
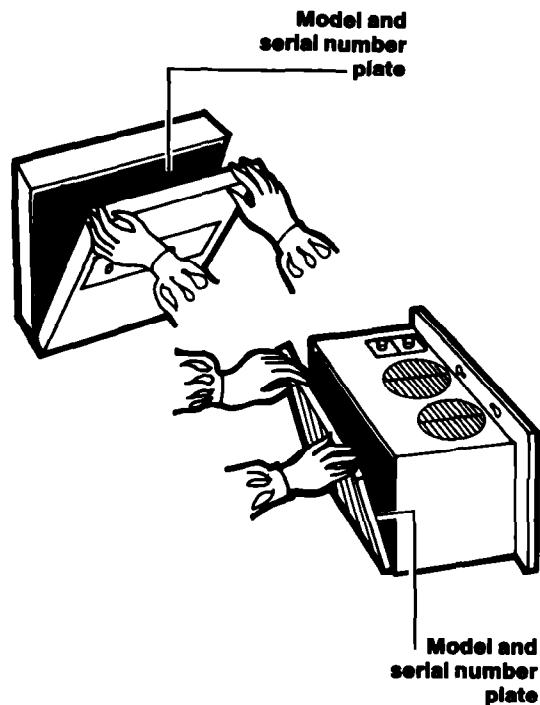

Figure B



Cleaning and caring for your air conditioner

Proper use and care of your air conditioner will help ensure longer life of the unit and lower operating costs. Follow these instructions carefully. Call your Whirlpool servicing dealer for an annual checkup.

Cleaning front panel

⚠ WARNING

Electrical Shock and Fire Hazard

- Unplug power cord from receptacle before cleaning unit. Failure to do so could result in electrical shock or personal injury.
- Do not use flammable fluids, solvents, abrasive cleaners, or strong detergents. Fire or product damage could result.

1. Remove the front panel from unit when cleaning. Press down at top edge of the front, as shown in diagrams at left (depending on your model).
2. When the front moves away from top of cabinet, pull top of front toward you.
3. Lift up and away from the bottom spring clips.
4. Clean front panel with warm water and mild soap or detergent. Use a soft cloth. Rinse and dry. Replace front panel.
5. Wipe control panel clean with a soft dry cloth.

Cleaning air conditioner filter

The filter is cleanable. A clean filter helps remove dust, lint and other particles from the air. Check every two weeks to see if filter needs cleaning.

1. Remove front panel as shown above.
 2. Remove filter by releasing it from plastic clips as shown in diagrams at left (depending on your model).
 3. Clean filter, using a vacuum cleaner.
- OR –
4. If very dirty, wash filter with warm water and mild detergent. Air dry thoroughly before replacing.

Annual maintenance for your air conditioner

Your air conditioner needs annual maintenance to help ensure steady, top performance throughout the year.

Call the service company recommended by your dealer to:

- Inspect and clean the coils and condensate water passages.
- Check fan and oil the fan motor.
- The compressor is sealed and needs no oiling.

Expense of annual inspection is customer's responsibility.

– OR –

If you are familiar with electrical appliances, you can do the cleaning and maintenance yourself. If you choose to do so, follow these steps:

⚠ WARNING

Electrical Shock and Personal Injury Hazard

- **Disconnect power cord from receptacle before performing any maintenance. Be sure no liquid gets into the motor, electrical control box or compressor electrical terminals.**
- **Because your air conditioner weighs from 70 to 105 pounds, it is recommended that you have someone help you when you remove and reinstall your unit and that you both use proper lifting techniques.**
- **Handle the air conditioner with care. Watch out for the sharp metal fins on the front and rear coils.**
- **Do not use the collected water for drinking purposes. It is not sanitary.**

Failure to follow the above precautions could result in electrical shock or personal injury.

1. Disconnect power supply.
2. Remove unit from cabinet. Wrap the motor, electrical control box and electrical terminals box in plastic film and make sure no water or other liquid gets inside any of these parts. It could damage the insulation and cause serious trouble.
3. Carefully clean and hose out the base, coils and condensate pans. Clean at least once a year or more often if the condenser coils and pans collect dirt, sand, leaves, insects or algae. Also, clean if you detect an odor from the air conditioner. While the cabinet is open, this is a good time to oil the fan motor. See page 14.
4. Remove plastic film from motor and electrical parts.
5. Replace unit in cabinet.
6. Reconnect power supply.

NOTE: It is a good idea to wait 24 hours before starting the unit again. This allows time for all areas to dry out.

Operating Instructions Continued

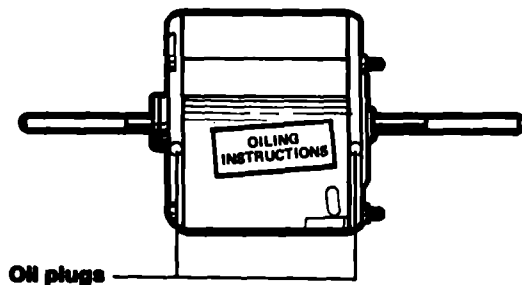

Oiling the fan motor

⚠ WARNING

Electrical Shock Hazard
Disconnect power cord from receptacle before oiling motor. Failure to do so could result in personal injury.

1. Oil the fan motor per instructions on the motor. To add oil, pull out the oil hole plug at each end of the motor (see diagram). An easy-to-use one-ounce capsule of especially recommended oil (Part No. 10943) can be ordered from your Whirlpool servicing dealer, or use SAE #20 non-detergent oil.
2. Replace the plug to keep dirt from motor bearings.
3. Reinstall the unit in cabinet after performing maintenance. Refer to the "Installation instructions" section for your unit.

Energy saving tips

- Improve home insulation (seal doors, windows, and close fireplace flue).
- Close blinds or drapes on sunny side of house; add window awnings.
- Keep air filter clean. Don't block air flow with drapes or furniture.
- Ventilate attic (high temperature levels add to normal cooling load).
- Try not to use heat producing appliances during the hottest part of the day. Turn lights, radios, televisions, and other appliances off when not needed.
- Keep heat registers and cool air returns closed or blocked off so cooled air won't escape.
- Use a vent fan in areas where cooking, laundry, or bathing is done to pull out extra heat and moisture near its source.

If You Need Service Or Assistance

We suggest you follow these steps:

1. Before calling for assistance...

Performance problems often result from little things you can find and fix yourself without tools of any kind.

Air conditioner won't run:

- Is unit plugged into a live circuit with proper voltage?
- Is switch turned on?
- Is thermostat set correctly?
- Has a fuse blown or a circuit breaker tripped?
- Has the local power failed?

Unit blows fuses or trips circuit breaker:

- Are time-delay fuses being used?
- Is an extension cord being used? (**Do not use an extension cord to run your air conditioner.**)
- Are you waiting three minutes after turning cooling circuit off before trying to restart unit?

Unit turns on and off, or does not cool room:

- Is filter clean?
- Are coils clean (both evaporator [inside] and condenser [outside])?
- Is there excessive moisture or heat (open vessel cooking, showers, etc.)?
- Try setting fan to higher speed.
- Try setting thermostat to a cooler setting.

Operating sounds:

- When your room air conditioner is **operating normally**, you will hear sounds such as:
- Droplets of water hitting the condenser, causing a "pinging" or "clicking" sound. Water droplets help to cool the condenser.
- Air movement from the fan, especially on high fan speed setting.
- Clicks from the thermostat cycle.
- Sounds also may be caused by house construction – such as vibration of the unit due to wall construction or unsteady window mounting area.

2. If you need assistance*...

Call Whirlpool COOL-LINE® service assistance telephone number. Dial free from anywhere in the U.S.:

1-800-253-1301

and talk with one of our trained consultants. The consultant can instruct you in how to obtain satisfactory operation from your appliance or, if service is necessary, recommend a qualified service company in your area.

3. If you need service*...



Whirlpool has a nationwide network of authorized Whirlpool™ service companies. Whirlpool service technicians are trained to fulfill the product warranty and provide after-warranty service, anywhere in the United States. To locate the authorized Whirlpool service company in your area, call our COOL-LINE® service assistance telephone number (see Step 2) or look in your telephone directory Yellow Pages under:

APPLIANCES – HOUSEHOLD – MAJOR – SERVICE & REPAIR ELECTRICAL APPLIANCES – MAJOR – REPAIRING & PARTS
OR
WASHING MACHINES, DRYERS & IRONERS – SERVICING
WHIRLPOOL APPLIANCES AUTHORIZED WHIRLPOOL SERVICE
SERVICE COMPANIES
XYZ SERVICE CO
123 MAPLE 999-9999

4. If you have a problem*...

Call our COOL-LINE service assistance telephone number (see Step 2) and talk with one of our consultants, or if you prefer, write to:

Mr. Donald Skinner
Director of Consumer Relations
Whirlpool Corporation
2000 M-63
Benton Harbor, MI 49022

Please include a daytime phone number in your correspondence.

5. If you need FSP® replacement parts*...

FSP is a registered trademark of Whirlpool Corporation for quality parts. Look for this symbol of quality whenever you need a replacement part for your Whirlpool appliance. FSP replacement parts will fit right and work right, because they are made to the same exacting specifications used to build every new Whirlpool appliance.

To locate FSP replacement parts in your area, refer to Step 3 above or call the Whirlpool COOL-LINE service assistance number in Step 2.

6. If you are not satisfied with how the problem was solved*...

- Contact the Major Appliance Consumer Action Panel (MACAP). MACAP is a group of independent consumer experts that voices consumer views at the highest levels of the major appliance industry.
- Contact MACAP only when the dealer, authorized service or Whirlpool have failed to resolve your problem.

Major Appliance Consumer Action Panel
20 North Wacker Drive
Chicago, IL 60606

- MACAP will in turn inform us of your action.

*When requesting assistance, please provide: model number, serial number, date of purchase, and a complete description of the problem. This information is needed in order to better respond to your request.

Whirlpool® Room Air Conditioner Warranty

AC001

LENGTH OF WARRANTY	WHIRLPOOL WILL PAY FOR						
FULL ONE-YEAR WARRANTY From Date of Purchase	FSP® replacement parts and repair labor to correct defects in materials or workmanship.						
FULL FIVE-YEAR WARRANTY From Date of Purchase	FSP replacement parts and repair labor to correct defects in materials or workmanship in the sealed refrigeration system. These parts are: <table border="0" style="width: 100%;"> <tr> <td style="width: 50%;">1. Compressor</td> <td style="width: 50%;">4. Drier-Strainer</td> </tr> <tr> <td>2. Evaporator</td> <td>5. Connecting Tubing</td> </tr> <tr> <td>3. Condenser</td> <td></td> </tr> </table>	1. Compressor	4. Drier-Strainer	2. Evaporator	5. Connecting Tubing	3. Condenser	
1. Compressor	4. Drier-Strainer						
2. Evaporator	5. Connecting Tubing						
3. Condenser							
WHIRLPOOL WILL NOT PAY FOR							
<p>A. Service calls to:</p> <ol style="list-style-type: none"> 1. Correct the installation of the air conditioner. 2. Instruct you how to use the air conditioner. 3. Replace house fuses or correct house wiring. 4. Clean or replace air filter. <p>B. Pick up and delivery. This product is designed to be repaired in the home.</p> <p>C. Damage to the air conditioner caused by accident, misuse, fire, flood, acts of God or use of products not approved by Whirlpool.</p> <p>D. The removal and reinstallation of the air conditioner if it is installed in an overhead or other inaccessible location or not installed in accordance with published installation instructions.</p>							

Service under the full warranties must be provided by an authorized WhirlpoolSM service company. WHIRLPOOL CORPORATION SHALL NOT BE LIABLE FOR INCIDENTAL OR CONSEQUENTIAL DAMAGES. Some states do not allow the exclusion or limitation of incidental or consequential damages so this limitation or exclusion may not apply to you. This warranty gives you specific legal rights, and you may also have other rights which vary from state to state.

Outside the United States, a different warranty may apply. For details, please contact your franchised Whirlpool distributor or military exchange.

If you need service, first see the "Service and Assistance" section of this book. After checking "Service and Assistance," additional help can be found by calling our COOL-LINE® service assistance telephone number, 1-800-253-1301, from anywhere in the U.S.



Free Manuals Download Website

<http://myh66.com>

<http://usermanuals.us>

<http://www.somanuals.com>

<http://www.4manuals.cc>

<http://www.manual-lib.com>

<http://www.404manual.com>

<http://www.luxmanual.com>

<http://aubethermostatmanual.com>

Golf course search by state

<http://golfingnear.com>

Email search by domain

<http://emailbydomain.com>

Auto manuals search

<http://auto.somanuals.com>

TV manuals search

<http://tv.somanuals.com>