

use & care guide

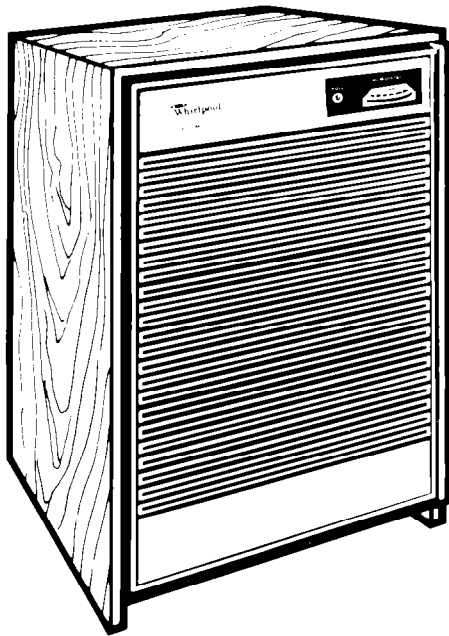

ryers. Freezers. Refrigerator-Freezers. Ice Makers. Dishwashers. Built-In Ovens. and Surface Units. Ranges. Microwave Ovens. Trash Compactors. Room Air Conditioners. Dehum



Please read this Use and Care Guide before you do anything else...

This booklet tells you how to install your dehumidifier, use it and clean it. Treat your new dehumidifier with care. Use it only to do what home dehumidifiers are designed to do.

Contents

Parts and Features		
Before Using Your Dehumidifier:		
Install Properly		
Electrical Requirements		
Using Your Dehumidifier:		
15 Pint Capacity Model		
All Other Models		
To Operate		
	Setting the Water Level Adjustment	6
	Water Disposal	7
	Caring for Your Dehumidifier	7
	Dehumidifier De-Icer Control	9
	If You Need Service or Assistance	9
	Whirlpool Dehumidifier Warranty	12

© 1988 Whirlpool Corporation

Parts and features

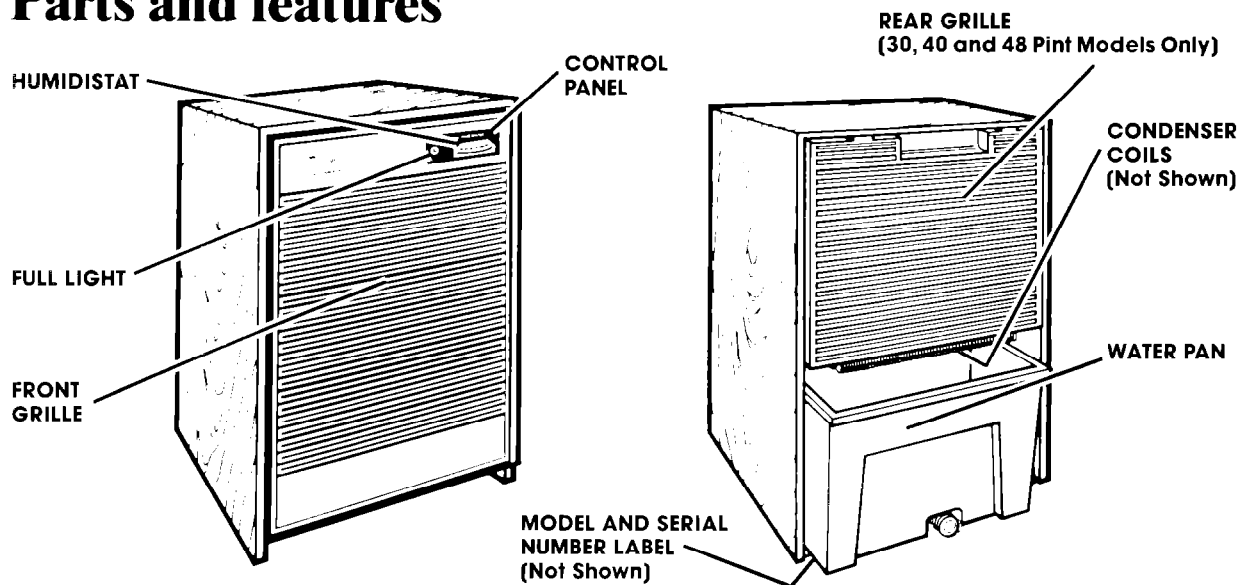

Thank you for buying a Whirlpool appliance. Please complete and mail the Owner Registration Card provided with this product. Then complete the form below. Have this information ready if you need service or call with a question.

- Copy model and serial numbers from label (under the water pan on the base of the unit) and purchase date from sales slip.
- Keep this book and sales slip together in a handy place.

Model Number

Serial Number

Purchase Date

Service Company
Phone Number

Before using your dehumidifier

It is your personal responsibility and obligation to make sure your dehumidifier:

- Has been properly installed on a floor that is reasonably level.
- Is the right size for the area you want to dehumidify.
- Is connected to the right kind of outlet, with the proper electrical supply and grounding. (Refer to "Electrical Requirements" on page 4.)
- Is used only to do what home dehumidifiers are designed to do.
- Is not used by anyone unable to operate it properly.
- Is properly maintained.
- Is used in an area where the room temperature will not fall below 65 F (18.3 C). [48, 40 and 30 pint models will operate in temperatures down to 50 F (10 C).]
- Do not remove Tech Sheet which is inside the cabinet. Your service technician needs this information.

Install Properly...

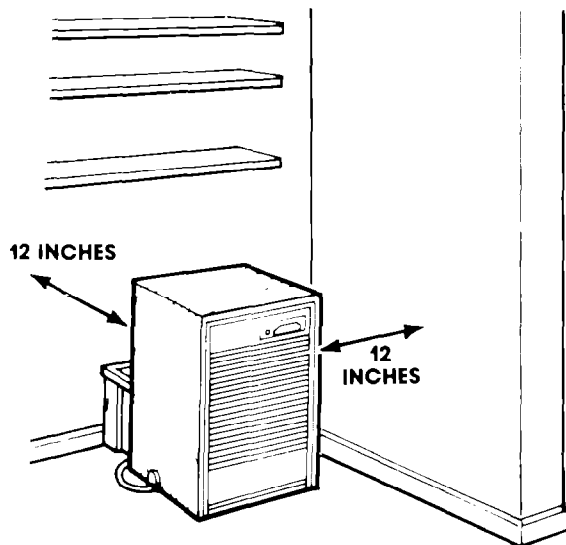

1. On most models, two rollers let you easily move the dehumidifier. Remove the water pan. Tilt unit forward and roll to another position. If your model does not have rollers, pick up the unit to move it to another position.
2. **Allow at least 12 inches (30.5 cm) of space around the unit for good air circulation.**
3. Keep all outside doors, windows and other openings closed when dehumidifier is operating. Humid outdoor air will add to the dehumidifier's operating load.
4. Water pan must be properly positioned on the hangers inside the cabinet when dehumidifier is operating.

Electrical Requirements

OBSERVE ALL GOVERNING CODES AND ORDINANCES.

Electrical ground is required on this appliance.

A 115 volt, 60 Hz., AC only, 15 or 20 ampere fused electrical supply is required. (Time delay fuse or circuit breaker is recommended.) It is recommended that a separate circuit serving only this appliance be provided. **Do not use an extension cord.**

DO NOT UNDER ANY CIRCUMSTANCES, REMOVE THE POWER SUPPLY CORD GROUND PRONG.

RECOMMENDED GROUNDING METHOD

For your personal safety, this appliance must be grounded. This appliance is equipped with a power supply cord having a 3-prong grounding plug. To minimize possible shock hazard, the cord must be plugged into a mating 3-prong grounding type wall receptacle, grounded in accordance with the National Electrical Code and local codes and ordinances. If a mating wall receptacle is not available, it is the personal responsibility and obligation of the customer to have a properly grounded 3-prong wall receptacle installed by a qualified electrician.

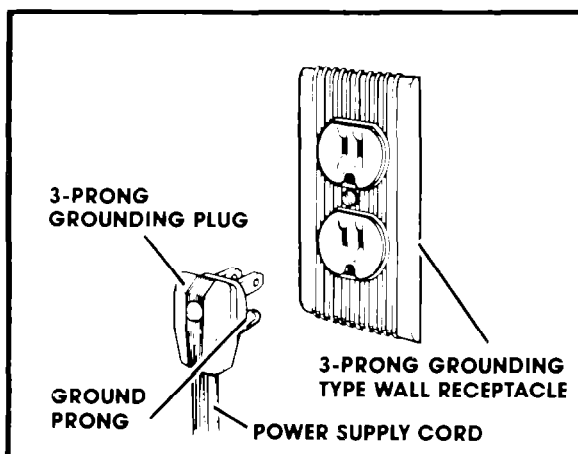

TEMPORARY GROUNDING METHOD

If changing and properly grounding the wall receptacle is impossible and where local codes permit (consult your electrical inspector), a temporary adaptor may be plugged into the existing 2-prong wall receptacle to mate with the 3-prong power supply cord. **THIS HOWEVER, IS NOT RECOMMENDED.**

If this is done, you must connect the grounding eyelet on the adapter to the wall receptacle cover plate screw and from this same screw, you must connect a separate copper ground wire (#14 minimum) to a grounded cold water pipe.* **Do not ground to a gas supply pipe. Do not connect to electrical supply until appliance is permanently grounded.**

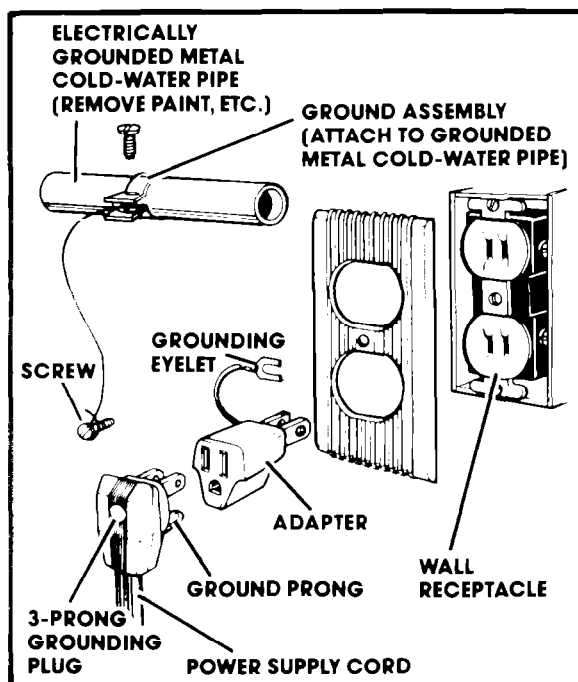

*Cold water pipe must have metal continuity to electrical ground and not be interrupted by plastic, rubber or other electrically insulating connectors (including water meter or pump) without adding a jumper wire at these connections.

Using your dehumidifier

You will use your dehumidifier more during months when you're not heating your home. But your dehumidifier can help prevent excessive moisture and keep you comfortable all year in any area of your home.

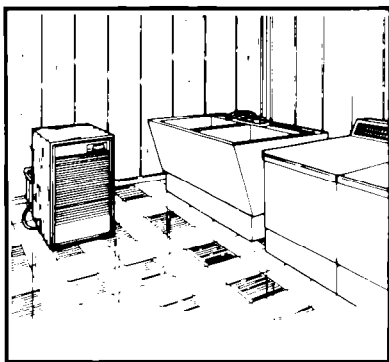

Use in a basement to help prevent moisture damage.

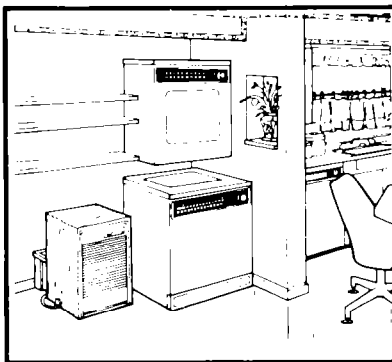

Use in cooking, laundry, bathing, and dishwashing areas which have excess moisture.

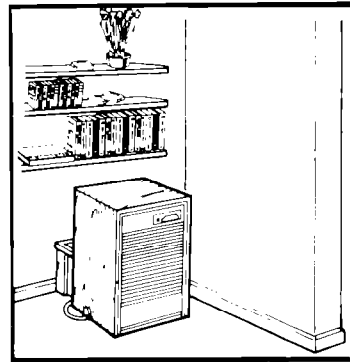

Use to prevent moisture damage anywhere books or valuables are stored.

NOTE: Do not operate any model in temperatures below 65°F (18.3°C), except the 48, 40 and 30 pint models which will operate down to 50°F (10°C). The coil may become iced over at low temperatures and will not operate properly.

15 Pint Capacity Model

Just plug it in to start. To stop, pull plug. This model does not have an ON/OFF switch or humidistat.

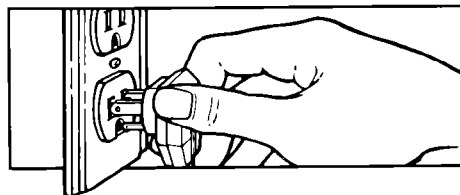

CAUTION: The 15 pint (7.0 L) capacity unit does not have a Water Level Control. To prevent overflow, the water level in the pan needs to be checked and emptied when $\frac{1}{2}$ to $\frac{3}{4}$ full, unless another disposal method is being used. See page 7.

All Other Models

All models except the 15 pint (7.0 L) capacity have a **FULL Light**. The light glows when the pan is full of water to indicate that it needs emptying.

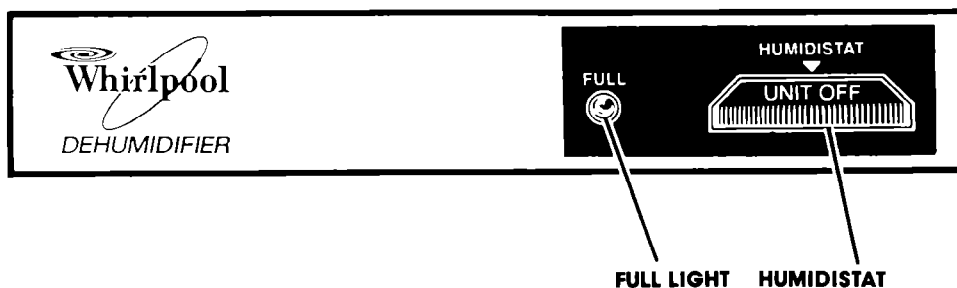

To Operate:

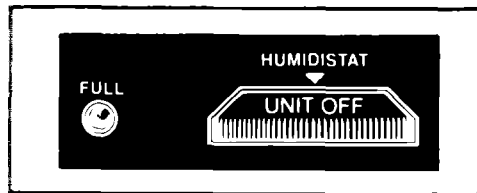

1. Turn Humidistat Control to UNIT OFF; then plug in the dehumidifier.

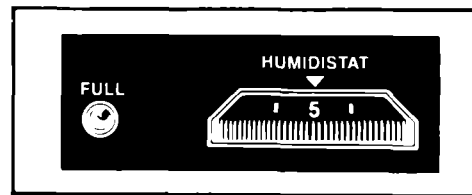

2. Your dehumidifier has an **automatic humidistat**. Turn Humidistat Control left toward DRYEST for normal operation. Set at number 5 or 6 to start. Adjust later, if necessary.

When humidity in the room increases, the dehumidifier automatically starts. When the humidity decreases to the selected level, the dehumidifier automatically stops.

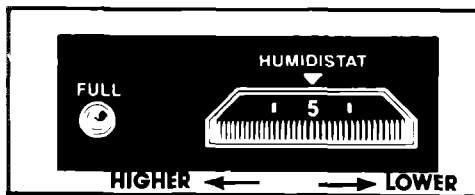

3. If you need more dehumidification, turn control to a higher number. Unit will run continuously at DRYEST setting. If you need less, set on a lower number.

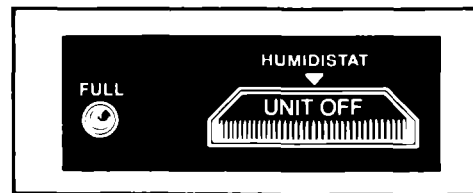

4. Stop the unit manually by turning the control to UNIT OFF.

Setting the Water Level Adjustment

All models except the 15 pint (7.0 L) capacity model have an adjustable water level. The Water Level Adjustment can be set in two positions to automatically turn off the unit when the pan is full (water level will be 1 to 4 inches from top of water pan). This prevents the danger of overflow.

Pan must be in proper position for Water Level Control Switch to work.

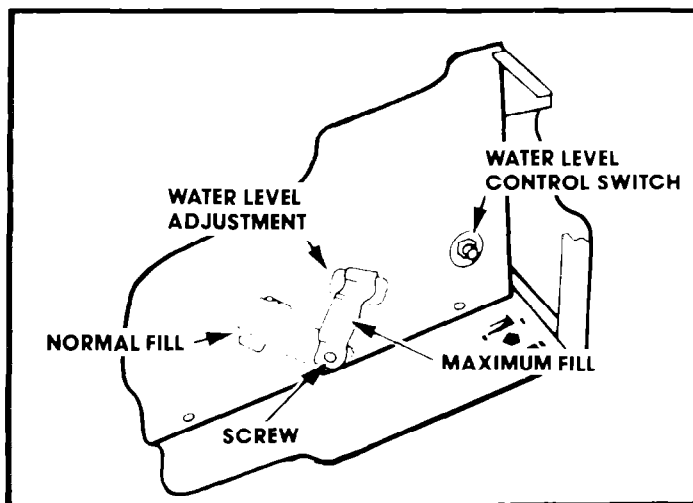

NORMAL FILL –

Water Level Adjustment set on the left side indentation. The water pan will be slightly more than $\frac{1}{2}$ full. The water pan and water will weigh approximately 16 lbs. (7.2 kg).

MAXIMUM FILL –

Move the Water Level Adjustment to the raised area on the right side. The water pan will be approximately $\frac{3}{4}$ full. The water pan and water will weigh approximately 24 lbs. (10.8 kg).

The Water Level Control Switch will automatically turn off the dehumidifier at the fill level you selected when pan is properly placed. Loosen the screw to move the Water Level Adjustment. Retighten screw when adjusted.

Water Disposal

All models have a 24 pint (11.3 L) capacity water pan.

There are three methods of disposing of water:

1. Empty pan manually.

When pan is full, remove it, empty it and put it back in place. **Be sure pan is properly placed so the Water Level Control Switch will work to automatically shut off the unit.**

WARNING: Do not use the water that collects in the water pan for drinking purposes. It is not sanitary and could cause illness.

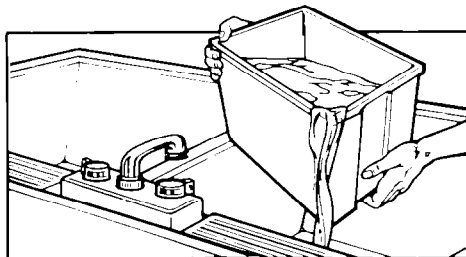

2. Place unit directly over drain.

Pan has a threaded hose connection which can be left open. Cut out opening with a knife or $\frac{3}{4}$ " wood drill.

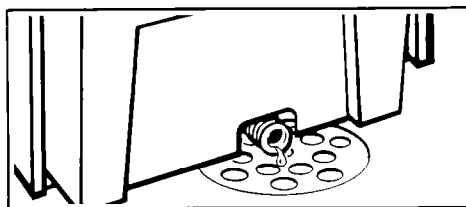

3. Attach garden hose to the threaded hose connection to carry water to drain.

- Pan has a threaded hose connection which can be left open. Cut out opening with a knife or $\frac{3}{4}$ " wood drill.
- Attach garden hose. Be sure hose does not kink or bend. It should lie flat from unit to drain.

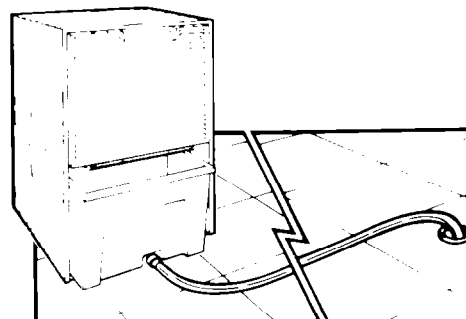

Caring for your dehumidifier

Your dehumidifier is designed to operate year-round. It needs practically no attention. However, you should check your dehumidifier and inspect the coils annually. Follow these instructions carefully.

You may call a service company to perform this annual checkup or you can do it yourself. Cost of annual inspection is the owner's responsibility.

WARNING: Disconnect power supply cord from receptacle before performing any maintenance. Failure to follow these instructions could cause personal injury.

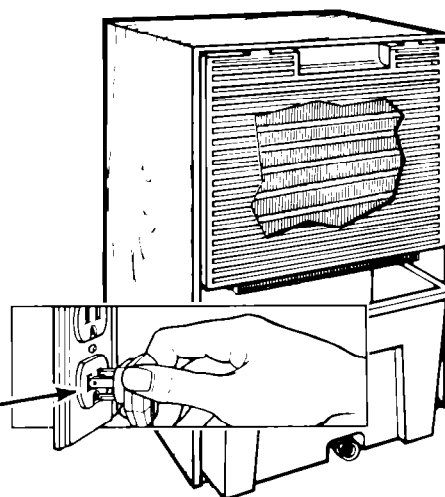

1. To remove outer cabinet:
 - a. Disconnect power cord.
 - b. Take off the plastic grille. Remove the two screws at the bottom. Drop grille down and take out.

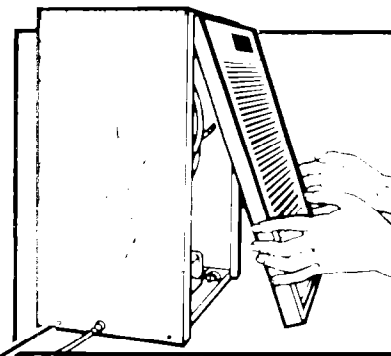
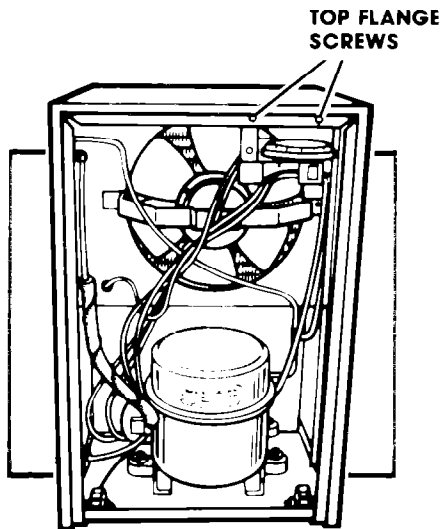

SOCKET HEAD SCREWS
(side of cabinet)

- c. Remove the socket head screws on each side and top flange screws (see illustrations). On 30, 40 and 48 pt. models, also remove rear grille. Pull out at bottom and drop grille down.
- d. Lift cabinet from unit.

2. Coils should be inspected annually. If needed, brush clean with warm water and mild detergent. Rinse and dry. **Be sure power supply cord is disconnected.**

⚠ WARNING: Be careful when cleaning the condenser coils. Fins are sharp and could cause personal injury.

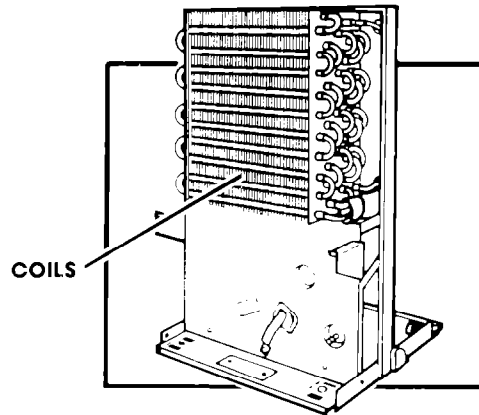

3. The compressor is sealed and needs no oiling.

4. **The fan motor is prelubricated and does not require further oiling under normal operating conditions.** However, if the dehumidifier is operated under severe environmental conditions (dust, dirt, high temperatures) the fan motor should be oiled annually through the provided oil tubes (holes). An easy to use capsule of especially recommended oil (Part Number 10943) is available through your nearest Whirlpool Factory Service Center, or use SAE #20 non-detergent oil.

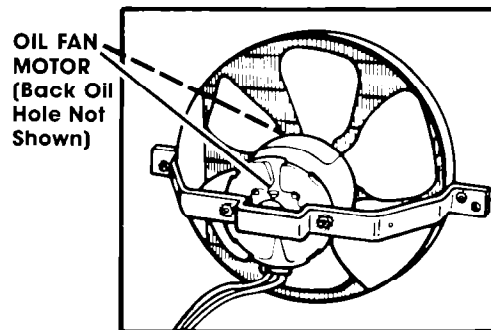

5. Wash plastic parts with a soft cloth, warm water and mild detergent. Rinse and dry with a soft cloth.

6. Replace cabinet grille(s). Reconnect power supply cord.

Dehumidifier DE-ICER control

The 48, 40 and 30 pint models have a DE-ICER control. This feature allows you to operate the unit in room temperatures below 65 F (18.3 C). Without this DE-ICER control, the unit's evaporator coil would form frost that could prevent proper operation.

The DE-ICER control senses frost build-up on the evaporator coils. When frost build-up is sensed it automatically shuts off the compressor, but allows the fan to continue running. The fan draws air across the coil which melts the frost. When the coil is defrosted, the DE-ICER control automatically restarts the compressor and resumes dehumidifying.

These units will not operate properly in room temperatures below 50 F (10 C).

If you need service or assistance, we suggest you follow these five steps:

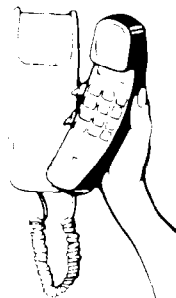

1. Before calling for assistance...

Performance problems often result from little things you can find and fix yourself without tools of any kind.

If unit won't operate:

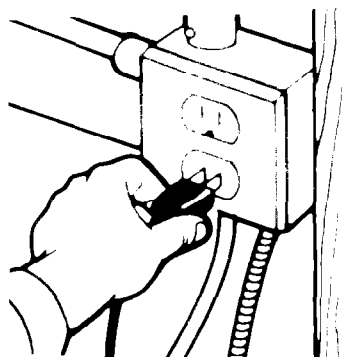

- Is the dehumidifier correctly plugged into a live circuit with the proper voltage?
- Is the Humidistat Control set to a position other than UNIT OFF? Try a dryer setting.

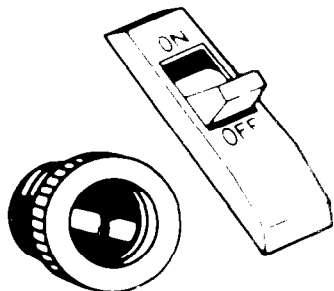

- Have you checked the main fuse or circuit breaker box?
- If a 48, 40 or 30 pint model, is the temperature below 50 F (10 C)? The fan should run, but the unit will not dehumidify.

If unit blows fuses or trips circuit breakers:

- Are correct time-delay fuses being used in the main fuse box?

- Is an extension cord being used? **Do not use an extension cord.**
- Are the coils iced or clogged with lint?

If unit ices up:

- Is humidity too low?
- Is room temperature below 65 F (18.3 C)? Coil will become iced over at low temperatures, except the 48, 40 and 30 pint models which will operate down to 50 F (10 C).

If water collects on the floor:

- Is unit reasonably level?
- Is hose or drain clogged or kinked?
- Is the water pan overflowing? Pan must be properly positioned.

Special dehumidifier needs:

- Annual inspection: Clean coils, inspect drain and hoses; if necessary, oil the fan motor.
- Moving: When moving, keep the unit in an upright position.

Remember... Please include the model and serial number of your appliance when requesting service. Also, retain your sales slip and warranty to verify your warranty status. Learn the benefits of using TECH-CARE® service for maintaining the quality originally built into your WHIRLPOOL appliance.

2. If you need assistance*...

Call Whirlpool COOL-LINE® service assistance telephone number. Dial free from anywhere in the U.S.:

1-800-253-1301

and talk with one of our trained consultants. The consultant can instruct you in how to obtain satisfactory operation from your appliance or, if service is necessary, recommend a qualified service company in your area.

3. If you need service*...



Whirlpool has a nationwide network of franchised TECH-CARE® Service Companies. TECH-CARE service technicians are trained to fulfill the product warranty and provide after-warranty service, any-

where in the United States. To locate TECH-CARE service in your area, call our COOL-LINE® service assistance telephone number (see Step 2) or look in your telephone directory Yellow Pages under:

APPLIANCES - HOUSEHOLD -
MAJOR - SERVICE & REPAIR

WHIRLPOOL APPLIANCES
FRANCHISED TECH-CARE SERVICE

SERVICE COMPANIES
WASHING MACHINES, DRYERS
& IRONERS - SERVICING

ELECTRICAL APPLIANCES -
MAJOR - REPAIRING & PARTS

OR

WHIRLPOOL APPLIANCES
FRANCHISED TECH-CARE SERVICE

SERVICE COMPANIES
WASHING MACHINES, DRYERS
& IRONERS - SERVICING

OR

WASHING MACHINES, DRYERS
& IRONERS - SERVICING

WHIRLPOOL APPLIANCES
FRANCHISED TECH-CARE SERVICE

SERVICE COMPANIES
WASHING MACHINES, DRYERS
& IRONERS - SERVICING

4. If you have a problem*...

Call our COOL-LINE service assistance telephone number (see Step 2) and talk with one of our consultants, or if you prefer, write to:

Mr. Donald Skinner
Director of Customer Relations
Whirlpool Corporation
2000 M-63
Benton Harbor, MI 49022



5. If you need FSP replacement parts*...

FSP is a registered trademark of Whirlpool Corporation for quality parts. Look for this symbol of quality whenever you need a replacement part for your Whirlpool appliance. FSP replacement parts will fit right and work right, because they are made to the same exacting specifications used to build every new Whirlpool appliance.

To locate FSP replacement parts in your area, refer to Step 3 above or call the Whirlpool COOL-LINE service assistance number in Step 2.

*If you must call or write, please provide: model number, serial number, date of purchase, and a complete description of the problem. This information is needed in order to better respond to your request for assistance.

Notes

A series of horizontal lines provided for taking notes.

IF YOU NEED SERVICE OR ASSISTANCE

WHIRLPOOL® DEHUMIDIFIER WARRANTY

DH001

LENGTH OF WARRANTY	WHIRLPOOL WILL PAY FOR
FULL ONE-YEAR WARRANTY From Date of Purchase	FSP* replacement parts and repair labor to correct defects in materials or workmanship.
FULL FIVE-YEAR WARRANTY From Date of Purchase	FSP replacement parts and repair labor to correct defects in materials or workmanship in the sealed refrigeration system. These parts are: <div style="display: flex; justify-content: space-between; margin-top: 5px;"> <div style="width: 45%;"> <ol style="list-style-type: none"> 1. Compressor 2. Evaporator 3. Condenser </div> <div style="width: 45%;"> <ol style="list-style-type: none"> 4. Drier – Strainer 5. Connecting tubing </div> </div>
WHIRLPOOL WILL NOT PAY FOR	
<p>A. Service calls to:</p> <ol style="list-style-type: none"> 1. Correct the installation of the dehumidifier. 2. Instruct you how to use the dehumidifier. 3. Replace house fuses or correct house wiring. <p>B. Pick up and delivery. This product is designed to be repaired in the home.</p> <p>C. Damage to dehumidifier caused by accident, misuse, fire, flood, acts of God or use of products not approved by Whirlpool.</p>	

Service under the full warranties must be provided by a franchised TECH-CARE® service company.

WHIRLPOOL CORPORATION SHALL NOT BE LIABLE FOR INCIDENTAL OR CONSEQUENTIAL DAMAGES. Some states do not allow the exclusion or limitation of incidental or consequential damages so this limitation or exclusion may not apply to you. This warranty gives you specific legal rights, and you may also have other rights which vary from state to state.

Outside the United States, a different warranty may apply. For details, please contact your franchised Whirlpool distributor or military exchange.



Free Manuals Download Website

<http://myh66.com>

<http://usermanuals.us>

<http://www.somanuals.com>

<http://www.4manuals.cc>

<http://www.manual-lib.com>

<http://www.404manual.com>

<http://www.luxmanual.com>

<http://aubethermostatmanual.com>

Golf course search by state

<http://golfingnear.com>

Email search by domain

<http://emailbydomain.com>

Auto manuals search

<http://auto.somanuals.com>

TV manuals search

<http://tv.somanuals.com>