

Installation Instructions

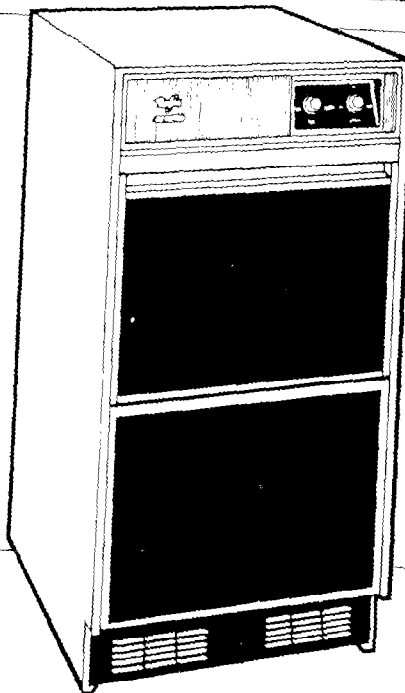

Part No. 759105-U

Ice Maker

IMPORTANT

Installer: Leave Installation Instructions with the homeowner.

Homeowner: Keep Installation Instructions for future reference.

Save Installation Instructions for local electrical inspector's use.



Before you start...

Proper installation is your responsibility. Make sure you have everything necessary for correct installation. It is the customer's responsibility to assure that the plumbing and electrical installations are adequate and meet all local codes and ordinances.

Proper electrical supply, water supply lines, and floor drain or sump pump must be available or must be installed, as specified, within the shaded area. (See "Electrical", "Water", and "Drain requirements" sections.) Plumbing and wiring should not cross in front of the ice maker motor. Wiring should not pass through the drain area.

Important: Observe all governing codes and ordinances.

Electrical ground is required. (See "Electrical requirements".)

Do Not close in the front of the ice maker. The ice maker cannot work properly if the airflow to the front of the ice maker is blocked.

Compliance with National Sanitation Foundation standards requires that this type of product be sealed to the floor at the bottom rail in order to prevent contamination from spills or vermin. Therefore, we recommend that when installing this product you seal it to the floor in accordance with those standards. A silicone-type sealer is recommended.

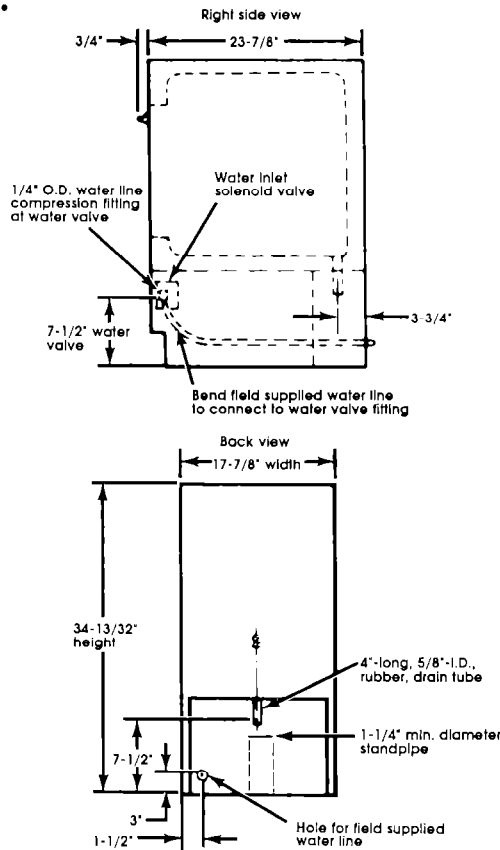

Figure 1

Shipboard installations:

Ice makers installed in ships require a water deflector (available from your local authorized parts distributor). The deflector keeps the water that flows over the evaporator from spilling into the storage bin area. Install deflector according to the instructions provided with the deflector kit.

Electrical requirements

⚠ WARNING

Electrical Shock Hazard

- **Electrical ground is required on this appliance.**
- **Check with a qualified electrician if you are in doubt as to whether the appliance is properly grounded. Do Not modify or remove the power supply cord plug. If it will not fit the outlet, have a proper outlet installed by a qualified electrician.**
- **Improper connection of the equipment-grounding conductor can result in a risk of electrical shock.**
- **Do Not use an extension cord with this appliance.**
- **Do Not have a fuse in the neutral or grounding circuit.**
- **Do Not connect to electrical supply until appliance is permanently grounded.**

Failure to follow these instructions could result in a fire, electrical shock, or other personal injury.

A 120-volt, 60-Hz, AC only, 15-ampere, fused, electrical supply is required. Time-delay fuse or circuit breaker is recommended. It is

recommended that a separate circuit serving only this appliance be provided.

If the personal responsibility and obligation of the customer to contact a qualified electrician to assure that the electrical installation is adequate and in conformance with the National Electrical Code ANSI/NFPA 70 latest edition, and all local codes and ordinances.

Recommended grounding method

For your personal safety, this appliance must be grounded. This appliance is equipped with a power supply cord having a 3-prong grounding plug. To minimize possible shock hazard, the cord must be plugged into a mating, 3-prong, grounding-type wall receptacle, grounded in accordance with the National Electrical Code ANSI/NFPA 70-latest edition, and local codes and ordinances. (See Figure 2.)

If a mating wall receptacle is not available, it is the personal responsibility and obligation of the customer to have a properly grounded, 3-prong, wall receptacle installed by a qualified electrician.

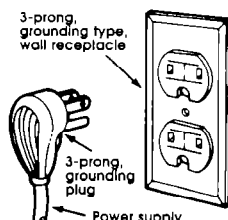

Figure 2

Check the location where the ice maker will be installed. The location **must** provide:

- Easy access to water, electricity and drainage lines.
- Protection from wind, weather, dripping or spraying water, and other harmful elements.
- Protection from cold temperatures to prevent the water inlet valve and drain from freezing.
- Good ventilation and unobstructed airflow to the front of the ice maker.
- Room to fully open the ice maker door.
- Room to move the cabinet forward for servicing, if necessary.

The unit may be enclosed around the sides, top and rear of ice maker.

Protection from weather: Do Not store or operate the ice maker below 55°F or above 110°F. For best results, operate the ice maker at temperatures between 70°F to 90°F.

Drain system requires either a gravity, floor-drain system or a drain pump (see "Drain requirements") to lift the water to an existing drain. A 1-1/4" min. diameter standpipe or 5/8" I.D. minimum drain tube to an open drain is required.

⚠ WARNING

Electrical Shock Hazard

Do Not let electrical wiring and components contact the drain hose or any plumbing materials.

Failure to follow these instructions could result in fire, electrical shock or other personal injury.

Read and follow the "Electrical requirements", "Water requirements" and "Drain requirements" sections before installing the ice maker.

Temporary grounding method

If changing and properly grounding the wall receptacle is impossible and where local codes permit (consult your electrical inspector), a temporary adapter may be plugged into the existing, 2-prong, wall receptacle to mate with the 3-prong, power supply cord.

THIS, HOWEVER, IS NOT RECOMMENDED.

If this is done, you **must** connect a separate, copper, grounding wire (No. 18 minimum) to a grounded, cold water pipe* by means of a clamp and then to the external grounding connector screw. **Do Not connect to a gas supply pipe or hot water pipe.** (See Figure 3.)

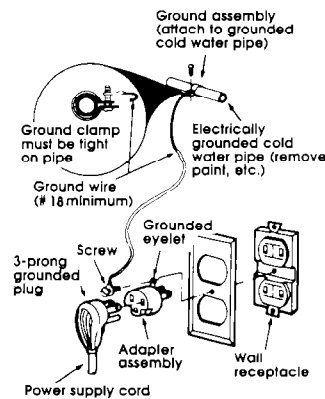

Figure 3

* Grounded, cold water pipe must have metal continuity to electrical ground and not be interrupted by plastic, rubber, or other electrical insulating connectors such as hoses, fittings, washers or gaskets (including water meter or pump). Any electrical insulating connector should be jumped as shown with a length of No. 4, copper wire securely clamped to bare metal at both ends.

Water requirements

The cold water line to the ice maker requires 1/4"-O.D. soft copper tubing.

A threaded compression fitting to connect the water line to the inlet valve is in the parts bag.

Install a shut-off valve in the water line where it can be easy to access.

Drain requirements

This appliance is equipped with a gravity drain and a 4"-long, 5/8"- O.D. rubber, drain tube.

Recommended method

Install a 1-1/4" minimum diameter standpipe directly below the drain tube outlet. (See Panel A for dimensions.)

It may be desirable to insulate the drain line up to the drain inlet to minimize condensation on the drain tube.

Alternate method

If a drain connection directly below the drain tube outlet is not available, a drain pump (Part No. EKDP3) will need to be installed. The drain pump, available from your local authorized parts distributor, lifts water to an available drain.

⚠ WARNING

Electrical Shock Hazard
Disconnect power supply.

Failure to do so could result in electrical shock or personal injury.

1. Follow steps 1 through 10 of the "Now start..." section.
2. Install the drain pump on the floor near the center of the rear wall of the cabinet opening. The side of drain pump with the discharge tube should face the rear of the opening.
3. Remove the rubber drain hose and connect the bin drain directly to the pump using 5/8" I.D. plastic hose. (See Figure 4.)
4. Run pump drain hose to drain. (See Figure 4.)
5. Run the power supply cord from the pump through the hole in the rear of the ice maker. (See Figure 4.)

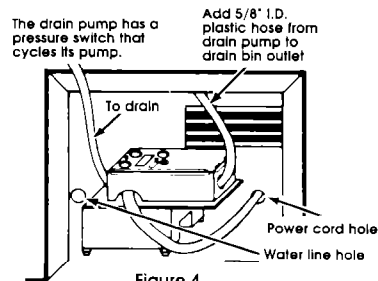

Figure 4

6. Remove the two screws attaching the air grille to the ice maker. Remove the air grille. (See Figure 5.)

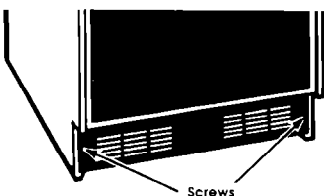

Figure 5

7. Remove and save the shunt from the ice maker receptacle. Plug the drain pump, power supply cord into the receptacle. (See Figure 6.)

NOTE:

Do Not discard shunt. The shunt must be reattached to the ice maker when the ice maker is operated without a drain pump. See Installation Instructions included with drain pump.

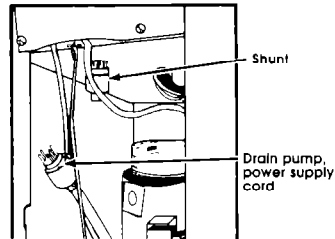
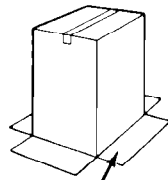

Figure 6

7. Reattach the air grille to the ice maker with the two screws.

Now start...

1. Carefully place carton on its side. Open the bottom flaps.



Open bottom flaps

2. Set carton upright with all four, bottom flaps folded outward. Remove carton from ice maker.

3. Remove all tape and packing material from the outside and inside of the ice maker.

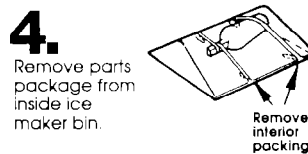

Remove interior packing

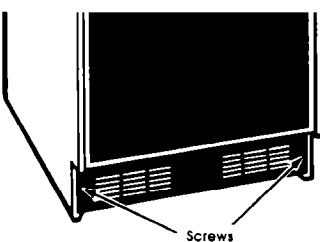

Screws

5. Remove the two screws attaching the air grille to the ice maker. Remove the air grille.

6. Turn the fan by hand to check that it moves freely.

7. Slightly loosen, but Do Not remove, the thumb screws holding the cutter grid and water pan in place.

8. Rough in 1/4"-O.D., soft copper tubing from the cold water supply line. Position tubing so that it can enter the access hole located in the rear of the ice maker cabinet. Place tubing in the center of the opening and allow enough tubing so that it extends beyond the cabinet front when the icemaker is pushed back into position. (See Panel A).

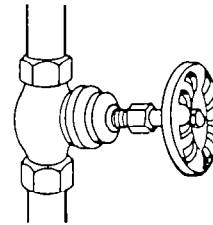

9. Install a shutoff valve in the water line where it can be easily used.

10. Flush the water line into a bucket to get rid of any particles that may clog the inlet valve. Turn the shutoff valve to the "off" position.

⚠ CAUTION

Floor Damage
Slide ice maker onto cardboard/hardboard before moving across floor. Failure to do so could result in damage to floor covering.

11. Determine which type of drain method you need and follow the "Drain requirements" instructions for that method on Panel B. Move ice maker close to its final position.

⚠ WARNING

Electrical Shock Hazard
Disconnect power supply.

Failure to do so could result in electrical shock or personal injury.

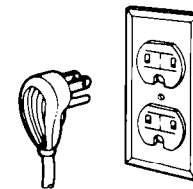

12. Plug the electrical cord into the grounded outlet.

13. Insert the cold-water supply tubing through the hole in the rear of the ice maker. Slide the ice maker into place. Center the ice maker in the opening. Remove the cardboard/hardboard.

14. Attach the hose by the threaded, compression fitting to the ice maker's cold-water inlet valve. Bend the cold-water supply tubing up toward the fitting. Attach the cold-water supply tubing to the fitting. Check for good fit.

15. Check the levelness of the ice maker from front to back and side to side. The ice maker must be level for proper operation. Shim the ice maker with masonite or any hard, permanent material so that it is level and held tightly in place. If local codes require, seal ice maker cabinet to floor with an approved caulking compound.

16. Check that all parts have been installed and that no steps were skipped. Check that you have all the tools you started with.

17. Take a few minutes to read the "Ice maker operation" section, Panel C, and the *Use and Care Guide* to fully understand your new ice maker.

18. Open ice maker door. Wash out the interior of the bin with a solution of two tablespoons of baking soda and one quart of water. Rinse the bin thoroughly with water.

19. If ice maker is installed above 2,000-foot altitude, the bin and evaporator thermostats will need adjusting. Remove the thermostats and follow the directions for turning the altitude adjustment screws as shown on each of the thermostat labels. Reinstall the thermostats in the ice maker.

20. Replace the access grille.

21. Turn on the water supply and check for leaks. Then turn on the electrical supply.

22. Turn the ice maker control knob to the right to the "CLEAN" position. Check that the pump motor is operating correctly.

23. Turn the control knob to the "ON" position. Check that the condenser fan is revolving.

Important:
Ice maker must run for three hours before you may expect ice.

24. Let the ice maker run for three hours. When water flows over the freezing plate, check that it is flowing evenly. If it is not, the ice maker is not level and Step 15 should be repeated.

Important:
Do Not adjust the thickness setting until ice maker has run for 24 hours.

25. Continue to let the ice maker run for 24 hours. Check to see if cubes are the desired thickness and, if necessary, adjust the thickness control.

26. If installing decorative wood panels on the door and lower panel, follow the "To change the bin door and lower panel" instructions.



Ice maker operation

Before running your ice maker for the first time, you should note the following:

- Water enters only during the defrost cycle, so the first harvest cycle will be completed without water in the system.
- Water will not enter the pump pan until the freezing plate gets cold and the ice maker begins a harvest cycle.
- A normal harvest cycle takes between 60 to 120 seconds to complete. However, do not expect ice until the ice maker has been operating for at least three hours.
- The evaporator thermostat opens when the evaporator reaches the preset temperature (+10° to -3°F, depending on the thickness of the ice). The hot gas solenoid and the water valve solenoid are energized at this time, so the pump motor and fan motor will shut down. The fans will remain off and the solenoids will remain charged until the evaporator reaches 38°F (±2°F) again.
- As the temperature of the room and water varies, so will the amount of ice produced. Higher operating temperatures will result in less ice made. To make the most ice, set the thickness control to produce 1/2" to 5/8" cubes.

4. Break off the ribs on the door insulation.
5. Slide the wood door bin panel into the door bin frame.
6. Reattach the handle with the two screws.
7. Remove the two screws at the bottom and the two screws at the top of the lower panel. Remove the top of the lower panel assembly.
8. Slide the metal panel and the spacers out of the lower panel assembly.
9. Slide the metal panel back into the lower panel assembly. Slide the wood panel in front of the metal panel.
10. Reattach the top of the panel with the two screws and replace the two screws at the bottom of the assembly.

How your ice maker works:

When the ice maker is turned to "ON":

- Compressor and condenser fans run.
- Water pump circulates water.
- Cutter grid becomes warm to touch.

When the ice slab reaches the desired thickness:

- Harvest cycle begins. (Normal harvest cycle takes 60 to 120 seconds.)
- Evaporator thermostat is satisfied.
- Compressor keeps running, but the condenser fan will stop turning or turn very slowly.
- Water pump stops.
- Hot gas solenoid and the water inlet valve open.
- Excess water is flushed out of the drain pan.
- Cutter grid remains warm to touch.

After the slab is released:

- Cycle begins again.
- Cutting process begins.

When the storage bin is filled:

- Bin thermostat opens.
- Cutter grid remains on.

Things to remember

- The ice maker will automatically continue to harvest ice until the storage bin is full. The ice maker will shut down when the ice in the storage bin touches the bin thermostat well. It will begin harvesting ice again when ice is removed from the bin.
- The storage bin is not refrigerated so there will be some melting. This will vary with the temperature of the room where the ice maker is located.
- The ice maker must have good ventilation to work properly. Do Not block the front of the ice maker. Keep the front air grille and condenser clean.
- The water system, including the filter screen in the water solenoid valve, needs to be cleaned periodically for good circulation. Instructions for cleaning the water system are located on the inner door panel.

To change the bin door and lower panel

The bin door and lower panel can be customized to match wood cabinets.

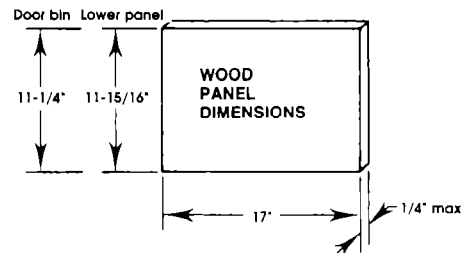

CAUTION

Personal Injury Hazard
Handle metal edges carefully. Cut metal edges may cause personal injury or damage to other materials.

1. Cut panels using the specified dimensions. Make sure wood grain matches the direction of the cabinet wood grain.

The ice maker is subject to some humidity. Cover both sides and edges of the wood panels with moisture-resistant sealer.

2. Open the bin door and remove the two screws holding the handle to the top of the door. Remove the handle.

3. Slide the metal panel out of the bin door.

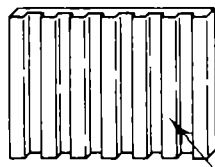

If you need assistance...

During normal business hours, the Whirlpool COOL-LINE® Service will answer any questions about operating your ice maker not covered in the Installation Instructions. The Whirlpool COOL-LINE® Service telephone number is (800) 253-1301. Dial just as you normally dial long distance — the call is free. When you call, you will need the ice maker model number and serial number. Both numbers can be found on the serial/rating plate located behind the bin door on the frame.

In the event that your Whirlpool appliance should need service, call the dealer from whom you purchased the appliance or a Whirlpool franchised service company. The Whirlpool COOL-LINE® Service can also provide you with the names of your nearest Whirlpool service outlet.

If ice maker does not operate...

Check that the circuit breaker is not tripped or the fuse blown. A more detailed, troubleshooting checklist is provided in the Use and Care Guide.

Wiring diagram

This appliance operates at 115 volts, except for the cutter grid circuit and glacial ice water pump, which operate at 8.5 volts at 1 amp.

The compressor will remain running until the bin thermostat becomes satisfied and opens up. This de-energizes all the system except for the transformer, cutter grid, and glacial ice water pump.

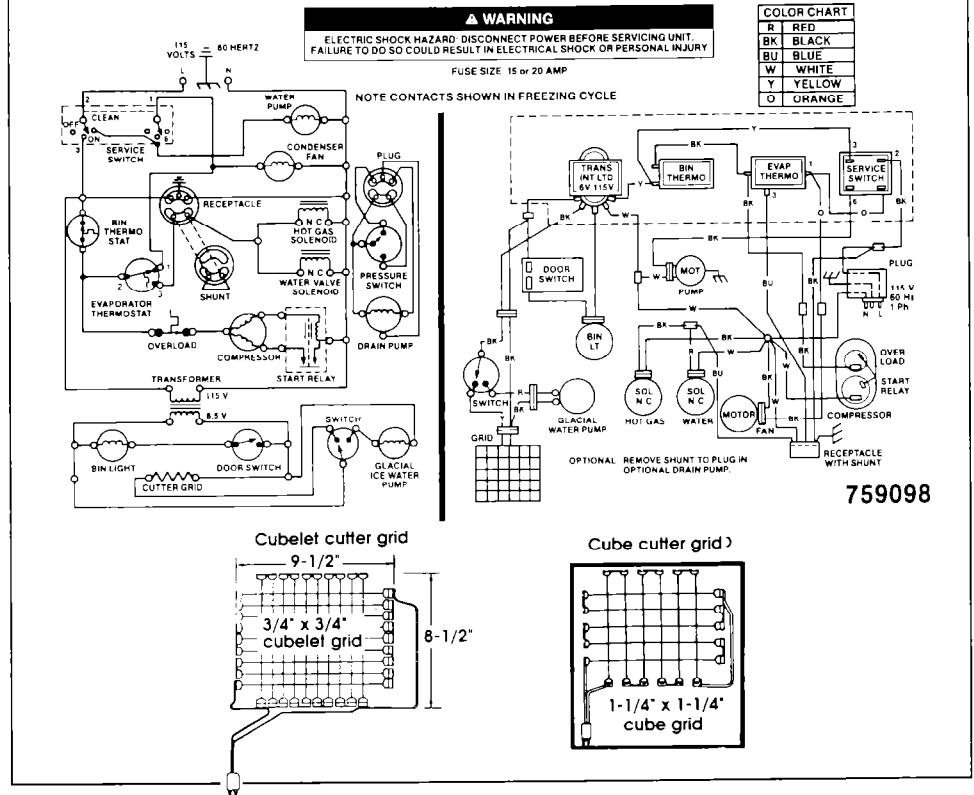

Part No. 759105-U
© Whirlpool Corp. 1990

Prepared by Whirlpool Corporation, Benton Harbor, Michigan 49022

Printed in U.S.A.

Free Manuals Download Website

<http://myh66.com>

<http://usermanuals.us>

<http://www.somanuals.com>

<http://www.4manuals.cc>

<http://www.manual-lib.com>

<http://www.404manual.com>

<http://www.luxmanual.com>

<http://aubethermostatmanual.com>

Golf course search by state

<http://golfingnear.com>

Email search by domain

<http://emailbydomain.com>

Auto manuals search

<http://auto.somanuals.com>

TV manuals search

<http://tv.somanuals.com>