

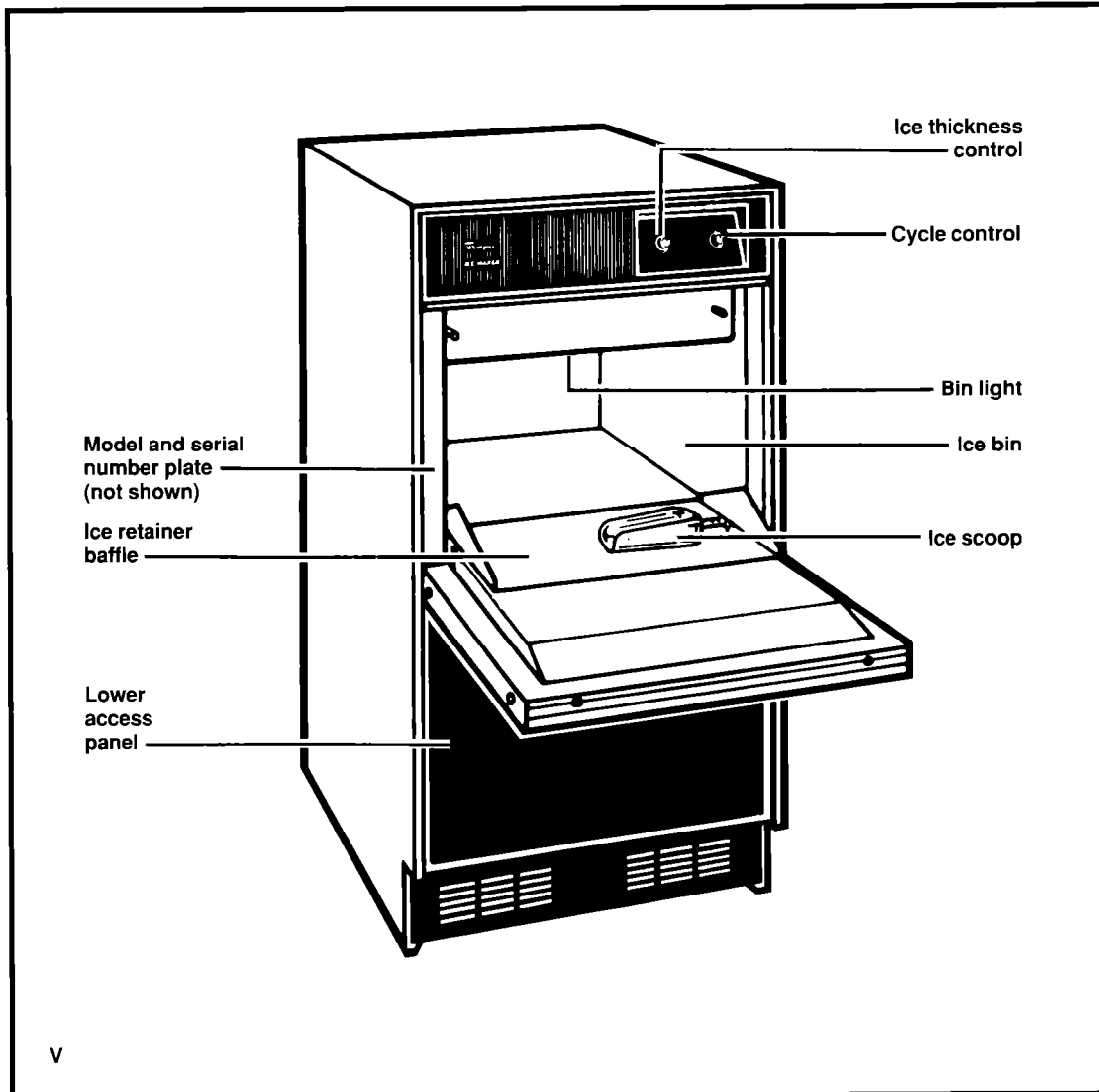

Use & Care Guide



AUTOMATIC ICE MAKER EC510

Contents

	Page
Important Safety Instructions	2
Using Your Ice Maker	3
How the ice maker works	3
Setting the controls	4
Changing the bin door panel	4
Changing the lower access panel	5
Changing the light bulb	6
Cleaning and Caring For Your Ice Maker ...	7
Cleaning exterior surfaces	7
Cleaning the condenser	8
Cleaning the ice maker system	9
Cleaning the interior components	11
Filtering and treating water	12
Vacation and Moving Care	13
If You Need Service Or Assistance	14
Whirlpool Ice Maker Warranty	16

© 1990 Whirlpool Corporation

Thank you for buying a Whirlpool appliance. Please complete and mail the Owner Registration Card provided with this product.

Then complete the form below. Have this information ready if you need service or call with a question.

- Copy model and serial numbers from plate (see diagram on front cover) and purchase date from sales slip.
- Keep this book and sales slip together in a handy place.

Model Number _____

Serial Number _____

Purchase Date _____

Service Company Phone Number _____

Important Safety Instructions

⚠ WARNING

To reduce the risk of fire, electrical shock, or injury when using your ice maker, follow basic precautions including the following:

- Read all instructions before using the ice maker.
- Never allow children to operate, play with, or crawl inside the ice maker.
- Never clean ice maker parts with flammable fluids. The fumes can create a fire hazard or explosion.
 - **FOR YOUR SAFETY**
 - DO NOT STORE OR USE GASOLINE OR OTHER FLAMMABLE VAPORS AND LIQUIDS IN THE VICINITY OF THIS OR ANY OTHER APPLIANCE. THE FUMES CAN CREATE A FIRE HAZARD OR EXPLOSION.**
 - It is your responsibility to be sure your ice maker:**
 - has been installed where it is protected from the elements.
 - is located so that the front is not blocked to restrict incoming or discharge air flow.
 - is properly leveled.
 - is located in a well ventilated area with temperatures above 55°F (13°C) and below 110°F (43°C). Best results are obtained at temperatures between 70°F (21°C) and 90°F (32°C).
 - is properly connected to a water supply and drain.
 - is connected only to the proper kind of outlet, with the correct electric supply and grounding. A 120 Volt, 60 Hz., 15 amp fused electrical supply is required.
NOTE: Time delay fuse or circuit breaker is recommended.
 - is not used by anyone unable to operate it properly.
 - is used only to do what ice makers are designed to do.
 - is properly maintained.
NOTE: A drain pump kit (EKDP3) is available as an option for installation where a floor drain is inaccessible.

—SAVE THESE INSTRUCTIONS—

Using Your Ice Maker

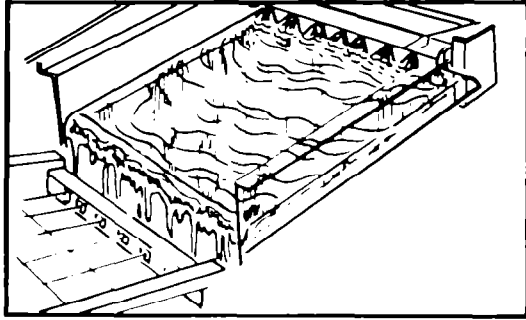

How the ice maker works

1. Water is constantly circulated over a freezing plate. As the water freezes into ice, the minerals in the water are rejected. This produces a sheet of ice with a low mineral content.

NOTE: The ice maker is designed to make clear ice from the majority of water sources on a daily basis. If your results are unsatisfactory, water may need to be filtered or treated. See "Filtering and treating water" on page 12.

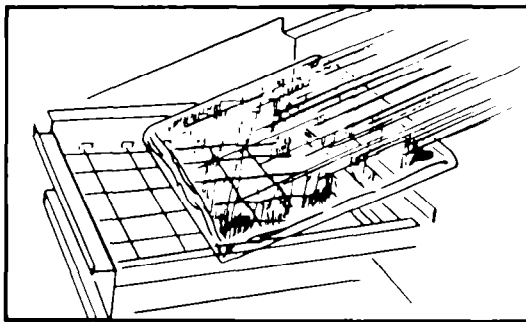

2. When the desired thickness is reached, the ice sheet is released and slides onto a cutter grid. The grid divides the sheet into individual cubes.
3. The water containing the rejected minerals is drained after each freezing cycle.
4. Fresh water enters the machine for the next ice making cycle.

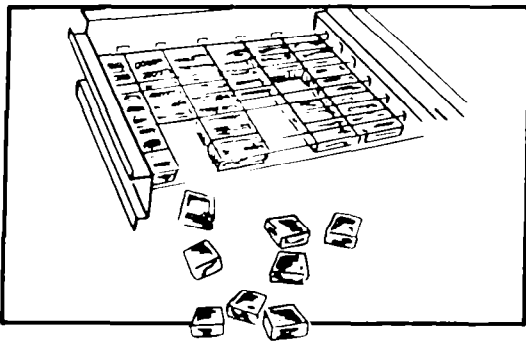

5. Cubes fall into the storage bin. When the bin is full, the ice maker shuts off automatically and restarts when more ice is needed.

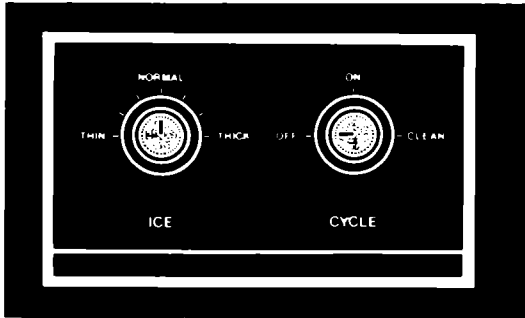

Setting the controls

1. Select ice thickness. The ice maker has been pre-set to produce ice approximately 1/2" (13 mm) thick, while operating in a room temperature of 70°F (21°C).
Operation in different room temperatures may require readjusting the control toward "THICK" or "THIN."

Best operation will be obtained with ice 1/2" (13 mm) to 5/8" (16 mm) thick.

If operating in a warm room (above 90°F [32°C]) **DO NOT** set control to maximum thickness or the unit may malfunction.

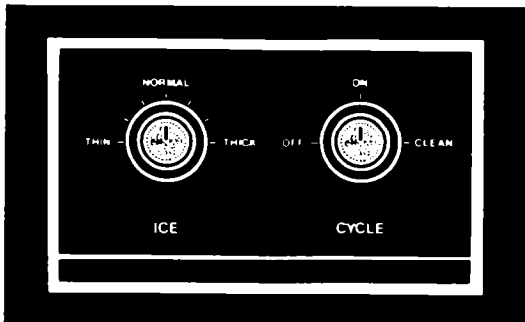

2. To start the normal ice making cycle, turn the Cycle Control Knob to "ON."
3. To stop ice maker operation, turn Cycle Control Knob to "OFF."

The "CLEAN" setting is used whenever solutions are circulated through the ice maker for cleaning. Only the water pump operates at this setting. See "Cleaning the ice maker system" on page 9 for specific instructions.

Changing the bin door panel

You can easily change the color of the front panel on the storage bin door. Two colors are available: Black and White.

To change panel:

1. Open the storage bin door. Remove the two screws on the top of the door, which hold the handle.
2. Loosen the screws in both of the side trim pieces.
3. Remove the handle and the handle insert.

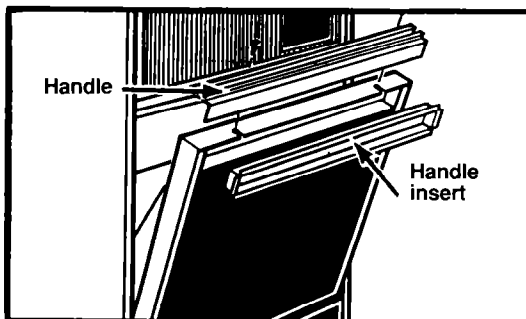

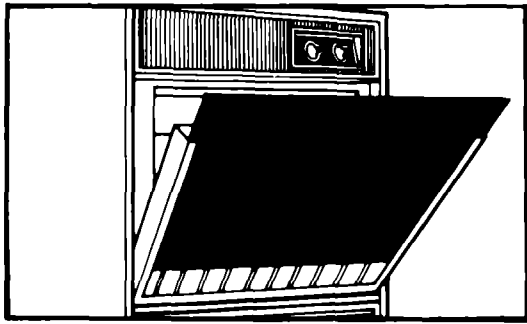

4. Carefully slide the panel out. You will find the reverse side is white. For units with white panels showing, the reverse side will be black.
5. Choose the color you want to show and carefully slide the panel back into the door.

NOTE: Be careful not to scratch the panel as it is inserted.

6. Replace the handle insert and tighten the screws in both side trim pieces. Replace the handle and the screws.

NOTE: You can make a decorative wood front to match existing cabinets. The panel should be 1/4" (6 mm) thick and 17" x 11 1/4" (433 mm x 286 mm). Remove the color panel and break off the ribs on the door insulation to allow for wood thickness.

Changing the lower access panel

⚠ WARNING

Electrical Shock Hazard
Do not operate ice maker with lower access panel or control panel removed. Electrical shock or personal injury could result.

1. Remove the two screws in the bottom grille area.

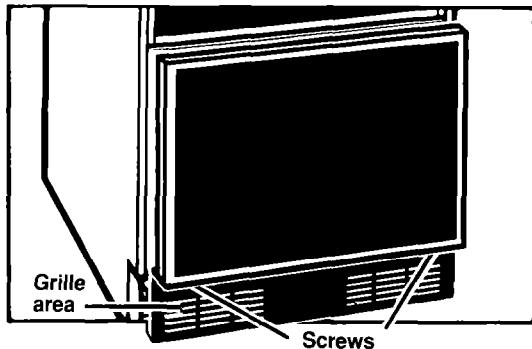

2. Remove the two screws from the top panel trim and remove the top trim.

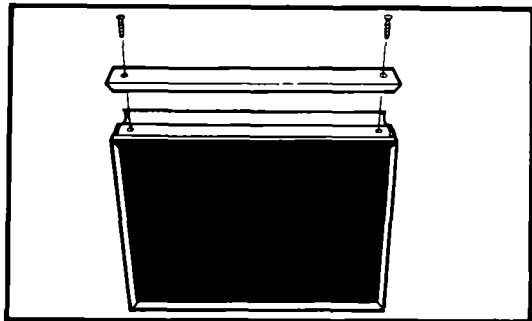

Using Your Ice Maker Continued

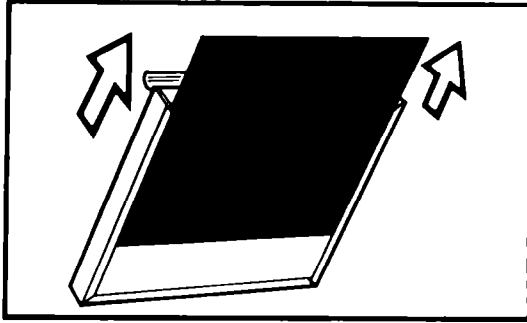

3. Carefully slide the panel out.
4. Choose the color you want to show and carefully slide the panel back into the lower access panel.
NOTE: Be careful not to scratch the panel as it is inserted.
5. Replace the top trim and screws. Replace the lower access panel assembly and screws.
NOTE: You can make a decorative wood front to match existing cabinets. The panel should be $\frac{1}{4}$ " (6 mm) thick and $17" \times 11 \frac{15}{16}"$ (433 mm x 303 mm). Remove the color panel and spacers to allow for wood thickness.

Changing the light bulb

⚠ WARNING

Electrical Shock Hazard

Before removing the light bulb, either unplug the ice maker or disconnect the electricity leading to the ice maker at the main power supply. Shock and injury can occur if electricity remains connected.

The ice maker has a light bulb in the top of the storage bin. To replace it, open the bin door and follow these instructions:

1. Disconnect ice maker from power supply.
2. Remove the two thumb screws and slide the ice cutter grid forward, out of the two slots near the water pan. Set the ice cutter grid on the bin door.
3. Press the front of the light shield in while pulling down to remove it from the light bracket.

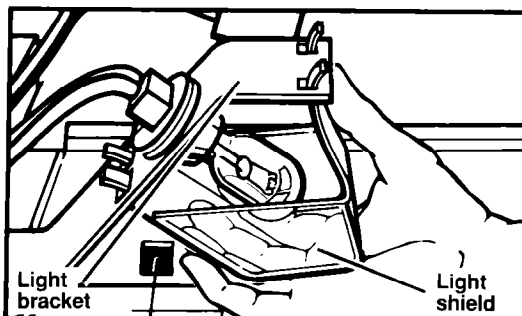
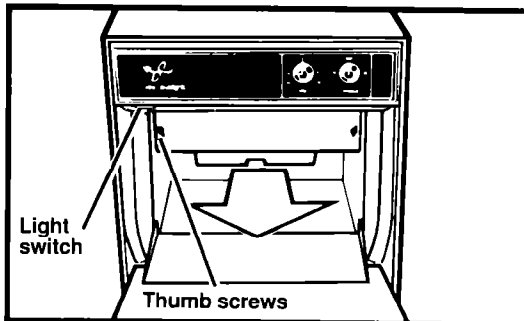

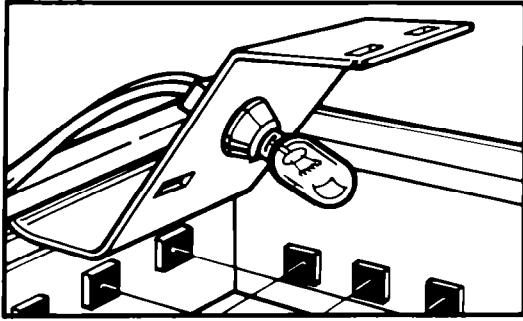

4. Remove bulb. Replace with a 15-watt bayonet base type bulb.
5. Replace the light shield, ice cutter grid and two thumb screws.
6. Reconnect power supply.

Cleaning and Caring For Your Ice Maker

Periodically inspect and clean the ice maker to keep it operating at peak efficiency and to prevent premature failure of system components.

Both the ice making system and the air cooled condenser need to be cleaned regularly.

The minerals rejected from the circulating water during the freezing cycle will eventually form a hard scaly deposit in the water system which prevents a rapid release of the ice from the freezing plate.

Clean the ice and water system periodically to remove mineral scale build-up. Frequency of cleaning depends on water hardness. With hard water (15 to 20 grains/gal.), cleaning may be required as frequently as every six months.

A dirty or clogged condenser:

- prevents proper air flow.
- reduces ice making capacity.
- causes higher than recommended operating temperatures which may lead to component failure.

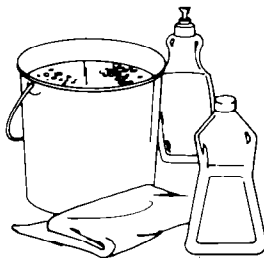

Cleaning exterior surfaces

Wash the exterior enamel surfaces and gaskets with warm water and mild soap or detergent. Rinse and dry. Regular use of a good household appliance cleaner and wax will help protect the finish.

Do not use abrasive cleaners on enamel surfaces as they may scratch the finish.

Cleaning the condenser

⚠ WARNING

Personal Injury and Product Damage Hazard

- Be sure the ice maker is OFF and disconnected from the main power supply. Unit could suddenly start if not disconnected. Condenser fan rotation, sharp condenser fins and hot tubing could cause personal injury.
- Condenser fins can bend easily. Use care when vacuuming the condenser to keep from bending the fins.

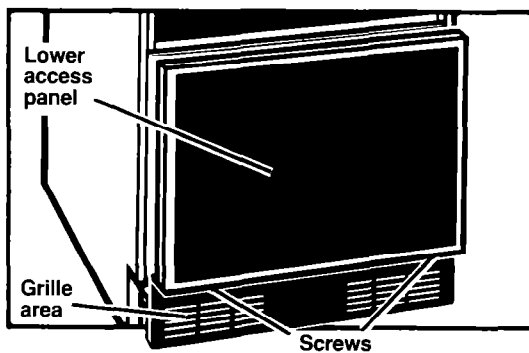

1. Disconnect electrical power supply to the ice maker and turn the Cycle Control Knob to "OFF."
2. Remove the two screws from the grille area of the lower access panel.
3. Pull forward and down to remove the panel.
4. Remove dirt and lint from the condenser fins and the unit compartment with a brush attachment attached to a vacuum cleaner.
5. Replace the lower access panel and screws. The top of the access panel needs to be secured under the two metal tabs before replacing the screws.
6. Plug unit in and turn the Cycle Control Knob to "ON."

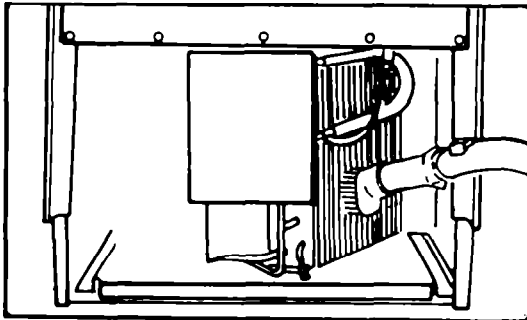

Cleaning the ice maker system

⚠ WARNING

Personal Injury Hazard

Most ice machine cleaners are citric or phosphoric acid which can cause irritation even after dilution. In case of contact with eyes, flush eyes thoroughly with fresh water and contact a physician immediately. In case of contact with skin, rinse well with water. If *swallowed*, give large amounts of water and contact a physician immediately. Do not induce vomiting. **KEEP OUT OF REACH OF CHILDREN.**

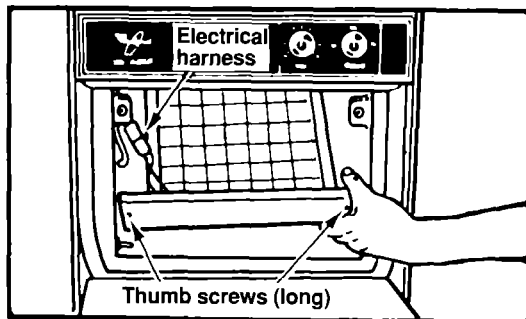

1. Turn the Cycle Control Knob to "OFF."
2. Remove the two thumb screws and slide the ice cutter grid forward, out of the two slots near the water pan.
3. Unplug the electrical harness.

⚠ CAUTION

Any ice on the grid should be melted under running warm water. Attempting to pick the ice slab off the grid may stretch and damage grid wires.

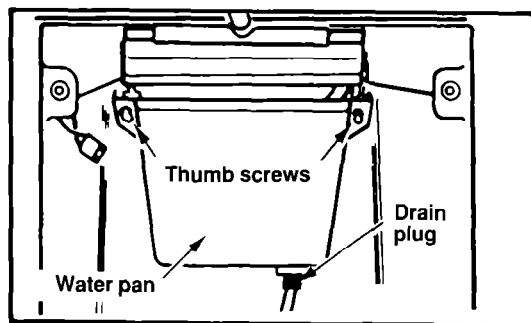

4. Remove all ice from the storage bin and the freezing plate.
5. Drain the water pan by removing the drain plug and then replace the plug.

Cleaning and Caring Continued

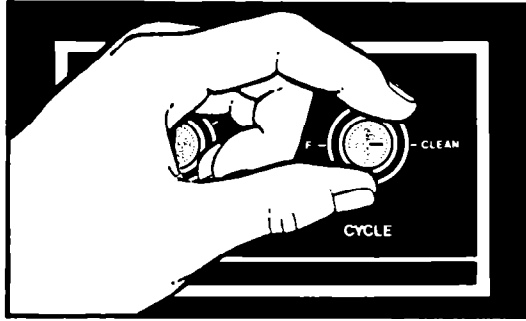

6. Pour 1/2 gallon (1.9L) of hot tap water into the water pan* and turn the Cycle Control Knob to "CLEAN." This warms up the system to make the cleaning solution more effective. Let circulate for five minutes. While tap water is circulating, prepare cleaning solution. Mix:
 - 6 oz. (170 g) powdered citric, or phosphoric acid into
 - 1/2 gallon (1.9 L) hot water(Citric and phosphoric acid crystals are available or can be ordered from many pharmacies or scientific supply houses.) Commercial ice machine cleaners (liquid) are also available from your dealer or refrigeration parts supply stores. Mix according to instructions on label (total quantity 1/2 gallon [1.9 L]).
 7. Turn Cycle Control Knob to "OFF" and drain the water pan. (See step 5.)
 8. Turn the Cycle Control Knob to "CLEAN" and slowly pour the hot cleaning solution into the water pan.* (If solution foams while pouring, wait until foaming stops.) Then add the balance of the solution.
 - Allow solution to circulate until the scale has dissolved (15 to 20 minutes). Severe scale build-up may require repeated cleaning with a fresh quantity of cleaning solution.
 - To clean scale off the side flanges of the freezing plate, use rubber gloves and scrub with a non-abrasive plastic scrubbing pad or nylon brush dipped in cleaning solution.
 9. Keep rubber gloves on to drain the cleaning solution. Turn the Cycle Control Knob to "OFF" and drain the water pan. (See step 5.)
 10. Replace the plug and add 1/2 gallon (1.9 L) of fresh water.* Set Cycle Control Knob on "CLEAN," circulate five minutes and drain. Repeat rinsing process.
- * For easier pouring of water and cleaning solution, use a 1- or 2-cup container.

Cleaning the interior components

⚠ WARNING

Electrical Shock and Product Damage Hazard

- Do not operate ice maker with lower access panel or control panel removed. Electrical shock or personal injury could result.
- Do not wash plastic parts in dishwasher. They cannot withstand temperatures above 145°F (63°C).

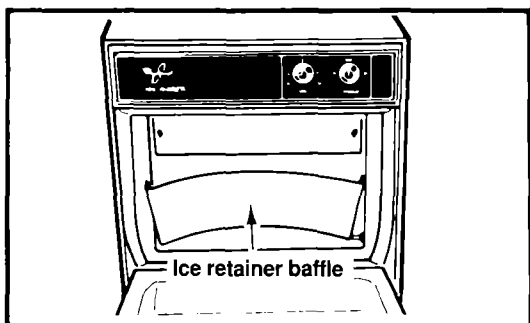

1. Turn the Cycle Control Knob to "OFF" and disconnect the electrical power supply to the machine. Open the storage bin door and remove any ice that is in the bin.
2. Remove ice retainer baffle by flexing it and then slide it off the studs.
3. Remove the ice cutter grid by unscrewing the two thumb screws, sliding the grid forward and unplugging the electrical wire harness.

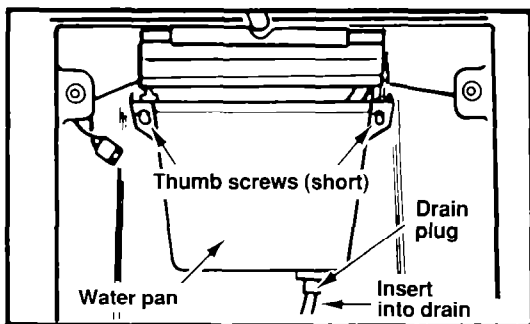

4. Remove the water pan by unscrewing and removing the two thumb screws and washers.

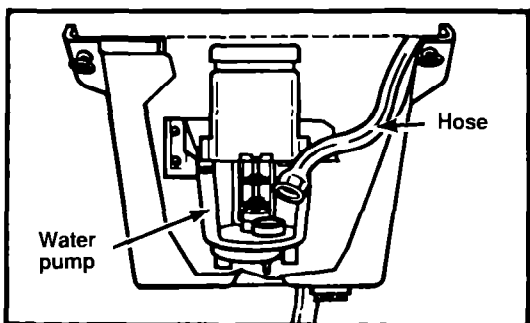

5. Remove the hose from the water pump.

Cleaning and Caring Continued

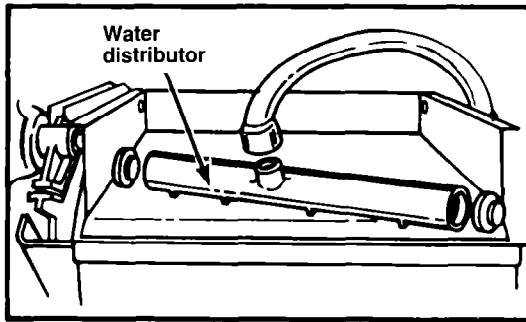

6. Remove the water distributor from the freezing plate. It is held in place by rubber end caps. Remove the inlet hose and clean all water distributor holes and the small orifice in the inlet side of the distributor. When replacing the distributor, make sure the end caps are located in the evaporator flange detents and that the water distributor holes face down.
7. Wash the **interior components** (ice retainer baffle, cutter grid, water pan, inlet hose and water distributor) and the storage bin, door gasket and ice scoop with mild soap or detergent and warm water. Rinse in clean water. These components should also be cleaned in a solution of 1 oz. (29.6 mL) of chlorine bleach in 1 gallon (3.8 L) warm water. Rinse again thoroughly in clean water.
8. Replace the interior components: water distributor, inlet hose and water pan.
9. Check the following:
 - Hose from water valve is in water pan.
 - Rubber drain plug is in water pan.
 - Water distributor is seated and holes are facing down.
 - Hose is reconnected to pump and water distributor.
 - Hose from water pan is inserted into storage bin drain opening.
10. Reconnect electrical harness, slide cutter grid into place and tighten the thumb screws. Replace the ice retainer baffle.
11. Turn Cycle Control Knob to "ON."

Filtering and treating water

In most areas it will be beneficial to filter or treat the water being supplied to the ice machine. It can improve the reliability of the machine, reduce water system maintenance and produce the best quality of ice.

The installation of a polyphosphate feeder will generally reduce scale build-up and the ice machine will require less frequent cleaning.

Municipal water systems are generally treated with chlorine to maintain a safe drinkable water supply. Activated carbon filters will sufficiently remove the residual chlorine from the water to reduce surface staining of stainless steel materials in the ice machine.

For more information on filtering and treating the water, see the dealer from whom you purchased your ice maker or your authorized Whirlpool[®] service company.

Vacation and Moving Care

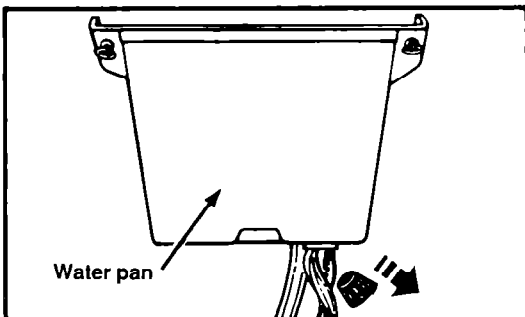
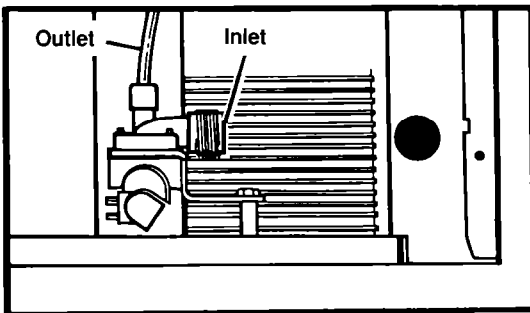
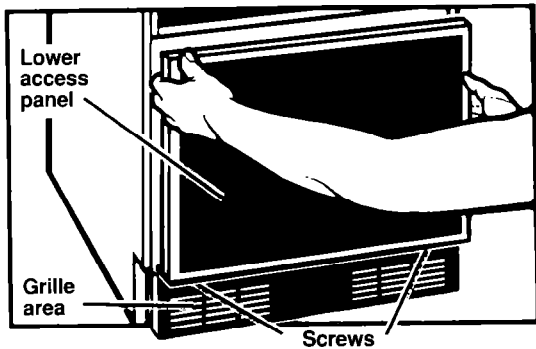
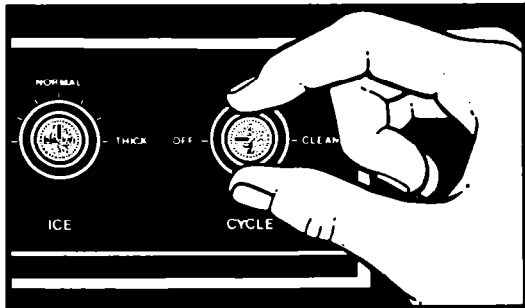

⚠ WARNING

Electrical Shock Hazard

Make sure the ice maker is disconnected from the main power supply before removing lower access panel. Failure to do so could result in electrical shock or personal injury.

To shut down the ice maker:

1. Disconnect electrical power supply to the ice maker and turn the Cycle Control Knob to "OFF."
2. Remove all ice from storage bin.
3. Shut off the water supply.

4. Remove two screws from grille area of lower access panel, then remove the panel.

5. Disconnect the inlet and outlet lines to water valve. Allow these lines to drain and then reconnect to the valve.
6. Replace lower access panel and screws.

7. Remove water from drain lines and drain water pan.
8. Before using again, clean the ice maker and storage bin.

NOTE: All components of the ice maker are permanently lubricated at the factory. They should not require any additional oiling throughout the normal life of the machine.

If You Need Service or Assistance

We suggest you follow these steps:

1. Before calling for assistance...

Performance problems often result from little things you can find and fix yourself without tools of any kind.

Unit does not run:

- Cycle Control Knob must be in the "ON" position.
- Check to see that power cord is plugged in.
- Have you checked your home's main fuses or circuit breaker box?
- Room temperature must be above 55°F (13°C). Otherwise, bin thermostat may sense cold room temperature and shut off even though bin is not full of ice. Also, unit may not restart once it does shut off.

Unit runs but produces no ice:

- Cycle Control Knob must be in the "ON" position.
- Check water supply to make sure it is open.
- If ice machine is operated at an elevation of 2,000 feet or more above sea level, both the bin thermostat and ice thickness thermostat need to be recalibrated. See Installation Instructions.

Unit runs but produces very little ice:

- Room temperature may be extremely high, more than 90°F (32°C). In this case, it is normal for ice production to be low.
- Dirt or lint may be blocking the air flow through the finned condenser. Condenser needs to be cleaned.
- Check to see if the unit has a scale build-up in water and freezing system. Clean, if necessary.

Grid is not cutting ice sheets:

- Check the grid harness plug to make sure the connection is secure.

Taste in ice cubes:

- There may be an unusually high mineral content in water supply. Water may need to be filtered or treated.
- Do not store any foods in the ice bin.
- Packaging material not all removed.

A more detailed "Trouble Diagnosis Chart" and other technical information is shipped with each unit and is located in the unit compartment section. Service repair and replacement parts manuals may be ordered directly from:

Whirlpool Corporation
Whirlpool Drive
Attention: Literature Department
LaPorte, Indiana 46350

Specify the model number of the ice machine when ordering.

2. If you need assistance*...

Call Whirlpool COOL-LINE[®] service assistance telephone number. Dial free from anywhere in the U.S.:

1-800-253-1301

and talk with one of our trained consultants. The consultant can instruct you in how to obtain satisfactory operation from your appliance or, if service is necessary, recommend a qualified service company in your area.

If you prefer, write to:

Mr. Donald Skinner
Director of Consumer Relations
Whirlpool Corporation
2000 M-63
Benton Harbor, MI 49022

Please include a daytime phone number in your correspondence.

3. If you need service*...



Whirlpool has a nationwide network of authorized WhirlpoolSM service companies. Whirlpool service technicians are trained to

fulfill the product warranty and provide after-warranty service, anywhere in the United States. To locate the authorized Whirlpool service company in your area, call our COOL-LINE[®] service assistance telephone number (see Step 2) or look in your telephone directory Yellow Pages under:

APPLIANCES - HOUSEHOLD -
MAJOR - SERVICE & REPAIR

ELECTRICAL APPLIANCES -
MAJOR - REPAIRING & PARTS

OR
WASHING MACHINES, DRYERS
& IRONERS - SERVICING

WHIRLPOOL APPLIANCES
AUTHORIZED WHIRLPOOL SERVICE

SERVICE COMPANIES
XYZ SERVICE CO
123 Maple999-9999

4. If you need FSP® replacement parts*...

FSP is a registered trademark of Whirlpool Corporation for quality parts. Look for this symbol of quality whenever you need a replacement part for your Whirlpool appliance. FSP replacement parts will fit right and work right, because they are made to the same exacting specifications used to build every new Whirlpool appliance.

To locate FSP replacement parts in your area, refer to Step 3 above or call the Whirlpool COOL-LINE service assistance number in Step 2.

5. If you are not satisfied with how the problem was solved*...

- Contact the Major Appliance Consumer Action Panel (MACAP). MACAP is a group of independent consumer experts that voices consumer views at the highest levels of the major appliance industry.
- Contact MACAP only when the dealer, authorized servicer or Whirlpool have failed to resolve your problem.

Major Appliance Consumer
Action Panel
20 North Wacker Drive
Chicago, IL 60606

- MACAP will in turn inform us of your action.

*When requesting assistance, please provide: model number, serial number, date of purchase, and a complete description of the problem. This information is needed in order to better respond to your request.

WHIRLPOOL[®] Ice Maker Warranty

IM001

LENGTH OF WARRANTY	WHIRLPOOL WILL PAY FOR
FULL ONE-YEAR WARRANTY From Date of Purchase For Residential Use	FSP [®] replacement parts and repair labor to correct defects in materials or workmanship. Service must be provided by an authorized Whirlpool SM service company.
LIMITED ONE-YEAR WARRANTY From Date of Purchase For Commercial Use	FSP replacement parts for any parts which are defective in materials or workmanship.
LIMITED FOUR-YEAR WARRANTY Second Through Fifth Year From Date of Purchase	FSP replacement compressor if defective in materials or workmanship.
WHIRLPOOL WILL NOT PAY FOR	
A. Service calls to: 1. Correct the installation of the ice maker. 2. Instruct you how to use the ice maker. 3. Replace fuses or correct wiring or plumbing. B. Pick up and delivery. This product is designed to be repaired where installed. C. Damage to ice maker caused by accident, misuse, fire, flood, acts of God or use of products not approved by Whirlpool. D. Any labor costs during the limited warranty.	

WHIRLPOOL CORPORATION SHALL NOT BE LIABLE FOR INCIDENTAL OR CONSEQUENTIAL DAMAGES. Some states do not allow the exclusion or limitation of incidental or consequential damages so this limitation or exclusion may not apply to you. This warranty gives you specific legal rights, and you may also have other rights which vary from state to state.

Outside the United States, a different warranty may apply. For details, please contact your authorized Whirlpool distributor or military exchange.

If you need service, first see the "Service and Assistance" section of this book. After checking "Service and Assistance," additional help can be found by calling our COOL-LINE[®] service assistance telephone number, **1-800-253-1301**, from anywhere in the U.S.

® Registered Trademark / SM Service Mark of Whirlpool Corporation

Free Manuals Download Website

<http://myh66.com>

<http://usermanuals.us>

<http://www.somanuals.com>

<http://www.4manuals.cc>

<http://www.manual-lib.com>

<http://www.404manual.com>

<http://www.luxmanual.com>

<http://aubethermostatmanual.com>

Golf course search by state

<http://golfingnear.com>

Email search by domain

<http://emailbydomain.com>

Auto manuals search

<http://auto.somanuals.com>

TV manuals search

<http://tv.somanuals.com>