



MODELS 690LR, 691, & 690LRVS AND 6931 PLUNGE BASE

ROUTER

TOUPIES

CONTORNEADORES

www.porter-cable.com

Copyright © 2006 Porter-Cable

Instructivo de operacion,
centros de servicio y poliza de garantia.
ADVERTENCIA: Lease este instructivo antes de usarel producto.

A15161-03-10-06-Rev.A

PORTER-CABLE®

SAVE THESE INSTRUCTIONS!

WARNING Read all instructions. Failure to follow all instructions listed below may result in electric shock, fire and/or serious injury. The term "power tool" in all of the warnings listed below refers to your mains-operated (corded) power tool or battery-operated (cordless) power tool.

WARNING To reduce the risk of injury, user must read instruction manual.

GENERAL SAFETY RULES

- 1) **Work area safety**
 - a) **Keep work area clean and well lit.** Cluttered or dark areas invite accidents.
 - b) **Do not operate power tools in explosive atmospheres, such as in the presence of flammable liquids, gases or dust.** Power tools create sparks which may ignite the dust or fumes.
 - c) **Keep children and bystanders away while operating a power tool.** Distractions can cause you to lose control.
- 2) **Electrical safety**
 - a) **Grounded tools must be plugged into an outlet properly installed and grounded in accordance with all codes and ordinances. Never remove the grounding prong or modify the plug in any way. Do not use any adaptor plugs.** Check with a qualified electrician if you are in doubt as to whether the outlet is properly grounded. If the tools should electrically malfunction or break down, grounding provides a low resistance path to carry electricity away from the user. **Applicable only to Class I (grounded) tools.**
 - b) **Double insulated tools are equipped with a polarized plug (one blade is wider than the other.) This plug will fit in a polarized outlet only one way. If the plug does not fit fully in the outlet, reverse the plug. If it still does not fit, contact a qualified electrician to install a polarized outlet. Do not change the plug in any way.** Double insulation eliminates the need for the three wire grounded power cord and grounded power supply system. **Applicable only to Class II (double insulated) tools.**
 - c) **Avoid body contact with earthed or grounded surfaces such as pipes, radiators, ranges, and refrigerators.** There is an increased risk of electric shock if your body is earthed or grounded.
 - d) **Do not expose power tools to rain or wet conditions.** Water entering a power tool will increase the risk of electric shock.
 - e) **Do not abuse the cord.** Never use the cord for carrying, pulling or unplugging the power tool. Keep cord away from heat, oil, sharp edges or moving parts. Damaged or entangled cords increase the risk of electric shock. Use only 3-wire extension cords that have 3-prong grounding-type plugs and 3-pole receptacles that accept the tool's plug.
 - f) **When operating a power tool outdoors, use an extension cord suitable for outdoor use.** If an extension cord is to be used outdoors, it must be marked with the suffix W-A or W following the cord type designation. Use of a cord suitable for outdoor use reduces the risk of electric shock. When using an extension cord, be sure to use one heavy enough to carry the current your product will draw. An undersized cord will cause a drop in line voltage resulting in loss of power and overheating. The following table shows the correct size to use depending on cord length and nameplate ampere rating. If in doubt, use the next heavier gauge. The smaller the gauge number, the heavier the cord.

Minimum Gauge for Cord Sets

Volts	Total Length of Cord in Feet			
	0-25	26-50	51-100	101-150
120V				
Ampere Rating	Gauge of wire in AWG units			
From 0 to 6 amps	18	16	16	14
" 6 to 10 amps	18	16	14	12
" 10 to 12 amps	16	16	14	12
" 12 to 16 amps	14	12	Not recommended	

- 3) **Personal safety**
 - a) **Stay alert, watch what you are doing and use common sense when operating a power tool. Do not use a power tool while you are tired or under the influence of drugs, alcohol or medication.** A moment of inattention while operating power tools may result in serious personal injury.
 - b) **Dress properly. Do not wear loose clothing or jewelry. Keep your hair, clothing and gloves away from moving parts.** Loose clothes, jewelry or long hair can be caught in moving parts.
 - c) **Avoid accidental starting. Be sure the switch is in the off-position before plugging in.** Carrying power tools with your finger on the switch or plugging in power tools that have the switch on invites accidents.
 - d) **Remove any adjusting key or wrench before turning the power tool on.** A wrench or a key left attached to a rotating part of the power tool may result in personal injury.
 - e) **Do not overreach. Keep proper footing and balance at all times.** This enables better control of the power tool in unexpected situations.
 - f) **Use safety equipment.** Always wear eye protection. Safety equipment such as dust mask, non-skid safety shoes, hard hat, or hearing protection used for appropriate conditions will reduce personal injuries.
 - g) **If devices are provided for the connection of dust extraction and collection facilities, ensure these are connected and properly used. Use of these devices can reduce dust-related hazards.** Accessories that may be suitable for one tool, may become hazardous when used on another tool.
- 4) **Power tool use and care**
 - a) **Use clamps or other practical way to secure and support the workpiece to a stable platform.** Holding the work by hand or against your body is unstable and may lead to loss of control.
 - b) **Do not force the power tool. Use the correct power tool for your application.** The correct power tool will do the job better and safer at the rate for which it was designed.
 - c) **Do not use the power tool if the switch does not turn it on and off.** Any power tool that cannot be controlled with the switch is dangerous and must be repaired.
 - d) **Disconnect the plug from the power source before making any adjustments, changing accessories, or storing power tools.** Such preventive safety measures reduce the risk

ing accessories, or storing power tools. Such preventive safety measures reduce the risk of starting the power tool accidentally.

- e) **Store idle power tools out of the reach of children and do not allow persons unfamiliar with the power tool or these instructions to operate the power tool.** Power tools are dangerous in the hands of untrained users.
 - f) **Maintain power tools. Check for misalignment or binding of moving parts, breakage of parts and any other condition that may affect the power tools operation.** If damaged, have the power tool repaired before use. Many accidents are caused by poorly maintained power tools.
 - g) **Keep cutting tools sharp and clean.** Properly maintained cutting tools with sharp cutting edges are less likely to bind and are easier to control.
 - h) **Use the power tool, accessories and tool bits etc., in accordance with these instructions and in the manner intended for the particular type of power tool, taking into account the working conditions and the work to be performed.** Use of the power tool for operations different from those intended could result in a hazardous situation.
- 5) **Service**
- a) **Have your power tool serviced by a qualified repair person using only identical replacement parts.** This will ensure that the safety of the power tool is maintained.

ADDITIONAL SPECIFIC SAFETY RULES

1. **HOLD POWER TOOLS BY INSULATED GRIPPING SURFACES** when performing an operation where the cutting tool may contact hidden wiring or its own cord. Contact with a "live" wire will make exposed metal parts of the tool "live" and shock the operator.
2. **USE CLAMPS** or other practical way to secure and support the workpiece to a stable platform. Holding the work by hand or against your body is unstable and may lead to loss of control.
3. **DISCONNECT TOOL FROM POWER SOURCE** before making adjustments or changing bits.
4. **TIGHTEN COLLET NUT** securely to prevent the bit from slipping.
5. **USE A CLAMP** or some other device to hold the workpiece rigidly in position and clear the path of the tool of obstructions.
6. **PROVIDE CLEARANCE** under workpiece for router bit when through-cutting.
7. **CHECK TO SEE THAT THE CORD** will not "hang up" during routing operation.
8. **CLEAR THE ROUTER BIT AREA** before starting motor.
9. **MAINTAIN FIRM GRIP** on router to resist starting torque.
10. **KEEP HANDS CLEAR OF BIT** when motor is running to prevent personal injury.
11. **KEEP CUTTING PRESSURE CONSTANT.** Do not overload motor.
12. **LET THE MOTOR COME TO A COMPLETE STOP** before putting the tool down.
13. **NEVER TOUCH** router bits after use. They may be extremely hot.
14. **NEVER TIGHTEN COLLET NUT** without a bit.
15. **DO NOT USE ROUTER BITS** with a diameter in excess of 2-1/2" at RPM above 13,000. Router bits up to 3-1/2" in diameter can be used when speed control is set for 13,000 RPM or less.
16. **ALWAYS KEEP CHIP SHIELD** clean and in place.
17. **AVOID "CLIMB-CUTTING"** (see "Using The Router" section in this manual). "Climb-cutting" increases the chance for loss of control resulting in possible personal injury.
18. **DO NOT HAND-HOLD THE ROUTER IN AN UPSIDE-DOWN OR HORIZONTAL POSITION.** The motor can separate from the base if not properly attached according to the instructions.

WARNING Some dust created by power sanding, sawing, grinding, drilling, and other construction activities contains chemicals known to cause cancer, birth defects or other reproductive harm.

Some examples of these chemicals are:

- lead from lead-based paints,
- crystalline silica from bricks and cement and other masonry products, and
- arsenic and chromium from chemically-treated lumber (CCA).

Your risk from these exposures varies, depending on how often you do this type of work. To reduce your exposure to these chemicals: work in a well ventilated area, and work with approved safety equipment, such as those dust masks that are specially designed to filter out microscopic particles.

- Avoid prolonged contact with dust from power sanding, sawing, grinding, drilling, and other construction activities. Wear protective clothing and wash exposed areas with soap and water. Allowing dust to get into your mouth, eyes, or lay on the skin may promote absorption of harmful chemicals.

WARNING Use of this tool can generate and/or disburse dust, which may cause serious and permanent respiratory or other injury. Always use NIOSH/OSHA approved respiratory protection appropriate for the dust exposure. Direct particles away from face and body.

CAUTION Wear appropriate hearing protection during use. Under some conditions and duration of use, noise from this product may contribute to hearing loss. The label on your tool may include the following symbols.

SYMBOLS

The label on your tool may include the following symbols:

V	volts	A	amps
Hz	hertz	~ W	watts
min	minutes	~ or a.c.	alternating current
---	.. direct current	n ₀	no load speed
□class II tool	⊕protective earth
/min	revolutions per minute		

CAUTION Do not operate your tool on a current on which the voltage is not within correct limits. Do not operate tools rated A.C. only on D.C. current. To do so may seriously damage the tool.

WARNING Turn off and unplug the tool before making any adjustments or removing or installing attachments or accessories. Be sure the switch is in the "OFF" position..

WARNING Use router bits with a diameter larger than 2-1/2" ONLY when the speed control is set between 10,000 and 13,000 RPM. The maximum diameter bit is 3-1/2".

WARNING Disconnect tool from power source when preparing the router for use, making adjustments, and when router is not in use.

INSTALLING THE BIT (1001 BASE)

To remove the motor unit from the base unit:

- (a) Open the clamp (A) Fig. 1.
 - (b) While holding the base, turn the power unit COUNTER-CLOCKWISE until the lower pin (B) in the motor housing is disengaged from groove in base.
 - (c) Lift the power unit free from the base unit.
2. Clean and insert the shank of the bit into the collet until the shank bottoms, then back it out approximately 1/16".
 3. Lay the power unit on its side on a bench with the collet pointing AWAY from you.
 4. Place one wrench on the flats of the chuck with the opposite end of the wrench resting on the bench to your left (Fig. 2).
 5. Place the other wrench on the collet and tighten COUNTER-CLOCKWISE. Tighten firmly.
 6. To remove the bit, reverse the procedure.

CAUTION Avoid possible damage to the collet. Never tighten the collet without a bit.

INSTALLING THE MOTOR

1. Open the clamp (A) Fig. 1 and set the power unit in the base unit.
2. Align the lower pin of the power unit (B) Fig. 1 with the groove in the base.
3. Rotate the power unit CLOCKWISE into the base until the upper guide pins are set in the groove of the base.
4. Close the clamp.

ADJUSTING THE DEPTH OF CUT

1. Open the clamp (A) Fig. 3.
2. Hold the base (E) and turn the power unit (F) Fig. 3 counter-clockwise until the tip of the bit is above the bottom of the base.
3. Set the tool on a flat surface.
4. Turn the power unit (F) Fig. 3 clockwise until the bit touches the work.
5. Close the clamp (A) Fig. 3.
6. Rotate the depth adjusting ring (B) Fig. 3 until the zero-line (C) is opposite the index line (D) on the housing.
7. Open the clamp (A) Fig. 3.
8. Tip the router so that the bit is clear of the work surface. Turn the power unit (F) Fig. 3 clockwise until the index line (D) on the motor housing reaches the desired depth indicated on the ring.
9. Close the clamp (A) Fig. 3.

NOTE: Setting the index line to 1/4" on the ring means the cutting edge of the bit is exposed 1/4" below the base.

ADJUSTING THE SUB-BASE ALIGNMENT (PLUNGE BASE)

Applications using a template guide require the bit to be centered in the guide. This, in turn, requires the center hole in the sub-base to be in line with the collet of the motor unit. Your model has an adjustable sub-base that has been aligned at the factory. The fixed-base router comes with the large hole.

WARNING Turn off and unplug the tool before making any adjustments or removing or installing attachments or accessories. Be sure the switch is in the "OFF" position.

1. Loosen the sub-base mounting screws (C) Fig. 4 just enough to allow the sub-base (D) to move.
2. Open the clamp and adjust the power unit so that the collet nut (B) engages the center hole in the sub-base (D). Allow the sub-base to center itself on the collet nut. Close the clamp.
3. Tighten the sub-base mounting screws (C) Fig. 4 securely.

CAUTION Be sure power switch is in "OFF" position and tool is disconnected from power source to avoid accidental starting of motor which could result in injury.

INSTALLING THE MOTOR (6931 Plunge Base)

1. Support the motor clamp (Fig. 5) and loosen the motor clamp screw (A) Fig. 5 approximately 1/2" with the hex wrench (furnished).
2. Insert the motor unit into the base with the switch positioned at the front of the left handle. Align the four pins (A) Fig. 7 (two of which are shown) in the motor case with the slots (B) Fig. 6 in the base.
3. Seat the motor in the base and tighten the motor clamp screw.

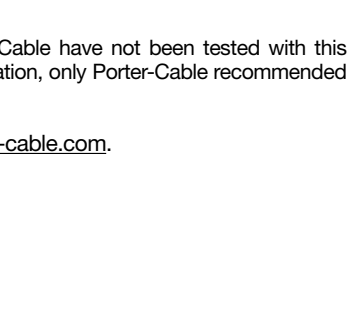
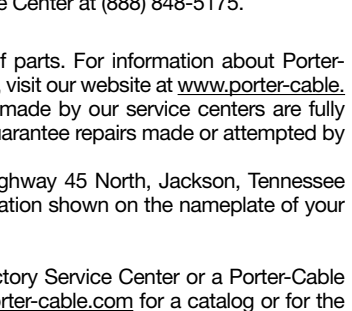
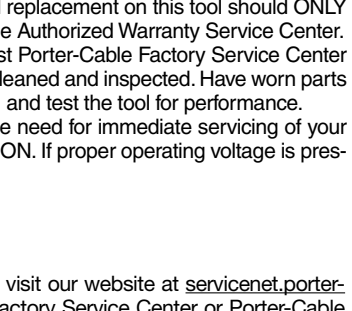
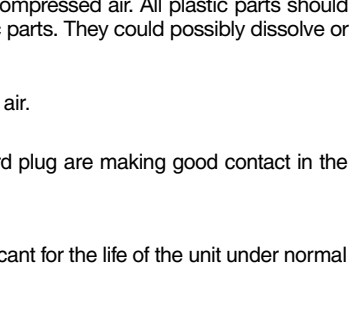
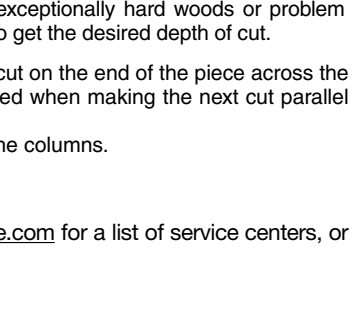
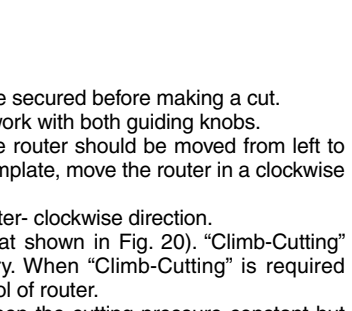
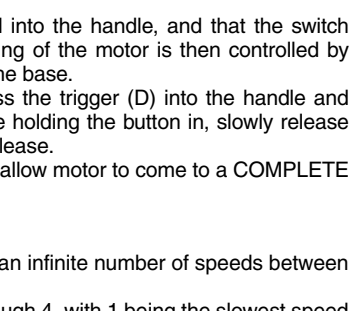
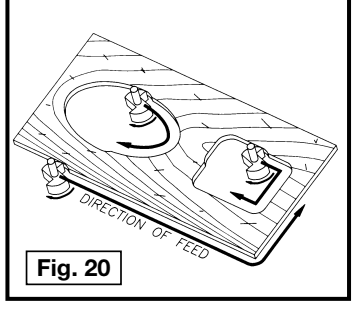
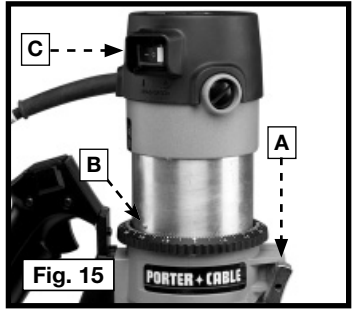
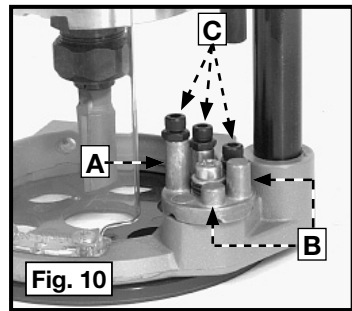
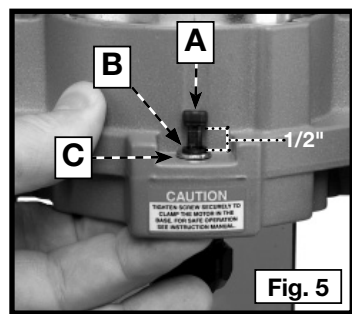
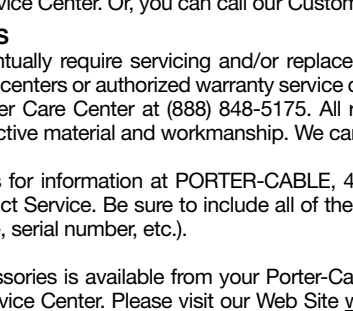
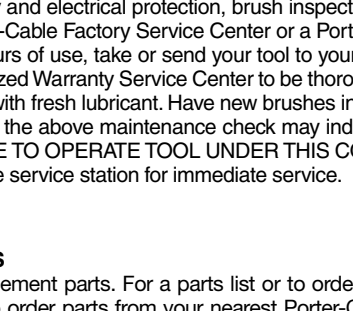
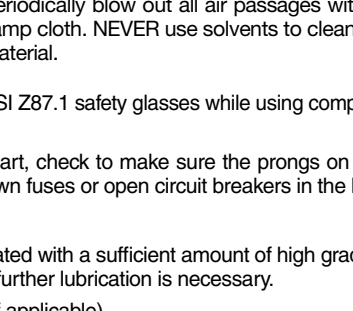
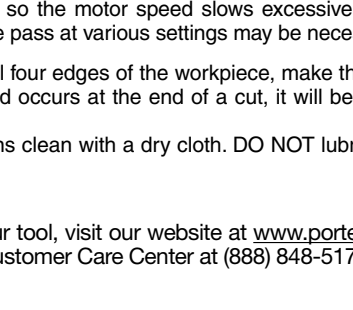
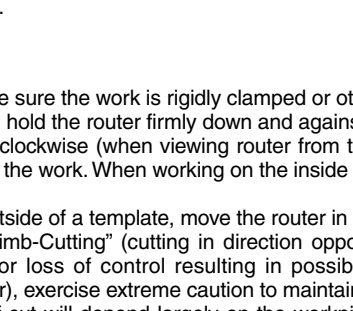
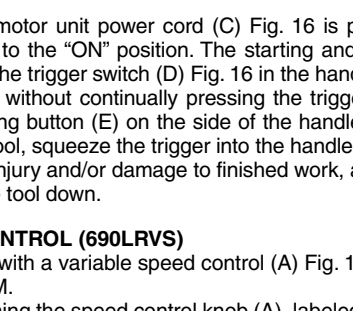
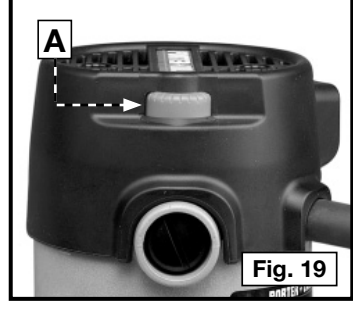
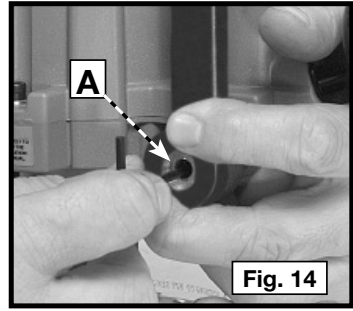
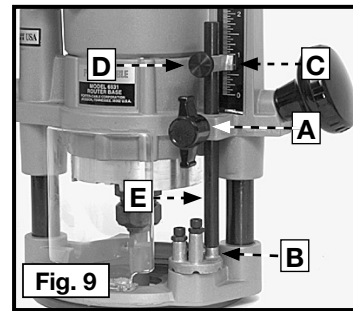
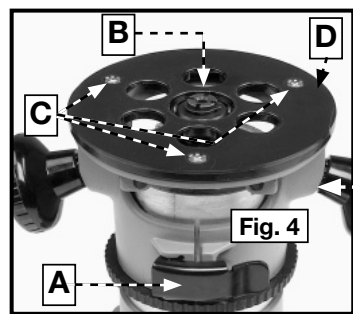
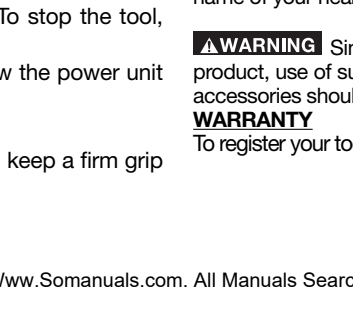
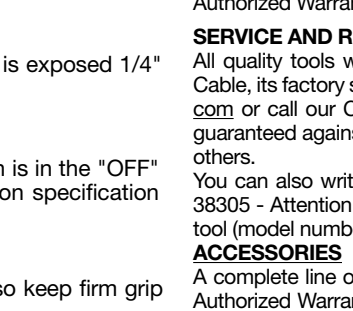
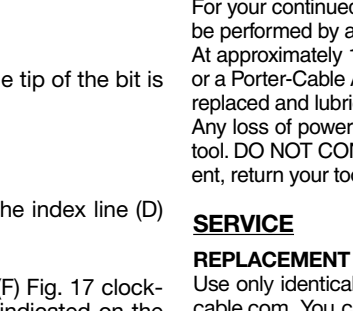
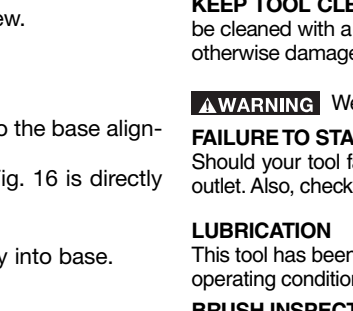
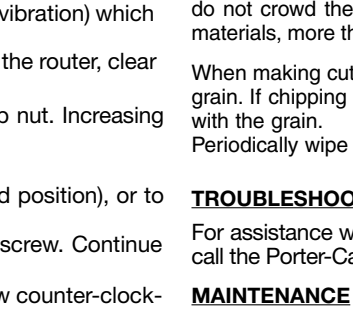
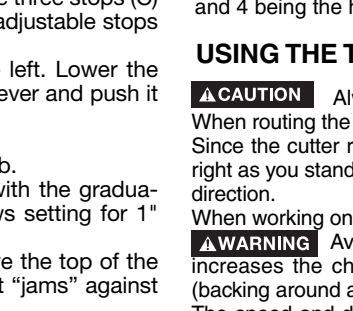
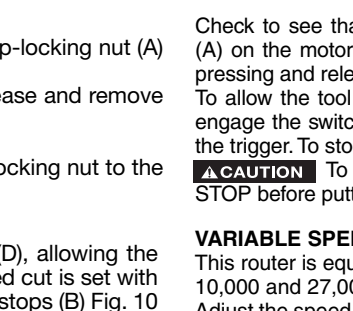
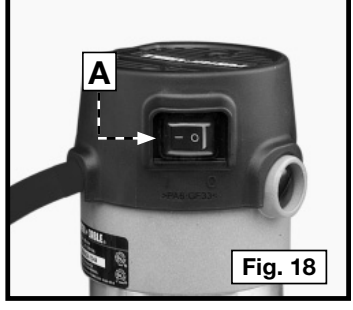
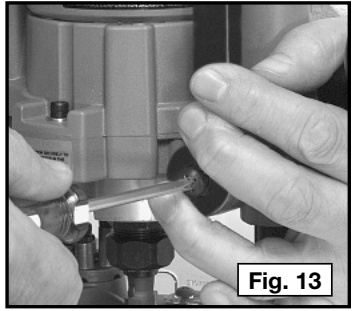
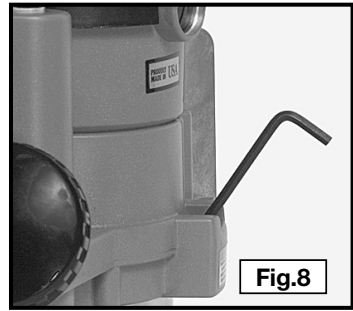
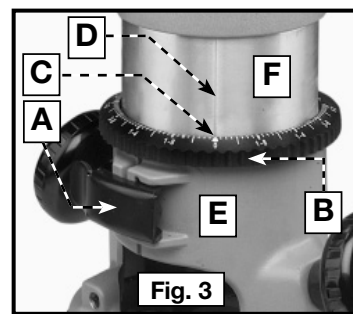
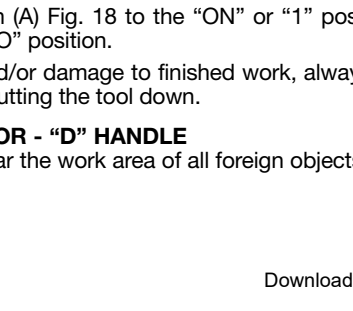
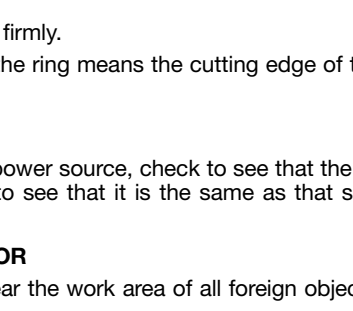
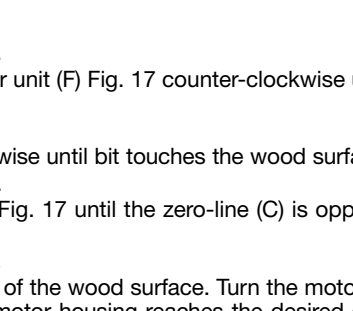
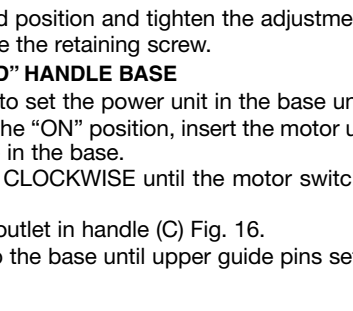
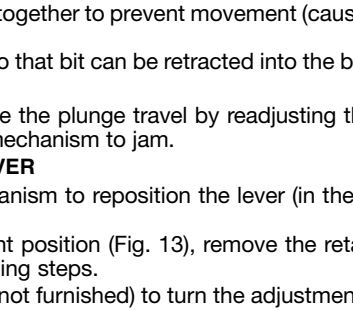
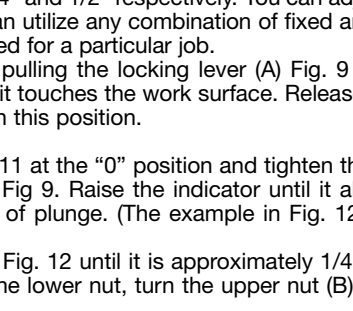
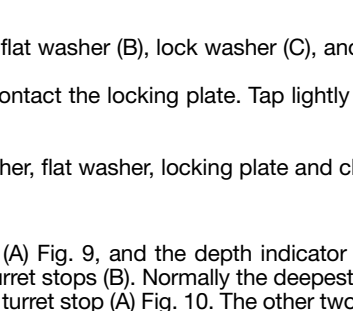
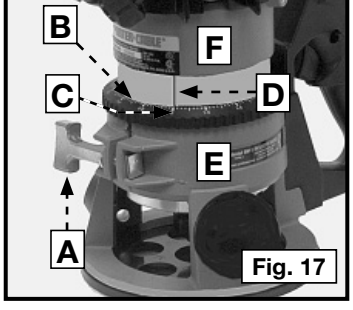
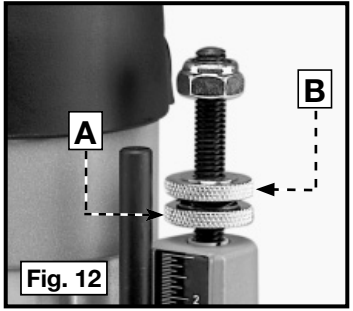
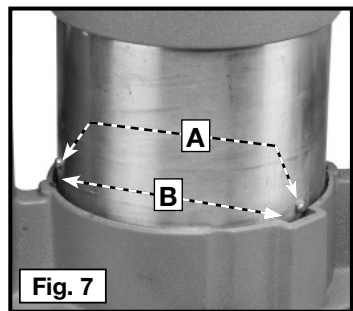
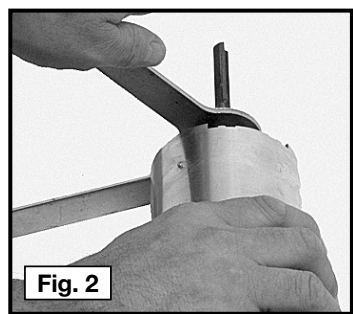
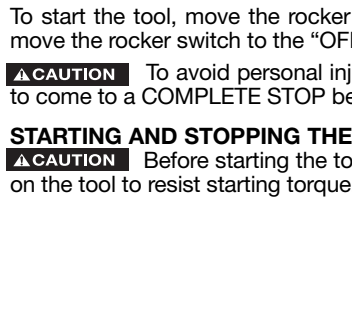
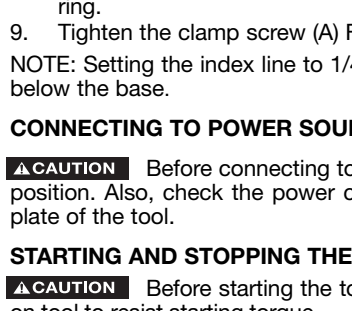
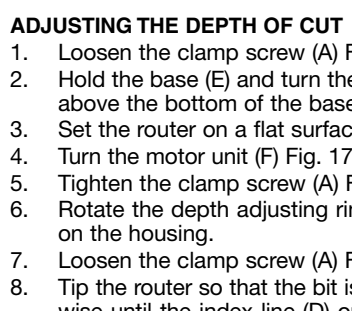
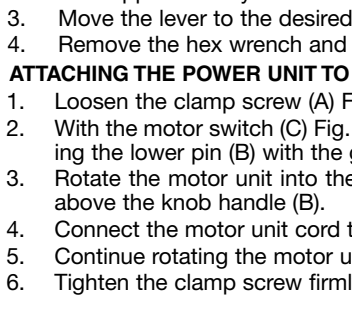
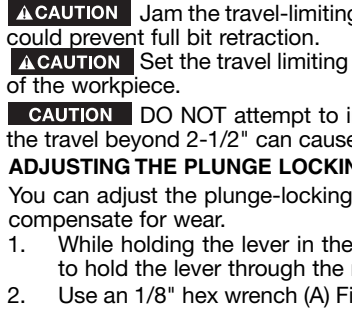
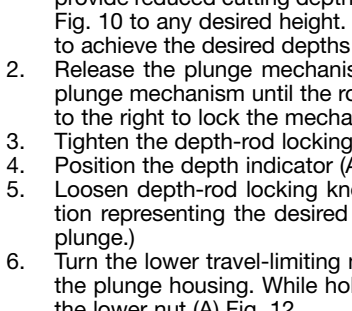
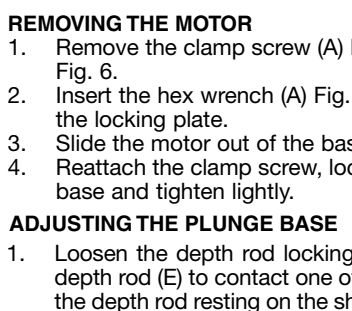
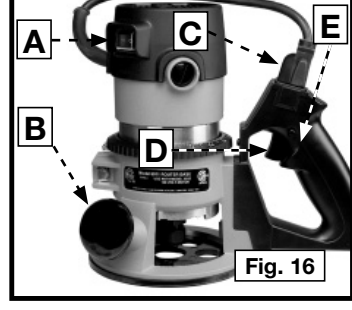
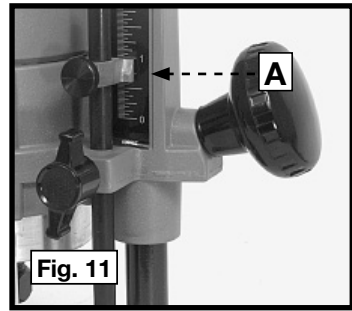
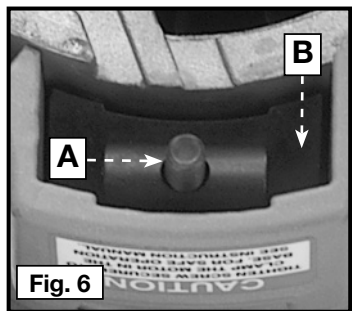
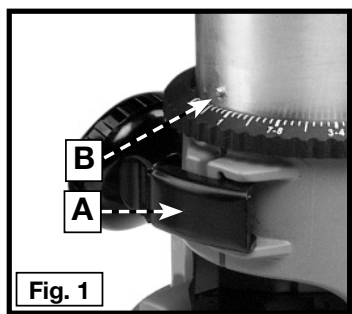

REMOVING THE MOTOR

1. Remove the clamp screw (A) Fig. 5, flat washer (B), lock washer (C), and clamp-locking nut (A) Fig. 6.
2. Insert the hex wrench (A) Fig. 8 to contact the locking plate. Tap lightly to release and remove the locking plate.
3. Slide the motor out of the base.
4. Reattach the clamp screw, lock washer, flat washer, locking plate and clamp locking nut to the base and tighten lightly.

ADJUSTING THE PLUNGE BASE

1. Loosen the depth rod locking knob (A) Fig. 9, and the depth indicator knob (D), allowing the depth rod (E) to contact one of the turret stops (B). Normally the deepest desired cut is set with the depth rod resting on the shortest turret stop (A) Fig. 10. The other two fixed stops (B) Fig. 10 provide reduced cutting depths of 1/4" and 1/2" respectively. You can adjust the three stops (C) Fig. 10 to any desired height. You can utilize any combination of fixed and/or adjustable stops to achieve the desired depths required for a particular job.
2. Release the plunge mechanism by pulling the locking lever (A) Fig. 9 to the left. Lower the plunge mechanism until the router bit touches the work surface. Release the lever and push it to the right to lock the mechanism in this position.
3. Tighten the depth-rod locking knob.
4. Position the depth indicator (A) Fig. 11 at the "0" position and tighten the knob.
5. Loosen depth-rod locking knob (A) Fig. 9. Raise the indicator until it aligns with the graduation representing the desired depth of plunge. (The example in Fig. 12 shows setting for 1" plunge.)
6. Turn the lower travel-limiting nut (A) Fig. 12 until it is approximately 1/4" above the top of the plunger housing. While holding the lower nut, turn the upper nut (B) until it "jams" against the lower nut (A) Fig. 12.

CAUTION Jam the travel-limiting nuts together to prevent movement (caused by vibration) which could prevent full bit retraction.

CAUTION Set the travel limiting nuts so that bit can be retracted into the base of the router, clear of the workpiece.

CAUTION DO NOT attempt to increase the plunge travel by readjusting the stop nut. Increasing the travel beyond 2-1/2" can cause the mechanism to jam.

ADJUSTING THE PLUNGE LOCKING LEVER

You can adjust the plunge-locking mechanism to reposition the lever (in the locked position), or to compensate for wear.

1. While holding the lever in the upright position (Fig. 13), remove the retaining screw. Continue to hold the lever through the remaining steps.
2. Use an 1/8" hex wrench (A) Fig. 14 (not furnished) to turn the adjustment screw counter-clockwise approximately 1/2 turn.
3. Move the lever to the desired locked position and tighten the adjustment screw.
4. Remove the hex wrench and replace the retaining screw.

ATTACHING THE POWER UNIT TO THE "D" HANDLE BASE

1. Loosen the clamp screw (A) Fig. 15 to set the power unit in the base unit.
2. With the motor switch (C) Fig. 15 in the "ON" position, insert the motor unit into the base aligning the lower pin (B) with the groove in the base.
3. Rotate the motor unit into the base CLOCKWISE until the motor switch (A) Fig. 16 is directly above the knob handle (B).
4. Connect the motor unit cord to the outlet in handle (C) Fig. 16.
5. Continue rotating the motor unit into the base until upper guide pins set rigidly into base.
6. Tighten the clamp screw firmly.

ADJUSTING THE DEPTH OF CUT

1. Loosen the clamp screw (A) Fig. 17.
2. Hold the base (E) and turn the motor unit (F) Fig. 17 counter-clockwise until the tip of the bit is above the bottom of the base.
3. Set the router on a flat surface.
4. Turn the motor unit (F) Fig. 17 clockwise until bit touches the wood surface.
5. Tighten the clamp screw (A) Fig. 17.
6. Rotate the depth adjusting ring (B) Fig. 17 until the zero-line (C) is opposite the index line (D) on the housing.
7. Loosen the clamp screw (A) Fig. 17.
8. Tip the router so that the bit is clear of the wood surface. Turn the motor unit (F) Fig. 17 clockwise until the index line (D) on the motor housing reaches the desired depth indicated on the ring.
9. Tighten the clamp screw (A) Fig. 17 firmly.

NOTE: Setting the index line to 1/4" on the ring means the cutting edge of the bit is exposed 1/4" below the base.

CONNECTING TO POWER SOURCE

CAUTION Before connecting tool to power source, check to see that the switch is in the "OFF" position. Also, check the power circuit to see that it is the same as that shown on specification plate of the tool.

STARTING AND STOPPING THE MOTOR

CAUTION Before starting the tool, clear the work area of all foreign objects. Also keep firm grip on tool to resist starting torque.

To start the tool, move the rocker switch (A) Fig. 18 to the "ON" or "1" position. To stop the tool, move the rocker switch to the "OFF" or "0" position.

CAUTION To avoid personal injury and/or damage to finished work, always allow the power unit to come to a COMPLETE STOP before putting the tool down.

STARTING AND STOPPING THE MOTOR - "D" HANDLE

CAUTION Before starting the tool, clear the work area of all foreign objects. Also keep a firm grip on the tool to resist starting torque.

Check to see that the motor unit power cord (C) Fig. 16 is plugged into the handle, and that the switch (A) on the motor is set to the "ON" position. The starting and stopping of the motor is then controlled by pressing and releasing the trigger switch (D) Fig. 16 in the handle of the base.

To allow the tool to run without continually pressing the trigger, press the trigger (D) into the handle and engage the switch locking button (E) on the side of the handle. While holding the button in, slowly release the trigger. To stop the tool, squeeze the trigger into the handle and release.

CAUTION To avoid injury and/or damage to finished work, always allow motor to come to a COMPLETE STOP before putting the tool down.

VARIABLE SPEED CONTROL (690LRVS)

This router is equipped with a variable speed control (A) Fig. 19 with an infinite number of speeds between 10,000 and 27,000 RPM.

Adjust the speed by turning the speed control knob (A), labeled 1 through 4, with 1 being the slowest speed and 4 being the highest.

USING THE TOOL

CAUTION Always be sure the work is rigidly clamped or otherwise secured before making a cut.

When routing the edges, hold the router firmly down and against the work with both guiding knobs. Since the cutter rotates clockwise (when viewing router from top), the router should be moved from left to right as you stand facing the work. When working on the inside of a template, move the router in a clockwise direction.

When working on the outside of a template, move the router in a counter-clockwise direction.

WARNING Avoid "Climb-Cutting" (cutting in direction opposite that shown in Fig. 20). "Climb-Cutting" increases the chance for loss of control resulting in possible injury. When "Climb-Cutting" is required (backing around a corner), exercise extreme caution to maintain control of router.

The speed and depth of cut will depend largely on the workpiece. Keep the cutting pressure constant but do not crowd the router so the motor speed slows excessively. On exceptionally hard woods or problem materials, more than one pass at various settings may be necessary to get the desired depth of cut.

When making cuts on all four edges of the workpiece, make the first cut on the end of the piece across the grain. If chipping of wood occurs at the end of a cut, it will be removed when making the next cut parallel with the grain.

Periodically wipe columns clean with a dry cloth. DO NOT lubricate the columns.

TROUBLESHOOTING

For assistance with your tool, visit our website at www.porter-cable.com for a list of service centers, or call the Porter-Cable Customer Care Center at (888) 848-5175.

MAINTENANCE

KEEP TOOL CLEAN. Periodically blow out all air passages with dry compressed air. All plastic parts should be cleaned with a soft damp cloth. NEVER use solvents to clean plastic parts. They could possibly dissolve or otherwise damage the material.

WARNING Wear ANSI Z87.1 safety glasses while using compressed air.

FAILURE TO START

Should your tool fail to start, check to make sure the prongs on the cord plug are making good contact in the outlet. Also, check for blown fuses or open circuit breakers in the line.

LUBRICATION

This tool has been lubricated with a sufficient amount of high grade lubricant for the life of the unit under normal operating conditions. No further lubrication is necessary.

BRUSH INSPECTION (If applicable)

For your continued safety and electrical protection, brush inspection and replacement on this tool should ONLY be performed by a Porter-Cable Factory Service Center or a Porter-Cable Authorized Warranty Service Center. At approximately 100 hours of use, take or send your tool to your nearest Porter-Cable Factory Service Center or a Porter-Cable Authorized Warranty Service Center to be thoroughly cleaned and inspected. Have worn parts replaced and lubricated with fresh lubricant. Have new brushes installed, and test the tool for performance. Any loss of power before the above maintenance check may indicate the need for immediate servicing of your tool. DO NOT CONTINUE TO OPERATE TOOL UNDER THIS CONDITION. If proper operating voltage is present, return your tool to the service station for immediate service.

SERVICE

REPLACEMENT PARTS

Use only identical replacement parts. For a parts list or to order parts, visit our website at servicenet.porter-cable.com. You can also order parts from your nearest Porter-Cable Factory Service Center or Porter-Cable Authorized Warranty Service Center. Or, you can call our Customer Care Center at (888) 848-5175.

SERVICE AND REPAIRS

All quality tools will eventually require servicing and/or replacement of parts. For information about Porter-Cable, its factory service centers or authorized warranty service centers, visit our website at www.porter-cable.com or call our Customer Care Center at (888) 848-5175. All repairs made by our service centers are fully guaranteed against defective material and workmanship. We cannot guarantee repairs made or attempted by others.

You can also write to us for information at PORTER-CABLE, 4825 Highway 45 North, Jackson, Tennessee 38305 - Attention: Product Service. Be sure to include all of the information shown on the nameplate of your tool (model number, type, serial number, etc.).

ACCESSORIES

A complete line of accessories is available from your Porter-Cable Factory Service Center or a Porter-Cable Authorized Warranty Service Center. Please visit our Web Site www.porter-cable.com for a catalog or for the name of your nearest supplier.

WARNING Since accessories other than those offered by Porter-Cable have not been tested with this product, use of such accessories could be hazardous. For safest operation, only Porter-Cable recommended accessories should be used with this product.

WARRANTY

To register your tool for warranty service visit our website at www.porter-cable.com.

PARA AJUSTAR LA PROFUNDIDAD DEL CORTE

1. Afloje el tornillo sujetador (A) Fig. 17.
2. Mientras detiene la base (E) gire el motor (F) Fig. 17, en SENTIDO CONTRARIO a las manecillas del reloj hasta que la punta de la broca esté un poco arriba de la parte más baja de la superficie de la base.
3. Ponga el ráuter sobre una superficie plana de madera.
4. Gire el motor (F) Fig. 17 en SENTIDO A las manecillas del reloj hasta que la broca toque la superficie de la madera.
5. Apriete el tornillo sujetador (A) Fig. 17.
6. Gire el anillo calibrador para ajustar la profundidad (B) Fig. 17 hasta que la marca de cero (C) esté alineada con la línea de índice (D) en la caja de motor.
7. Afloje el tornillo sujetador (A) Fig. 17.
8. Incline el ráuter hasta que la broca esté libre de la superficie de la madera. Gire la caja del motor (F) Fig. 17 en SENTIDO A las manecillas del reloj hasta que la línea de índice (D) en la caja del motor llegue a la profundidad deseada e indicada en el anillo calibrador.
9. Apriete el tornillo sujetador (A) Fig. 17 firmemente.

TOME NOTA: Alineando la línea de índice 1/4" en el anillo indica que la cuchilla de la broca sobrepasa la base 1/4".

PARA CONECTAR A LA FUENTE DE ELECTRICIDAD

⚠ PRECAUCIÓN Antes de conectar el ráuter a la fuente de electricidad, ASEGURE QUE EL INTERRUPTOR ESTE EN LA POSICIÓN APAGADA, "OFF". También verifique que la potencia del circuito sea la misma que la indicada en la placa de especificaciones del ráuter.

PARA PONER EN MARCHA Y PARAR EL MOTOR

⚠ PRECAUCIÓN Antes de poner el ráuter en marcha, asegure que la broca esté libre de cualquier objeto del forjén. También sujete (agarre) el ráuter firmemente para evitar la tendencia del ráuter de torcerse al comenzar el trabajo.

Para poner el motor en marcha, mueva el interruptor de eje de balancín a "ON" o "1" coloque (a) Fig. 19. Para parar pararlo, mueva el interruptor de eje de balancín a "Off" o a la posición de "0".

⚠ PRECAUCIÓN Para evitar herida personal o daño a la obra, siempre deje que el motor PARE COMPLETAMENTE antes de poner el ráuter a un lado.

PARA PONER EN MARCHA Y PARAR EL MOTOR (LA MANIJA DE "D")

⚠ PRECAUCIÓN Antes de poner el ráuter en marcha, asegure que la broca esté libre de la pieza en elaboración y de objetos ajenos. También sujete (agarre) el ráuter firmemente para evitar la tendencia del ráuter de torcerse al comenzar el trabajo.

Asegure que el cable del motor (A) (Fig. 26) esté enchufado en la empuñadura, y que el interruptor (B) del motor esté en la posición prendida, "ON". Ahora la habilidad de poner en marcha y parar el motor se controla por medio del gatillo (C) en la agarradera de la base.

Para mantener el motor en marcha sin tener que apretar constantemente el gatillo (C), Fig. 22, sólo apriete el gatillo (C) completamente y empuje el botón en el lado de la empuñadura. Mientras empuja el botón, suelte el gatillo despacio. Para parar el motor, apriete y suelte el gatillo para desenganchar el botón.

⚠ PRECAUCIÓN Para evitar herida personal o daño a la obra, siempre deje que el motor PARE COMPLETAMENTE antes de poner el ráuter a un lado.

MANDO DE VELOCIDAD (SÓLO EL MODELO 690LRVS)

Esta rebajadora se equipa de variable del (A) Fig. 19 del control de la velocidad con un número infinito de velocidades entre 10.000 y 27.000 RPM.

La velocidad se ajusta por dar vuelta velocidad control perilla (a), etiquetar 1 por 4, con 1 ser reducido velocidad y 4 ser alto.

USAR LA HERRAMIENTA

⚠ PRECAUCIÓN Siempre asegure que la pieza en elaboración esté engrapada firmemente o sujeta de otra manera antes de hacer el corte. Por lo general, cuando uno trabaja en un banco, la pieza en elaboración debe estar sujeta por unas prensas de madera (carpintería). Cuando contornee cantos (bordes), el ráuter debe ser deslizado firmemente contra la madera por ambas perillas (agarraderas) de guía.

Como la broca gira en sentido de las manecillas del reloj (vista de arriba), el ráuter debe avanzar de la izquierda a la derecha con el trabajo enfrente del operario. Cuando trabaje dentro de un patrón (plantilla), aváncelo en el sentido de las manecillas del reloj. Cuando trabaje en el exterior de un patrón, avance el ráuter en el sentido contrario a las manecillas del reloj.

⚠ ADVERTENCIA Evite el "CORTE TREPADOR" (un corte en la dirección opuesta a la indicada en la Fig. 20). El "CORTE TREPADOR" aumenta el riesgo de la pérdida de control, resultando en la posibilidad de herida personal. Cuando sea necesario hacer el "CORTE TREPADOR" (retrocediendo a una esquina), tenga extrema precaución para mantener control del ráuter.

La velocidad y profundidad del corte dependerá principalmente de la clase de material en elaboración. Mantenga la presión del corte constante pero no empuje el ráuter hasta el punto de aminorar (disminuir) la velocidad del motor excesivamente. Con el uso de maderas demasiado duras o materiales problemáticos, puede ser necesario hacer más de una pasada con profundidades crecientes para obtener la profundidad de corte deseada.

Cuando haga cortes en los cuatro cantos (bordes) de la pieza, es aconsejable hacer el primer corte al través del hilo. Así si la madera se astilla al final del corte, las astillas se pueden quitar con el siguiente corte al hilo.

Periódicamente limpie las columnas con una tela seca. NO lubrique las columnas.

LOCALIZACION DE FALLAS

Para obtener ayuda con su herramienta, visite nuestro sitio Web www.porter-cable.com y obtenga una lista de los centros de mantenimiento, o llame al Centro de atención al cliente de Porter-Cable al (888) 848-5175.

MANTENIMIENTO

MANTENGA LA HERRAMIENTA LIMPIA

Periódicamente sople todas las entradas de aire con aire comprimido seco. Todas las piezas de plástico deben limpiarse con un paño suave y húmedo. NUNCA utilice solventes para limpiar las piezas de plástico. Podrían derretirse o dañar el material.

⚠ ADVERTENCIA Cuando trabaje con aire comprimido, use anteojos de seguridad conforme a la norma Z87.1 del ANSI.

FALLA EN EL ENCENDIDO

Si la herramienta no enciende, verifique que las patas del enchufe del cable hagan buen contacto en el tomacorriente. Además, revise que no haya fusibles quemados o interruptores automáticos de circuito abierto en la línea.

LUBRICACIÓN

Esta herramienta ha sido aceiteada con una cantidad suficiente de lubricante de alto grado para extender la vida de la unidad en condiciones normales de funcionamiento. No se requiere lubricación adicional.

INSPECCIÓN DE LOS CEPILLOS (Si corresponde)

Para mantener la seguridad y la protección eléctrica, la inspección de los cepillos y su reemplazo deben ser realizados ÚNICAMENTE en una ESTACIÓN DE MANTENIMIENTO AUTORIZADA DE PORTER-CABLE o en un CENTRO DE MANTENIMIENTO DE FÁBRICA DE PORTER-CABLE•DELTA.

A las 100 horas de uso aproximadamente, lleve o envíe la herramienta a la Estación de mantenimiento autorizada de Porter-Cable más cercana para una limpieza e inspección exhaustiva. Haga reemplazar las piezas desgastadas y lubrique con lubricante nuevo. Instale nuevos cepillos y pruebe el funcionamiento de la herramienta.

Cualquier pérdida de potencia antes de la comprobación del mantenimiento mencionado puede indicar la necesidad del mantenimiento inmediato de su herramienta. NO CONTINÚE UTILIZANDO LA HERRAMIENTA EN ESTAS CONDICIONES. Si la herramienta presenta un voltaje de funcionamiento correcto, devuélvala para un mantenimiento inmediato.

SERVICIO

PIEZAS DE REPUESTO

Utilice sólo piezas de repuesto idénticas. Para obtener una lista de piezas o para solicitar piezas, visite nuestro sitio Web en servicenet.porter-cable.com. También puede solicitar piezas en nuestro centro más cercano, o llamando a nuestro Centro de atención al cliente al (888) 848-5175.

MANTENIMIENTO Y REPARACIONES

Con el paso del tiempo, todas las herramientas de calidad requieren mantenimiento o reemplazo de las piezas. Para obtener información acerca de Porter-Cable, sus sucursales o un Centro de mantenimiento con garantía autorizado, visite nuestro sitio Web www.porter-cable.com o llame a nuestro Centro de atención al cliente al (888) 848-5175. Todas las reparaciones realizadas en nuestros centros de mantenimiento están completamente garantizadas en relación con los materiales defectuosos y la mano de obra. No podemos otorgar garantías en relación con las reparaciones ni los intentos de reparación de otras personas.

También puede escribirnos solicitando información a PORTER-CABLE, 4825 Highway 45 North, Jackson, Tennessee 38305; referencia: Mantenimiento de productos. Asegúrese de incluir toda la información mencionada en la placa de la herramienta (número de modelo, tipo, número de serie, etc.)

El mantenimiento del cargador no puede ser realizado por el usuario. Dentro del cargador no hay piezas a las que el usuario pueda hacerles el mantenimiento. El mantenimiento de la herramienta debe realizarse en un centro de mantenimiento autorizado para evitar daños a los componentes internos, sensibles a la estática.

ACCESORIOS

Su proveedor de productos Porter-Cable•Delta, los Centros de mantenimiento de fábrica de Porter-Cable•Delta y los Centros de mantenimiento autorizados de Porter-Cable pueden suministrarle una línea completa de accesorios. Para obtener un catálogo o para conocer el nombre de su proveedor más cercano, visite nuestro sitio Web www.porter-cable.com.

⚠ ADVERTENCIA Debido a que no se han probado con este producto otros accesorios que no sean los que ofrece Porter-Cable•Delta, el uso de tales accesorios puede ser peligroso. Para un funcionamiento seguro, con este producto sólo deben utilizarse los accesorios recomendados por Porter-Cable•Delta.

GARANTÍA

Para registrar la herramienta a fin de obtener el mantenimiento cubierto por la garantía, visite nuestro sitio Web www.porter-cable.com.

GARANTÍA LIMITADA DE UN AÑO DE PORTER-CABLE: Porter-Cable garantiza su herramienta eléctrica profesional durante un año a partir de la fecha de compra original. Repararemos o reemplazaremos, a nuestra discreción, las partes del producto y los accesorios cubiertos por la garantía que, luego de ser examinados, se compruebe tengan un defecto en el material o de fabricación durante el período de la garantía. Para la reparación o el reemplazo, devuelva la herramienta completa o el accesorio a su Estación de mantenimiento autorizada o Centro de mantenimiento Porter-Cable. Le pueden solicitar comprobante de compra. Esta garantía no cubre la reparación o el reemplazo necesarios por mal uso, abuso, desgaste normal o por la reparación o el intento de reparación llevados a cabo en otros centros o estaciones de mantenimiento que no sean los nuestros.

TODA GARANTÍA IMPLÍCITA, INCLUIDAS LAS GARANTÍAS IMPLÍCITAS DE COMERCIABILIDAD E IDONEIDAD PARA UN PROPÓSITO DETERMINADO, TENDRÁ UN (1) AÑO DE VIGENCIA A PARTIR DE LA FECHA DE COMPRA ORIGINAL. Para obtener información sobre la garantía, escribanos a: PORTER-CABLE, 4825 Highway 45 North, Jackson, Tennessee 38305; referencia: Mantenimiento de productos. LA OBLIGACIÓN PRECEDENTE ES RESPONSABILIDAD EXCLUSIVA DE PORTER-CABLE BAJO ÉSTA O CUALQUIER GARANTÍA IMPLÍCITA Y BAJO NINGUNA CIRCUNSTANCIA PORTER-CABLE SE HARÁ CARGO DE LOS DAÑOS INCIDENTALES O INDIRECTOS. Algunos estados no permiten establecer limitaciones sobre la duración de una garantía implícita o la exclusión o limitación de los daños y perjuicios incidentales e indirectos, de modo que las exclusiones y las limitaciones establecidas en la presente pueden no ser aplicables.

Esta garantía le concede derechos legales específicos; pueden existir otros derechos que varían según el estado..

REEMPLAZO DE LAS ETIQUETAS DE ADVERTENCIA

Si sus etiquetas de advertencia se vuelven ilegibles o faltan, llame al (888) 848-5175 para que se las reemplacen gratuitamente

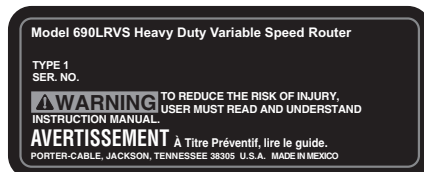

PÓLIZA DE GARANTÍA

IDENTIFICACIÓN DEL PRODUCTO:

Sello o firma del Distribuidor.Nombre del producto: _____ Mod./Cat.: _____

Marca: _____ Núm. de serie: _____

(Datos para ser llenados por el distribuidor)Fecha de compra y/o entrega del producto: _____

Nombre y domicilio del distribuidor donde se adquirió el producto: _____ Este

producto está garantizado por un año a partir de la fecha de entrega, contra cualquier defecto en su funcionamiento, así como en materiales y mano de obra empleados para su fabricación. Nuestra garantía incluye la reparación o reposición del producto y/o componentes sincargo alguno para el cliente, incluyendo mano de obra, así como los gastos de transportaciónrazonablemente erogados derivados del cumplimiento de este certificado.Para hacer efectiva esta garantía deberá presentar su herramienta y esta póliza sellada por establecimiento comercial donde se adquirió el producto, de no contar con ésta, bastará la factura de compra.

EXCEPCIONES

Esta garantía no será válida en los siguientes casos:

- Cuando el producto se hubiese utilizado en condiciones distintas a las normales;
- Cuando el producto no hubiese sido operado de acuerdo con el instructivo de uso que seacompaña;
- Cuando el producto hubiese sido alterado o reparado por personas distintas a las enlistadas al final de este certificado.

Anexo encontrará una relación de sucursales de servicio de fábrica, centros de servicio autorizados y franquiciados en la República Mexicana, donde podrá hacer efectiva su garantía yadquirir partes, refacciones y accesorios originales.

ESPECIFICACIONES

120V / 60 Hz / 11 amps

10000 - 27500 RPMs

Para servicio y ventas consulte
"HERRAMIENTAS ELECTRICAS"
en la sección amarilla.



The following are trademarks of PORTER-CABLE • DELTA (Las siguientes son marcas registradas de PORTER-CABLE • DELTA S.A.) (Les marques suivantes sont des marques de fabricant de la PORTER-CABLE • DELTA): Auto-Set®, BAMMER®, B.O.S.S.®, Builder's Saw®, Contractor's Saw®, Contractor's Saw II™, Delta®, DELTACRAFT®, DELTAGRAM™, Delta Series 2000™, DURATRONIC™, Emc2™, FLEX®, Flying Chips™, FRAME SAW®, Grip Vac™, Homecraft®, INNOVATION THAT WORKS®, Jet-Lock®, JETSTREAM®, Kickstand®, LASERLOC®, MICRO-SET®, Micro-Set®, MIDI LATHE®, MORTEN™, NETWORK™, OMNIJIG®, POCKET CUTTER®, PORTA-BAND®, PORTA-PLANE®, PORTER-CABLE®&(design), PORTER-CABLE®PROFESSIONAL POWER TOOLS, PORTER-CABLE REDEFINING PERFORMANCE™, Posi-Matic®, Q-3®&(design), QUICKSAND®&(design), QUICKSET™, QUICKSET II®, QUICKSET PLUS™, RIPTIDE™&(design), SAFE GUARD II®, SAFE-LOC®, Sanding Center®, SANDTRAP®&(design), SAW BOSS®, Sawbuck™, Sidekick®, SPEED-BLOC®, SPEEDMATIC®, SPEEDTRONIC®, STAIR EASE®, The American Woodshop®&(design), The Lumber Company®&(design), THE PROFESSIONAL EDGE®, THE PROFESSIONAL SELECT®, THIN-LINE™, TIGER®, TIGER CUB®, TIGER SAW®, TORQBUSTER®, TORQ-BUSTER®, TRU-MATCH™, TWIN-LITE®, UNIGUARD®, Unifence®, UNIFEDER™, Unihed®, Uniplane™, Unirip®, Unisaw®, Univise®, Versa-Feeder®, VERSA-PLANE™, WHISPER SERIES®, WOODWORKER'S CHOICE™.

Trademarks noted with ™ and ® are registered in the United States Patent and Trademark Office and may also be registered in other

PORTER-CABLE®

4825 Highway 45 North
Jackson, TN 38305
(888)-848-5175

www.porter-cable.com

Free Manuals Download Website

<http://myh66.com>

<http://usermanuals.us>

<http://www.somanuals.com>

<http://www.4manuals.cc>

<http://www.manual-lib.com>

<http://www.404manual.com>

<http://www.luxmanual.com>

<http://aubethermostatmanual.com>

Golf course search by state

<http://golfingnear.com>

Email search by domain

<http://emailbydomain.com>

Auto manuals search

<http://auto.somanuals.com>

TV manuals search

<http://tv.somanuals.com>