

Use & Care

G U I D E

Three speed automatic washers

A Note to You	2
Washer Safety	3
Parts and Features ...	4
Operating Your Washer	5
Caring for Your Washer	12
Troubleshooting	13
Requesting Assistance or Service	17
Index	19
Warranty	20

In the U.S.A. for assistance or service,
call the Consumer Assistance Center:

1-800-253-1301

In Canada for assistance or service,
see page 18.



3950310

www.whirlpool.com

A NOTE TO YOU

Thank you for buying a WHIRLPOOL* appliance.

The Whirlpool Brand is committed to designing quality products that consistently perform for you to make your life easier. To ensure that you enjoy years of trouble-free operation, we developed this Use and Care Guide. It is full of valuable information about how to operate and maintain your appliance properly and safely. Please read it carefully.

Also, complete and mail the **Ownership Registration Card** provided with your appliance. The card helps us notify you about any new information on your appliance.

Please record your model's information.

Whenever you call to request service for your appliance, you need to know your complete model number and serial number. You can find this information on the model and serial number label (see the diagram on the "Parts and Features" page for the location of the label). Also, record the other information shown in the next column.

Model Number _____

Serial Number _____

Purchase Date _____

Dealer Name _____

Dealer Address _____

Dealer Phone _____

Keep this book and the sales slip together in a safe place for future reference.

Our Consumer Assistance Center number is toll free.

1-800-253-1301

To find detailed product information, the location of the nearest Whirlpool dealer or authorized servicer, to purchase an accessory item, or register your appliance on-line, please visit our Web site at www.whirlpool.com

In Canada, for assistance or service, see the "Requesting Assistance or Service" section.

In Canada, visit our Web site at www.whirlpool.com/canada

WASHER SAFETY

Your safety and the safety of others is very important.

We have provided many important safety messages in this manual and on your appliance. Always read and obey all safety messages.



This is the safety alert symbol.

This symbol alerts you to hazards that can kill or hurt you and others.

All safety messages will be preceded by the safety alert symbol and the word "DANGER" or "WARNING." These words mean:

⚠ DANGER

You will be killed or seriously injured if you don't follow instructions.

⚠ WARNING

You can be killed or seriously injured if you don't follow instructions.

All safety messages will identify the hazard, tell you how to reduce the chance of injury, and tell you what can happen if the instructions are not followed.

IMPORTANT SAFETY INSTRUCTIONS

WARNING – To reduce the risk of fire, electric shock, or injury to persons when using the washer, follow basic precautions, including the following:

- Read all instructions before using the washer.
- Do not wash articles that have been previously cleaned in, washed in, soaked in, or spotted with gasoline, dry-cleaning solvents, other flammable, or explosive substances as they give off vapors that could ignite or explode.
- Do not add gasoline, dry-cleaning solvents, or other flammable, or explosive substances to the wash water. These substances give off vapors that could ignite or explode.
- Under certain conditions, hydrogen gas may be produced in a hot water system that has not been used for 2 weeks or more. **HYDROGEN GAS IS EXPLOSIVE.** If the hot water system has not been used for such a period, before using the washing machine, turn on all hot water faucets and let the water flow from each for several minutes. This will release any accumulated hydrogen gas. As the gas is flammable, do not smoke or use an open flame during this time.
- Do not allow children to play on or in the washer. Close supervision of children is necessary when the washer is used near children.
- Before the washer is removed from service or discarded, remove the door.
- Do not reach into the washer if the tub or agitator is moving.
- Do not install or store the washer where it will be exposed to the weather.
- Do not tamper with controls.
- Do not repair or replace any part of the washer or attempt any servicing unless specifically recommended in this Use and Care Guide or in published user-repair instructions that you understand and have the skills to carry out.
- See Installation Instructions for grounding requirements.

– SAVE THESE INSTRUCTIONS –

PARTS AND FEATURES

The parts and features of your washer are illustrated on this page. Become familiar with all parts and features before using your washer. Page references are included next to some features. Refer to those pages for more information about the features.

NOTE: The drawings in this book may vary from your washer model. They are designed to show the different features of all models covered by this book. Your model may not include all features.

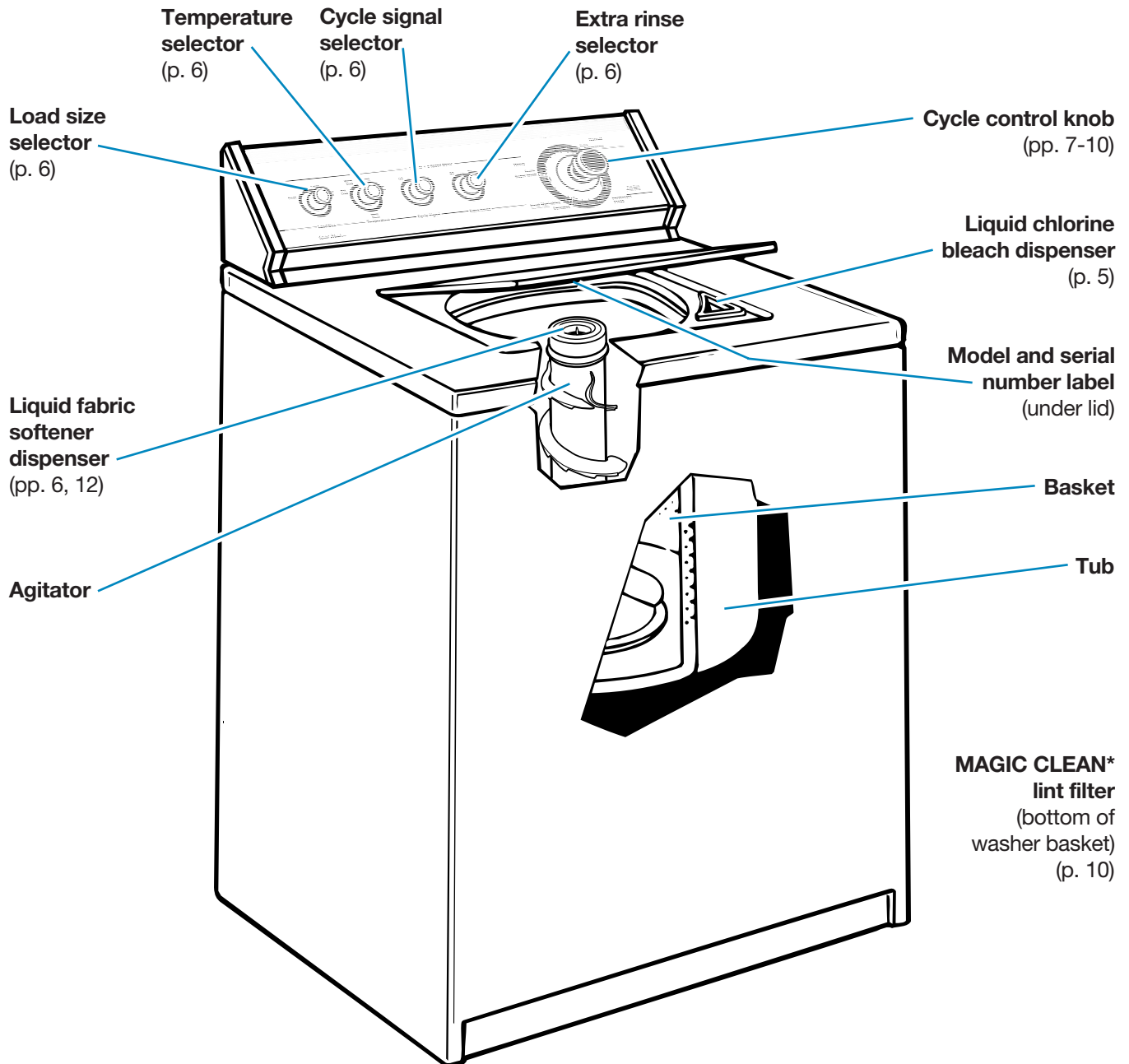

OPERATING YOUR WASHER

To get the best washing results possible, you must use your washer correctly. This section tells you how to use your washer properly and efficiently.

USING YOUR WASHER

⚠ WARNING



Explosion Hazard

Never place items in the washer that are dampened with gasoline or other flammable fluids.

No washer can completely remove oil.

Do not dry anything that has ever had any type of oil on it (including cooking oils).

Doing so can result in death, explosion, or fire.

⚠ WARNING



Electrical Shock Hazard

Plug into a grounded 3 prong outlet.

Do not remove ground prong.

Do not use an adapter.

Do not use an extension cord.

Failure to follow these instructions can result in death, fire, or electrical shock.

1. Measure detergent and pour it into the washer.

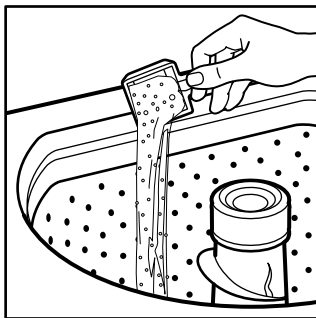

- If desired, you may also add powder or liquid color-safe bleach.
- Add extra detergent for the Super Wash cycle.

2. Drop a sorted load of clothes loosely into your washer, filling to the top row of holes.

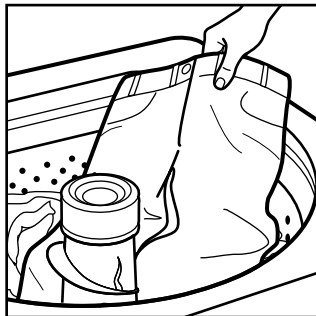

- Load evenly to maintain washer balance. Mix large and small items.
- Items should move easily through the wash water. Overloading can cause poor cleaning.
- To reduce wrinkling

of permanent press clothes and some synthetic knits, use a large load size to provide more space (see step 6).

3. (OPTIONAL STEP) Pour measured liquid chlorine bleach into the liquid chlorine bleach dispenser.

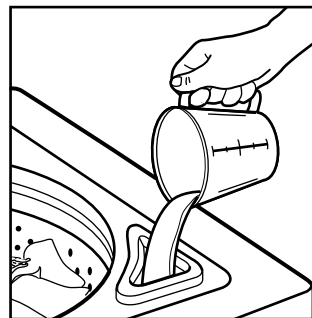

bleach into the liquid chlorine bleach dispenser. Bleach will be diluted automatically during the wash part of the cycle.

- Never use more than 1 cup (250 mL) for a full load. Use less with a smaller load size.
- Follow the manufacturer's directions for safe use.
- To avoid spilling, use a cup with a pouring spout. Do not let bleach splash, drip, or run down into the washer basket.
- Make sure you use only liquid chlorine bleach in this dispenser.

continued on next page

USING YOUR WASHER (CONT.)

- 4. (OPTIONAL STEP)** Pour measured **liquid fabric softener** into the fabric softener dispenser.

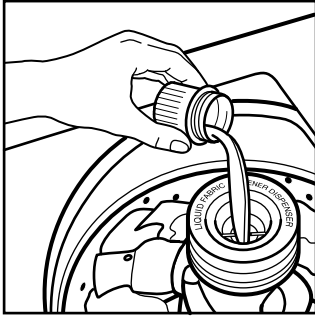

- Do not spill or drip any fabric softener on the clothes.
- Make sure you use only liquid fabric softener in this dispenser.

- Dilute liquid fabric softener by filling the dispenser with warm water until liquid reaches the crossbar in the opening.
- Softener is added automatically during the rinse portion of the cycle.

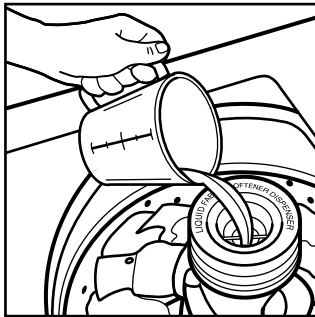

- 5.** Close the washer lid.

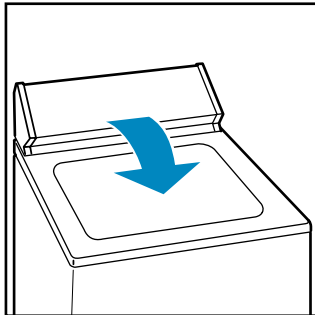

- 6.** Turn the Load Size selector to the correct setting for your wash load and the type of fabric being washed.

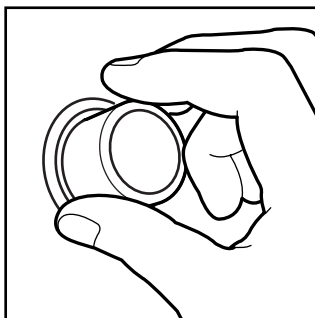

- Your washer has five load size settings.
- Choose a load size that allows the load to move freely for best fabric care. See "Loading" later in this section.

- Change the setting after the washer has started filling by turning the selector to a different setting.

- 7.** Set the Water Temperature selector to the correct setting for the type of fabric and soils being washed.

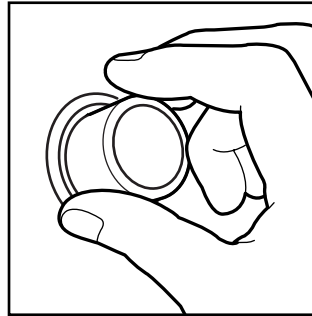

- Use the warmest water safe for fabric.

- Follow garment label instructions.

HOT: 130°F (54°C) or above.

- Whites and pastels.
- Heavy and greasy soils.

WARM: 90 to 110°F (32 to 44°C).

- Bright colors.
- Moderate to light soils.

COLD: 70 to 90°F (21 to 32°C).

- Colors that bleed or fade.
- Light soils.

- 8. (OPTIONAL STEP)** For an additional rinse and spin at the end of a wash cycle, set the Extra Rinse selector to On.

- 9. (OPTIONAL STEP)** Set the Cycle Signal selector to On if you want your washer to sound a signal when the wash cycle is finished. This signal is helpful when you are washing items that should be removed from the washer as soon as the cycle ends.

USING YOUR WASHER (CONT.)

- 10.** Push in the Cycle Control knob and turn it to the wash cycle you want. See “Cycle descriptions” later in this section.
- Reduce the wash time when using a small load size setting.

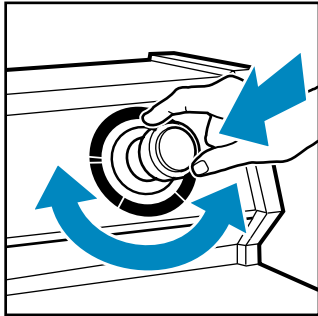

- 11.** Pull out the Cycle Control knob to start the washer.

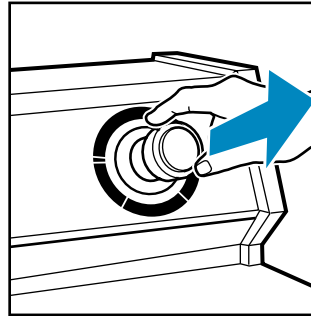

NOTE: To **stop** the washer at any time, push in the Cycle Control knob. To **restart** the washer, close the lid (if open) and pull out the Cycle Control knob.

LOADING

Loading suggestions

For these suggested full-sized loads, set the Load Size selector to the highest load size setting.

SUPER CAPACITY PLUS WASHERS			
Heavy Work Clothes 3 pair pants 3 shirts 4 pair jeans 1 coverall 1 overall	Delicates 3 camisoles 1 quilted robe 4 slips 4 panties 2 bras 2 nighties 1 baby's dress	Towels 10 bath towels 10 hand towels 14 wash cloths 1 bath mat	Mixed Load 3 double sheets 4 pillowcases 8 T-shirts 6 pair shorts 2 shirts 2 blouses 8 handkerchiefs

SELECTING A CYCLE AND TIME

This section describes the available wash cycles and will help you make the best cycle selections for your wash loads. Each cycle is designed for different types of fabric and soil levels.

- The washer pauses briefly throughout each cycle. These pauses are normal. Refer to “Understanding normal washer sounds” to learn more about the sounds you may hear during a wash cycle.
- Refer to “Understanding what happens in each cycle” later in this section to learn what happens during a wash cycle.

CYCLE DESCRIPTIONS

(Models GSQ9300, GSQ9340, GSQ9344, GST9344)

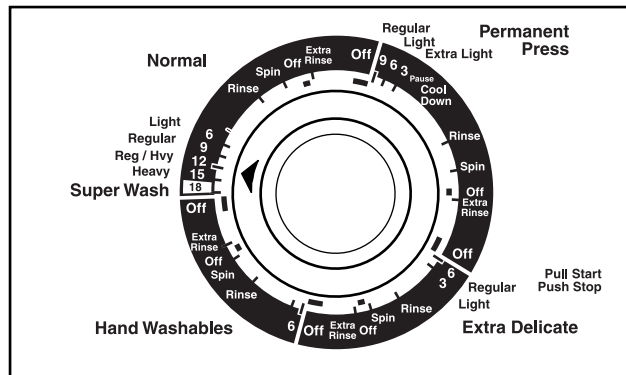

Cycles may vary with model

Normal cycle

The Normal cycle features high-speed agitation for cleaning cottons and linens. High spin speeds shorten drying times. Select 9 (Regular), 12 (Reg/Hvy)[†], or 15 (Heavy) minutes of wash time, depending on whether your load is moderately or heavily soiled. For lightly soiled cotton and linen fabrics, use the 6-minute Light setting.

Super Wash – Select the 18-minute Super Wash feature to wash heavily soiled loads that need maximum soil removal. Use two times the amount of recommended detergent for this cycle.

Permanent Press cycle

The Permanent Press cycle starts with high-speed agitation and then steps down to low-speed agitation for cleaning permanent press blends and synthetic fabrics. To minimize wrinkling, this cycle features a cool-down rinse and a low-speed final spin. Select 3 (Extra Light)[†], 6 (Light) or 9 (Regular) minutes to clean very light to moderately soiled loads.

Extra Delicate cycle

The Extra Delicate cycle features an extra low-speed agitation for gentle soil removal from delicate items and washable knits. Low spin speeds minimize wrinkling. Select 3 (Light)[†] or 6 (Regular) minutes to clean light to moderately soiled loads.

[†]On some models

Ultimate Care* cycle (Hand Washables)

The Ultimate Care (Hand Washables) cycle features a series of brief, extra low-speed agitations (7 seconds) and short soaks (12 seconds) to gently clean special-care items. Low spin speeds minimize wrinkling. Use 6 minutes of wash time to clean lightly soiled hand washables.

Garments are labeled “Hand Wash” because:

- The fiber or construction may be sensitive to agitation.
- The fabric contains sensitive dyes that may bleed. Properly sort and then use your Hand Washables cycle for gentle washing. Follow care label directions for drying. Items that may shrink should be dried flat. Block these items by gently stretching to original measurements. Woolens tend to shrink more the first time they are washed.
- If items appear to be floating due to trapped air, stop the washer by pushing in the Cycle Control knob. Push items down into the water. Restart the washer.

CYCLE DESCRIPTIONS

(Model LSR8300)

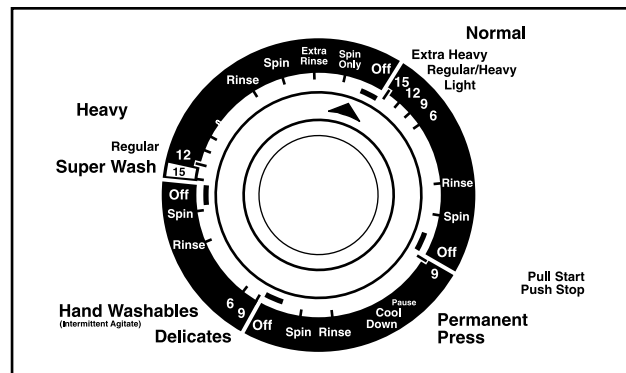

Normal cycle

The Normal cycle features extended high-speed agitation followed by a brief period of low-speed agitation for cleaning cottons and linens. High spin speeds shorten drying times. Select 9 (Light), 12 (Regular/Heavy), or 15 (Extra Heavy) minutes of wash time, depending on whether your load is moderately or heavily soiled. For lightly soiled cotton and linen fabrics, use the 6-minute setting.

Heavy cycle

Super Wash – Select the 15-minute Super Wash feature to wash heavily soiled loads that need maximum soil removal. Use two times the amount of recommended detergent for this cycle.

Permanent Press cycle

The Permanent Press cycle starts with high-speed agitation and then steps down to low-speed agitation for cleaning permanent press blends and synthetic fabrics. To minimize wrinkling, this cycle features a cool-down rinse and a low-speed final spin.

Delicate cycle

The Delicate cycle features an extra low-speed agitation and then steps to a series of brief, extra low-speed agitations (7 seconds) and short soaks (12 seconds) for gentle soil removal from delicate items and washable knits. Low spin speeds minimize wrinkling. Select this 9-minute cycle to clean light to moderately soiled loads.

Ultimate Care* cycle (Hand Washables)

The Ultimate Care (Hand Washables) cycle features a series of brief, extra low-speed agitations (7 seconds) and short soaks (12 seconds) to gently clean special-care items. Low spin speeds minimize wrinkling. Use 6 minutes of wash time to clean lightly soiled hand washables.

Garments are labeled “Hand Wash” because:

- The fiber or construction may be sensitive to agitation.
- The fabric contains sensitive dyes that may bleed. Properly sort and then use your Hand Washables cycle for gentle washing. Follow care label directions for drying. Items that may shrink should be dried flat. Block these items by gently stretching to original measurements. Woolens tend to shrink more the first time they are washed.
- If items appear to be floating due to trapped air, stop the washer by pushing in the Cycle Control knob. Push items down into the water. Restart the washer.

RINSE/DRAIN AND SPIN

Rinse and Spin feature

When using extra detergent for heavily soiled clothes, or washing special-care items, you may find an extra rinse and spin is needed.

- For an additional rinse and spin, push in the Cycle Control knob and turn it clockwise to any of the Rinse settings. The washer fills to the selected load size, agitates, drains, and spins.

NOTE: An Extra Rinse option is also available. See “Using your washer” earlier in this section.

Drain and Spin feature

A drain and spin may help shorten drying times for some heavy fabrics or special-care items by removing excess water.

- For a drain and spin, push in the Cycle Control knob and turn it clockwise to any of the Spin settings. Then pull out the Cycle Control knob. The washer drains, then spins.

MAGIC CLEAN* LINT FILTER

Your washer has a self-cleaning lint filter at the bottom of the basket. Wash and rinse water flow over the filter during agitation, separating the lint from the water. The lint spins out of the system during the spin part of the cycle.

If your washer drains into a tub, remove any lint collected in the tub or strainer.

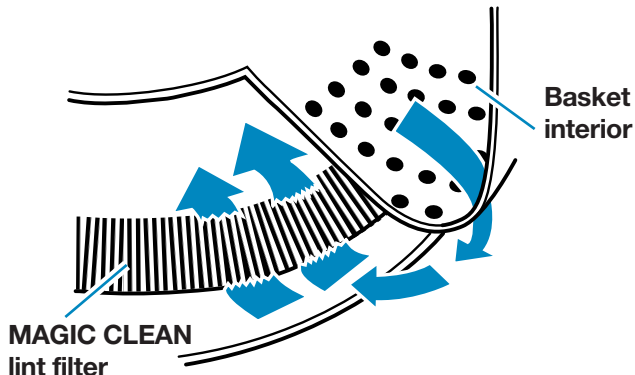

UNDERSTANDING NORMAL WASHER SOUNDS

Your new washer may make sounds your old one didn't. Because the sounds may be unfamiliar, you may be concerned about them. Don't be; most of them are normal.

The following describes some of the sounds you may hear and what causes them.

During washing

When you select a small load size setting, your washer has a lower water level. This may cause a clicking sound from the upper part of the agitator.

During drain

If water is drained quickly from your washer (depending on your installation), you may hear air being pulled through the pump during the end of draining.

After drain and before spin

When the cycle changes from draining to spinning, you may hear gears engaging.

UNDERSTANDING WHAT HAPPENS IN EACH CYCLE

When the Cycle Control knob is set to a number and pulled out, the washer fills (to the selected load size) before agitation and timing start. The washer begins agitating immediately after filling; agitation occurs with the washer lid up or down.



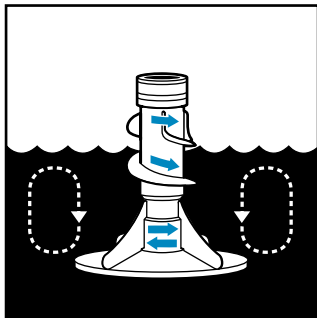

During agitation, the XTRA ROLL ACTION* agitator creates a continuous rollover action that provides a thorough cleaning of the wash load.









After agitation starts, the Cycle Control knob turns clockwise until it points to an Off area and the cycle ends.

NOTE: The washer pauses briefly throughout each cycle. These pauses are normal for washer operation.

Sequence of cycles

WASH	
	Fill
	Wash selected time
	Drain† No agitation
	Spin
† The Permanent Press cycle partially drains, fills, agitates briefly, and drains.	

RINSE	
	Fill
	Rinse
	Drain-No agitation
	Spin-Spray rinse
	Spin
	Off

CARING FOR YOUR WASHER

Proper care of your washer can extend its life. This section explains how to care for your washer properly and safely.

CLEANING YOUR WASHER

Cleaning the exterior



Use a soft, damp cloth or sponge to wipe up any spills such as detergent or bleach. Occasionally wipe the outside of your washer to keep it looking new.

Cleaning the interior

Clean your washer interior by mixing 1 cup (250 mL) of chlorine bleach and 2 cups (500 mL) of detergent. Pour this into your washer and run it through a complete cycle using hot water. Repeat this process if necessary.

NOTE: Remove any hard water deposits using only cleaners labeled as washer safe.

Cleaning the liquid fabric softener dispenser

Flush dispenser periodically with warm water, as shown. Remove the dispenser by grasping the top of the dispenser with both hands and squeezing and pushing upwards with thumbs. Clean the dispenser by rinsing it under a water faucet. Replace it after cleaning.

NOTE: Do not wash clothes with this dispenser removed. Do not add detergent or bleach to this dispenser; it is for liquid fabric softener use only.

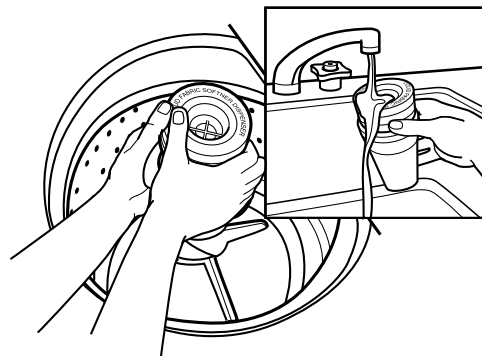

WINTER STORAGE, MOVING, VACATION CARE

Install and store your washer where it will not freeze. Because some water may stay in the hoses, freezing can damage your washer. If storing or moving your washer during freezing weather, winterize it.

To winterize washer:

1. Shut off both water faucets.
2. Disconnect and drain water inlet hoses.
3. Put 1 quart (1 L) of R.V.-type antifreeze in the basket.
4. Run washer on a drain and spin setting (see "Drain and spin feature" earlier in this section) for about 30 seconds to mix the antifreeze and water.
5. Unplug washer or disconnect power.

To use washer again:

1. Flush water pipes and hoses.
2. Reconnect water inlet hoses.
3. Turn on both water faucets.
4. Plug in washer or reconnect power.
5. Run the washer through a complete cycle with 1 cup (250 mL) of detergent to clean out antifreeze.

Non-use or vacation care:

Operate your washer only when you are at home. If you will be on vacation or not using your washer for an extended period of time, you should:

- Unplug the power supply cord or turn off electrical power to the washer.
- Turn off the water supply to the washer. This helps avoid accidental flooding (due to a water pressure surge) while you are away.

INLET HOSES

Replace inlet hoses after 5 years of use to reduce the risk of hose failure. Inspect and replace inlet hoses if bulges, kinks, cuts, wear, or leaks are found.

When replacing your inlet hoses, mark the date of replacement on the label with a permanent marker.

TROUBLESHOOTING

Most laundering problems are easily solved if you understand the cause. Check the following list for **common washing problems**. If you need further assistance, see the “Requesting Assistance or Service” section.

COMMON WASHING PROBLEMS

Problem ...	Cause ...	Solution ...
Washer leaks NOTE: After checking these, check household plumbing.	<ul style="list-style-type: none"> ● Fill hoses not tight. ● Fill hose washers not properly seated. ● Drain hose clamp not properly installed or is off. ● Drain is clogged. ● Tub moved forward during unloading, causing water to deflect off of tub ring. ● Unit not level, causing water to deflect off of tub ring. ● Fill or spray rinses are deflecting off of load. Washer is overloaded or load is unbalanced. 	<ul style="list-style-type: none"> ● Tighten hoses. See Installation Instructions. ● Reseat (reposition) washers. See Installation Instructions. ● Clamp drain hose. ● Unclog drain. Sink and standpipe must be able to handle 17 gallons (64.6 L) of water per minute. ● Ensure tub is centered before starting washer. ● Ensure front feet are installed and nuts are tightened. Level washer. ● Redistribute the load, or reduce load size.
Washer won't drain/spin	<ul style="list-style-type: none"> ● Drain hose is clogged. ● Lid is open. ● End of drain hose more than 72 inches (190.9 cm) above floor. ● Too much detergent – excessive sudsing. ● Low voltage or using an extension cord. 	<ul style="list-style-type: none"> ● Unclog hose. See Installation Instructions for proper installation of drain hose. ● Close the lid. ● Lower drain hose. ● Use less detergent. ● Check electrical source or call electrician. Do not use extension cords.
Wet loads	<ul style="list-style-type: none"> ● Wrong cycle for load being washed. ● Cold rinses. 	<ul style="list-style-type: none"> ● Choose a cycle with a higher spin speed. ● Cold rinses leave loads wetter than warm rinses. This is normal.
Washer continues to fill/drain or cycle stuck NOTE: Washer pauses briefly throughout each cycle. This is normal.	<ul style="list-style-type: none"> ● Top of drain hose is lower than water level in washer. ● Drain hose fits too tightly into standpipe. ● Drain hose taped into standpipe. 	<ul style="list-style-type: none"> ● Raise the drain hose. It must be higher for proper operation. ● Adjust drain hose for loose yet secure fit. See Installation Instructions. ● Do not seal off drain hose with tape. The hose needs an air gap.
Washer makes noise	<ul style="list-style-type: none"> ● Load is unbalanced. ● Washer is not level. ● Nuts on front feet not tight. ● Yellow shipping strap with cotter pins not completely removed. 	<ul style="list-style-type: none"> ● Redistribute load. ● Level washer. Reset rear leveling legs. See Installation Instructions. ● Tighten nuts. ● See Installation Instructions.

continued on next page 13

COMMON WASHING PROBLEMS (CONT.)

Problem ...	Cause ...	Solution ...
Washer makes noise (cont.)	<ul style="list-style-type: none"> ● Gears engaging after drain and before spin. ● Upper part of agitator clicks during wash. 	<ul style="list-style-type: none"> ● This is normal. ● This is normal.
Won't fill/rinse/agitate or wrong temperature	<ul style="list-style-type: none"> ● Power cord not plugged in. ● Timer dial is not lined up. ● Water inlet valve screens are plugged. ● Water is turned off. ● Hot and cold hoses are reversed. ● Inlet hose is kinked. 	<ul style="list-style-type: none"> ● Plug in power cord. ● Turn timer knob to the right slightly and pull to start. ● Clean screens. ● Turn on water. ● Reverse hoses. ● Straighten hoses.
Washer stops	<ul style="list-style-type: none"> ● Power cord not plugged in. ● No power at plug. ● Fuse blown or circuit breaker open. ● Using an extension cord. ● Timer dial is not lined up. ● Timer knob not pulled out. ● Washer at pause in Permanent Press cycle (approximately 2 minutes). ● Machine is overloaded. 	<ul style="list-style-type: none"> ● Plug in power cord. ● Check electrical source or call electrician. ● Replace fuse or reset circuit breaker. If problem continues, call electrician. ● Do not use extension cords. ● Turn timer to the right slightly and pull to start. ● Set and pull out knob. ● Allow cycle to continue. ● Wash smaller loads.
Agitator operation	<ul style="list-style-type: none"> ● The top of the agitator moves only in one direction. ● The top of the agitator is loose. 	<ul style="list-style-type: none"> ● This is normal. ● This is normal.
Water level seems too low or washer not completely filling	<ul style="list-style-type: none"> ● The top of the agitator is much higher than the highest water level. This creates a perception of the washer not being full. 	<ul style="list-style-type: none"> ● This is normal.
Washer tub is crooked	<ul style="list-style-type: none"> ● Tub is pulled forward when unloading. ● Tub moves. ● Unit not level. 	<ul style="list-style-type: none"> ● Push tub to center before starting. ● This is normal. ● Ensure front feet are installed and nuts tightened. Level washer. Reset rear leveling legs. See Installation Instructions.

COMMON WASHING PROBLEMS (CONT.)

Problem ...	Cause ...	Solution ...
Residue or lint on load	<ul style="list-style-type: none"> ● Improper sorting. ● Overloading. ● Paper or tissue in pockets. ● Not enough detergent. ● Detergent not dissolving. ● Wash water colder than 70°F (21°C). 	<ul style="list-style-type: none"> ● Sort lint givers (towels, chenille) from lint takers (corduroy, synthetics). Also sort by color. ● Lint can be trapped in load if overloaded. Wash smaller loads. ● Clean out pockets before washing. ● Use enough detergent to hold lint in water. ● Use wash water warmer than 70°F (21°C). ● Use wash water warmer than 70°F (21°C).
Tearing	<ul style="list-style-type: none"> ● Overloading. Improper use of washer. ● Improper use of chlorine bleach. ● Sharp items not removed from pockets; fasteners not fastened. ● Items damaged before washing. 	<ul style="list-style-type: none"> ● Loads should move freely during wash. Wash smaller loads. ● Do not pour chlorine bleach directly on load. Wipe up bleach spills. Undiluted bleach will damage fabrics. ● Clean out pockets before washing. Zip zippers before washing. ● Mend rips and broken threads in seams before washing.
Stains on load	<ul style="list-style-type: none"> ● Improper use of fabric softener. ● Iron (rust) in water. ● Not enough detergent used, causing soil to be redeposited. ● Dye transfer due to not sorting loads properly. ● Dye transfer due to not unloading washer promptly. 	<ul style="list-style-type: none"> ● Dilute fabric softener and add to rinse portion of cycle only. Do not drip fabric softener on clothes. ● Install an iron filter. ● Use enough detergent to remove soil and hold it in suspension. ● Sort dark clothing from whites and lights. ● Unload the washer as soon as it stops.
Load is wrinkled	<ul style="list-style-type: none"> ● Not removing load promptly. ● Wrong cycle for fabrics being washed. ● Overloading. ● Wash water not warm enough to relax wrinkles. Using warm rinses. ● Hoses reversed. 	<ul style="list-style-type: none"> ● Unload the washer as soon as it stops. ● Use the Permanent Press cycle or another cycle with low spin speeds to reduce wrinkling. ● Loads should move freely during wash. Wash smaller loads. ● If safe for fabric, use warm or hot wash water. Use cold rinse water. ● Reverse hoses.

continued on next page

COMMON WASHING PROBLEMS (CONT.)

Problem ...	Cause ...	Solution ...
Load is tangled/ twisted	<ul style="list-style-type: none"> ● Overloading. ● Clothes wrapped around agitator. 	<ul style="list-style-type: none"> ● Loads should move freely during wash. Wash smaller loads. ● Do not wrap items around agitator.
Clogged dispensers or bleach leaking	<ul style="list-style-type: none"> ● Not diluting softener. ● Use of color-safe bleach in chlorine bleach dispenser. ● Improper use of chlorine bleach. 	<ul style="list-style-type: none"> ● Dilute fabric softener in the dispenser. ● Add powder or liquid color-safe bleach directly to the basket. Do not use chlorine bleach dispenser for color-safe bleach. ● Always measure bleach before adding to the dispenser. Carefully pour into the dispenser. Wipe up bleach spills.
Gray whites, dingy colors	<ul style="list-style-type: none"> ● Dye transfer. ● Wash temperature too low. ● Not enough detergent. ● Hard water. 	<ul style="list-style-type: none"> ● Sort dark clothes from whites and lights. ● Use hot or warm washes if safe for fabric. Hot water should be at least 130°F (54°C) to clean heavy or greasy soils. ● Use more detergent for washing heavy soils in cold or hard water. ● Use more detergent when washing in hard water.

REQUESTING ASSISTANCE OR SERVICE

To avoid unnecessary service calls, please check the “Troubleshooting” section. It may save you the cost of a service call. If you still need help, follow the instructions below.

IF YOU NEED ASSISTANCE OR SERVICE IN THE U.S.A.

Call the Whirlpool Consumer Assistance Center toll free at 1-800-253-1301. Our consultants are available to assist you.



When calling:

Please know the purchase date, and the complete model and serial number of your appliance (see “A Note to You”). This information will help us better respond to your request.

Our consultants provide assistance with:

- Features and specifications on our full line of appliances
- Installation information
- Use and maintenance procedures

- Accessory and repair parts sales
- Specialized customer assistance (Spanish speaking, hearing impaired, limited vision, etc.)
- Referrals to local dealers, service companies, and repair parts distributors.

Whirlpool service technicians are trained to fulfill the product warranty and provide after-warranty service, anywhere in the United States.

To locate the authorized Whirlpool service company in your area, you can also look in your telephone directory Yellow Pages.

IF YOU NEED REPLACEMENT PARTS

If you need to order replacement parts, we recommend that you only use FSP* factory authorized parts. FSP replacement parts will fit right and work right, because they are made to the same exacting specifications used to build every new WHIRLPOOL* appliance.

To locate FSP replacement parts in your area, call our Consumer Assistance Center telephone number or your nearest authorized service center.

FOR FURTHER ASSISTANCE

If you need further assistance, you can write to Whirlpool with any questions or concerns at:

Whirlpool Brand Home Appliances
Consumer Assistance Center
c/o Correspondence Dept.
2000 North M-63
Benton Harbor, MI 49022-2692

Please include a daytime phone number in your correspondence.

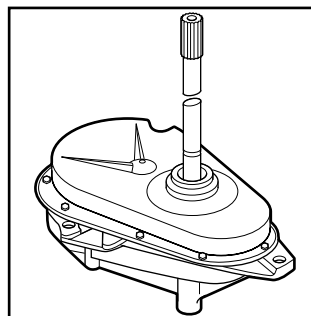

Gearcase assembly covered by your warranty.

IF YOU NEED ASSISTANCE OR SERVICE IN CANADA

1. If the problem is not due to one of the items listed in "Troubleshooting"†...

Contact the dealer from whom you purchased your appliance, or call the Inglis Limited Consumer Assistance Centre toll free, **8:30 a.m. – 6 p.m. (EST)**, at **1-800-461-5681**.



2. If you need service†...

Contact your nearest Inglis Limited Appliance Service branch or authorized servicing outlet to service your appliance. (See list below.)

† When asking for assistance or service, please provide a detailed description of the problem, your appliance's complete model and serial numbers, and the purchase date. (See the "A Note to You" section.) This information will help us respond properly to your request.

Inglis Limited Appliance Service – Consumer Services

Direct service branches:

BRITISH COLUMBIA		1-800-665-6788
ALBERTA		1-800-661-6291
ONTARIO (except 807 area code)	Ottawa area Outside the Ottawa area	1-800-267-3456 1-800-807-6777
MANITOBA, SASKATCHEWAN and 807 area code in ONTARIO		1-800-665-1683
QUEBEC	Montreal (except South Shore) South Shore Montreal Quebec City Sherbrooke	1-800-361-3032 1-800-361-0950 1-800-463-1523 1-800-567-6966
ATLANTIC PROVINCES		1-800-565-1598

FOR FURTHER ASSISTANCE

If you need further assistance, you can write to Inglis Limited with any questions or concerns at:

Consumer Relations Department
Inglis Limited
1901 Minnesota Court
Mississauga, Ontario L5N 3A7

Please include a daytime phone number in your correspondence.

INDEX

This index is alphabetical. Look for the word or phrase you are interested in, then look for the page number.

TOPIC	PAGE	TOPIC	PAGE
ASSISTANCE	17-18	PARTS/FEATURES	4
CLEANING		RINSE/DRAIN AND SPIN	10
Exterior	12	SAFETY	3
Interior	12	SERVICE	17-18
Liquid fabric softener dispenser	12	SOUNDS	10
CYCLES	8-10, 11	STORAGE	12
CYCLE SIGNAL	6	TROUBLESHOOTING	13-16
DISPENSERS		WARRANTY	20
Liquid chlorine bleach	5	WASHER OPERATION	
Liquid fabric softener	6	Selecting a cycle and time	7-10
EXTRA RINSE	6	Selecting a load size	6
FEATURES/PARTS	4	Selecting a temperature	6
INLET HOSES	12	Stopping/restarting	7
LINT FILTER	10	Using the dispensers	5, 6
LOADING	7	Using your washer	5-7
OPERATING	5-11		

WHIRLPOOL*

AUTOMATIC WASHER WARRANTY (U.S.A. AND CANADA)

LENGTH OF WARRANTY	WHIRLPOOL WILL PAY FOR
FULL ONE-YEAR WARRANTY FROM DATE OF PURCHASE	FSP* replacement parts and repair labor to correct defects in materials or workmanship. Service must be provided by an authorized Whirlpool service company.
LIMITED FIVE-YEAR WARRANTY FROM DATE OF PURCHASE	FSP replacement parts for any part of gearcase assembly if defective in materials or workmanship. The gearcase assembly is shown in the "Requesting Assistance or Service" section of this book. FSP replacement parts for any top and lid rust.
LIMITED TEN-YEAR WARRANTY FROM DATE OF PURCHASE	FSP replacement parts for outer tub should it crack, or fail to contain water, due to defective materials or workmanship.
WHIRLPOOL WILL NOT PAY FOR	
<p>A. Service calls to:</p> <ol style="list-style-type: none"> 1. Correct the installation of your washer. 2. Instruct you how to use your washer. 3. Replace house fuses or correct house wiring or plumbing. <p>B. Repairs when your washer is used in other than normal, single-family household use.</p> <p>C. Pickup and delivery. Your washer is designed to be repaired in the home.</p> <p>D. Damage to your washer caused by accident, misuse, fire, flood, acts of God, or use of products not approved by Whirlpool.</p> <p>E. Any labor costs during the limited warranties.</p> <p>F. Replacement parts or repair labor costs for units operated outside the United States and Canada.</p> <p>G. Repairs to parts or systems resulting from unauthorized modifications made to the appliance.</p>	

1/98

WHIRLPOOL CORPORATION SHALL NOT BE LIABLE FOR INCIDENTAL OR CONSEQUENTIAL DAMAGES.

Some states and provinces do not allow the exclusion or limitation of incidental or consequential damages, so this exclusion or limitation may not apply to you. This warranty gives you specific legal rights, and you may also have other rights which vary from state to state or province to province.

Outside the United States and Canada, a different warranty may apply. For details, please contact your authorized Whirlpool dealer.

If you need assistance or service, first see the "Troubleshooting" section of this book. After checking "Troubleshooting," additional help can be found by checking the "Requesting Assistance or Service" section. In the U.S.A., call our Consumer Assistance Center at **1-800-253-1301**.

For information in Canada:

Please contact your authorized Whirlpool dealer or call the Consumer Assistance Centre at 1-800-461-5681 (toll free) between 8:30 a.m. and 6 p.m. EST from anywhere in Canada.

For assistance or service in Canada:

If you need assistance or service in Canada, first see the "Troubleshooting" section of this book. After checking "Troubleshooting," additional help can be found by checking the "Requesting Assistance or Service" section.

Free Manuals Download Website

<http://myh66.com>

<http://usermanuals.us>

<http://www.somanuals.com>

<http://www.4manuals.cc>

<http://www.manual-lib.com>

<http://www.404manual.com>

<http://www.luxmanual.com>

<http://aubethermostatmanual.com>

Golf course search by state

<http://golfingnear.com>

Email search by domain

<http://emailbydomain.com>

Auto manuals search

<http://auto.somanuals.com>

TV manuals search

<http://tv.somanuals.com>