



TWO SPEED AUTOMATIC WASHER

Use & Care Guide

两速自动洗衣机 用户使用手册

Table of Contents / 目录.....	2
-----------------------------	---

W10096630

TABLE OF CONTENTS

WASHER SAFETY	3	Drain and Spin.....	8
PARTS AND FEATURES	4	Adding Liquid Chlorine Bleach	8
WASHER USE	5	Adding Liquid Fabric Softener	8
Understanding Washer Cycles	5	WASHER CARE	9
Loading.....	5	Cleaning Your Washer	9
Normal Sounds	5	Water Inlet Hoses.....	9
Starting Your Washer.....	6	Vacation, Storage and Moving Care.....	9
Washer Symbols	7	TROUBLESHOOTING	10
Selecting a Cycle and Time	8	ASSISTANCE OR SERVICE	12
Rinse and Spin	8	WHIRLPOOL® WASHER	12

目录

洗衣机安全说明	14	排水和脱水	19
部件和特征	15	加入液态氯漂白剂	19
洗衣机的使用	16	加入液体柔顺剂.....	19
了解洗衣循环过程	16	洗衣机的维护	20
装载衣物.....	16	清洁您的洗衣机	20
正常的声音	16	进水	20
开始使用您的洗衣机	17	度假、储存和搬运护理.....	20
洗衣机符号	18	故障解决	21
选择一种循环和时间	19	帮助或服务	23
漂洗和脱水	19	WHIRLPOOL® WASHER (惠而浦洗衣机)	23

WASHER SAFETY

Your safety and the safety of others are very important.

We have provided many important safety messages in this manual and on your appliance. Always read and obey all safety messages.



This is the safety alert symbol.

This symbol alerts you to potential hazards that can kill or hurt you and others.

All safety messages will follow the safety alert symbol and either the word "DANGER" or "WARNING." These words mean:

⚠ DANGER

You can be killed or seriously injured if you don't immediately follow instructions.

⚠ WARNING

You can be killed or seriously injured if you don't follow instructions.

All safety messages will tell you what the potential hazard is, tell you how to reduce the chance of injury, and tell you what can happen if the instructions are not followed.

IMPORTANT SAFETY INSTRUCTIONS

WARNING: To reduce the risk of fire, electric shock, or injury to persons when using the washer, follow basic precautions, including the following:

- Read all instructions before using the washer.
- Do not wash articles that have been previously cleaned in, washed in, soaked in, or spotted with petrol, dry-cleaning solvents, other flammable or explosive substances as they give off vapours that could ignite or explode.
- Do not add petrol, dry-cleaning solvents, or other flammable, or explosive substances to the wash water. These substances give off vapours that could ignite or explode.
- Under certain conditions, hydrogen gas may be produced in a hot water system that has not been used for 2 weeks or more. **HYDROGEN GAS IS EXPLOSIVE.** If the hot water system has not been used for such a period, before using the washing machine, turn on all hot water taps and let the water flow from each for several minutes. This will release any accumulated hydrogen gas. As the gas is flammable, do not smoke or use an open flame during this time.
- Do not allow children to play on or in the washer. Close supervision of children is necessary when the washer is used near children.
- The appliance is not intended for use by young children or infirm persons without supervision.
- Before the washer is removed from service or discarded, remove the door or lid.
- Do not reach into the washer if the drum, tub or agitator is moving.
- Do not install or store the washer where it will be exposed to the weather.
- Do not tamper with controls.
- Do not repair or replace any part of the washer or attempt any servicing unless specifically recommended in this Use and Care Guide or in published user-repair instructions that you understand and have the skills to carry out.
- See Installation Instructions for earthing requirements.
- If the supply cord is damaged, it must be replaced by the manufacturer or its service agent or a similarly qualified person in order to avoid a hazard.

SAVE THESE INSTRUCTIONS

PARTS AND FEATURES

This manual covers several different models. The washer you have purchased may have some or all of the parts and features listed below.

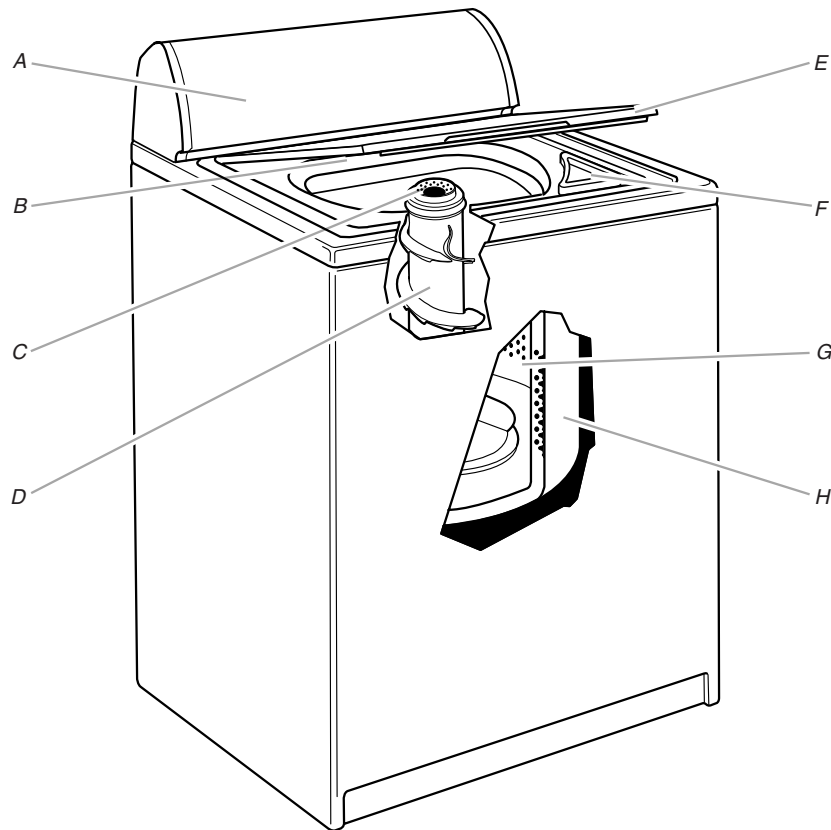

A. Control panel
 B. Model and serial number label
 C. Liquid fabric softener dispenser
 D. Agitator

E. Lid
 F. Liquid chlorine bleach dispenser
 G. Basket
 H. Tub

Other features your washer may have

- Agitator
- White porcelain basket

Control panel

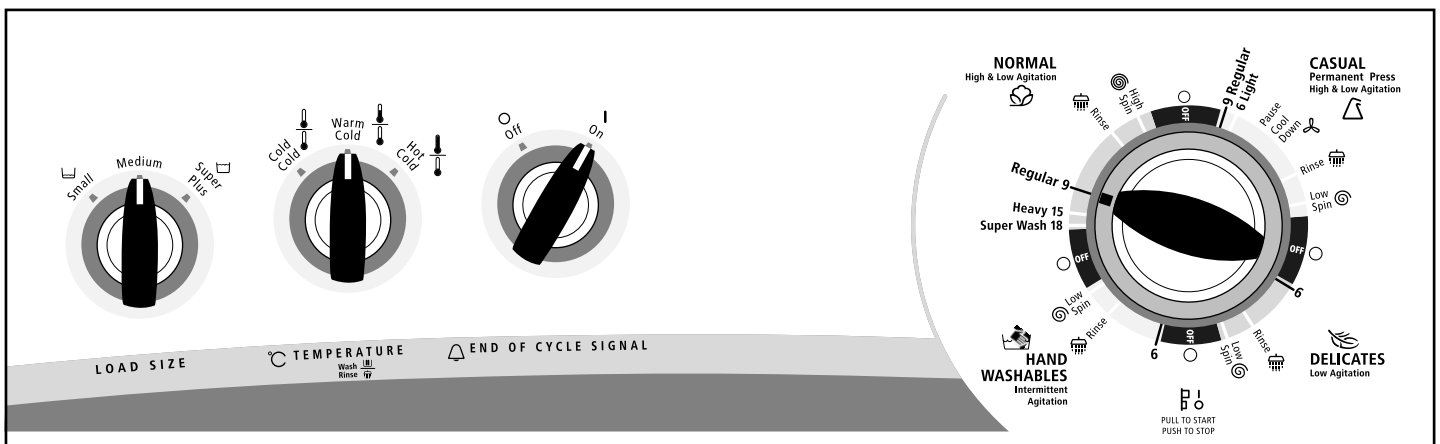

WASHER USE

Understanding Washer Cycles





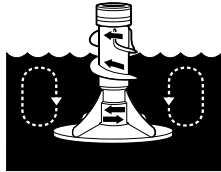

When the washer lid is closed and the Cycle Control knob is set to a number or cycle and pulled out, the washer fills (to the selected load size) before agitation and timing start. The washer begins agitating immediately after filling; agitation occurs with the washer lid down.

During agitation, the agitator creates a continuous rollover action (on some models) that provides a thorough cleaning of the wash load.

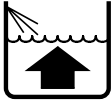

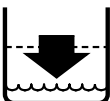
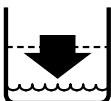
After agitation starts, the Cycle Control knob turns clockwise until it points to an OFF area and the cycle ends.

NOTE: The washer pauses briefly throughout each cycle. These pauses are normal for washer operation.

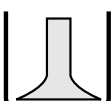
WASH	RINSE
 <p>1. Fill</p>	 <p>1. Fill</p>
 <p>2. Wash selected time</p>	 <p>2. Rinse</p>
 <p>3. Drain[†] No agitation</p>	 <p>3. Drain[†] No agitation</p>
 <p>4. Spin</p>	 <p>4. Spin-Spray rinse</p>
	 <p>5. Spin</p>
<p>[†]The Casual/Permanent Press cycle partially drains, fills, agitates briefly, and drains.</p>	 <p>6. Off</p>

Loading

For rated load capacity, refer to the model and serial label/plate, located on your washer as shown in "Parts and Features."

Loading suggestions

For these suggested full-sized loads, set the LOAD SIZE selector to the highest load size setting.

SUPER CAPACITY PLUS WASHERS

Heavy Work Clothes

3 pair pants	1 coverall
3 shirts	1 overall
4 pair jeans	

Delicates

3 camisoles	2 bras
1 quilted robe	2 nighties
4 slips	1 baby's dress
4 panties	

Towels

10 bath towels	14 washcloths
10 hand towels	1 bath mat

Mixed Load

3 double sheets	2 shirts
4 pillowcases	2 blouses
8 T-shirts	8 handkerchiefs
6 pair shorts	

EXTRA LARGE CAPACITY WASHERS

Heavy Work Clothes

2 pair pants	3 pair jeans
3 shirts	1 coverall

Delicates

3 camisoles	2 bras
4 slips	2 nighties
4 panties	

Towels

8 bath towels	10 washcloths
8 hand towels	1 bath mat

Mixed Load

2 double sheets or 1 king size sheet	6 pair shorts
4 pillowcases	2 shirts
6 T-shirts	2 blouses
	6 handkerchiefs

Normal Sounds

Your new washer may make sounds your old one didn't. Because the sounds might be unfamiliar, you may be concerned about them. These sounds are normal.

During washing

When you select a small load size setting, your washer has a lower water level. This can cause a clicking sound from the upper part of the agitator.

During drain

If water is drained quickly from your washer (depending on your installation), you may hear air being pulled through the pump during the end of draining.

After drain and before spin

When the cycle changes from draining to spinning, you may hear gears engaging.

Starting Your Washer

⚠ WARNING



Fire Hazard

Never place items in the washer that are dampened with gasoline or other flammable fluids.

No washer can completely remove oil.

Do not dry anything that has ever had any type of oil on it (including cooking oils).

Doing so can result in death, explosion, or fire.

⚠ WARNING



Electrical Shock Hazard

Electrically earth this appliance.

Do not use an extension cord or an electrical portable outlet device.

Failure to follow these instructions can result in death, fire, or electrical shock.

1. Measure detergent and pour it into the washer. If desired, add powdered or liquid color safe bleach. Add extra detergent for the Super Wash cycle.

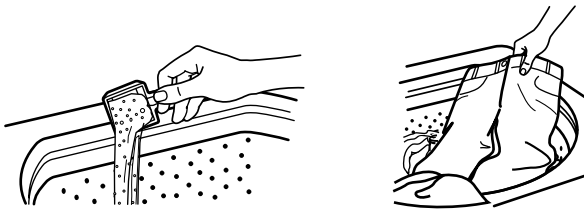

Drop a sorted load of clothes loosely into your washer.

- Load evenly to maintain washer balance. Mix large and small items.
- Items should move easily through the wash water. Overloading can cause poor cleaning.
- To reduce wrinkling of permanent press clothes and some synthetic knits, use a large load size to provide more space (see Step 5).

2. (OPTIONAL) Pour measured liquid chlorine bleach into the liquid chlorine bleach dispenser (on some models). Bleach will be diluted automatically during the wash part of the cycle.

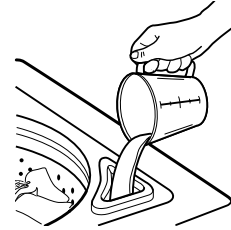

- Do not use more than 250 mL for a full load. Use less with a smaller load size.
- Follow the manufacturer's directions for proper use.
- To avoid spilling, use a cup with a pouring spout. Do not let bleach splash, drip, or run down into the washer basket.
- Use only liquid chlorine bleach in this dispenser.

NOTE: On models without a bleach dispenser, see "Adding Liquid Chlorine Bleach."

3. (OPTIONAL) Pour measured liquid fabric softener into the liquid fabric softener dispenser (on some models). Softener is added automatically during the rinse portion of the cycle.

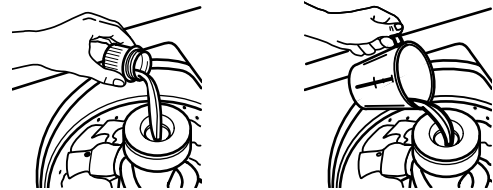

Dilute liquid fabric softener by filling the dispenser with warm water until liquid reaches the crossbar in the opening.

- Do not spill or drip any fabric softener on the clothes.
- Use only liquid fabric softener in this dispenser.

NOTE: On models without a fabric softener dispenser, see "Adding Liquid Fabric Softener."

4. Close the washer lid. Washer will not agitate or spin with the lid open.
5. Turn the LOAD SIZE selector to the correct setting for your wash load and the type of fabric being washed.

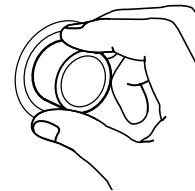

- Choose a load size that allows the load to move freely for best fabric care. See "Loading."
- You may change the load size selection after the washer has started filling by turning the selector to a different setting.

6. Set the TEMPERATURE selector to the correct setting for the type of fabric and soils being washed. Use the warmest water safe for fabric. Follow garment label instructions.

Your washer uses automatic temperature control (on some models) to maintain a uniform water temperature by regulating the incoming hot and cold water. This helps eliminate undissolved detergent and ensures consistent cleaning results. The Hot and Warm settings on this washer will be cooler than you are accustomed to. Wash temperatures in this washer are lower than the temperatures you may be used to in conventional washers.

NOTE: Make sure that both the hot and cold water taps are fully turned on, or the automatic temperature control feature will not work properly.

Water Temp	Use For
Hot	Whites and pastels Heavy soils
Warm	Bright colors Moderate to light soils
Cold	Colors that bleed or fade Light soils

NOTE: In wash water temperatures colder than 60°F (15.6°C), detergents do not dissolve well. Soils can be difficult to remove. Some fabrics can retain wear wrinkles and have increased pilling (the formation of small lint-like balls on the surface of garments).

7. (OPTIONAL) Some models have an EXTRA RINSE selector. For an additional rinse and spin at the end of a wash cycle, set the EXTRA RINSE selector to ON. On some models, the Extra Rinse feature is part of the cycle.
8. (OPTIONAL) Some models have an END OF CYCLE SIGNAL selector. Set the END OF CYCLE SIGNAL selector to ON if you want your washer to alert you when the wash cycle is complete. The signal is helpful when you are washing items that should be removed from the washer as soon as the cycle ends.
9. Push in the Cycle Control knob and turn it clockwise to the wash cycle you want. Reduce the wash time when using a small load size setting. See "Selecting a Cycle and Time."

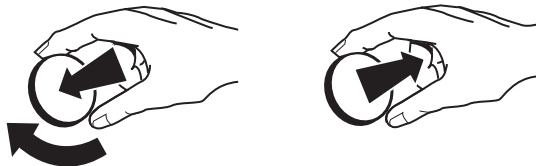

Pull out the Cycle Control knob to start the washer.

To stop or restart your washer

- To stop the washer at any time, push in the Cycle Control knob.
- To restart the washer, close the lid (if open) and pull out the Cycle Control knob.

Adding bleach to models without a bleach dispenser

If desired, add measured liquid chlorine bleach after the washer starts agitating. Pour diluted bleach around the agitator, not directly onto the load. Undiluted bleach will damage any fabric it touches. See "Adding Liquid Chlorine Bleach."

Adding softener to models without a fabric softener dispenser

If desired, add measured liquid fabric softener to the final rinse water. Always dilute fabric softener with 125 to 250 mL of warm water. Undiluted fabric softener can stain fabrics. See "Adding Liquid Fabric Softener."

Washer Symbols

The control panel of your washer contains symbols. Refer to the chart below for a definition of those symbols.

Symbols	Symbols
Small Load	Hand Washables
Large Load	Super Wash
Cold Temperature	Wash
Warm Temperature	Quick Wash
Hot Temperature	Prewash
Temperature	Rinse
On	Extra Rinse
Off	Spin
Buzzer	Slow Spin
Cotton	Cool Down
Synthetics	Pull Start Push Stop
Delicates	

Selecting a Cycle and Time

This section describes the available wash cycles and will help you make the best cycle selections for your wash loads. Each cycle is designed for different types of fabric and soil levels.

- The washer pauses briefly throughout each cycle. These pauses are normal. Refer to “Normal Sounds” to learn more about the sounds you may hear during a wash cycle.
- Refer to “Understanding Cycles” to learn what happens during a wash cycle.

NOTE: This manual covers several different washer models. The washer you have purchased will not have all of the cycles described.

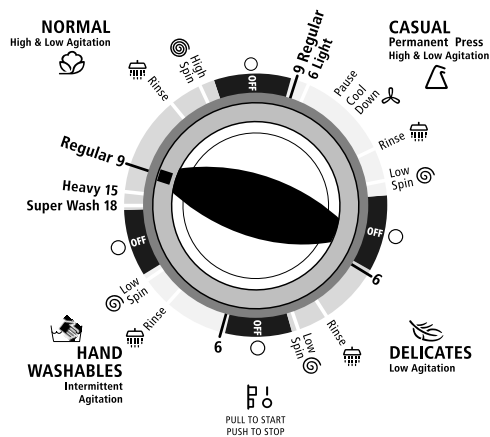

Heavy cycle

This cycle features high-speed agitation followed by brief periods of low-speed agitation for cleaning sturdy fabrics and heavily soiled loads that need maximum soil removal. Select Super Wash or Regular depending on whether your load is moderately or heavily soiled. For improved cleaning, use twice the amount of detergent recommended for a wash cycle. The Heavy cycle features Extra Rinse as part of the cycle.

Normal cycle

This cycle features high-speed agitation followed by a brief period of low-speed agitation for cleaning cottons and linens. High spin speeds shorten drying time. Select 9 to 15 minutes of wash time, depending on your model, for loads that are moderately or heavily soiled. For lightly soiled loads, use the shortest time setting.

Super Wash - Select the Super Wash setting to wash heavily soiled loads that need maximum soil removal. Use twice the amount of detergent recommended for a wash cycle.

Casual/Permanent Press cycle

This cycle starts with high-speed agitation and then steps down to low-speed agitation for cleaning permanent press blends and synthetic fabrics. To minimize wrinkling, this cycle features a cool-down rinse and a low-speed final spin. Select 6 to 9 minutes of wash time, depending on your model, to clean lightly to moderately soiled loads.

Delicates cycle

This cycle features low-speed agitation for gentle soil removal from delicate items and washable knits. Low spin speeds minimize wrinkling. Select 6 minutes of wash time, depending on your model, to clean lightly to moderately soiled loads.

Hand Washables cycle

This cycle features a series of brief, low-speed agitations and short soaks to gently clean special-care items. Low spin speeds minimize wrinkling. Wash small loads. If items appear to be floating (due to trapped air), stop the washer by pushing in the Cycle Control knob. Push items down into the washer. Restart the washer.

Rinse and Spin

When using extra detergent for heavily soiled clothes, or washing special-care items, you may find an extra rinse and spin are needed.

1. Push in the Cycle Control knob and turn it clockwise to any of the Rinse settings.
2. Pull out the Cycle Control knob. The washer fills to the selected load size, agitates, drains, and spins.

NOTE: An Extra Rinse option is available (on some models). See “Starting Your Washer.”

Drain and Spin

A drain and spin may help shorten drying times for some heavy fabrics or special-care items by removing excess water.

1. Push in the Cycle Control knob and turn it clockwise to any of the Spin settings.
2. Pull out the Cycle Control knob. The washer drains, then spins.

Adding Liquid Chlorine Bleach

Always measure liquid chlorine bleach. Do not guess. Do not use more than 250 mL for a full load. Follow manufacturer’s directions for proper use. Use a cup with a pouring spout to avoid spilling.

1. Let the washer fill and begin agitating the load.
2. Add bleach to the wash cycle so it can be removed in the rinse cycle. Pour bleach around the agitator, not directly onto the load to avoid damaging clothing or other items in the load.
 - Follow directions on the care labels. Do not use chlorine bleach on wool, silk, spandex, acetates, or some flame-retardant fabrics.
 - When soaking with chlorine bleach, add detergent to soak water.

NOTE: Undiluted bleach will damage any fabric it touches. The damage appears as rips, holes, tears, or color loss and may not show up until several washings later.

Adding Liquid Fabric Softener

Always dilute fabric softener with 125 to 250 mL warm water. Undiluted fabric softener can stain fabrics.

- Add diluted fabric softener only in the final rinse.
- Fabric softener should not be mixed with other laundry products. Greasy stains can form. To remove greasy stains, wet the stain and rub with liquid detergent or a bar of soap. Rewash.
- Too much fabric softener can make some items (cloth diapers and towels) nonabsorbent. If this happens, use less fabric softener, or do not use it every time.

WASHER CARE

Cleaning Your Washer

Cleaning the exterior

Use a soft, damp cloth or sponge to wipe up any spills such as detergent or bleach. Occasionally wipe the outside of your washer to keep it looking new.

Cleaning the interior

Clean your washer interior by mixing 250 mL of chlorine bleach and 500 mL of detergent. Pour this into your washer and run it through a complete cycle using hot water. Repeat this process if necessary.

NOTE: Remove any hard water deposits using only cleaners labeled for washer use.

Cleaning the liquid fabric softener dispenser

Flush dispenser periodically with warm water, as shown. Remove the dispenser by grasping the top of the dispenser with both hands and squeezing and pushing upward with thumbs. Clean the dispenser by rinsing it under a water faucet. Replace it after cleaning.

NOTE: Some models are equipped with a liquid fabric softener dispenser. To avoid damage to the washer or clothing, do not wash clothes with the liquid fabric softener dispenser removed or add detergent or bleach to this dispenser; it is for liquid fabric softener only.

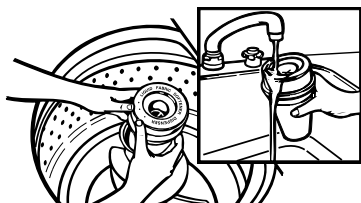

Water Inlet Hoses

Replace inlet hoses after 5 years of use to reduce the risk of hose failure. Periodically inspect and replace inlet hoses if bulges, kinks, cuts, wear or leaks are found.

When replacing your inlet hoses, mark the date of replacement on the label with a permanent marker.

Vacation, Storage and Moving Care

Install and store your washer where it will not freeze. Because some water may stay in the hoses, freezing can damage your washer. If storing or moving your washer during freezing weather, winterize it.

Non-use or vacation care

Operate your washer only when you are at home. If you will be on vacation or not using your washer for an extended period of time, you should:

- Unplug washer or disconnect power.
- Turn off the water supply to the washer. This helps avoid accidental flooding (due to a water pressure surge) while you are away.

To winterize washer

1. Shut off both water faucets.
2. Disconnect and drain water inlet hoses.
3. Put 1 L of R.V.-type antifreeze in the basket.
4. Run washer on a drain and spin setting (see "Drain and Spin") for about 30 seconds to mix the antifreeze and water.
5. Unplug washer or disconnect power.

To use washer again

1. Flush water pipes and hoses. Reconnect water inlet hoses. Turn on both water faucets.

⚠ WARNING



Electrical Shock Hazard

Plug into a grounded 3 prong outlet.

Do not remove ground prong.

Do not use an adapter.

Do not use an extension cord.

Failure to follow these instructions can result in death, fire, or electrical shock.

2. Plug in washer or reconnect power.
3. Run the washer through a complete cycle with 250 mL of detergent to clean out antifreeze.

TROUBLESHOOTING

First try the solutions suggested here and possibly avoid the cost of a service call...

Washer won't fill, rinse or agitate; washer stops

WARNING



Electrical Shock Hazard

Plug into a grounded (earthed) outlet.

Do not remove ground prong.

Do not use an adapter.

Do not use an extension cord.

Failure to follow these instructions can result in death, fire, or electrical shock.

- **Is the power cord plugged into an earthed 3 prong outlet?** Plug power cord into an earthed 3 prong outlet.
- **Are you using an extension cord?** Do not use an extension cord.
- **Is the indicator on the Cycle Control knob properly lined up with a cycle?** Turn the Cycle Control knob to the right slightly and pull to start.
- **Are the water inlet valve screens clogged?** Turn off the water and remove inlet hoses from the washer. Remove any accumulated film or particles. Reinstall hoses, turn on water and check for leaks.
- **Are both the hot and cold water faucets turned on?** Turn on the water.
- **Is the water inlet hose kinked?** Straighten the hoses.
- **Does the water level seem too low, or does the washer appear to not fill completely?** The top of the agitator is much higher than the highest water level. This creates a perception that the washer is not filling completely. This is normal.
- **Has a household fuse blown, or has a circuit breaker tripped?** Replace the fuse or reset the circuit breaker. If the problem continues, call an electrician.
- **Is the washer in a normal pause in the Casual/Permanent Press (or Hand Washables) cycle?**
The washer pauses for about 2 minutes in the Casual/Permanent Press cycle. Allow the cycle to continue.

The Hand Washables cycle (on some models) features periods of agitation and soak.
- **Is the washer overloaded?** Wash smaller loads.
- **Is the lid open?** The lid must be closed during operation. Washer will not agitate or spin with the lid open.

Washer continues to fill or drain, or the cycle seems stuck

- **Is the top of drain hose lower than the water level in washer?** The top of the hose must be higher than the water level in the washer for proper operation. See the Installation Instructions.
- **Does the drain hose fit too tightly in the standpipe, or is it taped to the standpipe?** The drain hose should be loose yet fit securely. Do not seal the drain hose with tape. The hose needs an air gap. See the Installation Instructions.

Washer won't drain or spin

- **Is the drain hose clogged, or the end of the drain hose more than 183 cm above the floor?**
See the Installation Instructions for proper installation of drain hose.
- **Is the lid open?**
The lid must be closed during operation. Washer will not agitate or spin with the lid open.
- **Is there excessive sudsing?**
Always measure detergent. Follow manufacturer's directions. If you have very soft water, you might need to use less detergent.
- **Is your voltage low?**
Check your electrical source or call an electrician. Do not use an extension cord.

Washer makes noise

- **Is the load balanced, and is the washer level?**
The wash load should be balanced and not overloaded.

The washer must be level. The front feet should be properly installed and the nuts tightened. Reset the rear leveling legs (if needed). See the Installation Instructions.
- **Did you completely remove the yellow shipping strap with cotter pins?**
See the Installation Instructions.
- **Are the gears engaging after the drain and before spin, or is the upper part of agitator clicking during wash?**
These are normal washer noises.

Washer leaks

- **Check the following:**
Are the fill hoses tight? Are the fill hose washers properly seated? Is the drain hose clamp properly installed? See the Installation Instructions.
- **Is the sink or drain clogged?**
Sink and standpipe must be able to handle 64 L of water per minute.
- **Is water deflecting off the tub ring or the load?**
Center the tub before starting the washer.

The wash load should be balanced and not overloaded. The fill or spray rinses can deflect off the load.

The washer must be level. The front feet should be properly installed and the nuts tightened. Reset the rear leveling legs (if needed). See the Installation Instructions.
- **Check household plumbing for leaks.**

Washer basket is crooked

- **Was the washer basket pulled forward during loading?**
The wash load should be balanced and not overloaded. Push the basket to the center before starting wash.
- **Is the load balanced, and is the washer level?**
The wash load should be balanced and not overloaded.

The washer must be level. The front feet should be properly installed and the nuts tightened. Reset the rear leveling legs (if needed). See the Installation Instructions.
- **The washer basket moves while washing.**
This is normal.

Agitator operation

- **The top of the agitator is loose, or moves in only one direction.**
This is normal.

Dispensers clogged or bleach leaking

- **Did you follow the manufacturer's directions when adding detergent and fabric softener to the dispensers?**
Measure detergent and fabric softener. Slowly pour into the dispensers. Wipe up all spills.

Dilute fabric softener in the fabric softener dispenser.
- **Did you put powdered or color-safe bleach into the liquid chlorine bleach dispenser?**
Add powdered or liquid color-safe bleach directly to the basket. Do not use the chlorine bleach dispenser for color-safe bleach.

Load too wet

- **Did you use the right cycle for the load being washed?**
Select a cycle with a higher spin speed (if available).
- **Did you use a cold rinse?**
Cold rinses leave loads wetter than warm rinses. This is normal.

Residue or lint on load

- **Did you sort properly?**
Sort lint givers (towels, chenille) from lint takers (corduroy, synthetics). Also sort by color.
- **Did you overload the washer?**
The wash load must be balanced and not overloaded. Lint can be trapped in the load if overloaded. Wash smaller loads.
- **Check the following:**
Was paper or tissue left in the pockets?

Did you use enough detergent? Follow manufacturer's directions. Use enough detergent to hold the lint in the water.

Is your water colder than 15.6°C? Wash water colder than 15.6°C may not completely dissolve the detergent.

Stains on load

- **Did you follow the manufacturer's directions when adding detergent and fabric softener?**
Measure detergent and fabric softener. Use enough detergent to remove soil and hold it in suspension.

Dilute fabric softener and add to the rinse portion of a cycle only. Do not drip fabric softener onto clothes.
- **Is there above average iron (rust) in water?**
You may need to install an iron filter.
- **Did you properly sort the load?**
Sort dark clothes from whites and lights.
- **Did you unload the washer promptly?**
To avoid dye transfer, unload the washer as soon as it stops.

Load is wrinkled

- **Did you unload the washer promptly?**
Unload the washer as soon as it stops.
- **Did you use the right cycle for the load being washed?**
Use the Casual/Permanent Press cycle or another cycle with low spin speeds (if available) to reduce wrinkling.
- **Did you overload the washer?**
The wash load must be balanced and not overloaded. Loads should move freely during washing.
- **Was the wash water warm enough to relax wrinkles, or are you using warm rinses?**
Use hot or warm washes if safe for the load. Use cold rinse water.
- **Are the hot and cold water hoses reversed?**
Check that the hot and cold water hoses are connected to the right faucets. See the Installation Instructions.

Load is tangled or twisted

- **Did you overload the washer?**
The wash load must be balanced and not overloaded. Loads should move freely during washing.
- **Did you wrap items around the agitator?**
Drop items loosely into the washer. Do not wrap items around the agitator.

Gray whites, dingy colors

- **Did you properly sort the load?**
Dye transfer can occur when mixing whites and colors in a load. Sort dark clothes from whites and lights.
- **Was the wash temperature too low?**
Use hot or warm washes if safe for the load. Make sure your hot water system is adequate to provide a hot water wash.
- **Did you use enough detergent, or do you have hard water?**
Use more detergent for washing heavy soils in cold or hard water.
- **Are the hot and cold water hoses reversed?**
Check that the hot and cold water hoses are connected to the right faucets. See the Installation Instructions.

Garment damage

- **Check the following:**
Were sharp items removed from pockets before washing?
Empty pockets, zip zippers, snap or hook fasteners before washing.

Were strings and sashes tied to avoid tangling?

Were items damaged before washing? Mend rips and broken threads in seams before washing.
- **Did you overload the washer?**
The wash load must be balanced and not overloaded. Loads should move freely during washing.
- **Did you properly add chlorine bleach?**
Do not pour chlorine bleach directly onto load. Wipe up bleach spills. Undiluted bleach will damage fabrics.
- **Did you follow the manufacturer's care label instructions?**

ASSISTANCE OR SERVICE

Before calling for assistance or service, please check "Troubleshooting." It may save you the cost of a service call. If you still need help, contact the dealer from whom you purchased the washer, or a Whirlpool designated service company.

When calling, please know the purchase date and the complete model and serial number of your appliance. This information will help us to better respond to your request.

If you need replacement parts

If you need to order replacement parts, we recommend that you only use factory specified parts. These parts will fit right and work right because they are made with the same precision used to build every new WHIRLPOOL® appliance.

To locate replacement parts in your area:

Contact the dealer from whom you purchased the washer, or a Whirlpool designated service company.

WHIRLPOOL® WASHER

Technical Specifications

Frequency of Operation	50 Hz
Amps	5.0 A
Volts	220 V~
Height	108 cm
Width	68 cm
Depth	65 cm
Maximum Water Inlet Pressure	690 kPa
Minimum Water Inlet Pressure	34.5 kPa
Maximum Working Noise Level During Wash Cycle	62 dBa
Maximum Working Noise Level During Spin Cycle	72 dBa

Notes

洗衣机安全说明

您以及其他人的安全非常重要

我们在用户手册以及机器上面里提供了许多安全信息。请您务必阅读和遵守这些安全信息。



这是安全警告符号。

该符号警告您有潜在的危險，可能造成您或者其他人死亡或者受伤。

所有安全信息都会跟在安全警告符号后面，以及有“DANGER（危險）”或者“WARNING（警告）”字样。

这两个词的意思是：

⚠ 危險

如果您没有立即按照说明操作，您可能致死或者严重受伤。

⚠ 警告

如果您没有按照说明操作，您可能致死或者严重受伤。

所有安全信息都会告诉您有什么潜在的危險，告诉您如何减少受伤的危險，以及如果没有按照说明操作会发生什么事故。

重要安全说明

警告：为了减少起火、电击、或者对使用洗衣机的人员造成伤害的危險，请遵守以下的基本注意事项：

- 在使用洗衣机以前，阅读所有说明。
- 请不要洗涤那些已经在汽油、干洗剂、其它易燃或易爆物质中清洁过、洗过、泡过或沾上过的衣物，因为它们产生的气体可能引起燃烧或者爆炸。
- 请不要在洗涤水中加入汽油、干洗剂，或者其他易燃易爆的物质，因为它们产生的气体可能引起燃烧或者爆炸。
- 在一定的条件下，氢气可以在未被使用2个星期或者以上的热水系统中产生。氢气是容易爆炸的气体。如果热水未被使用达这一期限，那么在使用洗衣机前，请打开所有热水水龙头，让每个水龙头流几分钟。这样可以减少任何储积的氢气。由于该气体易燃，这时请不要吸烟或者使用明火。
- 请不要让小孩在洗衣机外部或者内部玩耍。如果洗衣机在小孩旁边工作，有必要对小孩进行密切监督。
- 该机器不适合在无监督情况下给小孩或者弱者使用。
- 在洗衣机被拆除或者丢弃前，请卸下门或者盖子。
- 当圆桶、洗衣缸或者搅拌机在转动的时候，请不要伸入洗衣机内。
- 请不要将洗衣机安装或存放在露天下。
- 不要损坏控制器。
- 请不要维修或者更换洗衣机的任何部件，或者试图进行其他维修行动，除非本使用手册或者其他已出版的用户维修手册中有说明并且您有能力进行维修操作。
- 请看安装说明的接地要求。
- 如果提供的电源线损坏了，必须由制造商或者其服务代理商或者相似的合格人员进行更换，以免发生危險。

请保存好这些说明

部件和特征

该用户手册包括许多种不同的型号。您所购买的洗衣机有以下部分或者全部部件和特征。

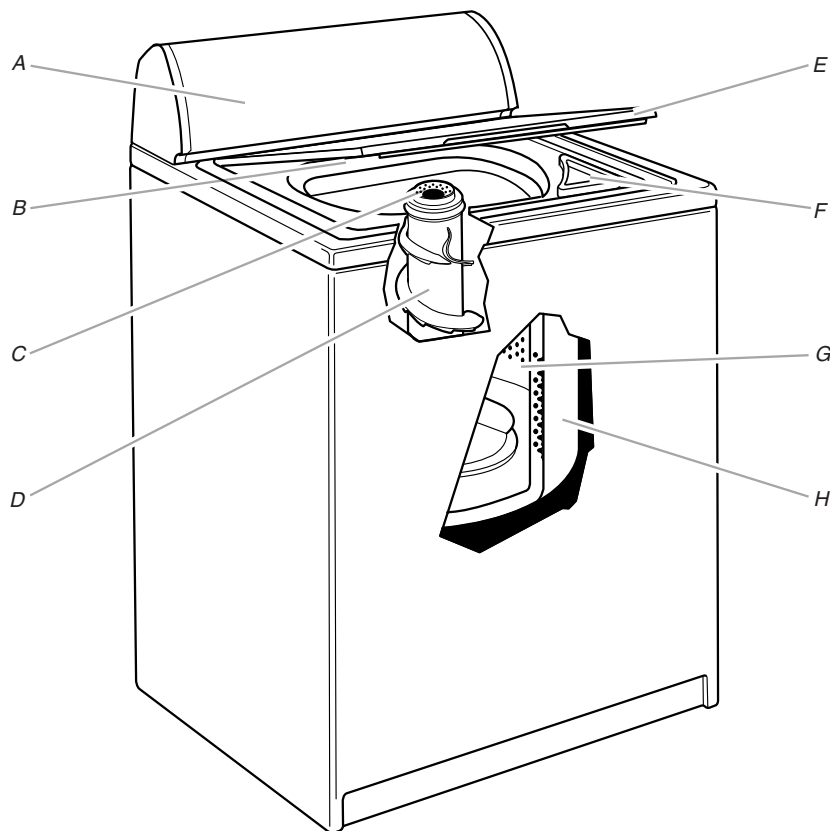

- A. 控制面板
- B. 型号和系列码标签
- C. 液体柔顺剂分配器
- D. 搅拌机

- E. 盖子
- F. 液体氯漂白剂分配器
- G. 洗衣篮
- H. 洗衣缸

您的洗衣机可能拥有的特征

- 搅拌机
- 白瓷洗衣篮

控制面板

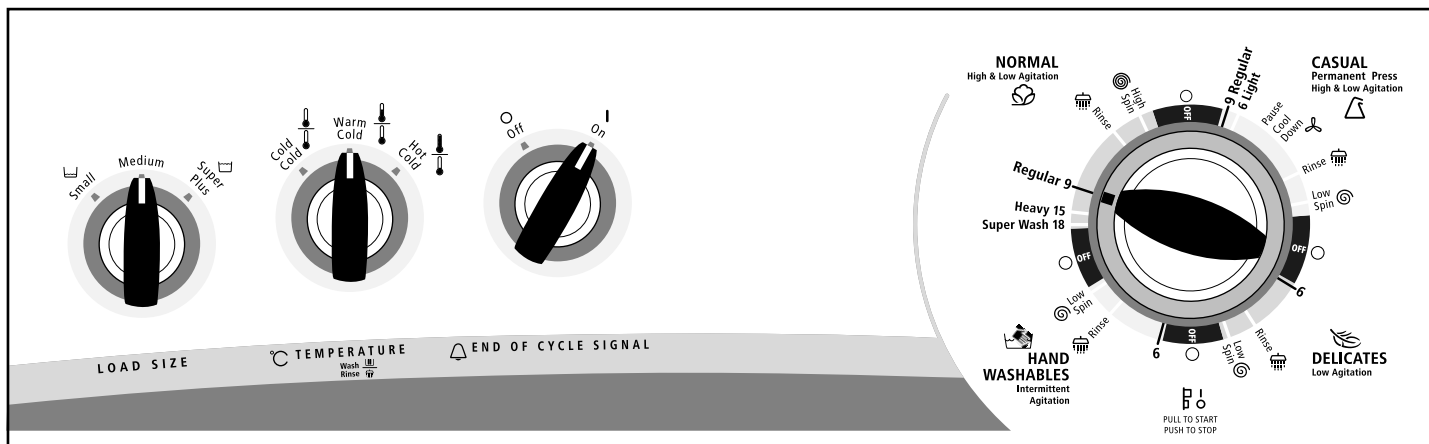

洗衣机的使用

了解洗衣循环过程

当洗衣机盖子盖好并且控制面板的旋钮设置到某个数字或者某个过程，拔起来后，洗衣机开始注水（到选择好的洗衣量水位），然后开始搅拌和计时。注水完盖上盖子以后，洗衣机马上就开始搅拌。在搅拌过程中，搅拌机不会不停地滚转（某些型号上），彻底洗涤衣物。

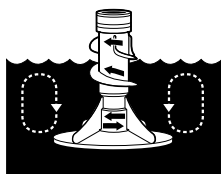

搅拌开始后，控制面板的旋钮按顺时针方向旋转直到它指向 OFF（关）区域并终止洗衣过程。

注意：对每个过程中，洗衣机会短暂暂停。这对于洗衣过程是正常的。

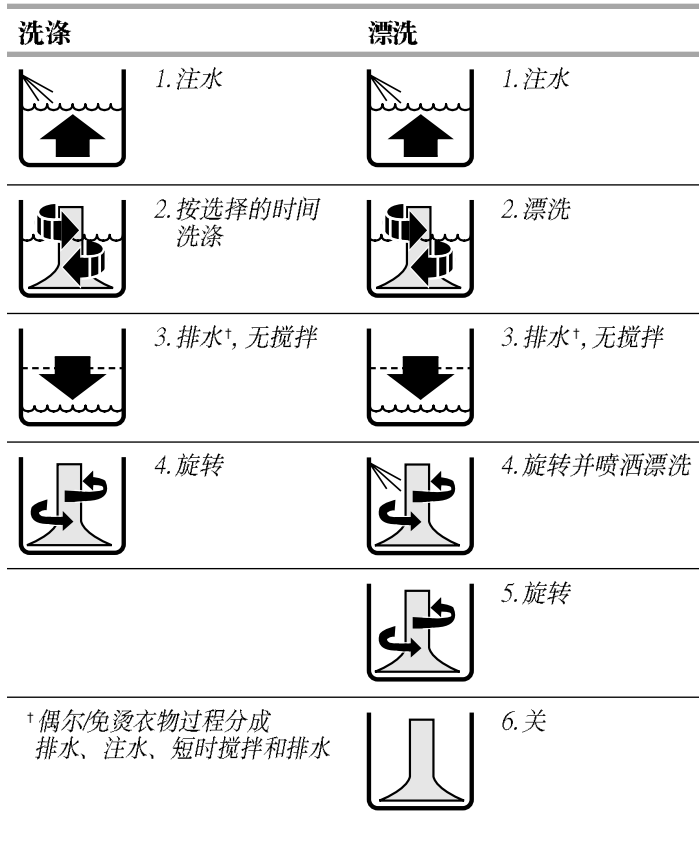

装载衣物

想知道装载衣物的容量，请参考洗衣机上的“部件和特征”中的型号和系列码标签/牌子。

装载衣物建议

对这些建议的满装载容量，请将装载量选择器设置为最高。

超大容量洗衣机

重工作服

3 条裤子	1 连裤工作服
3 衬衫	1 工装裤
4 套牛仔	

精致服饰

3 女背心	2 乳罩
1 棉长袍	2 睡衣
4 长女衬衣	1 儿童服饰
4 童裤	

毛巾

10 浴巾	14 毛巾
10 手巾	1 浴室防滑垫

混合装载

3 双人床单	2 衬衣
4 枕套	2 罩衫
8 T 恤	8 手帕
6 短裤	

特大容量洗衣机

重工作服

2 裤子	3 牛仔服
3 裙子	1 连裤工作服

精致衣物

3 女背心	2 乳罩
4 长女衬	2 睡衣
4 童裤	

毛巾

8 浴巾	10 毛巾
8 手巾	1 浴室防滑垫

混合装载

2 双人床单或者 1 张大床单	6 短裤
4 枕套	2 衬衣
6 T 恤	2 宽松上衣
	6 手帕

正常的声音

您的洗衣机可能会有一些与旧洗衣机不同的声音，因为这些声音可能是您不熟悉的，也许您会注意到。这些声音却是正常的。

洗涤过程中

当您选择少量设置时，您的洗衣机水量也是低水位的。这样在搅拌机上部会有啜啜声。

在排水过程中

如果洗衣机快速排水（要视您的安装情况而定），在排水快结束时，您可以从排水口一端听到水管内的空气抽动的声音。

排水之后脱水之前

当从排水转向脱水过程时，您会听到齿轮卡合的声音。

开始使用您的洗衣机

警告



火险

请不要将带有汽油或其它易燃性液体的衣物放入洗衣机。
没有任何洗衣机可以完全清除油污。
请不要烘干任何曾经带有油渍的衣物（包括食用油）。
如此操作，可能造成死亡、爆炸或者起火。

警告



电击危险

请将电器接地。
请不要使用加长电线或者一个手提式便携式插座设备。
如不按此操作，可能造成死亡、起火或者电击。

1. 量好洗洁剂并倒入洗衣机。如果需要，请加入粉状或者液体不退色漂白剂。对于超强洗衣过程请加入更多些洗洁剂。

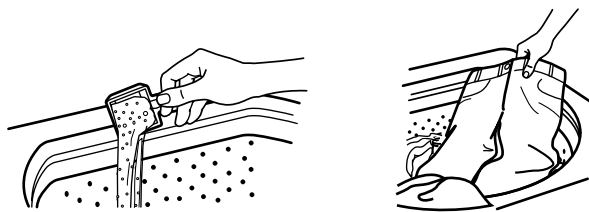

请将分类衣物松散放入洗衣机。

- 将衣物均匀放好。将大小件混合起来。
- 衣物在水中必须能自由漂动。装载过量会洗不干净。
- 要减少免烫衣物和一些合成衣物的褶皱，使用最大载量以提供足够空间（请看步骤 5）。

2. (可选) 将液体氯漂白剂倒入液体漂白剂分配器（某些型号上有）。漂白剂在洗涤过程中会自动被稀释。

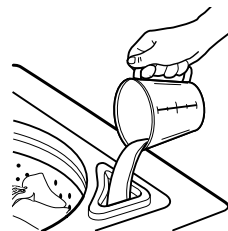

- 在满载量时的用量不要超过 250 毫升。对于较少衣物量，请适当减少。
- 请遵照制造商的要求正确使用。
- 为了避免溢出，请使用带有嘴的杯子来倒入。不要让漂白剂飞溅、滴落或者流入洗衣篮。
- 请在分配器中只使用液体氯漂白剂。

注意：对于没有漂白剂分配器的型号，请参看“加入氯漂白剂”章节。

3. (可选) 将量好的液体柔顺剂倒入柔顺剂分配器（某些型号上有）。柔顺剂会在漂洗过程中被自动加入。

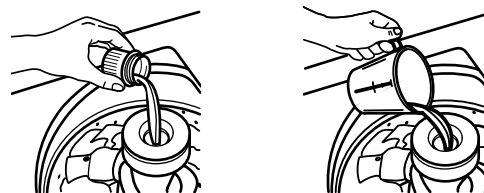

用温水稀释液体柔顺剂，直到水达到开口处的水线。

- 不要将柔顺剂滴落或者溅到衣物上。
- 仅在分配器中使用液体柔顺剂。

注意：对于没有柔顺剂分配器的型号，请参看“加入柔顺剂”章节

4. 盖上洗衣机盖子。如果盖子开着，洗衣机不会搅拌或者脱水。
5. 将衣物装载量选择旋钮旋转到您想要的衣物量以及类型设置。

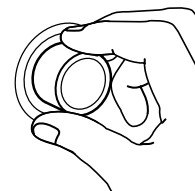

- 请选择适合衣物自由漂动的装载量。请参看“装载衣物”章节。
- 当洗衣机开始注水的时候，您可以更改装载量，仅将旋钮调到新的设置。

6. 将温度选择器设置到正确的衣物和脏度类型。使用对衣物最好的温水。请按照衣物标签说明操作。

您的洗衣机使用自动温度控制（在某些型号上有），通过控制热水和冷水进水来维持始终的温度。这样可以减少未溶解洗涤剂并保持一致的洗洁效果。热水和温水设置比您过去习惯的要凉一些。洗衣机的洗涤温度将比您过去习惯的洗衣机温度还低。

注意：确保热水和冷水水龙头都全部打开着，否则温度控制特征无法自动工作。

水温	适用衣物
热水	白色和浅色的 极脏的
温水	鲜亮色 中等脏的
冷水	容易退色的 轻微脏的

注意：在洗衣机水温低于 60 (15.6) 时，洗涤剂不会完全溶解。这样就比较难去污。一些衣物可能会保持皱褶并且会增加起球（也就是在衣物表面起的一些小球）。

7. (可选) 一些型号有额外漂洗选择器。再洗涤后想要额外漂洗并脱水，请设置额外漂洗选择器为 ON (开)。在某些型号上，额外漂洗是循环过程的一部分。
8. (可选) 有些型号有一个 END OF CYCLE SIGNAL (结束循环信号) 选择器。如果您希望在洗涤完成时洗衣机发出警告信号，请将结束循环信号设置成开。如果您洗涤一些需要在完成时马上取出的衣物时，该终止循环信号是很有用处的。
9. 按下过程控制旋钮并顺时针旋转到您想要的过程。如果是少量衣物，请减少时间。参看“选择一个循环过程和时间”章节



拨起旋钮开始洗衣。

停止或者重新启动洗衣机

- 如果任何时候要停止洗衣，请按下循环过程控制旋钮。
- 要重新启动，请盖上盖子（如果是开着的话）并拨起循环过程控制旋钮。

没有漂白剂分配器的洗衣机如何加入加漂白剂

如果需要，请在洗衣机开始搅拌后，加入液体漂白剂。将稀释的漂白剂加入到搅拌机周围，不要直接倒到衣物上面。没有稀释的漂白剂会损坏碰到的衣物。请参看“加入氯漂白剂”章节。

没有柔顺剂分配器的洗衣机如何加入柔顺剂

如果需要，将量好的柔顺剂加入最后漂洗的水中。请用 125 至 250 mL 的温水稀释柔顺剂。没有稀释的柔顺剂会染污衣物。请参看“加入柔顺剂”章节。

洗衣机符号

您的洗衣机控制面板包含一些符号，请参考下面对这些符号的定义。

符号	符号
少量衣物	手洗
大量衣物	超级洗涤
温度冷	洗涤
温度温	快洗
温度热	洗涤前
温度	漂洗
开	额外漂洗
关	脱水
蜂鸣器	慢脱水
棉花	冷却下来
合成纤维	拨起开始 按下停止
精致	

选择一种循环过程和时间

该选择描述了可用的一些洗涤过程选择以及帮助您依据衣物装载量作出最好的选择。每种循环过程都是适合不同种类和肮脏程度的衣物。

■ 在每个循环过程中，洗衣机都会短暂暂停。这些短暂暂停是正常的。请参看“正常的声音”章节，了解您在该过程中可能听到的一些声音。

■ 参看“了解循环过程”，了解每个洗衣循环过程的工作情况。

注意：该用户手册包括几种不同的洗衣机型号。您所购买的洗衣机可能没有包括所有过程。

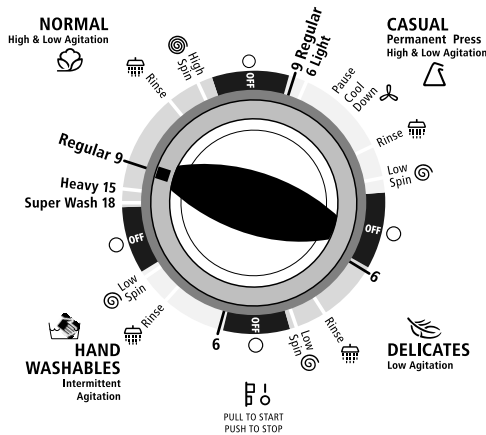

重循环过程

该循环特征是高速搅拌伴随简短的低速搅拌，适合结实和超脏而需要强力去污的衣物。选择超级洗涤或者普通洗涤，要视是否您装载的衣物是中等或者很脏状态。为了提高清洁能力，在一个循环过程中请使用两倍的洗涤剂。重循环特征包括额外漂洗功能。

正常循环过程

该循环特征是高速搅拌伴随短期低速搅拌，适合清洗棉类或者亚麻类衣物。高速脱水可以减短晾干时间。对中等或极度肮脏的衣物，请选择9至15分钟的洗涤时间，视您的型号而定。对于轻度肮脏的衣物，使用最短的时间设置。

超级洗涤 - 选择超级洗涤设置，来洗涤极度肮脏的衣物，需要强力去污。每个洗涤循环都要使用两倍的洗涤剂。

偶尔 / 免烫衣物循环过程

该循环开始以高速搅拌然后慢慢变成低速搅拌，适合洗涤免烫混合和合成衣物。要最大减少皱褶，该循环过程需要冷漂洗和最后低速脱水。选择6至9分钟的洗涤时间，视您的型号而定，轻柔洗涤，适合轻度和中等脏的衣物。

精致衣物循环过程

该循环过程特征是低速搅拌，轻柔去污，适合精致可洗的衣物。低速脱水可以最大减少皱褶。请选择6分钟的洗涤时间，视您的型号而定，轻柔清洗中等肮脏的衣物。

可手洗衣物的洗涤循环过程

该过程特征是一系列短的低速搅拌和短期浸泡，以轻柔洗涤需要特别小心的衣物。低速脱水可以最大限度减少皱褶。洗涤少量的衣物。如果衣物会漂浮（因为聚集的空气），请按下循环过程控制按钮停下洗衣机。将衣物接入洗衣机。重新启动洗衣机。

漂洗和脱水

当使用额外洗涤剂洗涤很脏的衣物时，或者洗涤需要特别小心的衣物时，您需要额外的漂洗和脱水。

1. 按下控制旋钮并顺时针旋转到任何一种脱水设置。
2. 拔起控制旋钮。洗衣机开始注水，然后搅拌、排水和脱水。

注意：也可以选择额外的漂洗（在一些型号上）。请参看“启动您的洗衣机”章节。

排水和脱水

对一些重的衣物或者需要特别小心洗涤的衣物，排水和甩干可以用掉过多的水分，减少晾干时间。

1. 按下过程控制旋钮并顺时针旋转到任何一种脱水设置。
2. 拔起过程控制旋钮。洗衣机就开水排水然后脱水。

加入液体氯漂白剂

要量好液体氯漂白剂，不要猜。对于满载量不要使用超过250 mL（毫升）的漂白剂量。请遵循制造商的正确使用说明。使用带嘴的杯子，避免溅出来。

1. 让洗衣机注水并开始搅拌衣物。
2. 再洗涤过程中加入漂白剂，这样在漂洗过程中就可以清洗掉。将漂白剂倒到搅拌机周围，不要直接的倒在衣物上，避免损坏衣服或者其他衣物。

■ 请遵循注意标签上的说明。不要使用氯漂白剂在羊毛、丝绸、氨纶或者其他阻燃衣物。

■ 当加入氯漂白剂浸泡时，将洗涤剂加入浸泡的水中。

注意：未稀释的漂白剂可能会损坏碰触到的衣物。比如会出现裂口、开口、撕裂，或者褪色，而且不会马上显示而是要多次洗涤以后才看得出来。

加入液体柔顺剂

务必使用125至250 mL（毫升）的水稀释柔顺剂。未稀释的柔顺剂会损坏衣物。

■ 只有在最后一次漂洗的时候加入稀释过的柔顺剂。

■ 柔顺剂不要和其它洗涤产品混合起来。那样会产生油脂污物。要去除那些污物，请湿化污物并使用洗涤剂擦洗或者用肥皂擦洗。重洗。

■ 过多的柔顺剂可能会使衣物（如布质尿布和毛巾）变成无吸收性。如果发生这种情况，请减少柔顺剂的量，或者干脆不要使用它。

洗衣机的维护

清洁您的洗衣机

清洁外部

使用软湿布或者海绵来擦拭外部的一些污渍比如洗洁剂或者漂白剂。偶尔擦拭洗衣机的外部使其美观。

清洁内部

混合 250 mL (毫升) 氯漂白剂和 500 mL (毫升) 洗洁剂, 用于清洁洗衣机内部。将其倒入洗衣机内, 使用热水注入, 运行一个完整循环过程。如果需要请重复该步骤。

注意: 请使用仅标签上标明适合洗衣机的清除工具来去除洗衣机内硬的水沉积物。

清洁液体柔顺剂分配器

如图所示, 用温水定期冲洗分配器。双手抓住分配器的上部用大拇指往上挤压取下分配器。在水龙头下冲洗该分配器。清洗完后, 安放回去。

注意: 一些型号的洗衣机配备有液体柔顺剂分配器。为了不损坏洗衣机或者衣物, 请不要在分配器取下的时候洗涤衣物, 也不要加入洗洁剂或漂白剂到该分配器里, 因为它是给柔顺剂专用的。

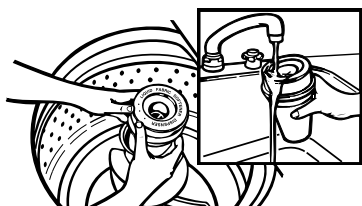

进水

进水管在使用 5 年后要更换, 减少损坏危险。定期检查和更换水管看是否有凸出、扭结、割坏、磨损或者泄漏现象。

当更换您的进水管时, 在标签上注明更换日期。

度假、储存和搬运护理

将洗衣机安装和储存在不会冰冻的环境下。因为可能回游一些水积存在水管内, 如果冰冻可能损坏洗衣机。如果在冰冻的天气下搬运您的洗衣机, 请作御寒处理。

不使用或者度假护理

只有您在家的时候才使用洗衣机。如果您将要去度假或者将在一段时间内不使用您的洗衣机, 您必须:

- 拔除电源或者断开电源。
- 关掉进水。这样可以避免在您不在的时候发生水泛滥 (因为水压等原因)

T 御寒处理

1. 关掉两个水龙头
2. 拔掉进水管并排干水。
3. 在洗衣篮内放入 1 升 R.V.- 类的防冻剂。
4. 运行排水和脱水设置 (参看 遗潘 屯陶) 大约 30 秒钟, 以混合水和防冻剂。
5. 拔除或者断开电源。

要再次使用洗衣机

1. 冲洗水管。接上进水管。打开两个水龙头。

警告



电击危险

插入三相插座

不要拆掉地相接头

不要使用适配器

不要使用加长电线

如果没有按照这些说明操作, 可能造成死亡、起火或者电击的危险。

2. 插上电源或者重新接上电源。
3. 使用 250 mL (毫升) 的洗洁剂, 运行一个完整循环过程, 清洗掉防冻剂。

故障解决

请您首先试试以下建议的方法，并尽可能避免电话呼叫服务产生的费用。

洗衣机不注水，不漂洗或者不搅拌；洗衣机停止工作

警告



电击危险

插入接地（有地相）的插座

不要拆掉地相接头

不要使用适配器

不要使用加长电线

如果没有按照这些说明操作，可能造成死亡、起火或者点
击的危险。

- **电线是否插入一个接地的3相插座？** 请将电线插入一个接地的3相插座内。
- **您使用加长电线吗？** 请不要使用加长电线。
- **过程控制旋钮已经准确指向某个循环过程了吗？** 将过程控制旋钮轻轻向右转然后拨起并启动洗衣机。
- **进水管阀门筛网堵住了吗？** 关掉水并拆卸下进水管。除去堵住的颗粒或脏东西。重新装上水管，打开水检查出水情况。
- **热水和冷水龙头都开着吗？** 打开水。
- **进水管弯曲了吗？** 拉直进水管
- **水位看起来太低，或者洗衣机看起来无法完全注水吗？** 搅拌机的顶端比最高水位还高出许多。这给人一个假象是水没有完全注入，这是正常的
- **家里有保险丝熔断，或者有断路器出错了吗？** 更换保险丝或者重设该断路器。如果还有问题，请电工来检查一下。
- **洗衣机在偶尔/免烫（或手洗衣物）过程时有正常的暂停吗？** 在偶尔/免烫（对手洗衣物）过程时洗衣机会暂停2分钟。让该循环过程继续。
手洗衣物的循环过程（某些型号上有）特征是定期搅拌和浸泡
- **洗衣机超载量了吗？** 请减少衣物载量。
- **洗衣机盖子开着吗？** 洗衣机运行时，盖子必须盖好。如果盖子开着，洗衣机不会搅拌或者脱水。

洗衣机持续注水或者排水，或者该过程看起来不工作

- 排水管的顶端比洗衣机内的水位低吗？水管顶端必须比洗衣机内的水位高，洗衣机才可以正常工作。请参看安装说明。
- 排水管与竖管结合太紧了吗，或者是胶合在竖管上的吗？排水管必须松点但是又安全结合。请不要用胶带封住排水管。水管需要空气间隙。请参看安装说明。

洗衣机不排水或者脱水

- 排水管堵住了，或者排水管末端在距离地面超过183cm吗？参看安装说明，正确安装排水管。
- 盖子开着吗？洗衣机运行时，盖子必须关着。如果盖子开着，洗衣机不会搅拌和脱水。
- 泡沫过多吗？请量好洗洁剂。遵循制造商的指示。如果您有软水，请减少洗洁剂用量。
- 电压太低了吗？请检查电源或者请求电工帮助。请不要使用加长电线。

洗衣机有噪音

- **是否衣物装载均匀，洗衣机安放平稳吗？** 装载的衣物必须均匀放好而且不能超载。
洗衣机必须得放安稳。前脚必须安装正确并且螺母旋紧。重设后面的平衡脚（如果需要）。请参看安装说明
- **您完全除去黄色带有开口销的包装带子吗？** 请参看安装说明。
- **在排水后和脱水前，齿轮有卡合，或者搅拌机在洗涤过程中正常发出嘀嗒声吗？** 这些是正常的洗衣机声音。

洗衣机漏水

- 检查以下方面：
注水水管旋紧了吗？注水水管位置接对了吗？排水管的夹子夹紧了吗？参看安装说明
- 水槽或者排水堵住了吗？
水槽和竖管必须每分钟可以接受 64 升的水。
- 水从洗衣缸偏出或者衣物偏位了吗？
启动洗衣机前要将洗衣缸定位在中间。
要洗的衣物必须安放均匀并且没有超载。注水或者喷洒漂洗都可能使衣物偏位。
洗衣机必须安放安稳。前脚必须正确安装并旋紧螺母。重设后面平衡脚（如果需要）。参看安装说明。
- 检查家里的水管是否漏水。

洗衣篮倾斜

- 洗衣篮在装载衣物时向前倾斜了吗？
要洗的衣物必须均匀放置并且不能超载。在开始洗涤之前，将洗衣篮推向正中间。
- 衣物均匀放置并且洗衣机安放平稳了吗？
要洗的衣物必须均匀放置并且不能超载。
洗衣机必须安放安稳。前脚必须正确安装并旋紧螺母。重设后面平衡脚（如果需要）。参看安装说明。
- 洗涤时洗衣篮移动着
这是正常现象。

搅拌机工作

- 搅拌机顶部是松动的，或者只有一个方向转。
这是正常的。

分配器堵塞或者漂白剂漏了

- 您按照制造商的说明往分配器里加洗洁剂和柔顺剂了吗？
量好洗洁剂和柔顺剂。慢慢倒入分配器里，拭干所有溅出的点。
在分配器内稀释柔顺剂。
- 您往液体氯漂白剂分配器内加入粉状或者不退色漂白剂了吗？
将粉状或者不退色漂白剂直接加入到洗衣篮内。不要在氯漂白剂分配器内使用不退色漂白粉

衣物太湿

- 您使用正确的循环过程了吗？
选择一个有高速脱水的循环过程（如果有的话）
- 您使用冷漂洗吗？
冷漂洗的衣物会比用温水洗的衣物更加潮湿。这很正常。

衣物上有残渣或者棉绒

- 您正确分类了吗？
将散棉类（毛巾、绒织物）与吸棉类衣物（灯芯绒，合成纤维）分开。同样也要按颜色分类。
- 衣物是否超载？
要洗涤的衣物要均匀安放并且不能超载。如果超载了，就会有堆积的棉绒。适当减少衣物。
- 检查以下方面：
口袋里有纸张或者纸巾吗？
您有使用足够的洗洁剂吗？请遵循制造商的说明。请使用足够的洗洁剂来收拢水里的棉绒。
你的水温低于 15.6°C 吗？如果水温低于 15.6°C，洗洁剂无法完全溶解。

衣物上有污点

- 加入洗洁剂和柔顺剂的时候，您有遵循制造商的说明吗？
量好洗洁剂和柔顺剂。使用足够的洗洁剂来去除污点并让那些污物漂浮着。
稀释柔顺剂并只有在漂洗过程才加入。不要将柔顺剂倒在衣服上面。
- 水里有超常铁锈吗
您可能需要安装一个过滤器。
- 您有给衣物适当分类吗？
将黑色与白色和浅色的衣服分开。
- 您有正确取出衣物吗？
要避免染色，当洗衣机停止的时候，尽快将衣物取出。

衣物褶皱

- 您尽快取出衣物了吗？
当洗衣机停止的时候，尽快将衣物取出。
- 您有使用正确的洗衣循环过程
使用偶尔 / 免烫洗衣过程或者其他慢速脱水的过程（如果有的话），以减少褶皱
- 您有装入过量衣物吗？
装载的衣物必须是均匀放置并且不要超载。衣物在洗涤的时候必须能够自由移动。
- 洗涤的水温足够缓解褶皱或者您有使用温水漂洗吗？
如果对衣物安全，请使用热水或者温水洗涤。使用冷水漂洗。
- 热水管和冷水管装错了吗？
检查热水管和冷水管接到正确的水笼头。请参看安装说明

衣物缠结或扭绞在一起

- 您装入过量衣物了吗？
装载的衣物必须是均匀放置并且不要超载。衣物在洗涤的时候必须能够自由移动。
- 搅拌机周围有绞住的衣物吗？
将衣物宽松地放进洗衣机内。不要将衣物缠绕在搅拌机上。

灰白色，深色的

- 您给衣物适当分类了吗？
如果将白色的衣物和其他颜色的衣物混和，可能会发生染色现象。将深色和白色浅色的衣物分开。
- 洗衣机的温度太低了吗？
如果衣物安全，请使用热水或温水。确信您的热水系统足够提供热水洗涤。
- 您使用足够的洗洁剂，或者您有硬水吗？
如果是硬水或者对于极度肮脏的衣物，请使用更多的洗洁剂。
- 热水管和冷水管装错了吗？
检查热水管和冷水管接到正确的水笼头。请参看安装说明。

衣物损坏

- 请检查以下方面：
在洗衣前取出口袋你的锐利东西了吗？洗涤前，请清空口袋、拉好拉链、扣好弹簧扣或者钩子。
绳子或者腰带扣好避免绞着了吗？
衣物在洗衣前就已经损坏了吗？在洗涤前请缝好裂缝和破口。
- 您装入过量衣物了吗？
装载的衣物必须是均匀放置并且不要超载。衣物在洗涤的时候必须能够自由移动
- 您正确加入氯漂白剂了吗？
请不要将氯漂白剂直接倒在衣物上。擦拭掉氯漂白剂的溅点。没有稀释的漂白剂会损坏衣物。
- 您遵循制造商标签上的洗涤说明了吗？

帮助或服务

在您呼叫帮助或者服务之前，请检查“故障解决”里的内容。也许可以解决问题而不需要呼叫服务。如果您还是需要帮助，请联系您所购买洗衣机的经销商，或者惠而浦指定的服务商。

在您呼叫服务时，请准备好您的购买电器的日期和完整型号及系列码。这些信息可以更好的让我们对您的要求做出反应。

如果您需要更换部件

如果您需要更换部件，我们推荐你仅使用工厂特别指明的部件。这些部件可以正常工作因为他们是专门以统一规格制作的，适合每个新的 WHIRLPOOL® 电器。

想知道提供您需要部件的当地地址：

请联系您购买洗衣机的经销商，或者惠而浦指定的服务公司。

WHIRLPOOL® 惠而浦 洗衣机

技术规格

工作频率	50 Hz
电流	5.0 A
电压	220 V~
高	108 cm
宽	68 cm
深	65 cm
最大进水水压	690 kPa
最小进水水压	34.5 kPa
洗涤时的最大噪音水平	62 dBa
脱水时的最大噪音水平	72 dBa

W10096630

© 2006 Whirlpool Corporation.
All rights reserved. 保留所有权利。

® Registered Trademark/TM Trademark of Whirlpool, U.S.A.
保留所有权利® 注册商标 Whirlpool, 美国

7/06
Printed in U.S.A.
印于美国

Free Manuals Download Website

<http://myh66.com>

<http://usermanuals.us>

<http://www.somanuals.com>

<http://www.4manuals.cc>

<http://www.manual-lib.com>

<http://www.404manual.com>

<http://www.luxmanual.com>

<http://aubethermostatmanual.com>

Golf course search by state

<http://golfingnear.com>

Email search by domain

<http://emailbydomain.com>

Auto manuals search

<http://auto.somanuals.com>

TV manuals search

<http://tv.somanuals.com>