

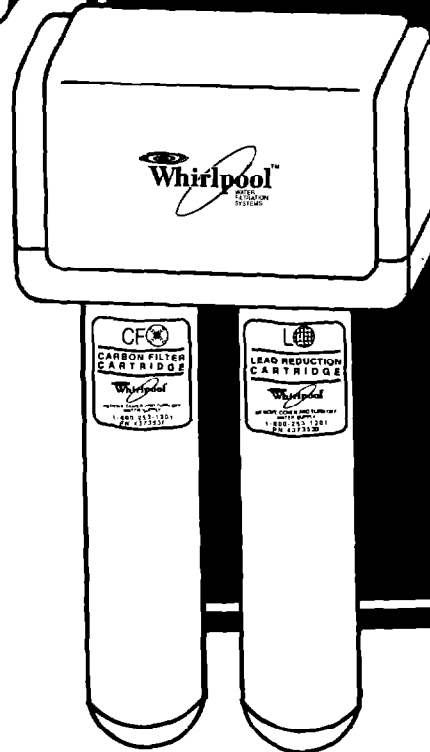

Fresh Clean Water

Use & Care Guide and Installation Instructions

WHIRLPOOL
UNDERCOUNTER
WATER FILTRATION
SYSTEMS I, II, & III

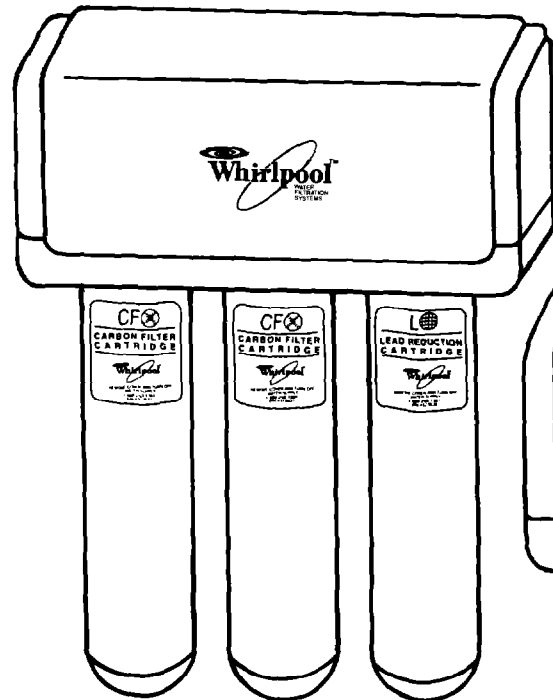

5-97

Water Filtration System Parts

Remove parts from packages.
Check that you have all the parts.

filtration assembly System I (A)
filtration assembly System II (B)
filtration assembly System III (C)
filtration assembly cover (D)
2 mounting screws (E)
1/4" blue tubing (F)
1/4" orange tubing (G)
2-way grey connector with push-in ends (H)
saddle valve assembly (I)
insert (J)
plastic sleeve (K)
brass compression nut (L)
literature package

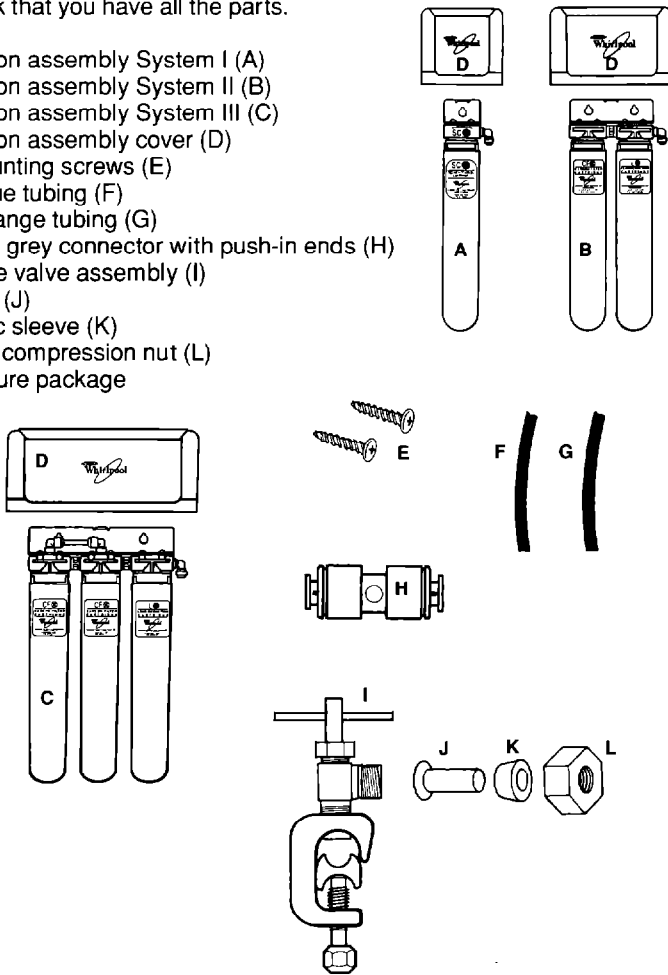

NOTE:

Some state and local plumbing codes prohibit the use of saddle-type valves. The use of saddle-type valves is prohibited in: Alaska, Delaware, Idaho, Kentucky, Massachusetts, Michigan, Minnesota, New Hampshire, North Dakota, Ohio, Oregon and South Dakota. Check your local plumbing codes for details.

Massachusetts CMR 248 strictly prohibits the use of saddle-type valves. The feed-water connection must conform to applicable plumbing codes.

Tools Needed for Installation

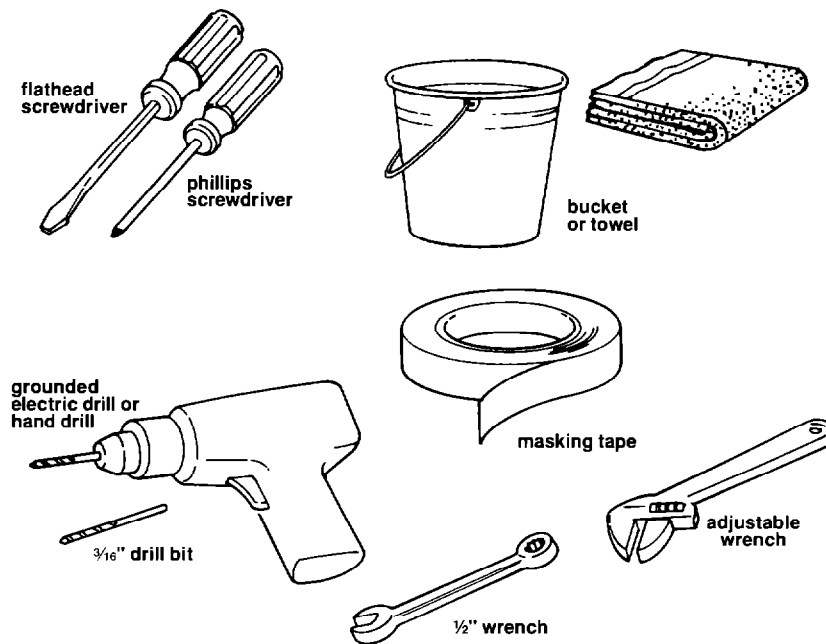

Materials Needed for Basement Installation

- step ladder
- Additional tubing, Part No. 4319151 available from your Whirlpool dealer.
- 1/4" drill bit
- safety glasses

Materials Needed for Optional Sink Faucet Installation

Sink faucet, Part No. 4319154, available from your Whirlpool dealer. Includes: faucet base with blue tubing attached, assembly hardware, faucet spout, 2-way grey connector with push-in ends, and a "T" grey connector with push-in ends.

Open This Flap For Installation Overview

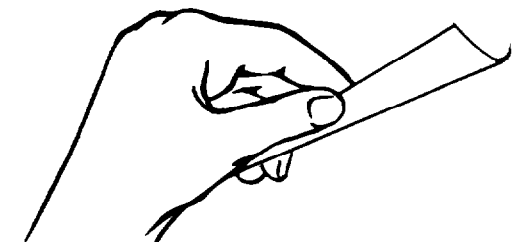

Installation Overview

Before You Start...

IMPORTANT: Read and save these instructions.

It is recommended that this system be installed by a licensed plumber.

It is the responsibility of the installer to comply with the installation specifications provided and with state and local plumbing codes.

If you decided to install the system yourself, see "General Information" on page 9 before continuing.

Water Filtration Systems I, II and III can be installed in the basement if there is not adequate room for under-sink installation. Order additional tubing, Part No. 4319151 from your Whirlpool dealer.

DO NOT use filtration system if water is micro-biologically unsafe or water quality is unknown.

If you need assistance...

Refer to the Use & Care information at the end of this booklet. If you need more help, the Whirlpool Consumer Assistance Center will answer any questions you may have about operating or maintaining your water filtration system. The Whirlpool Consumer Assistance Center is open 24 hours a day, 7 days a week. Just dial **1-800-253-1301**—the call is free. When you call, you will need the water filtration system model number and serial number. Both numbers can be found labeled on the filtration assembly.

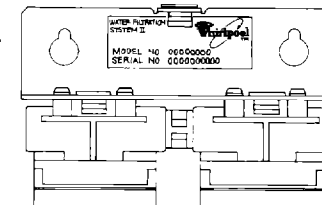

Water Filtration Systems I, II & III

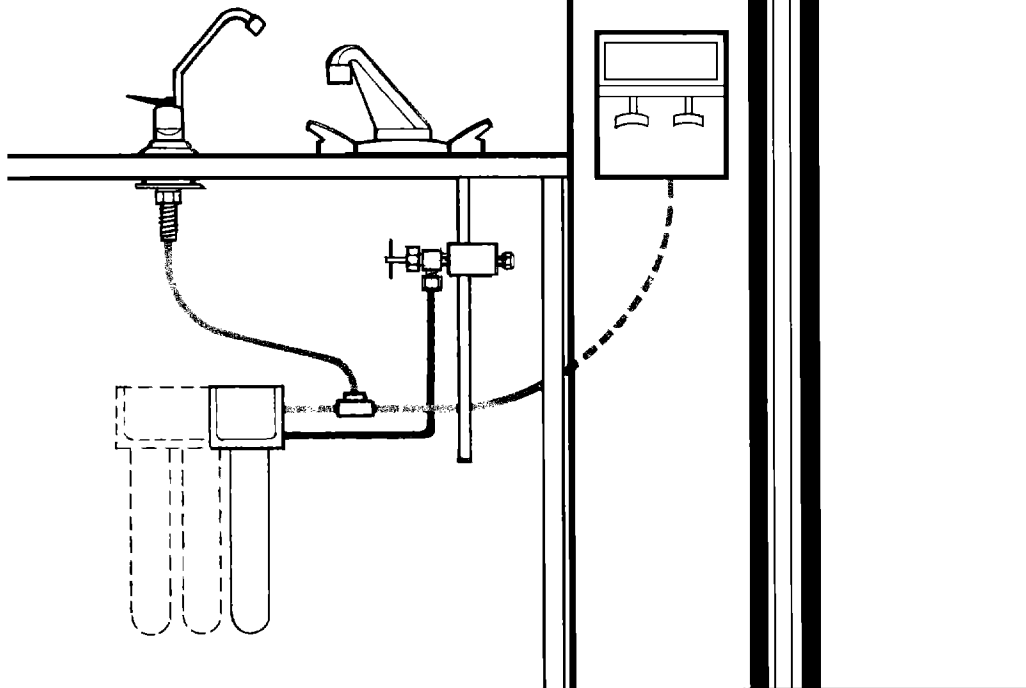

HOOK UP WATER

- Turn off cold water supply.
- Turn on faucet to drain water from line.
- Connect saddle valve to cold water supply. Turn saddle valve handle clockwise until piercing lance enters pipe and stops.
- Connect one end of orange tubing to saddle valve. Connect other end to filtration assembly.

SYSTEM CONNECTION

- Decide if the system will be connected to your refrigerator, to an optional faucet or to both.
- Connect refrigerator's water supply to filtration assembly with blue tubing.
- Or, install faucet in sink and connect blue tubing to filtration assembly.
- Or, use "T" grey connector to connect both refrigerator and faucet.

START UP

- Slide filtration assembly onto mounting screws.
- Turn on cold water supply.
- If filtration assembly was connected to refrigerator, make and discard 2 batches of ice and drain 2-3 gallons of water from water dispenser.
- If filtration assembly was connected to sink faucet, lift faucet handle to discard 2-3 gallons of water.

Instructions At A Glance • For detailed instructions see following page.

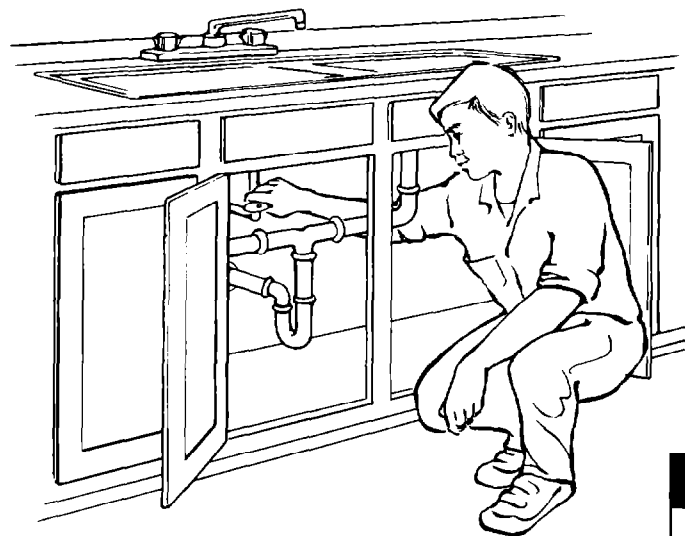

1. Turn off cold water supply. (Steps 1a-1b)

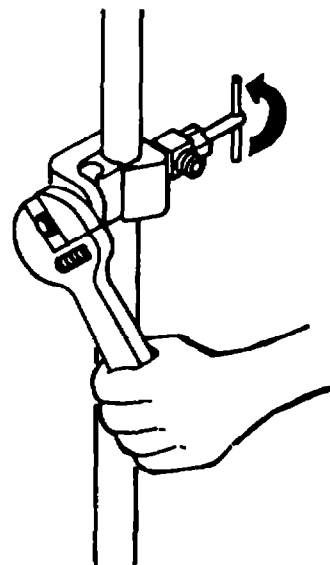

3. Connect saddle valve to cold water supply. Turn saddle valve handle clockwise until piercing lance enters pipe and stops. (Steps 1c-1g or 1h-1j)

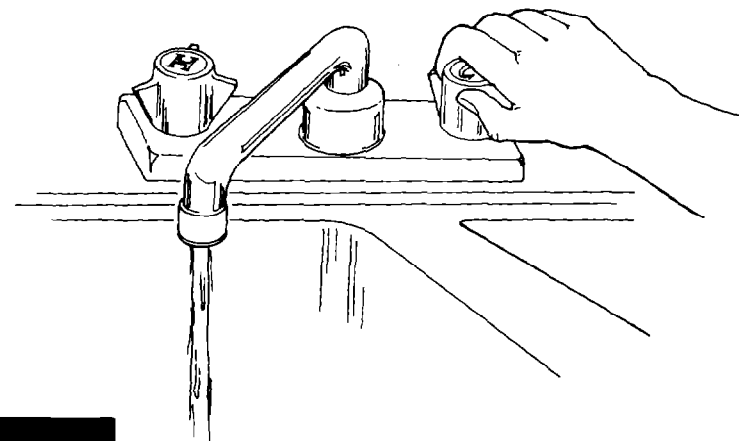

2. Turn on faucet to drain water from line. (Step 1b)

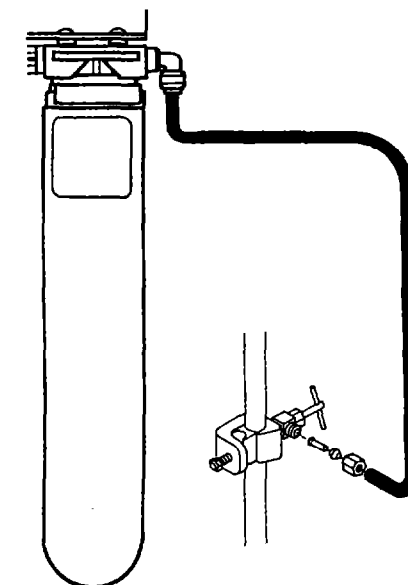

4. Connect one end of orange tubing to saddle valve. Connect other end to filtration assembly. (Step 1k)

! WARNING

Electrical Shock Hazard

Special care must be taken when drilling into water pipes. Some water may remain in water supply pipe:

- If an electric drill is used, it must be properly grounded to prevent severe or lethal shock if water should enter drill.
- Use only an electric drill that is double insulated or properly grounded.
- Check with qualified electrician if you are in doubt as to whether your electric drill is properly grounded.
- Only drill at top or side of horizontal water supply pipe. DO NOT drill at bottom of horizontal pipe where water may remain.

Failure to follow these instructions could result in personal injury or death.

Hook Up Water

! CAUTION

Product Damage

DO NOT connect to a hot water supply line. Failure to follow this instruction could result in product damage.

1a. Take note of water requirements listed under the Use & Care section of this booklet. The filtration system's feed line (orange tubing) connects to your cold water supply line using the saddle valve.

Do not use saddle valve if it is prohibited by your state or local plumbing codes.

The saddle valve is for use with $\frac{3}{8}$ " to $\frac{5}{8}$ " outer diameter (O.D.), soft copper pipe (plain or chrome plated) or rigid metal or plastic pipe. **Important: DO NOT use the saddle valve on flexible ribbed tubing.** The wall thickness of flexible ribbed tubing is thin and will not support the saddle valve supplied.

If your cold water supply is connected to the cold water faucet with flexible ribbed tubing, contact your local plumbing supply distributor to obtain special connecting hardware.

Important: If local codes do not permit the use of saddle valves, special feed valves can be obtained from your local plumbing supply distributor. Use only $\frac{1}{4}$ " polyethylene tubing for water line connection.

! CAUTION

Property/Product Damage

- **DO NOT install tubing in an area where temperatures drop below 32°F.**
- **DO NOT overtighten saddle valve to copper pipe. This will crush pipe.**
- **Keep a bucket or towel under area where saddle valve connection is made.**

Failure to follow these instructions may result in water damage to property or product damage.

1b. **Turn off cold water supply.** Turn on cold water faucet and allow all water to drain from line. Turn off faucet. Determine if your cold water supply line is soft copper pipe or rigid metal or plastic pipe. If your cold water supply line is soft copper pipe, proceed to step 1c. If your cold water supply line is rigid metal or plastic pipe, skip ahead to step 1h.

1c. **Connect saddle valve to cold water supply soft copper pipe.** Check that saddle valve piercing lance does not protrude beyond rubber gasket. If it is protruding, carefully push it in flush with the rubber gasket, using a hard object like the end of a screwdriver handle.

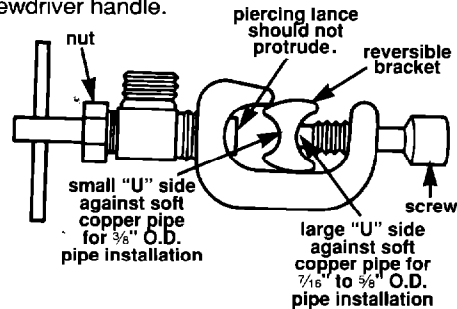

1d. Assemble saddle valve on copper pipe. Saddle valve must be on top side of horizontal pipe or side of vertical pipe to keep sediment from collecting in its valve.

If you are connecting the saddle valve to $\frac{3}{8}$ " O.D. copper pipe, assemble bracket with small "U" side against copper pipe to prevent distortion of pipe. If you are connecting the saddle valve to $\frac{7}{16}$ " to $\frac{5}{8}$ " O.D. pipe, assemble bracket with large "U" side against copper pipe.

1e. Tighten bottom screw firmly. **DO NOT** overtighten; copper pipe could be crushed.

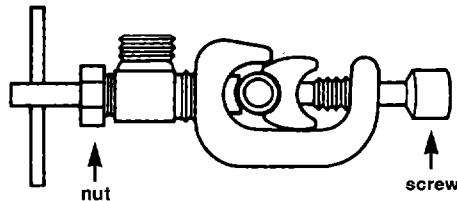

1f. Have a towel ready in case of leakage. Turn saddle valve handle clockwise until the lance pierces soft copper pipe and then stops. Do not continue to turn the saddle valve handle after it has stopped because you may pierce through the opposite side of pipe. The saddle valve is now in the closed position.

1g. Turn on cold water supply to check for leaks. In case of leaks, use an adjustable wrench to tighten nut below valve's handle. Turn cold water back off and proceed to step 1k.

1h. **Connect saddle valve to cold water supply rigid metal or plastic pipe.** Use a grounded electric drill or a hand drill to drill $\frac{3}{16}$ " hole in top side of horizontal pipe or side of vertical pipe. This will keep sediment from collecting in valve. Turn saddle valve handle clockwise to expose piercing lance a maximum of $\frac{3}{16}$ " beyond the rubber gasket. Align piercing lance over hole you drilled in pipe. Then assemble saddle valve on pipe with large "U" side against pipe.

1i. Tighten bottom screw firmly, keeping bracket parallel to pipe. Turn saddle valve handle clockwise until piercing lance enters hole in pipe and then stops. The saddle valve is now in the closed position.

1j. Have a towel ready in case of leaks. Turn on cold water supply to check for leaks. In case of leaks, use an adjustable wrench to tighten nut below valve's handle. Turn cold water back off.

1k. Remove cover from filtration assembly by lifting straight up. Move filtration assembly near

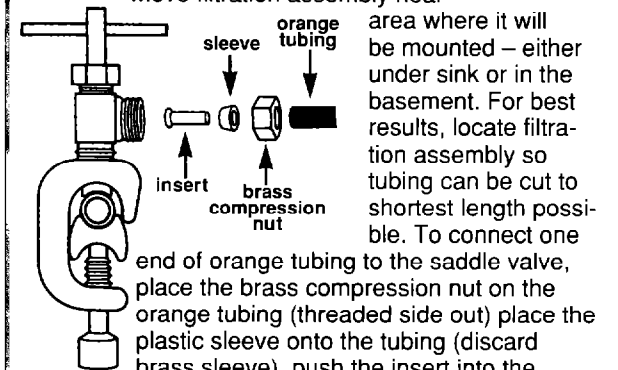

area where it will be mounted – either under sink or in the basement. For best results, locate filtration assembly so tubing can be cut to shortest length possible. To connect one end of orange tubing to the saddle valve, place the brass compression nut on the orange tubing (threaded side out) place the plastic sleeve onto the tubing (discard brass sleeve), push the insert into the tubing and thread this assembly onto the opening of the saddle valve. Tighten brass compression nut with $\frac{1}{2}$ " wrench.

Use a plastic tubing cutter or sharp razor knife to cut tubing to shortest possible length. Make sure cut end is clean and blunt and tubing is round. Push free end of orange tubing as far as it will go into the grey push-in fitting on the front right side of the filtration assembly.

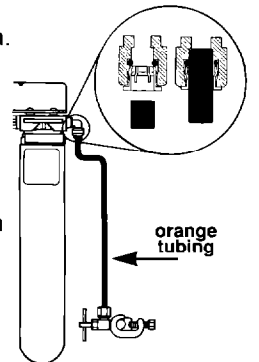

System Connection

Instructions At A Glance • For detailed instructions see following page.

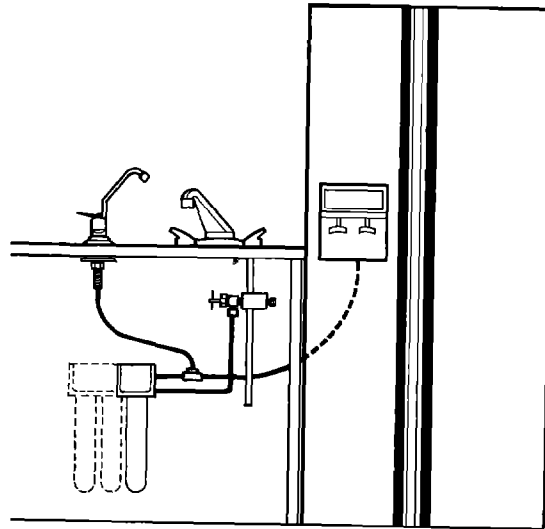

1. Decide if the system will be connected to your refrigerator, to an optional faucet or to both. (Step 2a)

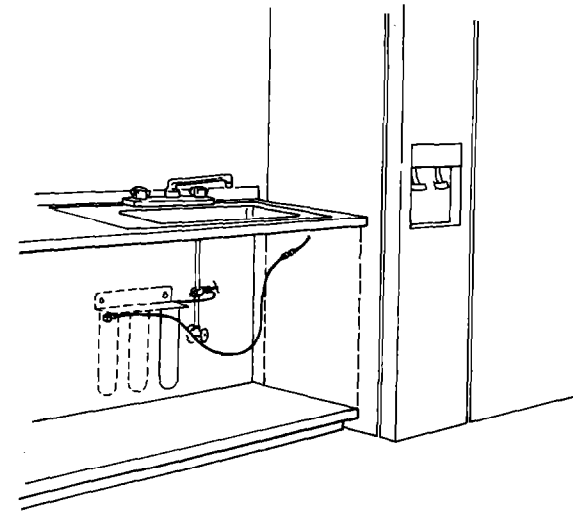

2. Connect refrigerator's water supply to filtration assembly with blue tubing. (Steps 2b-2c)

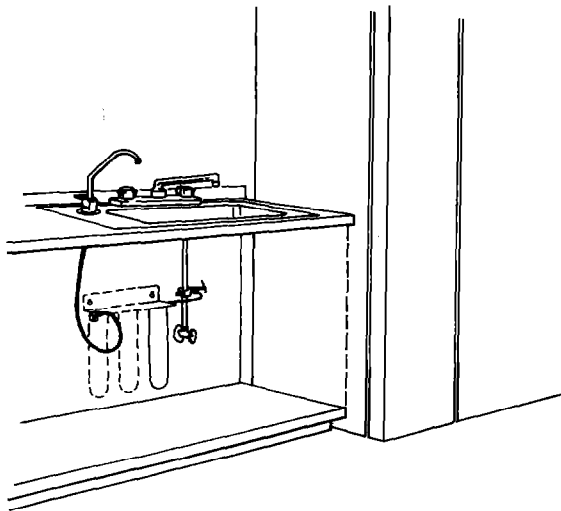

3. Or, install faucet in sink and connect blue tubing to filtration assembly. (Steps 2d-2g)

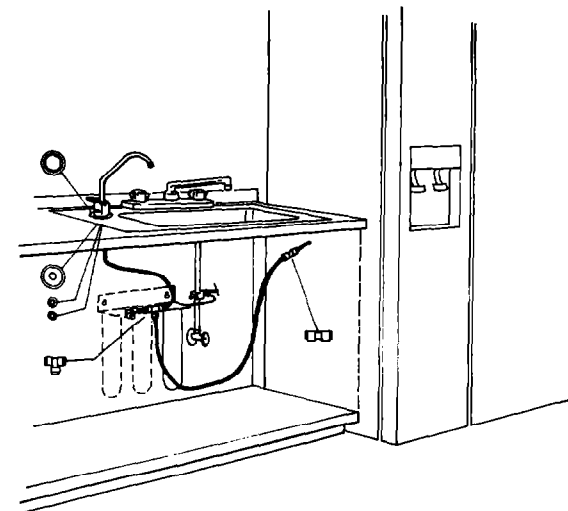

4. Or, use "T" grey connector to connect both refrigerator and faucet. (Steps 2h-2i)

System Connection

- 2a.** You have three installation options:
1. Connect water supply from filtration system to refrigerator's ice and water only.
 2. Connect water supply from filtration system to optional sink faucet only.
 3. Connect water supply from filtration system to both refrigerator and optional sink faucet.

All parts are included with this kit to connect refrigerator. If you choose to connect filtration system to a sink faucet, order sink faucet, Part No. 4319154, available from your Whirlpool dealer. This kit includes: faucet assembly with blue tubing attached, assembly hardware, faucet spout, 2-way grey connector with push-in ends, and a "T" grey connector with push-in ends. This "T" grey connector with push-in ends will allow you to connect filtration assembly to both the faucet and the refrigerator.

2b. Connect system to refrigerator only. Remove and discard short piece of blue tubing from grey connector with push-in end on the back of filtration assembly. Insert one end of long piece of blue tubing into this grey connector with push-in end. Run the blue tubing from the filtration assembly to the refrigerator.

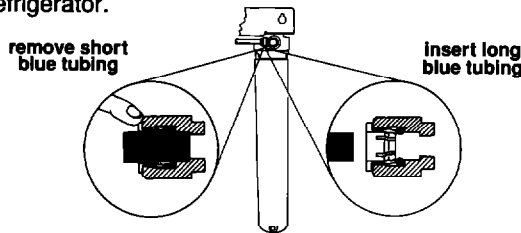

2c. Route blue tubing to rear of refrigerator. Cut blue tubing to shortest possible length. Insert free end of blue tubing into the 2-way grey connector with push-in ends as far as it will go. Turn off refrigerator water supply and ice maker. Press refrigerator water dispenser to empty water into a container. Disconnect main water supply from refrigerator's water line. Seal main water line hole because it will no longer be connected to refrigerator. Make sure the refrigerator water line has a square cut. Then insert refrigerator water line into other end of the 2-way grey connector with push-in ends. Proceed to step 3.

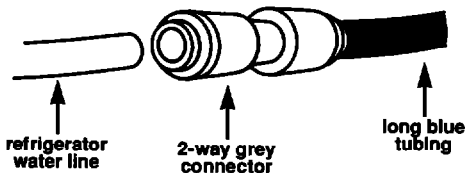

2d. Connect system to optional sink faucet only. A $\frac{3}{16}$ " diameter opening in the sink is required to install the optional sink faucet.

Important: If you do not have an existing sink opening, contact a qualified installer or licensed plumber to cut an opening in your sink.

! CAUTION

Property Damage

- Contact a qualified installer or licensed plumber for cutting a faucet opening in your sink.
- Failure to do so may result in damage to the sink.

2e. Remove and discard short clear piece of tubing from top of faucet base and push faucet spout into this opening. Place the escutcheon plate and black rubber washer on the faucet's threaded nipple. Note: Rubber washer may be removed and replaced with a bead of plumber's putty for a neater appearance. Feed blue tubing through sink hole. Position faucet spout over sink. Working below the sink, secure faucet with black plastic washer, locking washer and nut.

Side view of faucet

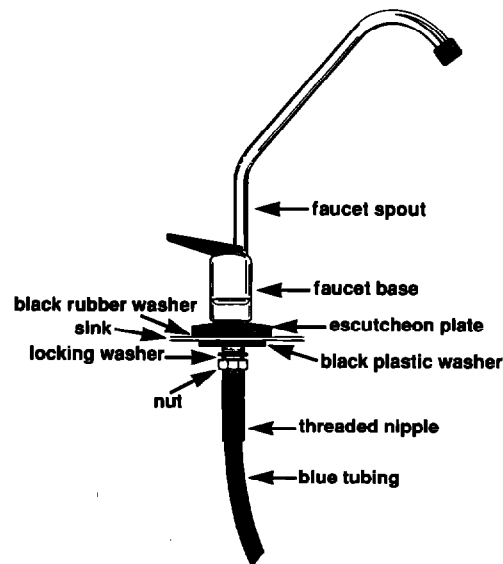

2f. Recheck faucet position. If position needs minor adjusting, wrap the flat chrome sides of faucet and the crescent portion of the crescent wrench with masking tape to protect the chrome from scratches. Use the wrench on flat sides of faucet to reposition faucet. Remove masking tape.

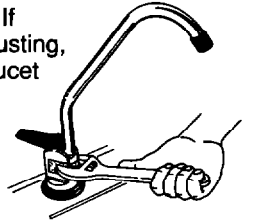

2g. Remove and discard short piece of blue tubing from grey connector with push-in end on the back of filtration assembly. Cut blue tubing from faucet to shortest possible length. Insert free end of faucet's blue tubing into this grey connector with push-in end. Proceed to step 3.

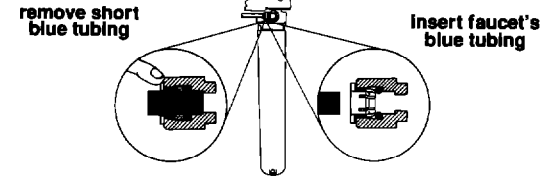

2h. Connect system to refrigerator and optional sink faucet. Follow steps 2d through 2f for faucet installation. It is strongly recommended that only a licensed plumber or professional installer cut an opening in the sink. Cut blue tubing from faucet to shortest possible length. Push the faucet's blue tubing as far as it will go onto one end of the "T" grey connector. Push the other end of the "T" grey connector as far as it will go onto the short piece of blue tubing on the back of the filtration assembly. Push the long piece of blue tubing onto the center push-in end of the "T" grey connector.

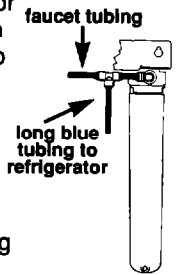

2i. Route blue tubing to refrigerator. Cut blue tubing to shortest possible length. Insert free end of blue tubing into the 2-way grey connector with push-in ends as far as it will go. Turn off refrigerator water supply and ice maker. Press refrigerator water dispenser to empty water into a container. Disconnect main water supply from refrigerator's water line. Seal main water line hole because it will no longer be connected to refrigerator. Make sure the refrigerator water line has a square cut. Then insert refrigerator water line into other end of the 2-way grey connector with push-in ends. Proceed to step 3.

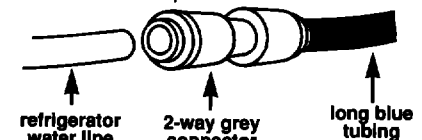

Start Up

Instructions At A Glance • For detailed instructions see following page.

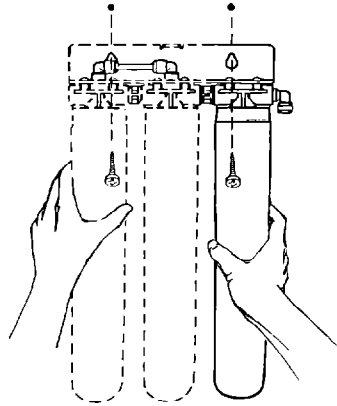

**1. Slide filtration assembly onto mounting screws.
(Steps 3a-3c)**

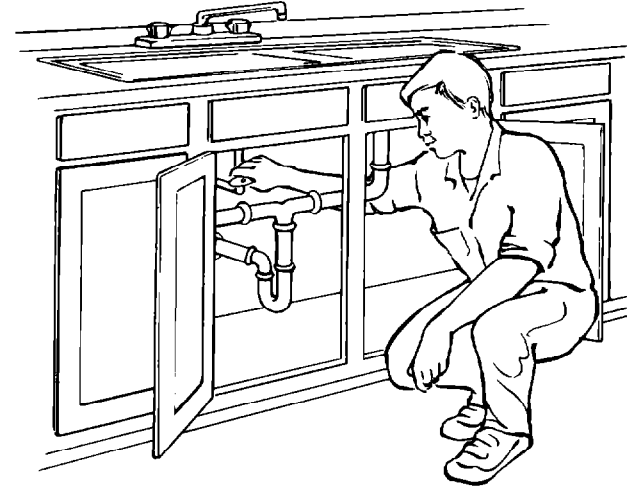

2. Turn on cold water supply. (Step 3d)

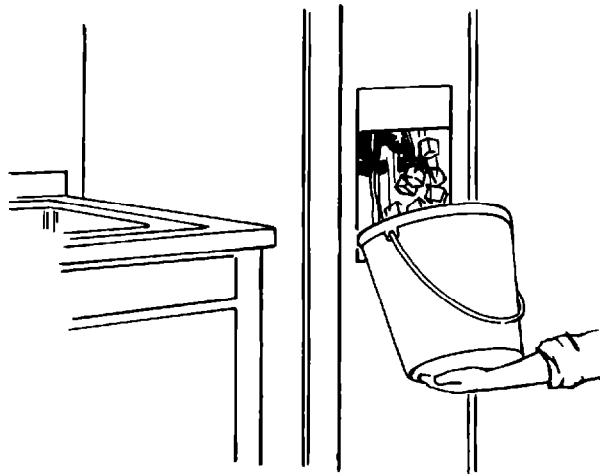

**3. If filtration assembly was connected to refrigerator,
make and discard 2 batches of ice and drain
2-3 gallons of water from water dispenser. (Step 3e)**

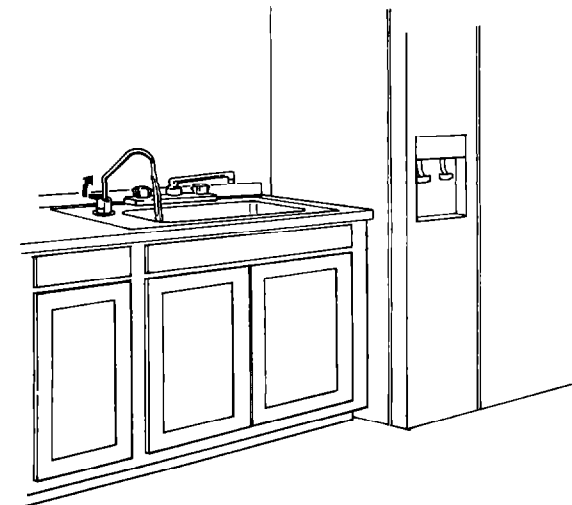

**4. If filtration assembly was connected to sink faucet, lift
faucet handle to discard 2-3 gallons of water. (Step 3f)**

Start Up

! WARNING

Electrical Shock Hazard

Special care must be taken when drilling into walls. Electrical wires may be concealed behind the wall covering:

- Use only an electric drill with a 3-wire power supply cord connected to a grounded receptacle.
- Check with qualified electrician if you are in doubt as to whether your electric drill is properly grounded.

Failure to follow these instructions could result in personal injury or death.

- 3a.** Mount filtration assembly:
- Solid Construction Cabinet:** Position the filtration assembly on either the right or left cabinet wall and allow a minimum of 2" clearance above the cabinet floor. Mark the location of the filtration system's bracket holes, then set the filtration assembly aside and skip ahead to step 3b.
- Non-solid Construction Cabinet:** Replace filtration assembly's cover. Position the filtration assembly on the cabinet floor along either the right or left cabinet wall. Skip ahead to step 3c.
- Basement Installation:** Position the filtration assembly on wood floor supports or on basement wall. Mark the location of the filtration assembly's bracket holes, then set the filtration assembly aside. Additional tubing may be required and is available from your local plumbing distributor or from your Whirlpool dealer. Continue with step 3b.

- 3b.** Drill pilot holes for the mounting bracket at the locations you've marked. Insert mounting bracket screws in holes and tighten, leaving a slight gap between screw head and wall.

For basement installation and solid construction cabinet installation, place filtration assembly mounting bracket on mounting screws and tighten screws until filtration assembly is secure and replace cover.

- 3c.** Make sure all tubing connected to grey push-in connectors is tight (pushed in as far as it will go) and that tubing does not bind or kink anywhere. Also make sure tubing does not interfere with cabinet storage areas. Tubing may be cut to a shorter length if necessary. Tubing may be secured to cabinet walls with insulated staples as long as staples do not crush or puncture tubing.

- 3d.** Place a towel or bucket under saddle valve, then turn on cold water supply and saddle valve and check for leaks.

- 3e.** If filtration assembly was connected to refrigerator, let ice maker produce two batches of ice and discard both batches. This will flush the line of any accumulated particles. If the refrigerator has a water dispenser, flush the line by dispensing 2-3 gallons of water.

- 3f.** If optional sink faucet was installed, lift faucet handle and dispense and discard the first 2-3 gallons of water. To get filtered water hold the faucet handle down for momentary flow, or hold the faucet up for continuous flow. To stop water flow from the faucet, return the faucet to the center or horizontal position.

General Information

- Due to shipping, some carbon grains may appear in the first few gallons of water through your filtration system. Simply flush the system until water becomes clear.
- This system can be connected to two dispensing points (including the optional sink faucet). We do not recommend installing this water filtration system to your existing tap faucet as the flow rate will be reduced to .6 gallons per minute.
- Remember to cut all tubing to the shortest possible length to maximize your flow rate.
- **Maintenance of this water filtration system is very important.** Replace the Sediment (S), Lead Reduction (L), and Carbon Filter (CF) cartridges annually. Failure to maintain this water filtration system over an extended period of time could present health risks.

Use & Care Information

Water Requirements

The filtration system must be connected to a cold water supply line providing 30-100 psi water pressure. The water temperature must be between 40°-100°F. Community or private well water must be potable (suitable for drinking).

! WARNING

Personal Injury Hazard

DO NOT use water filtration system if water is microbiologically unsafe or water quality is unknown. Failure to follow these instructions could result in personal injury.

General tips

- To correct a leaky saddle valve, turn off cold water supply and make sure bottom screw is tightened evenly and firmly. **DO NOT** overtighten, you could crush the pipe. Then make sure the nut below the saddle valve's handle is tight. If not, tighten it with a 7/8" wrench.
- If the threaded portion of the brass compression nut that is attached to the saddle valve leaks, turn off saddle valve and remove the nut, wrap Teflon tape around the threaded portion 2-4 times. Reconnect the nut.
- If a leak should occur at a push-in connector, the cause is usually defective tubing. To correct the

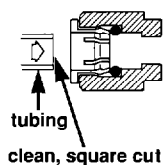
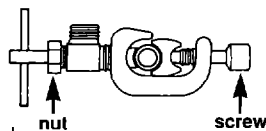

problem, turn off water supply to the system either at the saddle valve or other existing water valve. Push in the grey push-in connector and hold; then pull the tubing out of the connector. Cut at least 1/4" from the end of the tubing using a plastic tubing cutter or a sharp razor knife. Make sure the cut end is clean and blunt and that tubing is round. Reinsert tubing as far as it will go. Turn on water supply at valve.

- If the refrigerator tubing leaks at the push-in connector, the refrigerator's water line metal tubing may be grooved or deformed. To correct the problem, turn off water supply to the system either at the saddle valve or other existing water valve. Press refrigerator water supply or optional sink faucet to drain water from system. Wait five minutes for filtration assembly to depressurize. Push in the grey push-in connector and hold; then pull the tubing out of the connector. Cut at least 1/4" from the end of the tubing to create a new smooth end or replace if necessary.

- If a cartridge head leaks, it may have a misaligned, pinched or damaged O-ring. Shut off the saddle valve or other existing water valve. Press refrigerator water supply or optional sink faucet to drain water from system. Wait five minutes for filtration assembly to depressurize. Turn filter cartridge 1/4 turn to the left and remove. Replace the O-ring if it is misaligned, pinched or damaged.

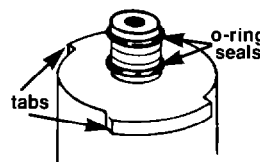
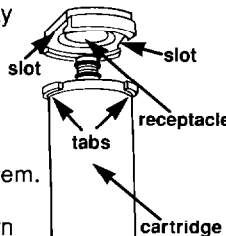

Maintaining your water filtration system

The maximum length of time a filter cartridge should be used is one year. Cartridges should be replaced every 500 gallons, but exactly how often cartridges are replaced will depend on local water conditions. Private wells may require more frequent cartridge replacement while softened water systems may require cartridge replacement only once a year.

Cartridge	Replace at least	Or replace if or when...
Sediment (SC)	Once/year or every 1,000 gals.	<ul style="list-style-type: none"> Water supply is cloudy, has high dirt and rust content (change every six months) Water amount or flow from faucet is noticeably reduced Water supply smells of chlorine
Lead Reduction (L)	Once/year or every 500 gals.	<ul style="list-style-type: none"> Water supply smells of chlorine or water has high dirt and rust content (change every six months)
Carbon (CF)	Once/year or every 500 gals.	<ul style="list-style-type: none"> Water has "off" taste or odor

Maintenance of this water filtration system is very important. Replace the Sediment (S), Lead Reduction (L), and Carbon Filter (CF) cartridges annually. Failure to maintain this water filtration system over an extended period of time could present health risks.

Replacing filter cartridges

- Turn off water supply at either saddle valve or main shut-off. Press refrigerator water dispenser to empty water into a container. If using the optional sink faucet, turn on faucet to drain any water in system. Discard this water. Wait five minutes for filtration assembly to depressurize.
- Lift cover off filtration assembly. Rotate cartridge one-quarter turn to the left to remove connector tabs from receptacle. Gently pull down to remove cartridge.
- Check that label on new cartridge matches label above cartridge receptacle. Remove red cap from cartridge. Wet O-ring seals of new cartridge with a little water. Line up the tabs at the top of the new cartridge with the slots in the filtration assembly's receptacle. Push cartridge up and turn it 1/4 turn to the right to lock it into place. Cartridge label must face front. Pull down on cartridge to make sure it's firmly in place. Repeat step if cartridge disconnects.
- Turn water supply back on and check for leaks. Open faucet and allow water to run for 5 minutes to check system for leaks. If water is leaking, shut off water and recheck connections. Replace cover.

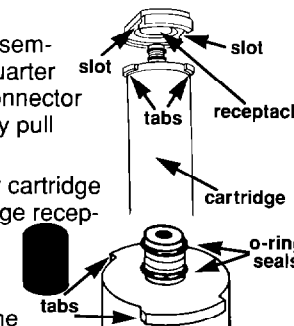

Preparation for long periods of non-use

Follow these instructions if system will not be used for more than 30 days.

- Turn off water supply at either saddle valve or main shut-off. Press refrigerator water dispenser to empty water into a container. If using the optional sink faucet, turn on faucet to drain any water in system. Discard this water. Wait five minutes for filtration assembly to depressurize.
- Remove all cartridges and place upside down in sink or bucket to drain water from cartridges. Place cartridges in plastic bag and seal tightly. Place bag with cartridges in refrigerator. Do Not allow cartridges to freeze.

Using water filtration system after long periods of non-use

- Follow instructions for replacing cartridges.
- Follow "Start Up" instructions (3e and 3f).

Call 1-800-253-1301 to order.

Replacement Parts & Accessories	
System I Replacement Cartridge Kit Kit includes Sediment/Carbon (SC) Cartridge	4373529
System II Replacement Cartridges Kit Kit includes Lead Reduction (L) and Carbon Filter (CF) Cartridges. Cartridges can also be ordered individually.	4373573
System III Replacement Cartridge Kit Kit includes Lead Reduction (L) and two Carbon Filter (CF) Cartridges. Cartridges can also be ordered individually.	4373574
Sediment/Carbon (SC) Cartridge	4373529
Lead Reduction (L) Cartridge	4373530
Carbon Filter (CF) Cartridge	4373531
Connector with Push-in Ends	4319153
Faucet Assembly	4319154
System III Filtration Assembly Cover	4373563
System II Filtration Assembly Cover	4373564
System I Filtration Assembly Cover	4373565
Saddle Valve	4373572
Additional Parts Needed for Multiple Connections:	
1/4" Tubing	4319151
" T" Connector with Push-in Ends	4319152
Additional tubing for basement installation	4319151

If You Need Assistance...

The Whirlpool Consumer Assistance Center will answer any questions about operating or maintaining your water filtration system not covered in the Installation Instructions and Use and Care Guide. The Whirlpool Consumer Assistance Center is open 24 hours a day, 7 days a week. Just dial **1-800-253-1301** – the call is free. When you call, you will need the water filtration system model number and serial number. Both numbers can be found labeled on the filtration assembly.

How To Arrange For Service...

In the event that your Whirlpool appliance should ever need service, call the dealer from whom you purchased the appliance or a Whirlpool-authorized service company. A Whirlpool-authorized service company is listed in the Yellow Pages of your telephone directory under "Appliances—Major—Service or Repair." You can also obtain the service company's name and telephone number by dialing, free within the continental United States, the Whirlpool Consumer Assistance Center telephone number, **1-800-253-1301**. A special operator will tell you the name and number of your nearest Whirlpool-authorized service company.

Maintain the quality built into your Whirlpool appliance – call a Whirlpool-authorized service company.



WATER FILTRATION SYSTEM I
MODEL NO. WSC100YW

REPLACEMENT CARTRIDGE: WHIRLPOOL SC FSP# 4373529

RATED SERVICE FLOW – 0.6 gpm (2.28 lpm)
MAX. OPERATING PRESSURE –100 psig (862 kPa)
MAX. OPERATING TEMPERATURE 100°F (38°C)

NOTICE: ACTIVATED CARBON FILTERS ARE NOT INTENDED FOR USE WITH WATER THAT IS MICROBIOLOGICALLY UNSAFE OR WITH WATER OF UNKNOWN QUALITY WITHOUT ADEQUATE DISINFECTION BEFORE OR AFTER THE UNIT. PLEASE READ THE PERFORMANCE DATA SHEET.

THIS PRODUCT HAS BEEN TESTED AND LISTED UNDER NSF STANDARD 42 FOR CHLORINE, TASTE AND ODOR REDUCTION (CLASS I) AND PARTICULATE REDUCTION (CLASS II).

WHIRLPOOL, BENTON HARBOR, MI, USA.

IT IS ESSENTIAL THAT OPERATIONAL, MAINTENANCE AND FILTER REPLACEMENT REQUIREMENTS BE CARRIED OUT FOR THE PRODUCT TO PERFORM AS ADVERTISED.



WATER FILTRATION SYSTEM II
MODEL NO. WSC200YW

REPLACEMENT CARTRIDGE: WHIRLPOOL L FSP# 4373530 WHIRLPOOL CF FSP# 4373531

RATED SERVICE FLOW – 0.6 gpm (2.28 lpm)
MAX. OPERATING PRESSURE –100 psig (862 kPa)
MAX. OPERATING TEMPERATURE 100°F (38°C)

NOTICE: ACTIVATED CARBON FILTERS ARE NOT INTENDED FOR USE WITH WATER THAT IS MICROBIOLOGICALLY UNSAFE OR WITH WATER OF UNKNOWN QUALITY WITHOUT ADEQUATE DISINFECTION BEFORE OR AFTER THE UNIT. PLEASE READ THE PERFORMANCE DATA SHEET.

THIS PRODUCT HAS BEEN TESTED AND LISTED UNDER NSF STANDARD 42 FOR CHLORINE, TASTE AND ODOR REDUCTION (CLASS I) AND PARTICULATE REDUCTION (CLASS II) AND UNDER NSF STANDARD 53 FOR LEAD, CYST AND TURBIDITY REDUCTION.

WHIRLPOOL, BENTON HARBOR, MI, USA.

IT IS ESSENTIAL THAT OPERATIONAL, MAINTENANCE AND FILTER REPLACEMENT REQUIREMENTS BE CARRIED OUT FOR THE PRODUCT TO PERFORM AS ADVERTISED.



WATER FILTRATION SYSTEM III
MODEL NO. WSC300YW

REPLACEMENT CARTRIDGE: WHIRLPOOL L FSP# 4373530 WHIRLPOOL CF FSP# 4373531

RATED SERVICE FLOW – 0.6 gpm (2.28 lpm)
MAX. OPERATING PRESSURE –100 psig (862 kPa)
MAX. OPERATING TEMPERATURE 100°F (38°C)

NOTICE: ACTIVATED CARBON FILTERS ARE NOT INTENDED FOR USE WITH WATER THAT IS MICROBIOLOGICALLY UNSAFE OR WITH WATER OF UNKNOWN QUALITY WITHOUT ADEQUATE DISINFECTION BEFORE OR AFTER THE UNIT. PLEASE READ THE PERFORMANCE DATA SHEET.

THIS PRODUCT HAS BEEN TESTED AND LISTED UNDER NSF STANDARD 42 FOR CHLORINE, TASTE AND ODOR REDUCTION (CLASS I) AND PARTICULATE REDUCTION (CLASS II) AND UNDER NSF STANDARD 53 FOR LEAD, CYST AND TURBIDITY REDUCTION. SEE PERFORMANCE DATA SHEET FOR PERMISSIBLE VOC CLAIMS.

WHIRLPOOL, BENTON HARBOR, MI, USA.

IT IS ESSENTIAL THAT OPERATIONAL, MAINTENANCE AND FILTER REPLACEMENT REQUIREMENTS BE CARRIED OUT FOR THE PRODUCT TO PERFORM AS ADVERTISED.



Performance Data Sheet



This product has been tested and listed by NSF International under Standard 42 for Taste, Odor and Chlorine reduction (Class I) and Particulate reduction (Class II).

Whirlpool Water Filtration System I Model No. WSC100YW

SPECIFICATIONS: Taste/Odor/Chlorine reduction (Class I) **CAPACITY:** 1,000 Gallons
SERVICE FLOW RATE: 0.6 GPM (2.2 L/min) @ 60 psi

General Performance	Average Influent	Maximum Effluent	Minimum% Reduction	NSF Test Requirement
Chlorine ¹	2.0 mg/L	<0.1 mg/L	92%	minimum 75% reduction (Class I)
Particulate	560,000 part/mL ²	18,000 part/mL	98%	minimum 85% reduction (Class II)
Performance may vary based on local water conditions. ¹ Free Available Chlorine. ² Test requirement is at least 10,000 particles/mL of AC Fine Test Dust.				



This product has been tested and listed by NSF International under Standard 42 for Taste, Odor and Chlorine reduction (Class I) and Particulate reduction (Class II) and under Standard 53 for Cyst, Turbidity and Lead reduction.

Whirlpool Water Filtration System II Model No. WSC200YW

SPECIFICATIONS: Lead and Taste/Odor/Chlorine reduction (Class I) **CAPACITY:** 500 Gallons
SERVICE FLOW RATE: 0.6 GPM (2.2 L/min) @ 60 psi

General Performance	Average Influent	Maximum Effluent	Minimum% Reduction	NSF Test Requirement
Chlorine ¹	2.0 mg/L	<0.1 mg/L	92%	minimum 75% reduction (Class I)
Particulate	560,000 part/mL ²	18,000 part/mL	98%	minimum 85% reduction (Class II)
Cyst	215,000 4-6 µ/mL ³	390 4-6 µ/mL	99.9%	minimum 99.9% reduction
Turbidity	14 NTU	0.42 NTU	97%	minimum effluent 1.0 NTU

Contaminant Reduction Performance ⁴	U.S. EPA MCL	Average Influent	Maximum Effluent	Minimum% Reduction	NSF Test Requirement
Lead @ pH 6.5	0.015 mg/L	0.16 mg/L ⁵	0.005 mg/L	97%	maximum effluent 0.015 mg/L
Lead @ pH 8.5	0.015 mg/L	0.17 mg/mL ⁵	0.002 mg/L	99%	maximum effluent 0.015 mg/L
¹ Free Available Chlorine. ² Test requirement is at least 10,000 particles/mL of AC Fine Test Dust. ³ Test requirement is 4-6 micrometer size particles per mL of influent. ⁴ These contaminants are not necessarily in your water supply. Performance may vary based on local water conditions. ⁵ Test requirement 0.15 mg/L ± 15%.					

Performance Data Sheet



This product has been tested and listed by NSF International under Standard 42 for Taste, Odor and Chlorine reduction (Class I) and Particulate reduction (Class II) and under Standard 53 for Cyst, Turbidity, Lead and VOC reduction.

Whirlpool Water Filtration System III

SPECIFICATIONS: Lead, VOC and Taste/Odor/Chlorine reduction (Class I) **CAPACITY:** 500 Gallons
SERVICE FLOW RATE: 0.6 GPM (2.2 L/min) @ 60 psi

General Performance	Average Influent	Maximum Effluent	Minimum% Reduction	NSF Test Requirement
Chlorine ¹	2.0 mg/L	<0.1 mg/L	92%	minimum 75% reduction (Class I)
Particulate	560,000 part/mL ²	18,000 part/mL	98%	minimum 85% reduction (Class II)
Cyst	215,000 4-6 µ/mL ³	390 4-6 µ/mL	99.9%	minimum 99.9% reduction
Turbidity	14 NTU	0.42 NTU	97%	minimum effluent 1.0 NTU

Contaminant Reduction Performance ⁴	U.S. EPA MCL	Average Influent	Maximum Effluent	Minimum% Reduction	NSF Test Requirement
Lead @ pH 6.5	0.015 mg/L	0.16 mg/L ⁵	0.005 mg/L	97%	maximum effluent 0.015 mg/L
Lead @ pH 8.5	0.015 mg/L	0.17 mg/L ⁵	0.002 mg/L	99%	maximum effluent 0.015 mg/L

¹Free Available Chlorine.
²Test requirement is at least 10,000 Particles/mL of AC Fine Test Dust.
³Test requirement is 4-6 micrometer size particles per mL of influent.
⁴These contaminants are not necessarily in your water supply. Performance may vary based on local water conditions.
⁵Test requirement 0.15 mg/L ± 15%.

VOLATILE ORGANIC CHEMICAL REDUCTION

This system has met the testing requirements of Standard 53, Section 5.1.1 for the reduction of chloroform, which is the surrogate for the following chemicals

Chemical	Occurrence Levels (ppb)	Maximum Effluent Level (ppb)	Other VOC's ¹	Influent Concentration (ppb)	Minimum Percent Reduction
Benzene	30 ¹	5 ³	cis-1,3-Dichloropropene	80	95%
Carbon Tetrachloride	40 ¹	5 ³	Chlorobenzene	80	95%
p-Dichlorobenzene	80 ²	5 ⁴	Hexachlorobutadiene	40	95%
Trichloroethylene	300 ¹	5 ³	ortho-Xylene	80	95%
Trihalomethanes (surrogate chemical)	300	15	trans-1,2-Dichloroethene	80	95%
1, 1-Dichloroethylene	50 ¹	7 ³	1,1,2,2-Tetrachloroethane	80	95%
1,1,1-Trichloroethane	80 ²	5 ⁴	1,2-Dichlorobenzene	80	95%
1,2-Dichloroethane	100 ¹	5 ³	1,2-Dichloroethane	80	95%
Ethylbenzene	80 ²	4 ⁴			
Tetrachloroethylene	80 ²	4 ⁴			
Toluene	80 ²	4 ⁴			
1,2-Dichloropropane	80 ²	5 ³			

¹Influent levels are the 95th percentile, occurrence levels are per Federal Register, Vol. 50, No. 219, November 13, 1985, p. 46917.
²Since the 95th percentile occurrence levels were too low and thus were not pertinent for testing these chemicals against their MCL's, a reasonable level was selected for surrogate testing as shown.
³EPA Primary Maximum Contaminant Levels
⁴Maximum effluent concentrations set at the practical quantitation level (PQL) which is less than the MCL.
⁵In the absence of officially stated occurrence levels and MCL's, the surrogate influents were selected to provide a conservative estimate.

Systems I, II & III

APPLICATION GUIDELINES/WATER SUPPLY PARAMETERS	
Water supply – community or private well	Potable (suitable for drinking)
Water Pressure	30 -100 psi (207 - 690kPa)
Water Temperature	40° - 100°F (4.4° - 38°C)
pH Range	6-9
Maximum TDS Level	500 ppm
Dissolved Iron	< 0.1 ppm
Dissolved Manganese	< 0.05 ppm
Turbidity	< 1 NTU

Water supplies that exceed limits for iron or manganese require pretreatment.
 It is essential that operational, maintenance and filter replacement requirements be carried out for the product to perform as advertised.
CAUTION: Do Not use where water is microbiologically unsafe or with water of unknown quality without adequate disinfection before or after the unit.

WARRANTY	
Length of Warranty:	Whirlpool will pay for:
One Year Full Warranty (From date of purchase)	Replacement parts and repair labor to correct defects in materials or workmanship for the entire product except for the filter cartridge(s). Service must be provided by an authorized Whirlpool servicing outlet.
Five Year Limited Warranty (Second through fifth year from date of purchase)	Replacement parts to correct defects in materials or workmanship for the entire product except for the filter cartridge(s).

Whirlpool will not pay for:

- Service calls to:
 - Correct the installation of the product. System must be installed and operated in accordance with Whirlpool procedures and guidelines.
 - Instruct you how to use the product.
 - Correct house plumbing.
- Repairs when product is used in other than normal, single-family household use.
- Repairs when product is damaged from neglect, misuse, abuse, freezing or hot water, fouling with sediment or scale, bacterial attack, alterations, improper installation, or installation not in accordance with local plumbing codes.
- Any labor costs during the limited warranty.
- Replacement parts or repair labor costs for units operated outside the U.S.
- Pickup and delivery. This product is designed to be repaired in the home.
- Repairs to parts or systems caused by unauthorized modifications made to the product.

The performance and functioning of your water filtration system is directly related to the quality of the water being treated and the particular application in which it is used. Please consult "Water Requirements" and "Use & Care".

Whirlpool shall not be liable for incidental or consequential damages. Some states do not allow the exclusion or limitation of incidental or consequential damages, so this limitation or exclusion may not apply to you.

This warranty gives you specific legal rights, and you may also have other rights which vary from state to state.

Part No. 4373576
©1993 Whirlpool Corporation



Whirlpool Corporation
Benton Harbor, MI 49022

Download from [Www.Somanuals.com](http://www.Somanuals.com). All Manuals Search And Download.



Printed on Recycled Paper in U.S.A.

Free Manuals Download Website

<http://myh66.com>

<http://usermanuals.us>

<http://www.somanuals.com>

<http://www.4manuals.cc>

<http://www.manual-lib.com>

<http://www.404manual.com>

<http://www.luxmanual.com>

<http://aubethermostatmanual.com>

Golf course search by state

<http://golfingnear.com>

Email search by domain

<http://emailbydomain.com>

Auto manuals search

<http://auto.somanuals.com>

TV manuals search

<http://tv.somanuals.com>