



Model WHES48

How to install, operate and maintain your E-Z Touch Demand Controlled Water Softener

Do not return water softener to store

If you have any questions or concerns when installing, operating or maintaining your water softener, call our toll free number:

1-866-986-3223

Monday- Friday, 8 AM - 7 PM EST or visit
www.ecodynewatertreatment.com

When you call, please be prepared to provide the model, date code and serial number of your product, found on the rating decal, typically located on the rim below the salt lid hinges.



System tested and certified by NSF International against NSF/ANSI Standard 44 for hardness reduction and efficiency.



System tested and certified by the Water Quality Association against CSA B483.1.



C USA

Manufactured and warranted by
Ecodyne Water Systems
1890 Woodlane Drive
Woodbury, MN 55125

Printed on recycled paper

7310359 (Rev K 9/9/11)
Product No. W10270201



Installation and Operation Manual

TABLE OF CONTENTS

	<u>Page</u>
Specifications & Dimensions	3
Water Softener Safety	4
Before You Start	4
Inspect Shipment	5
Water Conditioning Information	5
Installation Requirements	6-7
Installation Instructions	8-11
Water Softener Setup	12
Programming Your E-Z Touch Water Softener	13-17
Retrieving Information from the Water Softener Management System	18
Customizing Features / Options	19-22
Routine Maintenance	23
Troubleshooting	24-25
Exploded View & Parts List	26-29

WATER SOFTENER WARRANTY - MODEL WHES48

Warrantor: Ecodyne Water Systems, 1890 Woodlane Drive, Woodbury, MN 55125

Warrantor guarantees, to the original owner, that:

For the lifetime of the original owner, the salt storage tank and mineral tank will not rust, corrode, leak, burst, or in any other manner, fail to perform their proper functions; and that

For the lifetime of the original owner, the ion exchange resin will not fail to perform its proper function; and that

For a period of three (3) years after installation, the electronic control board will be free of defects in materials and workmanship and will perform its normal functions; and that

For a period of two (2) years after installation, all other parts will be free from defects in materials and workmanship and will perform their normal functions; and that

For a period of two (2) years after installation, labor to repair or replace any part deemed to be defective in materials or workmanship, will be provided at no additional cost.

If, during such respective period, a part proves to be defective, Warrantor will ship a replacement part, directly to your home, without charge. After the second year, labor necessary to maintain this product is not covered by the product warranty.

If you have questions regarding a warranted product, need assistance with installation or troubleshooting, wish to order a part or report a warranty issue, we are just a phone call away. SIMPLY DIAL 1-866-986-3223, Monday - Friday, 8 am - 7 pm EST, for assistance.

General Provisions

The above warranties are effective provided the water softener is operated at water pressures not exceeding 125 psi, and at water temperatures not exceeding 120°F; provided further that the water softener is not subject to abuse, misuse, alteration, neglect, freezing, accident or negligence; and provided further that the water softener is not damaged as the result of any unusual force of nature such as, but not limited to, flood, hurricane, tornado or earthquake.

Warrantor is excused if failure to perform its warranty obligations is the result of strikes, government regulation, materials shortages, or other circumstances beyond its control.

***THERE ARE NO WARRANTIES ON THE WATER SOFTENER BEYOND THOSE SPECIFICALLY DESCRIBED ABOVE. ALL IMPLIED WARRANTIES, INCLUDING ANY IMPLIED WARRANTY OF MERCHANTABILITY OR OF FITNESS FOR A PARTICULAR PURPOSE, ARE DISCLAIMED TO THE EXTENT THEY MIGHT EXTEND BEYOND THE ABOVE PERIODS. THE SOLE OBLIGATION OF WARRANTOR UNDER THESE WARRANTIES IS TO REPLACE OR REPAIR THE COMPONENT OR PART WHICH PROVES TO BE DEFECTIVE WITHIN THE SPECIFIED TIME PERIOD, AND WARRANTOR IS NOT LIABLE FOR CONSEQUENTIAL OR INCIDENTAL DAMAGES. NO WARRANTOR DEALER, AGENT, REPRESENTATIVE, OR OTHER PERSON IS AUTHORIZED TO EXTEND OR EXPAND THE WARRANTIES EXPRESSLY DESCRIBED ABOVE.**

Some states do not allow limitations on how long an implied warranty lasts or exclusions or limitations of incidental or consequential damage, so the limitations and exclusions in this warranty may not apply to you. This warranty gives you specific legal rights, and you may have other rights which vary from state to state. This warranty applies to consumer-owned installations only.

® Registered trademark/TM Trademark of Whirlpool, USA.

Manufactured under license by Ecodyne Water Systems, Woodbury, Minnesota.

© 2009 Whirlpool Corporation. All rights reserved.

Specifications & Dimensions

	Model WHES48
Model Code	EZ 48
Rated Softening Capacity (Grains @ Salt Dose)	14,300 @ 2.8 lbs. 37,900 @ 10.5 lbs. 48,000 @ 18.1 lbs.
Rated Efficiency (Grains/Pound of Salt @ Minimum Salt Dose)	5,107 @ 2.8 lbs.
Water Used During Regeneration @ Minimum Salt Dose	3.0 gal. / 1,000 grains
Total Water Used Per Regeneration @ Maximum Salt Dose	44.2 gallons
Rated Service Flow Rate	11.9 gpm
Amount of High Capacity Ion Exchange Resin	1.33 cu. ft.
Pressure Drop at Rated Service Flow	15 psig
Water Supply Max. Hardness	160 gpg
Water Supply Max. Clear Water Iron	12 ppm*
Water Pressure Limits (minimum / maximum)	20 - 125 psi**
Water Temperature Limits (minimum / maximum)	40 - 120 °F
Minimum Water Supply Flow Rate	3 gpm
Maximum Drain Flow Rate	2.0 gpm
Salt Storage Capacity	200 lbs.

*Capacity to reduce clear water iron is substantiated by WQA test data. State of Wisconsin requires additional treatment if water supply contains clear water iron exceeding 5 ppm.

**Canada working pressure limits: 1.4 - 7.0 kg/cm².

These systems conform to NSF/ANSI 44 for the specific performance claims as verified and substantiated by test data.

The efficiency rating is only valid at the stated salt dose. These softeners were efficiency rated according to NSF/ANSI Standard 44.

Variable Salt Dose: The salt dose is selected by the electronic controls at regeneration time based on the amount needed.

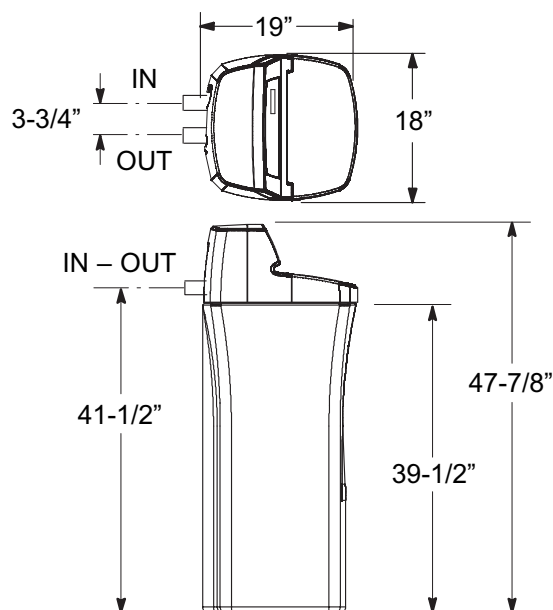

FIG. 1

Questions? Call Toll Free 1-866-986-3223 Monday- Friday, 8 AM - 7 PM EST
or visit www.ecodynewatertreatment.com

When you call, please be prepared to provide the model, date code and serial number, found on the rating decal, typically located on the rim below the salt lid hinges.

Water Softener Safety

Your safety and the safety of others are very important.

We have provided many safety messages in this manual and on your appliance. Always read and obey all safety messages.



This is the safety alert symbol.

This symbol alerts you to potential hazards that can kill or hurt you and others.

All safety messages will follow the safety alert symbol and either the word "DANGER" or "WARNING". These words mean:

⚠ DANGER

You can be killed or seriously injured if you don't immediately follow instructions.

⚠ WARNING

You can be killed or seriously injured if you don't follow instructions.

All safety messages will tell you what the potential hazard is, tell you how to reduce the chance of injury, and tell you what can happen if the instructions are not followed.

In the state of Massachusetts: The Commonwealth of Massachusetts plumbing code 248-CMR shall be adhered to. A licensed plumber shall be used for this installation.

In the state of California: You must turn the Salt Efficiency Feature setting to ON. This may initiate more frequent recharges. However, it will operate at 4,000 grains per pound of salt or higher. To turn on the Salt Efficiency Feature, follow the instructions in the "Salt Efficiency" section of this manual.

Before You Start

- The water softener requires a minimum water flow of 3 gallons per minute at the inlet. Maximum allowable inlet water pressure is 125 psi. If daytime pressure is over 80 psi, nighttime pressure may exceed the maximum. Use a pressure reducing valve if necessary (Adding a pressure reducing valve may reduce the flow). If your home is equipped with a back flow preventer, an expansion tank must be installed in accordance with local codes and laws.
- The water softener works on 24 volt, 60 Hz electrical power only, supplied by a direct plug-in transformer (included). Be sure to use the included transformer and plug it into a nominal 120V, 60 cycle household outlet that is in a dry location only, grounded and properly protected by an overcurrent device such as a circuit breaker or fuse. If transformer is replaced, use only UL, CUL or CSA approved Class 2 transformer with the following specifications:
 - Input: 120 VAC, 60 Hz, 13.5 W
 - Output Voltage: 24 VAC
 - Output Current: 400 mA
- Do not use this system to treat water that is microbiologically unsafe or of unknown quality without adequate disinfection upstream or downstream of the system.



European Directive 2002/96/EC requires all electrical and electronic equipment to be disposed of according to Waste Electrical and Electronic Equipment (WEEE) requirements. This directive or similar laws are in place nationally and can vary from region to region. Please refer to your state and local laws for proper disposal of this equipment.

Do not return the water softener to store.

If you have any questions, or there are missing parts or damage, please call **Toll Free 1-866-986-3223**, Monday - Friday, 8 am - 7 pm EST, or visit **www.ecodynewatertreatment.com**

When you call, please be prepared to provide the model, date code and serial number, found on the rating decal, typically located on the rim below the salt lid hinges.

Inspect Shipment

The parts required to assemble and install the water softener are included with the unit. Thoroughly check the water softener for possible shipping damage and parts loss. Also inspect and note any damage to the shipping carton.

Remove and discard (or recycle) all packing materials. To avoid loss of small parts, we suggest you keep the small parts in the parts bag until you are ready to use them.

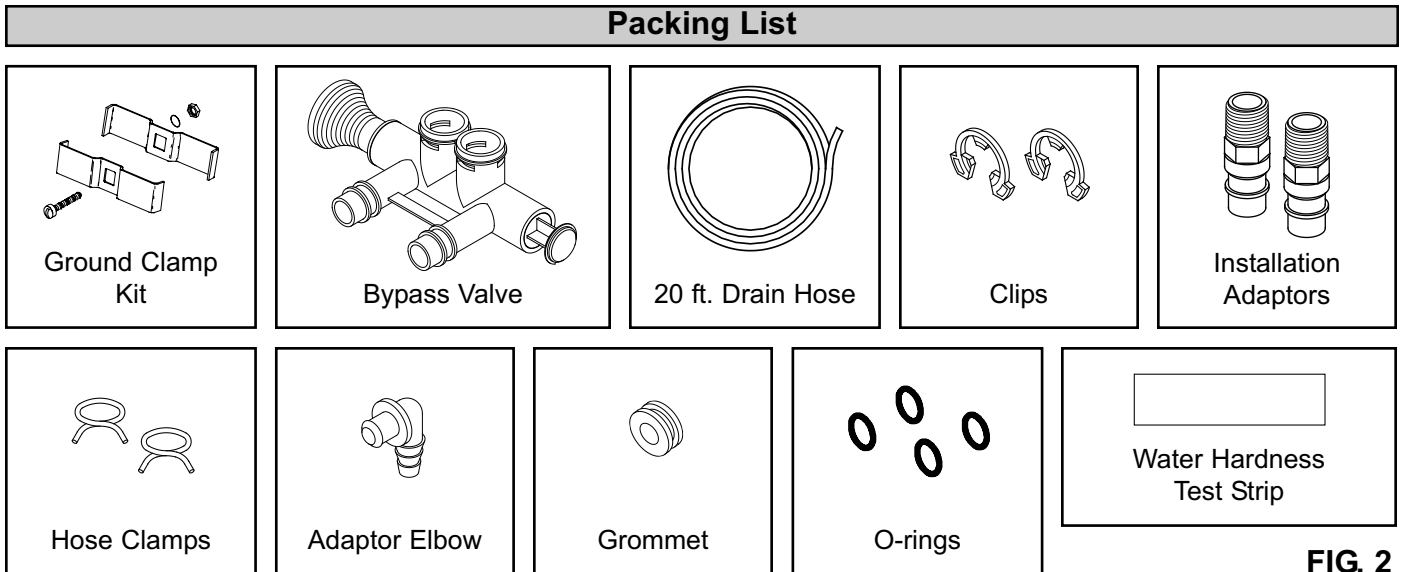

FIG. 2

Water Conditioning Information

IRON

Iron in water can cause stains on clothing and plumbing fixtures. It can negatively affect the taste of food, drinking water, and other beverages. Iron in water is measured in parts per million (ppm). The total* ppm of iron, and type or types*, is determined by chemical analysis. Four different types of iron in water are:

- Ferrous (clear water) iron
- Ferric (red water) iron
- Bacterial and organically bound iron
- Colloidal and inorganically bound iron (ferrous or ferric)

Ferrous (clear water) iron is soluble and dissolves in water. This water softener will reduce moderate amounts of this type of iron (see specifications).**

Ferric (clear water) iron is usually detected by taking a sample of water in a clear bottle or glass.

Immediately after taking, the sample is clear. As the water sample stands, it gradually clouds and turns slightly yellow or brown as air oxidizes the iron. This usually occurs in 15 to 30 minutes.

When using the softener to reduce Ferrous (clear water) iron, add 5 grains to the hardness setting for every 1 ppm of Ferrous (clear water) iron. See "Set Water Hardness Number" section.

Ferric (red water), and bacterial and organically bound irons are insoluble. This water softener will not remove ferric or bacterial iron. This iron is visible

immediately when drawn from a faucet because it has oxidized before reaching the home. It appears as small cloudy yellow, orange, or reddish suspended particles. After the water stands for a period of time, the particles settle to the bottom of the container. Generally these irons are removed from water by filtration. Chlorination is also recommended for bacterial iron.

Colloidal and inorganically bound iron is of ferric or ferrous form that will not filter or exchange out of water. This water softener will not remove colloidal iron. In some instances, treatment may improve colloidal iron water. Colloidal iron water usually has a yellow appearance when drawn. After standing for several hours, the color persists and the iron does not settle, but remains suspended in the water.

SEDIMENT

Sediment is fine, foreign material particles suspended in water. This water softener will not remove sediment. This material is most often clay or silt. Extreme amounts of sediment may give the water a cloudy appearance. A sediment filter installed upstream of the water softener normally corrects this situation.

* Water may contain one or more of the four types of iron and any combination of these. Total iron is the sum of the contents.

** Capacity to reduce clear water iron is substantiated by WQA test data.

Installation Requirements

LOCATION REQUIREMENTS

Consider all of the following when selecting an installation location for the water softener.

- Do not locate the water softener where freezing temperatures occur. Do not attempt to treat water over 120°F. Freezing temperatures or hot water damage voids the warranty.
- To condition all water in the home, install the water softener close to the water supply inlet, and upstream of all other plumbing connections, except outside water pipes. Outside faucets should remain on hard water to avoid wasting conditioned water and salt.
- A nearby drain is needed to carry away regeneration discharge (drain) water. Use a floor drain, laundry tub, sump, standpipe, or other options (check your local codes). See "Air Gap Requirements" and "Valve Drain Requirements" sections.
- The water softener works on 24 volt, 60 Hz electrical power only, supplied by a direct plug-in transformer (included). Provide an electrical outlet within 10 feet, in accordance with NEC and local codes.
- Always install the water softener between the water inlet and water heater. Any other installed water conditioning equipment should be installed between the water inlet and water softener (See Figure 4 below).
- Avoid installing in direct sunlight. Excessive sun heat may cause distortion or other damage to non-metallic parts.

PLUMBING CODES

All plumbing must be completed in accordance with national, state and local plumbing codes.

In the state of Massachusetts: The Commonwealth of Massachusetts plumbing code 248-CMR shall be adhered to. A licensed plumber shall be used for this installation.

AIR GAP REQUIREMENTS

A drain is needed for regeneration water (See Figure 3). A floor drain, close to the water softener, is preferred. A laundry tub, standpipe, etc. are other drain options. Secure valve drain hose in place. Leave an air gap of 1-1/2" between the end of the hose and the drain. This gap is needed to prevent backflow of sewer water into the water softener. Do not put the end of the drain hose into the drain.

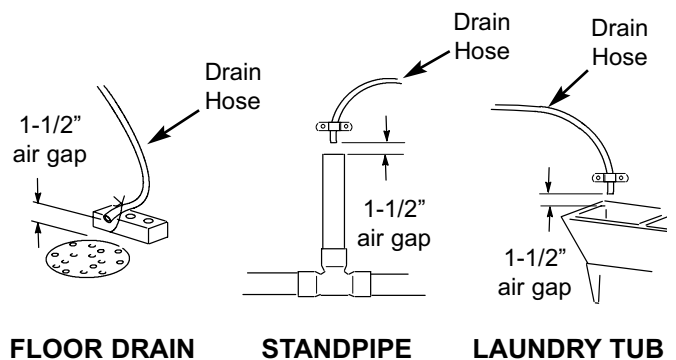

FIG. 3

THE PROPER ORDER TO INSTALL WATER TREATMENT EQUIPMENT

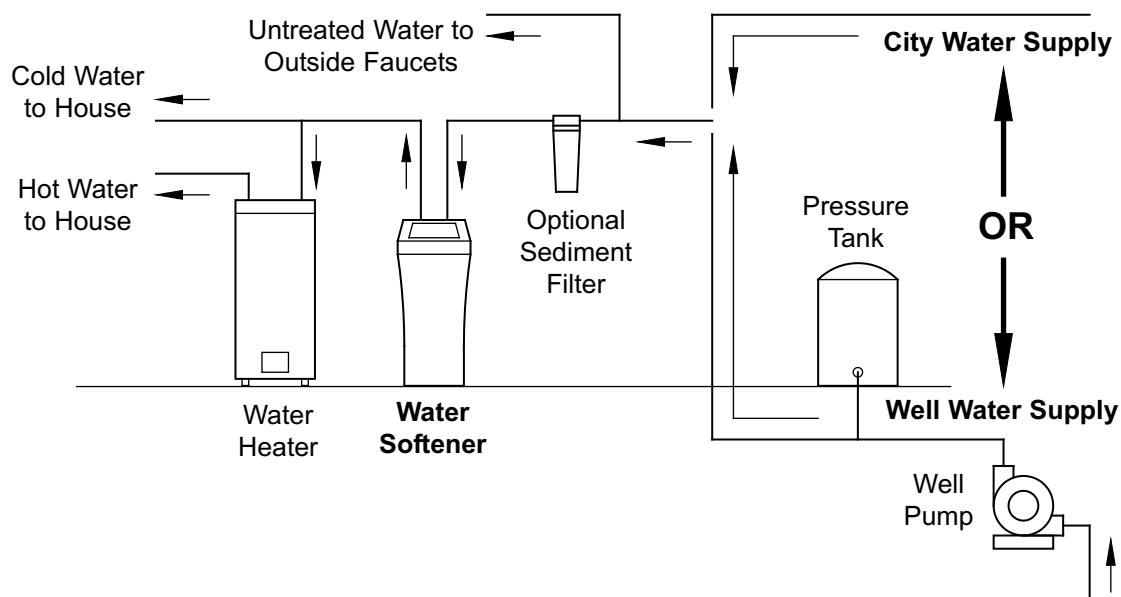

FIG. 4

Installation Requirements

VALVE DRAIN REQUIREMENTS

Using the flexible drain hose (included), measure and cut to the length needed. Flexible drain hose is not allowed in all localities (check your plumbing codes). If local codes do not allow use of a flexible drain hose, a rigid valve drain run must be used. Purchase a compression fitting (1/4 NPT x 1/2 in. minimum tube) and 1/2" tubing from your local hardware store. Plumb a rigid drain as needed (See Figure 6).

NOTE: Avoid drain hose runs longer than 30 feet. Avoid elevating the hose more than 8 feet above the floor. Make the valve drain line as short and direct as possible.

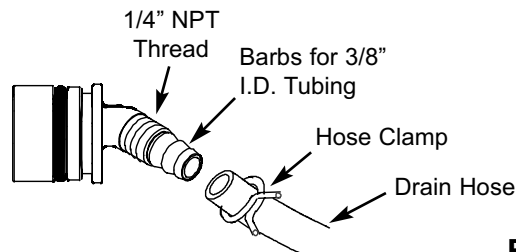

FIG. 5

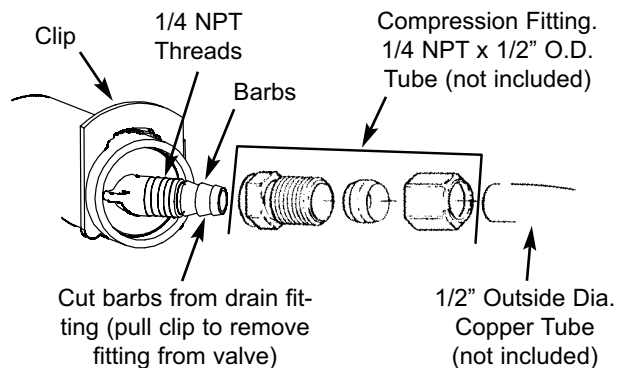

FIG. 6

INLET / OUTLET PLUMBING OPTIONS

Always install either a single bypass valve (provided), as shown in Figure 7, or, if desired, parts for a 3 valve bypass system (not included) can be purchased and assembled, as shown in Figure 8. Bypass valves allow you to turn off water to the softener for maintenance if needed, but still have water in house pipes. Pipe fittings must be 3/4" minimum.

Use:

- Copper pipe
- Threaded pipe
- PEX (Crosslinked Polyethylene) pipe
- CPVC plastic pipe
- Other pipe approved for use with potable water

IMPORTANT: Do not solder with plumbing attached to installation adaptors and single bypass valve. Soldering heat will damage the adaptors and valve.

SINGLE BYPASS VALVE

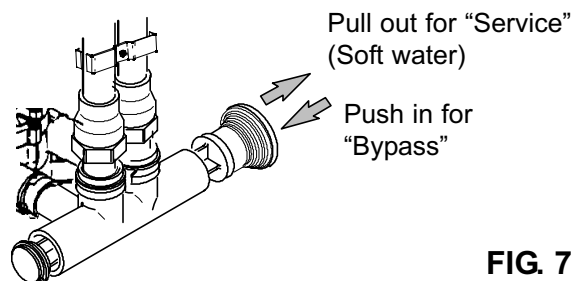

FIG. 7

3 VALVE BYPASS

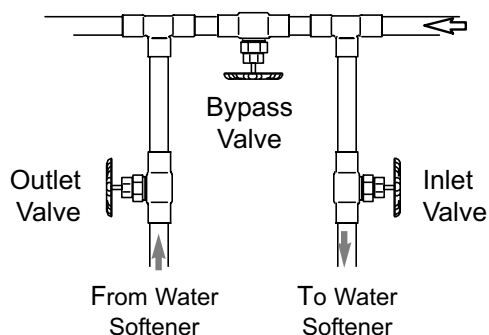

FIG. 8

Installation Instructions

TYPICAL INSTALLATION

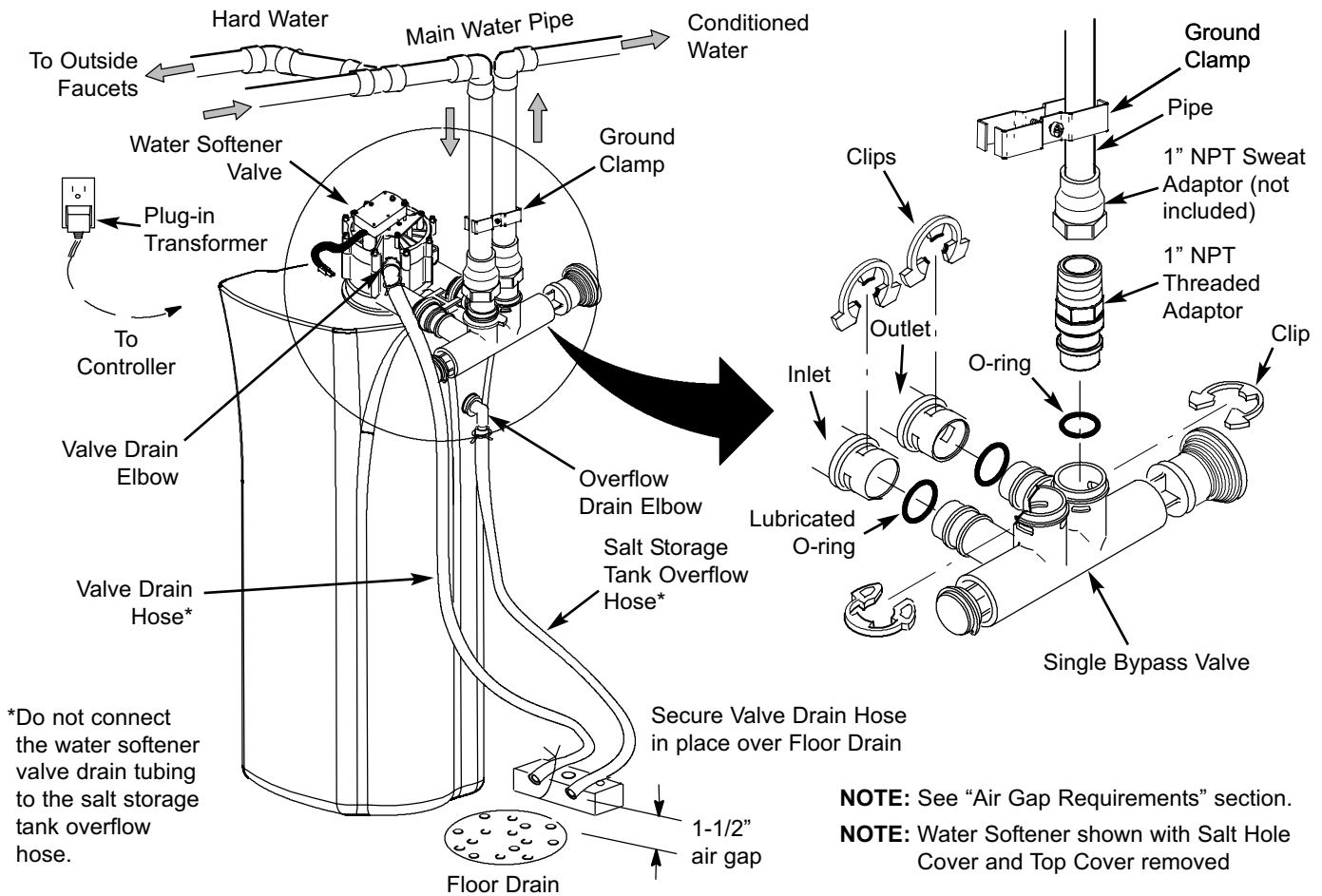

FIG. 9

Installation Instructions

TURN OFF WATER SUPPLY

1. Close the main water supply valve, located near the well pump or water meter.
2. Open all faucets to drain all water from house pipes.

NOTE: Be sure not to drain water from the water heater, as damage to the water heater elements could result.

INSTALL THE BRINE TANK OVERFLOW ELBOW

Install the brine tank overflow grommet and elbow in the 13/16" diameter hole in the back of the salt storage tank sidewall.

NOTE: The brine tank overflow elbow accepts either 1/2" or 3/8" I.D. hose.

MOVE THE WATER SOFTENER INTO PLACE

WARNING

Excessive Weight Hazard

Use two or more people to move and install water softener.
Failure to do so can result in back or other injury.

1. Move the water softener into the desired location. Set it on a solid, level surface.

IMPORTANT: Do not place shims directly under the salt storage tank to level the softener. The weight of the tank, when full of water and salt, may cause the tank to fracture at the shim.

2. Visually check and remove any debris from the water softener valve inlet and outlet ports.
3. Make sure the turbine assembly spins freely in the "out" port of the valve.
4. If not already done, put a light coating of silicone grease on the single bypass valve o-rings.
5. Push the single bypass valve into the softener valve as far as it will go. Snap the two large holding clips into place, from the top down as shown in Figures 11 & 12.

IMPORTANT: Be sure the clips snap firmly into place so the single bypass valve will not pull out.

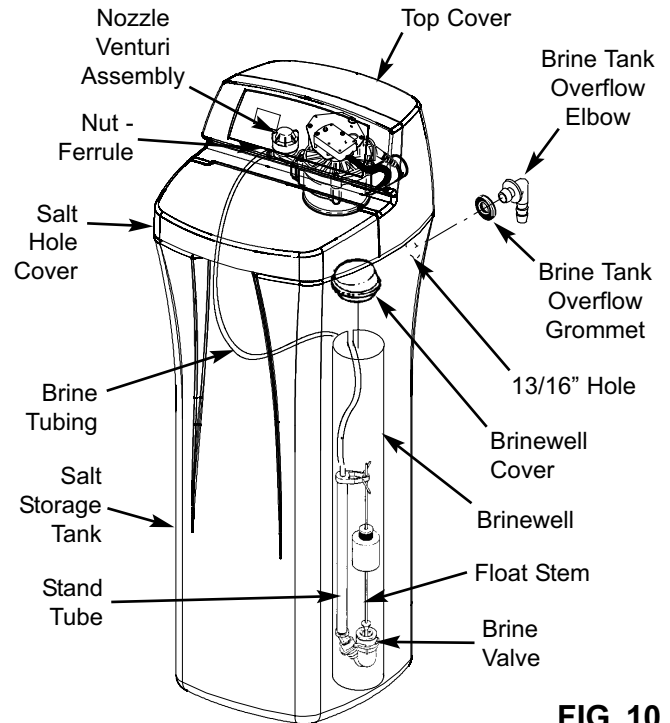

FIG. 10

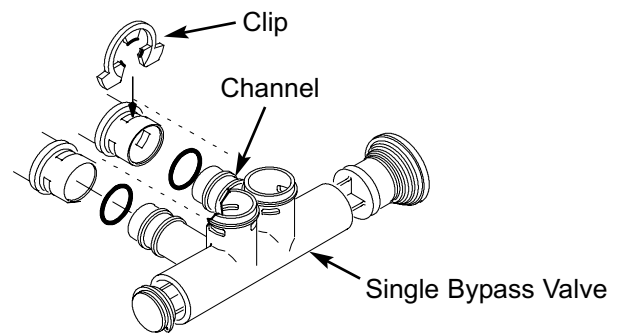

FIG. 11

CORRECT ASSEMBLY

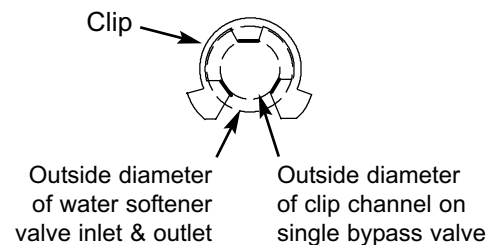

FIG. 12

NOTE: Be sure all 3 tabs of the clip go through the matching holes on the water softener valve inlet or outlet, and fully into the channel on the single bypass valve. Make sure that the tabs are fully seated.

Installation Instructions

COMPLETE INLET AND OUTLET PLUMBING

Measure, cut, and loosely assemble pipe and fittings from the main water pipe to the inlet and outlet ports of the water softener valve. Be sure to keep fittings fully together, and pipes squared and straight.

Be sure hard water supply pipe goes to the water softener valve inlet side.

NOTE: Inlet and outlet are marked on the water softener valve. Trace the water flow direction to be sure hard water is to inlet.

IMPORTANT: Be sure to fit, align and support all plumbing to prevent putting stress on the water softener valve inlet and outlet. Stress from misaligned or unsupported plumbing may cause damage to the valve.

Complete the inlet and outlet plumbing for the type of pipe you will be using. Secure ground clamp to metal pipes (See Fig. 13).

INSTALL VALVE DRAIN HOSE

1. Measure, cut to needed length and connect the 3/8" drain line (provided) to the water softener valve drain fitting. Use a hose clamp to hold the hose in place.

NOTE: Avoid drain hose runs longer than 30 feet. Avoid elevating the hose more than 8 feet above the floor. Make the valve drain line as short and direct as possible.

IMPORTANT: If codes require a rigid drain line see "Valve Drain requirements" section.

2. Route the drain hose or copper tubing to the floor drain. Secure drain hose. This will prevent "whipping" during regenerations. See "Air Gap Requirements" section.

INSTALL SALT STORAGE TANK OVERFLOW HOSE

1. Measure, cut to needed length and connect the 3/8" drain line (provided) to the salt storage tank overflow elbow and secure in place with a hose clamp.

2. Route the hose to the floor drain, or other suitable drain point no higher than the drain fitting on the salt storage tank (This is a gravity drain). If the tank overfills with water, the excess water flows to the drain point. Cut the drain line to the desired length and route it neatly out of the way.

IMPORTANT: For proper operation of the water softener, do not connect the water softener valve drain tubing to the salt storage tank overflow hose.

⚠ WARNING



Electrical Shock Hazard
Install metal ground clamp to metal house water supply pipe before beginning installation.
Securely tighten connection in center of metal ground clamp.
Failure to do so can result in death or electrical shock.

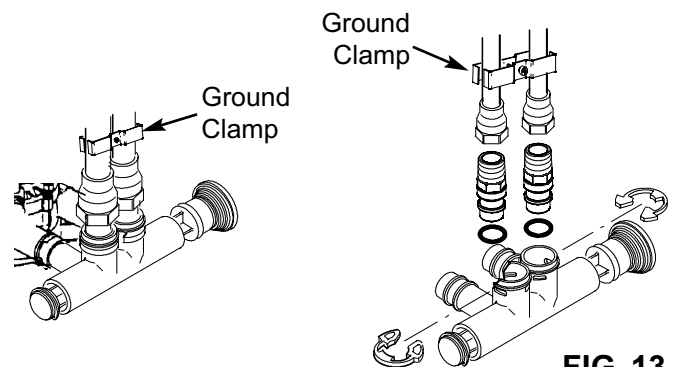

FIG. 13

Installation Instructions

TEST FOR LEAKS

To prevent air pressure in the water softener and plumbing system, complete the following steps in order:

1. Fully open two or more softened cold water faucets close to the water softener, located downstream from the water softener.
2. Place the bypass valve (single or 3 valve) into the "bypass" position. See Figures 7 & 8 on Page 7.
3. Slowly open the main water supply valve. Run water until there is a steady flow from the opened faucets, with no air bubbles.
4. Place bypass valve(s) in "service" or soft water position as follows:
 - Single bypass valve: Slowly move the valve stem toward "service," pausing several times to allow the water softener to fill with water.
 - 3 valve bypass: Fully close the bypass valve and open the outlet valve. Slowly open the inlet valve, pausing several times to allow the water softener to fill with water.
5. After about three minutes, open a hot water faucet until there is a steady flow and there are no air bubbles, then close this faucet.
6. Close all cold water faucets and check for leaks at the plumbing connections that you made.
7. Check for leaks around clips at softener's inlet and outlet. If a leak occurs at a clip, depressurize the plumbing (turn off the water supply and open faucets) before removing clip. When removing clips at the softener's inlet or outlet, push the single bypass valve body toward the softener (See Figure 14). Improper removal may damage clips. Do not reinstall damaged clips.

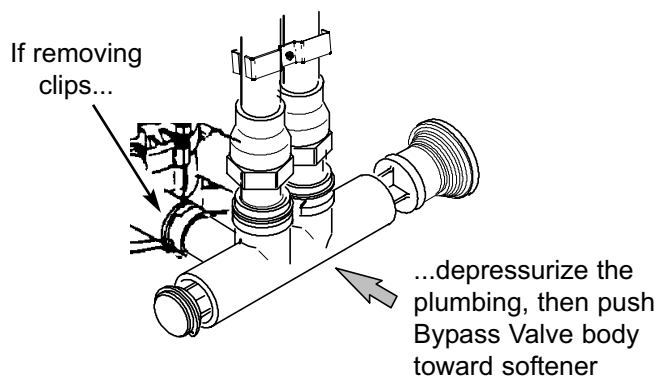

FIG. 14

ADD WATER AND SALT TO THE SALT STORAGE TANK

! WARNING

Excessive Weight Hazard

Use two or more people to move and lift salt bags.

Failure to do so can result in back or other injury.

1. Using a container, add about three gallons of clean water into the salt storage tank.
2. Add salt to the storage tank. Use nugget, pellet or coarse solar salts with less than 1% impurities.

PLUG IN THE WATER SOFTENER

During installation, the water softener wiring may be moved or jostled from place. Be sure all leadwire connectors are secure on the back of the electronic board and be sure all wiring is away from the valve gear and motor area, which rotates during regenerations.

1. Plug the water softener into an electrical outlet that is not controlled by a switch.

NOTE: The water heater is filled with hard water and, as hot water is used, it will refill with conditioned water. In a few days, the hot water will be fully conditioned. To have fully conditioned hot water immediately, wait until the initial recharge is over. Then, drain the water heater (following instructions for water heater) until water runs cold.

SANITIZE THE WATER SOFTENER / SANITIZE AFTER SERVICE

1. Open salt hole cover, remove the brinewell cover and pour about 3 oz. (6 tablespoons) of household bleach into the softener brinewell. Replace the brinewell cover.
2. Make sure the bypass valve(s) is in the "service" (open) position.
3. Start a recharge (regeneration). See "Recharge Now" on Page 15.
4. After the recharge has completed, fully open a cold water faucet, downstream from the softener, and allow 75 gallons of water to pass through the system. This should take at least 10 minutes. Close the faucet.

Water Softener Setup

TOUCH SCREEN

Controls for programming the water softener are displayed on a touch screen, located on the softener's front panel (See Figure 17). On-screen "buttons" appear as rectangular outlines with rounded corners and change with each display (See Figures below). Button presses are acknowledged with a "beep."

NOTE: Before cleaning the touch screen to remove fingerprints, unplug the transformer. The controller's memory items (including clock time, water hardness, etc.) are retained during brief power interruptions. Use a microfiber towel or household cleaner safe for plastics on the touch screen.

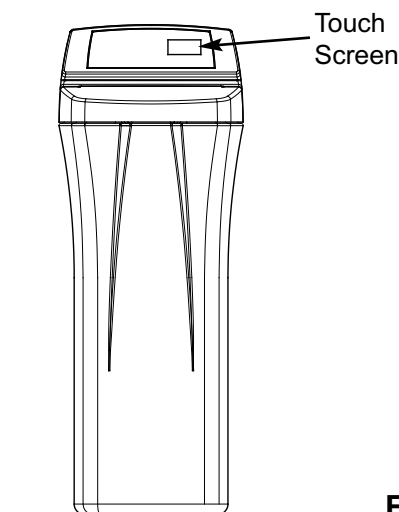

FIG. 17

SETUP PROCEDURE

When the softener is plugged in for the first time, a beep sounds and the display briefly shows "E-Z Touch", followed by the model number and software version.

Next, a series of three setup screens prompts you to enter basic operating information:

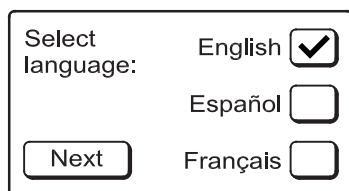

FIG. 15

1. LANGUAGE: If the desired language is not checked (See Figure 15), press the button next to the desired language, then press the NEXT button.

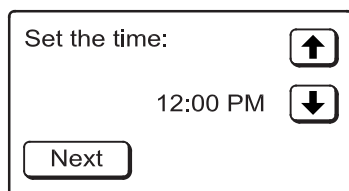

FIG. 16

2. CURRENT TIME: Press the DOWN (↓) or UP (↑) buttons to set the current time (See Figure 16). Hold the button down to rapidly advance. Be sure AM or PM is correct. When the current time is shown, press the NEXT button.

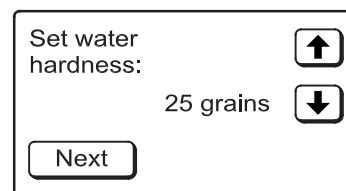

FIG. 18

3. WATER HARDNESS: Press the UP (↑) or DOWN (↓) buttons to set the value of your water's hardness (See Figure 18), then press the NEXT button.

NOTE: Do not increase the hardness setting to compensate for iron in your water. The electronic control will compensate automatically after you set the iron level, as described on Page 17.

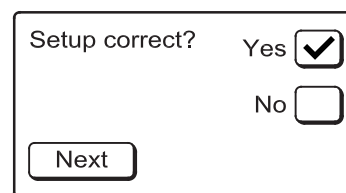

FIG. 19

- If, at this point, you want to go back and make changes, press the button next to NO, then press the NEXT button to repeat the three setup screens.
- If no changes are desired, make sure the button next to YES is checked and press the NEXT button. The softener begins normal operation, described on the next page.

Questions? Call Toll Free 1-866-986-3223 Monday- Friday, 8 AM - 7 PM EST
or visit www.ecodynewatertreatment.com

When you call, please be prepared to provide the model, date code and serial number, found on the rating decal, typically located on the rim below the salt lid hinges.

Programming Your E-Z Touch Water Softener

SOFTENER STATUS SCREEN

During normal operation, the softener's display shows a screen like the one in Figure 20, below. The display automatically returns to this screen from other screens after 4 minutes of inactivity.

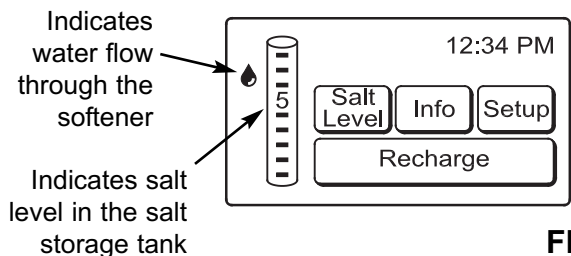

FIG. 20

During normal operation, there are four active buttons on the softener's status screen. They access subsidiary screens used to control softener operations, as shown below:

- ❑ **Salt Level** Button (See Page 13)
- ❑ **Recharge** Button (See Page 15)
 - **Recharge Now** (See Page 15)
 - **Set Recharge Time** (See Page 15)
 - **Schedule Recharge** (See Page 16)
- ❑ **Info (Information)** Button (See Page 18)
 - **Water Flow** (See Page 18)
 - **Average Daily Use** (See Page 18)
 - **Water Used Today** (See Page 18)
 - **Capacity Remaining** (See Page 18)
 - **Days In Use** (See Page 18)
 - **Total Recharges** (See Page 18)
- ❑ **Setup** Button (See Page 16)
 - **Set Time** (See Page 16)
 - **Set Hardness** (See Page 17)
 - **Set Recharge Time** (See Page 15)
 - **Set Iron Level** (See Page 17)
 - **Advanced Setup**
 - **Additional Features**
 - **Set Clean Feature** (See Page 19)
 - **Set Clean Time** (See Page 19)
 - **Set Salt Efficiency** (See Page 20)
 - **Set Salt Type** (See Page 20)
 - **Set Units** (See Page 21)
 - **Volume Units** (See Page 21)
 - **Time Format** (See Page 21)
 - **Hardness Units** (See Page 21)
 - **Set Contrast** (See Page 14)
 - **Restore Factory Settings** (See Page 22)
 - **Set Language** (See Page 14)

SALT LEVEL BUTTON

For the "Low salt" indicator to work, whenever you add salt to the softener, you must reset the salt level indicator on the display to match the new level of salt in the tank. A decal on the brinewell shows numbers up to 8, corresponding to the numbers on the display. Each press of the SALT LEVEL button (See Figure 20) makes the level indicated on the display go up by one. A "Low salt" message will flash on the display (See Figure 21) whenever the level is 2 or below.

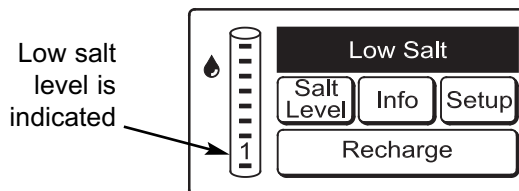

FIG. 21

TANK LIGHT

Touching the screen anywhere will turn on the light in the softener's brine tank. The light will turn off again automatically after 4 minutes.

FLASHING BACKLIGHT

The softener's display is backlit to make it easy to read. The contrast may be adjusted, as described on Page 14. The backlight will flash on and off when one or more of the following conditions occurs:

- Salt needs to be added
- Time has been lost, perhaps after a long power loss (The **Set Time** screen will be displayed instead of the status screen)
- Error condition (Service is required)

The flashing will stop after any key is pressed. However, it will start again at Midnight if the underlying condition (e.g. low salt level) has not been addressed.

ALERTS & REMINDERS

Normally, the current time is the only thing displayed along the top right portion of the screen. A flashing message, like the one shown in Figure 21, will be displayed instead if one of the following conditions occurs:

- **Low salt** indicates that salt needs to be added (See Page 23) and the salt level indicator reset (See "Salt Level Button", above). This message appears whenever the salt level is 2 or below.
- **Error** (Service is required)

Programming Your E-Z Touch Water Softener

SET LANGUAGE

When the softener's electronic control is first powered up, the setup procedure prompts you to set the language (See Page 12). To change the language:

1. Press the SETUP button on the softener status screen (See Figure 22).

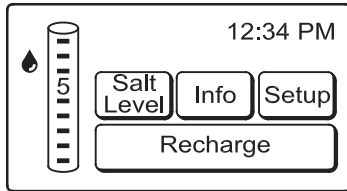

FIG. 22

2. Press the LEFT (←) button to display the screen shown in Figure 23.

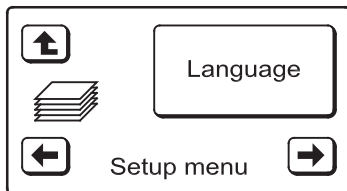

FIG. 23

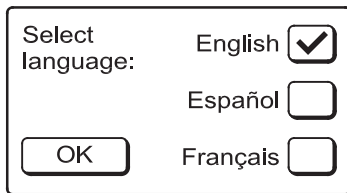

FIG. 24

3. Press the LANGUAGE button and the display will change to show the **Select Language** screen (See Figure 24).
4. Press the button next to the desired language. When the desired language is checked, press the OK button.
5. To return to the softener status screen, press the RETURN (↑) button.

TO SET THE SOFTENER TO ENGLISH IF ANOTHER LANGUAGE IS DISPLAYED:

If the softener status screen is not showing, press the RETURN (↑) button a few times. On the status screen, press the PRGM button. Press the LEFT (←) button, then press the large IDIOMA or LANGUE button. Press the button next to ENGLISH, then press the OK button. Press the RETURN (↑) button to return to the status screen.

SET CONTRAST

The contrast of the softener's display screen may be adjusted to optimize its readability. Depending on the ambient lighting conditions, you may want to increase or decrease the contrast from the medium level that is the default when the electronic control is first powered up. To change the contrast:

1. Press the SETUP button on the softener status screen (See Figure 22).
2. Press the LEFT (←) button twice to display the screen shown in Figure 25.

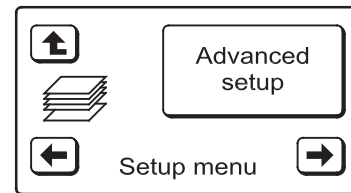

FIG. 25

3. Press the ADVANCED SETUP button. The display will change to the following screen.

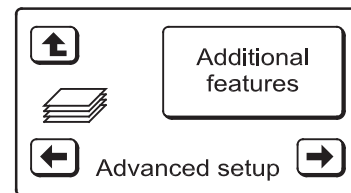

FIG. 26

4. Press the LEFT (←) button twice to display the screen shown in Figure 27.

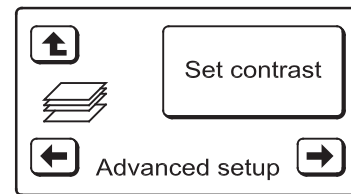

FIG. 27

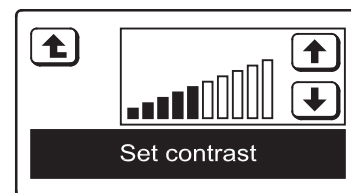

FIG. 28

5. Press the SET CONTRAST button and the display will change to show the **Set contrast** screen (See Figure 28).
6. Press the UP (↑) or DOWN (↓) buttons to increase or decrease the contrast. When the preferred contrast is reached, press the RETURN (↑) button.
7. To return to the softener status screen, press the RETURN (↑) button twice.

Programming Your E-Z Touch Water Softener

RECHARGE BUTTON

The long button at the bottom of the softener status screen (See Figure 29) will show recharge status, including whether a recharge is scheduled (See Figure 41). During a recharge cycle, a countdown clock is displayed in the button (See Figure 32).

RECHARGE NOW

To manually initiate an immediate recharge:

1. Press the RECHARGE button at the bottom of the softener status screen (See Figure 29).

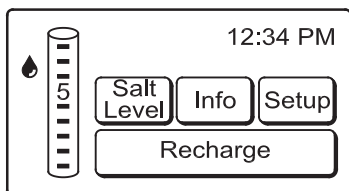

FIG. 29

2. The display will change to show the following screen.

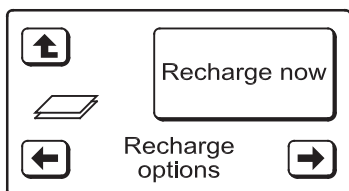

FIG. 30

3. Press the RECHARGE NOW button. The recharge begins and display will change to show a recharge status screen, like the one in Figure 31.

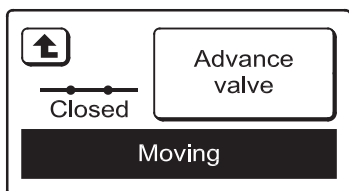

FIG. 31

4. To return to the softener status screen, press the RETURN (⬆) button.

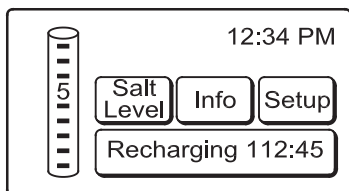

FIG. 32

SET RECHARGE TIME

When the softener's electronic control is first powered up, the default time for starting an automatic recharge is 2:00 a.m. This is a good time in most households because water is not being used.

To change the recharge time:

1. Press the RECHARGE button on the softener status screen (See Figure 33).

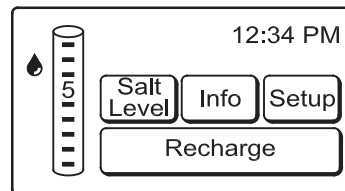

FIG. 33

2. The display will change to show the following screen.

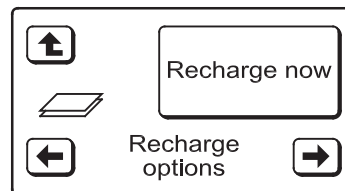

FIG. 34

3. Press the RIGHT (→) button. The display will change to show the following screen.

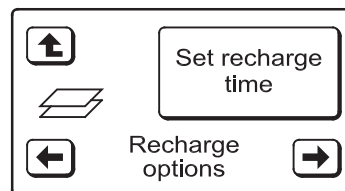

FIG. 35

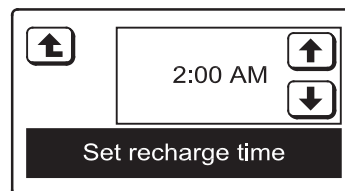

FIG. 36

4. Press the SET RECHARGE TIME button and the display will change to show the **Set recharge time** screen (See Figure 36).
5. Press the UP (↑) or DOWN (↓) buttons to set the recharge time in 1 hour increments. Hold the button down to rapidly advance. Be sure AM or PM is correct (unless softener is set for a 24-hour clock). When the desired recharge start time is shown, press the RETURN (⬆) button. The display will go back to the softener status screen.

Programming Your E-Z Touch Water Softener

SCHEDULE A RECHARGE

To schedule a recharge for the next preprogrammed recharge time (2:00 a.m., or as set on Page 15):

1. Press the RECHARGE button at the bottom of the softener status screen (See Figure 37).

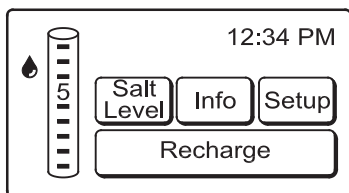

FIG. 37

2. The display will change to show the following screen.

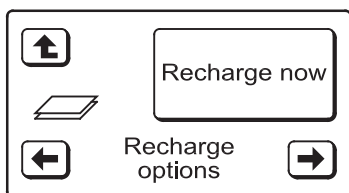

FIG. 38

3. Press the LEFT (←) button. The display will change to show the following screen.

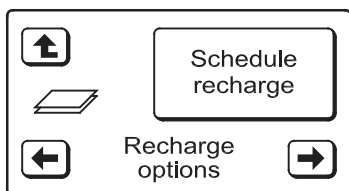

FIG. 39

4. Press the SCHEDULE RECHARGE button. The display will change to show the screen in Figure 40.

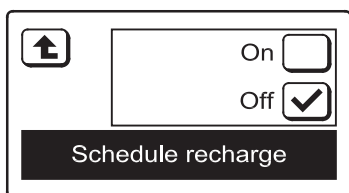

FIG. 40

5. Press the button next to ON, then press the RETURN (⬆) button. The display will go back to the screen shown in Figure 39.
6. To return to the softener status screen, press the RETURN (⬆) button.

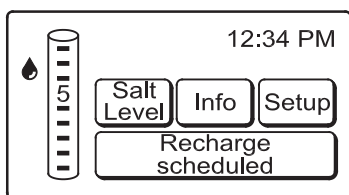

FIG. 41

SETUP BUTTON

The SETUP button on the softener status screen is used to set items of basic operating information:

- Set current time
- Set water's hardness
- Set recharge time
- Set water's iron level
- Advanced setup (Accesses more items that can be set. These are described starting on Page 19)
- Set language

SET TIME

When the softener's electronic control is first powered up, the setup procedure prompts you to set the current time (See Page 12). To change the time at a later date, such as after a long power loss:

1. Press the SETUP button on the softener status screen (See Figure 42).

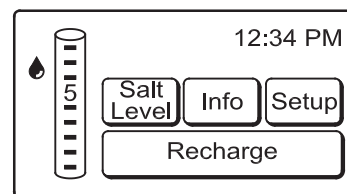

FIG. 42

2. Press the SET TIME button (See Figure 43) and the display will change to show the Set time screen (See Figure 44).

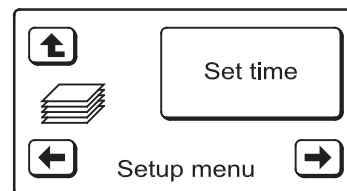

FIG. 43

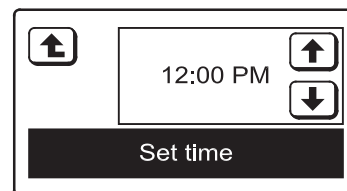

FIG. 44

3. Press the DOWN (↓) or UP (↑) buttons to set the current time. Hold the button down to rapidly advance. Be sure AM or PM is correct (unless softener is set for a 24-hour clock). When the current time is shown, press the RETURN (⬆) button.
4. To return to the softener status screen, press the RETURN (⬆) button.

Programming Your E-Z Touch Water Softener

SET HARDNESS

When the softener's electronic control is first powered up, the setup procedure prompts you to enter your water's hardness (See Page 12). To change it:

1. Press the SETUP button on the softener status screen (See Figure 45).

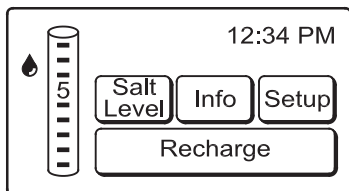

FIG. 45

2. Press the RIGHT (→) button to display the screen shown in Figure 46.

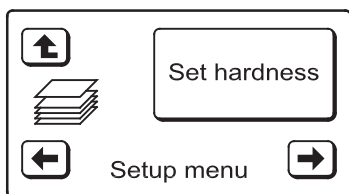

FIG. 46



FIG. 47

3. Press the SET HARDNESS button and the display will change to show the **Set hardness** screen (See Figure 47).

4. Press the UP (↑) or DOWN (↓) buttons to set the value for your water's hardness. Hold the button down to rapidly advance. When the correct hardness is shown, press the RETURN (↵) button.

NOTE: Do not increase the hardness setting to compensate for iron in your water. The electronic control will compensate automatically after you set the iron level, as described under "Set Iron Level" on this page.

5. To return to the softener status screen, press the RETURN (↵) button.

SET RECHARGE TIME

Refer to Page 15 for instructions on setting the start time for automatic recharges.

SET IRON LEVEL

The softener's electronic control can adjust cycle times to compensate for ferrous (clear water) iron in the water. When the softener's electronic control is first powered up, the iron level is set at 0.

NOTE: The iron level will always be displayed in ppm (parts per million), regardless of whether the **Hardness units** setting is grains or ppm. The conversion factor is 3 grains per ppm of clear water iron.

To enter your water's iron level:

1. Press the SETUP button on the softener status screen (See Figure 45).
2. Press the RIGHT (→) button three times to display the screen shown in Figure 48.

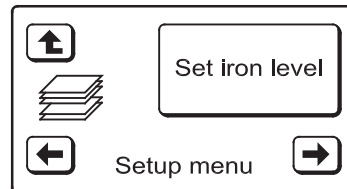

FIG. 48

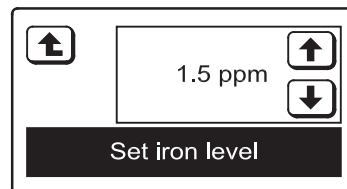

FIG. 49

3. Press the SET IRON LEVEL button and the display will change to show the **Set iron level** screen (See Figure 49).

4. Press the UP (↑) or DOWN (↓) buttons to set the value for iron in your water. Hold the button down to rapidly advance. When the correct iron level is shown, press the RETURN (↵) button.

5. To return to the softener status screen, press the RETURN (↵) button.

Retrieving Information from the Water Softener Management System

INFO (INFORMATION) BUTTON

The INFO button on the softener status screen is used to look up the following information about the softener and its operations:

- Current water flow
- Average daily water use
- Water used today
- Capacity remaining
- Days in use
- Total recharges

To display one of these screens:

1. Press the INFO button at the center of the softener status screen (See Figure 50).

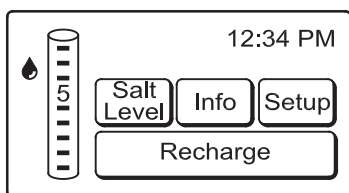

FIG. 50

2. Press the RIGHT (→) or LEFT (←) buttons to scroll through the six information screens (Figures 51-56).
3. To return to the softener status screen, press the RETURN (⬆) button.

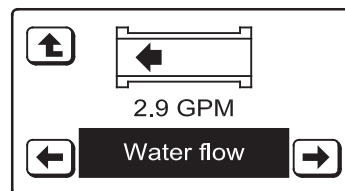

FIG. 51

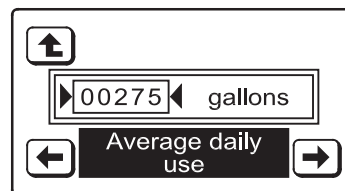

FIG. 52

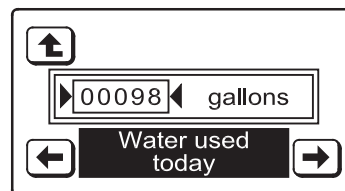

FIG. 53

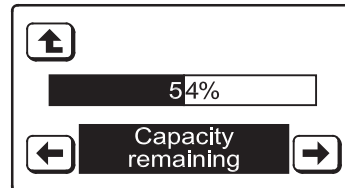

FIG. 54

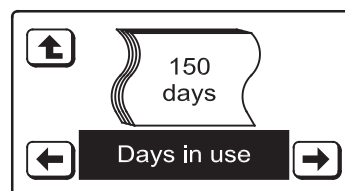

FIG. 55

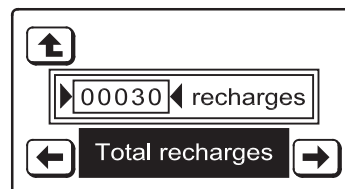

FIG. 56

Customizing Features / Options

SET CLEAN FEATURE

The Clean Feature with Sediment Guard technology is beneficial on water supplies containing ferrous (clear water) iron. The default setting is OFF. When set to ON, an additional backwash and fast rinse cycle will occur first, preceding the normal regeneration sequence. This provides extra cleaning of the resin bed before it is regenerated with the salt brine. To conserve water set this feature OFF if your water supply does not contain iron or sediments.

To set this feature:

1. Press the SETUP button on the softener status screen.
2. Press the LEFT (←) button twice to display the screen shown in Figure 57.

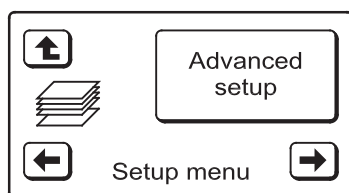

FIG. 57

3. Press the ADVANCED SETUP button. The display will change to the following screen.

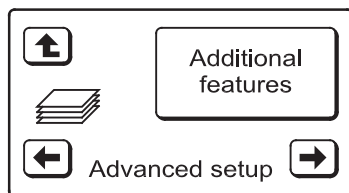

FIG. 58

4. Press the ADDITIONAL FEATURES button to display the screen shown in Figure 59.

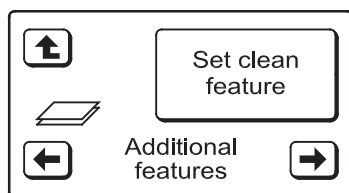

FIG. 59



FIG. 60

5. Press the SET CLEAN FEATURE button and the display will change to show the **Set clean feature** screen (See Figure 60).

continued

6. Press the button next to ON to enable this feature (or OFF to disable it) and then press the RETURN (⬆) button.
7. To return to the softener status screen, press the RETURN (⬆) button three times.

SET CLEAN TIME

The length of the Clean Feature with Sediment Guard technology can be adjusted, from 1 to 30 minutes. The default value for this feature is 7 minutes.

To change the clean time:

1. Press the SETUP button on the softener status screen.
2. Press the LEFT (←) button twice to display the screen shown in Figure 57.
3. Press the ADVANCED SETUP button to display the screen shown in Figure 58.
4. Press the ADDITIONAL FEATURES button to display the screen shown in Figure 59.
5. Press the RIGHT (→) button to display the screen shown in Figure 61.

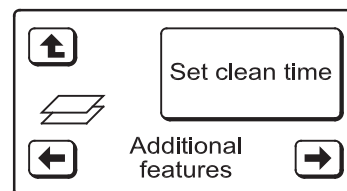

FIG. 61



FIG. 62

6. Press the SET CLEAN TIME button and the display will change to show the **Set clean time** screen (See Figure 62).
7. Press the UP (↑) or DOWN (↓) buttons to set the clean time in 1 minute increments. Hold the button down to rapidly advance. When the desired clean time is shown, press the RETURN (⬆) button.
8. To return to the softener status screen, press the RETURN (⬆) button three times.

Customizing Features / Options

SET SALT EFFICIENCY

When this feature is ON, the water softener will operate at salt efficiencies of 4000 grains of hardness per pound of salt or higher (May recharge more often using smaller salt dosage and less water). The softener is shipped with this feature set OFF, which utilizes the maximum rated capacity while most often achieving maximum salt efficiencies. When installing this unit in the State of California, you MUST turn this feature ON.

To set this feature:

1. Press the SETUP button on the softener status screen.
2. Press the LEFT (←) button twice to display the screen shown in Figure 63.

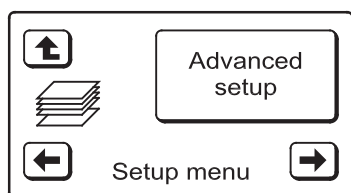

FIG. 63

3. Press the ADVANCED SETUP button. The display will change to the following screen.

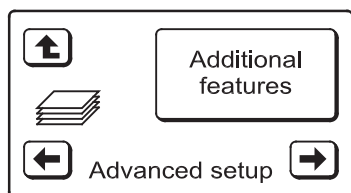

FIG. 64

4. Press the ADDITIONAL FEATURES button.
5. Press the LEFT (←) button to display the screen shown in Figure 65.

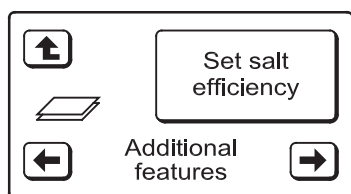

FIG. 65



FIG. 66

6. Press the SET SALT EFFICIENCY button and the display will change to show the **Set salt efficiency** screen (See Figure 66).

7. Press the button next to ON to enable this feature (or OFF to disable it) and then press the RETURN (↑) button.
8. To return to the softener status screen, press the RETURN (↑) button three times.

SET SALT TYPE

Use this feature to program the electronic control with which type of salt you will use. The default is Sodium Chloride (NaCl). Selecting Potassium Chloride (KCl) increases fill and brine rinse times.

To set this feature:

1. Press the SETUP button on the softener status screen.
2. Press the LEFT (←) button twice to display the screen shown in Figure 63.
3. Press the ADVANCED SETUP button to display the screen shown in Figure 64.
4. Press the RIGHT (→) button to display the screen shown in Figure 67.

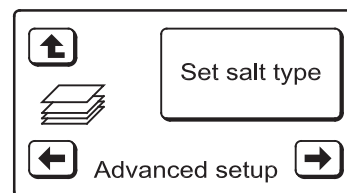

FIG. 67

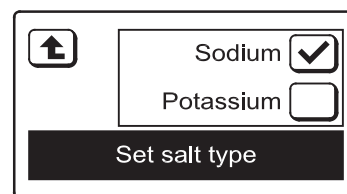

FIG. 68

5. Press the SET SALT TYPE button and the display will change to show the **Set salt type** screen (See Figure 68).
6. Press the button next to the type of salt you will use. When the correct salt type is checked, press the RETURN (↑) button.
7. To return to the softener status screen, press the RETURN (↑) button twice.

Customizing Features / Options

SET UNITS

The softener can be set to display values such as volume and water hardness in either English or Metric units. In addition the clock may be set to display time in either 12-hour (AM/PM) or 24-hour format.

VOLUME UNITS

To select between gallons and liters as volume units:

1. Press the SETUP button on the softener status screen.
2. Press the LEFT (←) button twice to display the screen shown in Figure 69.

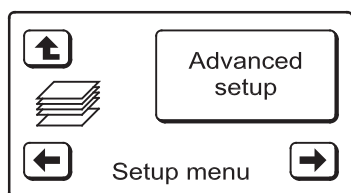

FIG. 69

3. Press the ADVANCED SETUP button. The display will change to the following screen.

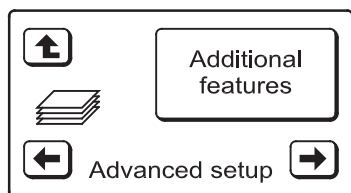

FIG. 70

4. Press the RIGHT (→) button twice to display the screen shown in Figure 71.

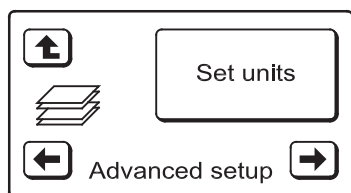

FIG. 71

5. Press the SET UNITS button and the display will change to show the **Volume units** screen (See Figure 72).

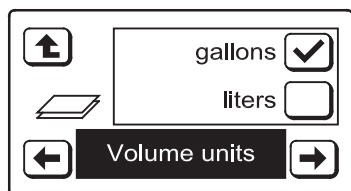

FIG. 72

6. Press the button next to the desired volume units and then press the RETURN (↵) button.
7. To return to the softener status screen, press the RETURN (↵) button twice.

TIME FORMAT

To select between 12-hour (AM/PM) and 24-hour time format:

- 1-5. Go to the **Volume units** screen by following Steps 1-5 in "Volume Units" in the previous column.
6. Press the RIGHT (→) button to display the **Time format** screen (See Figure 73).

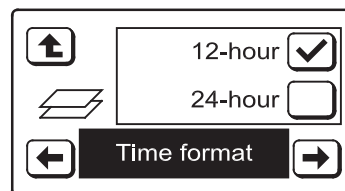

FIG. 73

7. Press the button next to the desired time format and then press the RETURN (↵) button.
8. To return to the softener status screen, press the RETURN (↵) button twice.

HARDNESS UNITS

To select between grains and ppm (parts per million) as water hardness units:

- 1-5. Go to the **Volume units** screen by following Steps 1-5 in "Volume Units" in the previous column.
6. Press the LEFT (←) button to display the **Hardness units** screen (See Figure 74).

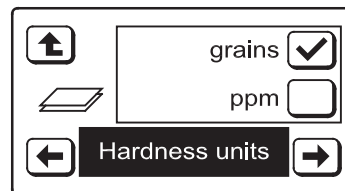

FIG. 74

7. Press the button next to the desired hardness units and then press the RETURN (↵) button.
8. To return to the softener status screen, press the RETURN (↵) button twice.

Customizing Features / Options

POWER OUTAGE MEMORY

If electrical power to the water softener is lost, "memory" built into the electronic control circuitry will keep all settings for up to six hours. While the power is out, the display is blank and the water softener will not regenerate. When electrical power is restored, the following will occur.

You have to reset the current time only if the display's backlight is flashing and the **Set time** screen is displayed instead of the softener's status screen.

Even if the clock is incorrect after a long power outage, the softener operates as it should to keep your water soft. However, regenerations may occur at the wrong time of day until you reset the clock to the correct time of day.

NOTE: If the water softener was regenerating when power was lost, it will now finish the cycle.

RESTORE FACTORY SETTINGS

This feature resets the softener's electronic controller to its initial startup condition. All settings, such as language, current time and water hardness, are cleared and returned to their default values. The user must then follow the setup procedure (See Page 12) before the softener will be ready to run again.

1. Press the SETUP button on the softener status screen.
2. Press the LEFT (←) button twice to display the screen shown in Figure 75.

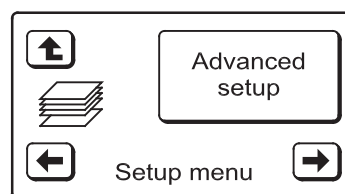

FIG. 75

3. Press the ADVANCED SETUP button. The display will change to the following screen.

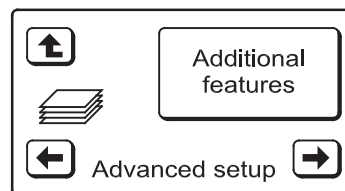

FIG. 76

4. Press the LEFT (←) button to display the screen shown in Figure 77.

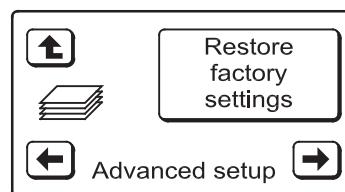

FIG. 77



FIG. 78

5. Press the RESTORE FACTORY SETTINGS button and the display will change to show the **Restore factory settings** screen (See Figure 78).
6. Press the button next to YES and then press the RETURN (↑) button.
7. Follow the setup procedure on Page 12.

Routine Maintenance

ADDING SALT

Lift the salt hole cover and check the salt storage level frequently. If the water softener uses all the salt before you refill it, you will experience hard water. Until you have established a refilling routine, check the salt every two or three weeks. Always add if less than 1/4 full. Be sure the brinewell cover is on.

NOTE: If using potassium chloride (KCl), do not fill above level 4 on the brinewell decal.

NOTE: In humid areas, it is best to keep the salt storage level lower, and to refill more often to avoid salt "bridging".

Recommended Salt: Nugget, pellet or coarse solar salts with less than 1% impurities.

Salt Not Recommended: Rock salt, high in impurities, block, granulated, table, ice melting, ice cream making salts, etc.

BREAKING A SALT BRIDGE

Sometimes, a hard crust or salt "bridge" forms in the brine tank. It is usually caused by high humidity or the wrong kind of salt. When the salt "bridges," an empty space forms between the water and the salt. Then, salt will not dissolve in the water to make brine. Without brine, the resin bed is not recharged and hard water will result.

If the storage tank is full of salt, it is difficult to tell if you have a salt bridge. A bridge may be underneath loose salt. Take a broom handle, or like tool, and hold it next to the water softener. Measure the distance from the floor to the rim of the water softener. Then, gently push the broom handle straight down into the salt. If a hard object is felt before the pencil mark is even with the top, it is most likely a salt bridge. Gently push into the bridge in several places to break it. Do not use any sharp or pointed objects as you may puncture the brine tank. Do not try to break the salt bridge by pounding on the outside of the salt tank. You may damage the tank.

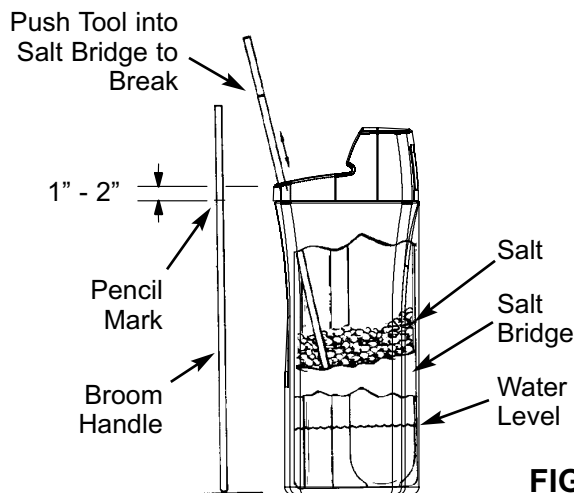
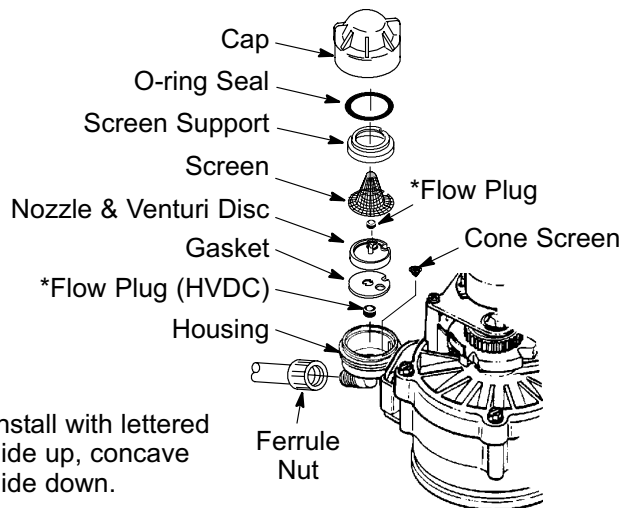

FIG. 79

CLEANING THE NOZZLE & VENTURI

A clean nozzle & venturi (See Figure 80) is a necessity for the water softener to work properly. This small component creates the suction to move brine from the brine tank, into the resin tank. If it should become plugged with sand, silt, dirt, etc., the water softener will not work, and hard water will result.



*Install with lettered side up, concave side down.

IMPORTANT: Be sure small hole in the gasket is centered directly over the small hole in the nozzle & venturi housing. Be sure the numbers are facing up

FIG. 80

To get access to the nozzle & venturi, remove the water softener's top cover. Put the bypass valve(s) into the bypass position. Be sure the water softener is in soft water (service) cycle (no water pressure at nozzle & venturi). Then, holding the nozzle & venturi housing with one hand, unscrew the cap. Do not lose the o-ring seal. Lift out the screen support and screen. Then, remove the nozzle & venturi disc, gasket and flow plug(s). Wash the parts in warm, soapy water and rinse in fresh water. Be sure to clean both the top and bottom of the nozzle & venturi disc. If needed, use a small brush to remove iron or dirt. Do not scratch, misshape, etc., surfaces of the nozzle & venturi.

Gently replace all parts in the correct order. Lubricate the o-ring seal with silicone grease and locate in place. Install and tighten the cap by hand, while supporting the housing. Overtightening may break the cap or housing. Put the bypass valve(s) into service (soft water) position.

Recharge the softener to reduce water level in the tank. This will also assure that the softener is completely recharged and ready to provide softened water again. Check the water level in the tank by looking down the brinewell. If the water level does not drop after a recharge, the problem has not been resolved. Call 1-866-986-3223, Monday - Friday, 8 am to 7 pm, EST.

Troubleshooting

AUTOMATIC ELECTRONIC DIAGNOSTICS

This water softener has a self-diagnostic function for the electrical system (except input power and/or water meter). The water softener monitors electronic components and circuits for correct operation. If a malfunction occurs, an error code appears in the display.

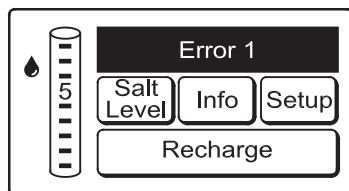

FIG. 82

A service person should be contacted to perform the diagnostics, see below, to further isolate the problem.

Procedure for removing error code from display:

1. Unplug transformer from electrical outlet.
2. Correct problem.
3. Plug in transformer.
4. Wait 6 minutes. The error code will return if the problem was not corrected.

CHECKING THE TURBINE

Use the following procedure to check the turbine that measures water flow through the softener.

1. Press the INFO button on the softener's status screen to display the **Water flow** screen (See Figure 83).

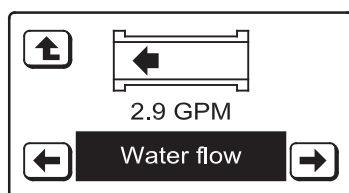

FIG. 83

2. Open a nearby soft water faucet. There should be a non-zero reading in the display with the faucet open.
3. When water is flowing, the **Water used today** screen (See Fig. 84) can be used to check the turbine reading against volume of water exiting the softener. Beginning when this screen is displayed, a beep sounds with each gallon (or liter, as set).

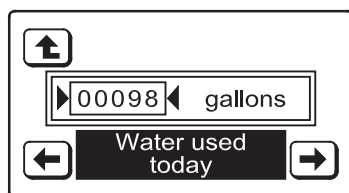

FIG. 84

OTHER INITIAL DIAGNOSTICS

NOTE: Be sure water is in contact with the salt, and not separated by a salt bridge (See "Breaking A Salt Bridge" section).

Other information which may be beneficial in diagnosing problems may be found in the **Total recharges** and **Days in use** information screens. This information is retained by the computer from the first time electrical power is applied to the electronic controller. On the softener's status screen, press the INFO button, then the LEFT (←) button to display these screens (See Page 12).

CHECKING THE MODEL CODE

1. Unplug the softener's transformer and plug it back in, watching the touch screen display.
2. After the "E-Z Touch" screen displays briefly, a screen that looks like Figure 86 will be shown for a few seconds. Take note of the number next to the word "Model:".



FIG. 85

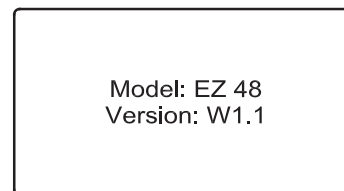

FIG. 86

3. The correct code for Model WHES48 is "EZ 48." This code identifies the softener model. If an incorrect model code is displayed, the softener will operate on incorrect configuration data.

Troubleshooting

MANUAL ADVANCE REGENERATION CHECK

This check verifies proper operation of the valve motor, brine tank fill, brine draw, regeneration flow rates, and other controller functions. Always make the initial checks first.

Use the following procedure to advance the water softener through the regeneration cycles to check operation. In the following steps you will use the ADVANCE VALVE button to move the valve into each cycle and check correct switch operation (See Figures 87 & 88).

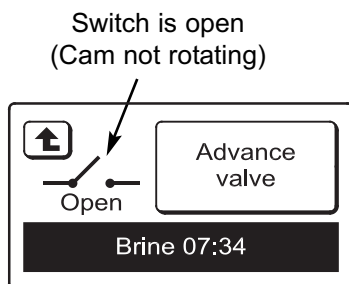

FIG. 87

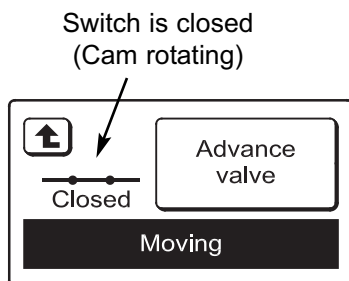

FIG. 88

NOTE: The following procedure shows the normal recharge cycle. If the **Clean feature** is set to ON, there will be an extra backwash and fast rinse before the normal regeneration sequence.

1. Press the RECHARGE button on the softener's status screen.
2. Press the RECHARGE NOW button to initiate a recharge. The softener's valve advances from the service to fill position.
3. Remove the brinewell cover and, using a flashlight, observe fill water entering the tank.

If water does not enter the tank, look for an obstructed nozzle, venturi, fill flow plug, brine tubing, or brine valve riser pipe.

4. After observing fill, press the ADVANCE VALVE button to move the softener's valve into the brine position. A slow flow of water to the drain will begin. Verify brine draw from the brine tank by shining a flashlight into the brinewell and observing a noticeable drop in the liquid level. This may take 15 to 20 minutes.

NOTE: Be sure water is in contact with the salt, and not separated by a salt bridge (See "Breaking A Salt Bridge" section).

If the water softener does not draw brine, check for (most likely to least likely):

- Dirty or plugged nozzle and venturi, see "Cleaning the Nozzle and Venturi" section.
- Nozzle and venturi not seated on the gasket, or gasket deformed
- Valve seals leaking.
- Restriction in valve drain, causing a back-pressure (bends, kinks, elevated too high, etc.). See "Install Valve Drain Hose" section.
- Obstruction in brine valve or brine tubing.

NOTE: If water system pressure is low, an elevated drain hose may cause back pressure, stopping brine draw.

5. Press the ADVANCE VALVE button to move the softener's valve into the backwash position. Look for a fast flow of water from the drain hose. Check that the drain can adequately handle the flow and volume.

An obstructed flow indicates a plugged top distributor, backwash flow plug, or drain hose.

6. Press the ADVANCE VALVE button to move the softener's valve into the fast rinse position. Again look for a fast drain flow. Allow the softener to rinse for a few minutes to flush out any brine that may remain in the resin tank from the brining cycle test.
7. To return the softener's valve to the service position, press the ADVANCE VALVE button.

Need help troubleshooting? Call Toll Free 1-866-986-3223 Monday- Friday, 8 AM - 7 PM EST
or visit www.ecodynewatertreatment.com

When you call, please be prepared to provide the model, date code and serial number, found on the rating decal, typically located on the rim below the salt lid hinges.

Softener Exploded View

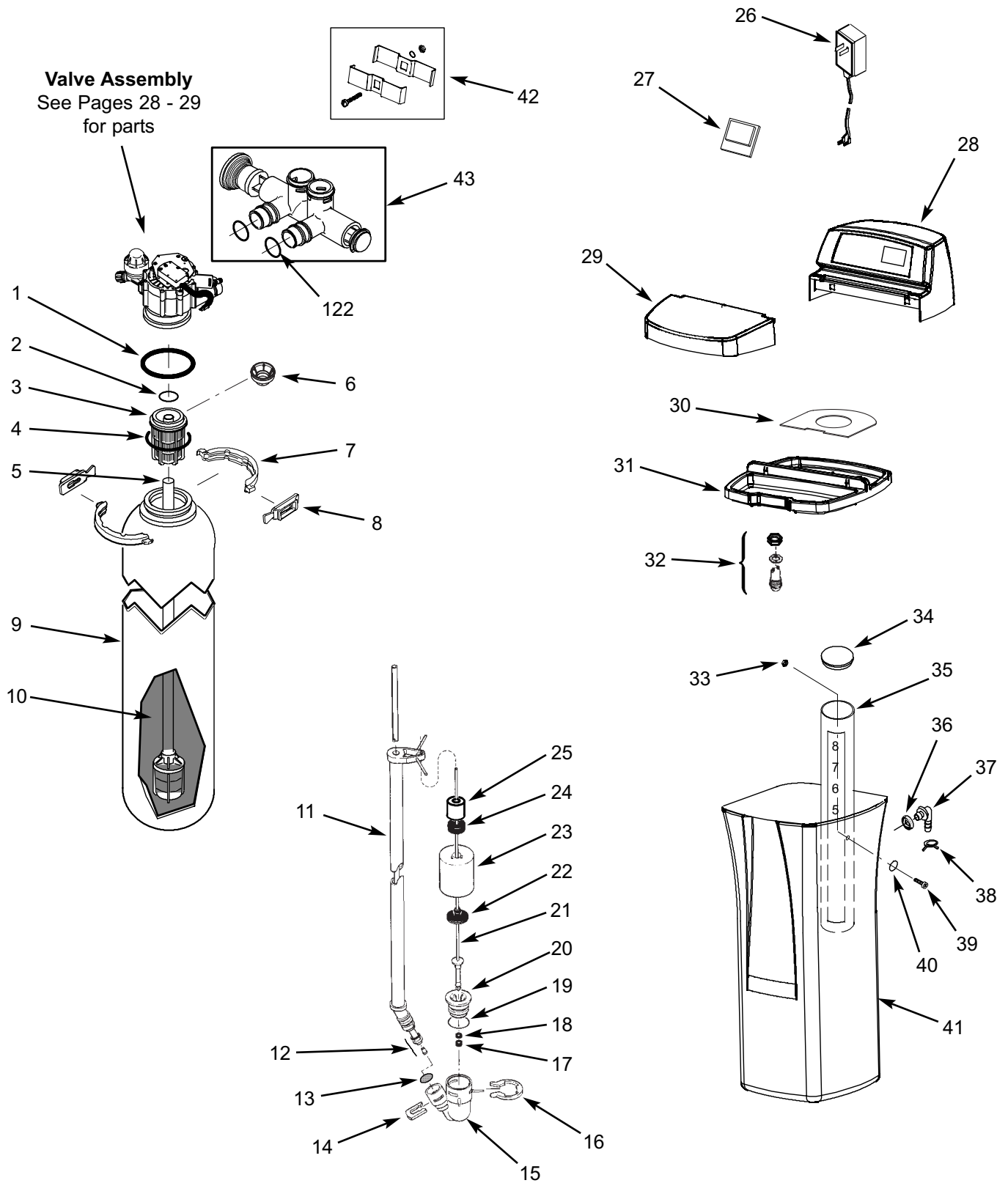

Softener Parts List

Key No.	Part No.	Description
1	7170296	O-Ring, 2-7/8" x 3-1/4"
2	7170254	O-Ring, 13/16" x 1-1/16"
3	7077870	Top Distributor
4	7170270	O-Ring, 2-3/4" x 3"
5	7105047	Repl. Bottom Distributor
6	7265025	Filter Screen
7	7176292	Clamp Section (2 req.)
8	7088033	Retainer Clip (2 req.)
9	7247996	Repl. Resin Tank, 10" x 40"
10	0502272	Resin, 1 cu. ft.
11	7221746	Brine Tube
12	7113016	Tubing Assembly
13	7131365	Screen
14	7142942	Clip
15	7308881	Brine Valve Body
16	7116713	Clip
17	0516924	Bottom Seal Retainer
18	0516211	Seal
19	7170288	O-Ring, 15/16" x 1-3/16"
20	7308904	Guide Cap
21	7220627	Float, Rod & Stem
22	0516947	Float Seal
23	7097202	Float (incl. Key No. 22)
24	0513860	Float Stop
25	7168647	Ceramic Weight
■	7310202	Repl. Brine Valve Assembly

Key No.	Part No.	Description
26	7275907	Transformer
27	7305443	Repl. Electronic Control Board (PWA)
28	7305477	Top Cover & Faceplate Assembly, (order decal below)
■	7330668	Faceplate Decal
29	7305207	Salt Hole Cover (order decal below)
■	7296571	Instruction Decal
30	7296416	Vapor Barrier
31	7305299	Rim
32	7218696	Repl. Light Assembly
33	7082150	Nut
34	7219888	Brinewell Cover
35	7137824	Brinewell
36	9003500	Grommet
37	1103200	Hose Adaptor
38	0900431	Hose Clamp
39	7262792	Screw
40	7003847	O-Ring
41	7305451	Repl. Brine Tank
42	7248706	Grounding Kit
43	7214383	Bypass Valve (includes 2 ea. of Key Nos. 120 & 122)
■	7310359	Owner's Manual

■ Not illustrated.

To order repair parts call toll free 1-866-986-3223, Monday - Friday, 8 am - 7 pm EST.

Manufactured and warranted by
Ecodyne Water Systems
1890 Woodlane Drive
Woodbury, MN 55125

Questions? Call Toll Free 1-866-986-3223 Monday- Friday, 8 AM - 7 PM EST
or visit www.ecodynewatertreatment.com

When you call, please be prepared to provide the model, date code and serial number, found on the rating decal, typically located on the rim below the salt lid hinges.

Valve Exploded View

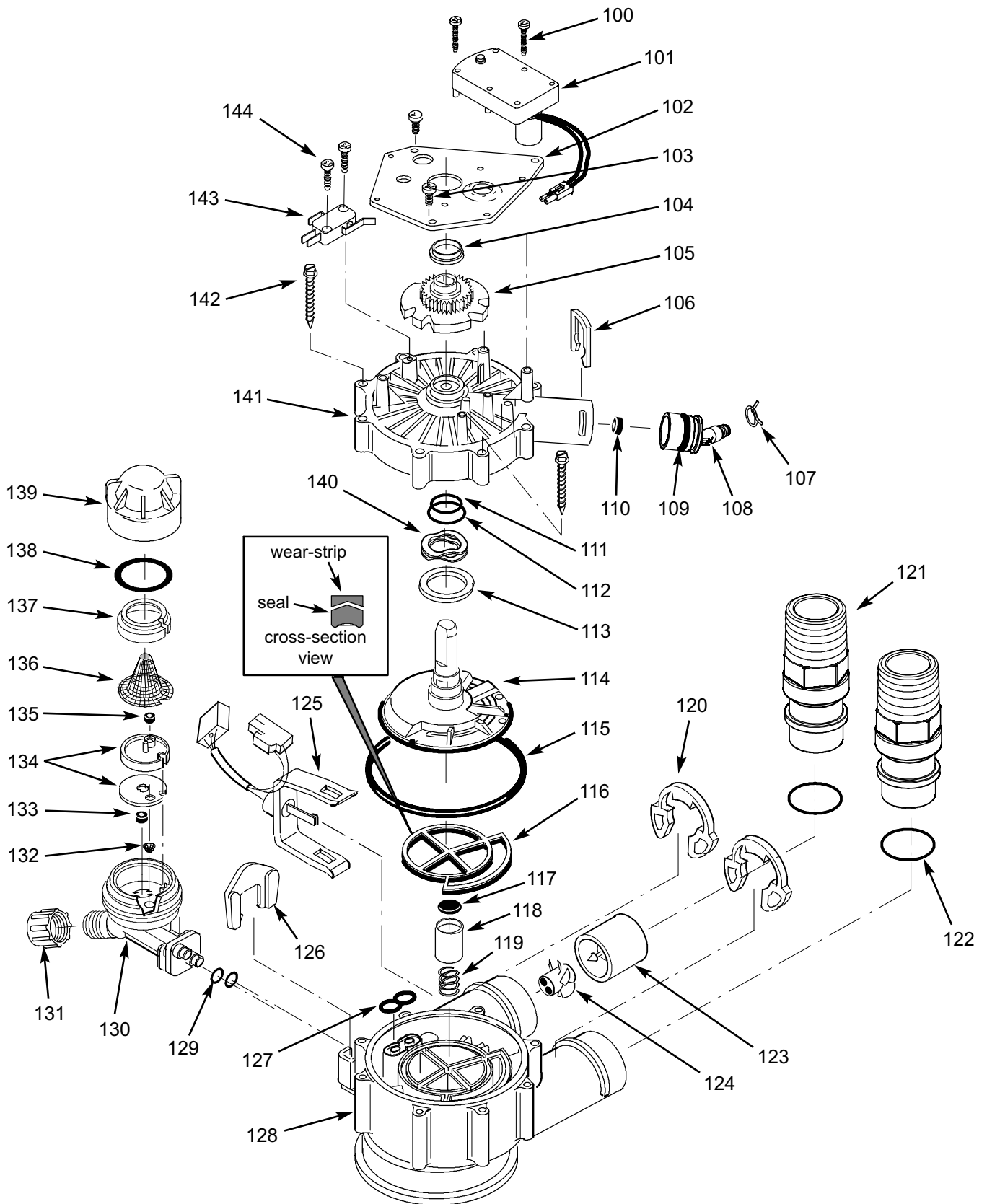

Valve Parts List

Key No.	Part No.	Description
100	7224087	Screw, #8-32 x 1" (2 req.)
101	7286039	Motor (incl. 2 ea. of Key No. 100)
102	7231393	Motor Plate
103	0900857	Screw, #6-20 x 3/8" (3 req.)
104	7171250	Bearing
105	7283489	Cam & Gear
106	7169180	Clip, Drain
107	0900431	Hose Clamp
108	7271270	Drain Hose Adaptor
109	7170288	O-Ring, 15/16" x 1-3/16"
110	0501228	Flow Plug, 2.0 gpm
111	7170327	O-Ring, 5/8" x 13/16"
112	7173024	O-Ring, 1-1/8" x 1-1/2"
113	7174313	Bearing, Wave Washer
114	7185500	Rotor & Disc
115	7173032	O-Ring, 4-1/2" x 4-7/8"
116	7185495	Rotor Seal
117	7172989	Seal
118	7171187	Plug, Drain Seal
119	7129889	Spring
120	7089306	Clip (4 req.)
121	7271204	1" NPT Threaded Adaptor (2 req.)
122	7311127	O-Ring, 1-1/16" x 1-5/16" (4 req.)
123	7094898	Turbine Support
124	7101548	Turbine

Key No.	Part No.	Description
125	7309811	Wire Harness, Sensor
126	7081201	Retainer, Nozzle & Venturi
127	7195482	Seal, Nozzle & Venturi
128	7171145	Valve Body
129	7170319	O-Ring, 1/4" x 3/8" (2 req.)
130	7081104	Housing, Nozzle & Venturi
131	1202600	Nut - Ferrule
132	7095030	Cone Screen
133	1148800	Flow Plug, .3 gpm
134	7114533	Nozzle & Venturi Gasket Kit
	7204362	Gasket Only
135	7084607	Flow Plug, .15 gpm
136	7146043	Screen
137	7167659	Screen Support
138	7170262	O-Ring, 1-1/8" x 1-3/8"
139	7199729	Cap
140	7175199	Wave Washer
141	7171161	Valve Cover
142	7172997	Screw, #10 x 2-5/8" (8 req.)
143	7305150	Switch
144	7140738	Screw, #4-24 x 3/4" (2 req.)
■	7253808	Nozzle & Venturi Assembly (incl. Key Nos. 130 & 132 - 139)
■	7185487	Seal Kit (incl. Key Nos. 111, 112, 115, 116, 117 & 127)
■	3479901	Adaptor Kit, 1" to 1-1/4"

■ Not illustrated.

To order repair parts call toll free 1-866-986-3223, Monday - Friday, 8 am - 7 pm EST.

Manufactured and warranted by
Ecodyne Water Systems
1890 Woodlane Drive
Woodbury, MN 55125

Questions? Call Toll Free 1-866-986-3223 Monday- Friday, 8 AM - 7 PM EST
or visit www.ecodynewatertreatment.com

When you call, please be prepared to provide the model, date code and serial number, found on the rating decal, typically located on the rim below the salt lid hinges.

Free Manuals Download Website

<http://myh66.com>

<http://usermanuals.us>

<http://www.somanuals.com>

<http://www.4manuals.cc>

<http://www.manual-lib.com>

<http://www.404manual.com>

<http://www.luxmanual.com>

<http://aubethermostatmanual.com>

Golf course search by state

<http://golfingnear.com>

Email search by domain

<http://emailbydomain.com>

Auto manuals search

<http://auto.somanuals.com>

TV manuals search

<http://tv.somanuals.com>