

OWNER'S MANUAL

Pro-800W WATT

POWER INVERTER

THE WHISTLER GROUP, INC CORPORATE HEADQUARTERS

3604 N.W. Frontage Rd.
Bentonville, AR 72712
TEL (479) 273-6012 FAX (479) 273-2927
www.whistlergroup.com

CUSTOMER RETURN CENTER

551 N. 13th St.
Rogers, AR 72756
Customer Service Tel (800) 531-0004
Email: info@whistlergroup.com

P/N 401515
© 2010 The Whistler Group, Inc.



If you have questions concerning the operation of this Whistler product please call Customer Service:

1-800-531-0004
Hours:
Monday - Friday
8:00 am - 5:00 pm CT

Please keep the receipt in a safe place. You may register your product online at www.whistlergroup.com. If the unit is returned without a dated proof of purchase, an out of warranty service charge applies. **Note:** Your warranty period begins at the time of purchase. The warranty is validated **only** by your receipt.

Now is the time to record the serial number of the unit in the space provided in the warranty section of the manual.

INTRODUCTION

Dear Whistler Owner,

For many of us, a vehicle is more than just transportation. It can be a mobile office, communications or entertainment center, or simply an expression of our personality. Whistler products are designed to make the time you spend in your vehicle more productive, more fulfilling, safer, or just simply more fun. Our mission is to provide products that improve your driving experience.

Whistler offers a complete line of DC to AC inverters ranging from 100 Watts to 3000 Watts. These inverters offer advanced technology, dependable operation and will provide years of reliable service when used in accordance with our operating instructions.

Your new Whistler power inverter allows you to run most AC appliances right from your car, boat or RV. They're great for weekend use and life on the road. They're also great for power outages!

To fully acquaint yourself with the operation of this inverter, we recommend reading this entire manual.

Sincerely,

THE WHISTLER GROUP, INC.

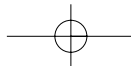

TABLE OF CONTENTS

WHISTLER FEATURES

Topic	Page
Features Summary.....	3
Important Information.....	6
Inverter Basics	7 - 9
• Getting Started	
• Don't Push It	
Operation	10 - 15
• Making the Connection	
• Tips	
• Recharging Equipment	
• Changing the Fuse	
• Power Source	
Additional & Safety Features.....	13 - 14
• Auto Shut Down	
• Thermal Cut Off	
• Low Battery Protection	
Care & Maintenance.....	18 - 19
Technical Operating Principles.....	20 - 21
Operation Summary	22 - 23
Troubleshooting	24 - 26
Specifications.....	27
Warranty Information.....	28 - 30

A Word About WHISTLER Inverters.

Whistler inverters convert low voltage, direct current (DC) to 110 volt alternating household current (AC). The AC output is called "modified sine wave". See "Technical Operating Principles" section for more information. Depending on the model and its rated capacity, Whistler inverters draw power either from standard 12 volt automobile and marine batteries or from portable high power 12 volt sources.

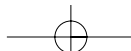
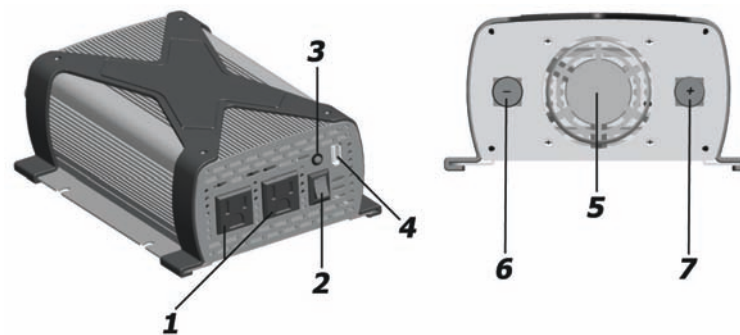

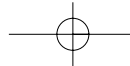

WHISTLER FEATURES

1. Two 110 AC Outlets

2. On/Off Switch

Turns the unit On/Off.

3. On/Shutdown Indicator Light

The LED will illuminate GREEN when the inverter is powered in normal conditions. This light will turn RED and the inverter will automatically shut down (except low voltage alarm) when any of the following problems occur:

- **Short Circuit Protection.** The inverter will shut down until the short is removed.
- **Low Voltage Alarm.** An alarm will sound when the voltage from the battery discharges to 10.5+/-0.5 volts DC. This is an indication that the battery needs to be recharged.
- **Over Voltage Protection.** The inverter will turn itself off when the input exceeds 15.5+/-0.5 volts DC.
- **Under Voltage Protection.** The inverter will turn itself off when the input is less than 10.0+/-0.5 volts DC.
- **Overload Protection.** The inverter will turn itself off when the continuous draw or the surge draw of the equipment being operated exceeds the maximum power rating for the inverter.
- **Thermal Protection.** The inverter will turn itself off when the internal temperature exceeds safe design parameters.

4

WHISTLER FEATURES

4. USB Power Port

5. Cooling Fan

6. Power Input Terminal (Negative)

(Observe proper polarity)

7. Power Input Terminal (Positive)

(Observe proper polarity)

Note:

 In the event of an automatic shut down or continuous audible alarm, turn the inverter OFF (O) until the source of the related problem has been determined and resolved.

5

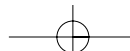

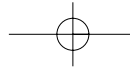

IMPORTANT INFORMATION

Important Information About Your New Whistler Inverter.

This manual will provide you with directions for the safe and efficient operation of your Whistler Inverter. Read the manual carefully before using your new Whistler inverter and keep the manual on file for future reference.

Notes:

Your Whistler inverter is designed to operate from a 12 volt power source only. Never attempt to connect your Whistler inverter to any other power source, including any AC power source.

- The length of the supplied cables is matched for the current needed by the inverter. Making this cable longer will make the inverter less efficient and may cause the cables to heat up.
- Do not attempt to lengthen the supplied power cables.
- 110 volts can be lethal. Improper use of your Whistler inverter may result in property damage, personal injury or loss of life.
- Do not connect the inverter's output to any other power source.
- **Not recommended for use with medical equipment. Check with the appliance manufacturer for compatibility with modified sine wave inverters.** Some appliances may not work well, not at all or be damaged. For more information on compatibility issues, please visit our inverter FAQ page at www.whistlergroup.com.

6

INVERTER BASICS

Getting Started

Power equipment and appliances which operate with motors or tubes require an initial surge of power to get them up and running. This power surge is referred to as the "starting load" or "peak load." (By comparison, electrical devices such as standard light bulbs do not require a large starting load). Once the equipment or appliance has been powered up, it settles down to a slower pace and requires far less electrical power to operate. This lower power requirement is referred to as the "continuous load."

In order to ensure that the capacity of your Whistler inverter is sufficient to meet the required start up load, you must first determine the power consumption of the equipment or appliance you plan to operate.

Power consumption is rated either in wattage or amperes, and information regarding the required "watts" or "amps" generally is stamped or printed on most appliances and equipment. If this information is not indicated on the appliance or equipment, check the owner's manual. **Contact the appliance or equipment manufacturer to determine if the device you are using (TV's, battery charger, computer, etc.) is compatible with a modified sine wave.**

If the power consumption is rated in amps, multiply the number of amps by 110 (AC voltage) to determine the comparable wattage rating. Induction motors, as well as some televisions, may require 2 to 6 times their wattage rating to start up.

For further information on the fundamental operating principles of Whistler inverters and related technical data, see "**Technical Operating Principles.**"

7

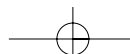

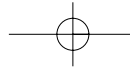

INVERTER BASICS

Don't Push It.

Although your Whistler inverter has the capacity to provide power output (excess current) equal to approximately two times its rated wattage capacity for a very brief period, it is designed to operate equipment and appliances with start up load wattage ratings no higher than its own maximum continuous wattage rating.

For example, the Pro-800W model has a maximum continuous rating of 800 watts. Although this model has the capacity to briefly provide more than its continuous power (that is, excess current), it is designed to operate equipment and appliances with start up load requirements of 800 watts or less.

Consequently, if the start up load rating of your equipment or appliance slightly higher than the maximum continuous rating of the inverter, the inverter will attempt to start loads above the continuous rating.

To determine whether your inverter will operate a particular piece of equipment or appliance, run a test. The inverter is designed to shut down automatically in the event of a power overload. Testing appliances and equipment with start up load ratings comparable to your inverter wattage rating will not damage the inverter.

INVERTER BASICS

If a piece of equipment or an appliance will not operate, first confirm that the inverter has been properly connected to the 12 volt power source (See "Making The Connection"). If all connections have been properly made, turn the inverter rocker switch ON (I), OFF (O) and ON (I) again in quick succession. If this procedure is unsuccessful, it is likely that the inverter does not have the required start up capacity to operate the equipment or appliance in question.

Note:

- Most heat generating appliances require start up loads in excess of 1000 watts and the inverter will not operate such appliances as coffee makers, irons, hair dryers or heaters.
- The inverter's USB Port does not support data communications.
- USB power is always on and independent of the inverter's on/off switch.

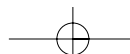

OPERATION

Making the Connection.

This inverter is designed to connect to your 12 volt battery by the supplied #8 AWG gauge cables.

1. Make certain that the inverter's rocker switch is in the OFF (O) position.
2. Connect the cables to the power input terminals at the rear of the inverter and tighten the screws to make a secure connection. *Do not use tools to tighten these screws.*
3. Connect the cable from the (BLACK) Negative (-) terminal on the inverter to the Negative (-) terminal on the 12 volt power source. Make certain the connection is secure.
4. Confirm that the cable you have just installed is properly connected. Specifically, make certain that the cable is connected to the Negative (-) terminals on both the inverter and the 12 volt power source.
5. Connect the cable from the (RED) Positive (+) terminal on the inverter to the Positive (+) terminal on the power source.

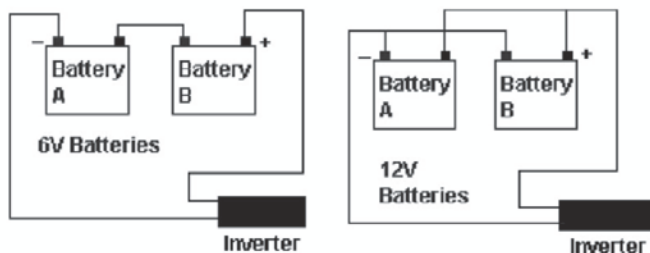

10

OPERATION

Note:

- Loose connections can result in a severe decrease in voltage which may cause damage to the wires and insulation.
 - Failure to make proper connection between the inverter and the power source will result in reverse polarity. Reverse polarity will blow the internal fuses in the inverter and may cause permanent damage to the inverter. **Damage caused by reverse polarity is not covered under the Whistler warranty.**
 - Making the connection between the Positive (+) terminals may cause a spark as a result of current flowing to the capacitors in the inverter. This is a normal occurrence. Due to the potential for sparking, however, it is extremely important that both the inverter and the 12 volt battery be well removed from any possible source of flammable fumes or gases.
Failure to heed this warning could result in fire or explosion.
6. For safe and proper operation of the inverter when not using the supplied cables, connect the inverter to the power source with the proper gauge wire available and in the shortest length practical. When the inverter and the battery are set up within four feet of each other, use a minimum of #8 gauge wire to make the connections. Within four to six feet, use #6 gauge wire. At distances between six feet to ten feet, use #4 gauge wires connected to the battery.

11

OPERATION

7. Run a ground from the Ground Lug Terminal at the rear of the inverter to a proper grounding point using the shortest practical length of 18 AWG wire. Selection of the grounding point will depend on where you are using the inverter. The ground wire may be connected to the chassis of your vehicle or to the grounding system in your boat or to the earth* if you are operating the inverter in a remote location. Before connecting to the ground, make certain that the inverter is turned off.

Operating the inverter without properly grounding it may result in electric shock.

* This ground can't be the same ground as the AC ground.

8. Confirm that the equipment or appliance to be operated is turned off. Plug the equipment or appliance into one of the AC receptacles on the front panel of the inverter.
9. Turn the inverter to the ON (I) position. Turn on the equipment or appliance.
10. Plug the USB powered device into the inverter's USB power port.

OPERATION

Note:

- The audible alarm may make a momentary "chirp" when the inverter is turned OFF (O). The same alarm may also sound when the inverter is being connected to or disconnected from the 12 volt power source.
- The use of an extension cord from the inverter to the appliance or equipment being operated will decrease the power being delivered to the load. For best operating results, the extension cord should be no more than 50 feet long.
- Check frequently to ensure that the input and output connections are secure. Loose connections may damage the inverter, the power source, or may generate excessive heat.

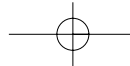

OPERATION

Important Information on Battery Chargers

Using your inverter with battery chargers for power tools, flashlights, video cameras and laptop computers may cause damage to the inverter or the charging unit. Check with the appliance manufacturer for compatibility with modified sine wave inverters if you're unsure.

Although we advise against it, if you attempt to use a charging unit, monitor the temperature of the charging unit for approximately 10 minutes. If the charging unit becomes unusually warm, disconnect it from the inverter immediately.

Don't Blow A Fuse.

This inverter is equipped with internal spade type fuses. With reasonable care, it should not be necessary to replace the fuse(s) in your inverter.

Most blown fuses are the result of reverse polarity or a short circuit within the appliance or equipment being operated. If the fuse(s) does blow, turn off and disconnect the appliance or equipment from the inverter immediately, repair the related problem and replace the fuse(s). The internal fuses are replaceable, however only electronic knowledgeable people should attempt fuse replacement.

Note:

- Make certain to correct the source of the overload which caused the blown fuse before turning your inverter back ON (I).

OPERATION

The Power Source.

When the engine is off, most batteries will provide ample power to the inverter for one to two hours. The actual length of time is a function of several variables including the age and condition of the battery and the power demand being placed on it by the equipment being operated with the inverter.

If you are using the inverter while the engine is off, we recommend you start the engine every hour and let it run for at least 10 minutes to recharge the battery. We also recommend that the device plugged into the inverter be turned off before turning over the engine.

Although it is not necessary to disconnect the inverter when turning over the engine, the inverter may momentarily cease operation as the battery voltage decreases. When the inverter is not supplying power, and is turned on, it draws very low (<0.80 A).

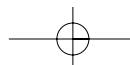

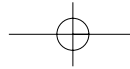

ADDITIONAL FEATURES

Automatic Shut Down & Related Safety Features.

Each Whistler inverter model has an unique LED Indicator warning light system which operates in conjunction with the **automatic shut down feature**. These indicator lights operate as follows:

GREEN LED: System ready.

RED LED: System overload/automatic shut down.

Your inverter will shut down automatically when any of the following problems occur:

1. The power input from the battery drops below 10 volts.
2. The power input from the battery exceeds 15.5+/-0.5 volts.
3. The continuous draw of the appliance or equipment being operated exceeds the design parameters of the inverter.

The inverter is equipped with the following additional safety features:

1. **Thermal Cut Off**
Automatic shut down if internal temperature exceeds safe design parameters.
2. **Low Battery Voltage Alarm/Shutdown Protection**
 - a) When the input voltage from the 12 volt power source drops below 10.5 volts, an audible tone will be heard. This is the low battery voltage alarm.
 - b) The inverter will automatically shut down when the input voltage drops below 10 volts. This protects the battery from completely draining.

ADDITIONAL FEATURES

In the event of automatic shut down or continuous audible alarm, turn the inverter rocker switch to the OFF (O) position until the source of the related problem has been identified and resolved.

Wall Mounting:

The Pro-800W has provisions for wall mounting; slotted holes allow for easy wall mounting of the unit.

For You Television Fans and Audiophiles.

Although the inverter is shielded and filtered to minimize signal interference, some interference with your television picture may be unavoidable, especially with weak signals. However, here are some suggestions that may improve the reception.

1. First, make certain that the television antenna produces a clear signal under normal operation conditions (i.e., at home plugged into a standard 110AC wall outlet). Also, ensure that the antenna cable is properly shielded and of good quality
2. Change the relative positions of the inverter, antenna cables and television power cord.
3. Isolate the television, its power cord and antenna cables and television power cord.
4. Coil the television power cord and the input cables running from the 12 volt power source to the inverter.

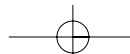

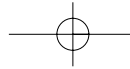

CARE AND MAINTENANCE



Note: Inexpensive sound systems may emit a “buzzing” sound when operated with the inverter. This is due to inadequate filters in the sound system. There is no solution to this problem short of purchasing a sound system with a higher quality power supply.

Some Powerful Advice.

When driving with the inverter in operation, make certain that neither the inverter nor the power cords will impede safe operation of your vehicle. Keep the unit and all cords clear of the steering wheel, gas, brake and clutch pedals and gear shift.

To maintain your inverter in proper working condition, note the following important safety precautions:

- **MOISTURE.** Keep the inverter dry. Do not expose it to moisture. Do not operate the inverter if you, the inverter, the device being operated or any other surfaces that may come in contact with any power sources are wet. Water and many other liquids can conduct electricity which may lead to serious injury or death.
- **HEAT.** For peak efficiency, the ambient air temperature should be between 50° and 80° F. Avoid placing the inverter on or near heating vents, radiators or other sources of heat. Do not place the inverter in direct sunlight.

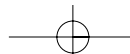

CARE AND MAINTENANCE

- **VENTILATION.** In order to disperse the heat generated while the inverter is in operation, keep it well ventilated. While in use, maintain several inches of clearance around the top and sides of the inverter.
- **FUMES & GASES.** Avoid using the inverter near flammable materials. Do not place the inverter in areas such as battery compartments, where fumes or gases may accumulate.

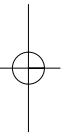

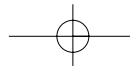

OPERATING PRINCIPLES

For You Technical Types.

1. Basic Operating Principles:

Whistler inverters work in two stages. During the first stage, the DC to DC converter increases the DC input voltage from the power source (e.g. a 12 volt battery) to 145 volts DC. In the second stage, the high voltage DC is converted to 110 volts (60 Hz AC) using advanced power MOSFET transistors in a full bridge configuration. The result is excellent overload capability and the capacity to operate difficult reactive loads. The output waveform resulting from these conversions is a "quasi-sine wave" or a "modified sine wave" as shown below

This stepped waveform is similar to the power generated by utilities and has a broad range of applications.

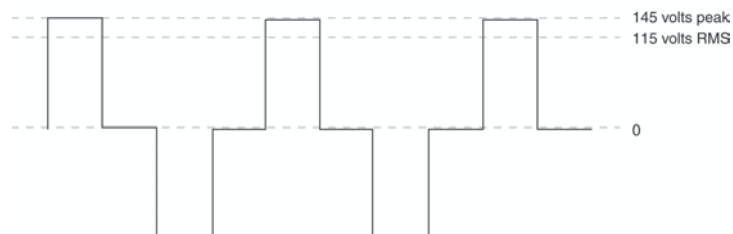

The modified sine wave produced by the inverter

The modified sine wave produced by your Whistler inverter has a root mean square (RMS) voltage of 110 volts. The majority of AC voltmeters measure RMS voltage and assume that the measured waveform will be a pure sine wave.

OPERATING PRINCIPLES

Consequently, these meters will not read the RMS modified sine wave voltage correctly and, when measuring your Whistler inverter output, the meters will read about 20 to 30 volts too low. To accurately measure the output voltage of your inverter, use a true RMS reading voltmeter such as a Fluke 87, Fluke 8060A, Beckman 4410, Triplet 4200 or any multimeter identified as "True RMS."

For more information on inverters see our Inverter FAQ page at www.whistlergroup.com

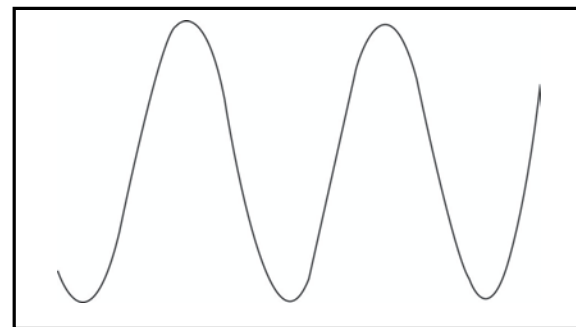

A true sine wave typical of home AC outlet.

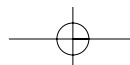

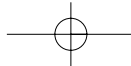

OPERATION SUMMARY

In Review.

- Never attempt to operate your Whistler inverter from any power source other than a 12 volt battery or series of batteries that total 12 volts.
- This inverter is designed to be connected to the power source with the supplied cables or larger cables that properly match the distance from the battery. When utilizing the supplied cables, do not attempt to modify or lengthen them.
- Always make certain that the power cable terminal connections Negative (-) to Negative (-) and Positive (+) to Positive (+). Check these connections frequently to ensure that they are secure.
- Make certain the rated power consumption of the appliance or equipment you wish to operate is compatible with the capacity of your inverter.
- If the rated power consumption of the equipment is in the range of the maximum specified wattage of your converter, test the inverter to ensure that it will operate properly.
- This inverter is not designed to operate heat generating appliances such as coffee makers, irons, hair dryers, toasters and heaters.
- Before attempting to use a battery charger see page 14.

22

OPERATION SUMMARY

- Before attempting to use medical equipment see page 6.
- When operating the inverter with the engine off, start the engine every hour and let it run for at least 10 minutes to recharge the battery.
- In the event of automatic shut down, turn the inverter OFF (O) immediately. Do not restart the inverter until the source of the problem has been identified and corrected.
- To avoid battery drain, always disconnect the inverter when not in use.
- Do not expose the inverter to moisture.
- Avoid placing the inverter near sources of heat or in direct sunlight.
- When in use, make certain that the inverter is properly ventilated.
- Do not use the inverter near flammable materials, fumes, or gases.
- Always operate the inverter in accordance with the instructions in this manual. Failure to do so may result in property damage, personal injury, or loss of life.

23

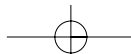

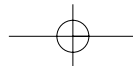

TROUBLESHOOTING

PROBLEM: TV Interference

Problem	Solution
Electrical interference from inverter.	Add a Ferrite data line filter on to the TV power cord. This filter is available at electronic part stores.

PROBLEM: Low or No Output Voltage

Problem	Solution
Using incorrect type of voltmeter to test output voltage.	Use true RMS reading meter. See " For You Technical Types " Section of this manual.

TROUBLESHOOTING

PROBLEM: Low Battery Alarm On All The Time

Problem	Solution
Input voltage below 10.5 volts.	Keep input voltage above 10.5 volts to maintain regulation.
Poor or weak battery condition.	Replace battery.
Inadequate power being delivered to the inverter or excessive voltage drop.	Use lower gauge wire.

Red LED On

Problem	Solution
Equipment has a high start up surge.	Turn inverter power switch OFF (O) and then ON (I) again until the inverter powers your appliance. Repeat as necessary to get your appliance "started".
Battery voltage below 10 volts.	Recharge or replace battery.
Equipment being operated draws too much power.	Use a higher capacity inverter.
Inverter is too hot (thermal shutdown mode).	Allow inverter to cool. Check for adequate ventilation. Reduce the load on the inverter to rated continuous power output.

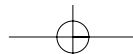

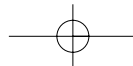

TROUBLESHOOTING

PROBLEM: TV Does Not Work

Problem	Solution
TV does not turn on.	Try rocking the ON/OFF switch of the inverter while leaving the TV ON (see page 9).
	Contact TV manufacturer for start-up surge and/or to find out if TV is compatible with a modified sine wave.
	A larger inverter may be required.

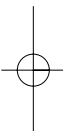

SPECIFICATIONS

Pro-800W WATT INVERTER SPECIFICATIONS

Maximum Continuous Power800 Watts
 Maximum Surge Capability (Peak Power)1600 Watts*
 No Load Current Draw.....≤0.9 A
 WaveformModified Sine Wave
 Operating Input Voltage Range11 – 15.5+/-0.5 Volts
 AC Receptacle..... Dual North American 3 Prong
 Fuses(3) 35 Amp (Spade Type-Internal)
 USB.....5 Volt 500mA Max
 Approximate Dimensions10" L x 5.75" W x 3" H
 Approximate Weight2.42 lbs

*Under certain conditions your inverter may provide up to 2 times the continuous rating for a brief period.

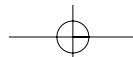
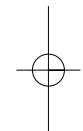

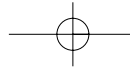

WARRANTY

Consumer Warranty

This Whistler inverter is warranted to the original purchaser for a period of two years from the date of original purchase against all defects in materials and workmanship. **This limited warranty is void if the unit is abused, modified, installed improperly, had its housing removed, or has a missing serial number.** There are no express warranties covering this product other than those set forth in this warranty. All express or implied warranties for this product are limited to two years. Whistler is not liable for damages arising from the use, misuse, or operation of this product.

Service Under Warranty

During the warranty period, defective units will be repaired or replaced (with the same or a comparable model), at Whistler's option, without charge to the purchaser when returned with a dated store receipt to the address below. Inverters returned without a dated store receipt will be handled as described in section "Service Out Of Warranty."

When returning a unit for service, please follow these instructions:

1. Ship the inverter in the original carton or in a suitable sturdy equivalent, fully insured, with return receipt requested, and shipping charges prepaid to:

Whistler Repair Dept.
551 N. 13th St.
Rogers, AR. 72756

Please allow 3 weeks for return.

WARRANTY

IMPORTANT: Whistler will not assume responsibility for loss or damage incurred in shipping. Therefore, please ship your inverter insured with return receipt requested.

2. Include the following clearly printed information:

- Your name and street address (for shipping via UPS), a daytime telephone number, (No P.O. Box please) and an email address (if applicable).
- A detailed description of the problem, i.e. Unit powers up but no AC output.
- A copy of your dated store receipt or bill of sale.

3. Be certain your inverter is returned with its serial number. For reference, please write your unit's serial number in the following space: s/n _____.

Inverters without serial numbers are not covered under warranty.

IMPORTANT: To validate that your inverter is within the warranty period, make sure you keep a copy of your dated store receipt! You may register your warranty online at www.whistlergroup.com, however, for warranty verification purposes, a copy of your dated store receipt must accompany any unit sent in for warranty work.

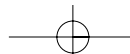

WARRANTY

Service Out Of Warranty

Inverters will be repaired at "out of warranty" service rates when:

- The unit's original warranty has expired.
- A dated store receipt is not supplied.
- The unit has been returned without its serial number.
- The unit has been abused, modified, installed improperly, or had its housing removed.

The out of warranty service fee for your 800 watt Whistler inverter is \$45.00 (U.S.). If you require out of warranty service, please return your inverter as outlined in the section "Service Under Warranty" along with a certified check or money order for the correct amount. Payment may also be made by MasterCard, VISA or American Express; **personal checks are not accepted**. In the event repairs cannot be covered by the service fee, you will be contacted by a Whistler technical service specialist who will outline options available to you. If you elect not to have your inverter repaired/replaced, it will be returned to you along with your certified check or money order.

IMPORTANT: When returning your inverter for service, be certain to include a daytime telephone number and email address (if applicable).

Customer Service

If you have questions concerning the operation of your Whistler inverter, or require service during or after the warranty period, please call Customer Service at 1-800-531-0004. Representatives are available to answer your questions Monday - Friday from 8:00 a.m. to 5:00 p.m. (CT).

Free Manuals Download Website

<http://myh66.com>

<http://usermanuals.us>

<http://www.somanuals.com>

<http://www.4manuals.cc>

<http://www.manual-lib.com>

<http://www.404manual.com>

<http://www.luxmanual.com>

<http://aubethermostatmanual.com>

Golf course search by state

<http://golfingnear.com>

Email search by domain

<http://emailbydomain.com>

Auto manuals search

<http://auto.somanuals.com>

TV manuals search

<http://tv.somanuals.com>