

INSTRUCTION BOOK

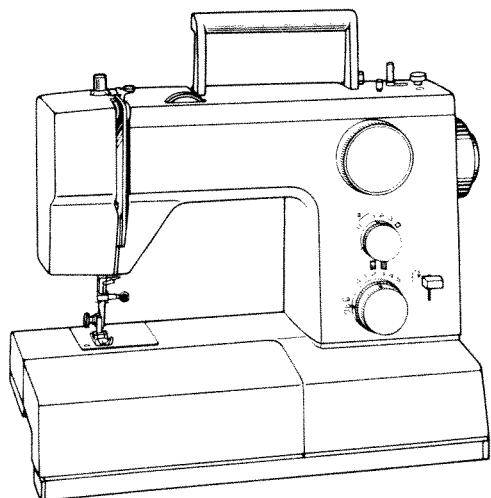

MODEL 1899
1787

WHITE *Sewing machine company*

POLARIZED PLUG CAUTION

To reduce the risk of electric shock, this appliance has a polarized plug (one blade is wider than the other). This plug will fit in a polarized outlet only one way. If the plug does not fit fully in the outlet, reverse the plug. If it still does not fit, contact a qualified electrician to install the proper outlet. Do not change the plug in any way.

SEWING MACHINE

Record in space provided below the Serial No. and Model No. of this appliance.

The Serial No. is located Rear of arm.

The Model No. is located Rear of arm.

Serial No. _____

Model No. **1899 1787**

Retain these numbers for future reference.

Foot Controller Type: YC-482

IMPORTANT SAFETY INSTRUCTIONS

When using an electrical appliance, basic safety precautions should always be followed, including the following:

Read all instructions before using (this appliance).

DANGER – To reduce the risk of electric shock:

This appliance should never be left unattended when plugged in. Always unplug this appliance from the electric outlet immediately after using and before cleaning.

WARNING – To reduce the risk of burns, fire,

electric shock, or injury to persons:

Do not allow to be used as a toy. Close attention is necessary when this appliance is used by or near children.

Use this appliance only for its intended use as described in this manual. Use only attachments recommended by the manufacturer as contained in this manual.

Never operate this appliance if it has a damaged cord or plug, if it is not working properly, if it has been dropped or damaged, or dropped into water. Return the appliance to the nearest authorized dealer or service center for examination, repair, electrical or mechanical adjustment.

Never operate the appliance with any air openings blocked. Keep ventilation openings of the sewing machine and foot controller free from the accumulation of lint, dust, and loose cloth.

Never drop or insert any object into any opening.

Do not use outdoors.

Do not operate where aerosol (spray) products are being used or where oxygen is being administered.

To disconnect, turn all controls to the off ("0") position, then remove plug from outlet.

Do not unplug by pulling on cord. To unplug, grasp the plug, not the cord.

DANGER

Always unplug before relamping. Replace bulb with same type rated 15 watts.

Do not reach for an appliance that has fallen into water. Unplug immediately.

Do not place or store appliance where it can fall or be pulled into a tub or sink.

Do not place in or drop into water or other liquid.

WARNING

1. Keep fingers away from all moving parts. Special care is required around the sewing machine needle.
2. Always use the proper needle plate. The wrong plate can cause the needle to break.
3. Do not use bent needles.
4. Do not pull or push fabric while stitching. It may deflect the needle causing it to break.
5. Switch the sewing machine off ("0") when making any adjustments in the needle area, such as threading needle, changing needle, threading bobbin, or changing presser foot, etc.
6. Always unplug sewing machine from the electrical outlet when removing covers, lubricating, or when making any other user servicing adjustments mentioned in the instruction manual.
7. Never operate on a soft surface such as a bed or couch where the air openings may be blocked.

SAVE THESE INSTRUCTIONS

CONTENTS

1. NAMES OF PARTS	2
2. ACCESSORIES	3
3. BEFORE SEWING	4
Detaching Extension Table	4
Connecting Foot Controller and Power Cord	5
Changing Needle	6
Changing Foot	7
Bobbin Winding	8
Inserting Bobbin	11
Adjusting Lower Tension	12
Drop Feed Lever	12
Threading Upper Thread	13
Twin Needle Threading	14
Decorative Tucks or Designs	14
Drawing Up Lower Thread	15
Foot Pressure	15
Fabric, Thread and Needle Table	16
Pattern Setting	17
4. STRAIGHT SEWING	18
Pattern Selection Dial	18
Stitch Length Dial	18
Starting to Sew	19
Double Presser Foot Lifter	19
Cloth Guide	20
Adjusting Thread Tension	20
Applications of Straight Stitch	21
5. ZIGZAG SEWING	22
Zigzag Width Control	22
Needle Position Control	22
Thread Tension for Zigzag Stitch	22
6. MAKING BUTTONHOLES	23
Determine Length	23
Determine Width	23
Left and Right Side Balance of Buttonhole	25
Cutting Buttonholes	26
Corded Buttonholes	26
7. SEWING ON BUTTONS	27
8. OVERCASTING	28
9. OVERLOCKING	29
Applications of the Elastic Overlockstitch	30
Application of Ultra Stretch	31
Application of Rick-Rack	32
Application of Decorative Fun Patterns	33
0. BLIND HEM STITCH	34
Elastic Blind Hem Stitch	35
1. STRETCH SEAM	36
2. ZIPPER SEWING	37
3. SHELL STITCHING	38
4. PIN TUCKING	39
5. QUILTING	40
6. SCALLOPING	41
7. MENDING	42
Patching	42
Mending a Rip	42
8. APPLIQUE WORK	43
9. EMBROIDERY	44
0. MAINTENANCE	45
Cleaning	45
Oiling	46
1. TROUBLE CHART	47
Changing Light Bulb	48

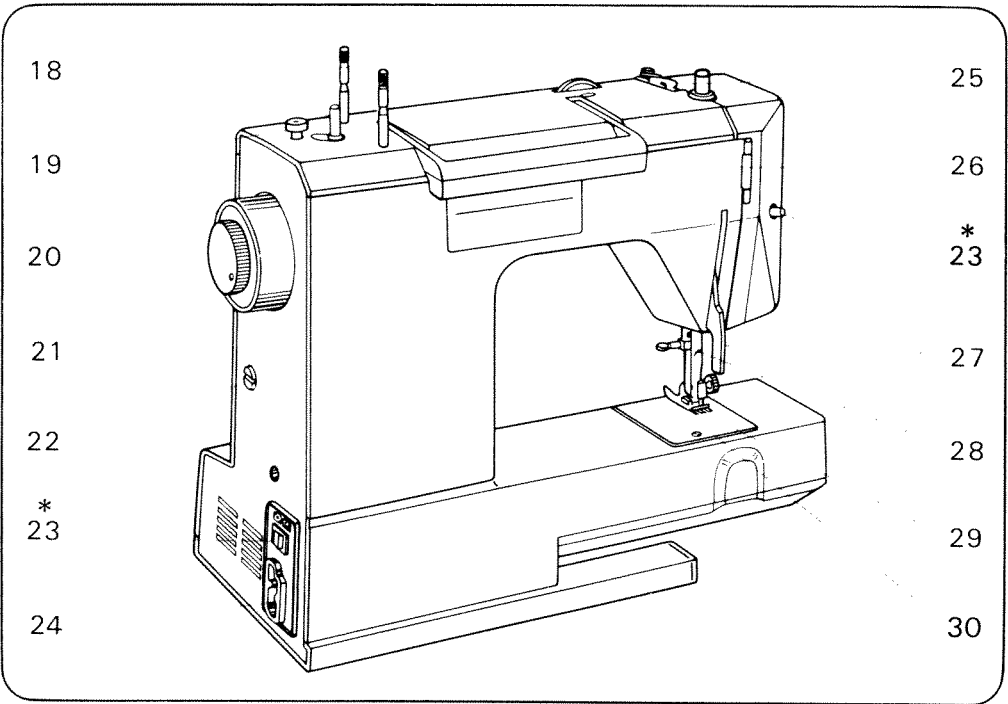
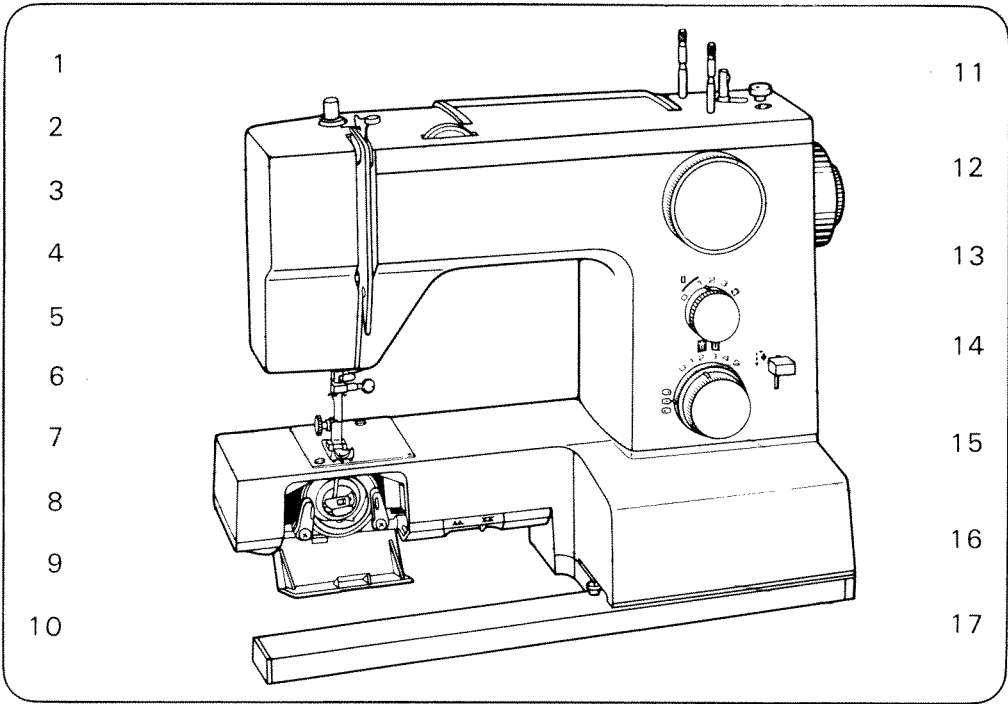











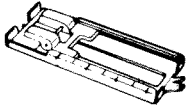

. NAMES OF PARTS

1. Thread guide for bobbin winding
2. Pressure regulator
3. Take-up lever
4. Face cover
5. Upper thread tension dial
6. Thread guide for upper threading
7. Presser foot thumb screw
8. Presser foot
9. Free arm
0. Shuttle cover
1. Spool pins
2. Pattern selection dial
3. Stitch length dial
4. Needle position control
5. Reverse sewing lever
6. Zigzag width control
7. Drop feed lever

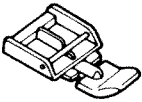
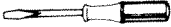
8. Bobbin winding spindle
9. Bobbin winding stopper
0. Handwheel
1. Stop motion knob
2. Special buttonhole adjustment
3. switch *
4. Socket
5. Thread guide for upper threading
6. Handle
7. Presser foot lifter
8. Thread cutter
9. Feed dog
0. Needle plate

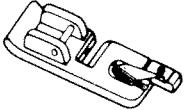
*Specifications vary from country to country.

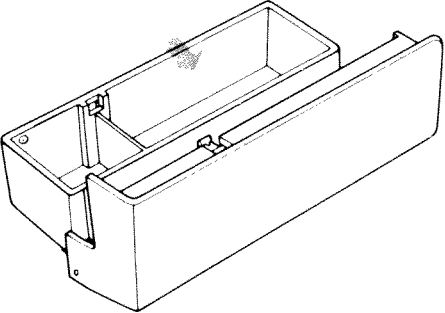
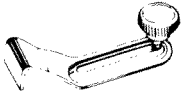
2. ACCESSORIES

<p>Felts (2 pcs.)</p> 	<p>Bobbins (3 pcs.)</p> 
<p>Buttonhole foot</p> 	<p>Needles</p>  <p>Ordinary needles (3 pcs.)</p>  <p>Ball point needle (1 pc.)</p>
<p>Button sewing foot</p> 	<p>Twin needle (1 pc.)</p> 
<p>Zipper foot</p> 	<p>Screw drivers (small)</p>  <p>(large)</p> 
<p>Roll hemming foot</p> 	<p>Oiler</p> 
<p>Quilting guide</p> 	 <p>Accessories are stored in extension table.</p>
<p>Cloth guide</p> 	
<p>Buttonhole cutter</p> 	

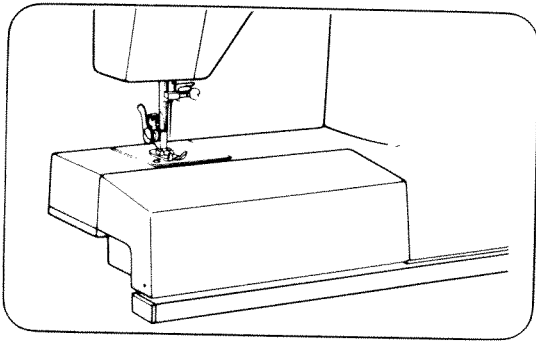

3. BEFORE SEWING

Machine is stored in flat-bed style which makes your work easier in ordinary sewing.

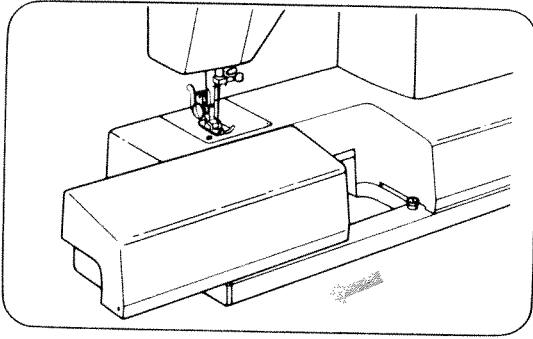

Detachable Extension Table

Slide table off and the machine is used as a free-arm model.

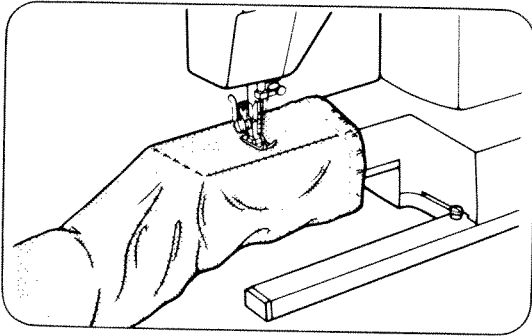

Free-arm is convenient to sew or embroider; trousers, sleeves, cuffs of T-shirts, blouses, etc.

Do vice-versa of above steps to attach extension table.

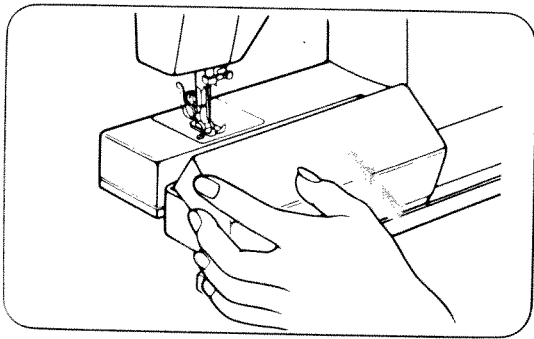

To open lid of accessory box, push it open, as illustrated.

Connecting foot controller and power cord

Connect foot controller and power cord 1 2.

Before plugging in your machine, be sure that voltage is same as that of your machine. (written on a plate at back of machine)

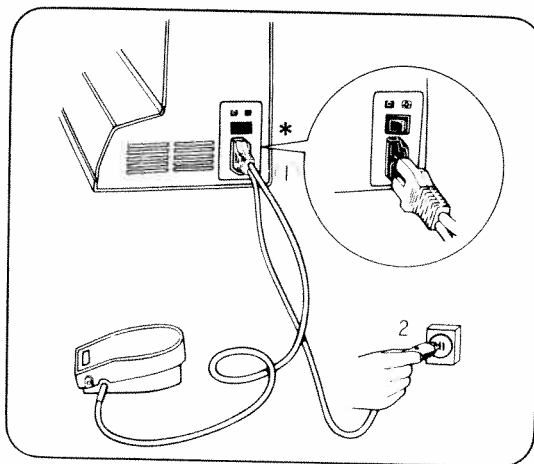

a Switch on put power on the machine and turn on the sewing light.

b Push button to turn sewing light on and off.

Always switch off or unplug machine when not in use.

*Specifications vary from country to country.

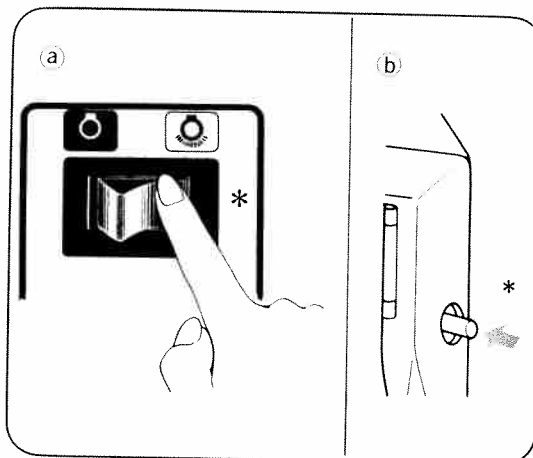

The more you press foot controller, the faster the machine runs.

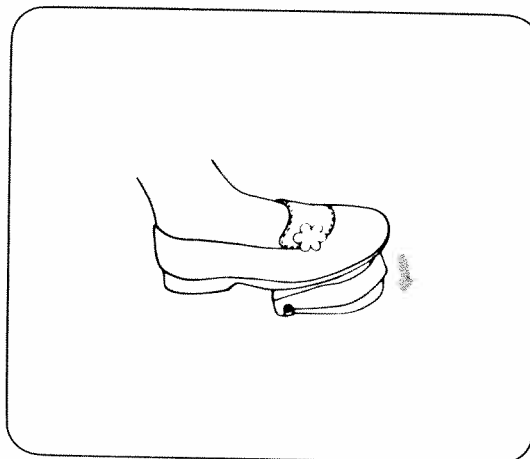

Changing Needle

Set needle in the highest position by turning handwheel towards you.

Loosen needle clamp screw and remove needle.

With flat face away from you, insert a new needle into groove of needle bar.

Push needle until it reaches stopper (a) and tighten needle clamp screw firmly.

Always use a straight needle with a sharp point.

Using defective or worn needles not only causes stitch skipping, breakage of needles or snapping of thread; it also can damage hook and needle plate.

Proper needle

straight shaft

sharp point

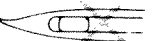
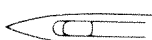

Changing Foot

Raise presser foot lifter ①.

Set needle in the highest position by turning handwheel towards you ②.

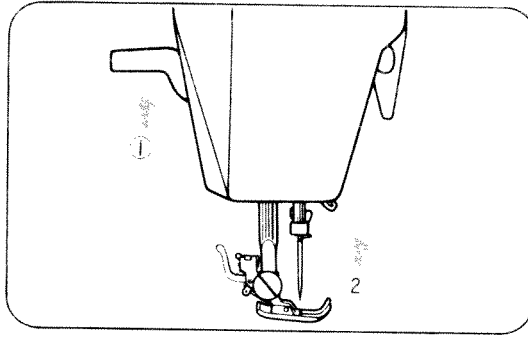

Snap-on Presser Foot:

Push the lever a in the arrow direction so that the presser foot will come off.

Position a new foot with the pin b right under the groove of the holder.

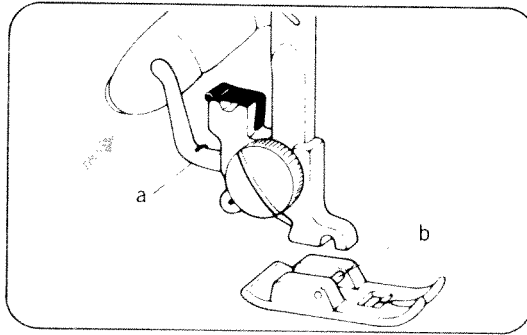

Lower the presser foot lifter so that the foot will be automatically snapped on.

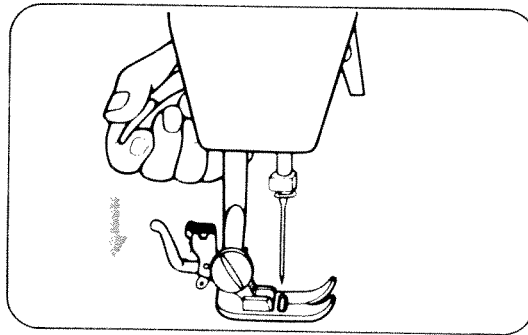

When you fail to catch the foot, push the lever in the arrow direction slightly.

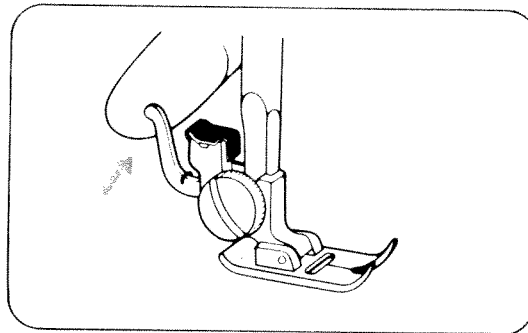

Bobbin Winding

Set needle in the highest position by turning handwheel towards you.

Open shuttle cover.

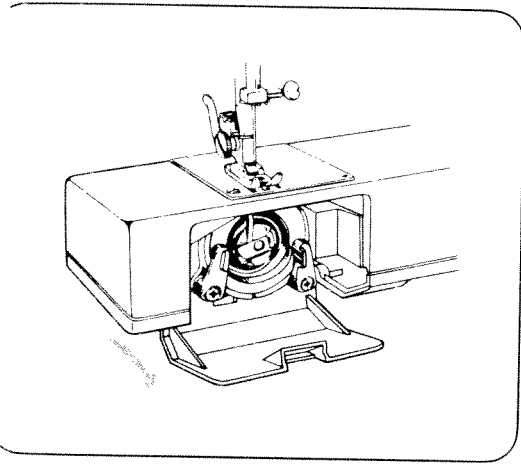

Open latch of bobbin case and take it out.

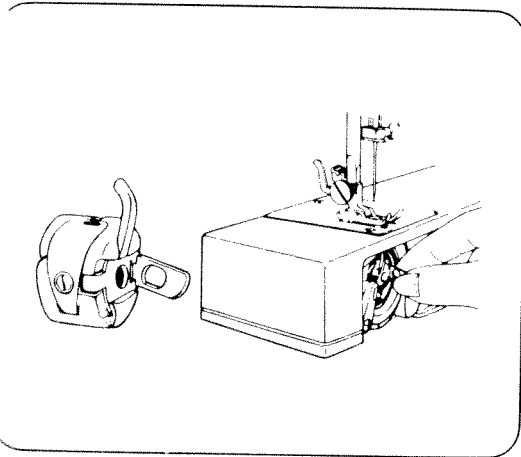

Close latch of bobbin case and bobbin comes out easily.

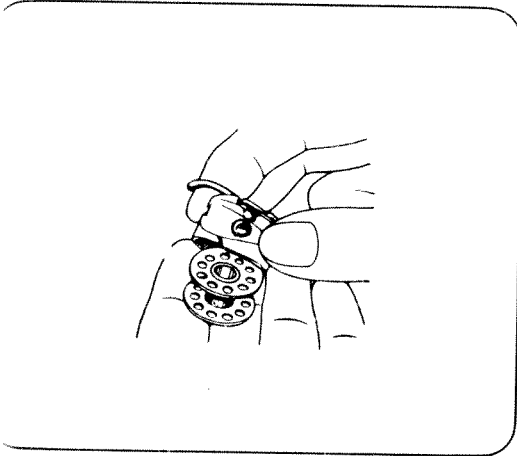

Push back to fold handle.
Pull out spool pin and put a felt
on spool pin.

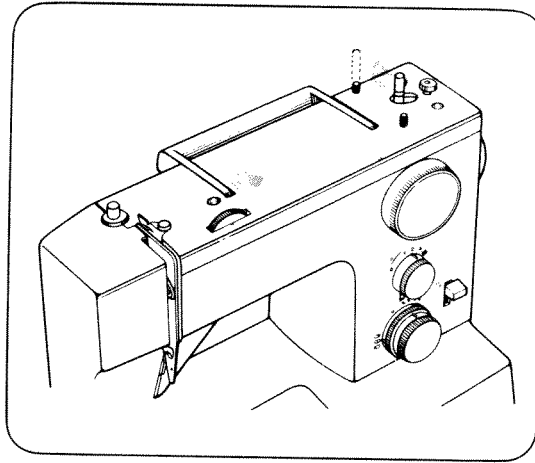

Put a spool on spool pin.
Draw thread from spool pin
through thread guide and pre-
tension device, following numb-
ers 1 and 2.

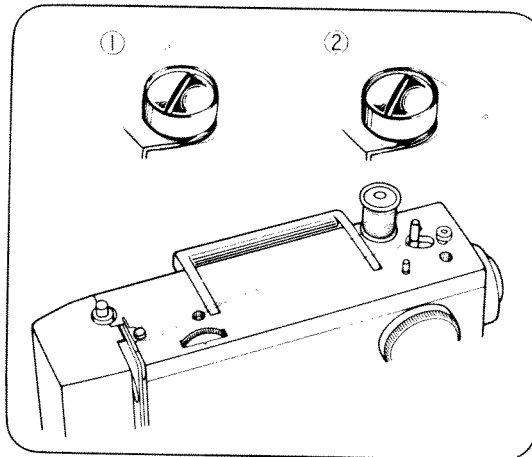

Wind thread clockwise around
bobbin several times.
Push bobbin on to spindle.

Holding handwheel with your left
hand disengage handwheel by
unscrewing stop motion knob.

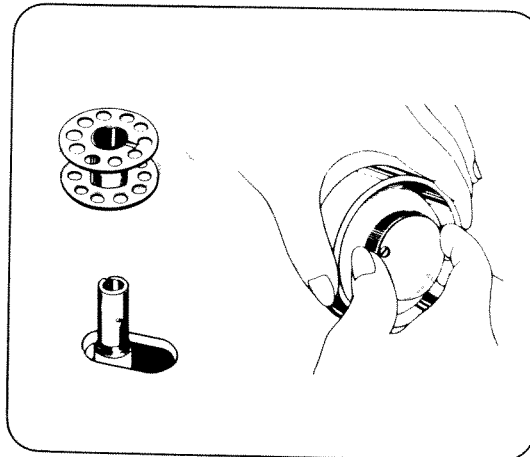

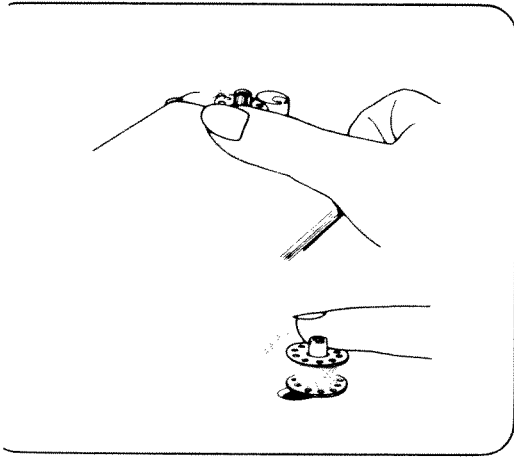

Push bobbin to right and press down foot controller.

Machine stops automatically when bobbin is full.

Push bobbin to left, to disengage from wheel.

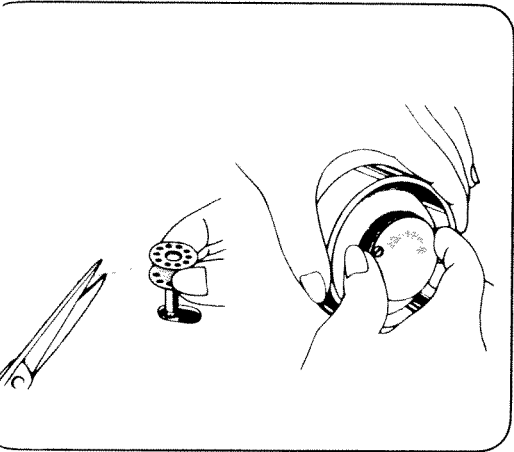

Take off bobbin from spindle and cut thread.

Retighten stop motion knob.

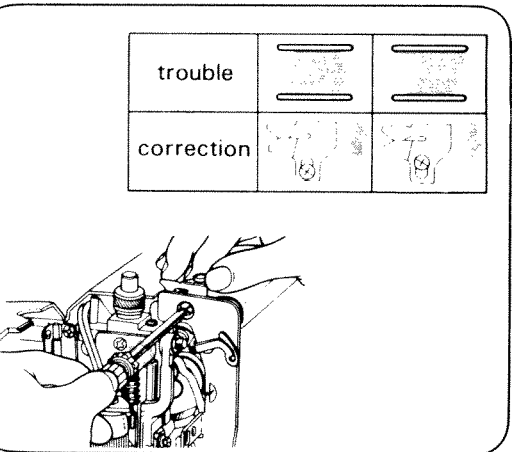

If bobbin is wound unevenly as shown, open face cover and loosen set-screw of the guide for bobbin winding: Use screw driver to adjust height.

Inserting Bobbin

Place bobbin in its case with thread running in direction of arrow.

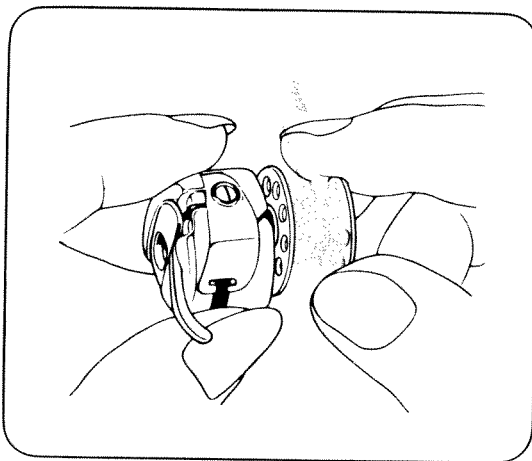

Guide thread into slot (a) of bobbin case.

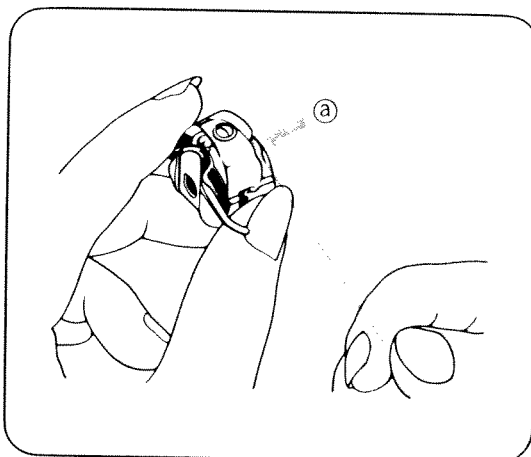

Pulling thread to left, bring it under tension spring then to delivery eye (b).

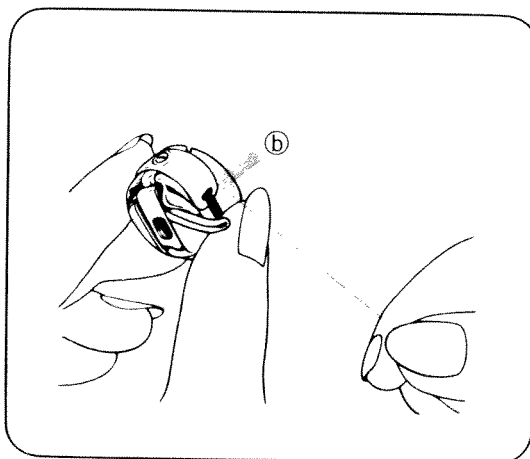

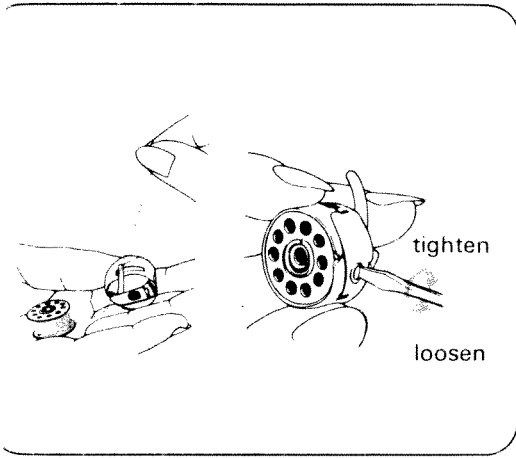

Adjusting Lower Tension

To test bobbin tension, hang and shake bobbin case as shown.

At proper tension bobbin case will gradually drop a small amount.

To adjust tension, turn adjusting screw with small screwdriver.

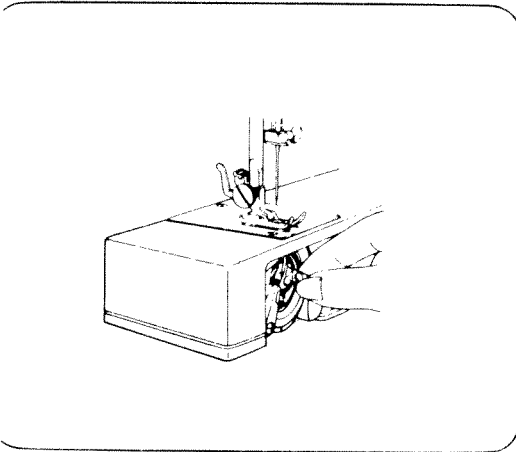

Raise needle in the highest position.

Leave end of thread of about 10 cm (4") from bobbin case.

Take hold of latch and push bobbin case into shuttle

Release latch when bobbin case is fully inserted.

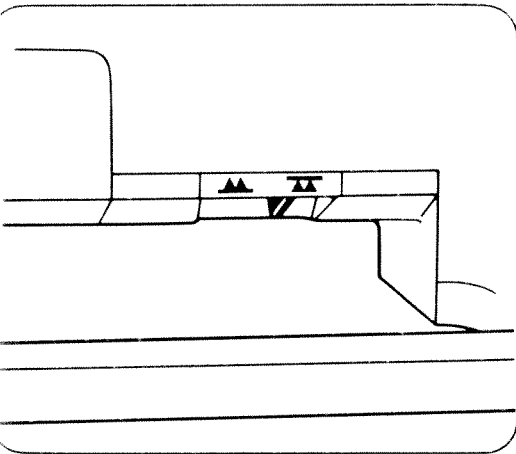

DROP FEED LEVER

The lever is in the right side of shuttle cover. For normal sewing, move the lever to ▲▲ position.

To lower feed dog, move the lever to ▼▼ position.

This position is used for button sewing, darning and embroidery.

Threading Upper Thread

Raise presser foot lifter.

Raise take-up lever to the highest position by turning handwheel towards you.

Thread following numbers ①-⑦.

Pass thread through guide ①.

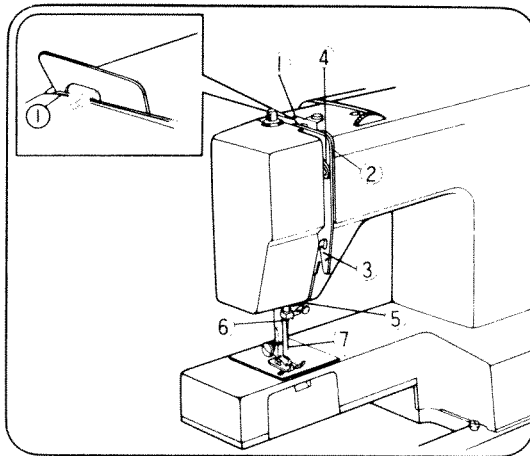

Lead thread either side of tension disc (2).

Hook it to guide (3) from down to upwards.

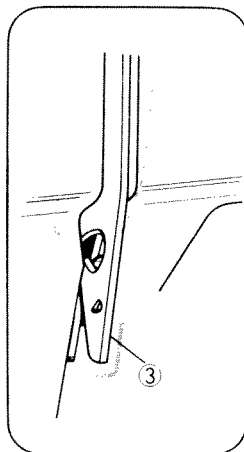
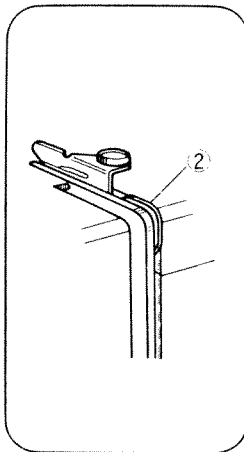

Thread take-up lever (4).

Pass thread to guide (5) from right to left, and guide (6) (left one) then needle eye (7).

Leave end of thread of about 15 cm (6'').

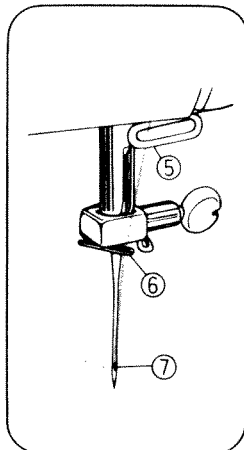
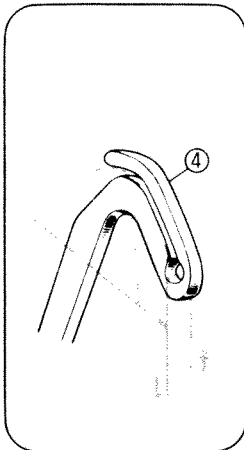

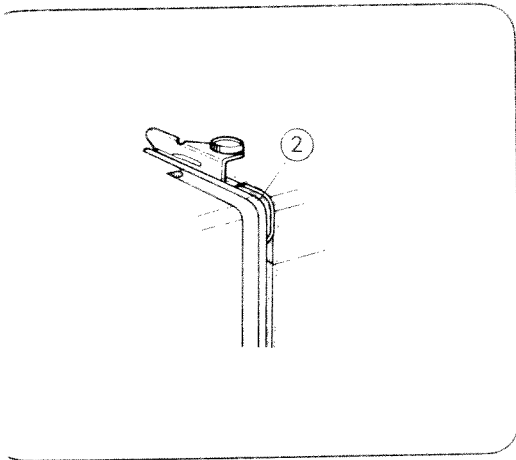

Twin Needle Threading

Thread in the same way as normal threading, except at points 2, 6 and 7.

At point 2, pass threads separately to right and left of tension disc.

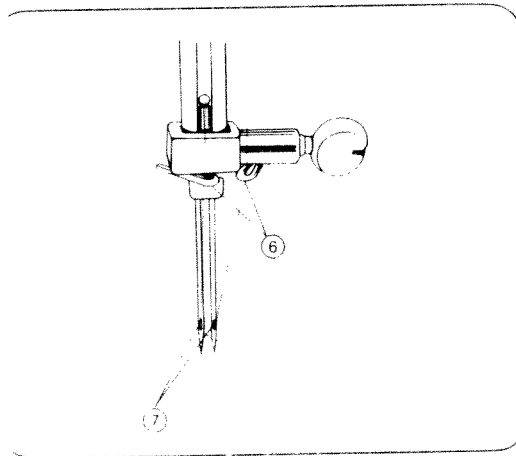

At guide 6, pass one of threads to right guide and the other at left guide.

At point 7, thread from right guide should be lead to right needle eye, and from left guide to left needle eye.

Leave ends of threads of about 15 cm (6").

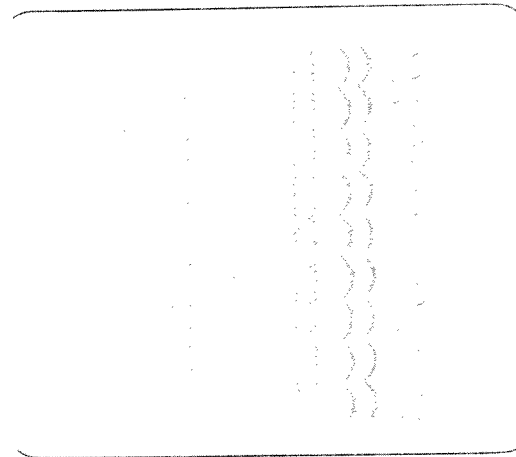

Decorative Tucks or Designs

Any stitch can be used with the twin needle for decorative effects. Most attractive are the multiple stitch zigzag and blind hem stitch for fancy tucks. The satin stitch or tapered zigzag designs in two colors are effective for creative trims.

Caution: Remember to use no more than 2.5 zigzag width and needle position control at  for twin needle sewing.

Drawing Up Lower Thread

Hold end of upper thread with left hand.

Turn handwheel slowly towards you until needle moves down and up again.

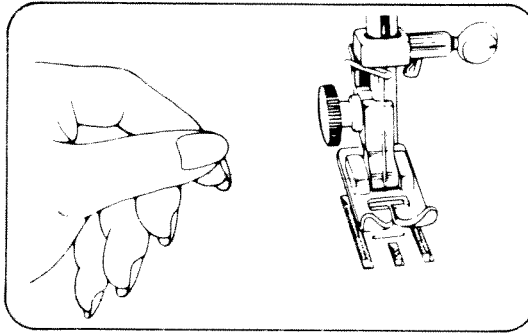

Pull upper thread slowly and lower thread will be brought up in a loop.

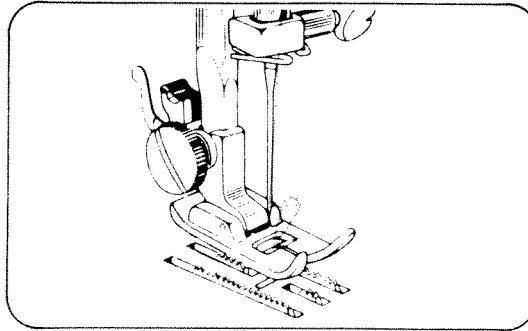

Pull out both threads to about 15 cm (6") and place them together under presser foot on left.

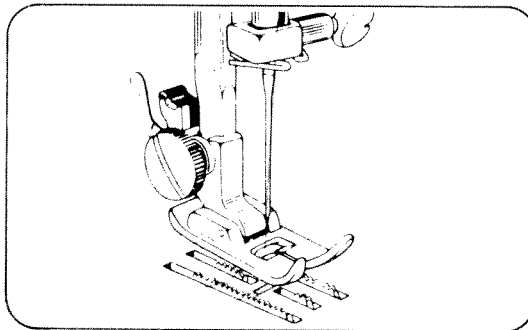

Foot Pressure

Push down the outer ring of the pressure regulator. This will release the pressure on the presser foot. To increase the pressure, push down inner pin until suitable pressure is obtained.

Insufficient pressure may cause poor feeding of the fabric, skipped stitches, or difficulty in guiding the fabric. If feed dogs or presser foot marks appear on the fabric, reduce the pressure.



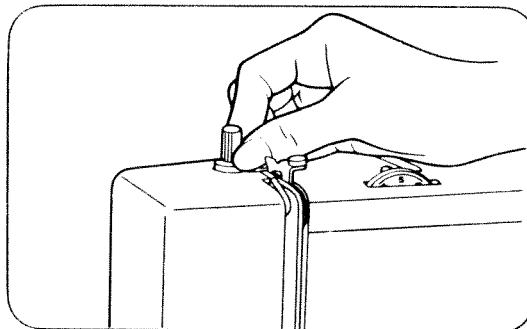







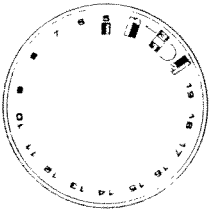





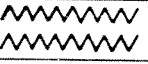

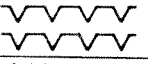

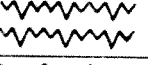

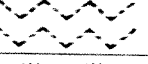

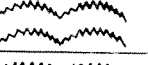

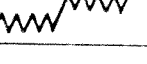
When sewing multiple thickness or heavy fabric, reduce the pressure. Increase pressure when sewing lighter weight fabrics.

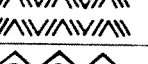

abric, thread and needle table

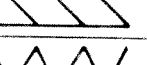
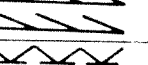
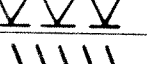
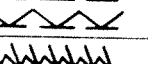
FABRIC	THREAD			NEEDLE			REMARKS
	European	Mercerized	Cotton Covered	European	U S Size	Point	
	Cotton	Cotton	Polyester, Silk, Nylon	705	15x1	Style	
VERY SHEER, Lace, Voile, Chiffon, Net	70	60	Silk Nylon	65-70	9	Regular	Loosen upper tension one or two points
SHEER, Blouse Crepe, Lawn, Organdy, Taffeta	50-70	60	Silk Nylon	65-70	9		
MEDIUM-WEIGHT, Crepe, Wool, Brocade, Velvet	30	50	Silk	75-80	11		
MEDIUM, Wool, Silk, Linen, Velvets, Cotton, Linen, Terry cloth	30	50	Silk	80-90	11-14		
HEAVY, Denim, Duck, Sailcloth	30	Heavy Duty	C.C. Poly	100	16		
XTRA HEAVY, Upholstery, Canvas, Tarpaulin	30	Heavy Duty	C.C. Poly	120	19		
KNITS]							
MEDIUM-WEIGHT; Tricot, Power net	50-70	60	Silk Nylon	70	9	Light Ball	
MEDIUM-WEIGHT, Jersey, Double Knit, Power Net	30	50	Silk Nylon C.C. Poly	70-80	9-10	Light to Medium Ball	
HEAVY-WEIGHT, Double Knit, Power Net	30	50	Silk Nylon C.C. Poly	80-90	11-14	Medium to Heavy Ball	
WAKE-FURS, VELOURS	30	Heavy Duty	C.C. Poly	90-100	14-16	Ball or Sharp	
LEATHER]							
VINYLS FILMS	30	50	C.C. Poly	90	14	Wedge	
MEDIUM-TO-MEDIUM-WEIGHT	30	50	C.C. Poly	90-100	14-16	Wedge	
HEAVY LEATHER	30	Heavy Duty	C.C. Poly	100-110	16-18	Wedge	
DECORATIVE TOUCHES]							
TOP STITCHING	Silk twist			100-110	16-18	Regular	
MACHINE EMBROIDERY	Size 50-70			65-80	9-11	Regular	

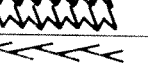
Pattern Setting

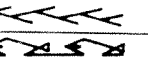
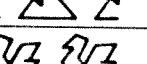
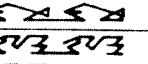
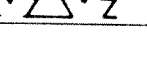
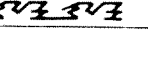
	 PATTERN SELECTOR	 TWIN NEEDLE	PATTERN NAME	COLOR CODE
1-4			BUTTONHOLE	ORANGE
5			STRAIGHT	YELLOW
			ZIGZAG	YELLOW
6			BLIND HEM	YELLOW
7			STRETCH BLIND HEM	YELLOW
8			MULTIPLE ZIG ZAG	YELLOW
9			SCALLOP	YELLOW
10			PEARL DECORATIVE	YELLOW
11			CHECKER	YELLOW
12			STRAIGHT STRETCH	PURPLE
			RICK RACK	PURPLE
13			DECORATIVE	PURPLE
14			ULTRA STRETCH	PURPLE
15			OVERLOCK	PURPLE
16			OVERLOCK	PURPLE
17			BRIAR	PURPLE
18			FISH	PURPLE
19			SWAN	PURPLE

4. STRAIGHT SEWING

Set machine as shown.

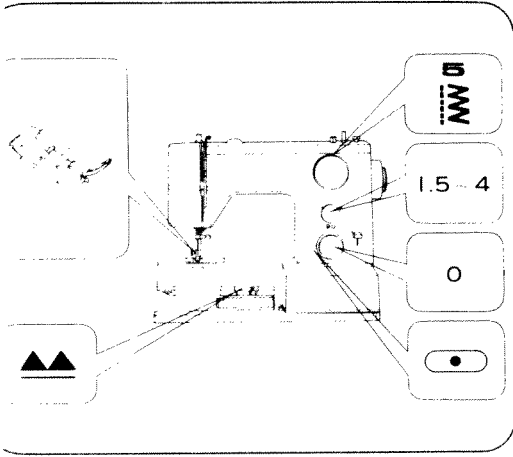

Pattern Selection Dial

Turn dial to choose pattern.
Dial can be turned either to right or to left.

* Always make sure needle is in the highest position when operating dial.

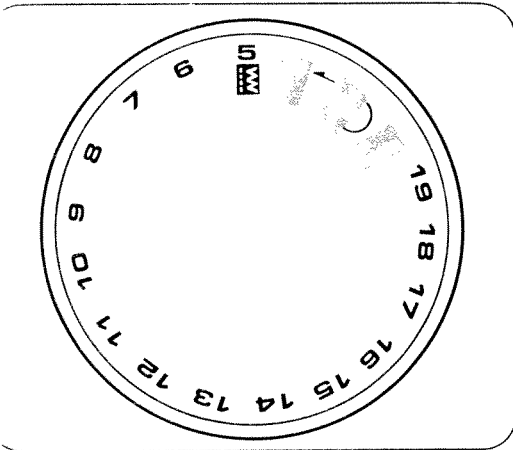

Stitch length dial

For a longer stitch, turn dial in clockwise. For a shorter stitch, turn it in counter-clockwise.

For normal sewing it is set between 2 and 3.

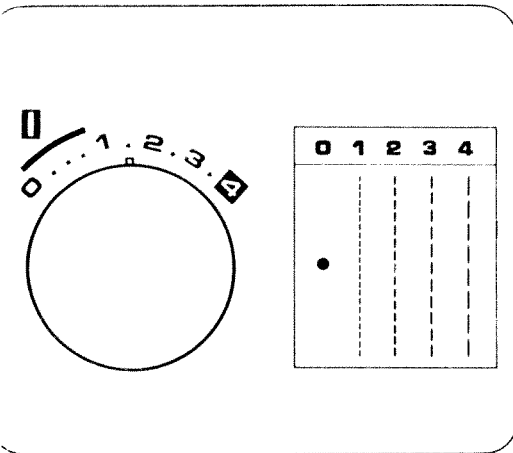

Starting to Sew

Place fabric under foot about 1 cm (0.4") inside the edge.
Lower presser foot lifter.

Important:

Hold on both threads during the sewing of the first 3~4 stitches of the seam.

Double Presser Foot Lifter

In order to obtain wider gap when using very thick materials, firmly push presser foot lifter up as far as it will go.

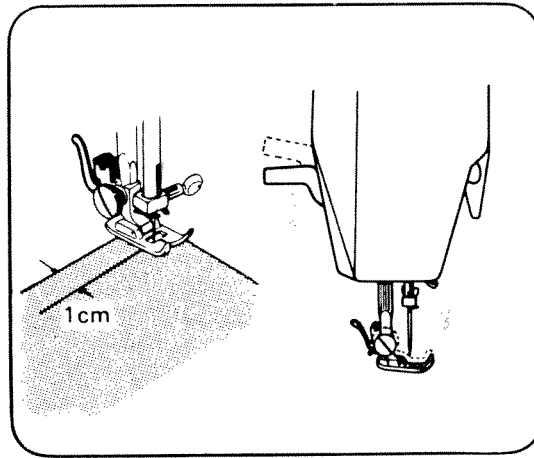

Reverse Sewing

To reinforce seam, sew backwards to the edge of fabric by pushing down reverse sewing lever.

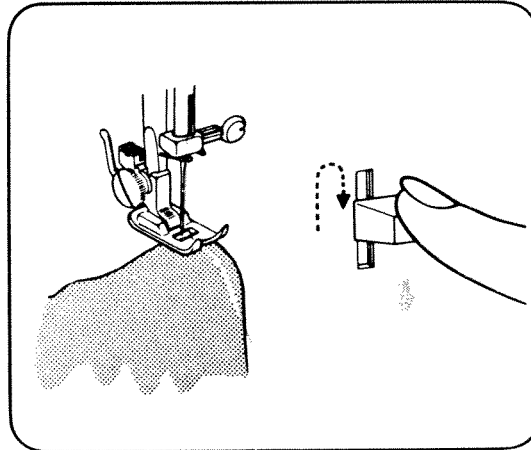

Release lever and commence forward sewing guiding fabric by hand as it is fed.
Never pull material.

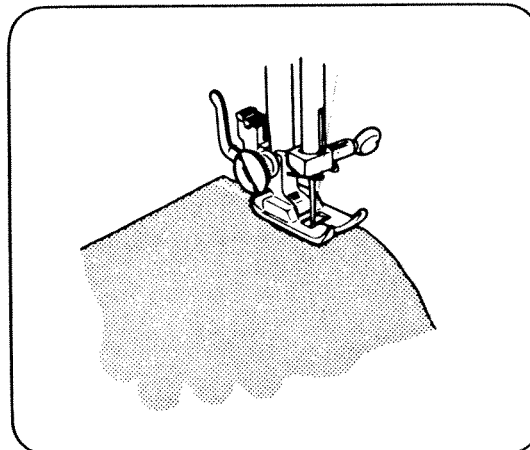

Cloth Guide

Use cloth guide when sewing a long seam of regular distance from edge of material.

Set guide in hole on arm, at right of needle plate, and adjust distance.

Run machine with edge of fabric touching guide.

Position cloth guide at an angle to sew a curved seam.

Sew reverse stitches for reinforcement at end of seam.

Draw fabric to left when sewing is finished.

Cut threads with thread cutter behind presser bar.

Adjusting Thread Tension

Test stitch performance on a scrap of material you are going to use.

With correct tension (a), upper and lower threads tension is equal and strong enough to lock both threads in center.

If upper tension is too tight (loose), upper (lower) thread lies straight along upper (lower) surface of fabric (b, c). Correct by turning tension dial.

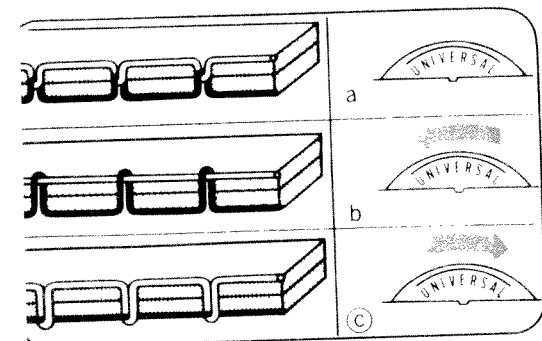
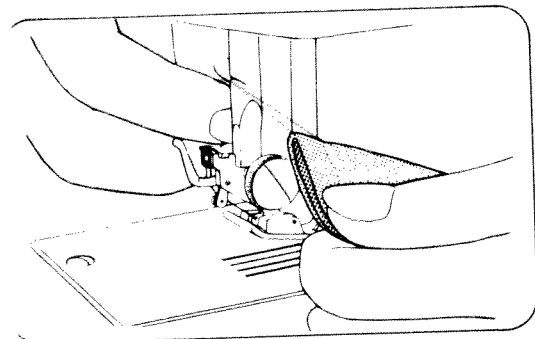
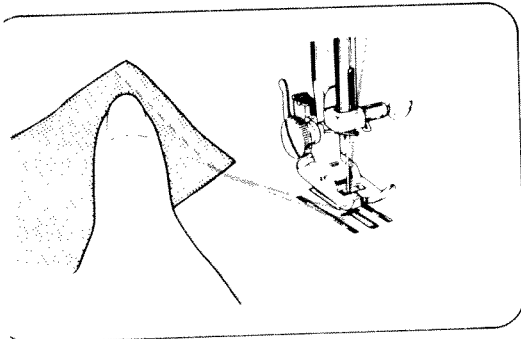
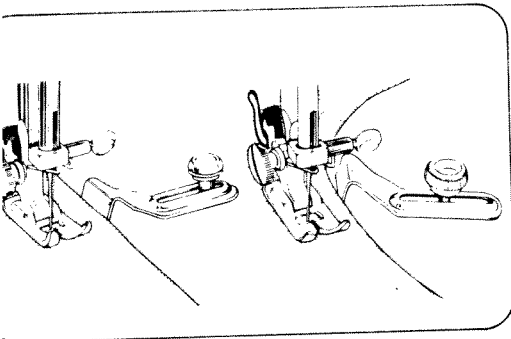

Applications of Straight Stitch

A. Seams

The normal stitch length for most fabrics is 3, but the length chosen should depend on the fabric and area of usage. Usually, heavier fabrics require longer stitches, and lighter weight fabrics require shorter stitches. For curved seams and bias cut areas use a shorter stitch length to add strength and elasticity to the seam.

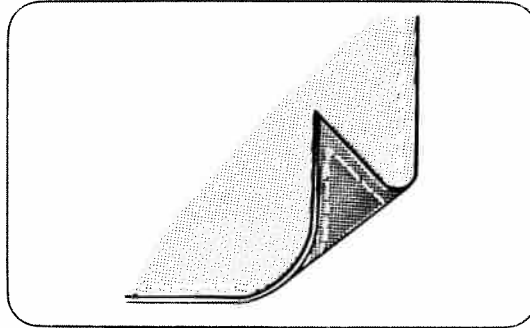
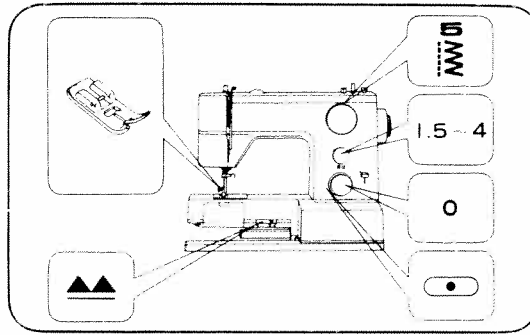

B. Basting/Topstitching

Sewing a seam with a longer stitch is useful for temporary seams prior to fitting. Basting stitches also may be used when gathering in fullness. Topstitching can be done very effectively with the long straight stitch. For a bolder stitch, two threads of the same type can be threaded through one needle (size 14 or 16). A heavier thread such as buttonhole twist may be used for topstitching, but be sure to use a larger needle (size 16 or 18). Basting instructions in glossary.

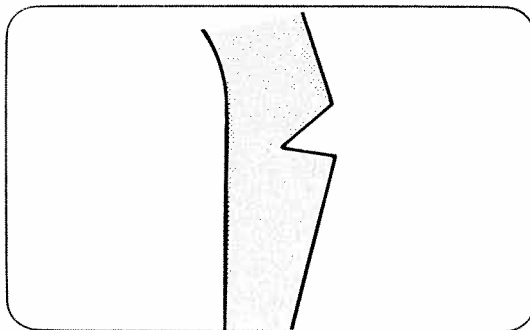
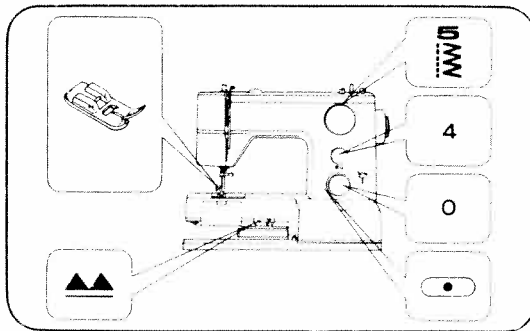

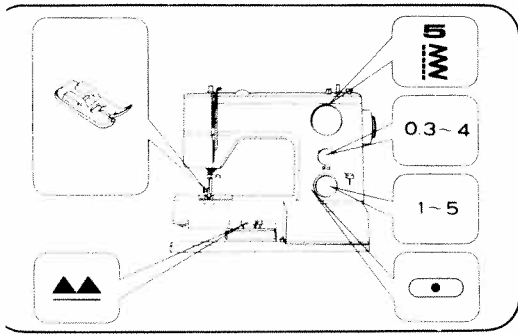

5. ZIGZAG SEWING

Set machine as shown.

To prevent seam ends unravelling, set machine for straight stitch and sew in reverse at beginning and ending of seam.

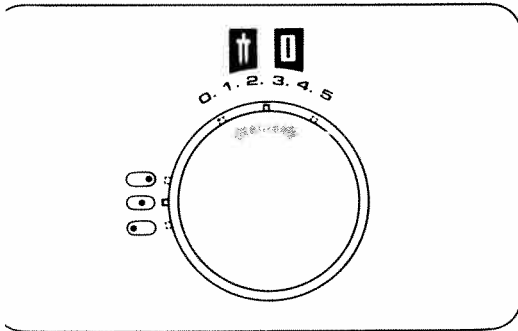

Zigzag Width Control

Set control at required number. Larger the number, wider the stitch.

Set it at 0 for straight sewing.

Make sure needle is in upper position when you set control.

Position	Straight stitch	Zigzag stitch (width 2.5)	
			Left position button sewing, etc
			Middle position straight stitch, buttonholes, etc
			Right position blind hem, overlock, etc

Needle Position Control

Needle position can be changed by turning needle position control.

When selecting position, make sure needle is in upper position to avoid tearing material or bending needle.

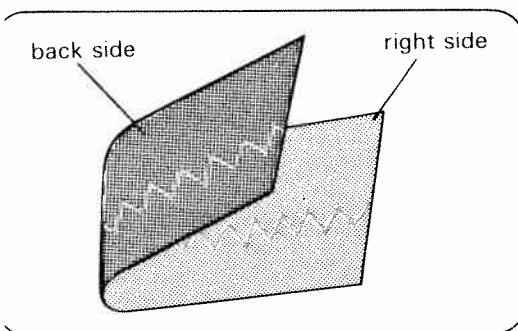

Thread Tension for Zigzag Stitch

Better-looking zigzag stitching requires less upper tension than straight stitching.

Loosen upper tension slightly.

6.MAKING BUTTONHOLES

Set machine as shown.

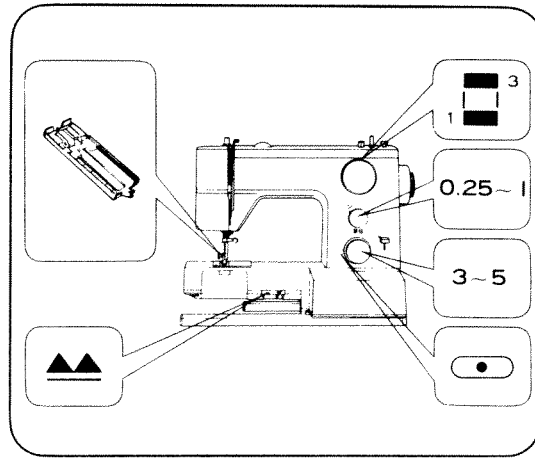

Determine Length

Measure diameter and thickness of button and add 0.3cm (1/8") for bar tacks.

Mark buttonhole size on material.

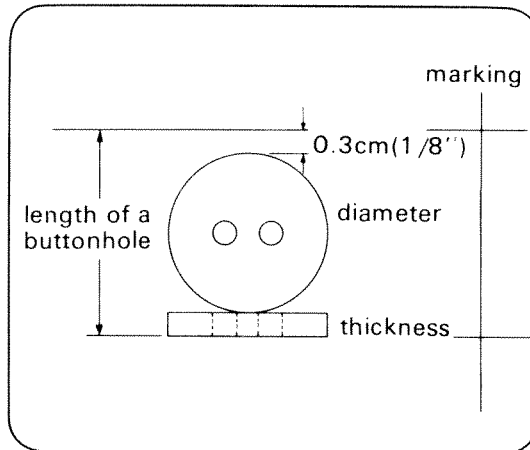

Determine Width

Determine width according to diameter of button, its thickness, and kind of material.

Attach buttonhole foot.
Completely push back sliding part a of buttonhole foot.
Place material under foot so that marking of buttonhole passes through center of foot and arrow b of foot indicates beginning line of marking.

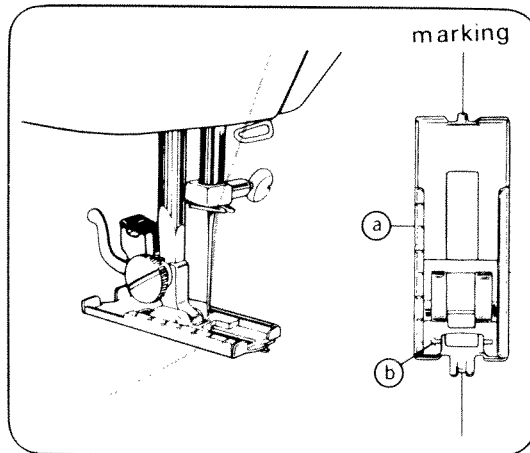

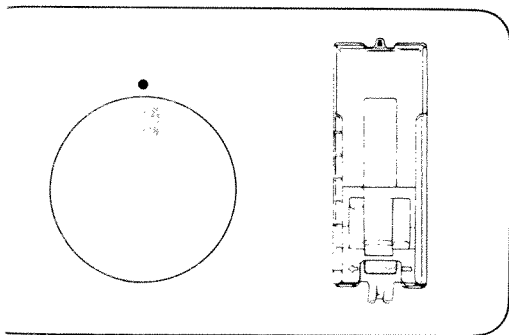

Bar tacking: Set pattern selection dial to 1 (1 ■³) and sew 5-6 stitches.

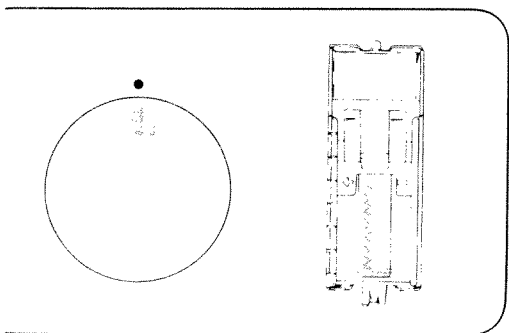

Left side: Change pattern to 2 (2 ■). Sew left side from front to back until it reaches end line.

Remember the point where arrow shows so that it is not necessary to mark end lines for all buttonholes.

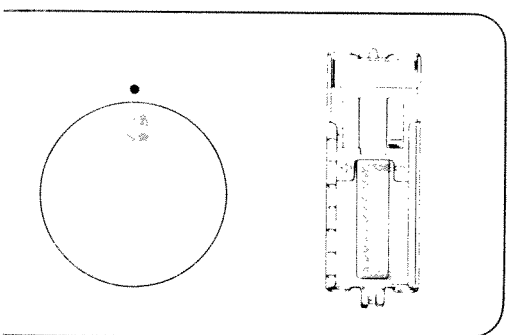

Bar tacking: Change pattern to 3 (3 ■³) and sew 5-6 stitches.

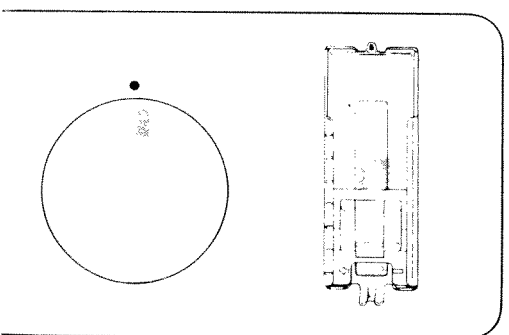

Right side: Change pattern to 4 (4 ■⁴) and sew right side until it catches first bar tack.

Quick finish: To prevent unstitching, set zigzag width at 0 and proceed for a few stitches.

Left and Right Side Balance of Buttonhole

Stitch density on right and left sides of buttonhole can be adjusted by buttonhole balance control dial.

This dial should usually be in a neutral position (between "+" and "-")

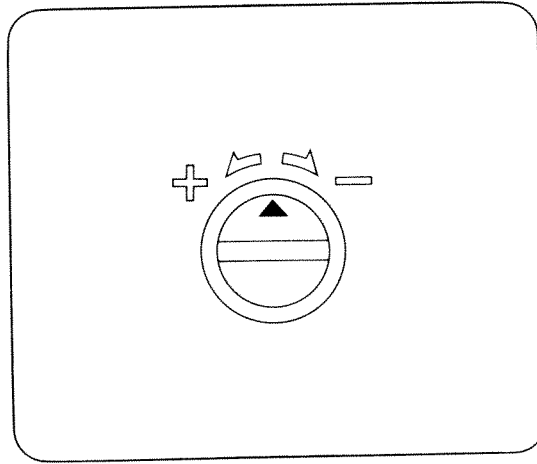

If the stitches on the right side of the buttonhole are too close together, turn the dial to the left (+).

*Turning dial to left opens right side and closes left side.

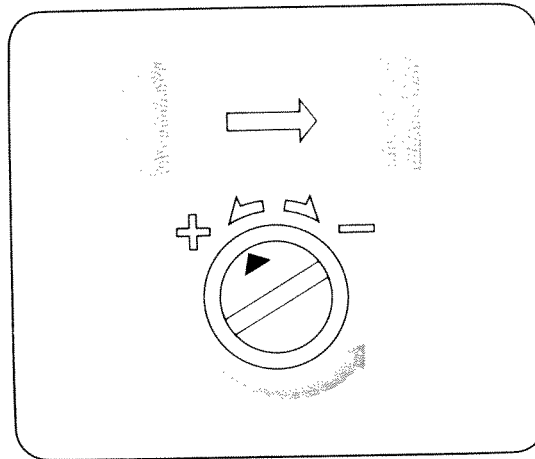

If the stitches on the right side of the buttonhole are too open, turn the dial to the right (-).

*Turning dial to right closes right side and opens left side.

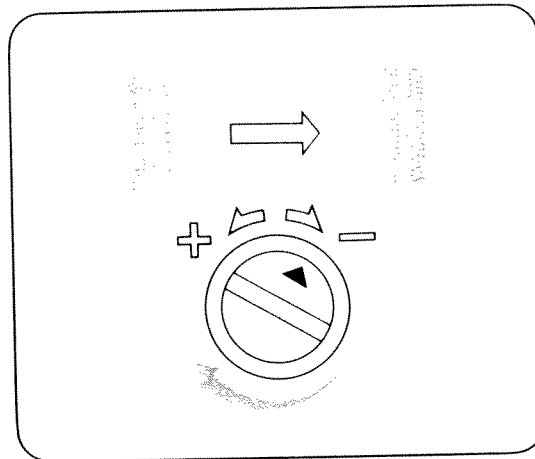

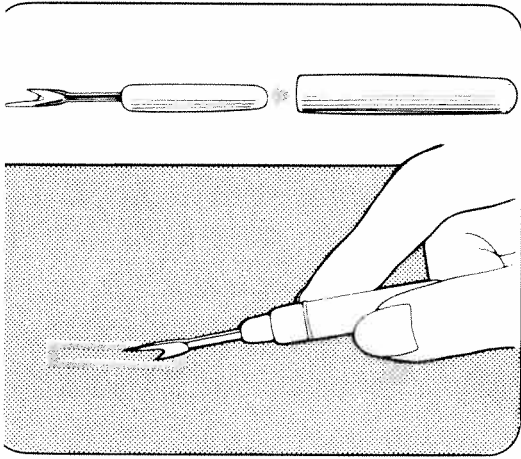

Cutting Buttonholes

Stick a needle through bar tacks to prevent over-cutting.

Cut buttonhole along center with buttonhole cutter.

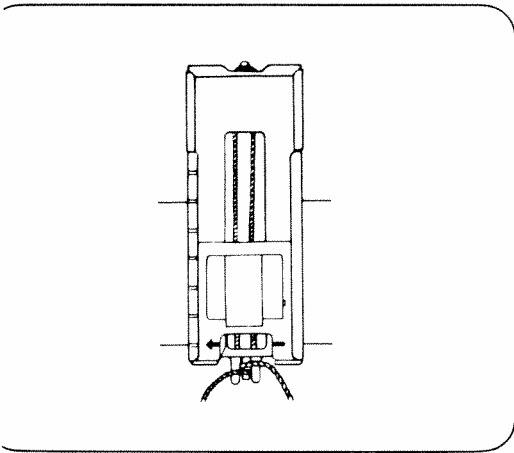

Corded Buttonholes

For stretch fabrics such as knits, a corded buttonhole is effective to keep finished buttonhole in shape.

Hook filler cord on top spur and lead ends of cord under foot, pull taut, and hook them to bottom notches as shown.

Proceed with stitching as for regular buttonholes.

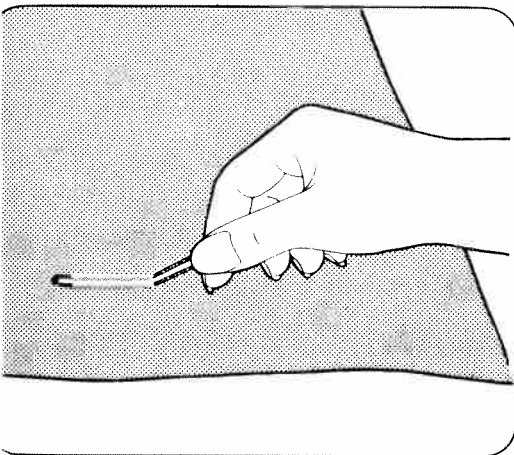

When buttonhole is completed, pull filler cord ends so that loop on the other end disappears into buttonhole stitching.

Thread ends of cord to reverse side and tie, or cut both ends of cord.

7. SEWING ON BUTTONS

Set machine as shown.

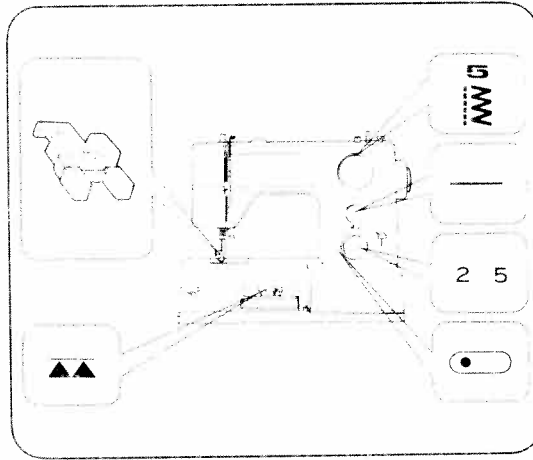

Position a button and material under foot. When needle comes to left side of stitch, lower foot. Raise needle and adjust zigzag width so that needle comes to right hole of button.

Make one stitch be certain that needle is aligned with button's holes.

Run machine at medium speed and sew 5-6 zigzag stitches.

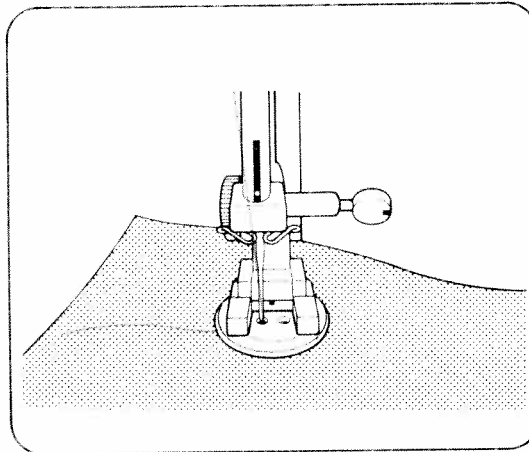

Stop machine when needle is in upper position.

a Set zigzag width control to 0, align needle with button's hole and sew 3-4 stitches to prevent stitches from unlocking.

OR

b Remove work and cut off threads. Draw thread ends through to wrong side and tie a knot.

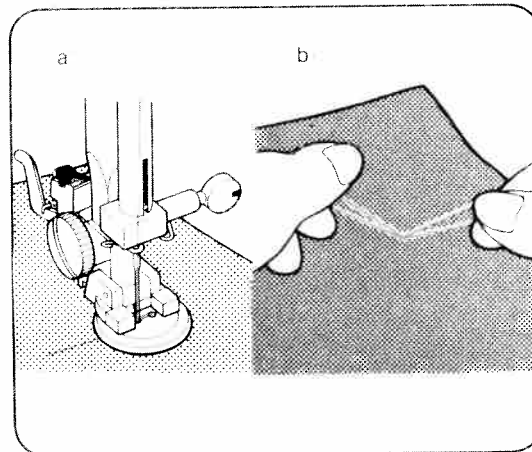

8. OVERCASTING

For light weight material:

Set machine as shown.

Overcasting prevents edge of fabric from fraying and produces neat finish.

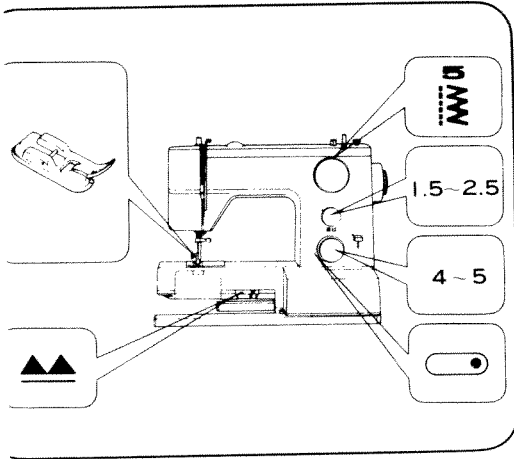

Sew carefully so that all stitches on right side are flush with edge of fabric.

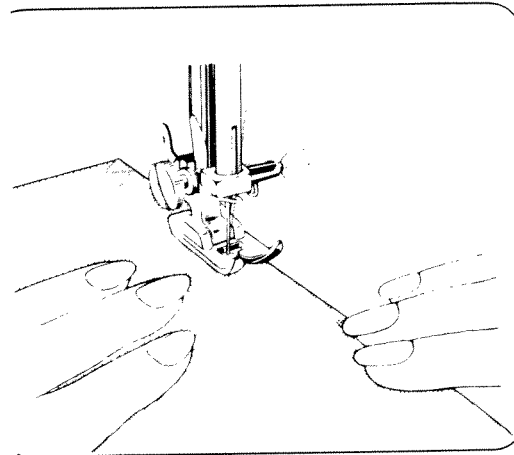

For thick and elastic material:

Set machine as shown.

Sew in the same way above.

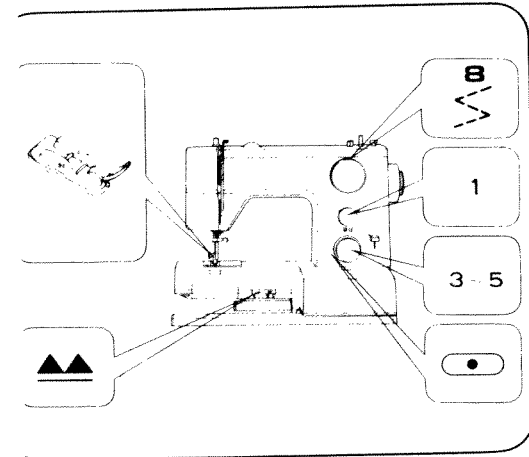

9. OVERLOCKING

Overlocking stitches make it possible to sew and overcast seams at the same time.

Set machine as shown.

- Ⓐ For medium, thin material
- Ⓑ For medium, thick material

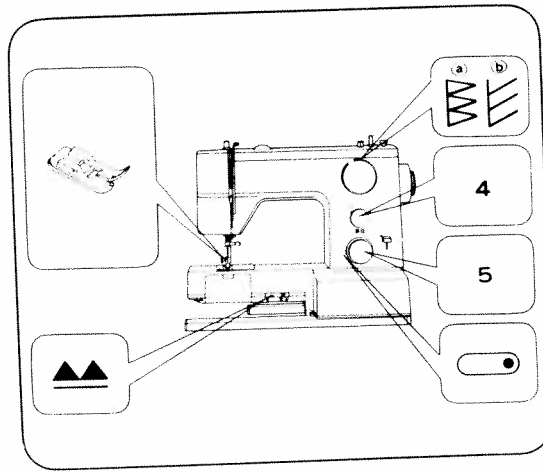

Put two pieces of cloth together with right sides facing and sew.

To prevent edges from fraying, sew so that right side stitches drop outside the edge of material.

In some cases overlocking stitches can be used for overcasting.

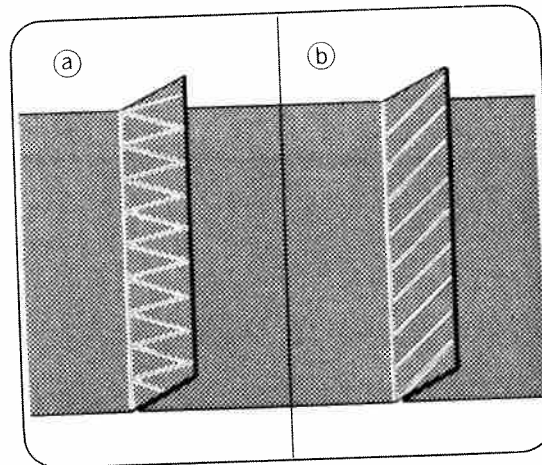

Applications of the Elastic Overlockstitch

This stitch is very effective for overcasting, edgestitching, etc, on knits and very stretchy fabrics, also, for decoration.

Topstitching

A decorative topstitch can be produced with the elastic edging stitch. Stitch around the structural lines of the garments for a dramatic effect. Topstitch a braid or decorative inset with the elastic edging to add an additional decorative flair.

Pattern: 
Length: 5
width: 5
Feed Dog: Up
Pressure: Normal
Foot: Embroidery
Needle Position: L or R

Edging

As with the stretch blind hem, the elastic edging stitch can be used for a decorative edge on place mats, napkins and tablecloths. Proceed as you would with the stretch blind hem stitch, but use the elastic edging stitch instead.

Pattern: 
Length: 5
Width: 3-5
Feed Dog: Up
Pressure: Normal
Foot: Embroidery
Needle Position: M, L or R

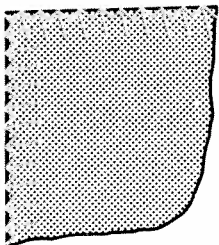
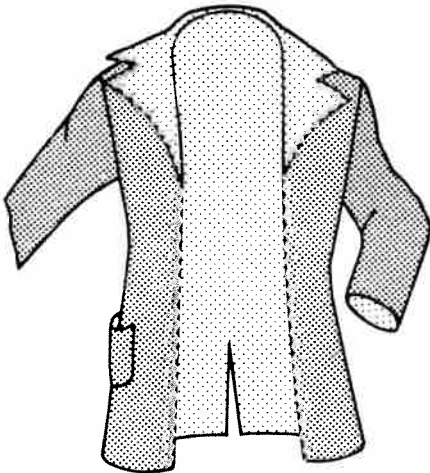
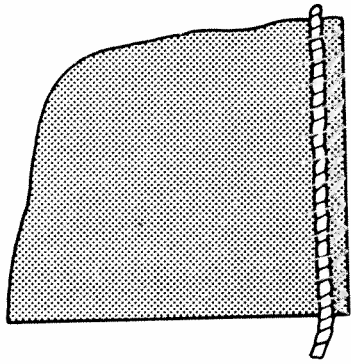

Application of Ultra Stretch Stitch



A. Seaming

On most knits, a 3/16 inch finished seam, such as stitch and overcast or the overlock stitch, is more desirable than a 5/8 inch opened seam allowance. These stitches can create a neater, more professional finish, eliminate bulky seams prevent curling, permit the garment to "give" under stress, and at the same time they cut down on the amount of work involved in making a garment. If ever in doubt as to which of the two stitches to use, test both on the particular fabric in question and choose according to their performance.

The stitch and overcast stitch is excellent for stretch fabrics such as sweater knits, bathing suit knits, and cotton knits. It has the greatest strength and elasticity of all.

For patterns with 3/16 inch seam allowances: Feed the fabric such that the needle goes over the raw edge of the fabric when it swings to the right.

For patterns with 5/8 inch seam allowances: Feed the raw edge of the fabric along the etched guide line "1/2", then trim away the excess fabric close to the stitching.

B. Procedure:

- Overlock stitching is used for seaming and finishing the cut edge of knit fabrics, all in one operation.
- This overlock stitch is especially good for stretch fabrics such as double knit and jersey and will give a firm, neat edge finish.

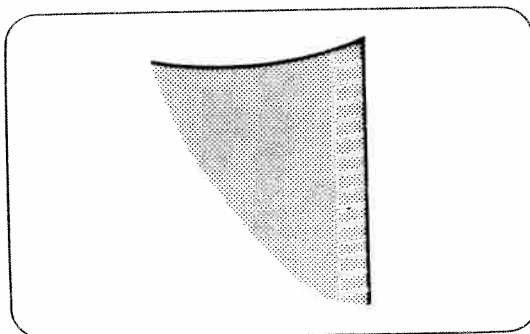
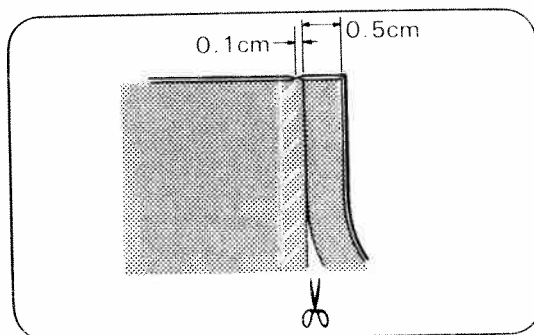
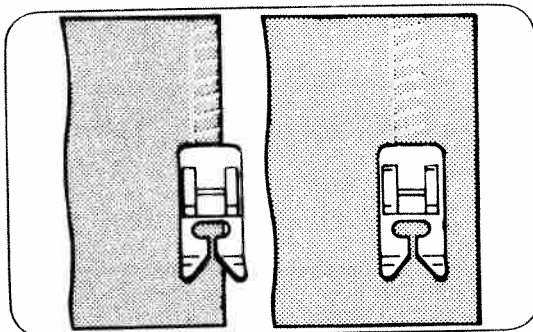
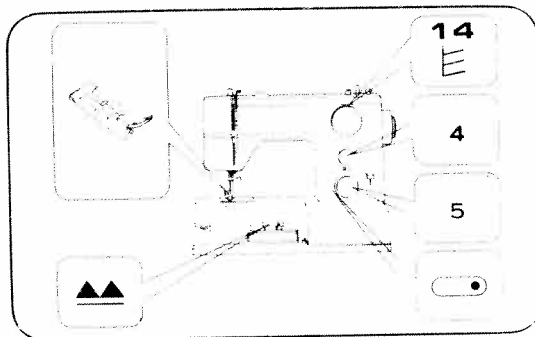

Application of Rick-Rack



A. Topstitching/Rick-Rack

A decorative topstitch can be produced with the rick-rack stitch. Stitch around the structural lines of the garment for a special effect. Topstitch braid or a decorative inset to add an additional creative flair.

B. Tapering/Rick-Rack

The rick-rack stitch may be tapered to form creative stems and petals of flowers, embroidered pictures and wall hangings. As in tapering the zigzag, slowly turn the stitch width lever from 0 to 5 and back to 0. A group of these tapered rick-rack stitch will form a bouquet-like effect.

C. Procedure:

- The elastic rick-rack stitch is a zigzag line of stitching that is desired so that seams may be pressed open.
- Apply this stitch to areas of stress on both wovens and knits.
- Use narrow width of zigzag as a heavy duty triple stitch for seams.
- Use medium and wide widths of zigzag for overcasting edges of seams, facings and hems of heavier weight fabrics such as terrycloth, and for attaching elastic. Use also for decorative stitching.
- Guide your fabric from the front. Do not pull or push as it will cause poor stitching.

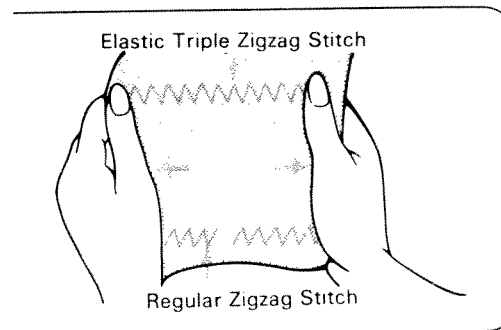
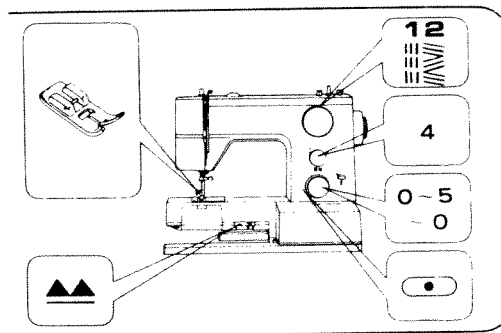
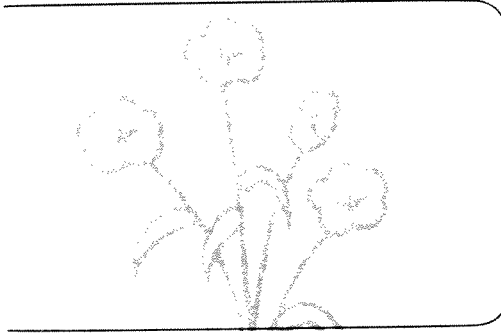
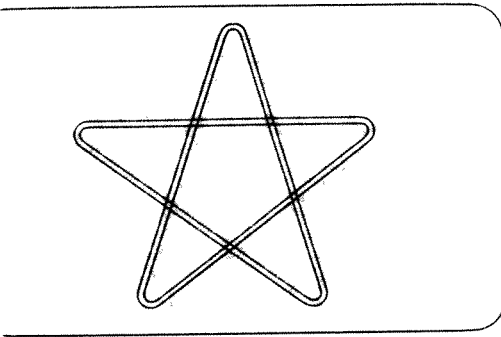

Application of Decorative Fun Patterns

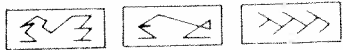

A. Fun stitches-Swan-Fish-Briar

The reverse stitch patterns produce swan, fish, briar designs for use on household linens and children clothes. These reverse stitch patterns can be used to sew in hems as the scallop stitch. The reverse stitch patterns can also be used for topstitching bindings and ribbons for decorative effect. This is done in the same manner that lace is applied with the zigzag stitch. The straight stitched edge of the reverse stitch patterns on the left should be sewn on the left edge of the binding or ribbon. This decorative effect can be used on towels and placemats for a pleasant appearance. The reverse stitch patterns can also be corded for stronger decorative edges on placemats and tablecloths. Simply place four strands of pearl cotton, embroidery floss or yarn under the presser foot. A transparent foot will help guide the cord evenly while sewing the reverse stitch patterns. The reverse stitch patterns can be sewn with two threads through one needle for a more effective decorative stitch. Simply thread two sewing threads through the upper threading system. A larger needle should be used to accommodate the two threads. Use this decorative technique for enhancing tablecloths, placemats, napkins, and curtains.

NOTE: Narrow patterns may be made by setting zigzag width to 4-3-2.

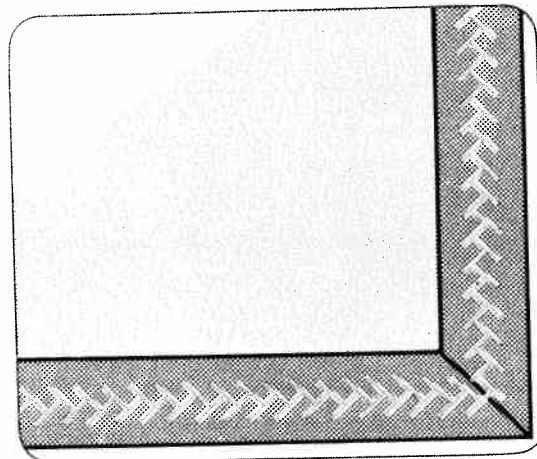
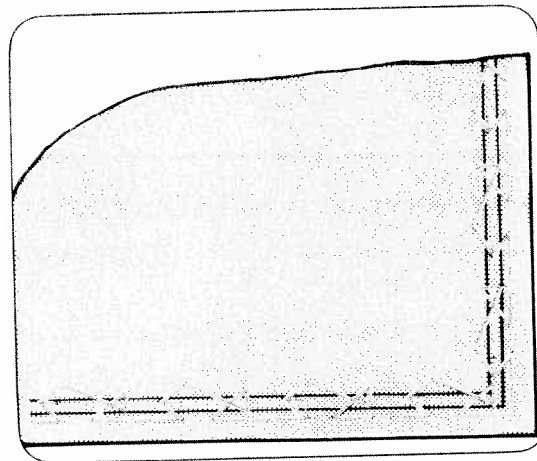
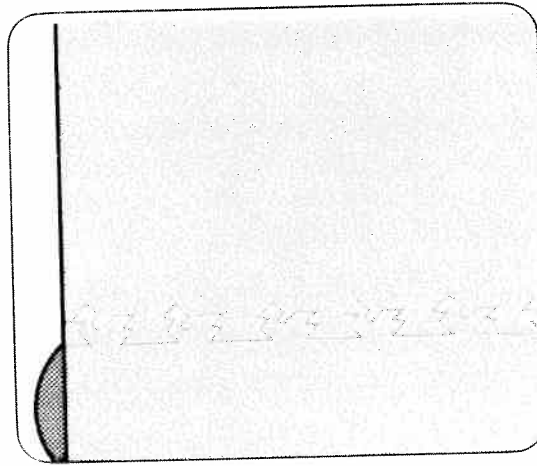

10. BLIND HEM STITCH

Set machine as shown.

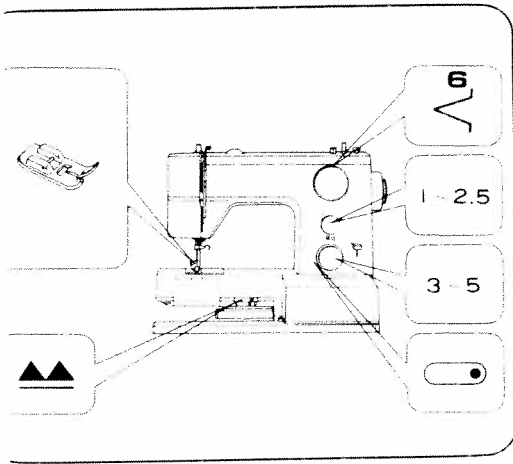

Fold material as shown and place it under foot.

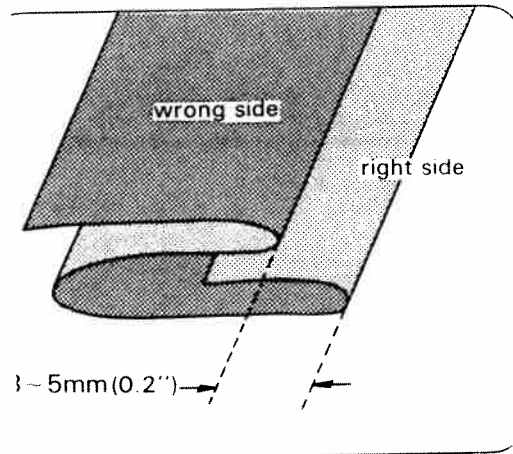

For a neater finish, it is preferable to baste or iron hem before hand.

Sew carefully, so that straight stitches are made on hem edge, and slanting stitches pierce only one or two threads of fold.

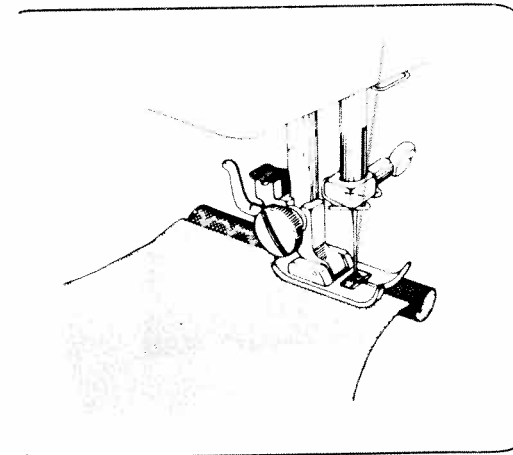

- a Correct seam.
- b Needle is catching edge of fold too much.
- c Needle is not catching edge of fold at all.

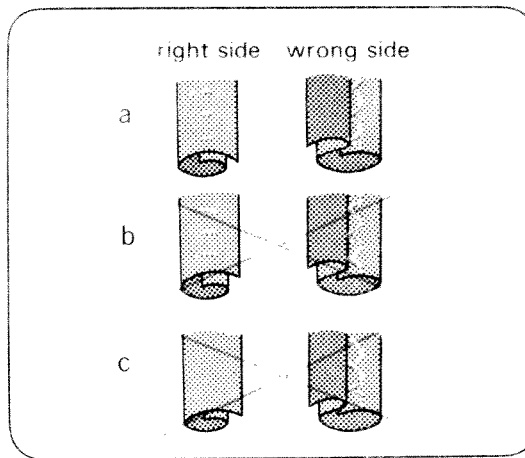

Elastic Blind Hem Stitch

For elastic materials, set machine as shown and sew in the same way as for normal blind hem stitch.

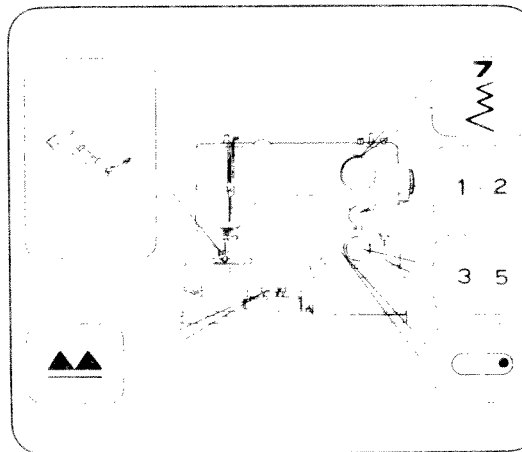

11. STRETCH SEAMS

A ball-point needle is essential.
Paper may be laid under knits for smoother feeding.

a **Medium-weight fabrics**
double knit, jersey.

Apply elastic triple stitch.

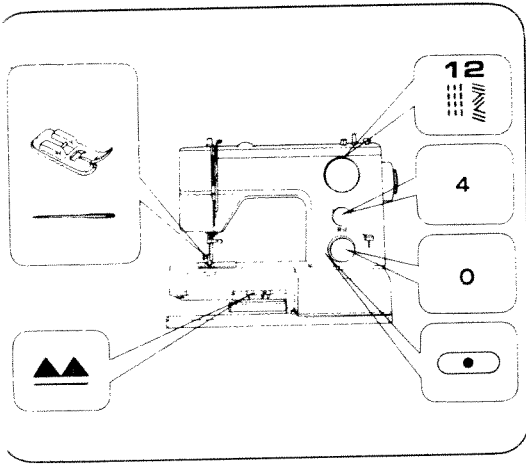

b. **Light-weight fabrics**

Apply small zigzag. Reduce upper and lower thread tension.

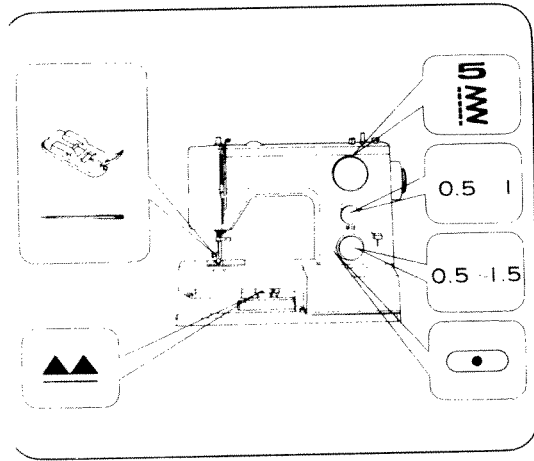

c. **For Very elastic fabrics**
spandex (power net)

Use lapped or abutted seam.
Apply multiple zigzag.

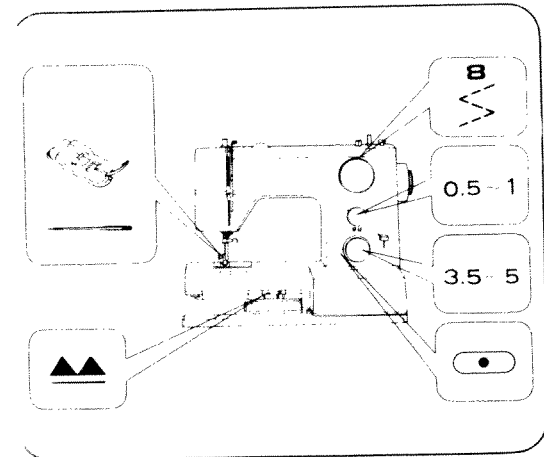

12. ZIPPER SEWING

Set machine as shown.

Used for dresses, blouses skirts, trousers, bags, etc.

By using the special zipper foot, zipper sewing can be easily done.

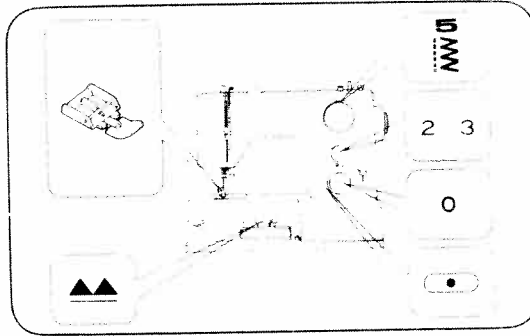

- (1) With right sides together, tack along seam line of the opening a .
- (2) Open the tacked seam and pull out the lower material 0.3cm (1/8"). Place the folded edge over the right side of the zipper and tack over it.

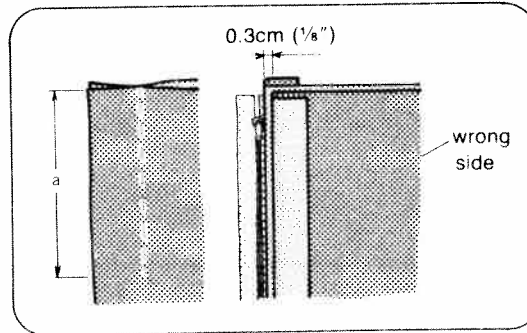

- (3) Replace the presser foot with the zipper foot on the left of the needle. The zipper foot can be shifted either to the right or the left of the zipper, so the zipper can be sewn without difficulty. Stitch from the bottom to the top. Remove the tacking.

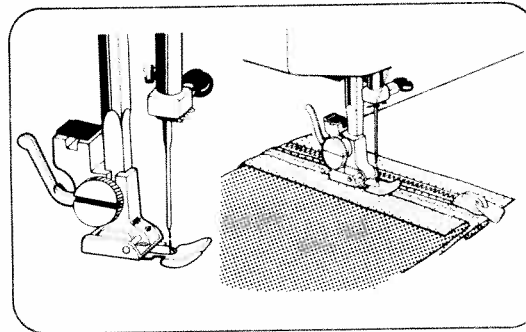

- (4) Turn the material to the right side. Ease the material and the zipper. Tack a measured 1.3cm (1/2") from the tacked seam as a stitching guide. Shift the zipper foot to the right of the needle. Doublestitch across the lower end, then up along the zipper. Remove the tacking.

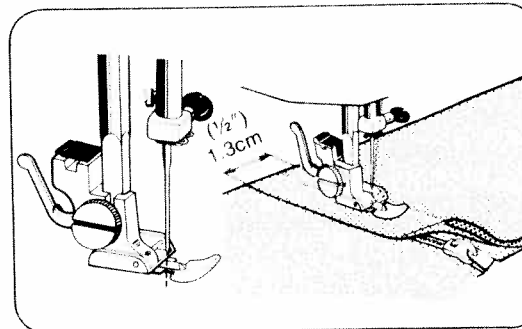

13. SHELL STITCHING

Silk, nylon organdy or similar sheer fabrics are suitable.

Set machine as shown.

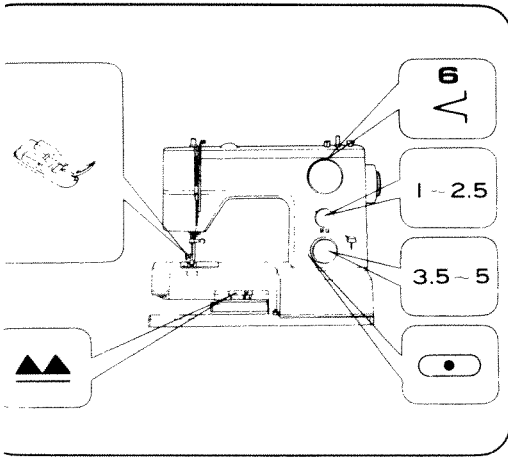

Fold edge of material. With folded edge to left, place it under presser foot.

Pull thread ends towards back when starting sewing.

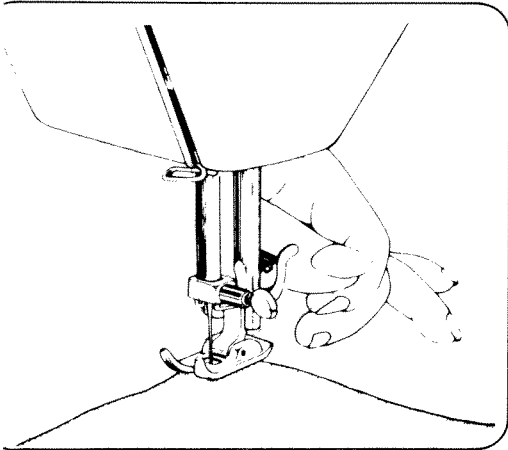

Make sure needle misses raw edge of fold when it moves side ways.

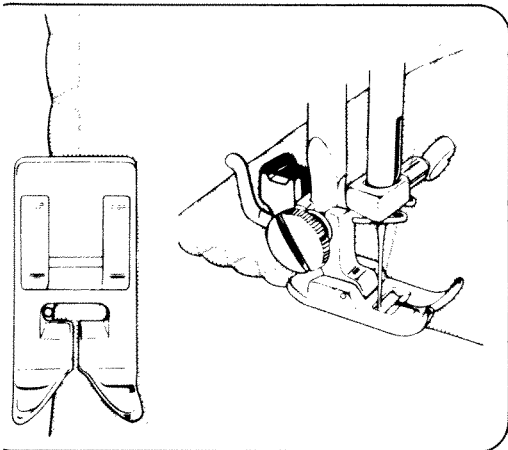

14. PIN TUCKING

Set machine as shown.

For better appearance, use sheer material and tighten lower thread a little.

For twin needle threading see p. 14.

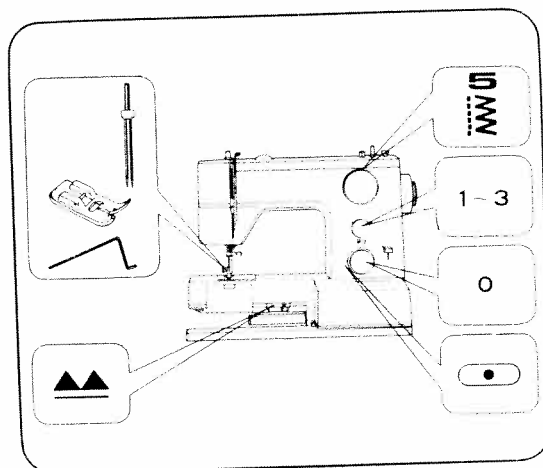

Insert the quilting guide under the spring plate on the holder.

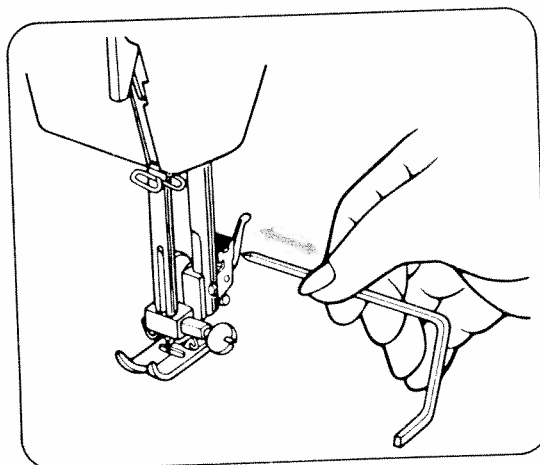

Mark first line with pencil or tailor's chalk, and sew.
From second line, just sew, following seam of first line using guide.
Interval between seams can be adjusted by moving guide in direction of arrow.

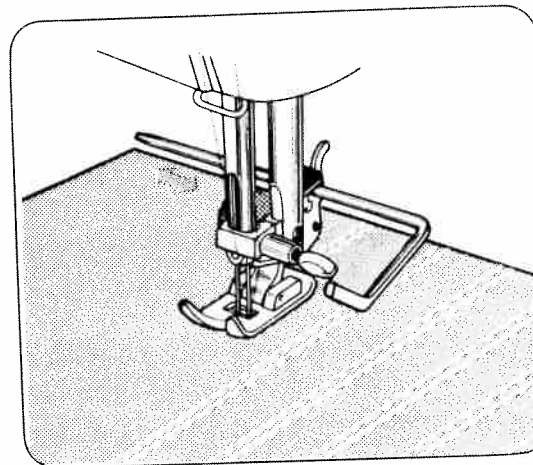

15. QUILTING

Set machine as shown.

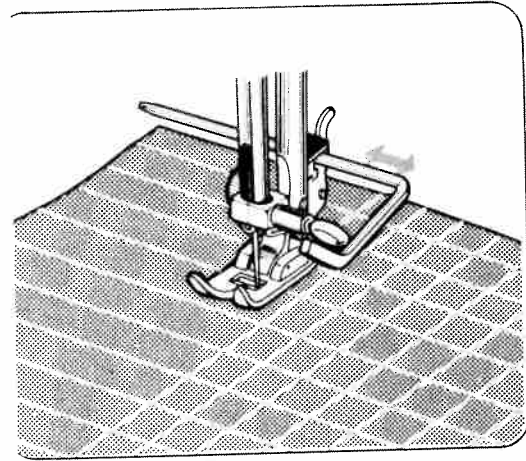
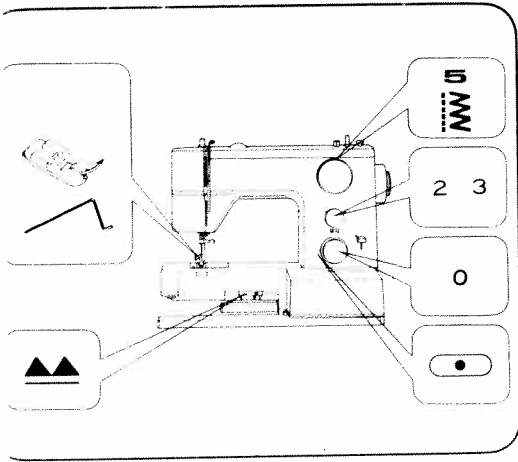

Baste layers of material to prevent them from slipping out as you sew.

Attach quilting guide and sew in the same way as pin tucking.

16. SCALLOPING

Set machine as shown.

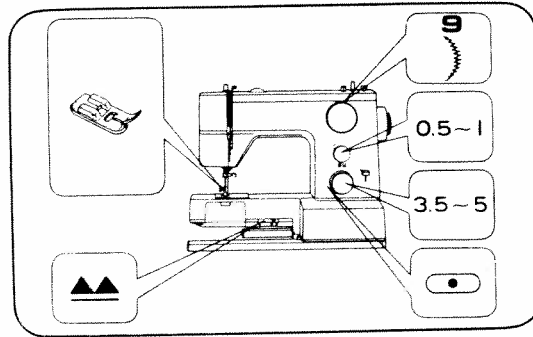

Put two pieces of cloth together with right sides facing, and sew.

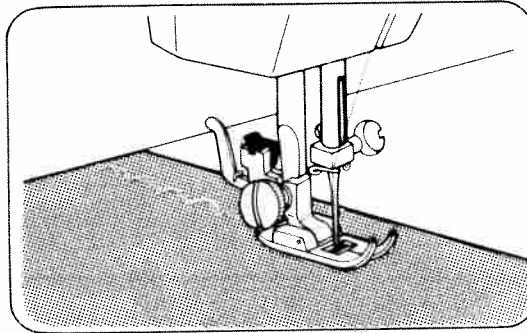

Trim edge 0.3 cm (1/8") away from stitching.
Make notches on seam edge at evenly spaced intervals.

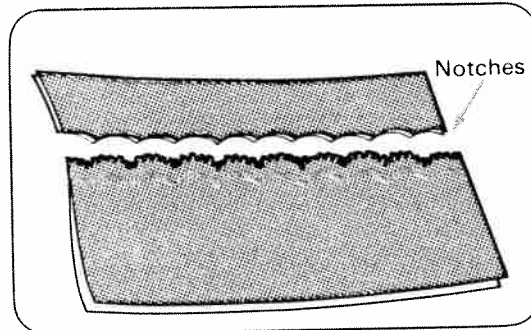

Turn two pieces to right sides out. Bring stitching line to very edge by pushing seam edge gently with your fingers, and press.

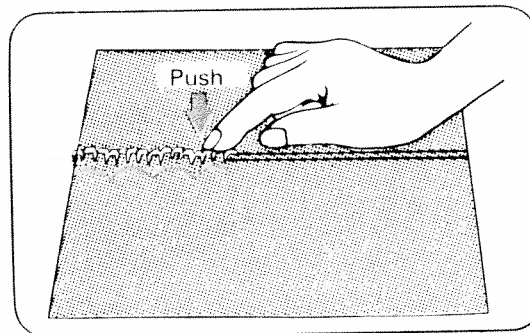

17. MENDING

Patching

Set machine as shown.

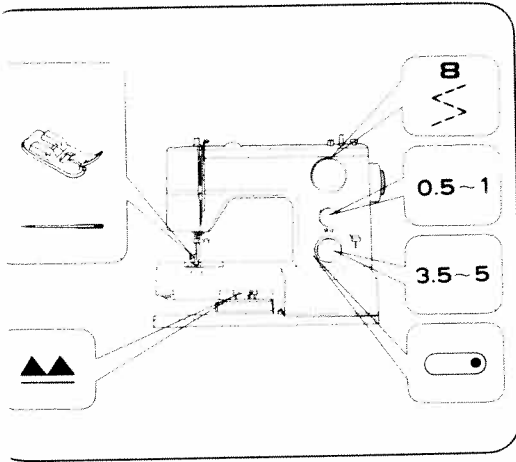

Place the patch over the worn part.

Sew along the edge of the patch on the right side. Trim away the worn part close to the seam on back side.

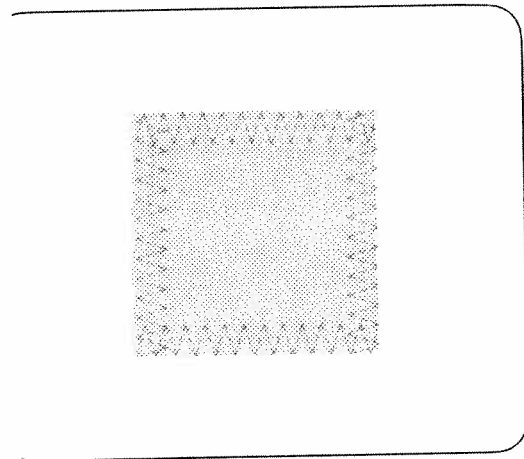

Mending a Rip

Set machine in the same way as for patching.

Sew the edges of tear together first.

Then sew two more seams on either side.

A piece of gauze can be placed underneath to reinforce the rip.

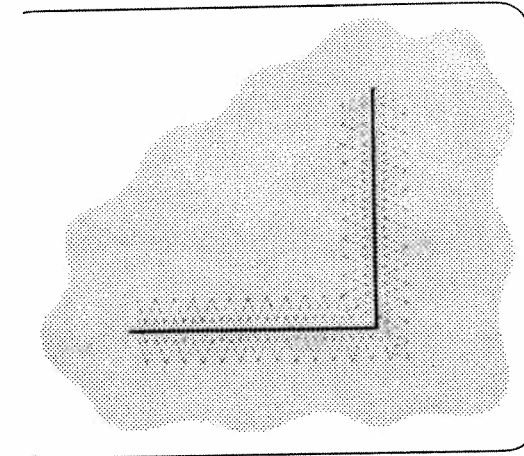

18. APPLIQUE WORK

Set machine as shown.

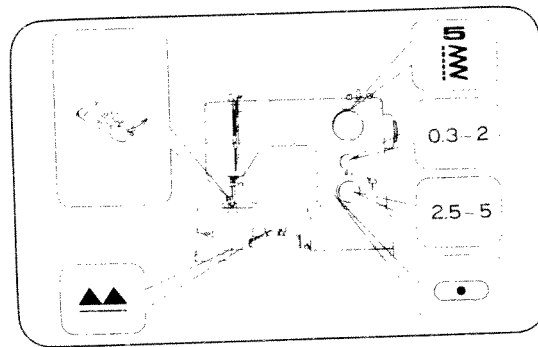

Draw design on material to be used as an applique and cut it out. Place cut-out on base material and baste it.

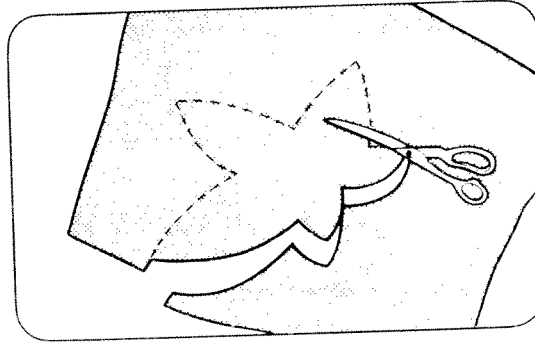

Sew around outline with zigzag stitch adjusting stitch length and width according to shape and size of cut-out and type of base material.

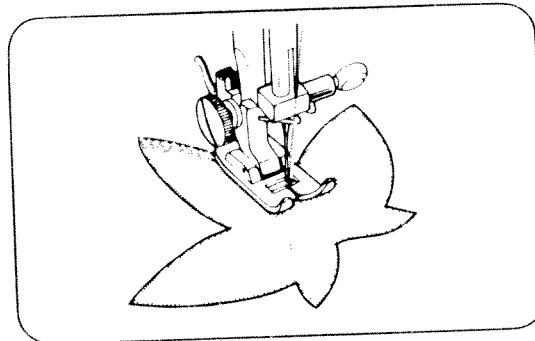

To change direction at corners, or to sew very small circles, stop machine, positioning needle just away from edge of cut-out, lift presser foot and turn material. Lower presser foot and continue sewing.

Sew a few stitches at end with zigzag width at 0. This is to prevent unstitching.

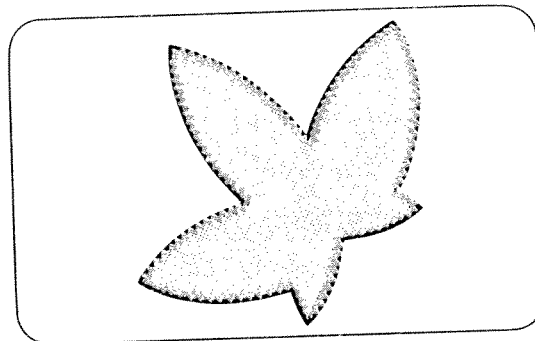

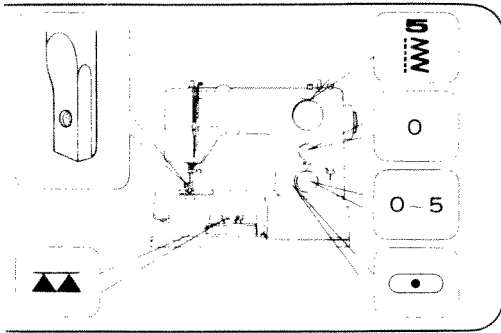

19. EMBROIDERY

Set machine as shown.

Remove foot, and holder screw.

To avoid lower thread being pulled up, reduce upper thread tension.

For good embroidery, it is important to use correct needles and thread.

Use thin embroidery silk for upper thread and a thinner silk of same kind and color for lower thread.

Trace your design on material and center it in embroidery hoop. Make sure material is taut.

Pull out lower thread by turning handwheel towards you while holding upper thread lightly.

Lower presser foot lifter.

Hold both threads and start sewing along outline of design with satin stitch.

Continue sewing guiding hoop by hand.

To finish filling, sew several stitches with zigzag width at 0.

Lay typewriting paper underneath when embroidering sheer fabric.

Needle	Thread
No. 9	120~100
No. 11	100~80
No. 14	60~50

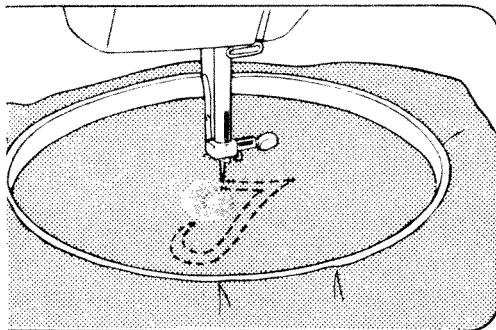
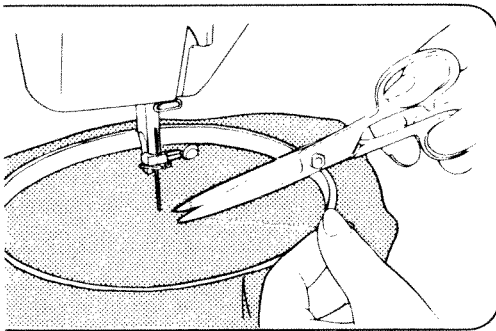

20. MAINTENANCE

Your machine requires regular cleaning and oiling for satisfactory sewing performance. A machine which is used for a few hours a day needs to be cleaned and oiled once a month.

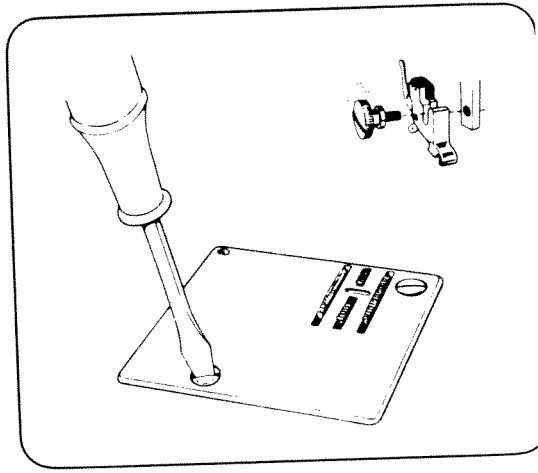

Cleaning

Remove foot and needle.
Remove needle plate.

Brush off all dust and lint on feed dog with cleaning brush.

Turn latches outwards.

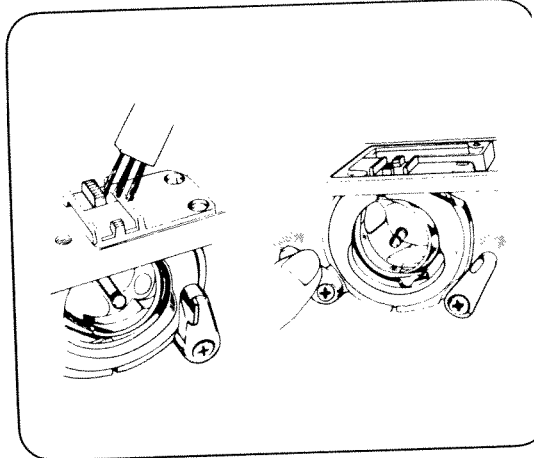

Remove shuttle race cover.
Remove shuttle. Clean shuttle race with a cleaning brush and a soft cloth.

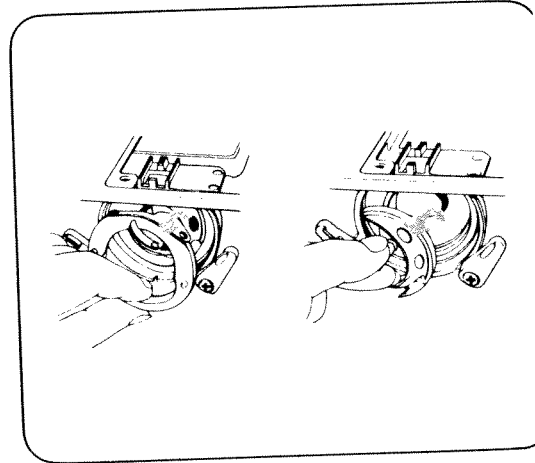

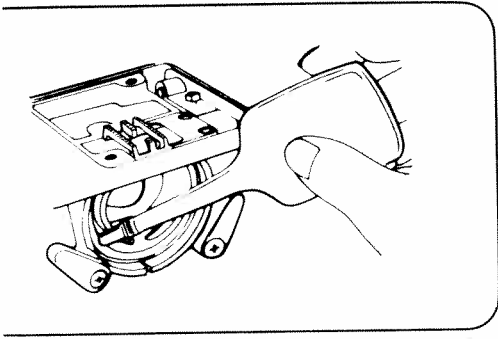

Oiling

Use oil manufactured specially for sewing machine use. Other oils will eventually cause mechanism to jam.

Apply one drop of oil to part of shuttle where friction occurs.

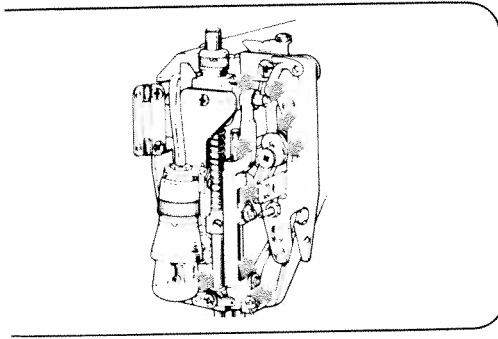

Open face cover and apply oil in the same way.

Be careful not to apply too much oil or it may stain your material and cause some sewing difficulty.

After oiling, run machine for 1-2 minutes to allow oil to penetrate to every part.

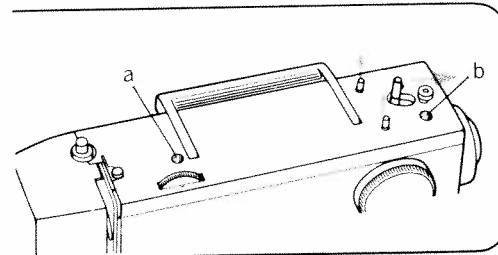

Remove Top Cover:

Pull out spool pins and push bobbin winding spindle to right. Loosening screws **a** and **b** with large screwdriver. then take off top cover.

Apply one drop of oil to lubricating points indicated by arrows.

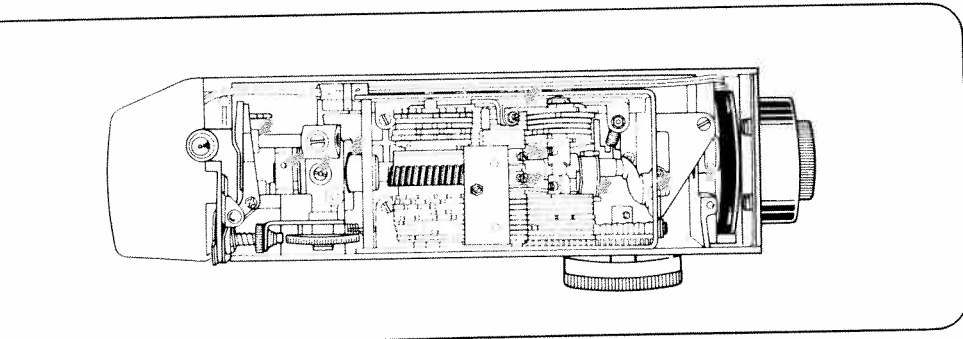

21. TROUBLE CHART

PROBLEM	PROBABLE CAUSE	CORRECTION
Breaking lower thread	Thread not wound evenly on the bobbin or not drawn up correctly	P.10, P.15
	Lower thread tension too tight	P.12
	Lint stuck in the bobbin case and inside the tension spring	Remove lint and fluff with a cleaning brush
Skipping stitches	Needle not fully inserted	P. 6
	Needle bent	P. 6
	Size or type of needle and thread not suitable for the material	P.16
	Incorrect upper threading	P.13
	Too much oil on the hook	P.46
Irregular stitches	Incorrect size of needle for the material	P.16
	Upper thread tension too loose	P.20
	Incorrect lower tension	P.12
The material not fed correctly	Pattern selection dial not set correctly	P.17
	Incorrect feed dog height	P.12
	Lint stuck on the feed dog	P.45

PROBLEM	PROBABLE CAUSE	CORRECTION
The material puckers	Upper or lower thread tension too tight Stitch too long for material Thread too thick Incorrect threading of upper or lower thread	P.12, P.20 P.18 P.16 P.13, P.11
Breaking needle	Needle not correctly inserted Needle bent Needle clamp screw too loose Upper thread tension too tight Needle too fine for the material Dials have been changed while the needle was down in the material Zigzag width set more than 2.5 while twin needle was attached	P. 6 P. 6 P. 6 P.20 P.16 P.18, P.22 P.14

If trouble is still apparent in the machine, please consult your nearest dealer. Do not try to correct fault by yourself.

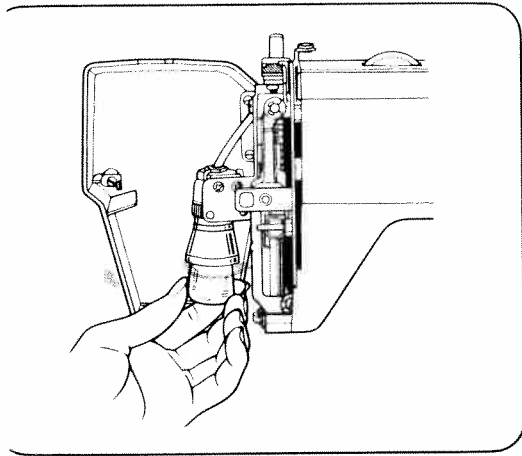

Changing Light Bulb

Unplug the machine.
Open face cover as shown.

Remove bulb by unscrewing it
in counterclockwise.
Install a new bulb by screwing it
in clockwise.

Free Manuals Download Website

<http://myh66.com>

<http://usermanuals.us>

<http://www.somanuals.com>

<http://www.4manuals.cc>

<http://www.manual-lib.com>

<http://www.404manual.com>

<http://www.luxmanual.com>

<http://aubethermostatmanual.com>

Golf course search by state

<http://golfingnear.com>

Email search by domain

<http://emailbydomain.com>

Auto manuals search

<http://auto.somanuals.com>

TV manuals search

<http://tv.somanuals.com>