

Williamson-Thermoflo

PORTABLE AIR CONDITIONER

OWNER'S MANUAL

MODEL N°: 12PRA



This symbol denotes a caution or warning.

-  **Caution:**
- Please read these instructions carefully before installing and operating your Williamson-Thermoflo portable air conditioner. They will help you to derive the maximum benefit from your air conditioner.
 - The air conditioner should always be operated or stored in an upright position. If you have any reason to believe that it was not always in an upright position during the 24 hours before you acquired it, leave it upright for 24 hours before attempting to operate it. This will help to ensure that your air conditioner will run properly.

1. Introduction	1
2. Safety precautions	2
3. Electrical safety	3
4. Remote control buttons and display	4
5. Control panel buttons and display	5
6. Installing remote control batteries	6
7. Setting the clock	7
8. Condensate water drainage	8
9. Automatic mode	9
10. Cooling mode	10
11. Dehumidifying mode	11
12. Setting the timer	12
13. Sleep mode	13
14. Adjusting the airflow direction	14
15. Setting the fan speed	15
16. Cleaning	16
17. Troubleshooting	17_18
18. Tips for saving energy	19

INTRODUCTION

For future reference, we suggest you attach a copy of your sales slip/receipt to this page, along with the following information which is located on the manufacturer's nameplate located on the side of the unit. You will be asked this information if your unit requires servicing and/or for general inquiries.

Model number: _____

Serial number: _____

Date of purchase: _____

Date of installation: _____

Dealer's Name and Address: _____

Carefully read these safety precautions before using your air conditioner.
These precautions must be taken at all times.
Keep this document for future reference.

- Unit must be supervised in presence of children or anybody unfamiliar with it.
- Do not hang or place any clothing or other objects on the unit.
- Do not place any obstacles in front of the unit.
- This device must be installed according to the national electrical code.
- Never spill any liquid into the unit. If this should accidentally happen, turn off the electrical circuit breaker used for your air conditioner and contact your installation specialist.
- Do not insert anything between the airflow blades to avoid any damage to the inner fan and to avoid possible harm.
- If the remote control is not used for a long period of time, remove the batteries to prevent leakage of electrolyte.
- Any damaged electrical component should be replaced by a certified HVAC technician.
- Users of this appliance are warned **NOT TO ATTEMPT ANY REPAIRS** on this product, doing so is at their own risk. Instead, they are requested to contact a certified HVAC technician or the outlet at which the product was purchased.



Caution:

The manufacturer does not take any responsibility for any damage or injuries caused by inadequate installation. An accident may occur if the installation is not executed as instructed in the installation manual. If you experience any difficulty during the installation, you must contact a certified HVAC technician, a designated service center or the outlet at which the product was purchased.

3. ELECTRICAL SAFETY: Please read carefully!

GROUNDING

- For personal safety, this appliance must be properly grounded.
- The appliance's power cord is equipped with a three-prong (grounding) plug that mates with a standard three-prong (grounding) wall outlet to minimize the possibility of electric shock.
- Have the wall outlet and circuit checked by a qualified electrician to make sure that the outlet is properly grounded.
- If you encounter a two-prong wall outlet, it is your personal responsibility and obligation to have it replaced with a properly grounded three-prong wall outlet.
- DO NOT, UNDER ANY CIRCUMSTANCES, CUT OR REMOVE THE THIRD (GROUND) PRONG FROM THE POWER CORD.

HANDLING THE CORD

- Never use the electrical power cord to turn the unit on or off.
- Grasp the plug to remove the cord from the outlet. Never pull on the cord to remove the plug from the outlet.

USE OF EXTENSION CORD NOT RECOMMENDED

Because of potential safety hazards under certain conditions, we strongly recommend that you don't use an extension cord. However, if you do choose to use an extension cord, it has to be a UL-listed, 3-wire, grounding, appliance extension cord with a grounding plug (to be used with only a corresponding outlet) and that the electrical rating of the cord is 20 amperes (minimum) and 120 volts.

TO REDUCE RISKS

- To reduce risks of fire or electrical shock, do not expose the unit to rain or moisture.
- Do not open the cabinet while the unit is connected to a power source. Dangerous voltage is present.
- Have repairs performed by a certified HVAC technician.

4. REMOTE CONTROL BUTTONS AND DISPLAY

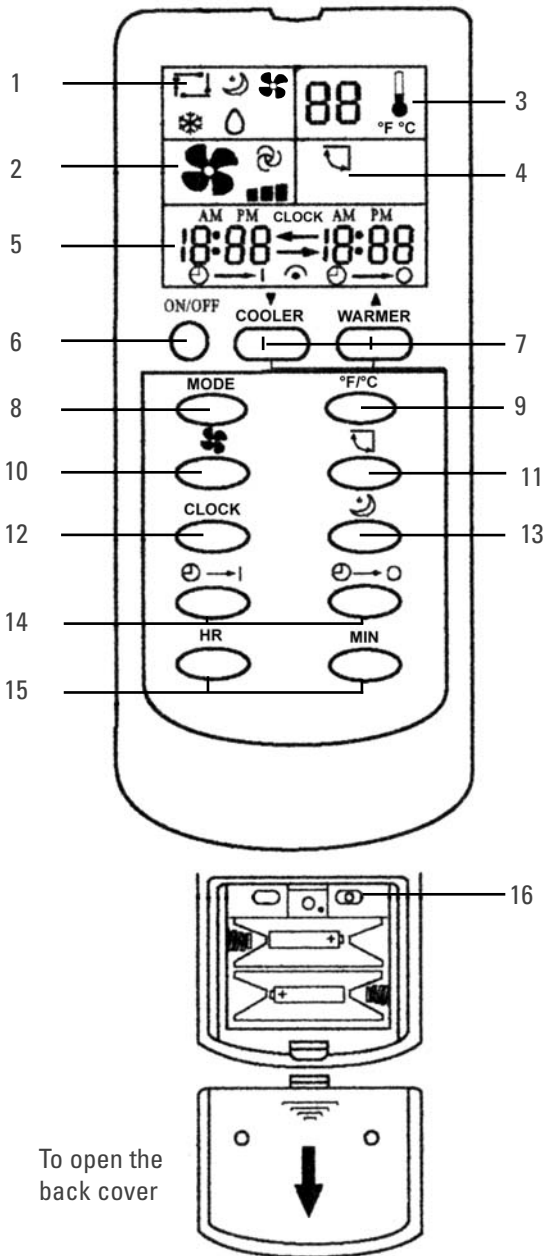

1. Operating mode setting display
2. Fan speed display
3. Temperature display
4. Airflow sweep icon
5. Clock and timer display
6. On/Off button
7. Temperature adjustment buttons
8. Mode button (auto, cooling, dehumidifying)
9. °F/°C switch button
10. Fan speed adjustment button
11. Airflow sweep button
12. Clock button
13. Sleep button
14. Timer setting buttons
15. Clock setting buttons
16. Reset button

When operating the air conditioner, point the remote control toward the signal receiver on the air conditioner and the operation should be confirmed by a beep sound and icon display.

Note:

- The remote control works within a distance of 23 ft. and at a maximum angle of 30 degrees.
- Dust, high temperatures and strong vibrations must be avoided.

Fahrenheit °F/Celsius °C
press °F/°C button to select the
desired temperature scale.

5.CONTROL PANEL BUTTONS AND DISPLAY

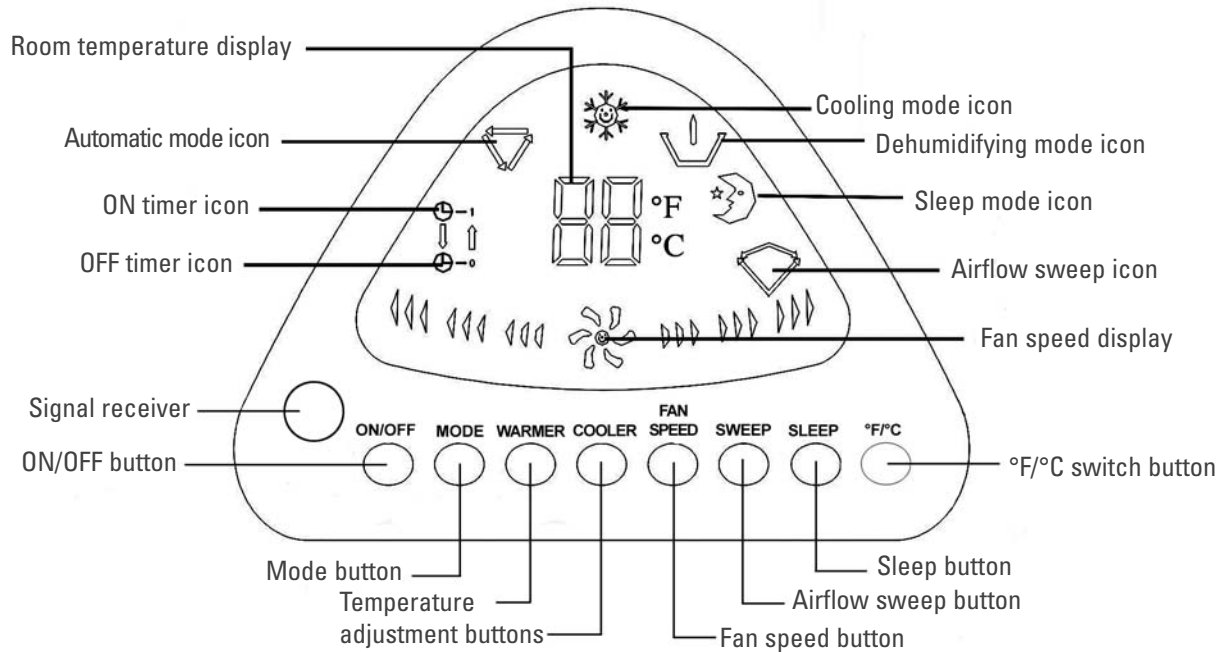

When you set the temperature of your portable air conditioner with either the remote control or the control panel on the unit, the selected temperature will appear for 5 seconds on the control panel display before the room temperature reappears.

Note:

The remote control only displays the desired target temperature.

6. INSERTING REMOTE CONTROL BATTERIES

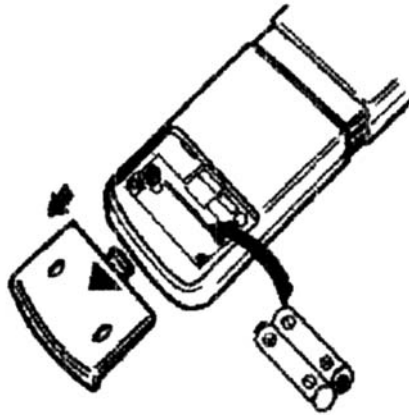

1. Slide the battery cover (on the rear of the remote control) in the direction of the arrow and remove it.
2. Insert the two batteries by respecting the polarities indicated.
3. Close the cover by sliding it back until it clicks into place.

⚠ Caution:
In replacement of batteries:

- Do not use old batteries or different kinds of batteries together.
- Use two AAA, 1.5V alkaline batteries.
- If you do not expect to use the remote control for a long period of time, remove the batteries to prevent the leakage of electrolytes.

7. SETTING THE CLOCK

1- Press the **CLOCK** button on the remote control.

2- Press the **CLOCK** setting buttons   to set the time.

3- Press the **CLOCK** button again.

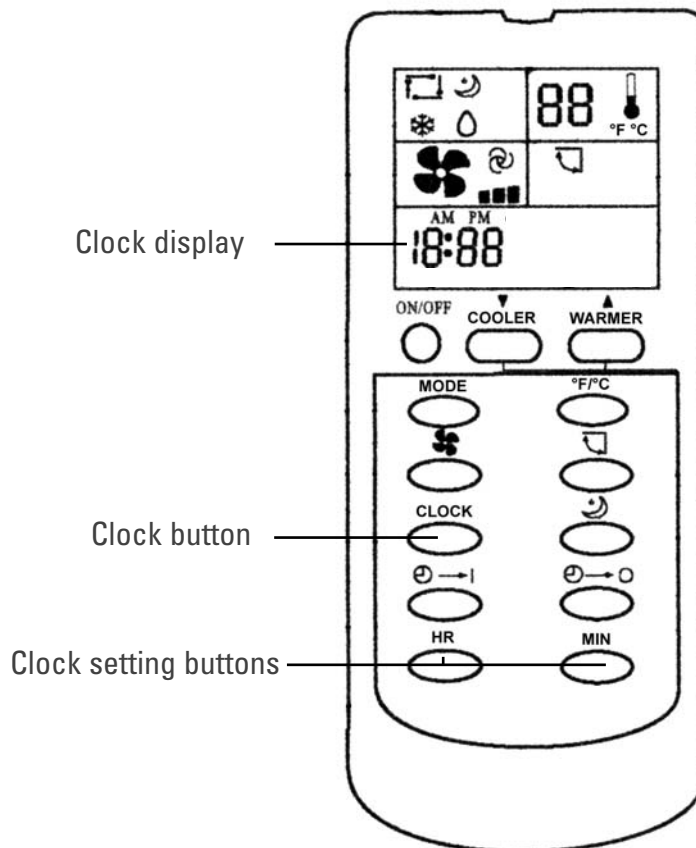

8. CONDENSATED WATER DRAINAGE

In cooling or in dehumidifying modes, condensate water will accumulate in an internal water tank. When the water attains a predetermined level, the water pump will automatically activate and pump the water outside through the draining tube located in the exhaust hose. Refer to the maintenance and installation manual for more information on the installation of the draining tube through the included adjustable window panels.

This unit also has provisions for a continuous “drain” option (for basement applications having a floor drain). The required drain hose extension is not included with this unit. It can be purchased through any local Hardware Store.

For continuous direct drain operation, unscrew the drain cap at the back of the cabinet. Attach suitable length of garden hose to the direct drain fitting. Do not over tighten. Position the open end of the drain hose as close as possible to the floor drain. Check the hose connection for leaks.

Note: Direct drain operation is intended for floor drain applications only. Direct drain operation should not be used a stand pipe and/or sink applications.

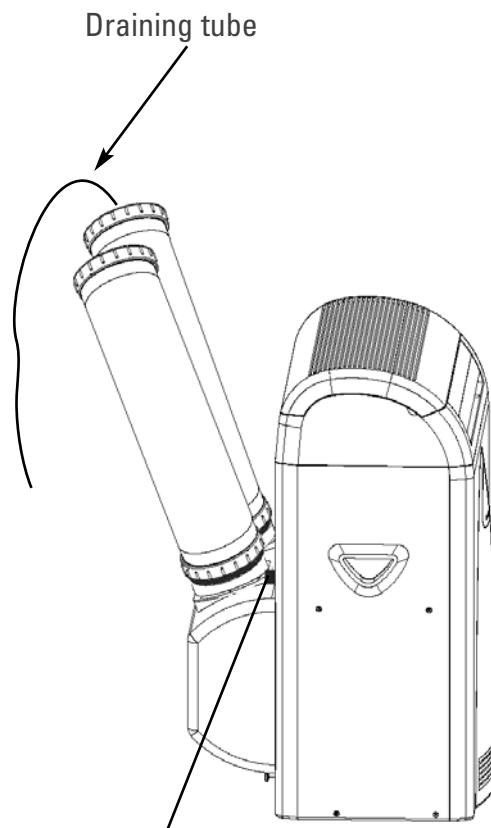

Direct drain (garden hose not included)

9. AUTOMATIC MODE

In automatic mode, the air conditioner will operate in dehumidifying mode when room temperature is below 77 °F and in cooling mode when it is above 77 °F. These temperatures are preset and cannot be modified.

In this mode, you can use the remote control and the unit's control panel to set the following :

- fan speed (low, med, high, auto)
- airflow direction.

To operate :

1. Press the **ON/OFF** button on the remote control or on the unit's control panel to start the air conditioner.
2. Press the **MODE** button repeatedly on either the remote control or the control panel until the automatic mode icon () is displayed in the upper left corner of the remote control or the unit's control panel display.

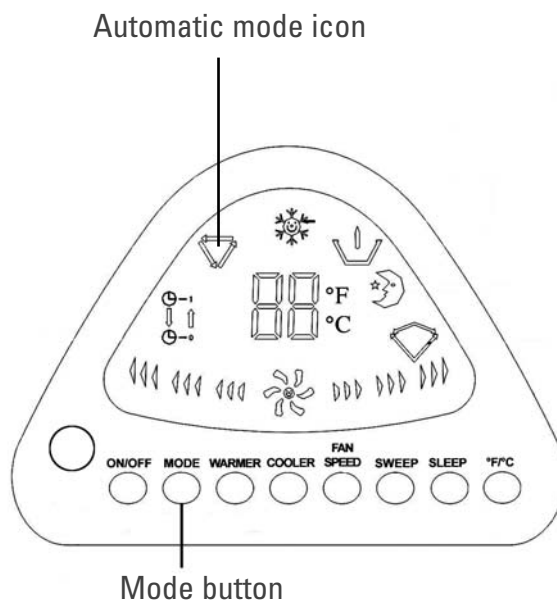
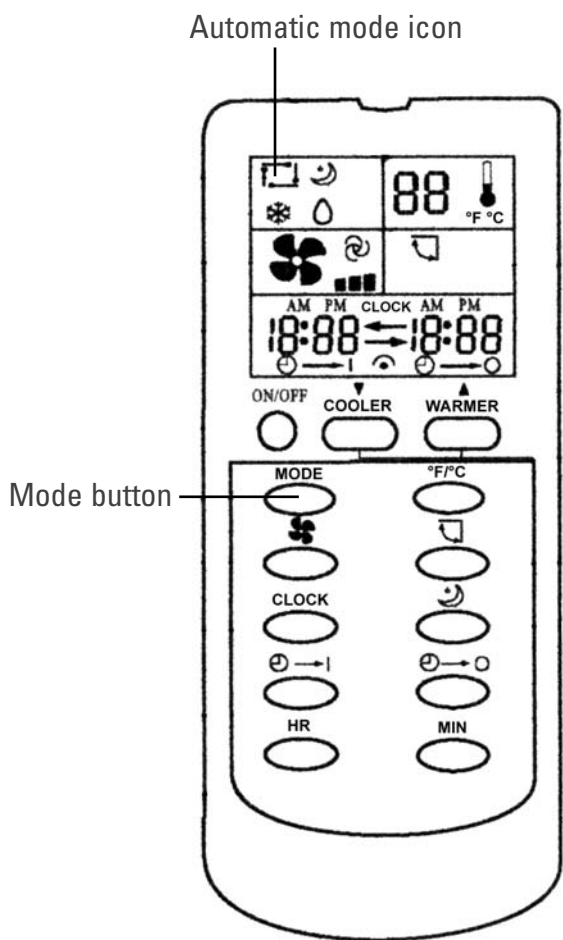

In cooling mode, you can use the remote control and the unit's control panel to adjust the following :

- temperature
- fan speed (Low, med, high, auto)
- airflow direction

1. Press the **ON/OFF** button on the remote control or on the unit's control panel to start the air conditioner.
2. Press the **MODE** button repeatedly until the cooling mode icon (❄️) is displayed in the upper left corner of the remote control and at the top of the unit's control panel display.
3. Press the fan speed adjustment button (🌀) and select the desired speed (low, med, high, auto).
4. To adjust the temperature, press the **WARMER/COOLER** buttons until the targeted temperature is displayed. The available temperature range is between 64 °F and 87 °F.

Each time you press a **WARMER/COOLER** button, the temperature is adjusted by 1 °F.

5. The air conditioner starts cooling, provided that the room temperature is higher than the selected target temperature.

Note:

- If the room temperature is lower than 64 °F, the air conditioner will not allow the compressor to operate in cooling mode.
- If the room temperature is too low and the room humidity is too high, frost or ice can form on the surface of the evaporator. However, the air conditioner is pre-adjusted to protect itself against it. Whenever the evaporator temperature drops below 32 °F, the fan will run at high speed until the evaporator temperature increases to 45 °F.

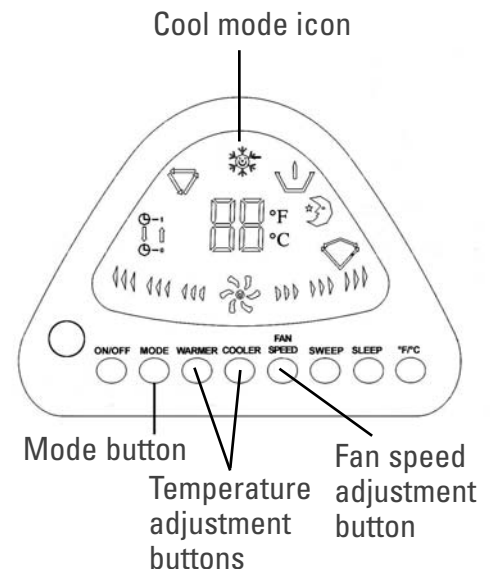
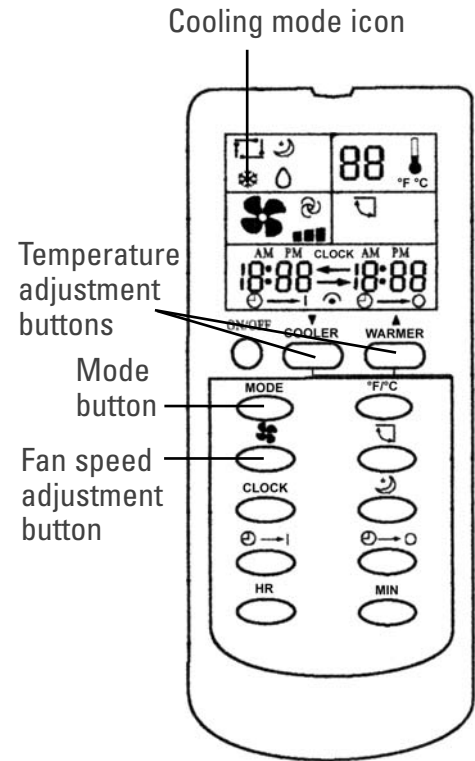

Caution:

Set a reasonable temperature to avoid discomfort from overcooling.

11. DEHUMIDIFYING MODE

In dehumidifying mode, the compressor will automatically run at regular intervals of 10 minutes **ON** and 4 minutes **OFF**.

In this mode, the temperature and the fan speed cannot be adjusted. The fan will automatically run at low speed.

1. Press the **ON/OFF** button on the remote control or on the unit's control panel to start the air conditioner.
2. Press the **MODE** button repeatedly until the dehumidifying mode icon (☉) or (☂) is displayed in the upper left corner of the remote control and at the top of the unit's control panel display.

Note:

The exhaust and intake hoses are not required during dehumidifying mode only. (Do not forget to put the drain tube in a container or directly in a drain).

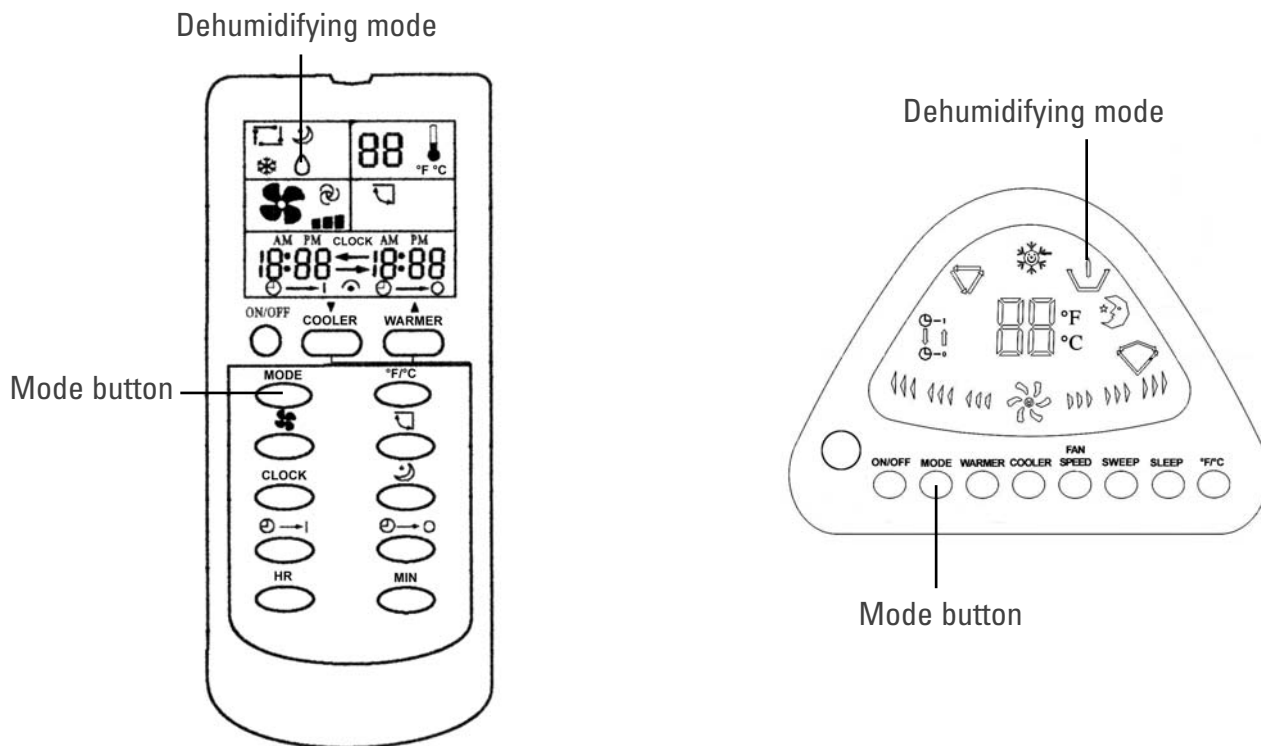

Caution: In cooling and dehumidifying modes, if the compressor cycle is interrupted (due to unplugging, power failure, etc.), a protection circuit is automatically activated, preventing the compressor from operating. This is no cause for alarm, but the protection circuit may need 3-5 minutes to deactivate. Do not attempt to restart the compressor until you hear that the protection circuit is no longer activated.

12. SETTING THE TIMER

Before setting the timer, you have to be sure that the remote control's clock is correctly set. This function offers you a choice of three different timer program options. The programming period is based on a minimum time range of 10 minutes and a maximum time range of 24 hours. These programs have to be set daily and are automatically cancelled with their expiry.

The 3 options are:

Program #1: Setting the **ON** timer and **OFF** timer

This option enables you to program the unit to automatically start operating and shut down at specified times within a maximum range of 24 hours.

1. Press the **ON** timer button. (⊕-|)
2. Press the clock setting buttons (**HR** and **MIN**) to set the time you want the unit to start running.
3. Press the **OFF** timer button. (⊕-○)
4. Press the clock setting buttons (**HR** and **MIN**) to set the time you want the unit to stop running.
5. You have to set all possible adjustments (mode, temperature, fan speed, airflow).
6. The program is confirmed by the illumination of the two icons (⊕-○) and (⊕-|) on the screen of the unit and the display of the timer settings on the remote control.

Program #2: Setting the **ON** timer only

This option enables you to program the unit to automatically start running at a specified time within a maximum time range of 24 hours.

1. Press the **ON** timer button. (⊕-|)
2. Press the clock setting buttons (**HR** and **MIN**) to set the time you want the unit to start running.
3. You have to set all possible adjustments (mode, temperature, fan speed, airflow).
4. The program is confirmed by the illumination of the **ON** timer icon (⊕-|) on the screen of the unit and the display of the timer settings on the remote control.

Program #3: Setting the **OFF** timer only

This option enables you to program the unit to automatically shut down at a specified time within a maximum time range of 24 hours.

1. Press the **OFF** timer button. (⊕-○)
2. Press the clock setting buttons (**HR** and **MIN**) to set the time you want the unit to shut down.
3. The program is confirmed by the illumination of the **OFF** timer icon (⊕-○) on the screen of the unit and the display of the timer settings on the remote control.

To cancel a timer setting, simply press the **ON** timer button (⊕-|) and/or other **OFF** timer button (⊕-○) according to the program you chose. The timer icons on the unit's control panel turn off. On the remote control, the timer settings disappear and the clock displays.

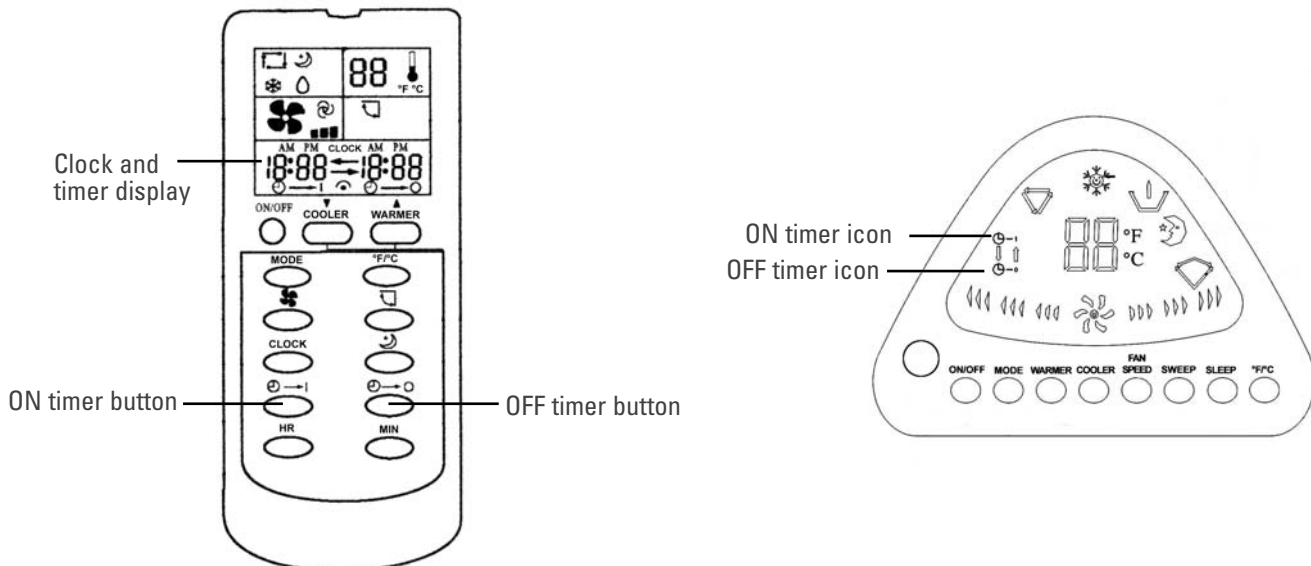

13. SLEEP MODE

In sleep mode, the air conditioner will first attain the desired target temperature. Then, it will allow the temperature to rise 2 °F higher than the target temperature for every hour for up to two hours (4 °F). The unit will automatically slow down after another 6 hours of continuous running.

1. Press the sleep button (☾) on the remote control or on the unit's control panel.
2. To cancel this mode, press the sleep button (☾) again.

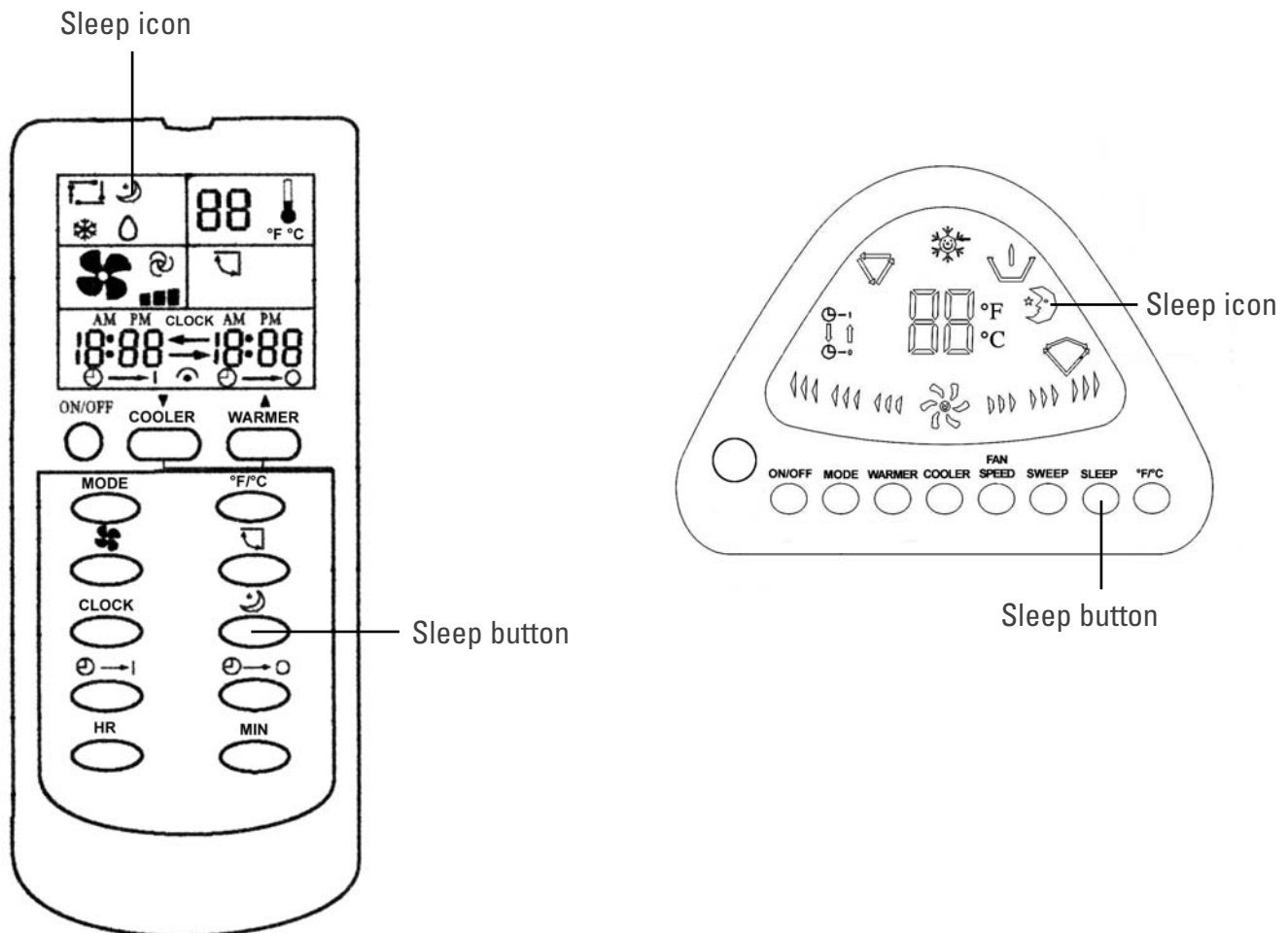

Low-light display screen

Pressing down on the WARM and COOLER keys for at least 3 seconds will shutdown the LED numeric section. Of the display, leaving only the selected operation mode icon lit. This can be undone by simply pressing any button.



14. ADJUSTING THE AIRFLOW DIRECTION

Adjusting the vertical airflow

If you want the outer blades to move up and down automatically when the air conditioner is operating, press the SWEEP button () on the remote control or on the unit's control panel. Press the SWEEP button () again when the blades are at any position that you desire and they will remain in that position.

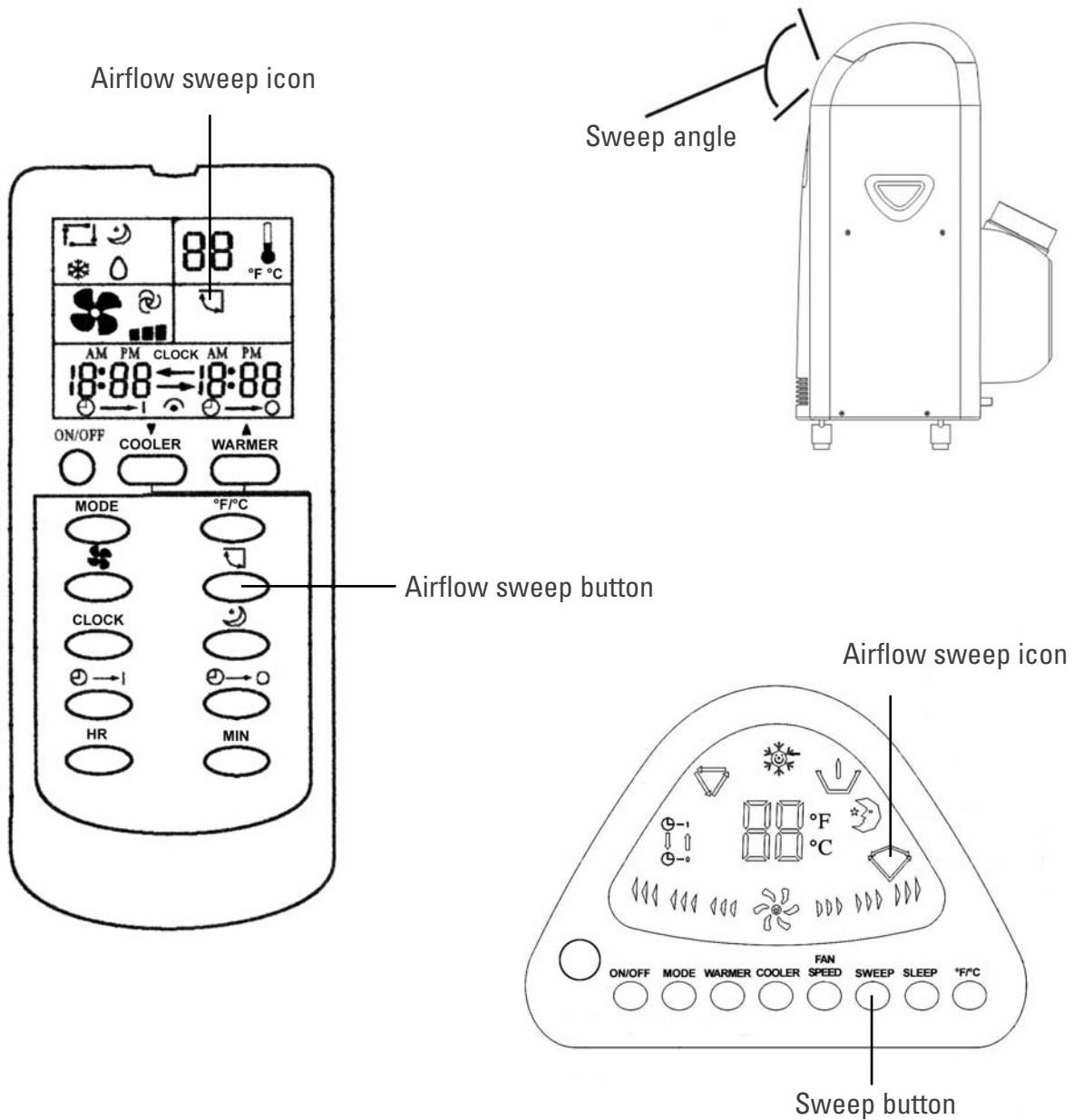

15. SETTING THE FAN SPEED

Press the fan speed adjustment button () repeatedly until the required setting is displayed.

On the remote control you will see the following:

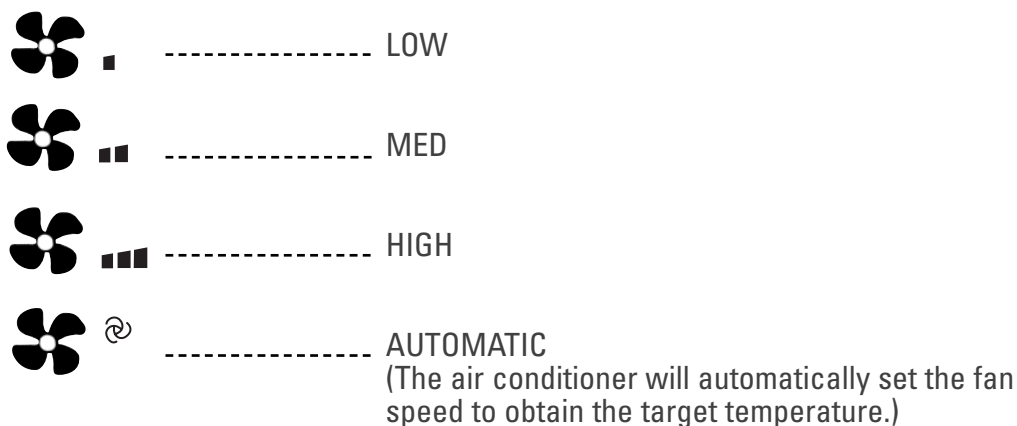

On the unit's control panel you will see the following:

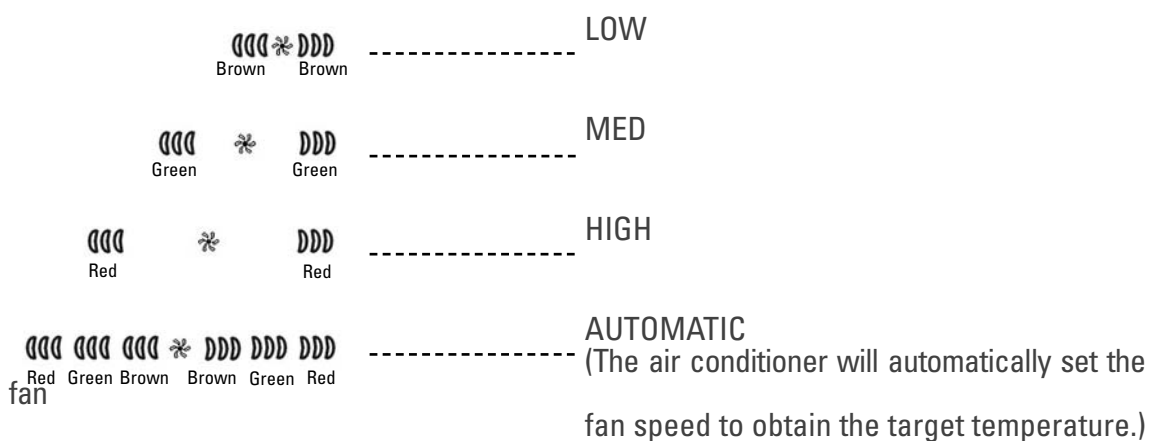

IMPORTANT

Shutting down the display screen

Pressing down on the FAN SPEED and SWEEP buttons simultaneously for at least 3 seconds. To unlock, simply repeat the same procedure.

- Before cleaning your air conditioner, make sure that you have turned the unit off and then unplugged it.
- To obtain the best possible results from your air conditioner, clean it regularly, removing any dust that has accumulated in the air filters or on the condenser coils.
- If you have not used the air conditioner for a long period of time, run the fan for 3 or 4 hours to thoroughly dry the inside of the air conditioner.
- Do not clean the unit's surface with thinners, alcohol, polishers, alkaline detergents, acid, or an abrasive brush. Such items could scratch and damage the finish.

To clean the air filters

1. Open the front grid by lifting the tabs on the lower right and left sides of the unit. Raise the front grid until it snaps tight in an open position.
2. Remove the air filters.
3. Remove all dust from the air filters with a vacuum cleaner or a soft brush, or wash them with warm water. (Do not use benzene, solvents, or other chemicals.)
4. When you have finished, put the air filters back into the unit and close the front grid.

Note:

Failure to keep air filters clean will result in poor air circulation. Do not operate the air conditioner without its filters. Dirt and lint will clog the evaporator surface, reduce airflow, and possibly cause ice to form, reducing the unit's cooling capacity.

To clean the condenser coils

Press on the three snaps located on the lower rear side of the unit and open the door to access the condenser coils. Gently clean the coils with a soft-bristled brush.

Note:

Dirty condenser coils will increase condensing pressure and may result in high power consumption. Moreover, the high-pressure safety control may be activated, causing the system to shut down.

17. TROUBLESHOOTING

Before contacting the HVAC technician, perform the following simple checks. They may save you the time and expense of an unnecessary call.

Problem	Cause	Solution
The unit does not work at all.	The unit is not plugged in.	Plug in the power cord.
	There is no power at the receptacle.	Check the fuses and the circuit breaker.
	The ON timer is activated.	Cancel the timer
Cooling performance is poor.	The wrong function mode was selected.	Select the correct function mode. (auto, cooling)
	The air exhaust hose or the air intake hose is blocked or broken.	Remove any object that may be obstructing air circulation. Repair the hose or change it.
	The air filters are dirty.	Clean filters.
	There is an obstacle in front of the unit.	Clear all obstacles.
The unit is operating, but the air remains warm.	The compressor is not yet operating.	Wait 3-5 minutes for the compressor protection circuit to turn off.
	The temperature is incorrectly set.	Adjust the temperature setting.
The compressor stops running after a short time.	There is not enough voltage.	Unplug other appliances that may overload the electrical circuit breaker.
	The unit is connected to an extension cord.	Remove the extension cord or use a proper extension cord for air conditioners.
Water is leaking.	The drain tube is clogged.	Remove the blockage.
The unit is making unusual noises.	The unit is not level.	Place the unit on a level surface.
The unit is working, but the room is still not cool enough.	The room's BTU demand is greater than the unit's capacity.	The room needs a greater cooling capacity: add another unit or upgrade to a unit with greater BTU capacity.
The evaporator fan is noisy.	Cross flow fan is not well balanced.	The unit needs to be repaired, or parts must be replaced.
The condenser fan is noisy.	The fan is rubbing against the plastic housing.	The unit needs to be repaired, or parts must be replaced.
The air conditioner does not operate with the remote control.	There is an obstacle between the remote control and the signal receiver.	Make sure the signal path is clear.
	The batteries are weak.	Replace the batteries.
	You are too far from the unit.	Get closer (Within 23 ft).



CAUTION:

Have repairs performed by a certified HVAC technician.

TROUBLE INDICATORS

If a problem occurs with the air conditioner, the control panel will display the following codes:

Trouble/Display	Reason	Maintenance
E1	Problem with the room temperature sensor.	Check the room temperature sensor.
E2	Problem with the pipe temperature sensor.	Check the pipe temperature sensor.
E4	An abnormality in the unit's system is affecting the cooling capacity.	Check refrigerant. If the air filters are dirty, remove dust and wash them with water.
E5	Problem with the pump.	Check the pump's water level switch or check if the pump works properly.

**CAUTION:**

Have repairs performed by a certified HVAC technician.

18. TIPS FOR SAVING ENERGY

- Keep air filters clean.
- Do not allow the room to get too hot. Whenever possible, turn the unit on before the room heats up. When heat is “stored” in walls, furniture, rugs, or draperies, the air conditioner takes longer to produce the desired level of comfort.
- Keep windows and doors closed. Cool, dry air escapes when they are open.
- Keep furnace floor registers and cold air returns closed. Cold air can easily escape through them.
- Do not let drapes or furniture block the front of the unit, where they can restrict airflow when it is operating.
- It is best to operate your air conditioner at high speed during extremely hot weather.
- Keep condenser coils clean.
- Turn the air conditioner off if you do not expect to use it for an extended period of time.



Williamson-Thermoflo

8201 W. Calumet Road, Milwaukee, WI 53223 USA

www.williamson-thermoflo.com

Free Manuals Download Website

<http://myh66.com>

<http://usermanuals.us>

<http://www.somanuals.com>

<http://www.4manuals.cc>

<http://www.manual-lib.com>

<http://www.404manual.com>

<http://www.luxmanual.com>

<http://aubethermostatmanual.com>

Golf course search by state

<http://golfingnear.com>

Email search by domain

<http://emailbydomain.com>

Auto manuals search

<http://auto.somanuals.com>

TV manuals search

<http://tv.somanuals.com>