

INSTALLATION INSTRUCTIONS
AND
REPAIR PARTS INFORMATION

WOODS

#118470 LOADER MOUNTING KIT

#58025 HOSE KIT

for mounting Woods Model 215 Loader to
FORD/NH 5640 Tractors

WOODS

TO THE DEALER:

The loader mounting kit assembly and proper installation to the tractor is the responsibility of the Woods dealer. Read manual instructions and safety rules. Make sure all items on the Pre-Delivery and Delivery Check Lists in the loader manual are completed before releasing equipment to the owner.

TO THE OWNER:

Read these mounting instructions before installing loader mounting kit. The information presented will prepare you to do a better and safer job. Keep this document handy for ready reference. Require all operators to read the loader manual carefully and become acquainted with all the adjustment and operating procedures before attempting to operate. Replacement manuals can be obtained from your dealer or by calling 1-800-319-6637, in the USA or Canada only.

The loader mounting kit you have purchased has been carefully engineered and manufactured to provide dependable and satisfactory use. Like all mechanical products, it will require cleaning and upkeep. Observe all safety information in this document, the loader and tractor manuals, and all safety decals on the loader and tractor.

For service, your authorized Woods dealer has trained mechanics, genuine Woods service parts, and the necessary tools and equipment to handle all your needs.

Use only genuine Woods service parts. Substitute parts will void the warranty and may not meet standards required for safe and satisfactory operation. Record the model number of your mounting kit and provide it to your dealer when requesting repair parts.

Model: Woods #118470 Loader Mounting Kit

Throughout this manual, the term **IMPORTANT** is used to indicate that failure to observe can cause damage to equipment. The terms **CAUTION**, **WARNING** and **DANGER** are used in conjunction with the Safety-Alert Symbol, (a triangle with an exclamation mark), to indicate the degree of hazard for items of personal safety.



This Safety-Alert Symbol indicates a hazard and means **ATTENTION! BECOME ALERT! YOUR SAFETY IS INVOLVED!**



Indicates an imminently hazardous situation that, if not avoided, will result in death or serious injury.



Indicates a potentially hazardous situation that, if not avoided, could result in death or serious injury, and includes hazards that are exposed when guards are removed



Indicates a potentially hazardous situation that, if not avoided, may result in minor or moderate injury.

SAFETY RULES



ATTENTION! BECOME ALERT! YOUR SAFETY IS INVOLVED!



Safety is a primary concern in the design and manufacture of our products. Unfortunately, our efforts to provide safe equipment can be wiped out by a single careless act of an operator.

In addition to the design and configuration of equipment, hazard control and accident prevention are dependent upon the awareness, concern, prudence and proper training of personnel involved in the operation, transport, maintenance and storage of equipment.

It has been said *"The best safety device is an informed, careful operator."* We ask you to be that kind of an operator.

The designed and tested safety of this equipment depends on it being operated within the limitations as explained in this manual.

INSTALLATION

■ During installation, the tractor engine should be off, the key removed and the brakes locked. Do not disconnect hydraulic lines until attachments are removed or lowered to the ground and system pressure is released by operating valve levers. Never operate any hydraulic cylinders during any phase of the installation process.

■ Only use this mounting kit for mounting Woods 215 loader on FORD/NH 5640 tractors. Any other use or modification of this mounting kit may result in serious injury or death.

■ After connecting hoses, check that all control lever positions function as instructed in the Operator's Manual. Do not operate until control lever and equipment movements are correct.

TRAINING

■ Read and understand this manual, the loader manual and the tractor manual before any operation, assembly or maintenance. Follow all safety rule and safety decal instructions. (Replacement manuals are available from dealer or, in the United States and Canada, call 1-800-319-6637.) Failure to follow safety instructions can result in serious injury or death.

■ If you do not understand any part of this manual and need assistance, see your dealer.

■ Keep hands and body away from pressurized lines. Use paper or cardboard, not body parts to check for leaks. Wear safety goggles. Hydraulic fluid under pressure can easily penetrate skin and will cause serious injury or death.

■ Make sure that all operating and service personnel know that in the event hydraulic fluid penetrates skin, it must be surgically removed as soon as possible by a doctor familiar with this form of injury, or gangrene, serious injury or death will result. **CONTACT A PHYSICIAN IMMEDIATELY IF FLUID ENTERS SKIN OR EYES. DO NOT DELAY.**

■ Do not allow children or untrained persons to operate equipment.

PREPARATION

■ Check that all hardware is tight and properly installed. Always tighten to torque chart specifications.

■ Air in hydraulic systems can cause erratic operation and allows loads or equipment components to drop unexpectedly. Before operating or allowing anyone to approach the equipment, purge any air in the system by operating all hydraulic functions several times after connecting equipment, connecting hoses, or doing any hydraulic maintenance.

■ After connecting hoses, check that all control lever positions function as instructed in the Operator's Manual. Do not operate until control lever and equipment movements are correct.

■ Protective sleeves must be over hydraulic hoses and securely fastened onto metal hose fittings as described in this manual. Replace if damaged or if protective sleeve is not properly positioned or secured.

■ Make sure all hydraulic hoses, fittings and valves are in good condition and not leaking before starting power unit or using equipment. Check and route hoses carefully to prevent damage. Hoses must not be twisted, bent sharply, kinked, frayed, pinched, or come into contact with any moving parts. Operate moveable components through full operational range to check clearances. Replace any damaged hoses immediately.

(Safety Rules continued on next page)

SAFETY RULES



ATTENTION! BECOME ALERT! YOUR SAFETY IS INVOLVED!



(Safety Rules continued from previous page)

- Always wear relatively tight and belted clothing to avoid entanglement in moving parts. Wear sturdy, rough-soled work shoes and protective equipment for eyes, hair, hands, hearing and head.
- Ensure implement is properly attached, adjusted and in good operating condition.
- Power unit must be equipped with ROPS or ROPS CAB and seat belt. Keep seat belt securely fastened. Falling off power unit can result in death from being run over or crushed. Keep foldable ROPS systems in “locked up” position at all times.
- Whenever 3-point implements are attached to tractor, always check full range of operation for mechanical or hydraulic hose interference.
- Ensure shields and guards are properly installed and in good condition. Replace if damaged.

OPERATIONAL SAFETY

- Do not allow other people in the area when operating, attaching, removing, assembling or servicing equipment.
- Do not operate equipment while under the influence of alcohol or drugs.
- Power unit must be equipped with ROPS or ROPS CAB and seat belt. Keep seat belt securely fastened. Falling off power unit can result in death from being run over or crushed. Keep foldable ROPS systems in “locked up” position at all times.
- Always sit in tractor seat when operating controls or starting engine. Securely fasten seat belt, place transmission in neutral, engage brake and ensure all other controls are disengaged before starting tractor engine.

- Before dismounting tractor or performing any service or maintenance, disengage power to implement, lower the 3-point hitch and all raised components to the ground, operate valve levers to release any hydraulic pressure, stop engine, set parking brake, remove key, and unfasten seat belt.

MAINTENANCE SAFETY

- Refer to loader manual and follow all maintenance safety rules and instructions.
- Do not allow other people in the area when operating, attaching, removing, assembling or servicing equipment.
- Do not modify or alter or permit anyone else to modify or alter the equipment or any of its components in any way.
- Before dismounting tractor or performing any service or maintenance, disengage power to implement, lower the 3-point hitch and all raised components to the ground, operate valve levers to release any hydraulic pressure, stop engine, set parking brake, remove key, and unfasten seat belt.
- Your dealer can supply original equipment hydraulic accessories and repair parts. Substitute parts may not meet original equipment specifications and may be dangerous.
- Always wear relatively tight and belted clothing to avoid entanglement in moving parts. Wear sturdy, rough-soled work shoes and protective equipment for eyes, hair, hands, hearing and head.
- Ensure implement is properly attached, adjusted and in good operating condition.
- Keep all persons away from operator control area while performing adjustments, service or maintenance.
- Tighten all bolts, nuts and screws to torque chart specifications. Check that all cotter pins are installed securely to ensure equipment is in a safe condition before operating.
- Ensure shields and guards are properly installed and in good condition. Replace if damaged.

SAFETY RULES

⚠ ATTENTION! BECOME ALERT! YOUR SAFETY IS INVOLVED! ⚠

 <p>19924</p>	⚠ WARNING
	<p>HIGH PRESSURE HYDRAULIC OIL LEAKS CAN PENETRATE SKIN</p> <ul style="list-style-type: none"> ■ CHECK FOR LEAKS WITH CARDBOARD; NEVER USE HAND. ■ BEFORE LOOSENING FITTINGS: LOWER LOAD, RELEASE PRESSURE, AND BE SURE OIL IS COOL. ■ CONSULT PHYSICIAN IMMEDIATELY IF SKIN PENETRATION OCCURS. <p>SKIN PENETRATION CAN RESULT IN SERIOUS INJURY AND GANGRENE.</p>

⚠ WARNING
<ul style="list-style-type: none"> • Read and understand Operator's Manual before operating (available from dealer or call 1-800-319-6637). • Keep others away when operating loader. • Do not allow children or untrained persons to operate equipment. • Lower loader to ground, stop engine, set park brake and remove key before leaving tractor seat. • Failure to follow safety rules can result in serious injury or death.

⚠ WARNING

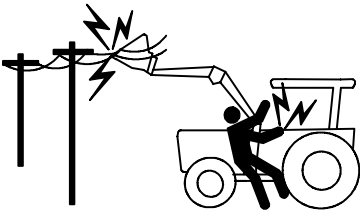

<p>FALLING LOAD HAZARD TO AVOID INJURY OR DEATH:</p> <ul style="list-style-type: none"> • Do not handle round bale or other shiftable load unless loader is equipped with approved attachments. (Read Operator's Manual.) • Lift and carry only one bale at a time. • Handle raised load with caution. • Carry load low. <p style="text-align: right;">26-0352</p>

⚠ DANGER

SERIOUS INJURY OR DEATH CAN RESULT FROM CONTACT WITH ELECTRICAL LINES.

⚠ DANGER

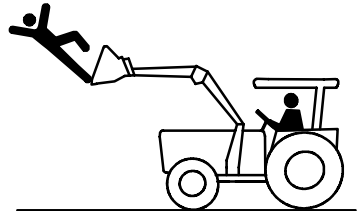
<p>ROLLOVERS CAN RESULT IN INJURY OR DEATH</p> <ul style="list-style-type: none"> • ALWAYS USE ROPS AND SEAT BELT. • ADD REAR TRACTOR BALLAST • MOVE WHEELS TO WIDEST SETTING. • AVOID SLOPE OPERATION. • OPERATE AT LOW SPEEDS. • CARRY LOAD LOW. <p style="text-align: right;">26-0351</p>

⚠ WARNING

FALLING HAZARD TO AVOID INJURY OR DEATH:

- DO NOT WORK FROM OR ALLOW RIDERS ON LOADER OR ITS ATTACHMENTS.

⚠ WARNING

<p>CRUSHING HAZARD TO AVOID INJURY OR DEATH:</p> <ul style="list-style-type: none"> • DO NOT WALK OR WORK UNDERNEATH A RAISED LOADER. • LOWER LOADER TO GROUND BEFORE LEAVING TRACTOR SEAT. <p style="text-align: right;">26-0350</p>
--

BOLT TORQUE CHART

SAE Series Torque Chart

Always tighten hardware to these values unless a different torque value or tightening procedure is listed for a specific application.

Fasteners must always be replaced with the same grade as specified in the manual parts list.

Make sure fastener threads are clean and you properly start thread engagement.

SAE Bolt Head Identification

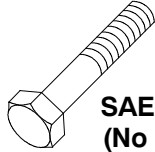

**SAE Grade 2
(No Dashes)**

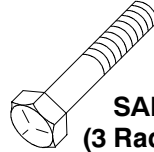

**SAE Grade 5
(3 Radial Dashes)**

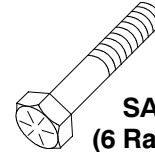

**SAE Grade 8
(6 Radial Dashes)**

Bolt Diameter "A"	Wrench Size	MARKING ON HEAD					
		SAE 2		SAE 5		SAE 8	
		Lbs.-Ft.	(N-m)	Lbs.-Ft.	(N-m)	Lbs.-Ft.	(N-m)
1/4"	7/16"	6	(8)	11	(15)	14	(19)
5/16"	1/2"	13	(18)	21	(28)	25	(34)
3/8"	9/16"	23	(31)	38	(52)	55	(75)
7/16"	5/8"	37	(50)	55	(75)	80	(110)
1/2"	3/4"	57	(77)	85	(115)	120	(165)
9/16"	13/16"	82	(111)	125	(170)	180	(245)
5/8"	15/16"	111	(150)	175	(240)	230	(310)
3/4"	1-1/8"	200	(270)	300	(410)	440	(600)
7/8"	1-5/16"	280	(380)	450	(610)	720	(975)
1"	1-1/2"	350	(475)	680	(925)	1035	(1400)
1-1/8"	1-11/16"	450	(610)	885	(1200)	<p>Bolt Diameter</p>	
1-1/4"	1-7/8"	600	(815)	1255	(1700)		
1-3/8"	2-1/16"	675	(915)	1620	(2200)		
1-1/2"	2-1/4"	920	(1250)	2200	(2900)		

Metric Series Torque Chart

Use only metric tools on metric hardware.

Always tighten hardware to these values unless a different torque value or tightening procedure is listed for a specific application.

Fasteners must always be replaced with the same grade.

Make sure fastener threads are clean and you properly start thread engagement.

Bolt Diameter "A"	Wrench Size	MARKING ON HEAD			
		8.8		10.9	
		N-m	(Lbs.-Ft.)	N-m	(Lbs.-Ft.)
5 mm	8 mm	6	(4.5)	9	(6.5)
6 mm	10 mm	10	(7.5)	15	(11)
8 mm	13 mm	25	(18)	35	(26)
10 mm	16 mm	50	(37)	75	(55)
12 mm	18 mm	85	(63)	130	(97)
14 mm	21 mm	110	(80)	150	(110)
16 mm	24 mm	215	(159)	315	(232)
20 mm	30 mm	435	(321)	620	(457)
24 mm	36 mm	750	(553)	1070	(789)
30 mm	46 mm	1495	(1103)	2130	(1571)

Metric Bolt Head Identification

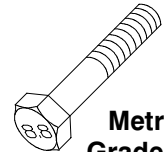

Metric Grade 8.8

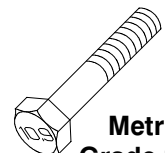

Metric Grade 10.9

BOLT SIZE CHART

NOTE: Chart shows bolt thread sizes and corresponding head (wrench) sizes for standard SAE and Metric Bolts.

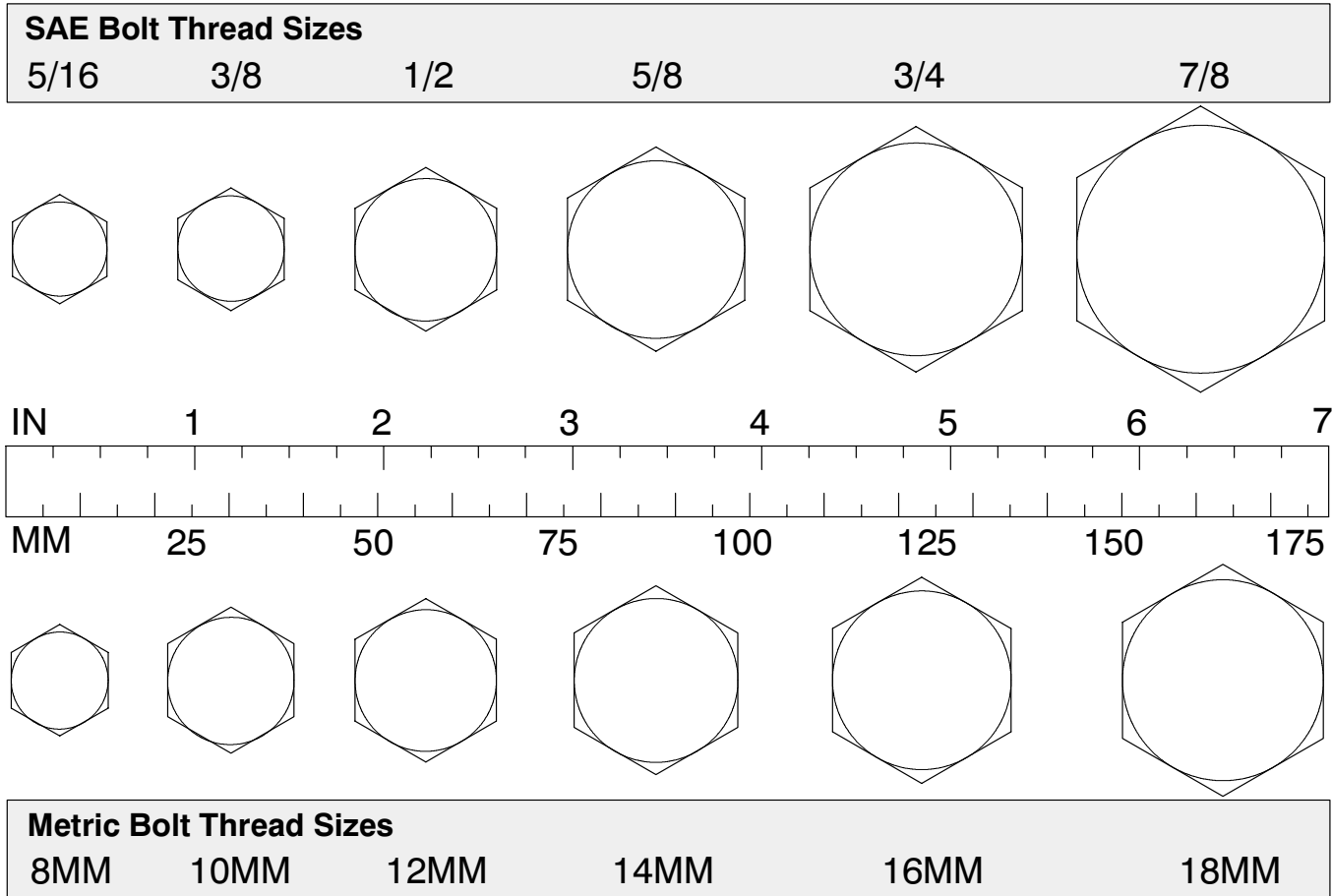

NOTES

LOADER MOUNTING KIT ATTACHMENT

Loader mounting kit assembly is the responsibility of the Woods dealer. It must be properly installed and checked before delivery to the customer. Please check the loader mounting kit to see that all pieces have been received.

For installing this mounting kit, references to right, left, forward and rearward directions are determined from the operator's position in the tractor seat.

WARNING

■ Only use this mounting kit for mounting Woods 215 loader on FORD/NH 5640 tractors. Any other use or modification of this mounting kit may result in serious injury or death.

■ Read and understand this manual, the loader manual and the tractor manual before any operation, assembly or maintenance. Follow all safety rule and safety decal instructions. (Replacement manuals are available from dealer or, in the United States and Canada, call 1-800-319-6637.) Failure to follow safety instructions can result in serious injury or death.

CAUTION

■ If you do not understand any part of this manual and need assistance, see your dealer.

■ Always wear relatively tight and belted clothing to avoid entanglement in moving parts. Wear sturdy, rough-soled work shoes and protective equipment for eyes, hair, hands, hearing and head.

WARNING

■ Do not modify or alter or permit anyone else to modify or alter the equipment or any of its components in any way.

Tractor Preparation

Shut off engine and set parking brake during installation.

Remove tractor front weights and weight bracket if so equipped.

Install loader front frame: Before removing loader from shipping pallet, remove loader front frame and replace with new open frame supplied with loader mounting kit. Tighten frame cap screws to specifications in Torque Chart.



Figure 1. Loader Front Frame

Installing Loader Front Mount, Figure 1 and Figure 2.

Refer to Parts Lists for reference number and assembly illustration.

Leave cap screws loose until front support is completely installed.



Figure 2. Loader Front Mount

Use flat washers with cap screws and lockwashers to cover slotted mounting holes in tractor side frame, Figure 2.

Use cap screws and lockwashers at tractor front frame, Figure 3.

Tighten all cap screws to specifications given on the Bolt Torque chart.

Installing Loader Rear Mount (Figure 3)

Refer to Parts Lists for reference number and assembly illustration.

Leave cap screws loose until rear loader mounts are completely installed.

Attach Left and Right Loader Mounts to tractor chassis.

Use cap screws and lockwashers at tractor clutch housing and side frame, Figure 3.

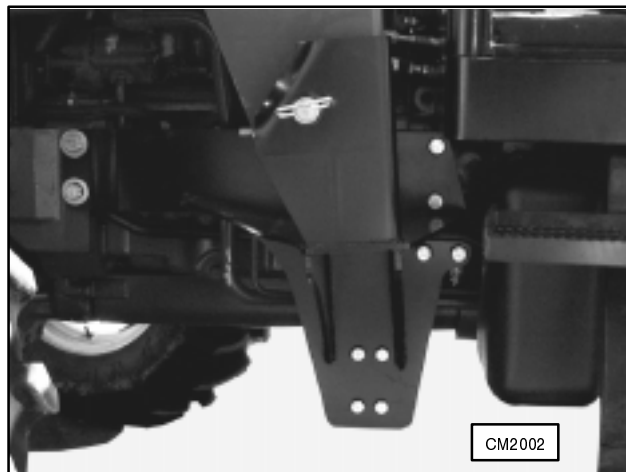

Figure 3. Installing Loader Rear Mount to Tractor
(left side shown)

Install Crossmember

Install crossmember to left and right rear mounts using cap screws, flat washers, and nuts as shown in Figure 4.

Tighten all Loader Mounting Kit cap screws to specifications given on the Torque chart.

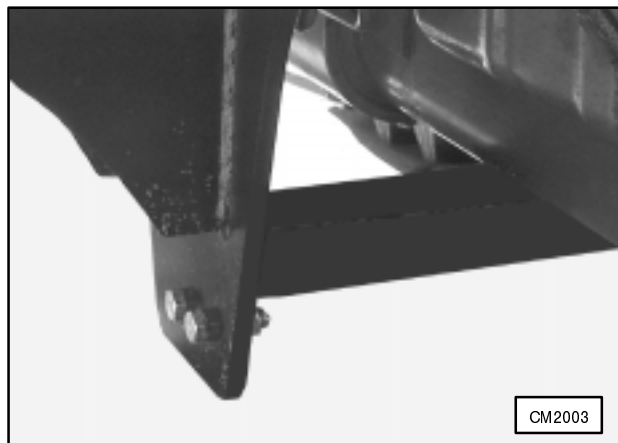

Figure 4. Install Crossmember

NOTES

LOADER HYDRAULIC CONNECTIONS

WARNING

■ Keep hands and body away from pressurized lines. Use paper or cardboard, not body parts to check for leaks. Wear safety goggles. Hydraulic fluid under pressure can easily penetrate skin and will cause serious injury or death.

■ Make sure that all operating and service personnel know that in the event hydraulic fluid penetrates skin, it must be surgically removed as soon as possible by a doctor familiar with this form of injury, or gangrene, serious injury or death will result. CONTACT A PHYSICIAN IMMEDIATELY IF FLUID ENTERS SKIN OR EYES. DO NOT DELAY.

■ Air in hydraulic systems can cause erratic operation and allows loads or equipment components to drop unexpectedly. Before operating or allowing anyone to approach the equipment, purge any air in the system by operating all hydraulic functions several times after connecting equipment, connecting hoses, or doing any hydraulic maintenance.

■ Make sure all hydraulic hoses, fittings and valves are in good condition and not leaking before starting power unit or using equipment. Check and route hoses carefully to prevent damage. Hoses must not be twisted, bent sharply, kinked, frayed, pinched, or come into contact with any moving parts. Operate moveable components through full operational range to check clearances. Replace any damaged hoses immediately.

■ Protective sleeves must be over hydraulic hoses and securely fastened onto metal hose fittings as described in this manual. Replace if damaged or if protective sleeve is not properly positioned or secured.

USING TRACTOR CONTROL LEVERS TO OPERATE LOADER

Refer to Parts Lists for reference number and assembly illustration.

These set up instructions are for operating the loader using the tractor hydraulic remote control levers. To use this hydraulic connection the tractor must be equipped with two hydraulic levers and four tractor hydraulic couplers as shown (Figure 7). Hose kit

#58025 must be used to complete the hydraulic connection.

Attach 90 degree adapter and male hydraulic coupler to each loader supply hose.

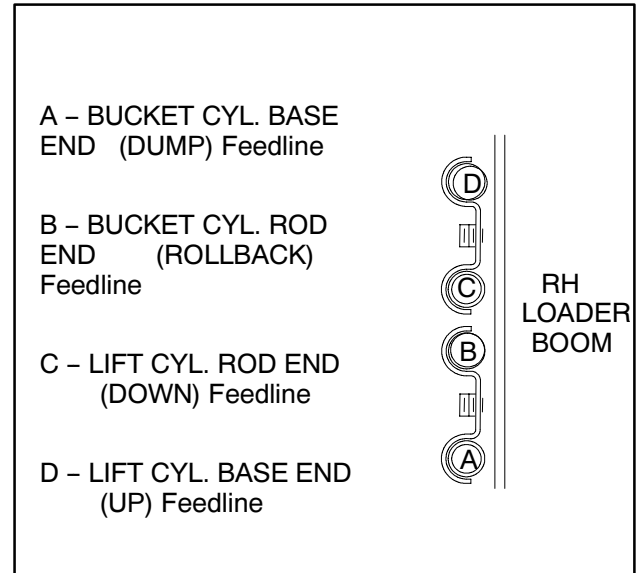

Figure 5. Loader Feed Line Identification (viewed from rear)

Hydraulic couplers for connection to tractor are NOT INCLUDED with hose kits, but are available as service parts.

Connect loader supply hoses to loader feed lines. (Figure 5)

Route hydraulic hoses along loader mount, under the right side of operators platform, and under the tractor platform. Be sure to avoid contact with three-point linkage, brake pedals, and other moveable tractor components.



Figure 6. Hose routing

Hoses must be routed so that they are not pinched, bent sharply, or chafed during operation. Hoses must not interfere with any tractor control operation or contact any moving parts.

Connect hydraulic hoses to tractor hydraulic couplers as shown in Figure 7.

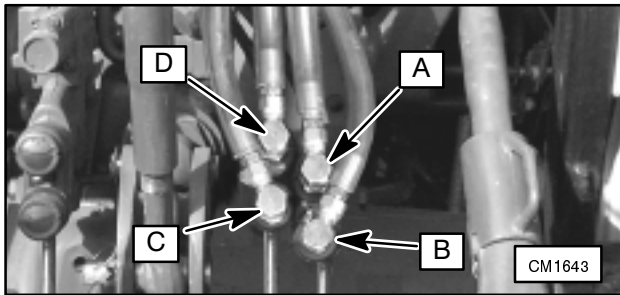

Figure 7. Hose Connection to Tractor Hydraulic Couplers

Verification of Control Movements

Refer to tractor operator's manual for instructions on operating the tractor hydraulic levers.

WARNING

■ After connecting hoses, check that all control lever positions function as instructed in the Operator's Manual. Do not operate until control lever and equipment movements are correct.

Comply with all Safety Rules and start the tractor. Check that all hydraulic control lever positions operate the loader movements correctly as shown in Figure 8. If loader movements do not respond correctly, recheck all connections. Loader control movements must be correct before proceeding.

Once all hoses are connected, start the tractor and operate the loader to check for leaks and purge any remaining air from hydraulic system.

Check to be sure the valve handle directions correspond with the motion of the loader.

When hose routings and correct loader operations are verified, identify each circuit by placing a matching colored band around the male and female hydraulic-disconnect coupler. The color-coded bands will make reinstallation easier when the loader is removed from tractor.

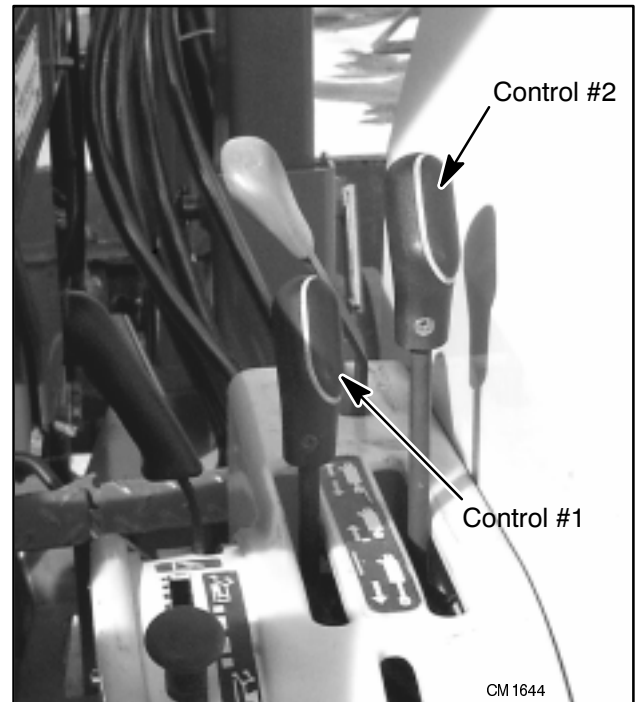

- Control #1, Handle forward – Boom down
- Control #1, Handle back – Boom up
- Control #2, Handle forward – Dump bucket or attachment
- Control #2, Handle back – Rollback bucket or attachment

Figure 8. Tractor Hydraulic Control Levers (Typical)

Attach the plastic tie straps (included in kit) every 20" around the hoses to keep them tightly bundled and away from contact with the ground or other moving parts on the tractor or loader.

OPERATION

Refer to the Woods 215 Loader Operator's Manual to complete the loader installation.

Front tractor tires must not contact the loader or loader mounting brackets during operation. Tires must be checked for possible contact at full turning radius and maximum axle oscillation before operating the loader. See your tractor operator's manual for the proper adjustment procedure and adjust the front axle steering stops as required to obtain clearance.

Before operating the loader, make sure that the Pre-Delivery, Delivery and Pre-Operation Checklists have been completed.

118470 LOADER MOUNTING KIT PARTS LIST

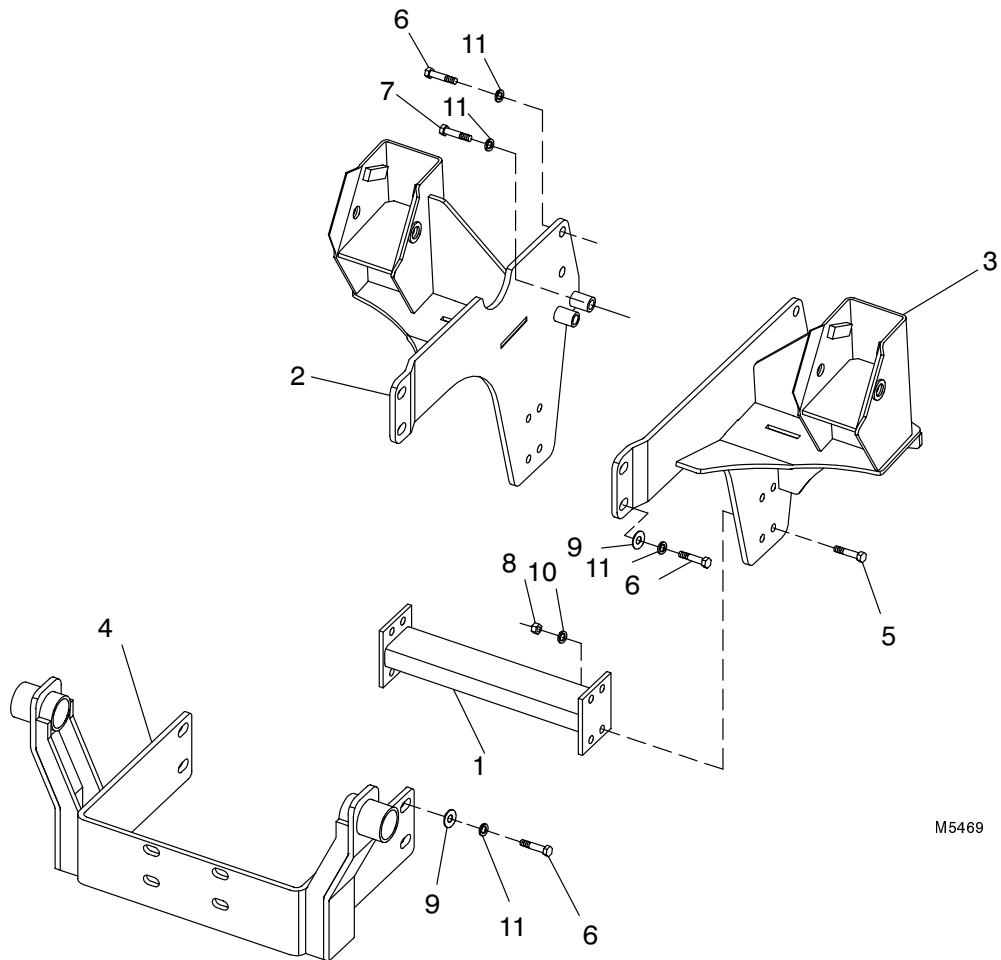

M5469

Ref No	Part No	No Used	Description	Ref No	Part No	No Used	Description
1	58377	1	Rear support	6	58471	16	3/4 NC x 1-3/4 Hex head cap screw GR8
2	58602	1	Right hand rear mount	7	58474	4	3/4 x 3 Hex head cap screw GR8
3	58603	1	Left hand rear mount	8	230	8	5/8 NC Hex nut
4	52615	1	Front mount	9	57798	12	3/4 Flat washer, plated
5	902	8	5/8 NC x 2 Hex head cap screw GR5	10	1286	8	5/8 Lockwasher
				11	2522	20	3/4 Lockwasher, plated

NOTES

#58025 HYDRAULIC HOSE KIT

A – BUCKET CYL. BASE END
(DUMP)

B – BUCKET CYL. ROD END
(ROLLBACK)

C – LIFT CYL. ROD END
(DOWN)

D – LIFT CYL. BASE END
(UP)

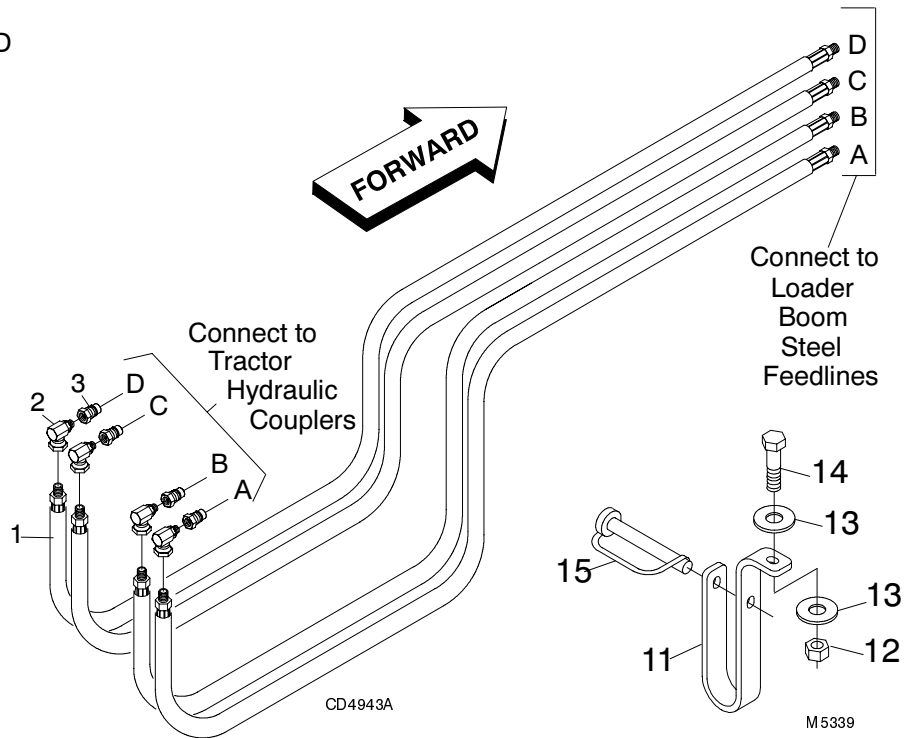

Ref No	Part No	No Used	Description	Ref No	Part No	No Used	Description
1	53670	4	3/8 x 120 hose with protective sleeves clamped at both ends 8JICM x 8JICM	13*	4378	2	5/16 Flat washer
2	313053	4	90 deg. elbow with 8JICF x 1/2 NPTM	14*	6250	1	5/16NC x 1-1/4 Hex head cap screw GR5
3	66511	4	1/2 male hydraulic coupler x 1/2 NPTM (not included in kit)	15	58047	1	1/4 x 2-1/2 Lock pin
11*	58033	1	Hose hanger bracket	NS	88	A/R	Plastic Tie Strap
12*	6778	1	5/16NC Lock nut	NS	395061	2	Red ID band
				NS	395062	2	Blue ID band
				NS	395063	2	Orange ID band
				NS	54124	2	White ID band

(* Not used for this application)

NOTES

WARRANTY

Please enter information below and **SAVE FOR FUTURE REFERENCE.**

Date Purchased: _____ From (Dealer): _____

Model Number: _____ Serial Number: _____

WOODS warrants each new WOODS product to be free from defects in material and workmanship. This warranty is applicable only for the normal service life expectancy of the machine or components, not to exceed twelve consecutive months from the date of delivery of the new WOODS product to the original purchaser.

Genuine WOODS replacement parts and components will be warranted for 90 days from date of purchase, or the remainder of the original equipment warranty period, whichever is longer.

Under no circumstances will it cover any merchandise or components thereof, which, in the opinion of the company, has been subjected to negligent handling, misuse, alteration, an accident, or if repairs have been made with parts other than those obtainable through WOODS.

The company in no way warrants engines, batteries, tires or other trade accessories since these items are warranted separately by their respective manufacturers.

Our obligation under this warranty shall be limited to repairing or replacing, free of charge to the original purchaser, any part that in our judgement shall show evidence of such defect, provided further that such part shall be returned within thirty (30) days from date of failure to WOODS, routed through the dealer and distributor from whom the purchase was made, transportation charges prepaid.

This warranty shall not be interpreted to render us liable for injury or damages of any kind or nature to person or property. This warranty does not extend to loss of crops, loss because of delay in harvesting, or any expense or loss incurred for labor, supplies, substitute machinery, rental or for any other reason.

Except as set forth above, WOODS SHALL HAVE NO OBLIGATION OR LIABILITY OF ANY KIND ON ACCOUNT OF ANY OF ITS EQUIPMENT AND SHALL NOT BE LIABLE FOR SPECIAL OR CONSEQUENTIAL DAMAGES. WOODS MAKES NO OTHER WARRANTY, EXPRESS OR IMPLIED, AND, SPECIFICALLY, WOODS DISCLAIMS ANY IMPLIED WARRANTY OF MERCHANTABILITY OR FITNESS FOR A PARTICULAR PURPOSE. SOME STATES OR PROVINCES DO NOT PERMIT LIMITATIONS OR EXCLUSIONS OF IMPLIED WARRANTIES OR INCIDENTAL OR CONSEQUENTIAL DAMAGES, SO THE LIMITATIONS OR EXCLUSIONS IN THIS WARRANTY MAY NOT APPLY.

This warranty is subject to any existing conditions of supply which may directly affect our ability to obtain materials or manufacture replacement parts.

WOODS reserves the right to make improvements in design or changes in specifications at any time, without incurring any obligations to owners of units previously sold.

No one is authorized to alter, modify, or enlarge this warranty nor the exclusions, limitations and reservations.

**Woods Equipment
Company**

2606 Illinois Route 2 South
Post Office Box 1000
Oregon, Illinois 61061

815-732-2141 tel
815-732-7580 fax

PART NUMBER

58612

WOODS

**WOODS
DUAL
GANNON
ALLOWAY
GILL**

Free Manuals Download Website

<http://myh66.com>

<http://usermanuals.us>

<http://www.somanuals.com>

<http://www.4manuals.cc>

<http://www.manual-lib.com>

<http://www.404manual.com>

<http://www.luxmanual.com>

<http://aubethermostatmanual.com>

Golf course search by state

<http://golfingnear.com>

Email search by domain

<http://emailbydomain.com>

Auto manuals search

<http://auto.somanuals.com>

TV manuals search

<http://tv.somanuals.com>