

MODEL W1802
2 QT. PROFESSIONAL
SPRAY GUN SET



OWNER'S MANUAL

Phone: (360) 734-3482 · Online Technical Support: tech-support@shopfox.biz

COPYRIGHT © JUNE, 2007 BY WOODSTOCK INTERNATIONAL, INC.
WARNING: NO PORTION OF THIS MANUAL MAY BE REPRODUCED IN ANY SHAPE OR FORM WITHOUT
THE WRITTEN APPROVAL OF WOODSTOCK INTERNATIONAL, INC.

#9621JM Printed in CHINA

WARNING!

This manual provides critical safety instructions on the proper setup, operation, maintenance and service of this machine/equipment.

Failure to read, understand and follow the instructions given in this manual may result in serious personal injury, including amputation, electrocution or death.

The owner of this machine/equipment is solely responsible for its safe use. This responsibility includes but is not limited to proper installation in a safe environment, personnel training and usage authorization, proper inspection and maintenance, manual availability and comprehension, application of safety devices, blade/cutter integrity, and the usage of personal protective equipment.

The manufacturer will not be held liable for injury or property damage from negligence, improper training, machine modifications or misuse.

WARNING!

Some dust created by power sanding, sawing, grinding, drilling, and other construction activities contains chemicals known to the State of California to cause cancer, birth defects or other reproductive harm. Some examples of these chemicals are:

- Lead from lead-based paints.
- Crystalline silica from bricks, cement and other masonry products.
- Arsenic and chromium from chemically-treated lumber.

Your risk from these exposures varies, depending on how often you do this type of work. To reduce your exposure to these chemicals: Work in a well ventilated area, and work with approved safety equipment, such as those dust masks that are specially designed to filter out microscopic particles.

SAFETY

WARNING

For Your Own Safety Read Instruction Manual Before Operating This Equipment

The purpose of safety symbols is to attract your attention to possible hazardous conditions. This manual uses a series of symbols and signal words which are intended to convey the level of importance of the safety messages. The progression of symbols is described below. Remember that safety messages by themselves do not eliminate danger and are not a substitute for proper accident prevention measures.



Indicates an imminently hazardous situation which, if not avoided, **WILL** result in death or serious injury.



Indicates a potentially hazardous situation which, if not avoided, **COULD** result in death or serious injury.



Indicates a potentially hazardous situation which, if not avoided, **MAY** result in minor or moderate injury. It may also be used to alert against unsafe practices.

NOTICE

This symbol is used to alert the user to useful information about proper operation of the equipment.

WARNING

Safety Instructions for Pneumatic Tools

1. **KEEP ALL SAFETY DEVICES IN PLACE** and in working order.
2. **REMOVE ADJUSTING KEYS AND WRENCHES.** Form habit of checking to see that keys and adjusting wrenches are removed from tool before operation.
3. **KEEP WORK AREA CLEAN.** Cluttered areas and benches invite accidents.
4. **DO NOT USE IN DANGEROUS ENVIRONMENT.** Do not use pneumatic tools in damp or wet locations, or where any flammable or noxious fumes may exist. Keep work area well lighted.
5. **KEEP CHILDREN AND VISITORS AWAY.** All children and visitors should be kept at a safe distance from work area.
6. **MAKE WORKSHOP CHILD PROOF** by locking your shop and shutting off air valves.
7. **DO NOT FORCE TOOL.** It will do the job better and safer at the rate for which it was designed.
8. **USE THE RIGHT TOOL.** Do not force tool or attachment to do a job for which it was not designed.
9. **DO NOT USE UNDER THE INFLUENCE OF DRUGS OR ALCOHOL.**

WARNING

Safety Instructions for Pneumatic Tools

10. **USE PROPER AIR HOSE** for the tool. Make sure your air hose is in good condition and is long enough to reach your work without stretching.
11. **WEAR PROPER APPAREL.** Do not wear loose clothing, gloves, neckties, rings, bracelets, or other jewelry which may get caught in moving parts. Non-slip footwear is recommended. Wear a protective hair covering to contain long hair.
12. **ALWAYS USE SAFETY GLASSES.** Also use a face or dust mask if cutting operation is dusty. Everyday eyeglasses only have impact resistant lenses, they are NOT safety glasses.
13. **WEAR APPROVED HEARING PROTECTION.** Air escaping from pneumatic tools can exceed safe exposure limits and may cause hearing damage with prolonged exposure.
14. **SECURE WORK.** Use clamps or a vise to hold work when practical. It is safer than using your hand and frees both hands to operate tool.
15. **MAINTAIN TOOLS WITH CARE.** Keep tools lubricated and clean for best and safest performance. Follow instructions for lubricating and changing accessories.
16. **REDUCE THE RISK OF UNINTENTIONAL FIRING.** Do not carry tool with hand on trigger and always disconnect from air when not in use.
17. **DISCONNECT TOOLS** before servicing, changing accessories, or moving to another location.
18. **DO NOT OVERREACH.** Keep proper footing/balance at all times.
19. **USE THE RECOMMENDED ACCESSORIES.** Consult owner's manual for recommended accessories. The use of improper accessories may cause risk of injury.
20. **CHECK FOR DAMAGED PARTS BEFORE USING.** Check for binding and alignment of parts, broken parts, part mounting, loose bolts, and any other conditions that may affect machine operation. Repair or replace damaged parts.
21. **NEVER LEAVE UNATTENDED TOOL CONNECTED TO AIR.** Disconnect the air hose and do not leave tool until it is relieved of any built up pressure.
22. **NEVER ALLOW UNTRAINED USERS TO USE THIS TOOL WHILE UNSUPERVISED.**
23. **IF YOU ARE UNSURE OF THE INTENDED OPERATION, STOP USING TOOL.** Seek formal training or research books or magazines that specialize in pneumatic tools.
24. **BE AWARE OF HOSE LOCATION WHEN USING PNEUMATIC TOOLS.** Hoses can easily become a tripping hazard when laid across the floor or spread out in a disorganized fashion.

WARNING

Additional Safety Instructions for Spray Guns

- 1. READ THIS MANUAL.** This manual contains proper operating instructions for this spray gun.
- 2. READ MATERIAL LABELS and MATERIAL SAFETY DATA SHEETS (MSDS).** Read and know all the instructions on the packaging label and the MSDS before opening the package. This information could save your life.
- 3. ALWAYS WEAR A NIOSH APPROVED RESPIRATOR WHEN SPRAYING OR WORKING AROUND FINISHING MATERIALS.**
- 4. FIRE EXTINGUISHERS.** Always have a fully charged multi class or class B fire extinguisher in the immediate area.
- 5. FLAMMABLE MATERIAL. NEVER** spray near open flame or where any spark could occur.
- 6. FRESH AIR.** Always provide adequate exhaust to keep area free of built up vapors, NEVER spray in an enclosed space.
- 7. DISCONNECT COMPRESSED AIR.** Always disconnect the spray gun from compressed air before cleaning, changing attachments or when performing maintenance of any kind on this tool.
- 8. PROTECTIVE CLOTHING.** Protect exposed skin from overspray by wearing a protective suit or other approved garment.
- 9. INAPPROPRIATE USE. DO NOT** point or shoot spray gun directly at yourself or another person or animals. Do not attempt to use the spray gun for any other use than it was intended.
- 10. STORAGE.** Thoroughly clean and dry spray gun before storage. Store in an approved cabinet.
- 11. SOLVENTS.** Always store solvents and shop towels soaked in solvent in approved containers.
- 12. EYE PROTECTION.** Wear eye protection whenever spraying or cleaning. Solvents and chemicals can cause serious eye injury, which could lead to blindness.
- 13. OPERATING PRESSURE. DO NOT** exceed the recommended inlet air pressure. Excessive pressure could cause the spray gun to burst or cause other internal equipment damage.
- 14. LOCAL LAWS.** Consult local authorities regarding exhaust and waste disposal requirements.

INTRODUCTION

Woodstock Technical Support

This tool has been specially designed to provide many years of trouble-free service. Close attention to detail, ruggedly built parts and a rigid quality control program assure safe and reliable operation.

Woodstock International, Inc. is committed to customer satisfaction. Our intent with this manual is to include the basic information for safety, setup, operation, maintenance, and service of this product.

We stand behind our tools! In the event that questions arise about your tool, please contact Woodstock International Technical Support at (360) 734-3482 or send e-mail to: tech-support@shopfox.biz. Our knowledgeable staff will help you troubleshoot problems and process warranty claims.

If you need the latest edition of this manual, you can download it from <http://www.shopfox.biz>.

If you have comments about this manual, please contact us at:

Woodstock International, Inc.
Attn: Technical Documentation
Manager
P.O. Box 2309
Bellingham, WA 98227
Email: manuals@woodstockint.com

W1802 Specifications

Type.....	Pressurized Cup
Fluid Tip.....	2.0 mm
Optional Tip Range.....	1.5–2.5mm
Air Consumption.....	6.0 CFM
Inlet Air Pressure.....	2-3 Bar /29–43.5 PSI
Air Hose Inlet.....	1/4" NPT
Fluid Hose Inlet.....	3/8" NPS
Material Capacity.....	2 qt.
Pattern Width.....	180-230 mm

WARNING

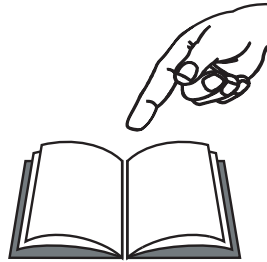

Read the manual before operation. Become familiar with this spray gun and its safety operation before beginning any work. Serious personal injury may result if safety or operational information is not understood or followed.

CAUTION

No list of safety guidelines can be complete. Every shop environment is different. Always consider safety first, as it applies to your individual working conditions. Use this and other tools with caution and respect. Failure to do so could result in serious personal injury, damage to equipment or poor work results.

SETUP

Unpacking

This tool has been carefully packaged for safe transportation. If you notice the spray gun has been damaged during shipping, please contact your authorized Shop Fox dealer immediately.

Inventory

The following is a description of the main components shipped with the Model W1802. Lay the components out to inventory them.

Note: *If you can't find an item on this list, check the mounting location on the tool or examine the packaging materials carefully. Occasionally we pre-install certain components for safer shipping.*

Model W1802 Inventory (Figure 1)	Qty
A. Pressure Cup	1
B. Spray Gun	1
C. Hook/Handle.....	1
D. Air & Fluid Hose.....	1
E. Tool Kit (not shown).....	1
–Service Wrench.....	1
–Cleaning Brush.....	1

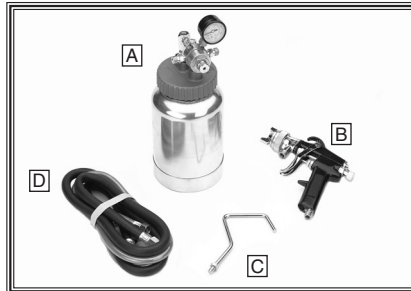

Figure 1. Model W1802 Inventory.

Assembly

1. Attach the hook/handle on the cap with 19mm and 14mm wrenches (see **Figure 2**).

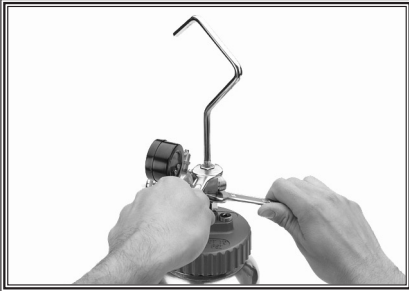

Figure 2. Installing hook/handle.

2. Attach the $\frac{3}{8}$ " fluid hose to the $\frac{3}{8}$ " outlet on the cap (see **Figure 3**).



Figure 3. Installing fluid hose.

3. Attach the other end of the $\frac{3}{8}$ " fluid hose to the $\frac{3}{8}$ " fluid inlet on the spray gun body (see **Figure 4**).



Figure 4. Attaching fluid hose to spray gun.

4. Attach the $\frac{1}{4}$ " air hose to the $\frac{1}{4}$ " air outlet on the cap (see **Figure 5**).

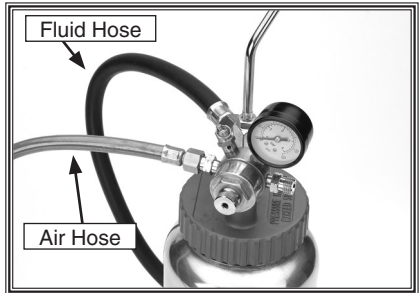

Figure 5. Air hose installed.

5. Attach the other end of the $\frac{1}{4}$ " air hose to the $\frac{1}{4}$ " air inlet on the spray gun body (see **Figure 6**).



Figure 6. Attaching hose to spray gun.

- Attach the compressed air line to the air inlet, as shown in **Figure 7**. For easier operation and maintenance, install a 1/4" NPT quick disconnect set-up on the air line (not included).

Note: For the best results, use a filter that will extract water and oil contaminants and a hose that will be dedicated for spray use only. Do not use a hose that has been used with an in-line oiler or other possible contaminant.

If you need additional help with this assembly, call our Technical Support at: (360) 734-3482.



Figure 7. Compressed air inlet location.

Controls

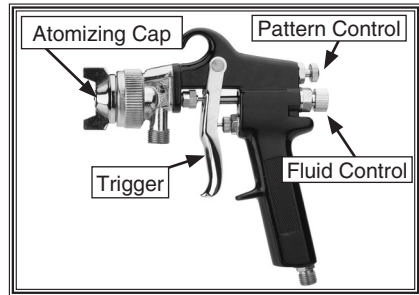

Figure 8. Controls.

- Fluid Control:** Controls the volume of material that travels through the fluid tip.
- Pattern Control:** Adjusts the spray pattern from a round pattern to a wide fan.
- Atomizing Cap:** Controls the spray pattern from vertical to horizontal.
- Trigger:** Two stage trigger. Stage one only releases compressed air for blowing off the work piece. Stage two sprays material.
- Pressure Control Knob:** Controls the fluid pressure inside the spray gun.
- Safety Valve:** Releases unsafe pressure build-up from pressure cup.

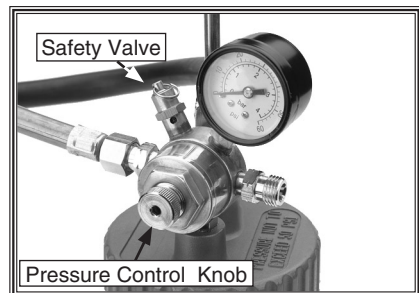

Figure 9. Pressure cup controls.

OPERATIONS

! DANGER



EXPLOSION HAZARD! DO NOT smoke or have any source of flame or spark near spraying. Vapors will explode if ignited.

! WARNING



RESPIRATORY HAZARD! Always use respirator rated for organic vapor and solvent use when using spray equipment. Failure to protect your lungs can lead to respiratory illness and nervous system damage.

! WARNING



TOXIC FUMES! Always use an approved spray booth or well ventilated area when spraying. **NEVER** spray in a confined space where toxic fumes and flammable vapors can accumulate to deadly levels.

Spraying

The Model W1802 spray system is designed to spray medium to high viscosity liquids. It is ideal for painting large areas such as trucks, busses, and vans.

To use your spray system:

1. Read and follow the material manufacturer's instructions for spraying, mixing, safety, disposal, and any other instruction on the label or Material Safety Data Sheet (MSDS).
2. After mixing, filter the material through a strainer while filling the pressure cup. (Strainers are available from your paint supplier.)
3. Fill the pressure cup $\frac{3}{4}$ full or less. **DO NOT OVERFILL.** Overfilling will cause pressurization problems and contribute to leaks and spills.
4. Tighten the cap securely on the pressure cup and ensure all other fittings are secure to avoid air leaks or material spills.
5. Set the inlet air pressure (the air coming to the pressure cup) between 29 and 43.5 PSI or to the material manufacturer's recommendations. **DO NOT** exceed 50 PSI for any reason.

Note: Periodically pull the ring on the safety valve to ensure it moves freely. Do not use the pressure cup if the safety valve is not working!

6. Set the pressure control knob to regulate the fluid pressure to the gun. Follow material manufacturer's recommendations for this setting.
7. Adjust the atomizing cap to vertical or horizontal. See **Atomizing Cap and Fan Adjustments** on **Page 10** for further explanation.

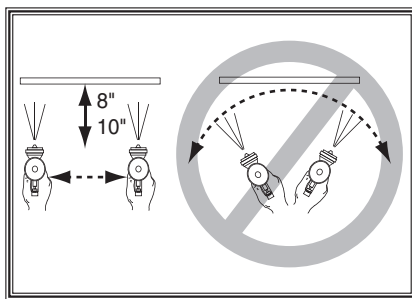

Figure 10. Spray technique.

8. Trial and error are necessary to achieve the results you want along with a fair amount of practice. Test your material flow and spray pattern on a piece of cardboard or some scrap of material similar to your project.
9. Adjust the fluid control knob to start with a low volume of material and keep the atomization as low as possible. You will need to use a combination of fluid control, inlet air pressure, air flow control and stroke speed to achieve the results you want. Spray so the material wets out nicely without running or sagging.
10. Use the pattern control knob to adjust the spray fan to your desired pattern.

12. Begin spraying 2-3 inches before the work and continue to the end of the work. Continue the motion for a few inches past the work until you are ready for the return stroke.

11. Keep the gun tip perpendicular, parallel, and 8-10" from the work at all times when spraying, as shown in **Figure 10**. Do not allow your wrist to bend. This will cause the gun to arc across the surface and distribute the material unevenly, possibly creating sags and dry spots.

13. Maintain an even speed when spraying.

14. Overlap each stroke by 50%. This will ensure even coverage, as shown in **Figure 11**. Less than 50%, as shown in the figure to the right, may lead to missed spots or streaky results.

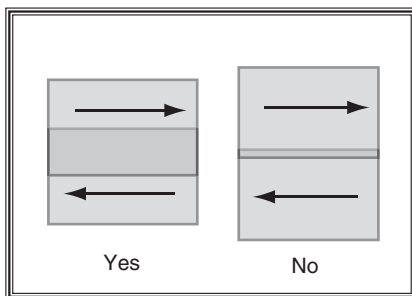

Figure 11. Overlap technique.

15. Spray stroke should have even consistency and parallel edges. If it doesn't, refer to **Troubleshooting** on **Page 14**.

Atomizing Cap and Fan Adjustments

The atomizing cap needs to be adjusted for horizontal or vertical spraying patterns. Spraying in the wrong direction may lead to material build up on the atomizing cap horn. Many performance problems are caused by clogged atomizing holes on the atomizing cap horns (see **Cleaning on Page 11**).

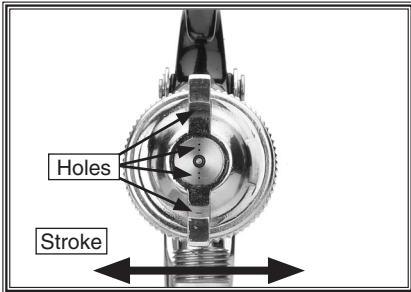

Figure 12. Set up for horizontal stroke direction with vertical fan pattern.

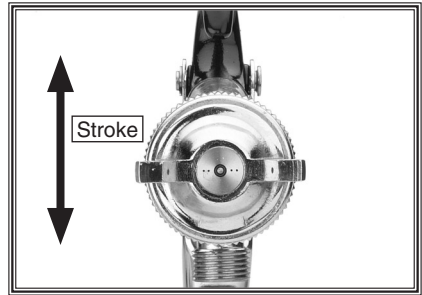

Figure 13. Set up for vertical spray stroke with horizontal fan pattern.

Rotating the pattern adjustment knob in **Figure 14** will give you a range between the two patterns in **Figure 15**.

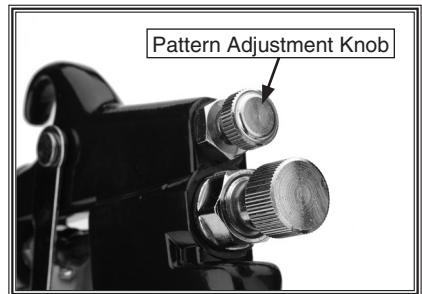

Figure 14. Pattern adjustment knob.

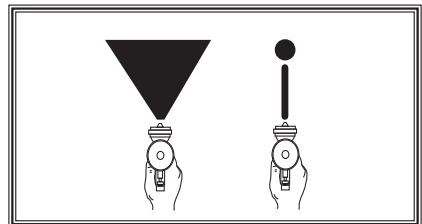

Figure 15. Fan patterns.

CLEANING & LUBRICATION

Cleaning

Proper cleaning is the best way to ensure trouble free performance from your spray gun system. If your system is not thoroughly cleaned, damage and poor spraying will result. Problems caused by improper cleaning will not be covered by the warranty. Clean the spray gun, hose and pressure cup immediately after each use.

To clean your spray system:

1. Depressurize the cup by disconnecting from the compressed air, and bleed the system by loosening (DO NOT REMOVE) the pressure relief valve until "zero" pressure is recorded on the pressure cup gauge (see Figure 16).



Figure 16. Pressure relief valve.

!WARNING

EXPLOSION HAZARD! Do not unscrew pressure cup lid while under pressure! Exploding paint material and solvents could cause serious injury!

!WARNING

HEALTH & CONTAMINATION HAZARD! Dispose of paint waste in a responsible manner! Follow manufacturer's recommendations and local laws regarding disposal. Failure to comply will result in contamination and possibly large fines and penalties.

2. Unscrew the cap and empty the pressure cup contents into an approved receptacle.

!WARNING

EXPLOSION HAZARD! Chlorinated Solvents like 1,1,1-Trichloroethane and Methylene Chloride (methyl chloride) can chemically react with aluminum and may explode. Many parts in spray guns and pressure cups are made of aluminum. Read your solvent label carefully before using solvent.

3. Clean pressure cup with solvent.
4. Add clean solvent to pressure cup, replace the lid and repressurize.
5. Spray the gun until the fluid sprays clear to clean the fluid hose.

Note: Check local laws regarding this practice. If you are spraying on a regular basis, spraying solvents into the air may be illegal. A closed system cleaner may be required.

6. Depressurize the system as explained in **Step 1**.
7. Disassemble the gun by disconnecting the hoses, unscrewing the fluid control knob, and removing the spring and needle.
8. Unscrew the atomizing cap with your fingers and the fluid tip with the service wrench. The fully disassembled gun should look like **Figure 17**.
10. Use the cleaning brush with solvent to clean the inner orifice and other hard to reach areas on the outside of the spray gun body and pressure cup cap.
11. Wipe the rest of the gun body and pressure cup cap with a lint free shop towel and dry.
12. Hang the hose to dry and dry the pressure cup with a lint free shop towel.

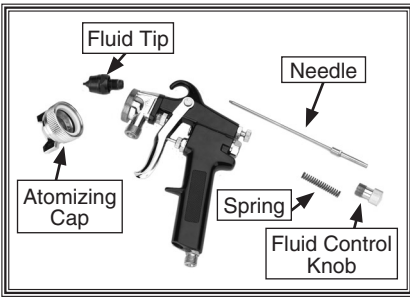

Figure 17. Disassembly for cleaning.

9. Rinse these parts thoroughly in solvent, then dry with compressed air or let air dry.

Note: *If the small holes in the atomizing cap become blocked, soak in clean solvent. If the blockage still exists, clear the blockage with a small needle, taking great care not to enlarge or damage the hole. Damage to the hole will create a disrupted spray pattern.*

NOTICE

DO NOT soak the spray gun body in solvent. Prolonged exposure to solvent will rapidly deteriorate the spray gun washers and seals. Ignoring this notice will void your warranty.

NOTICE

DO NOT soak the pressure cup cap in solvent. Soaking in solvent will damage safety valve and regulator parts. Ignoring this notice will void your warranty.

Lubrication

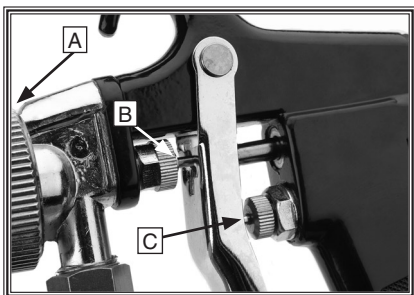

Figure 18. Lubrication points.

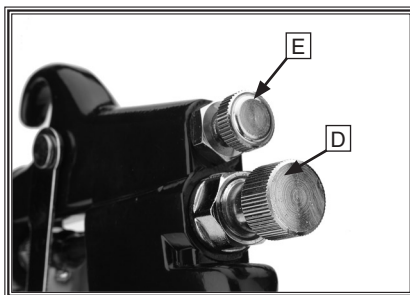

Figure 19. Control knob lubrication.

Lubricate the following areas in **Figures 18-20** with a non-silicon spray gun lubricant after each cleaning.

- A. Atomizing Cap Threads
- B. Air Valve Packing
- C. Trigger Pin
- D. Fluid Control Knob
- E. Pattern Control Knob
- F. Pressure Control Knob

Allow the lubricant to coat threads, and run into gun body to lubricate all moving parts and seals.

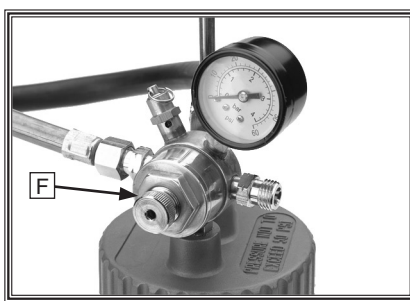







Figure 20. Pressure control threads.

Troubleshooting

Symptom	Possible Cause	Possible Solution
Fluttering or Spitting spray. 	<ol style="list-style-type: none"> 1. Dry or worn fluid tip seat permits air to seep into fluid passage. 2. Material level too low. 3. Fluid tip or strainer obstructed. 4. Dry needle packing. 	<ol style="list-style-type: none"> 1. Tighten fluid tip or replace seat with new one. 2. Add material. 3. Clean 4. Lubricate needle.
Uneven top or bottom pattern. 	<ol style="list-style-type: none"> 1. Atomizing cap holes are obstructed. 2. Build-up on top or bottom of fluid tip. 3. Build-up on atomizing cap is on needle seat. 	<ol style="list-style-type: none"> 1. Clear holes. 2. Clean. 3. Clean.
Right or left arc pattern. 	<ol style="list-style-type: none"> 1. Left or right side horn holes are plugged. 2. Build-up on left or right side of fluid tip. 3. Build-up of material inside atomizing cap. 	<ol style="list-style-type: none"> 1. Clear holes. 2. Clean. 3. Clean.
Heavy deposit of material in center. 	<ol style="list-style-type: none"> 1. The material flow exceeds the atomizing cap capacity. 2. Inlet air pressure is too low. 3. Material is too thick. 	<ol style="list-style-type: none"> 1. Lower fluid flow. 2. Increase inlet air pressure. 3. Thin material.
Narrow center pattern. 	<ol style="list-style-type: none"> 1. Volume control turned in too far. 2. Inlet air pressure too high. 3. Fluid pressure is too low. 4. Material is too thin. 	<ol style="list-style-type: none"> 1. Increase volume. 2. Reduce inlet air pressure. 3. Increase fluid pressure. 4. Adjust material.
No spray output.	<ol style="list-style-type: none"> 1. No pressure at gun. 2. Fluid passages dirty. 3. Fluid control closed. 4. Out of paint. 	<ol style="list-style-type: none"> 1. Check air supply. 2. Clean gun, remove any obstructions. 3. Open. 4. Refill.

Symptom	Possible Cause	Possible Solution
Excessive over-spray.	<ol style="list-style-type: none"> 1. Fluid pressure too high. 2. Gun is too far from surface. 3. Spraying too fast. 	<ol style="list-style-type: none"> 1. Reduce fluid pressure. 2. Keep gun at recommended distance. 3. Slow down and maintain consistent, even parallel stroke.
Unable to control spray fan.	<ol style="list-style-type: none"> 1. Pattern adjustment screw is not seating properly. 2. Atomizing cap is loose. 	<ol style="list-style-type: none"> 1. Clean or replace. 2. Tighten atomizing cap.
Runs and sags.	<ol style="list-style-type: none"> 1. Damaged seal. 	<ol style="list-style-type: none"> 1. Replace damaged seals.
Material leaks from cup.	<ol style="list-style-type: none"> 1. Cap not secure. 2. Cup not tight on gun body. 3. Leaking from cap vent hole. 	<ol style="list-style-type: none"> 1. Tighten. 2. Tighten. 3. Hold gun upright do not tilt.
Material leaks from gun.	<ol style="list-style-type: none"> 1. Fluid tip loose. 2. Dry or damaged seals. 3. Excessive pressure. 	<ol style="list-style-type: none"> 1. Tighten. 2. Replace seals. 3. Reduce pressure.
Thick dimpled finish aka "Orange Peel."	<ol style="list-style-type: none"> 1. Holding gun too close to surface. 2. Inlet air pressure too low. 3. Material not properly mixed. 4. Surface is dirty or oily. 	<ol style="list-style-type: none"> 1. Spray at recommended distance. 2. Check inlet air pressure. 3. Follow manufacturer's instructions. 4. More surface prep is required.
Dry Spray.	<ol style="list-style-type: none"> 1. Inlet air pressure too high. 2. Gun too far from surface. 3. Gun stroke too fast. 	<ol style="list-style-type: none"> 1. Lower inlet air pressure. 2. Keep gun at recommended distance. 3. Slow down and maintain consistent even parallel stroke.
Gun leaks from fluid tip.	<ol style="list-style-type: none"> 1. Debris will not let the needle seat with the fluid tip. 	<ol style="list-style-type: none"> 1. Clean or replace both.
Contaminated paint.	<ol style="list-style-type: none"> 1. Water or oil in the air line. 	<ol style="list-style-type: none"> 1. Install an in-line air filter. 2. Replace air line.

W1802 PARTS BREAKDOWN

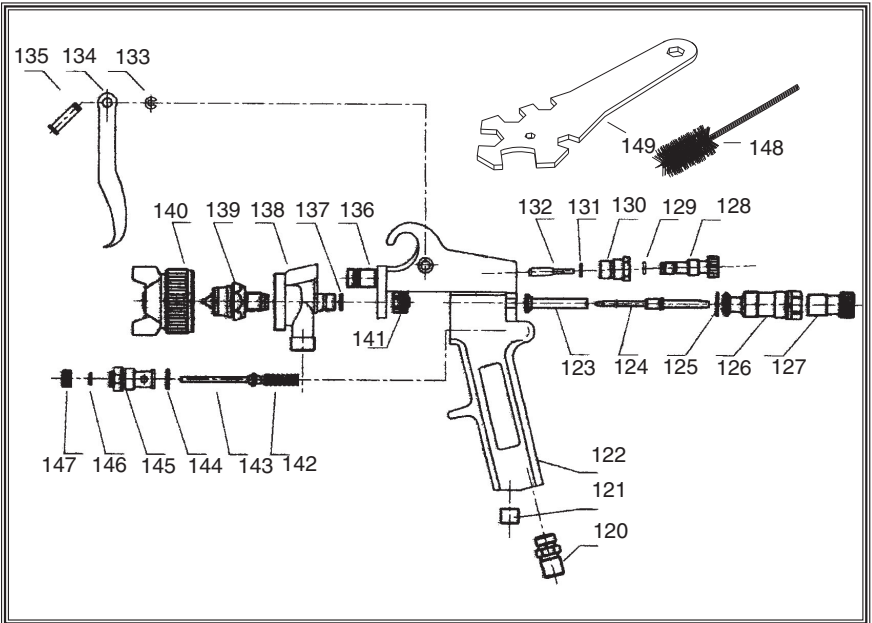
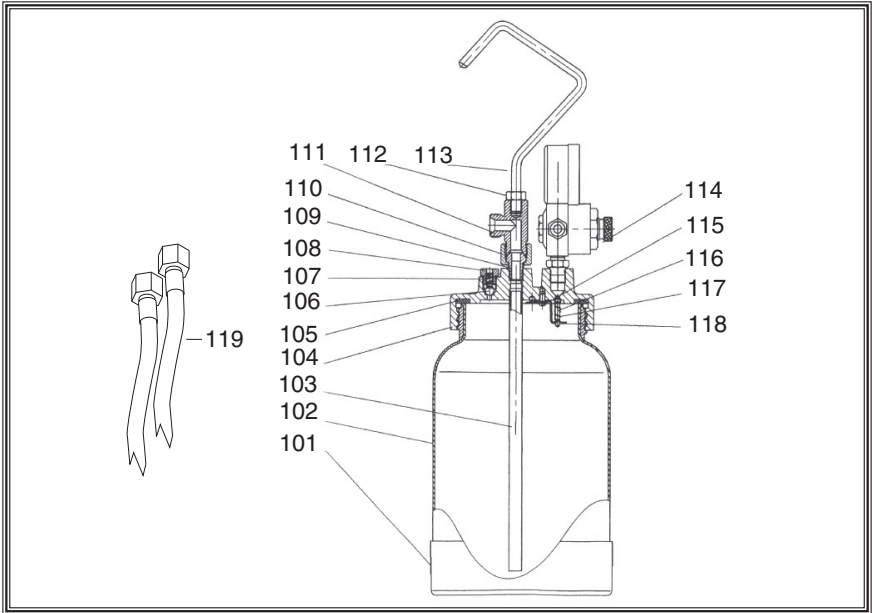

W1802 PARTS LIST

REF PART #	DESCRIPTION
101	X1802101 POT BOTTOM
102	X1802102 CUP
103	X1802103 FLUID TUBE
104	X1802104 COVER
105	X1802105 RUBBER WASHER
106	X1802106 LATEX JAM
107	X1802107 COMPRESSION SPRING
108	X1802108 SPRING RELIEF VALVE
109	X1802109 PAINT INLET PLUG
110	X1802110 CENTERPOST
111	X1802111 FLUID OUTLET
112	X1802112 SPECIAL NUT
113	X1802113 HANDLE
114	X1802114 REGULATOR ASSEMBLY
115	XPS17M PHLP HD SCR M4-.7 X 6
116	X1802116 CHECK VALVE
117	X1802117 COMPRESSION SPRING
118	X1802118 SPECIAL WASHER
119	X1802119 COMBO HOSE
120	X1802120 AIR INLET PLUG
121	X1802121 BLOCK
122	X1802122 GUN BODY
123	X1802123 DIRECTION PIPE
124	X1802124 FLUID ADJ. NEEDLE
125	X1802125 SPECIAL WASHER

REF PART #	DESCRIPTION
126	X1802126 FLUID CONTROL SCREW
127	X1802127 FLUID ADJ. SCREW
128	X1802128 PATTERN ADJ. SCREW
129	X1802129 O-RING 2.5 X 2.1
130	X1802130 PATTERN ADJ. KNOB
131	X1802131 SNAP RETAINER
132	X1802132 PATTERN ADJ. NEEDLE
133	X1802133 TRIGGER PIN
134	X1802134 TRIGGER
135	X1802135 SNAP RETAINER
136	X1802136 CONNECT SCREW
137	X1802137 SPECIAL WASHER
138	X1802138 HEAD
139	X1802139 FLUID NOZZLE
140	X1802140 AIR CAP
141	X1802141 DIRECTION SCREW
142	X1802142 SWITCH SPRING
143	X1802143 SWITCH PIPE
144	X1802144 SEALING WASHER
145	X1802145 SWITCH SEAT
146	X1802146 SPECIAL WASHER
147	X1802147 SPECIAL NUT
148	X1802148 BRUSH
149	X1802149 SERVICE WRENCH

WARRANTY AND RETURNS

Woodstock International, Inc. warrants all Shop Fox machinery to be free of defects from workmanship and materials for a period of two years from the date of original purchase by the original owner. This warranty does not apply to defects due directly or indirectly to misuse, abuse, negligence or accidents, lack of maintenance, or reimbursement of third party expenses incurred.

Woodstock International, Inc. will repair or replace, at its expense and at its option, the Shop Fox machine or machine part which in normal use has proven to be defective, provided that the original owner returns the product prepaid to a Shop Fox factory service center with proof of their purchase of the product within two years, and provides Woodstock International, Inc. reasonable opportunity to verify the alleged defect through inspection. If it is determined there is no defect, or that the defect resulted from causes not within the scope of Woodstock International Inc.'s warranty, then the original owner must bear the cost of storing and returning the product.

This is Woodstock International, Inc.'s sole written warranty and any and all warranties that may be implied by law, including any merchantability or fitness, for any particular purpose, are hereby limited to the duration of this written warranty. We do not warrant that Shop Fox machinery complies with the provisions of any law or acts. In no event shall Woodstock International, Inc.'s liability under this warranty exceed the purchase price paid for the product, and any legal actions brought against Woodstock International, Inc. shall be tried in the State of Washington, County of Whatcom. We shall in no event be liable for death, injuries to persons or property or for incidental, contingent, special or consequential damages arising from the use of our products.

Every effort has been made to ensure that all Shop Fox machinery meets high quality and durability standards. We reserve the right to change specifications at any time because of our commitment to continuously improve the quality of our products.

Warranty Registration

Name _____

Street _____

City _____ State _____ Zip _____

Phone # _____ Email _____ Invoice # _____

Model # _____ Serial # _____ Dealer Name _____ Purchase Date _____

The following information is given on a voluntary basis. It will be used for marketing purposes to help us develop better products and services. Of course, all information is strictly confidential.

1. How did you learn about us?

Advertisement Friend Local Store
 Mail Order Catalog Website Other:

2. How long have you been a woodworker/metalworker?

0-2 Years 2-8 Years 8-20 Years 20+ Years

3. How many of your machines or tools are Shop Fox?

0-2 3-5 6-9 10+

4. Do you think your machine represents a good value? Yes No

5. Would you recommend Shop Fox products to a friend? Yes No

6. What is your age group?

20-29 30-39 40-49
 50-59 60-69 70+

7. What is your annual household income?

\$20,000-\$29,000 \$30,000-\$39,000 \$40,000-\$49,000
 \$50,000-\$59,000 \$60,000-\$69,000 \$70,000+

8. Which of the following magazines do you subscribe to?

<input type="checkbox"/> Cabinet Maker	<input type="checkbox"/> Popular Mechanics	<input type="checkbox"/> Today's Homeowner
<input type="checkbox"/> Family Handyman	<input type="checkbox"/> Popular Science	<input type="checkbox"/> Wood
<input type="checkbox"/> Hand Loader	<input type="checkbox"/> Popular Woodworking	<input type="checkbox"/> Wooden Boat
<input type="checkbox"/> Handy	<input type="checkbox"/> Practical Homeowner	<input type="checkbox"/> Woodshop News
<input type="checkbox"/> Home Shop Machinist	<input type="checkbox"/> Precision Shooter	<input type="checkbox"/> Woodsmith
<input type="checkbox"/> Journal of Light Cont.	<input type="checkbox"/> Projects in Metal	<input type="checkbox"/> Woodwork
<input type="checkbox"/> Live Steam	<input type="checkbox"/> RC Modeler	<input type="checkbox"/> Woodworker West
<input type="checkbox"/> Model Airplane News	<input type="checkbox"/> Rifle	<input type="checkbox"/> Woodworker's Journal
<input type="checkbox"/> Modeltec	<input type="checkbox"/> Shop Notes	<input type="checkbox"/> Other:
<input type="checkbox"/> Old House Journal	<input type="checkbox"/> Shotgun News	

9. Comments: _____

CUT ALONG DOTTED LINE

FOLD ALONG DOTTED LINE



WOODSTOCK INTERNATIONAL INC.
P.O. BOX 2309
BELLINGHAM, WA 98227-2309



FOLD ALONG DOTTED LINE

TAPE ALONG EDGES--PLEASE DO NOT STAPLE

Free Manuals Download Website

<http://myh66.com>

<http://usermanuals.us>

<http://www.somanuals.com>

<http://www.4manuals.cc>

<http://www.manual-lib.com>

<http://www.404manual.com>

<http://www.luxmanual.com>

<http://aubethermostatmanual.com>

Golf course search by state

<http://golfingnear.com>

Email search by domain

<http://emailbydomain.com>

Auto manuals search

<http://auto.somanuals.com>

TV manuals search

<http://tv.somanuals.com>