

MODEL W1712

12" Disc & 6" Belt Sander



INSTRUCTION MANUAL

Phone: 1-360-734-3482 • On-Line Technical Support: tech-support@shopfox.biz

COPYRIGHT © August, 2003 BY WOODSTOCK INTERNATIONAL, INC.

**WARNING: NO PORTION OF THIS MANUAL MAY BE REPRODUCED IN ANY SHAPE OR FORM WITHOUT
THE WRITTEN APPROVAL OF WOODSTOCK INTERNATIONAL, INC.**

Printed in Taiwan

WARNING

Some dust created by power sanding, sawing, grinding, drilling, and other construction activities contains chemicals known to the State of California to cause cancer, birth defects or other reproductive harm. Some examples of these chemicals are:

- Lead from lead-based paints.
- Crystalline silica from bricks, cement, and other masonry products.
- Arsenic and chromium from chemically treated lumber.

Your risk from these exposures varies, depending on how often you do this type of work. To reduce your exposure to these chemicals: work in a well ventilated area, and work with approved safety equipment, such those dust masks that are specially designed to filter out microscopic particles.

CONTENTS

INTRODUCTION2

 About Your New Sander2

 Woodstock Service and Support2

 Warranty and Returns3

 Specifications3

SAFETY4

 Standard Safety Instructions4

 Know Your Machine6

 Safety Instructions for Your Sander7

 110V Operation8

 Extension Cords8

 Grounding8

ASSEMBLY9

 Unpacking9

 Inventory9

 Shop Preparation10

 Dust Collection10

 Initial Cleaning10

 Cabinet Assembly11

 Mounting Sander12

 Installing Table13

ADJUSTMENTS14

 Belt Tracking14

 Table Angle Adjustment15

 Disc Table Alignment16

OPERATIONS17

 Test Run17

 Miter Sanding18

 Power Switch18

 Belt/Disc Selection18

 Disc Sanding19

 Flat Sanding19

 Changing Sanding Belt21

 Changing Sanding Disc Paper22

MAINTENANCE23

 General23

 Lubrication23

 Sanding Surfaces23

PARTS24

TROUBLESHOOTING28

USE THE QUICK GUIDE PAGE LABELS TO SEARCH OUT INFORMATION FAST!





INTRODUCTION

About Your New Sander

Your new **SHOP FOX**® Model W1712 12" Disc and 6" Belt Sander is specially designed to provide many years of trouble-free service. Close attention to engineering detail, ruggedly built parts, and a rigid quality control program assure safe and reliable operation.

The Model W1712 features a 1½ HP, 110V motor. It also features a heavy-duty cabinet stand, two tilting precision-ground cast iron tables, and dual dust ports.

For more features and details, refer to the **Specifications** sub-section in this manual.

Woodstock International, Inc. is committed to customer satisfaction in providing this manual. It is our intent to include all the information necessary for safety, ease of assembly, practical use and durability of this product.

If you need the latest edition of this manual, you can download it from <http://www.shopfox.biz>.
If you still have questions after reading the latest manual, or if you have comments please contact us at:

Woodstock International, Inc.
Attn: Technical Support Department
P.O. Box 2309
Bellingham, WA 98227

Woodstock Service and Support

We stand behind our machines! In the event that a defect is found, parts are missing or questions arise about your machine, please contact Woodstock International Service and Support at 1-360-734-3482 or send e-mail to: tech-support@shopfox.biz. Our knowledgeable staff will help you troubleshoot problems, order parts or arrange warranty returns.

Warranty and Returns

Woodstock International, Inc. warrants all **SHOP FOX**[®] machinery to be free of defects from workmanship and materials for a period of 2 years from the date of original purchase by the original owner. This warranty does not apply to defects due directly or indirectly to misuse, abuse, negligence or accidents, lack of maintenance, or to repairs or alterations made or specifically authorized by anyone other than Woodstock International, Inc.

Woodstock International, Inc. will repair or replace, at its expense and at its option, the **SHOP FOX**[®] machine or machine part which in normal use has proven to be defective, provided that the original owner returns the product prepaid to the **SHOP FOX**[®] factory service center or authorized repair facility designated by our Bellingham, WA office, with proof of their purchase of the product within 2 years, and provides Woodstock International, Inc. reasonable opportunity to verify the alleged defect through inspection. If it is determined there is no defect, or that the defect resulted from causes not within the scope of Woodstock International Inc.'s warranty, then the original owner must bear the cost of storing and returning the product.

This is Woodstock International, Inc.'s sole written warranty and any and all warranties that may be implied by law, including any merchantability or fitness, for any particular purpose, are hereby limited to the duration of this written warranty. We do not warrant that **SHOP FOX**[®] machinery complies with the provisions of any law or acts. In no event shall Woodstock International, Inc.'s liability under this warranty exceed the purchase price paid for the product, and any legal actions brought against Woodstock International, Inc. shall be tried in the State of Washington, County of Whatcom. We shall in no event be liable for death, injuries to persons or property or for incidental, contingent, special or consequential damages arising from the use of our products.

Every effort has been made to ensure that all **SHOP FOX**[®] machinery meets high quality and durability standards. We reserve the right to change specifications at any time because of our commitment to continuously improve the quality of our products.

Specifications

Motor Size	1 ¹ / ₂ HP, 110V Single-Phase
Motor Speed.....	1725 RPM
Sanding Belt	6" x 48"
Belt Speed878 FPM
Sanding Disc.....	12"
Disc Speed.....	1725 RPM
Table (Disc)	17 ¹ / ₂ " x 10"
Stand	Cabinet-Style, Powder-Coated Paint
Power Transfer	Direct Drive
Bearings	Sealed & Lubricated Ball Bearings
Switch	ON/OFF Paddle Switch, w/ Safety Lock Key
Shipping Weight	178 lbs.

SAFETY

**READ MANUAL BEFORE OPERATING MACHINE.
FAILURE TO FOLLOW INSTRUCTIONS BELOW WILL
RESULT IN PERSONAL INJURY.**



Indicates an imminently hazardous situation which, if not avoided, **WILL** result in death or serious injury.



Indicates a potentially hazardous situation which, if not avoided, **COULD** result in death or serious injury.



Indicates a potentially hazardous situation which, if not avoided, **MAY** result in minor or moderate injury, **MAY** result in property damage.

NOTICE

This symbol is used to alert the user to useful information about proper operation of the equipment.

Standard Safety Instructions

1. **Thoroughly read the instruction manual before operating your machine.** Learn the applications, limitations and potential hazards of this machine. Keep manual in a safe, convenient place for future reference.
2. **Keep work area clean and well lit.** Clutter and inadequate lighting invite potential hazards.
3. **Ground all tools.** If a machine is equipped with a three-prong plug, it must be plugged into a three-hole grounded electrical receptacle or grounded extension cord. If you are using an adapter to aid in accommodating a two-hole receptacle, screw adapter to a known ground.
4. **Wear eye protection at all times.** Use safety glasses with side shields or safety goggles that meet the appropriate standards of the American National Standards Institute (ANSI).
5. **Avoid dangerous environments. DO NOT** operate this machine in wet or open flame environments. Airborne dust particles could cause an explosion and severe fire hazard.
6. **Ensure all guards are securely in place and in working condition.**
7. **Make sure the machine power switch is in the OFF position** before connecting power to machine.
8. **Keep the work area clean, free of clutter, grease, etc.**
9. **Keep children and visitors away.** Visitors should be kept at a safe distance while operating unit.
10. **Childproof your workshop with padlocks, master switches or by removing starter keys.**
11. **Stop and disconnect the machine when cleaning, adjusting or servicing.**

12. **DO NOT force tool.** The machine will do a safer and better job at the rate for which it was designed.
13. **Use correct tool. DO NOT force machine or attachment to do a job for which it was not designed.**
14. **Wear proper apparel. DO NOT wear loose clothing, neck ties, gloves, jewelry, and secure long hair away from moving parts.**
15. **Remove adjusting keys, rags, and tools.** Before turning the machine on, make it a habit to check that all adjusting keys and wrenches have been removed.
16. **Avoid using an extension cord.** But if you must, examine the extension cord to ensure it is in good condition. Use **TABLE 1** below to determine the correct length and gauge of extension cord needed for your particular needs. The amp rating of the motor can be found on its nameplate. If the motor is dual voltage, be sure to use the amp rating for the voltage you will be using. If you use an extension cord with an undersized gauge or one that is too long, excessive heat will be generated within the circuit, increasing the chance of a fire or damage to the circuit. Always use an extension cord that uses a ground pin and connected ground wire. Immediately replace a damaged extension cord.
17. **Keep proper footing and balance** at all times and lock mobile base from rolling freely before using your machine.
18. **DO NOT leave machine unattended.** Wait until it comes to a complete stop before leaving the area.
19. **Perform machine maintenance and care.** Follow lubrication and accessory attachment instructions in the manual.
20. **Keep machine away from open flame.** Operating machines near pilot lights or open flames creates a high risk if dust is dispersed in the area. Dust particles and an ignition source may cause an explosion. **DO NOT** operate the machine in high-risk areas, including but not limited to, those mentioned above.
21. **If at any time you are experiencing difficulties** performing the intended operation, stop using the machine! Contact our service department or ask a qualified expert how the operation should be performed.
22. **Habits are hard to break.** Develop good habits in your shop and consistent safety practices will become second-nature to you.

TABLE 1.
Extension Cord Requirements

Amp Rating	Length And Gauge		
	25ft	50ft	100ft
0-6	#16	#16	#16
7-10	#16	#16	#14
11-12	#16	#16	#14
13-16	#14	#12	#12
17-20	#12	#12	#10
21-30	#10	#10	No

⚠ WARNING

Operating this equipment creates the potential for flying debris to cause eye injury. Always wear safety glasses or goggles when operating equipment. Everyday glasses or reading glasses only have impact resistant lenses, they are not safety glasses. Be certain the safety glasses you wear meet the appropriate standards of the American National Standards Institute (ANSI).





Know Your Machine

An important part of safety is knowing your machine and its components. Please take the time to learn the items shown below in **Figure 1**. The letters in the picture correspond to the following descriptions in the list.

SAFETY

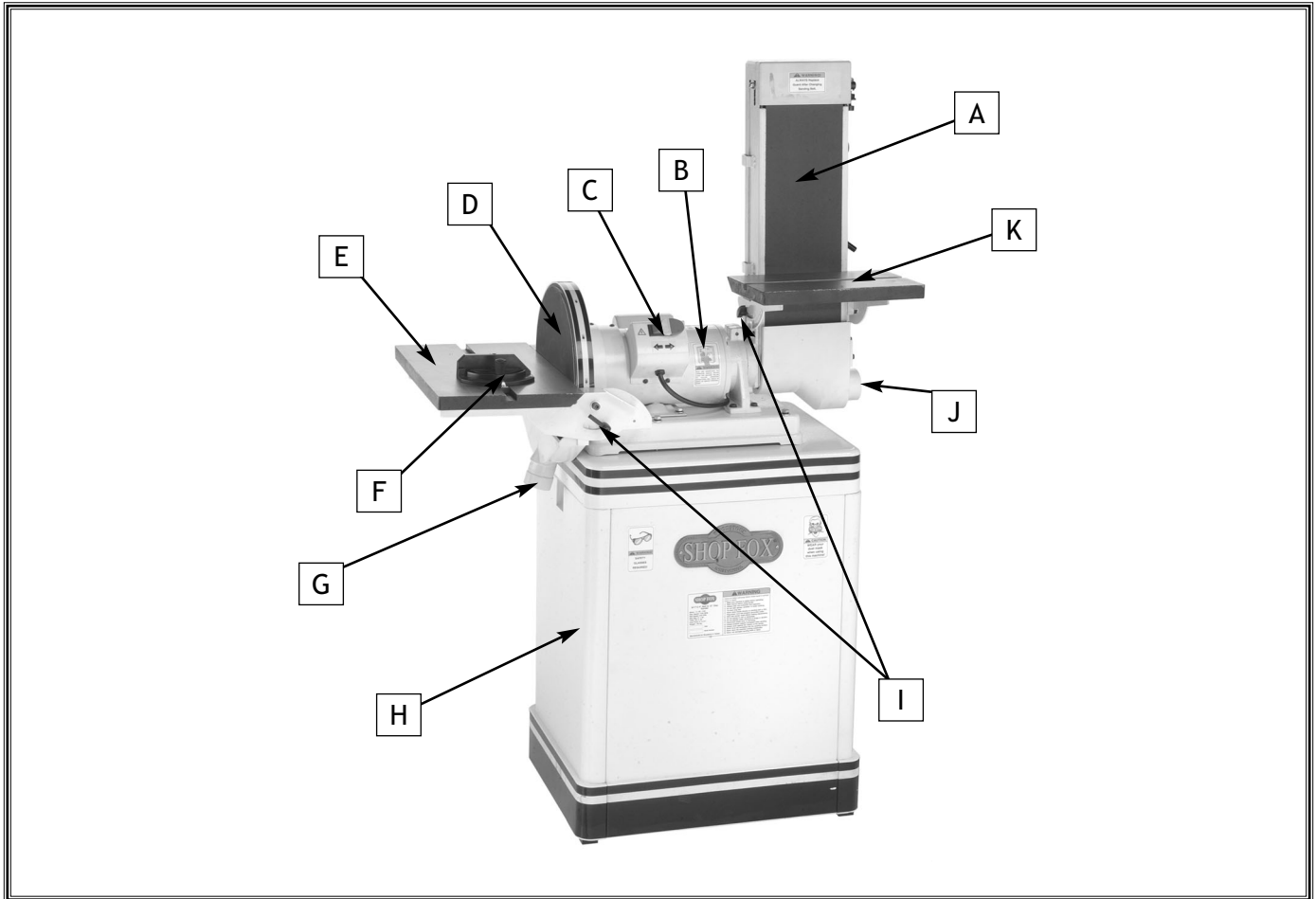



Figure 1. Machine Features.

- A. Sanding Belt
- B. Motor
- C. Paddle Switch with Safety Key
- D. 12" Sanding Disc
- E. Sanding Disc Table
- F. Miter Gauge
- G. Sanding Disc Dust Port
- H. Cabinet Stand
- I. Table Tilting Knobs
- J. Sanding Belt Dust Port
- K. Sanding Belt Table

Safety Instructions for Your Sander



! WARNING
 READ and understand this entire instruction manual before using this machine. Serious personal injury may occur if safety and operational information is not understood and followed. **DO NOT** risk your safety by not reading!

! CAUTION
 USE this and other machinery with caution and respect, and always consider safety first, as it applies to your individual working conditions. Remember, no list of safety guidelines can be complete, and every shop environment is different. Failure to follow guidelines can result in serious personal injury, damage to equipment and/or poor work results.

- **ALWAYS** keep bystanders away when sanding.
- **ALWAYS** secure aprons, clothing, and long hair away from all sander moving parts.
- **ALWAYS** use a respirator along with a dust collection system when sanding. Dust from some wood is toxic, so make sure you research the dangers of the specific species of wood you will sand.
- **ALWAYS** keep your hands away from the sanding belt and disc during operation.
- **ALWAYS** wear eye and hearing protection.
- **ALWAYS** feed the workpiece into the sander using light pressure, so you do not overload the sander. Never force the workpiece into the sander.
- **ALWAYS** shut the sander down, let the belt come to a complete stop, and disconnect power or engage applicable safety-lock devices before you service, adjust, troubleshoot, or leave the machine unattended.
- **ALWAYS** keep this machine in correct adjustment and properly serviced.
- **ALWAYS** replace the sandpaper when it is worn, and only use undamaged sandpaper.
- **ALWAYS** inspect the workpiece for nails, staples, knots, imbedded stones, and other material that could be dislodged and thrown from the machine during sanding operations.
- **NEVER** attempt to clear a jammed workpiece while the sander is running.
- **NEVER** sand if there is any doubt about the stability or integrity of the workpiece.
- **NEVER** sand more than one workpiece at a time.
- **NEVER** sand tapered or pointed stock with the point facing the feed direction.
- **NEVER** leave the machine running unattended.
- **NEVER** operate the sander without an adequate dust collection system in place and running.

110V Operation

The SHOP FOX® Model W1712 1½ HP, 110 volt motor draws approximately 12 amps.

Make sure you use an outlet with a 15 amp circuit breaker or fuse. If other machines may be using the same circuit, make sure the circuit, circuit breaker, or fuse can carry the total load without tripping. If the total amperage load of all machines and the sander exceeds the amperage rating of the circuit breaker or fuse, use a different circuit that can carry the load.

DO NOT modify an existing low-amperage circuit by only replacing the circuit breaker with a breaker rated for a higher amperage. The breaker and the complete circuit must be replaced by a qualified electrician, otherwise the wires can overheat and cause a fire.

Extension Cords

If you must use an extension cord with the Model W1712, please follow these requirements:

- Use a cord rated for Standard Service (Grade S).
- Use a cord that is 100 feet or less.
- Use a least a 16 gauge cord.
- Use a cord with a ground pin.
- Use an undamaged cord only.

Grounding

	<p>⚠ WARNING</p> <p> Serious injury or fire may occur if you plug this machine into a receptacle that is not grounded. Connect this machine to grounded outlets only!</p>
--	--

Ground this machine! The electrical cord supplied with the SHOP FOX® Model W1712 Sander has a three prong plug for grounded outlets. See Figure 2. If your power receptacle does not have a ground pin hole, have the receptacle replaced by a qualified electrician, or have an appropriate adapter installed and grounded properly. NEVER cut the ground pin off so your sander plug fits into a non-grounded receptacle.

<p style="text-align: center;">NOTICE</p> <p>When using an electrical plug adapter, make sure the adapter is grounded.</p>

Remember, an adapter with a grounding wire does not guarantee the sander is grounded. A ground source must always be verified in the electrical circuit within the wall or conduit.

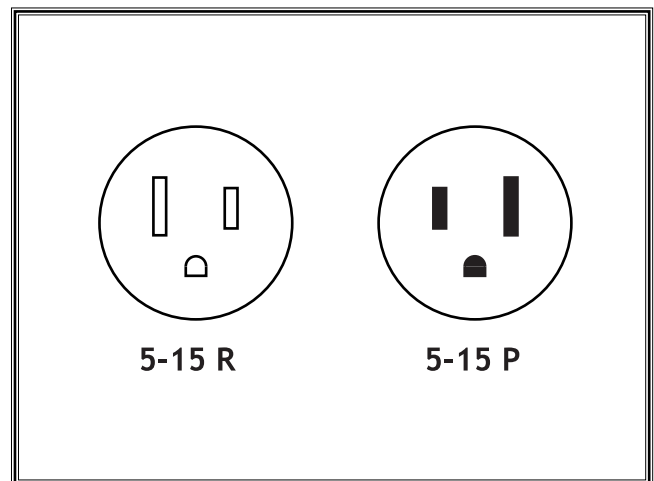

Figure 2. NEMA-style 5-15 plug and receptacle.

SAFETY

ASSEMBLY

Unpacking

The Model W1712 was carefully packed when it left our warehouse. If you receive it damaged or missing any parts, please contact Woodstock International Service and Support at 1-360-734-3482 or send e-mail to: tech-support@shopfox.biz.

Inventory

Layout and inventory the package contents listed below and familiarize yourself with the components to ease assembly.

Item	Qty.
A. Sander Unit	1
B. Cabinet Stand	1
• Side Panel L/R	2
• Front/Rear Panel	2
C. Table Hardware Bag	1
- Cap Screw 5/16"-18 x 3/4"	2
- Lock Nut 5/16"-18	2
- Flat Washer 1/4"	2
- Knob Bolt M6-1 x 15	2
D. 12" Disc Sanding Table	1
E. Belt Sanding Table	1
F. Main Hardware Bag	1
• Cabinet Stand Hardware Bag	1
- Hex Bolt 5/16"-18 x 3/8"	8
- Hex Bolt 5/16"-18 x 1"	2
- Hex Nut 5/16"	8
- Flat Washer 5/16"	18
- Lock Washer 5/16"	10
- 6MM Allen Wrench	1
• Floor Pad Bag	1
- Floor Pads	4
- Phillips Head Screw 3/16"-18 x 5/8"	4
- Flat Washer 5/16"	4
- Hex Nut 5/16"	4
• Accessories Bag	1
- Belt Tension Lever	1
- Screwdriver	1
- Knob Bolt M8-1.25 x 20	1
- Stop Fence	1
G. Miter Gauge Assembly	1

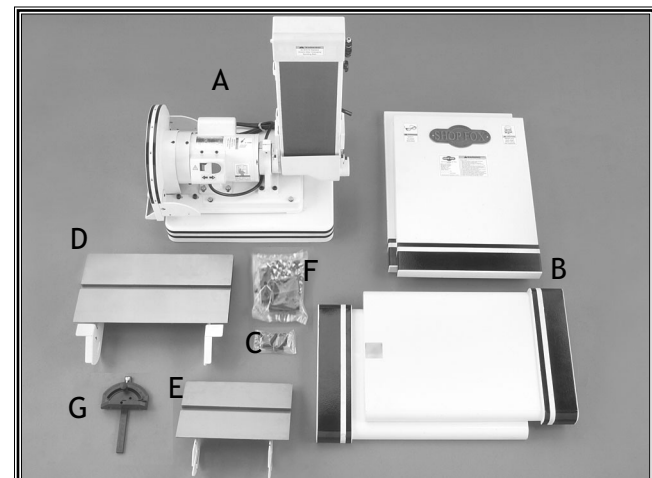
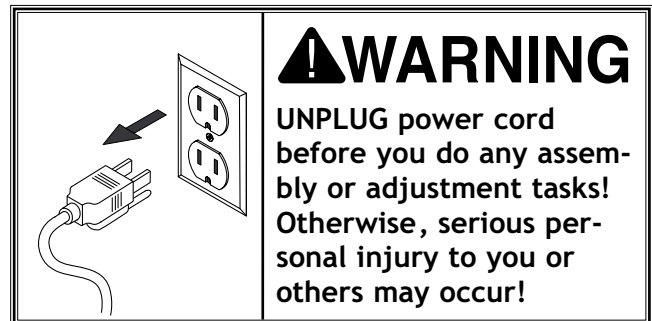
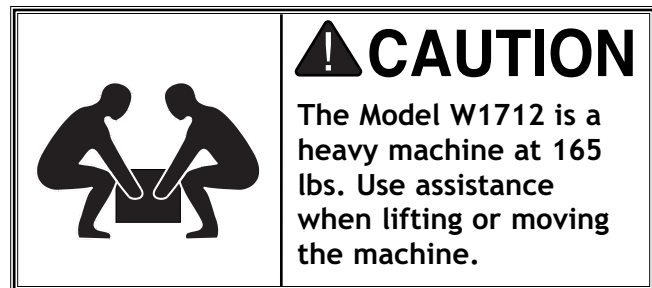
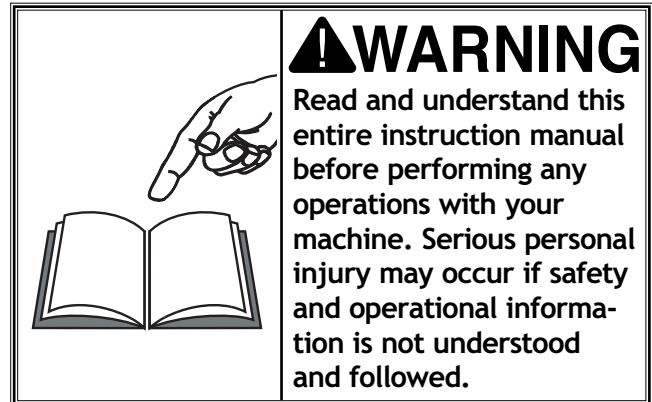

Figure 3. Inventory.

ASSEMBLY

Shop Preparation

	<p>⚠ CAUTION</p> <p>ONLY ALLOW TRAINED PEOPLE in your shop! Make sure shop entrances are locked and machines are correctly turned off with lock-out devices when not in use. Otherwise, injury or death can occur.</p>
---	---

- **Lighting:** Lighting should be bright enough to eliminate shadows and prevent eye strain.
- **Working Clearances:** Consider your current and future shop needs with respect to the safe operation of this machine.
- **Outlets:** Make sure the electrical circuits have the capacity to handle the amperage requirements for your Model W1712. Refer to **page 8** for more information. Electrical outlets should be located near the sander, so power or extension cords are clear of high-traffic areas.

Dust Collection

	<p>⚠ CAUTION</p> <p>Some wood dust may cause allergic reactions or respiratory illness. Use a dust collection system and respirator in your shop to help protect yourself from these long-term hazards.</p>
---	--



For information on the correct dust collection components for sanders, contact your Woodstock International dealer for a copy of the Dust Collection Basics handbook and available accessories.

Initial Cleaning

The exposed and unpainted sander surfaces are coated with a waxy oil to prevent rust during storage and shipment. DO NOT use chlorine based solutions or solvents to remove this waxy oil or you will damage the painted surfaces. Remove the waxy oil with a solvent based degreaser before you use the sander. Always follow all usage and safety instructions of the product that you are using.

	<p>⚠ WARNING</p> <p>DO NOT use flammables such as gas or other petroleum-based solvents to clean your machine. These products have low flash points and present the risk of explosion and severe personal injury!</p>
--	--

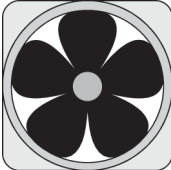
	<p>⚠ WARNING</p> <p>DO NOT smoke while using cleaning solvents. Smoking may cause explosion or risk of fire when exposed to these products!</p>
--	--

	<p>⚠ CAUTION</p> <p>ALWAYS work in a well ventilated area when using solvents with fumes, and keep away from any potential ignition sources (pilot lights). Most solvents used to clean machinery are toxic when inhaled or ingested. Always dispose of waste rags in a sealed container to make sure they do not cause fire or environmental hazards.</p>
	
	

Cabinet Assembly

The Model W1712 mounts onto a heavy-duty formed sheet steel cabinet stand. Use the hardware in the cabinet hardware bag to complete this assembly.

To assemble the cabinet stand, do these steps:

1. Assemble the cabinet panels together as shown in **Figure 4** with the supplied $\frac{5}{16}$ "-18 x $\frac{3}{4}$ " hex bolts, $\frac{5}{16}$ " flat washers, $\frac{5}{16}$ " lock washers and $\frac{5}{16}$ " hex nuts.
2. Attach the remaining side panel.
3. Secure the rubber feet to the bottom corners of the cabinet stand with the floor pad hardware bag as shown in **Figure 5**.

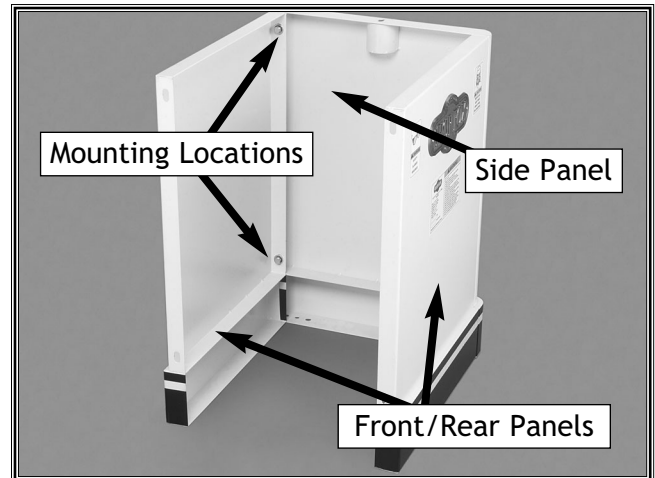



Figure 4. Cabinet assembly.



Figure 5. Rubber feet installed.

Mounting Sander

Mounting the sander to the stand will require the help of an assistant. Secure the sander to the stand using the cabinet stand hardware bag.

	<p>⚠ CAUTION</p> <p>The Model W1712 is a heavy machine at 165 lbs. Use assistance when lifting or moving the machine.</p>
---	--

	<p>⚠ WARNING</p> <p>UNPLUG sander before you do any assembly! Otherwise, serious personal injury to you or others may occur!</p>
--	---



Figure 6. Mounting the sander.

To mount the sander, do these steps:

1. KEEP THE SANDER UNPLUGGED!
2. Place the sander on the stand.
3. Align the holes in the cabinet with the pre-drilled and tapped mounting holes in the sander.
4. Secure the sander to the stand as shown in Figure 6.

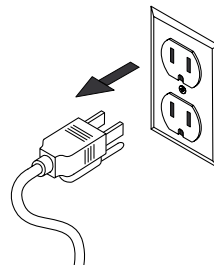
Installing Table

The sanding belt table comes assembled on the W1712, but the sanding disc table needs to be installed on the sander.

To install the sanding disc table, do these steps:

1. **KEEP THE SANDER UNPLUGGED!**
2. Align the sanding table mounting holes with the threaded holes in the bracket.
3. Secure the sanding table, as shown in **Figure 7**, with the cap screws supplied in the table hardware bag.
4. Install the table tilt control knobs (**Figure 8**).

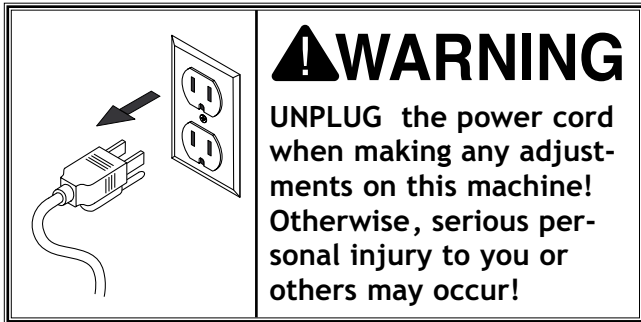

Figure 7. Installing table.



Figure 8. Installed tilting knobs.

ADJUSTMENTS



Belt Tracking

The belt tracking must be adjusted correctly to make the belt ride parallel with the table.

To adjust the belt tracking, do these steps:

1. **UNPLUG THE SANDER!**
2. Make sure all guards are in place and the belt locking lever is in the locked position as shown in **Figure 9**.
3. Loosen the knurled adjustment nut away from the roller pin (**Figure 10**).
4. Check the current belt position and note if it needs to move left or right. **Figure 11** shows a properly tracked belt with $\frac{1}{16}$ " of the roller exposed on each side.
5. Adjust the tension bolt clockwise to make the belt ride to the left, and adjust counter-clockwise to make the belt ride to the right.
6. Plug in the sander.
7. Start the sander and observe the corrected belt tracking.
8. Stop the sander and repeat **steps 1-7** until the desired tracking has been met.
9. Finger tighten the adjustment nut against the roller pin when the belt is riding correctly.



Figure 9. Belt locking lever.

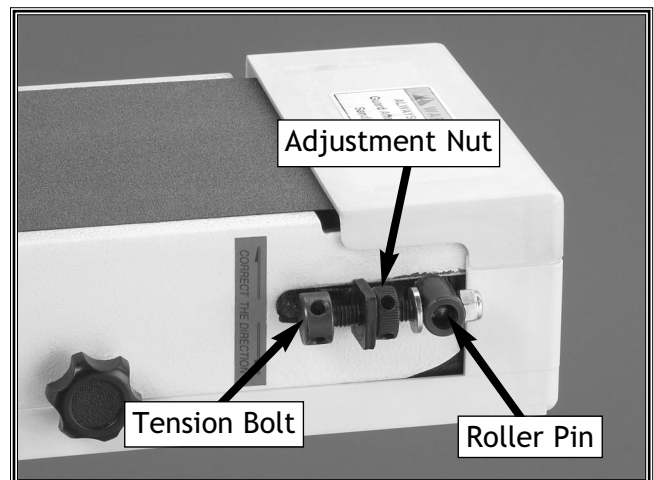

Figure 10. Tracking adjustment system.

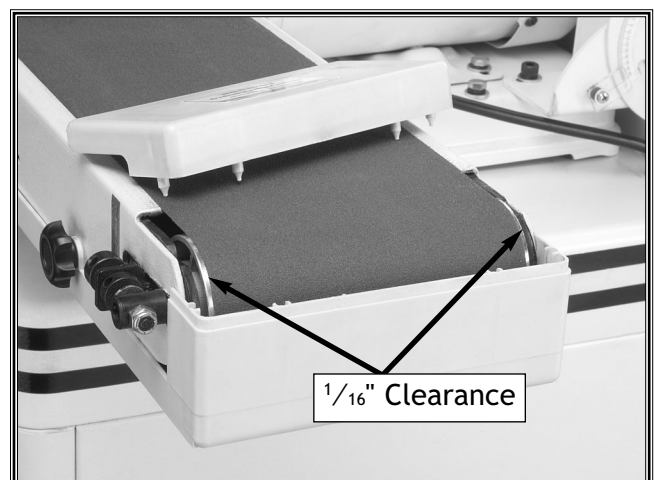

Figure 11. Proper belt tracking (guard removed for clarity).

ADJUSTMENTS

Table Angle Adjustment

The scale pointers on the sander indicate the tilt angle of the sanding tables. The pointers have been set at the factory but throughout the life of your machine, you may need to adjust them.

To adjust the scale pointers, do these steps:

1. **UNPLUG THE SANDER!**
2. Loosen the table tilting lock knob shown in **Figure 12** and rotate the table so it is perpendicular with the edge of the sanding disc.
3. Place a machinist square on the disc sanding table and against the sanding disc to check for squareness (shown in **Figure 13**).
4. Lock the table tilt knob when the table is perpendicular to the disc.
5. Loosen the screw securing the pointer and adjust it so it indicates 90° (**Figure 13**).
6. Repeat **steps 1-5** to adjust the belt sanding table.

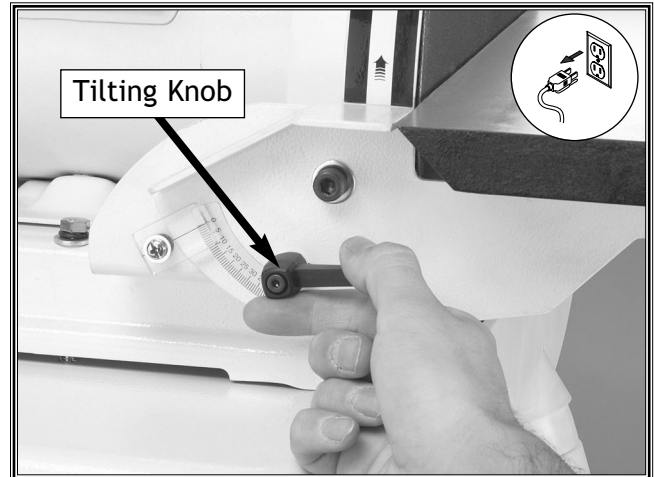
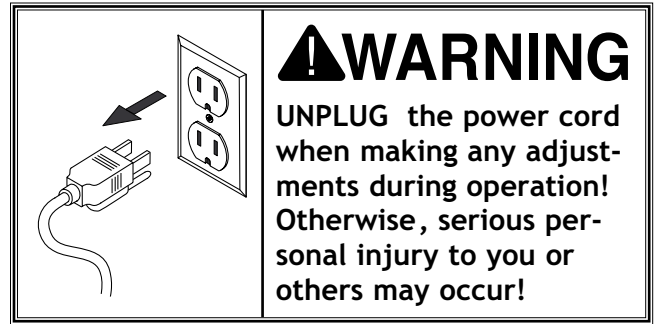

Figure 12. Table tilting knob.

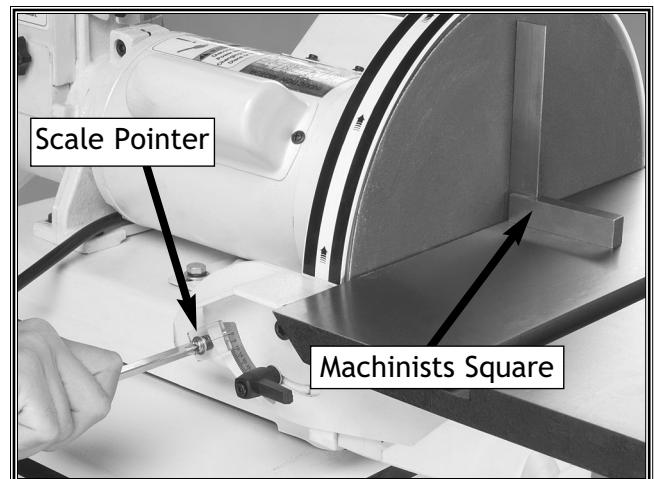

Figure 13. Setting the scale pointer.

Disc Table Alignment

The disc table clearance has been correctly set at the factory, but over the life of your machine adjustments may need to be made.

To adjust the disc table clearance, do these steps:

1. **UNPLUG THE SANDER!**
2. Make sure the disc table is set to 0°.
3. Loosen the four table adjustment bolts (Figure 14).
4. Measure the gap between the table edge and the face of the disc at the left and right end locations.
5. Adjust the clearance at each location to be approximately $\frac{1}{8}$ ".
6. Tighten the adjustment bolts when the proper clearance has been achieved.

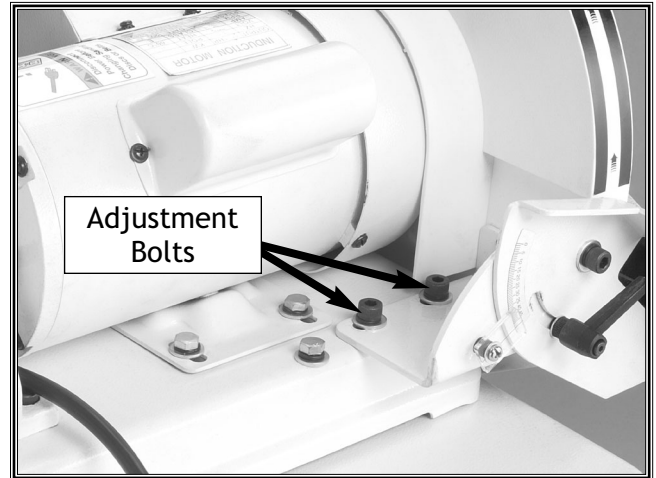

Figure 14. Disc table adjustment bolts (only 2 of 4 shown).

OPERATIONS

Test Run

The purpose of a test run is to identify any unusual noises and vibrations, as well as to confirm that the machine is performing as intended.

To test run the Model W1712, do these steps:

1. Make sure all guards are in place.
2. Make sure that the ON/OFF switch is in the "OFF" position before connecting the machine to power.
3. Pull the power switch up to start the sander. Once the sander is running, listen for any unusual noises. The machine should run smoothly with little or no vibrations.
 - If there are any unusual noises or vibrations, STOP the sander immediately by pushing the paddle switch down.
4. Unplug the sander and investigate the source of the noise or vibration. DO NOT make any adjustments to the sander while it is plugged in. The sander should not be run any further until the problems are corrected.

	<p>⚠ WARNING THIS MACHINE creates sawdust. Always wear safety glasses or a face shield during all sanding operations.</p>
--	---

	<p>⚠ WARNING KEEP loose clothing rolled up and out of the way of machinery and keep hair pulled back.</p>
--	---

	<p>⚠ CAUTION This machine produces sawdust that may cause allergic reactions or respiratory problems. Wear a respirator in addition to using a dust collector.</p>
--	--

Power Switch

The power switch on the SHOP FOX® Model W1712 not only starts and stops the sander, but features a safety lockout key. When the key is removed, as shown in Figure 15, the sander is disabled to prevent accidental start up.

Belt/Disc Selection

The SHOP FOX® Model W1712 accepts 6" x 48" sanding belts and 12" discs. There are a large variety of sanding belts and discs to choose from. We recommend Aluminum Oxide belts and discs for standard sanding purposes. Table 2 shows abrasive types and grit numbers.

As a general rule of thumb, progressively increase the grit number you use without jumping more than 50 grit sizes at one time.

Miter Sanding

The most efficient way to get a perfect miter is to cut the workpiece slightly long and sand it to the desired dimension. Miter sanding can be done easily with the miter gauge:

To perform miter sanding operations:

1. Loosen the knob on the miter gauge and adjust the angle to the desired point. Tighten the knob.
2. Slide the miter gauge into its slot in the table to steady your workpiece at the correct angle. Note—*The miter gauge can be used in either direction in the slot to achieve the proper relation of the workpiece to the disc.*
3. Hold the workpiece and miter gauge firmly as shown in Figure 16.

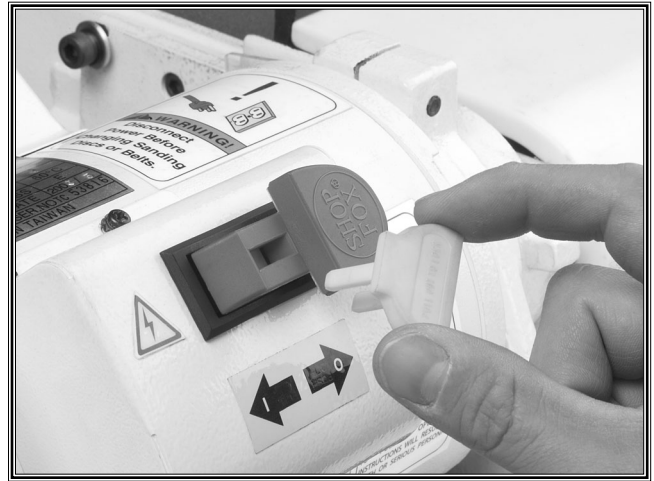

Figure 15. Safety lockout key removed.

Type	Grit
Coarse	60
Medium	80-100
Fine	120-180
Very Fine	220



Figure 16. Miter sanding operation.

Disc Sanding

To start disc sanding operations, do these steps:

1. **UNPLUG THE SANDER!**
2. Set the table tilt angle to the desired position by loosening the table lock knobs. **Figure 17** shows the table at 45°.
3. Plug the sander into the power supply.
4. Start the sander.
5. Hold the workpiece firmly in both hands as shown in **Figure 18**. Note— *Always keep the workpiece on the side of the wheel that is rotating down toward the table. This will keep the workpiece from flying out of your hands from the rotational forces.*



Figure 17. Table tilt set at 45°.

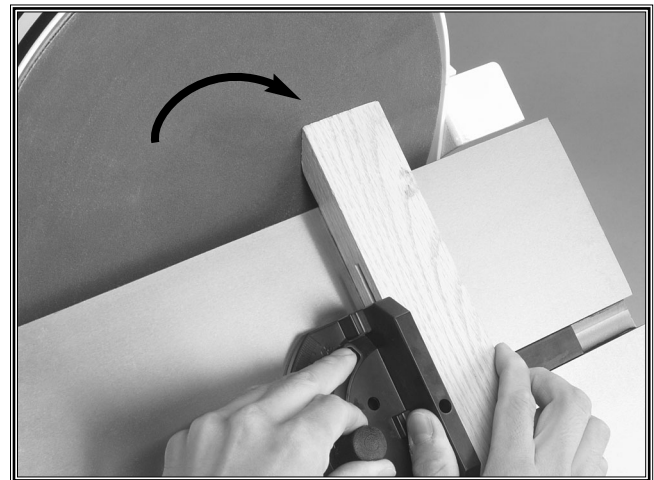

Figure 18. Disc sanding.

Flat Sanding

Flat sanding operations can be performed with the sanding belt in the vertical position or horizontal position.

To start flat sanding operations with the belt vertical, do these steps:

1. **UNPLUG THE SANDER!**
2. Make sure the sanding table is square to the belt.
3. Plug the sander into the power supply.
4. Start the sander.
5. Hold the workpiece firmly as shown in **Figure 19**.



Figure 19. Flat sanding operation.

To start flat sanding operations with the belt horizontal, do these steps:

1. **UNPLUG THE SANDER!**
2. Remove the belt sanding table.
3. Loosen the cap screw shown in **Figure 20** to allow the sanding belt to rotate.
4. Rotate the belt to the horizontal position then tighten the cap screw loosened in **step 3**.
5. Install the work-stop fence (shown in **Figure 21**) to prevent the workpiece from running off the end of the sander.
6. Start the sander.
7. Hold the workpiece firmly and in contact with the work-stop fence as shown in **Figure 22**.

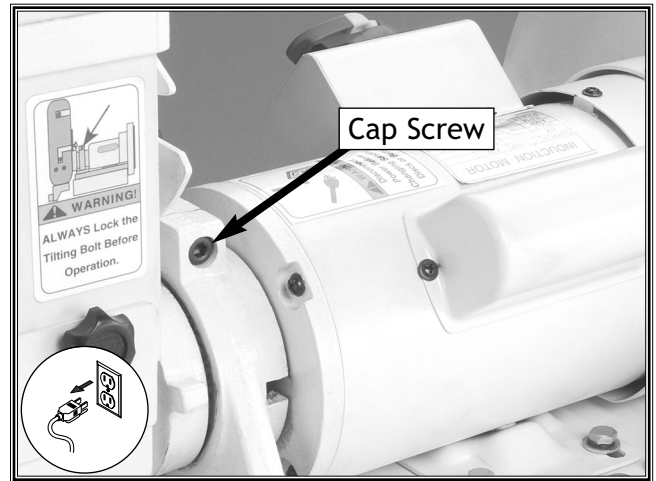

Figure 20. Cap screw location.



Figure 21. Flat sanding operation.

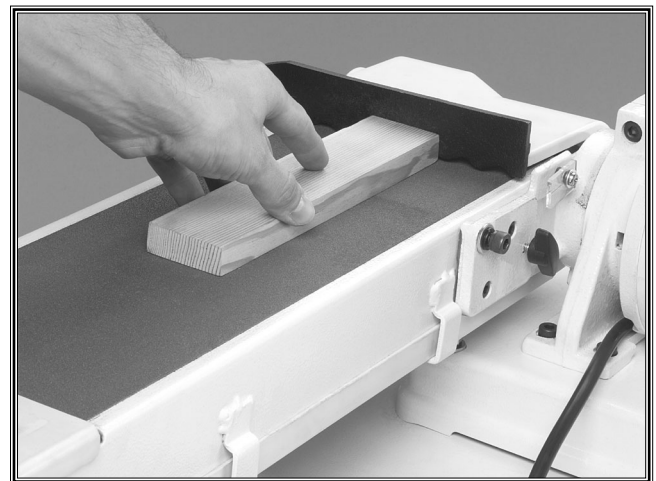

Figure 22. Flat sanding operation.

Changing Sanding Belt

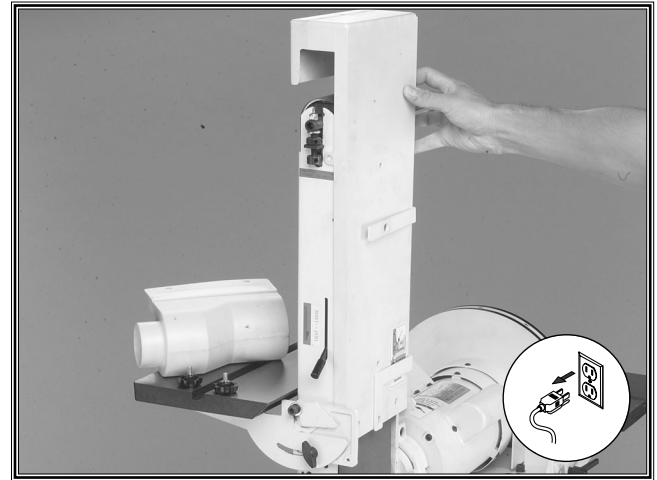
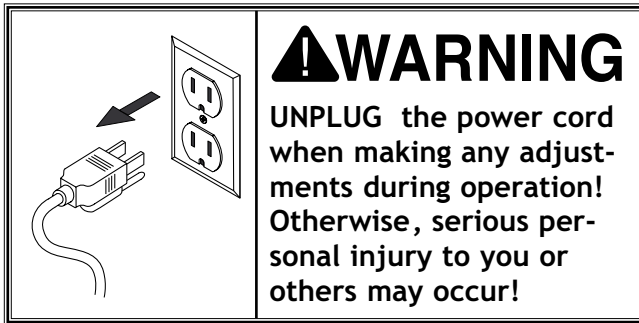

Figure 23. Removing belt guard.

To change the sanding belt, do these steps:

1. **UNPLUG THE SANDER!**
2. Remove all the cover lock knobs from the back of the belt guard and slide the belt guard up and off the sanding belt as shown in Figure 23.
3. Remove the table and mounting bracket from the belt sander (Figure 24).
4. Release the belt tension by moving the belt tension lever to the "unlock" position.
5. Roll the old sanding belt off the right side of the rollers.
6. Install a new belt with the arrows in the proper direction as shown in Figure 25.
7. Re-install the mounting bracket, table and belt guards.

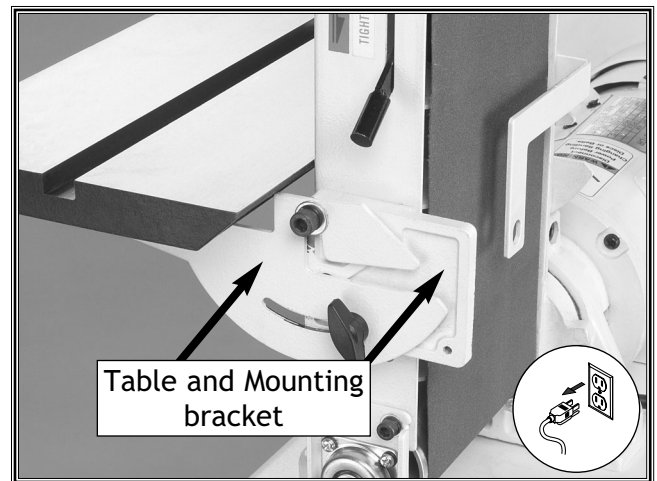

Figure 24. Table and mounting bracket.

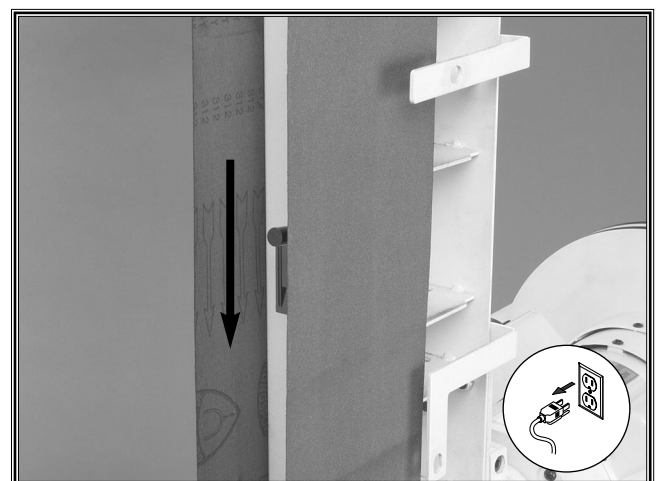

Figure 25. Installing a new sanding belt.

Changing Sanding Disc Paper

The 12" disc sander requires 12" sanding discs with hook and loop backing that can be easily attached to the disc.

To install a new sanding disc on the 12" disc sanding surface:

1. **UNPLUG THE SANDER!**
2. Remove the disc sanding table.
3. Peel the old sanding paper off the sanding disc.
4. Place the new 12" sandpaper on the sanding disc as shown in **Figure 26**.
5. Replace the disc sanding table.

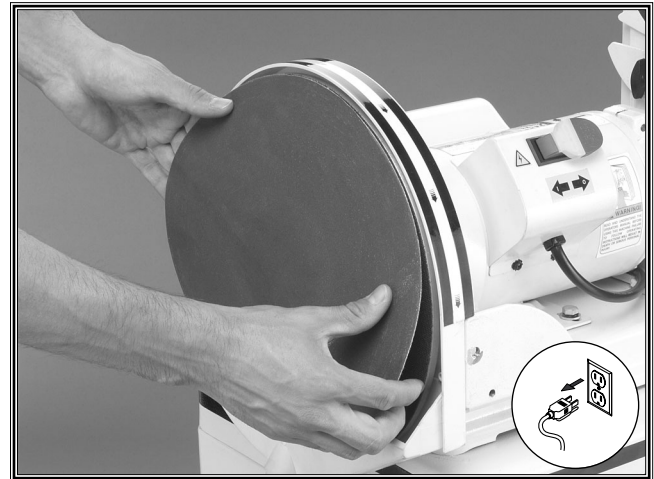
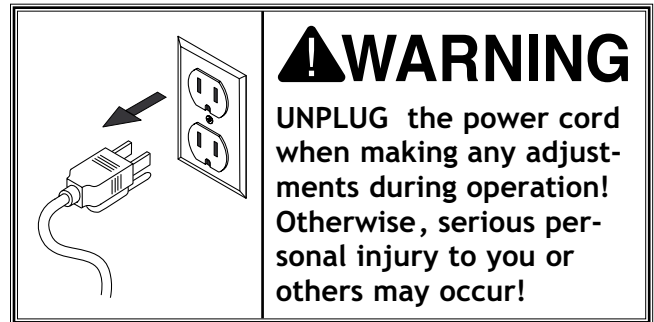

Figure 26. Sanding disc installation.

MAINTENANCE

General

To ensure optimum performance from your sander, make a habit of inspecting it before each use. Check for the following conditions and repair or replace when necessary:

- Loose mounting bolts.
- Worn switch.
- Worn or damaged cords and plugs.
- Any other condition that could hamper the safe operation of this machine.

Table And Base

Tables can be kept rust-free with regular applications of products like SLIPIT®. For long term storage you may want to consider products like Boeshield T-9™.

Sanding Surfaces

Regularly clean your sanding belt and disc as sawdust builds up in the grit. Clean the sanding belts and discs with PRO STICK® belt cleaners as shown in **Figure 27**. Cleaning built-up sawdust will prolong the life of your sanding belts and discs.

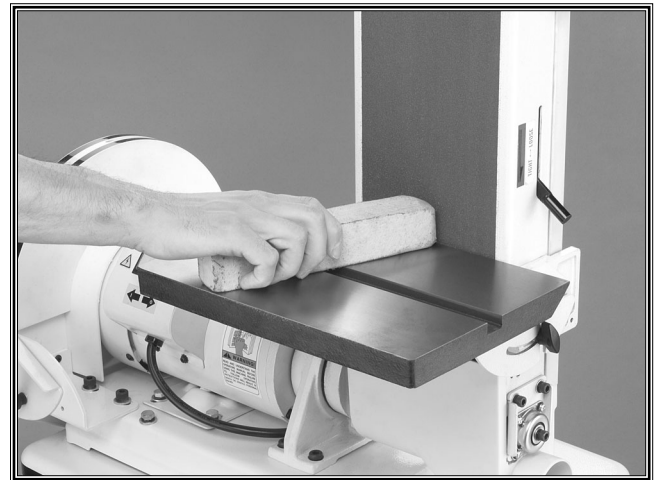
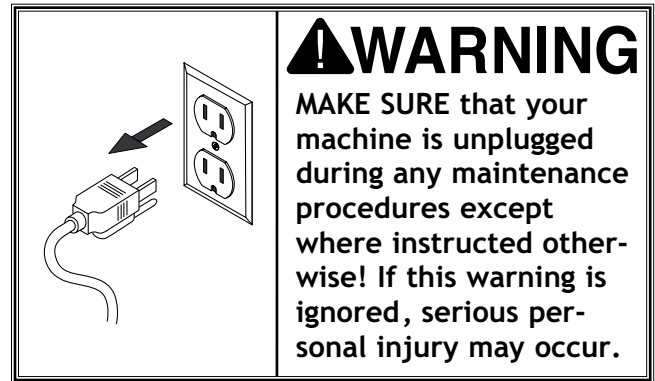
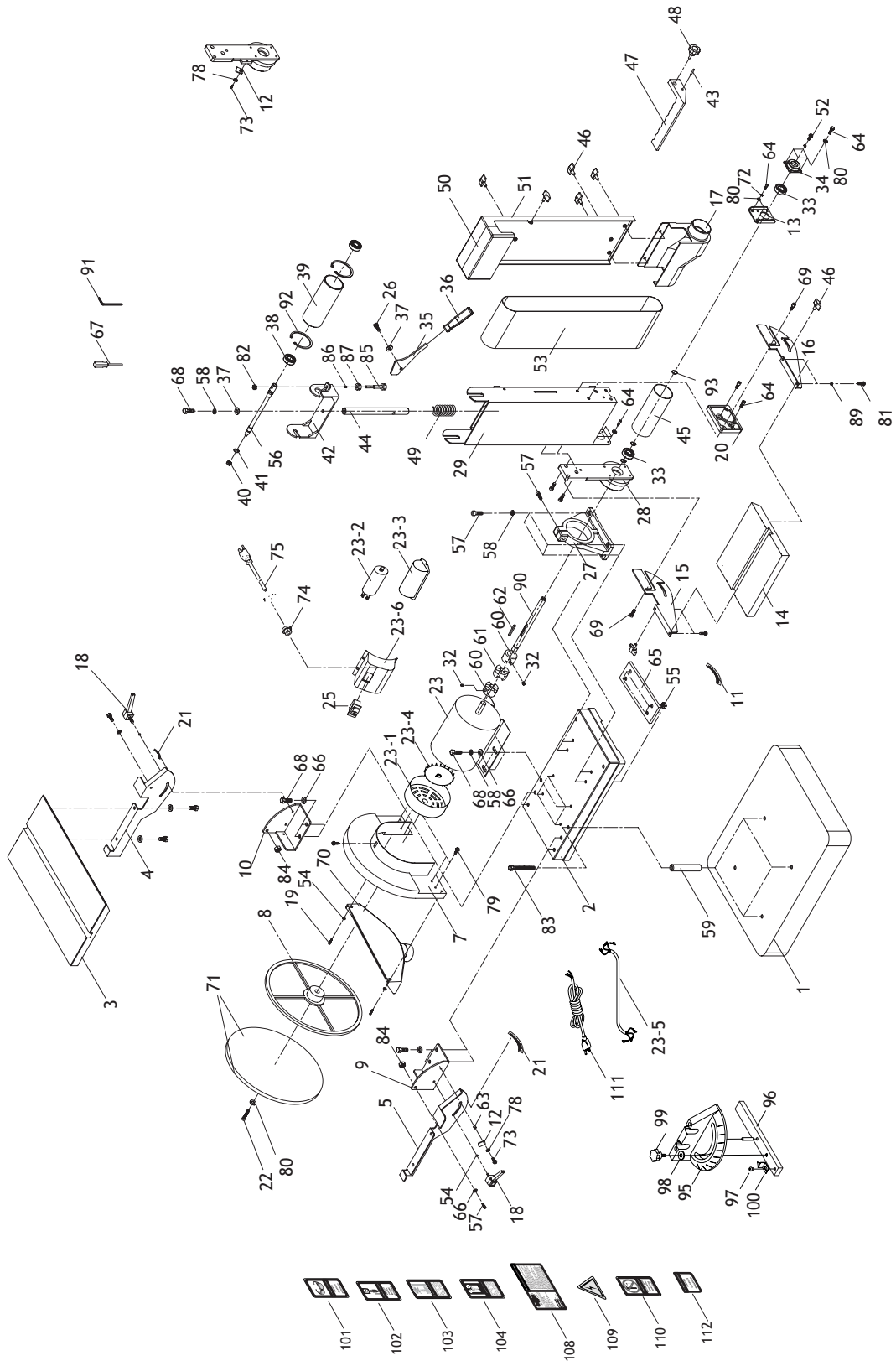

Figure 27. Cleaning the sanding belt with PRO STICK®.

PARTS



PARTS

PARTS

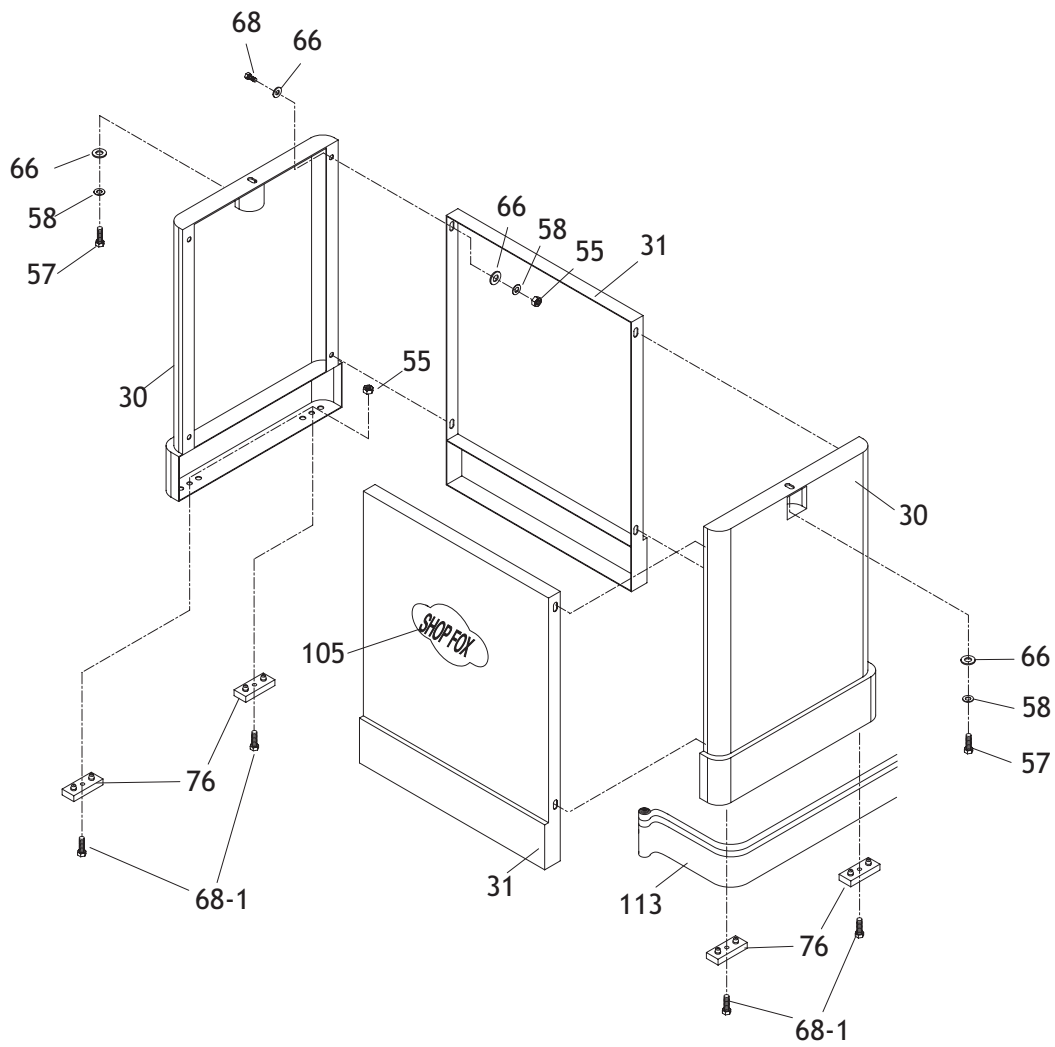

REF	PART #	DESCRIPTION
1	X1712001	BASE LOWER
2	X1712002	BASE UPPER
3	X1712003	DISC TABLE
4	X1712004	FRONT GRADUATED SCALE
5	X1712005	REAR GRADUATED SCALE
6	X1712006	DISC DUST HOOD
7	X1712007	DISC GUARD
8	X1712008	DISC
9	X1712009	FRONT BRACKET
10	X1712010	REAR BRACKET
11	X1712011	GRADUATED SCALE
12	X1712012	SCALE INDICATOR
13	X1712013	BEARING FIXED PLATE
14	X1712014	BELT TABLE
15	X1712015	LEFT SCALE PLATE
16	X1712016	RIGHT SCALE PLATE
17	X1712017	BELT DUST HOOD
18	X1712018	KNOB BOLT M6-1 X 12
19	XPS22	PHLP HD SCR 10-24 X 5/8"
20	X1712020	RIGHT GRADUATED SCALE BASE
21	X1712021	GRADUATED SCALE
22	XPSB112M	CAP SCREW M6-1 X 15 LH
23	X1712023	MOTOR
23-1	X1712023-1	MOTOR FAN COVER
23-2	X1712023-2	CAPACITOR 45 MFD 250 VAC
23-3	X1712023-3	CAPACITOR COVER
23-4	X1712023-4	MOTOR FAN
23-5	X1712023-5	MOTOR CORD
23-6	X1712024	SWITCH BOX
25	X1712025	SWITCH
26	XPB11	HEX BOLT 5/16"-18 X 1 1/2"
27	X1712027	TILTING FIXED BRACKET
28	X1712028	CONNECTION BLOCK
29	X1712029	SANDING PLATEN
30	X1712030	RIGHT/LEFT CABINET PANEL
31	X1712031	FRONT/REAR CABINET PANEL
32	XPSS11	SET SCREW 1/4"-20 X 1/4"
33	XP6202	BALL BEARING 6202ZZ
34	X1712034	BEARING CAP 6202ZZ

REF	PART #	DESCRIPTION
35	X1712035	BELT CHANGE HANDLE
36	X1712036	BELT TENSION LEVER
37	XXPW07	FLAT WASHER 5/16"
38	XP6201	BALL BEARING 6201
39	X1712039	DRIVEN ROLLER
40	XPLN02	LOCK NUT 1/4"-20
41	XPR03M	EXT RETAINING RING 12MM
42	X1712042	DRIVE ROLLER BRACKET
43	XPRP32M	ROLL PIN 6 X 40
44	X1712044	BRACKET SHAFT
45	X1712045	DRIVE ROLLER
46	X1712046	KNOB BOLT 1/4"-20 X 3/8"
47	X1712047	STOP FENCE
48	X1712048	KNOB BOLT M8-1.25 X 35
49	X1712049	SPRING
50	X1712050	DUST COVER LID
51	X1712051	DUST COVER BACK
52	XPS18	PHLP HD SCR 10-24 X 1/4"
53	X1712053	SANDING BELT 6" X 48"
54	XPW03M	FLAT WASHER 6MM
55	XPNO5	HEX NUT 5/16"
56	X1712056	DRIVEN ROLLER AXLE
57	XPB15	HEX BOLT 5/16"-18 X 3/8"
58	XPLW01	LOCK WASHER 5/16"
59	X1712059	SPACER
60	X1712060	COUPLER
61	X1712061	COMPOUND BLOCK
62	XPK12M	KEY 5 X 5 X 30
63	X1712063	SPACER 6MM
64	XPB19	HEX BOLT 1/4"-20 X 1/2"
65	X1712065	PLATE
66	XPW07	FLAT WASHER 5/16"
67	X1712067	SCREWDRIVER
68	XPB03	HEX BOLT 5/16"-18 X 1"
68-1	XPS79	PHLP HD SCR 3/16"-18 X 3/4"
69	XPSB30	CAP SCREW M8-1.25 X 25
71	X1712071	12" DISC SANDING PAPER
72	XPLW02	LOCK WASHER 1/4"
73	XPS06M	PHLP HD SCR M5-.8 X 20

REF	PART #	DESCRIPTION
74	X1712074	STRAIN RELIEF BUSHING
75	X1712075	POWER CORD
76	X1712076	PAD
77	XPB03	HEX BOLT $\frac{5}{16}$ "-18 X 1"
78	XPW06	FLAT WASHER $\frac{1}{4}$ "
79	XPHTEK8	TAP SCREW #8 X $\frac{1}{2}$ "
80	XPW06	FLAT WASHER $\frac{1}{4}$ "
81	XPS01	PHLP HD SCR 10-24 X $\frac{1}{2}$ "
82	XPLN04	LOCK NUT 10-24
83	XPB04	HEX BOLT $\frac{5}{16}$ "-18 X 3"
84	XPLN03	LOCK NUT $\frac{5}{16}$ "-18
85	X1712085	TRACKING ADJUSTMENT BOLT
86	X1712086	STEEL BALL 9MM
87	X1712087	ADJUSTMENT NUT
89	XPW06	FLAT WASHER $\frac{1}{4}$ "
90	X1712090	COUPLED AXLE
91	X1712091	HEX WRENCH 6MM
92	XPR29M	INT RETAINING RING 32MM
93	XPR52M	INT RETAINING RING 15MM
94	X1712094	MANUAL

REF	PART #	DESCRIPTION
95	X1712095	MITER GAUGE BODY
96	X1712096	MITER GAUGE BAR
97	XPS06	PHLP HD SCR 10-24 X $\frac{3}{8}$ "
98	XPTLW01	EXT TOOTH WASHER #10
99	X1712099	KNOB BOLT FOR MITER GAUGE
100	X1712100	POINTER
101	X1712101	WARNING LABEL-EYE GLASSES
102	X1712102	WARNING LABEL-DUST MASK
103	X1712103	WARNING LABEL-READ MANUAL
104	X1712104	WARNING LABEL-UNPLUG
105	X1712105	SHOP FOX LOGO
106	X1712106	STRIP FOR STAND
107	X1712107	STRIP FOR FRAME
108	X1712108	MACHINE ID LABEL
109	X1712109	ELECTRICITY LABEL
110	X1712110	WARNING LABEL-LOCK BOLT
111	X1712111	POWER CORD
112	X1712112	WARNING LABEL-BELT GUARD
113	X1712113	DECORATIVE STRIPE

Troubleshooting Sanding

SYMPTOM	POSSIBLE CAUSE	CORRECTIVE ACTION
Deep sanding grooves or scars in workpiece.	<ol style="list-style-type: none"> 1. Sanding belt/disc grit is too coarse for the desired finish. 2. Workpiece sanded across the grain. 3. Too much sanding force on workpiece. 4. Workpiece held still against the belt/disc. 	<ol style="list-style-type: none"> 1. Use a finer grit sanding belt/disc. 2. Sand with the grain. 3. Reduce pressure on workpiece while sanding. 4. Keep workpiece moving while sanding on the belt/disc.
Grains rub off the belt or disc easily.	<ol style="list-style-type: none"> 1. Sanding belt/disc has been stored in an incorrect environment. 2. Sanding belt/disc has been folded or smashed. 	<ol style="list-style-type: none"> 1. Store sanding belt/disc away from extremely dry or hot temperatures. 2. Store sanding belt/disc flat not folded or bent.
Sanding surfaces clogs quickly or burns.	<ol style="list-style-type: none"> 1. Too much pressure against belt/disc. 2. Sanding softwood. 	<ol style="list-style-type: none"> 1. Reduce pressure on workpiece while sanding. 2. Use different stock. Or, accept the characteristics of the stock and plan on cleaning/replacing belts frequently.
Burn marks on workpiece.	<ol style="list-style-type: none"> 1. Using too fine of sanding grit. 2. Using too much pressure. 3. Work held still for too long. 	<ol style="list-style-type: none"> 1. Use a coarser grit sanding belt/disc. 2. Reduce pressure on workpiece while sanding. 3. Do not keep workpiece in one place for too long.
Glazed sanding surfaces.	<ol style="list-style-type: none"> 1. Sanding wet stock. 2. Sanding stock with high residue. 	<ol style="list-style-type: none"> 1. Dry stock properly before sanding. 2. Use different stock. Or, accept the characteristics of the stock and plan on cleaning/replacing belts/discs frequently.
Workpiece frequently gets pulled out of your hand.	<ol style="list-style-type: none"> 1. Not supporting the workpiece against the stop. 2. Starting the workpiece on a leading corner. 	<ol style="list-style-type: none"> 1. Use back stop to support workpiece. 2. Start workpiece on a trailing corner.
Motor will not start.	<ol style="list-style-type: none"> 1. Low voltage. 2. Open circuit in motor or loose connections. 	<ol style="list-style-type: none"> 1. Check power line for proper voltage. 2. Inspect all lead connections on motor for loose or open connections.
Motor will not start; fuses or circuit breakers blow.	<ol style="list-style-type: none"> 1. Short circuit in line cord or plug. 2. Short circuit in motor or loose connections. 3. Incorrect fuses or circuit breakers in power line. 	<ol style="list-style-type: none"> 1. Inspect cord or plug for damaged insulation and shorted wires. 2. Inspect all connections on motor for loose or shorted terminals or worn insulation. 3. Install correct fuses or circuit breakers.
Motor overheats.	<ol style="list-style-type: none"> 1. Motor overloaded. 2. Incorrect usage of machine. 3. Air circulation through the motor restricted. 	<ol style="list-style-type: none"> 1. Reduce load on motor. 2. Reduce the applied load on the machine. 3. Clean out motor to provide normal air circulation.
Motor stalls (resulting in blown fuses or tripped circuit).	<ol style="list-style-type: none"> 1. Short circuit in motor or loose connections. 2. Low voltage. 3. Incorrect fuses or circuit breakers in power line. 4. Motor overloaded. 	<ol style="list-style-type: none"> 1. Inspect connections on motor for loose or shorted terminals or worn insulation. 2. Correct the low voltage conditions. 3. Install correct fuses or circuit breakers. 4. Reduce load on motor.
Machine slows when operating.	<ol style="list-style-type: none"> 1. Applying too much pressure to workpiece. 2. Undersized circuit or using ext cord. 	<ol style="list-style-type: none"> 1. Sand with less pressure—let the movement of the belt/disc do the work. 2. Make sure circuit wires are proper gauge & don't use ext cords!
Machine vibrates excessively.	<ol style="list-style-type: none"> 1. Stand not stable on floor. 2. Incorrect motor mounting. 3. Incorrect sanding belt tension. 4. Weak or broken tension spring. 5. Idler roller is too loose. 6. Broken/defective sanding belt/disc. 	<ol style="list-style-type: none"> 1. Secure stand to floor, reposition to level surface, or shim stand. 2. Check/adjust motor mounting. 3. Make sure tension lever is in tensioning position. Follow belt tensioning instructions in this manual. 4. Replace spring. 5. Adjust idler roller. 6. Replace sanding belt/disc.

Notes

Notes

WARRANTY CARD



Name _____
Street _____
City _____ State _____ Zip _____
Phone Number _____ E-Mail _____ FAX _____
MODEL # _____ Serial # _____

The following information is given on a voluntary basis and is strictly confidential.

1. Where did you purchase your **SHOP FOX**® machine? _____
_____ Band Saw _____ Planer
_____ Drill Press _____ Power Feeder
_____ Drum Sander _____ Radial Arm Saw
_____ Dust Collector _____ Sander
_____ Horizontal Boring Machine _____ Spindle Sander
_____ Jointer _____ Table Saw
_____ Sander _____ Vacuum Veneer Press
_____ Mortiser _____ Wide Belt Sander
_____ Other _____
2. How did you first learn about us?
_____ Advertisement _____ Friend
_____ Mail order Catalog _____ Local Store
_____ World Wide Web Site
_____ Other _____
3. Which of the following magazines do you subscribe to.
_____ American Woodworker _____ Today's Homeowner
_____ Cabinetmaker _____ Wood
_____ Family Handyman _____ Wooden Boat
_____ Fine Homebuilding _____ Woodshop News
_____ Woodsmith _____ Home Handyman
_____ Woodwork _____ Journal of Light Construction
_____ Woodworker _____ Popular Woodworking
_____ Old House Journal _____ Woodworker's Journal
_____ Popular Mechanics _____ Workbench
_____ Popular Science _____ American How-To
_____ Other _____
4. Which of the following woodworking/remodeling shows do you watch?
_____ Backyard America _____ The New Yankee Workshop
_____ Home Time _____ This Old House
_____ The American Woodworker _____ Woodwright's Shop
_____ Other _____
5. What is your annual household income?
_____ \$20,000-\$29,999 _____ \$60,000-\$69,999
_____ \$30,000-\$39,999 _____ \$70,000-\$79,999
_____ \$40,000-\$49,999 _____ \$80,000-\$89,999
_____ \$50,000-\$59,999 _____ \$90,000 +
6. What is your age group?
_____ 20-29 _____ 50-59
_____ 30-39 _____ 60-69
_____ 40-49 _____ 70 +
7. How long have you been a woodworker?
_____ 0 - 2 Years _____ 8 - 20 Years
_____ 2 - 8 Years _____ 20+ Years
8. How would you rank your woodworking skills?
_____ Simple _____ Advanced
_____ Intermediate _____ Master Craftsman
9. How many **SHOP FOX**® machines do you own? _____
10. What stationary woodworking tools do you own? Check all that apply.
_____ Air Compressor _____ Panel Saw
11. Which benchtop tools do you own? Check all that apply.
_____ 1" x 42" Belt Sander _____ 6" - 8" Grinder
_____ 5" - 8" Drill Press _____ Mini Lathe
_____ 8" Table Saw _____ 10" - 12" Thickness Planer
_____ 8" - 10" Bandsaw _____ Scroll Saw
_____ Disc/Belt Sander _____ Spindle/Belt Sander
_____ Mini Jointer
_____ Other _____
12. Which portable/hand held power tools do you own? Check all that apply.
_____ Belt Sander _____ Orbital Sander
_____ Biscuit Joiner _____ Palm Sander
_____ Circular Saw _____ Portable Planer
_____ Detail Sander _____ Saber Saw
_____ Drill/Driver _____ Reciprocating Saw
_____ Miter Saw _____ Router
_____ Other _____
13. What machines/supplies would you like to see?

14. What new accessories would you like Woodstock International to carry?

15. Do you think your purchase represents good value?
_____ Yes _____ No
16. Would you recommend **SHOP FOX**® products to a friend?
_____ Yes _____ No
17. Comments: _____

CUT ALONG DOTTED LINE

FOLD ALONG DOTTED LINE

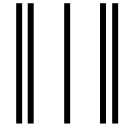
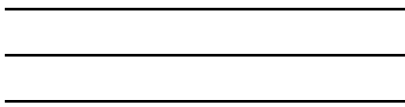

Place
Stamp
Here



WOODSTOCK INTERNATIONAL, INC.
P.O. BOX 2309
BELLINGHAM, WA 98227-2309



FOLD ALONG DOTTED LINE

TAPE ALONG EDGES--PLEASE DO NOT STAPLE

Free Manuals Download Website

<http://myh66.com>

<http://usermanuals.us>

<http://www.somanuals.com>

<http://www.4manuals.cc>

<http://www.manual-lib.com>

<http://www.404manual.com>

<http://www.luxmanual.com>

<http://aubethermostatmanual.com>

Golf course search by state

<http://golfingnear.com>

Email search by domain

<http://emailbydomain.com>

Auto manuals search

<http://auto.somanuals.com>

TV manuals search

<http://tv.somanuals.com>