

OWNER'S/ OPERATOR'S MANUAL

**MODEL NO.
PF-448**

⚠ CAUTION

For Safe Operation
Read Rules And
Instructions Carefully

SINO LEEINGLES, PIDA AYUDA
A AIGUIEN QUE SI LO LEA
PARA QUE LE TRADUZCA LAS
MEDIDAS DE SEGURIDAD.

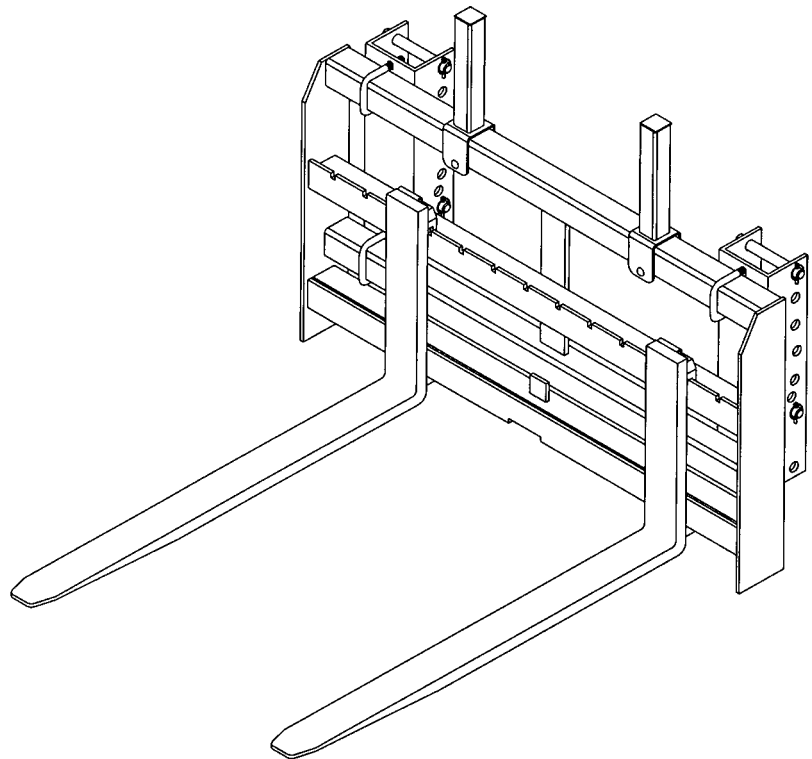

TRACTOR FRONT LOADER PALLET FORK

**Safety Instructions
Tractor Preparation
Operating Instructions**

**Assembly & Mounting
Maintenance
Repair Parts**

⚠ CAUTION ⚠

**THE FOLLOWING SAFETY PRECAUTIONS SHOULD BE THOROUGHLY UNDERSTOOD
BEFORE ATTEMPTING TO BEGIN ASSEMBLING THIS MACHINE**

1. Select an area for assembly that is clean and free of any debris which might cause persons working on the assembly to trip.
2. Do not lift heavy parts or assemblies. Use crane, jack, tackle, fork trucks or other mechanical devices.
3. Preview the assembly instructions in your operator's manual before proceeding further.
4. If the assembly instructions call for parts or assemblies to be blocked up, use only blocking material that is in good condition and is capable of handling the weight of the assembly to be blocked. Also insure that the blocking material is on a clean, dry surface.
5. Never put hands, or any part of body, under blocked up assemblies if at all possible.
6. After completing assembly, thoroughly inspect the machine to be sure that all nuts, bolts, hydraulic fittings or any other fastened assemblies have been thoroughly tightened.
7. Before operating the machine, thoroughly read the operation section of your operator's manual.
8. Before operating, read the maintenance section of your operator's manual to be sure that any parts requiring lubrication, such as gearboxes, are full, to avoid any possible damage.
9. **Before operating equipment – If you have any questions regarding the proper assembly or operation, contact your dealer or representative.**

TABLE OF CONTENTS

SINO LEEINGLES, PIDA AYUDA A
AIGUIEN QUE SI LO LEA PARA QUE
LE TRADUZCA LAS MEDIDAS DE
SEGURIDAD.

SAFETY INFORMATION	3
SAFETY SIGNS	13
PREPARATION INSTRUCTIONS	14
ASSEMBLY INSTRUCTIONS	15
OPERATING INSTRUCTIONS	16
PARTS DRAWING/LIST	18

STATEMENT OF POLICY

It is the policy of Worksaver, Inc. to improve its products where it is possible and practical to do so. Worksaver, Inc. reserves the right to make changes or improvements in design and construction at any time, without incurring the obligation to make these changes on previously manufactured units.

TO THE OWNER:

Read this manual before using your Loader Fork. This manual is provided to give you the necessary operating and maintenance instructions for keeping your Loader Fork in top operating condition. Please read this manual thoroughly. Understand what each control is for and how to use it. Observe all safety signs on the machine and noted throughout the manual for safe operation of implement. Keep this manual handy for ready reference.

Like all mechanical products, it will require cleaning and upkeep.

Use only genuine Worksaver, Inc. service parts. Substitute parts will void the warranty and may not meet standards required for safe and satisfactory operation. Record the model and serial number of your Loader Fork here:

Model: _____ Serial Number: _____

RETAIL CUSTOMER'S RESPONSIBILITY

It is the Retail Customer and/or Operator's responsibility to read the Operator's Manual, to operate, lubricate, maintain, and store the product in accordance with all instructions and safety procedures. Failure of the operator to read the Operator's Manual is a misuse of this equipment.

It is the Retail Customer and/or Operator's responsibility to inspect the product and to have any part(s) repaired or replaced when continued operation would cause damage or excessive wear to other parts or cause a safety hazard.

It is the Retail Customer's responsibility to deliver the product to the authorized Worksaver Dealer, from whom he purchased it, for service or replacement of defective parts which are covered by warranty. Repairs to be submitted for warranty consideration must be made within forty-five (45) days of failure.

It is the Retail Customer's responsibility for any cost incurred by the Dealer for traveling to or hauling of the product for the purpose of performing a warranty obligation or inspection.

LIMITED WARRANTY

Worksaver warrants to the original purchaser of any new Pallet Fork (Model PF-448), that the equipment be free from defects in material and workmanship for a period of six (6) months for non-commercial, state, and municipalities. Use sixty (60) days for commercial use from date of retail sale.

Replacement or repair parts installed in the equipment covered by this warranty are warranted for sixty (60) days from the date of purchase of such part or to the expiration of the applicable new equipment warranty period, whichever occurs later.

Such parts shall be provided at no cost to the user during regular working hours. Worksaver reserves the right to inspect any equipment or parts which are claimed to have been defective in material or workmanship.

DISCLAIMER OF IMPLIED WARRANTIES & CONSEQUENTIAL DAMAGES

Worksaver's obligation under this warranty, to the extent allowed by law, is in lieu of all warranties, implied or expressed, including implied warranties of merchantability and fitness for a particular purpose and any liability for incidental and consequential damages with respect to the sale or use of the items warranted. Such incidental and consequential damages shall include but not be limited to: transportation charges other than normal freight charges; cost of installation other than cost approved by Worksaver; duty; taxes; charges for normal service or adjustments; loss of crops or any other loss of income; rental of substitute equipment, expenses due to loss, damage, detention or delay in the delivery of equipment or parts resulting from acts beyond the control of Worksaver.

THIS WARRANTY SHALL NOT APPLY:

1. To vendor items which carry their own warranties, such as hydraulic cylinders, tires, and tubes.
2. If the unit has been subjected to misapplication, abuse, misuse, negligence, fire or other accident.
3. If parts not made or supplied by Worksaver have been used in connection with the unit, if, in sole judgement of Worksaver such use affects its performance, stability, or reliability.
4. If the unit has been altered or repaired outside of an authorized Worksaver dealership in a manner which, in the sole judgement of Worksaver affects its performance, stability or reliability.
5. To normal maintenance service and normal replacement items such as gearbox lubricant, hydraulic fluid, worn blades, or to normal deterioration of such things as belts and exterior finish, due to use or exposure.
6. To expendable or wear items such as teeth, chains, sprockets, belts, springs and other items that in the company's sole judgement is a wear item.

NO EMPLOYEE OR REPRESENTATIVE OF WORKSAVER IS AUTHORIZED TO CHANGE THIS WARRANTY IN ANY WAY OR GRANT ANY OTHER WARRANTY UNLESS SUCH CHANGE IS MADE IN WRITING AND SIGNED BY WORKSAVER'S SERVICE MANAGER, POST OFFICE BOX 100, LITCHFIELD, ILLINOIS 62056-0100.

To the Owner/Operator/Dealer

All implements with moving parts are potentially hazardous. There is no substitute for a cautious, safe-minded operator who recognizes the potential hazards and follows reasonable safety practices. The manufacturer has designed this implement to be used with all its safety equipment properly attached to minimize the chance of accidents.

BEFORE YOU START!!

Read the safety messages on the implement and shown in your manual.
Observe the rules of safety and common sense!



THIS SYMBOL MEANS

- ATTENTION!
- BECOME ALERT!
- YOUR SAFETY IS INVOLVED!

THIS SAFETY ALERT SYMBOL IDENTIFIES IMPORTANT SAFETY WARNING MESSAGES. CAREFULLY READ EACH WARNING MESSAGE THAT FOLLOWS. FAILURE TO UNDERSTAND AND OBEY A SAFETY WARNING, OR RECOGNIZE A SAFETY HAZARD, COULD RESULT IN AN INJURY OR DEATH TO YOU OR OTHERS AROUND YOU. THE OPERATOR IS ULTIMATELY RESPONSIBLE FOR THE SAFETY OF HIMSELF, AS WELL AS OTHERS, IN THE OPERATING AREA OF THE SKID STEER UNIT OR TRACTOR AND ATTACHED EQUIPMENT.

UNDERSTAND SIGNAL WORDS

Note the use of the signal words **DANGER**, **WARNING** and **CAUTION** with the safety messages. The appropriate signal word for each has been selected using the following guidelines:

DANGER: Indicates an imminently hazardous situation that, if not avoided, will result in death or serious injury. This signal word is to be limited to the most extreme situations typically for machine components which, for functional purposes, cannot be guarded.

WARNING: Indicates a potentially hazardous situation that, if not avoided, could result in death or serious injury, and includes hazards that are exposed when guards are removed. It may also be used to alert against unsafe practices.

CAUTION: Indicates a potentially hazardous situation that, if not avoided, may result in minor or moderate injury. It may also be used to alert against unsafe practices.

If you have questions not answered in this manual or require additional copies or the manual is damaged, please contact your dealer or the manufacturer directly.

IMPORTANT SAFETY INFORMATION!

Working with unfamiliar equipment can lead to careless injuries. Read this manual, and the manual for your tractor, skid steer, or forklift, before assembly or operating, to acquaint yourself with the machines. It is the implement owner's responsibility, if this machine is used by any person other than yourself, is loaned or rented, to make certain that the operator, prior to operating:

1. Reads and understands the operator's manuals.
2. Is instructed in safe and proper use.





The use of this equipment is subject to certain hazards which cannot be protected against by mechanical means or product design. All operators of this equipment must read and understand this entire manual, paying particular attention to safety and operating instructions, prior to using. If there is something in this manual you do not understand, ask your supervisor, or your dealer, to explain it to you.

SAFETY INSTRUCTIONS (continued)





EQUIPMENT SAFETY GUIDELINES

-  Safety of the operator is one of the main concerns in designing and developing a new piece of equipment. Designers and manufacturers build in as many safety features as possible. However, every year many accidents occur which could have been avoided by a few seconds of thought and a more careful approach to handling equipment. You, the operator, can avoid many accidents by observing the following precautions in this section. To avoid personal injury, study the following precautions and insist those working with you, or for you, follow them.

-  In order to provide a better view, certain photographs or illustrations in this manual may show an assembly with a safety shield removed. However, equipment should never be operated in this condition. Keep all shields in place. If shield removal becomes necessary for repairs, replace the shield prior to use.

-  Replace any CAUTION, WARNING, DANGER or instruction safety sign that is not readable or is missing. Location of such safety signs is indicated in this booklet.

-  Never use alcoholic beverages or drugs which can hinder alertness or coordination while operating this equipment. Consult your doctor about operating this machine while taking prescription medications.

-  Review the safety instructions with all users annually.

-  This equipment is dangerous to children and persons unfamiliar with its operation. The operator should be a responsible adult familiar with farm machinery and trained in this equipment's operations. **Do not allow persons to operate or assemble this unit until they have read this manual and have developed a thorough understanding of the safety precautions and of how it works.**

-  To prevent injury or death, use a tractor equipped with a Roll-Over Protective System (ROPS). Do not paint over, remove or deface any safety signs or warning signs on your equipment. Observe all safety signs and practice the instruction on them.

-  Never exceed the limits of a piece of machinery. If its ability to do a job, or to do so safely, is in question – **DON'T TRY IT.**







-  Do not modify the equipment in any way. Unauthorized modification may impair the function and/or safety and could affect the life of the equipment.

-  In addition to the design and configuration of this implement, including Safety Signs and Safety Equipment, hazard control and accident prevention are dependent upon the awareness, concern, prudence, and proper training of personnel involved in the operation, transport, maintenance, and storage of the machine. Refer also to Safety Messages and Operation Instructions in each of the appropriate sections of the Tractor, Skid Steer, and Implement Manuals. Pay close attention to the Safety Signs affixed to the Tractor, Skid Steer, and the Implement.

SAFETY INSTRUCTIONS (continued)







SAFETY TRAINING

-  Safety is a primary concern in the design and manufacture of our products. Unfortunately, our efforts to provide safe equipment can be wiped out by a single careless act of an operator.
-  In addition to the design and configuration of equipment, hazard control and accident prevention are dependent upon the awareness, concern, prudence and proper training of personnel involved in the operation, transport, maintenance and storage of equipment.
-  It has been said, "The best safety device is an informed, careful operator." We ask you to be that kind of an operator. It is the operator's responsibility to read and understand ALL Safety and Operating instructions in the manual and to follow these. Accidents can be avoided.
-  Working with unfamiliar equipment can lead to careless injuries. Read this manual, and the manual for your tractor, before assembly or operating, to acquaint yourself with the machines. It is the equipment owner's responsibility, if this machine is used by any person other than yourself, is loaned or rented, to make certain that the operator, prior to operating:
1. Reads and understands the operator's manuals.
 2. Is instructed in safe and proper use.
-  Know your controls and how to stop skid steer, tractor, engine, and loader quickly in an emergency. Read this manual and the one provided with your tractor or skid steer.
-  Train all new personnel and review instructions frequently with existing workers. A person who has not read and understood all operating and safety instructions is not qualified to operate the machine. An untrained operator exposes himself and bystanders to possible serious injury or death.
-  Do not allow children to operate this machine.







SAFETY INSTRUCTIONS (continued)



SAFETY SIGNS



-  Keep safety signs clean and legible at all times.
-  Replace safety signs that are missing or have become illegible.
-  Replaced parts that displayed a safety sign should also display the current sign.
-  Safety signs are available from your Distributor or Dealer Parts Department or the factory.

How to Install Safety Signs:

-  Be sure that the installation area is clean and dry.
-  Be sure temperature is above 50°F (10°C).
-  Decide on the exact position before you remove the backing paper.
-  Remove the smallest portion of the split backing paper.
-  Align the sign over the specified area and carefully press the small portion with the exposed sticky backing in place.
-  Slowly peel back the remaining paper and carefully smooth the remaining portion of the sign in place.
-  Small air pockets can be pierced with a pin and smoothed out using the piece of sign backing paper.















STARTING AND STOPPING SAFETY

-  Be certain the tractor or skid steer is in neutral or park position before starting engine.
-  Always shut off power unit and shift to “Park” or set brakes when leaving unit. Always lower bucket or attachment to ground, relieve all hydraulic pressure. Remove key when leaving equipment unattended. Park in level area.
-  Before operating equipment: if you have any questions regarding the proper assembly or operation, contact your dealer or representative.

SAFETY INSTRUCTIONS (continued)



OPERATIONAL SAFETY

-  The use of this equipment is subject to certain hazards which cannot be protected against by mechanical means or product design. All operators of this equipment must read and understand this entire manual, paying particular attention to safety and operating instructions, prior to using. If there is something in this manual you do not understand, ask your supervisor, or your dealer, to explain it to you.
-  Most accidents occur because of neglect or carelessness. Keep all helpers and bystanders fifty feet (50') from an operating power unit and attached equipment. Only properly trained people should operate this machine. It is recommended the tractor be equipped with a Rollover Protection System (ROPS) and a seat belt that is used. Always stop the tractor, skid steer, or forklift, set brake, shut off the engine, remove the ignition key, and lower loader and attachment to the ground before dismounting. Never leave equipment unattended with the engine running.
-  Please remember it is important that you read and heed the safety signs on the front loader attachment and loader, and the safety rules set forth. Clean or replace all safety signs if they cannot be clearly read and understood. They are there for your safety as well as the safety of others. The safe use of this machine is strictly up to you, the operator.
-  Be sure power unit is in good condition. Read all the safety precautions and make sure all operators are familiar with the safety rules of operation.
-  Know your controls and how to stop the power unit and engine quickly in an emergency. READ THIS MANUAL AND THE ONE PROVIDED WITH YOUR TRACTOR AND LOADER, OR SKID STEER.
-  When the use of hand tools is required to perform any part of assembly, installation, adjustment, maintaining, repairing, removal, or moving the implement, be sure the tools used are designed and recommended by the tool manufacturer for that specific task.
-  Personal protection equipment including safety glasses, safety shoes, and gloves are recommended during assembly, installation, operation, adjustment, maintaining, repairing, removal, or moving the attachment.
-  Always use two people to handle heavy, unwieldy components during assembly, installation, removal, or moving the loader attachment.
-  Never place any part of your body where it would be in danger if movement should occur during assembly, installation, operation, maintaining, repairing, removal, or moving the implement.
-  The use of any loader attachment is NOT recommended on tractor with a tricycle wheel arrangement. Tricycle type tractors are unstable for front loader use.
-  A heavy load can cause instability in driving a power unit. Make sure the front or rear of the power unit is properly counter-balanced with weights. Always drive slowly – especially around turns. An unstable power unit could steer badly and possibly tip over, causing injury or death.
-  Do not allow others to ride on the power unit with an operator. Riders are subject to injury such as being struck by foreign objects or being thrown off. Riders obstruct the operator's view resulting in unsafe operation. **Never allow anyone to ride on the implement!**

SAFETY INSTRUCTIONS (continued)



OPERATIONAL SAFETY (continued)



Before you operate any equipment, check over all pins, bolts and connections to be sure all are securely in place. Replace any damaged or worn parts immediately.



Do not work under a raised loader unless it is securely blocked or held in position. Do not depend on the power unit hydraulic system to hold the implement in place.



Operate the loader controls smoothly, avoiding jerky operation. Stop loader gradually when lowering or lifting loads.



Beware of low electrical wires when loader is raised. Serious injury or death can result if contact is made.



When handling material on a slope, always approach the material with the power unit facing uphill.



Only use a power unit equipped with a ROPS cab or rollover protective structure.



When stacking material, ALWAYS MAKE SURE MATERIAL IS PLACED SO THE STACK IS STABLE.



Keep all bystanders at a safe distance. REMEMBER FALLING ITEMS CAN ROLL OR TUMBLE.



Do not handle loads that exceed the weight limitations of the loader.



Carry the loads slowly and as low as possible to the ground. Avoid excessive speed during operation.



For operator safety, always keep load in front of power unit. NEVER position load back over operator. ALWAYS BE CAREFUL!



Beware of lift clearance when raising loader to maximum height.

















Keep alert and watch the rear as well as the front when working with the loader.

SAFETY INSTRUCTIONS (continued)

















OPERATIONAL SAFETY (continued)

-  When maneuvering close to buildings or passing through narrow areas, be sure to allow sufficient clearance for the power unit, loader, and load. Drive slowly.
-  Operate loader from operator's seat only. Remain at controls until operating cycle is complete.
-  Use extreme care when working on inclines and hillsides.
-  Do not operate close to ditches, creeks or holes. Slow down when operating over rough ground.
-  Allow for additional length of loader and load on power unit while turning.
-  Keep load centered on attachment and loader. Unbalanced loads increase possibility of tipping or roll-over.
-  Never allow anyone to walk or work under a raised loader.
-  Be sure that people, livestock, or pets are not standing near the machine while operating.
-  Do not use loader for a work platform.
-  Do not lift or carry anyone on loader or in bucket or on attachment.
-  ALWAYS lower loader to the ground or block securely before performing any maintenance work.
-  Always keep power unit on solid footing when operating loader.
-  Observe Safety Recommendations in loader instruction manual.
-  Inspect the entire machine periodically as indicated in the Maintenance Section of this manual. Look for loose fasteners, worn or broken parts, pinched hydraulic hoses, and leaky or loose fittings. Make sure all pins have cotter pins and washers. Serious injury may occur from not maintaining this machine in good working order.

SAFETY INSTRUCTIONS (continued)



TRANSPORT SAFETY

-  Comply with state and local laws governing highway safety and movement of farm machinery on public roads.
-  The use of flashing amber lights is acceptable in most localities. However, some localities prohibit their use. Local laws should be checked for all highway lighting and marking requirements.
-  When driving the tractor and equipment on the road or highway under 20 mph (32 kph) at night or during the day, use flashing amber warning lights and a slow moving vehicle (SMV) identification emblem.
-  Always be sure the implement is in the proper raised position for transport.
-  Reduce speed when transporting mounted implements to avoid bouncing and momentary loss of steering control.
-  Plan your route to avoid heavy traffic.
-  Always install transport locks, pins or brackets before transporting.
-  Do not drink and drive!
-  Watch for traffic when operating near or crossing roadways.
-  Turn curves or go up or down hills only at a low speed and at a gradual steering angle. Make certain that at least 20% of the tractor's weight is on the front wheels to maintain safe steering. Slow down on rough or uneven surfaces, and loose gravel.
-  Use extreme care and maintain minimum ground speed when transporting on hillside, over rough ground and when operating close to ditches or fences. Be careful when turning sharp corners.
-  Never allow riders on either power unit or implement. Falling off can kill.
-  Be a safe and courteous driver. Always yield to oncoming traffic in all situations, including narrow bridges, intersections, etc.
-  Do not exceed 20 mph (32 kph). Reduce speed on rough roads and surfaces.
-  Always disengage PTO before driving the tractor to transport the implement from one place to another.

SAFETY INSTRUCTIONS (continued)





MAINTENANCE SAFETY

-  Good maintenance is your responsibility. Poor maintenance is an invitation to trouble.

-  Follow good shop practices.
 - Keep service area clean and dry.
 - Be sure electrical outlets and tools are properly grounded.
 - Use adequate light for the job at hand.

-  Make sure there is plenty of ventilation. Never operate the engine of the towing vehicle in a closed building. The exhaust fumes may cause asphyxiation.

-  Before working on this machine, drive to a level area, disengage the PTO, lower implement or loader (or if working underneath, raise and block securely), shut off the engine, relieve all hydraulic pressure, set the brakes, and remove the ignition keys.

-  Be certain all moving parts on attachments have come to a complete stop before attempting to perform maintenance.

-  Never work under equipment unless it is blocked securely. Never depend on hydraulic system to keep implement in raised position.

-  Keep all persons away from operator control area while performing adjustments, service, or maintenance.

-  Always use personal protection devices such as eye, hand and hearing protectors, when performing any service or maintenance.

-  Periodically tighten all bolts, nuts and screws and check that all cotter pins are properly installed to ensure unit is in a safe condition.







-  When completing a maintenance or service function, make sure all safety shields and devices are installed before placing unit in service.

-  Openings in the skin and minor cuts are susceptible to infection from hydraulic fluid. If injured by escaping hydraulic fluid, see a doctor at once. Gangrene and death can result. Without immediate medical treatment, serious infection and reactions can occur.

SAFETY INSTRUCTIONS (continued)









MAINTENANCE SAFETY (continued)

-  After servicing, be sure all tools, parts and service equipment are removed.
-  Check to ensure all safety signs are installed and in good condition. (See safety sign section for location drawing.)
-  Do not allow grease or oil to build up on any deck or platform.
-  Never replace hex bolts with less than grade five bolts unless otherwise specified, i.e. shear bolts. Refer to bolt torque chart for head identification marking.
-  Where replacement parts are necessary for periodic maintenance and servicing, genuine factory replacement parts must be used to restore your equipment to original specifications. The manufacturer will not claim responsibility for use of unapproved parts and/or accessories and other damages as a result of their use.
-  If equipment has been altered in any way from original design, the manufacturer does not accept any liability for injury or warranty.
-  A fire extinguisher and first aid kit should be kept readily accessible while performing maintenance on this equipment.



STORAGE SAFETY

-  Following operation or when unhooking, stop the skid steer or tractor, set the brakes, shut off the engine, relieve all hydraulic pressure and remove the ignition keys.
-  Store the unit in an area away from human activity.
-  Do not park equipment where it will be exposed to livestock for long periods of time. Damage and livestock injury could result.
-  Do not permit children to play on or around the stored unit.
-  Make sure all parked machines are on a hard, level surface and engage all safety devices.
-  If blocking is used, make sure it is solid and secure before leaving area.

SAFETY SIGNS

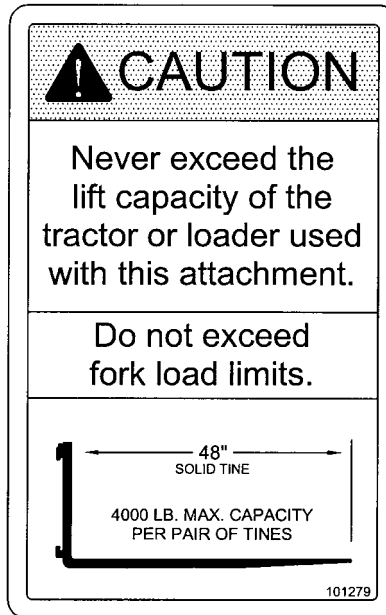
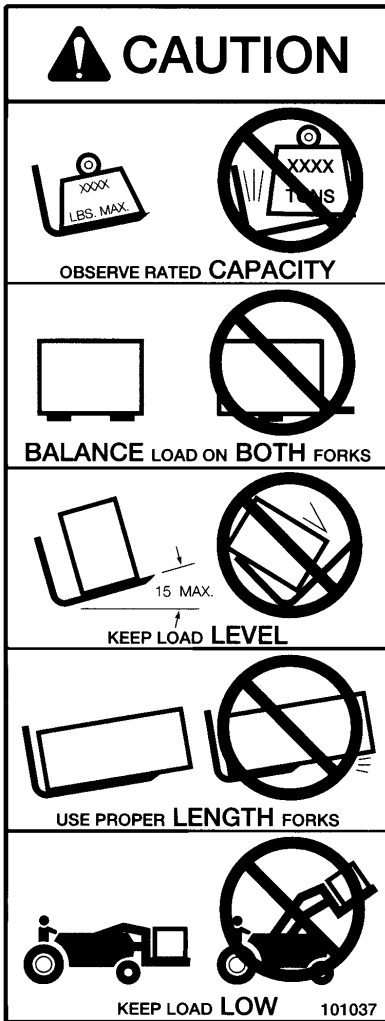

**REPLACE
SAFETY DECALS
IF DAMAGED
OR MISSING!**

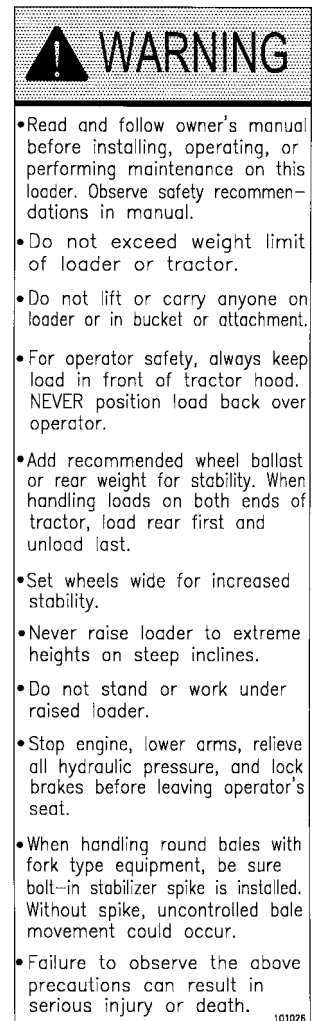

SAFETY INFORMATION

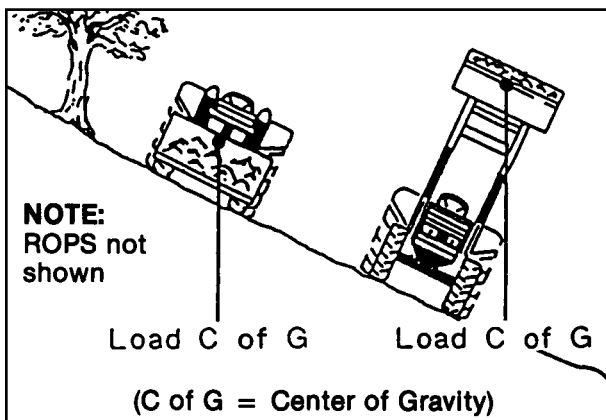

When working on side hills, **DO NOT RAISE LOADER TOO HIGH.** Keep an eye on terrain changes. Keep load low.

Safety is a primary concern in the design and manufacture of our products. Unfortunately, our efforts to provide safe equipment can be wiped out by a single careless act of an operator.

In addition to the design and configuration of equipment, hazard control and accident prevention are dependent upon the awareness, concern, prudence and proper training of personnel involved in the operation, transport, maintenance and storage of equipment.

It has been said, "The best safety device is an informed, careful operator." We ask you to be that kind of an operator.

**ALWAYS OBEY ALL SAFETY RULES!
ALWAYS BE CAREFUL!**

INSTRUCTIONS

The Universal Pallet Fork attachment is designed to fit most farm tractor double-cylinder front-end loaders. Optional brackets are available to fit some popular quick coupler front-end loaders.

The Universal Pallet Fork will also work on the rear of tractors with a Category II 3 pt. hitch.

The model PF-448 with 48" solid pallet forks can handle loads up to 4,000 lbs. Load ratings are figured with the load about 20" in front of the fork lift frame and evenly distributed between the two fork tines. **NEVER** put load at the ends of the fork tines – the lift capacity at the ends of the forks is only about 1/3 of the total lift capacity. **WARRANTY DOES NOT COVER BENT FORKS.**

TRACTOR REQUIREMENTS AND PREPARATION

The required size of the tractor and front loader or skid steer will be determined by the weight of the load to be handled.

Always use a tractor and front loader or skid steer large enough to safely handle the load.

Check your tractor and front loader or skid steer to make sure they are in good working condition. Check all frame mounting bolts to make sure they are tight.

Loaders that attach to the tractor frame rails should have a cross-tie installed for stability.



The use of any loader attachment is NOT recommended on tractors with a tricycle wheel arrangement. Tricycle type tractors are unstable for front loader use.

NOTE: Loaders with only one hydraulic cylinder in the center of the loader to tilt the bucket or attachment may be used with the addition of an optional center bracket (order bracket #830320).

Check the tractor's hydraulic system. Be sure the hydraulic oil and filter have been serviced according to manufacturer's recommendations. Refer to your tractor or loader operator's manual or dealer for any adjustments necessary to put the hydraulic system in good working order.

Be sure tires and rims are in good condition. Inflate tires to the proper recommended air pressure.



Power unit must be equipped with ROPS or ROPS cab and seat belt. Keep seat belt securely fastened. Falling off power unit can result in death from being run over or crushed. Keep foldable ROPS systems in "locked up" position at all times.



Be sure your tractor and loader are in good condition. Read all the safety precautions and make sure all equipment operators are familiar with the safety rules of operation.

The operator is responsible for the safe operation of this equipment. The operator must be properly trained. Operators should be familiar with the tractor, loader and loader attachment, and all safety practices before starting operation. Read the safety rules and safety signs on pages 3-13.



A heavy load can cause instability in driving a tractor. Make sure the rear of the tractor is properly counter-balanced with weights. Always drive slowly – especially around turns. An unstable tractor could steer badly and possibly tip over, causing injury or death.

ASSEMBLY – TRACTOR LOADERS PIN ON ATTACHMENT

This unit is shipped almost completely assembled. Carefully follow instructions for final assembly.

Preview the assembly instructions and the exploded views of the pallet fork in your operator's manual and become familiar as to how the parts or assemblies go together.

INSTRUCTIONS (continued)

ASSEMBLY (continued)

Remove the bucket from your front end loader. Check your loader to make sure it is in good working order. Check all frame mounting bolts to make sure they are tight.

Loaders that attach to the tractor frame rails should have a cross-tie installed for stability.

Refer to the "exploded view" of the Loader Fork on page 18 of this manual.

Assemble the two lift brackets (Ref. #3) on the main frame (Ref. #1) with the $\frac{5}{8}$ " x 3" I.D. U-bolts. Leave the U-bolts loose.

NOTE: The lift channel brackets are supplied with 1" diameter pins to fit your loader. If your loader requires $1\frac{1}{8}$ " pins, it will be necessary for the hole diameter in the channel brackets to be drilled out to $1\frac{5}{32}$ " (1.156") and ask your dealer to order $1\frac{1}{8}$ " diameter pins. The $1\frac{1}{8}$ " pins are part #830318. Be sure to indicate if two or four $1\frac{1}{8}$ " pins are required.

If your loader requires $1\frac{1}{4}$ " diameter pins, please ask your dealer to order adapter bushings (part #830319). Be sure to indicate how many adapter bushings are required.

NOTE: The Ford (New Holland) models 7109, 7209, 7210, 7309, 7310 and 7410 Pin Type Loaders require special brackets. Also, Rhino (Alamo) models 2410 and 2491. Order #830330 bracket kit.

NOTE: For loaders that require brackets that provide additional roll back, order #830335 (1" pins).

Connect the above assembly to the loader arms using the bottom hole in the channel and attach the upper control cylinder to the top hole in the lift channels. Center the main frame (side to side) with your loader arms and tighten the four (4) $\frac{5}{8}$ " x 3" U-Bolts.

The lower hole positions in the lift channels can be used to obtain more angle movement. However, if the frame becomes too parallel with the loader lift arms, the loader may not have enough power (mechanical advantage) to bring the frame back.

NOTE: Generally, it is not recommended to have the tilt cylinders located any closer than 10-12 inches to the main loader lift arms. **Check the spacing of mounting pins on your loader bucket and use this as a guide.**

If tilt cylinders are located too close to the loader arms, they may go "over center" when fully extended. If this happens, damage may occur to the cylinders and/or mounting brackets.

ASSEMBLY – QUICK ATTACH

If your tractor loader has a bucket Quick Attach feature, check with your dealer on the availability of adapter brackets for your brand and model loader.

Measure the width of the front adapter on your loader and locate the Quick Attach brackets on the main frame. Locate these brackets so the main frame will be centered on your loader.

Tighten the U-bolts that connect the brackets to the main frame.

ASSEMBLY – TRACTOR LOADERS

Install the pallet forks on the main frame. The forks go on in the center of the main frame and then are slid to the right or left side.

NOTE: Smearing a light coat of grease on the main frame rails will make adjusting the fork width easier.

IMPORTANT: Keep forklift tines adjusted to maximum width for better load stability.

PRE-OPERATION CHECKLIST

(OWNER/OPERATOR RESPONSIBILITY)

- ___ Review and follow safety rules and safety signs on pages 3 through 13.
- ___ Check that Loader Fork is properly and securely attached to tractor loader.
- ___ Check that all hardware is properly installed.
- ___ Check that no one enters the area of machine operation. Always work at a safe distance from roads, built-up areas, or populated places.
- ___ Know your controls and how to stop tractor, engine and PTO quickly in an emergency. READ THIS MANUAL AND THE ONE PROVIDED WITH YOUR TRACTOR AND LOADER.
- ___ To avoid accident or injury, do not allow anyone to operate this equipment without proper instructions. Any person who operates this equipment must be instructed in and be capable of the safe operation of the tractor, implement and all controls.

OPERATING INSTRUCTIONS

OPERATION

Be sure tractor or skid steer is properly counter-balanced with weights before attempting to lift any load.

Make sure fork latch is properly engaged.

Using the bucket tilt cylinders, adjust the angle of the fork tines so they are parallel with the ground.

Adjust height of fork tines to enter the pallet to be handled. Always keep the load or pallet as close to the forklift main frame as possible.

Make sure weight of load is centered between the forks.



Never exceed the lift capacity of the tractor/loader or skid steer used with the loader fork.



Avoid carrying loose or shiftable loads. Falling items could cause injury.



The Model PF-448 Pallet Fork is NOT to be used for large round bales, as this would create a hazardous condition.



Beware of low electrical wires when loader is raised. Serious injury or death can result if contact is made.



Beware of lift clearance when raising loader to maximum height.

Make sure all operators have read the Owner's Manual and are familiar with the instructions and the safety rules of operation.

OPERATE LOADER SAFELY

- Improper use of loader can cause serious injury or death.
- Become familiar with controls.
- Be sure anyone operating the loader is aware of safe operation and potential hazards. Read and observe safety recommendations in loader manual.
- Operate loader from operator's seat only. Remain at controls until operating cycle is complete.
- Stop loader gradually when lowering or lifting loads.
- Use particular care when working on inclines and hill-sides.
- Avoid holes, ditches, and obstructions which may cause tractor/loader to tip.
- Allow for additional length of loader on tractor while turning.
- Never allow anyone to walk or work under a raised loader.
- Be sure that people, livestock, or pets are not standing near the machine while operating.
- Do not use the loader for a work platform.
- Do not lift or carry anyone on loader or in bucket or attachment.
- Carry load low.
- Travel slowly over rough ground or when making turns.
- Drive slowly through gates and doors.
- Avoid carrying loose or shiftable loads.
- Lower bucket or attachment to ground when loader is unattended.

OWNER SERVICE

MAINTENANCE

WARNING!

Always stop the tractor or skid steer, set brake, shut off engine, remove key, and lower loader to ground before attempting to service. Never leave equipment unattended with engine running.

WARNING!

Do not work under a raised loader unless it is securely blocked or held in position. Do not depend on the hydraulic system to hold loader and attachment in place.

Check the pins at the ends of the loader arms. Make sure they are locked in place with the linchpins.

Periodically check all bolts to make sure they are tight.

Replace any worn or damaged parts immediately. Do not use attachment with any damaged parts.

**REPLACE
SAFETY SIGNS
IF DAMAGED
OR MISSING.**

TRANSPORTING

CAUTION!

When traveling on public roads, whether at night or during the day, use accessory light and devices for adequate warnings to operators of other vehicles. Comply with all federal, state and local laws.

Check visibility. If visibility is impaired, reduce speed or consider other means of transport.

Allow for additional length of loader on tractor while turning. Carry load low.

Select a safe ground travel speed when transporting from one area to another. When traveling on roadways, transport in such a way that faster moving vehicles may pass you safely.

When traveling over rough or hilly terrain or when making turns, slow down and use extra care.

Read all the safety warnings in the front of this manual and in the manual of tractor or skid steer unit.

STORAGE

- At the end of the working season or when the pallet fork will not be used for a long period, it is good practice to clean off any dirt or grease that may have accumulated.
- Inspect the pallet fork for loose, damaged or worn parts and adjust or replace if needed.
- Sand areas where paint is chipped or worn and repaint to prevent rust.
- Always store in a safe place away from children or livestock.

MODEL PF-448 PARTS LIST

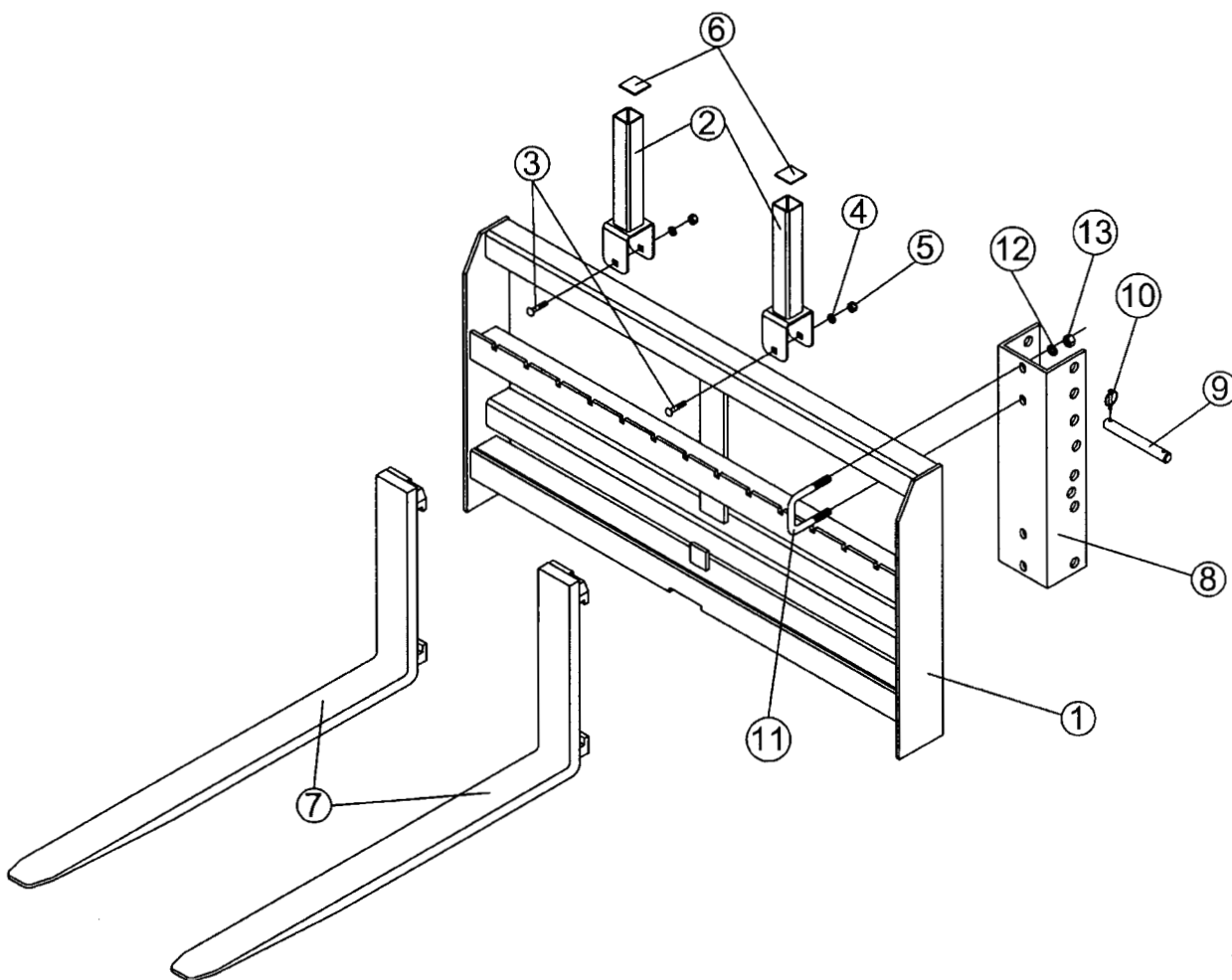

Ref. No.	Part No.	Description	No. Req'd.
1	831831	Frame Weldment (PF-448)	1
2	831835	Backstop Weldment (PF-448)	2
3	2503160	Bolt, Carriage 1/2"-13NC x 4.00" G2	2
4	2502002	Washer, 1/2" Spring Lock	2
5	2500003	Nut, Hex 1/2"-13NC	2
6	2504309	Cap, Plastic (2 x 2)	2
7	831375	48" Fork (SSPF-3748/PF-448)	2
8	830317	Lift Bracket - Standard (Hay Channels)	2
9	830309	Pin, Lift (1" Dia. x 8" Long)	4
10	590034	AK-61 Linchpin 1/4"	8
11	830214	U-Bolt 5/8"-11NC 3" x 4 1/2"	4
12	2502007	Washer, 5/8" Spring Lock	8
13	2500013	Nut, Hex 5/8" - 11NC	8
N/S	101279	Safety Sign- Caution (Fork Limits)	1
N/S	101037	Safety Sign- Caution (Capacity)	1
N/S	101026	Safety Sign - Warning (Read Owner's Manual)	1

⚠ SAFETY PRECAUTIONS ⚠

**MOST ACCIDENTS OCCUR BECAUSE OF NEGLIGENCE OR CARELESSNESS.
AVOID NEEDLESS ACCIDENTS BY FOLLOWING ALL OF THE SAFETY PRECAUTIONS LISTED BELOW.**

- Machinery should be operated only by those who are responsible and are authorized to do so.
- Stop the engine, lower all equipment, lock the brakes, and remove the ignition key before dismounting from the tractor.
- Never stand between tractor and implement while tractor is being backed to hitch.
- Loose fitting clothing should not be worn, to avoid catching on various parts.
- Detach implement in area where children normally do not play.
- When performing adjustments or maintenance on an implement, first lower it to the ground or block it securely at a workable height.
- Only a qualified operator should be permitted on tractor when in operation; no riders allowed.
- Make certain everyone is in the clear before starting tractor or raising or lowering equipment.
- Operate the tractor and implement only while seated in the driver's seat.
- Reduce speed when transporting mounted implements to avoid bouncing and momentary loss of steering control.
- A heavy load can cause instability of the tractor. Use extreme care during road travel. Slow down on turns and watch out for bumps. Tractor may need front counterweights to counter-balance the weight of the implement.
- Reduce speed on hillsides or curves so there is no danger of tipping.
- Avoid driving too close to the edge of ditches or creeks.
- Do not transport implement on public roads without reflectors and slow moving vehicle emblem in daylight and with approved warning lights at night and other periods of poor visibility.
- Due to the width of some implements, use extra caution on highways, farm roads, and when approaching gates.
- Always be sure the implement is in the proper position for transport.
- Keep alert and watch the front as well as the rear when working with the implement.

OWNER'S/ OPERATOR'S MANUAL

**MODEL NO.
PF-448**

**WHEN ORDERING REPAIR
PARTS, ALWAYS GIVE THE
FOLLOWING INFORMATION:**

1. PART NUMBER
2. PART DESCRIPTION
3. MODEL NUMBER
4. NAME OF ITEM

MAY 2006

TRACTOR FRONT LOADER PALLET FORK

- ✓ Please work, drive, play, and live each day with care and concern for your safety and that of your family and fellow citizens.

**MAKE EVERY DAY A
HOLIDAY FROM ACCIDENTS!**

WORKSAVER, INC.

P.O. BOX 100 LITCHFIELD, IL 62056-0100 (217) 324-5973
WEB: <http://www.worksaver.com> E-MAIL: sales@worksaver.com

WS-TA004-0G

Free Manuals Download Website

<http://myh66.com>

<http://usermanuals.us>

<http://www.somanuals.com>

<http://www.4manuals.cc>

<http://www.manual-lib.com>

<http://www.404manual.com>

<http://www.luxmanual.com>

<http://aubethermostatmanual.com>

Golf course search by state

<http://golfingnear.com>

Email search by domain

<http://emailbydomain.com>

Auto manuals search

<http://auto.somanuals.com>

TV manuals search

<http://tv.somanuals.com>