

OWNER'S MANUAL

**MODEL NO.
HK-102**

⚠ CAUTION

For Safe Operation
Read Rules And
Instructions Carefully

SINO LEEINGLES, PIDA AYUDA
A AIGUIEN QUE SI LO LEA
PARA QUE LE TRADUZCA LAS
MEDIDAS DE SEGURIDAD.

STATEMENT OF POLICY

It is the policy of **Worksaver, Inc.** to improve its products where it is possible and practical to do so. **Worksaver, Inc.** reserves the right to make changes or improvements in design and construction at any time, without incurring the obligation to make these changes on previously manufactured units.

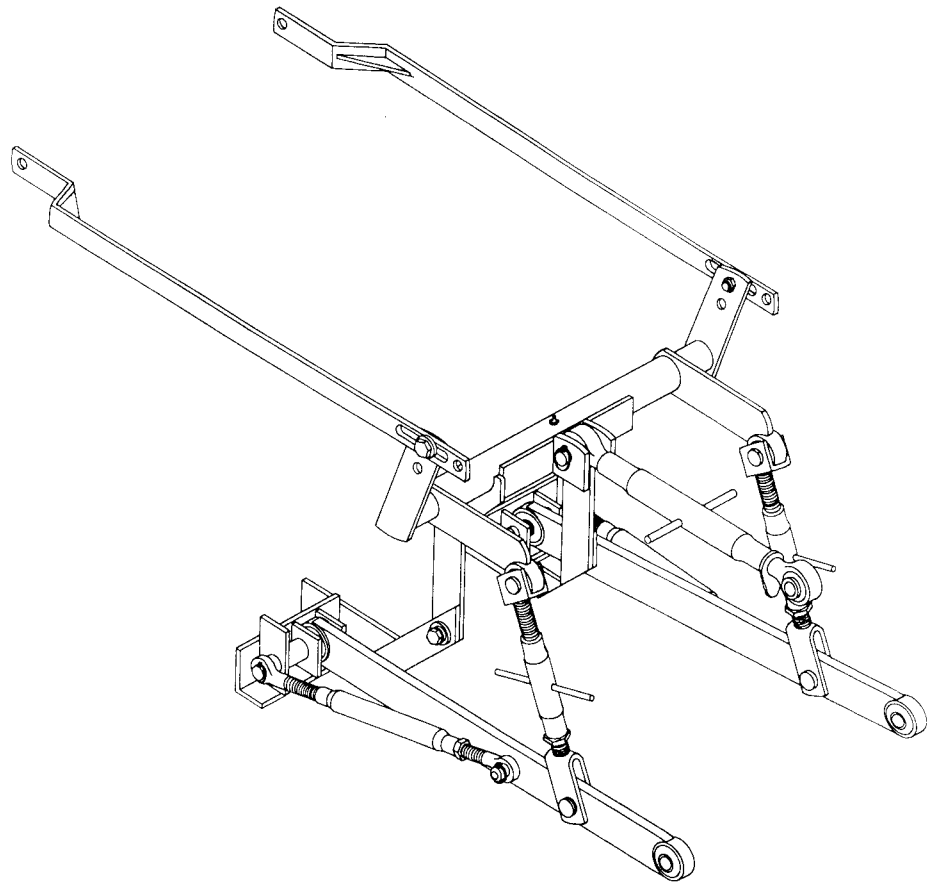

3 PT. HITCH ADAPTER KIT

For IHC/Farmall Models C, Super C, 200, 230

**Safety Instructions
Tractor Preparation
Operating Instructions**

**Assembly & Mounting
Maintenance
Repair Parts**

⚠ CAUTION

**THE FOLLOWING SAFETY PRECAUTIONS SHOULD BE THOROUGHLY UNDERSTOOD
BEFORE ATTEMPTING TO BEGIN ASSEMBLING THIS MACHINE**

1. Select an area for assembly that is clean and free of any debris which might cause persons working on the assembly to trip.
2. Do not lift heavy parts or assemblies. Use crane, jack, tackle, fork trucks or other mechanical devices.
3. Preview the assembly instructions in your operator's manual before proceeding further.
4. If the assembly instructions call for parts or assemblies to be blocked up, use only blocking material that is in good condition and is capable of handling the weight of the assembly to be blocked. Also insure that the blocking material is on a clean, dry surface.
5. Never put hands, or any part of body, under blocked up assemblies if at all possible.
6. After completing assembly, thoroughly inspect the machine to be sure that all nuts, bolts, hydraulic fittings or any other fastened assemblies have been thoroughly tightened.
7. Before operating the machine, thoroughly read the operation section of your operator's manual.
8. Before operating, read the maintenance section of your operator's manual to be sure that any parts requiring lubrication, such as gearboxes, are full, to avoid any possible damage.
9. **Before operating equipment – If you have any questions regarding the proper assembly or operation, contact your Worksaver dealer or representative.**

To the Owner/Operator/Dealer

All implements with moving parts are potentially hazardous. There is no substitute for a cautious, safe-minded operator who recognizes the potential hazards and follows reasonable safety practices. The manufacturer has designed this implement to be used with all its safety equipment properly attached to minimize the chance of accidents.

BEFORE YOU START!!

**Read the safety messages on the implement and shown in your manual.
Observe the rules of safety and common sense!**



THIS SYMBOL MEANS

- ATTENTION!
- BECOME ALERT!
- YOUR SAFETY IS INVOLVED!

THIS SAFETY ALERT SYMBOL IDENTIFIES IMPORTANT SAFETY WARNING MESSAGES. CAREFULLY READ EACH WARNING MESSAGE THAT FOLLOWS. FAILURE TO UNDERSTAND AND OBEY A SAFETY WARNING, OR RECOGNIZE A SAFETY HAZARD, COULD RESULT IN AN INJURY OR DEATH TO YOU OR OTHERS AROUND YOU. THE OPERATOR IS ULTIMATELY RESPONSIBLE FOR THE SAFETY OF HIMSELF, AS WELL AS OTHERS, IN THE OPERATING AREA OF THE TRACTOR AND EQUIPMENT.

UNDERSTAND SIGNAL WORDS

Note the use of the signal words **DANGER**, **WARNING** and **CAUTION** with the safety messages. The appropriate signal word for each has been selected using the following guidelines:

DANGER: Indicates an imminently hazardous situation that, if not avoided, will result in death or serious injury. This signal word is to be limited to the most extreme situations typically for machine components which, for functional purposes, cannot be guarded.

WARNING: Indicates a potentially hazardous situation that, if not avoided, could result in death or serious injury, and includes hazards that are exposed when guards are removed. It may also be used to alert against unsafe practices.

CAUTION: Indicates a potentially hazardous situation that, if not avoided, may result in minor or moderate injury. It may also be used to alert against unsafe practices.

IMPORTANT SAFETY INFORMATION!

Working with unfamiliar equipment can lead to careless injuries. Read this manual, and the manual for your tractor, before assembly or operating, to acquaint yourself with the machine. It is the equipment owner's responsibility, if this equipment is used by any person other than yourself, is loaned or rented, to make certain that the operator, prior to operating:

1. Reads and understands the operator's manuals.
2. Is instructed in safe and proper use.

















The use of this equipment is subject to certain hazards which cannot be protected against by mechanical means or product design. All operators of this equipment must read and understand this entire manual, paying particular attention to safety and operating instructions, prior to using. If there is something in this manual you do not understand, ask your supervisor, or your dealer, to explain it to you.

















Most accidents occur because of neglect or carelessness. Keep all helpers and bystanders twenty-five feet (25') from operating equipment. Only properly trained people should operate this tractor and attached implement. It is recommended the tractor be equipped with a Roll-Over Protection System (ROPS) and a seat belt that is used. Always stop the tractor, set brake, shut off the tractor engine, remove the tractor key, and lower implement to the ground before dismounting tractor. Never leave equipment unattended with the tractor running.

SAFETY INFORMATION (continued)

-  All equipment is potentially hazardous. There is no substitute for a cautious, safe-minded operator who recognizes potential hazards and follows reasonable safety practices.
-  When the use of hand tools is required to perform any part of assembly, installation, adjustment, maintaining, repairing, removal, or moving the implement, be sure the tools used are designed and recommended by the tool manufacturer for that specific task.
-  Personal protection equipment including safety glasses, safety shoes, and gloves are recommended during assembly, installation, operation, adjustment, maintaining, repairing, removal, or moving of the hitch kit.
-  Always use two people to handle heavy, unwieldy components during assembly, installation, removal, or moving of the hitch kit.
-  Never place any part of your body where it would be in danger if movement should occur during assembly, installation, operation, maintaining, repairing, removal, or moving the implement.
-  Never place yourself between the tractor and implement while implement is in operation.
-  Do not work under a raised implement unless it is securely blocked or held in position. Do not depend on the tractor hydraulic system to hold the implement in place.
-  A heavy load can cause instability of the tractor. Use extreme care during travel. Slow down on turns and watch out for bumps. The tractor may need front counter-weights to counter-balance the weight of the implement. An unstable tractor could steer badly and possibly tip over, causing injury or death.
-  Never use alcoholic beverages or drugs which can hinder alertness or coordination while operating equipment. Consult your doctor about operating tractor and implement while taking prescription medications.
-  Do not allow others to ride on the tractor with an operator. Riders are subject to injury such as being struck by foreign objects or being thrown off. Riders obstruct the operator's view resulting in unsafe operation. **Never allow anyone to ride on the implement!**
-  Before you operate any implement, check over all pins, bolts and connections to be sure all are securely in place. Replace any damaged or worn parts immediately.
-  Do not allow anyone who is not familiar with the safety rules and operation instructions to use this equipment.
-  Never allow children to operate or be around equipment.
-  Do not exceed lift capacity of the tractor hitch.
-  Keep alert and watch the front as well as the rear when working with the attached implements.

SAFETY INFORMATION (continued)

-  When maneuvering close to buildings or passing through narrow areas, be sure to allow sufficient clearance for the implement.
-  Do not operate close to ditches or creeks. Slow down when operating over rough ground.
-  Always be sure the implement is in the fully raised position when in transport.
-  Pull from drawbar or lower 3 pt. arms only. Failure to hitch properly could cause tractor to flip over, resulting in serious injury or death.
-  Use extreme caution when backfilling deep holes or trenches.
-  Use care when working on slopes.
-  Avoid excessive speed during operation.
-  Make adjustments only when the implement is attached to the tractor.
-  When using a rear blade in a reverse position, use extra care. **Do not ram rear blade** into piles of dirt. Tractor lift arms and the rear blade are not built to take high impact loads in this position. **Ramming** backwards can also dislodge operator from seat and/or tractor controls, resulting in possible serious injury or death.
-  Always ease the tractor into the load. It may be necessary to reposition and take less “bite” on the material to move it safely.
-  Watch for and avoid hidden obstructions, i.e., buried pipes, rocks, concrete piers, uneven concrete slabs, stumps, etc., when operating rear blades, box scrapers, or other ground engaging implements.
-  NEVER operate any PTO driven implement unless tractor PTO guard is in place and PTO driveline shielding is in place.
-  Always shut off tractor and shift to “Park” or set brakes when leaving tractor. Always lower implement to ground. Remove key when leaving tractor unattended.
-  Before operating equipment: if you have any questions regarding the proper assembly or operation, contact your dealer or representative.

**ALWAYS OBEY ALL
SAFETY RULES!
ALWAYS BE CAREFUL!**

Safety is a primary concern in the design and manufacture of our products. Unfortunately, our efforts to provide safe equipment can be wiped out by a single careless act of an operator.

In addition to the design and configuration of equipment, hazard control and accident prevention are dependent upon the awareness, concern, prudence and proper training of personnel involved in the operation, transport, maintenance and storage of equipment.

It has been said, “The best safety device is an informed, careful operator.” We ask you to be that kind of an operator.

INSTRUCTIONS

The Model HK-102 hitch adapter kit is designed for the IHC/Farmall Model C, Super C, 200 and 230 tractors. This kit is for tractors equipped with a standard swinging drawbar. NOT for tractors with the IHC fast hitch (2 pt.).

This kit uses the existing hydraulic lift on the tractor to raise and lower the 3 pt. hitch.

TRACTOR PREPARATION

Be sure tires and rims are in good condition. Inflate tires to the proper recommended air pressure.

Check the tractor's hydraulic system. Refer to your tractor operator's manual or dealer for any adjustments necessary to put the hydraulic system in good working order. (I&T shop manuals will list most specifications and adjustment instructions – available from most farm equipment dealers.)

Check the shield over the PTO stub shaft. Make sure it is in good condition and bolted securely to the tractor. Purchase a new shield if old shield is damaged or missing. (You may have to use a tractor salvage yard for replacement parts on older tractors.)

It is recommended that a ROPS (Roll-Over Protection Structure) be installed on all tractors. Contact your local dealer for ROPS for your tractor.

Check the threaded holes that go into the rear tractor housing and make sure the threads are in good condition and that the holes are clean.

NOTE: These holes on the sides of the differential housing may have painted cork plugs in them. It is necessary to remove the cork and clean the holes.



If an air hose is used to blow any loose rust or dirt from the holes, be sure safety glasses are used to prevent particles from entering an eye.

The HK-102 kit is designed to lift up to 800 pounds. This capacity of lift is calculated at a point 24" to the rear of the lift arms. The lifting capacity is dependent on the pressure and condition of the tractor's hydraulic system. You will also find that the closer the load is kept to the tractor, the more you will be able to lift. The tractor and the hitch may be damaged if you use heavier loads.



Be sure your tractor is in good condition and properly equipped with counterweights. Read all the safety precautions and make sure all tractor operators are familiar with the safety rules of tractor operation.

PACKING

The three point hitch kit is shipped as 1 carton and 2 bundles.

1. The carton contains all of the hardware.
2. One bundle is the main frame.
3. One bundle is the lift control arms.

ASSEMBLY

For instruction reference, the terms front or rear are based on the operator facing forward on the tractor, thus front is toward the front of the tractor and the rear is to the rear of the tractor.

It is suggested that all the instructions be read before beginning assembly.

Check the exploded view of the HK-102 hitch kit in this manual to get an idea of the relationship between the parts.

Place the main hitch frame in position on the upper rear part of the differential housing. Insert the $\frac{3}{4}$ " x 2" hex head bolts with lockwasher through the upper holes (two each side) in the hitch frame and into the housing on the tractor. Leave all bolts loose at this time.

Remove the swinging drawbar bracket bolts on each side to install the right and left hand pull brackets over the outside of the existing drawbar brackets. (Do one side at a time.)

Place the $\frac{5}{8}$ " x 2" hex bolt with lockwasher through the rear oval hole in the pull bracket, the lower hole of the main frame, and into the housing of the tractor. Leave the bolt loose for now.

Swing the pull bracket up into position and using a $\frac{5}{8}$ " – 11 x 2 $\frac{1}{4}$ " hex bolt with lockwasher, place it through the front oval hole of the pull bracket, the drawbar mounting bracket, and into the tractor housing. Repeat this procedure for the opposite side, then tighten all the bolts.

INSTRUCTIONS (continued)

ASSEMBLY (continued)

Attach the two lift control arms (slotted end goes to the hitch main frame) to the hydraulic lift quadrant on the tractor. Using one of the $\frac{5}{8}$ " – 11 x $2\frac{1}{4}$ " hex head bolts, 2 flat washers, and locknut, attach the other end to the upright arm on the main frame (arm without ball socket). Use the slot so that the hitch will float as the tractor navigates rough terrain. Be sure to use a flat washer against the slot. Check to see that the lift control arm moves freely but without excessive looseness.

On both the outer left-hand and the right-hand ends of the pull brackets, start the ends of the pull pins (ref. #11) through the outer pull bracket ears. Position the pull pin so that the end with **NO** hole goes to the inside.

As soon as the end of the pull pin passes through the first outer pull bracket ear, slide the pull pin spacer (ref. #12) on the pin so that it is located between the first and second pull bracket ears. Slide the pull pin in further until the end is just entering the second pull bracket ear.

Then place the forward end of the lift arm between the large side plate on the pull bracket and the second pull bracket. Slide the pull pin in further so that it goes through the ball end of the lift arm and enters the hole in the large side plate.

Rotate the pull pin so that the holes in the pin are horizontal. Slide the spacer tube and adjust the pull pin so that a large ($\frac{5}{16}$ ") hairpin clip can be inserted through the center hole of the pull pin. This locks the pull pin in place on each side.

Pin the leveling assemblies (ref. #20-24) to the rockershaft lift arms (arms with balls welded on), using the $\frac{7}{8}$ " flat head pins (ref. #26) and linchpins.

Raise the lift arms, sliding them between the clevis ends of the lift arm leveling assemblies, and pin them in place.

Install the stabilizer stub pins (ref. #27) in the forward holes of each lift arm. Have the large ($\frac{7}{8}$ ") diameter of the stub pin to the outside of the lift arm and the threaded nut to the inside. **Do not use a lockwasher under the nut.** Place a screwdriver or small bar through the linchpin hole and tighten the nut on the stub pin.

Place one end of the stabilizer bars (ref. #16-19) over the ends of the pull pins on the outside of the pull bracket and secure with linchpins.

The stabilizer bars have threaded ends and can be adjusted to the correct length by turning the center barrel. Adjust the stabilizer bars, then slide the other end over the stabilizer stub pins in the lift arms. Secure in place with linchpins.

NOTE: Angle of Stabilizer Ends

The ends of the stabilizer bars (ref. #17, 18) may not be at the correct angle for your hitch. Since this hitch kit can connect to either Category I (26" pull pin width) or to Category II (32" pull pin width) equipment, slightly different angles will be required on the stabilizer bar threaded stub ends. If the angle is not correct for your desired hitch spacing, place one end of the stabilizer bar threaded stub in a vise and apply hand pressure to the other end of the stabilizer bar assembly until desired angle is obtained. Reverse the stabilizer assembly in the vise and repeat for the other end.

It is suggested that you connect the lift arm ends to a piece of equipment or install a 3 pt. drawbar and center the lift arms (side to side) so you can easily determine what angle correction may be required.

NOTE: Use of Stabilizer Bars

For some implements such as post hole diggers, rear blades, landscape rakes, and rear 3 pt. scoops, you need to install the stabilizer bars to eliminate side movement of the hitch to control the implement.

With other implements, such as 3 pt. plows, disc harrows, field cultivators, and harrows, it is best to remove the stabilizer bars and allow the hitch side movement. This makes it easier to steer the tractor and minimize side pressure on the hitch and the implement when turning.

NOTE: When connecting the hitch to an implement, it will be necessary to remove the lift arm end of the stabilizer bar from the lift arm. This allows the lift arm to swing out and be installed on the pull pin of the implement.

After the lift arms are connected to the implement, the stabilizer bars need to be reconnected and adjusted so that the implement is centered behind the tractor.

Attach the center link to the main frame using the $\frac{3}{4}$ " topline pin and linchpin provided.

Tighten all bolts before using this kit.

Check to make sure that the hitch is operating smoothly.

Read manual before operating.



- ▲ **Keep clear of rotating parts; stay on tractor seat until all motion has stopped.**
- ▲ **Be sure tractor engine is off and key is removed before making any adjustments.**
- ▲ **Do not get under machine to make measurements or adjustments without securely blocking implement first.**

INSTRUCTIONS (continued)

SAFETY TRAINING

- Know your controls and how to stop tractor, engine, and PTO quickly in an emergency. READ THIS MANUAL AND THE ONE PROVIDED WITH YOUR TRACTOR.
- To avoid accident or injury, do not allow anyone to operate this equipment without proper instructions. Any person who operates this equipment must be instructed in and be capable of the safe operation of the tractor, implement and all controls.
- Do not allow children to operate this machine.
- Always wear relatively tight and belted clothing to avoid entanglement in moving parts. Wear sturdy, rough-soled work shoes and protective equipment for eyes, hands, and hearing. Never operate tractor in bare feet, sandals, or sneakers.
- Operate only in daylight or good artificial light.
- Ensure implement is properly mounted, adjusted and in good operating condition.
- Ensure that all safety shielding and safety signs are properly installed and in good condition.

OPERATION

Two holes are provided on the lift arms to connect to the lower ends of the leveling assemblies.

The forward holes will provide the greatest lifting range for the ball ends of the lift arms. The rear holes will allow heavier loads to be handled by the hitch.

The adjustable screw type leveling assemblies will provide additional adjustment in the lifting height of the hitch.

NOTE: BE SURE THAT AT LEAST 1¼" OF THREAD ON EACH END IS ENGAGED INTO THE THREADED BARREL OF THE LEVELING ASSEMBLIES.



A heavy load can cause instability in driving a tractor. Make sure the front of the tractor is properly counter-balanced with weights. Always drive slowly – especially around turns. An unstable tractor could steer badly and possibly tip over, causing injury or death.

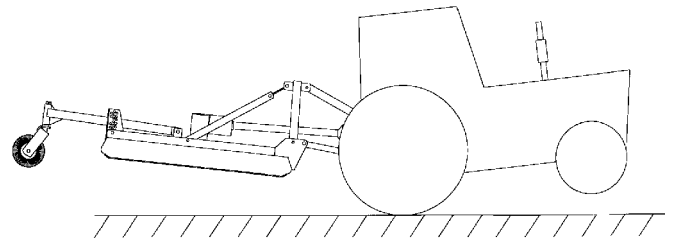

Figure 1. Tractor Stability



When using 3 pt. hitch equipment, a minimum 20% of tractor and equipment weight must be on tractor front wheels. Without this weight, tractor could tip up, causing possible loss of control and possible personal injury or death. The weight may be attained with a front end loader, front wheel weights, ballast in tires or front tractor weights. When attaining a minimum 20% of tractor and equipment weight on the front wheels, you must not exceed the ROPS weight certification. Weigh the tractor and equipment. DO NOT GUESS OR ESTIMATE!

The adjustable screw type top link can also be shortened or lengthened to adapt different implements and can be used to obtain various degrees of pitch on the implements you are using.

The ball sockets on the lift arms are two-way balls, so they will accommodate both Category I or Category II lift pins on the implement. If the drawbar or implement has Category I (7/8") pins, make sure the balls are turned so that the 7/8" diameter holes are used.

NOTE: If the larger 1 1/8" diameter holes are used with the smaller 7/8" pins, the ball sockets will "hole out," for which Worksaver cannot be responsible. If you do use smaller 7/8" diameter lift pins and the larger 1 1/8" diameter ball holes, be sure to use lift arm adapter bushings to eliminate the excess play or loose fit.

The stabilizer bars should be used whenever possible, as they not only prevent side sway, but provide rigidity and stability to the unit – plus added strength. The stabilizer bars are threaded stubs so their length can be adjusted so the spread of the lift arms can be increased or decreased to accommodate the different width of Category I and Category II tools.

INSTRUCTIONS (continued)

WARNING!

Be sure your tractor is in good condition and properly equipped with counterweights. Read all the safety precautions and make sure all tractor operations are familiar with the safety rules of tractor operation.

CAUTION!

When using a 3 pt. hitch rear blade in a reverse position (bulldozing), use extra care. **DO NOT RAM BLADE** into dirt or packed snow piles! Tractor lift arms and the blade are not built to take high impact loads in this position. **RAMMING** backwards can also dislodge operator from seat and/or tractor controls, resulting in possible serious injury or death.

Always ease the tractor into the load. It may be necessary to reposition and take less "bite" on the material to move it safely.

Watch for and avoid hidden obstructions, i.e., buried pipes, rocks, concrete piers, uneven concrete slabs, stumps, etc., when operating. This is especially of concern when removing snow.

STORING SAFELY

- Never store equipment with fuel in the tank inside a building where fumes may reach an open flame or spark. Allow engine to cool before storing in an enclosure.
- Do not run engine indoors - exhaust gases contain carbon monoxide, an odorless and deadly poison.
- Sand areas where paint is chipped or worn and repaint to prevent rust. Lubricate all pivot locations on hitch kit to prevent moisture damage during storage.

MAINTENANCE

Inspect the hitch kit for loose, damaged or worn parts and adjust or replace if needed.

Repaint parts where paint is worn or scratched to prevent rust.

Check all bolts and nuts to be sure they are tight.

Periodically oil the following:

- a. Top link (upper 3rd link) threads
- b. Ball sockets
- c. Leveling assembly threads
- d. Stabilizer bar threads

**OBEY ALL
SAFETY WARNINGS!**

SAFETY SIGNS

**REPLACE SAFETY SIGNS
IF DAMAGED OR MISSING!**

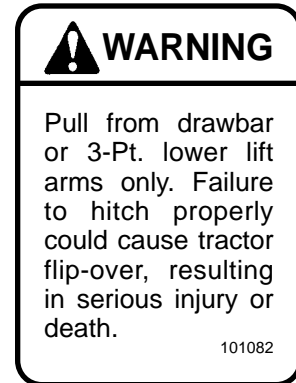

**ALWAYS OBEY ALL SAFETY RULES!!
ALWAYS BE CAREFUL!!**

- U Keep children away from danger all day, every day.
- U Equip tractors with roll-over protection (ROPS) and keep all machinery guards in place.
- U Please work, drive, play, and live each day with care and concern for your safety and that of your family and fellow citizens.

HK-102
3 PT. ADAPTER KIT
EXPLODED PARTS VIEW

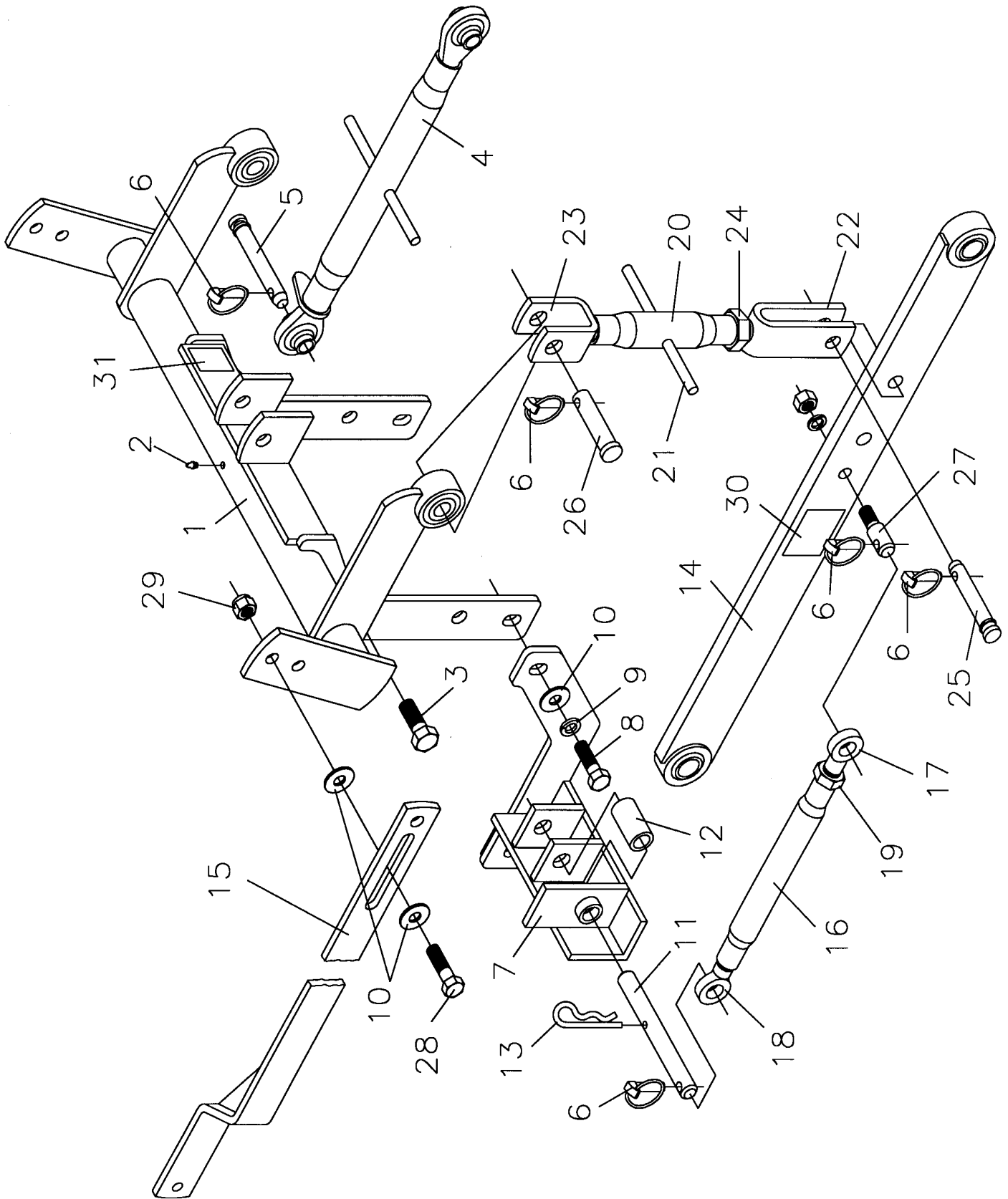

HK - 102
3 PT. ADAPTER KIT
REPAIR PARTS

REF. NO.	PART NO.	DESCRIPTION	NO. REQ.
1	865104	Main Frame Weldment (HK-102)	1
2	2504049	Drive Zerk $\frac{5}{16}$ "	1
3	2503002	Bolt $\frac{3}{4}$ " - 10 NC x 2" Hex Head	2
4	590072	Top Link, Cat. I (AK-500F)	1
5	590002	Toplink Pin Cat. I (AK-9)	1
6	590006	Linch Pin $\frac{7}{16}$ " (AK-14)	9
7	865120	LH Pull Bracket	1
NS	865125	RH Pull Bracket	1
8	2503048	Bolt $\frac{5}{8}$ " - 11NC x 2" Hex Head	2
9	2502007	Washer $\frac{5}{8}$ " Springlock	2
10	2501005	Washer $\frac{5}{8}$ " Flat	6
11	865338	Pin, Pull $\frac{7}{8}$ " Dia. x $7\frac{3}{4}$ " Lg.	2
12	865339	Spacer, Pull Pin	2
13	590014	Hairclip Pin $\frac{5}{16}$ " (AK-36)	2
14	865014	Lift Arm Weldment 34"	2
15	861148	Lift Control Arm Weldment	2
	590317	Stabilizer Assembly (Parts 16-19)	2
16	590406	Barrel $\frac{7}{8}$ " - 14NF	2
17	590407	Stabilizer End RH	2
18	590318	Stabilizer End LH	2
19	2500018	Nut $\frac{7}{8}$ " - 14NF Jam Hex	2
	861131	Leveling Assembly (AK-503) (Parts 20-24)	2
20	590278	Barrel $1\frac{1}{8}$ " - 7NC x $8\frac{1}{4}$ " Lg.	2
21	590145	Knock-In Handle	2
22	861136	Lower Lift Bracket RH	2
23	861139	Upper Lift Bracket LH	2
24	2500024	Nut $1\frac{1}{8}$ " - 7NC Jam Hex	2
25	590001	Toplink Pin Cat. I (AK-8)	2
26	860107	Upper Lift Pin ($\frac{7}{8}$ " Dia. x $3\frac{1}{2}$ "	2
27	590069	Stabilizer Stub Pin (AK-378) with Washer & Nut	2
28	2503059	Bolt $\frac{5}{8}$ " - 11NC x $2\frac{1}{4}$ " Hex Head	2
29	2500041	Nut $\frac{5}{8}$ " - 11NC Hex Nylock	2
30	101039	Safety Sign - Caution (Stay Clear of Arms)	2
31	101082	Safety Sign - Warning (Pull from Drawbar)	1

**Obey All
Safety Warnings**



SAFETY PRECAUTIONS

MOST ACCIDENTS OCCUR BECAUSE OF NEGLIGENCE OR CARELESSNESS.

AVOID NEEDLESS ACCIDENTS BY FOLLOWING ALL OF THE SAFETY PRECAUTIONS LISTED BELOW.

- Machinery should be operated only by those who are responsible and are authorized to do so.
- Stop the engine, lower all equipment, lock the brakes, and remove the ignition key before dismounting from the tractor.
- Never stand between tractor and implement while tractor is being backed to hitch.
- Loose fitting clothing should not be worn, to avoid catching on various parts.
- Detach implement in area where children normally do not play.
- When performing adjustments or maintenance on an implement, first lower it to the ground or block it securely at a workable height.
- Only a qualified operator should be permitted on tractor when in operation; no riders allowed.
- Make certain everyone is in the clear before starting tractor or raising or lowering equipment.
- Operate the tractor and implement only while seated in the driver's seat.
- Reduce speed when transporting mounted implements to avoid bouncing and momentary loss of steering control.
- A heavy load can cause instability of the tractor. Use extreme care during road travel. Slow down on turns and watch out for bumps. Tractor may need front counter-weights to counter-balance the weight of the implement.
- Reduce speed on hillsides or curves so there is no danger of tipping.
- Avoid driving too close to the edge of ditches or creeks.
- Do not transport implement on public roads without reflectors and slow moving vehicle emblem in daylight and with approved warning lights at night and other periods of poor visibility.
- Due to the width of some implements, use extra caution on highways, farm roads, and when approaching gates.
- Always be sure the implement is in the proper position for transport.
- Keep alert and watch the front as well as the rear when working with the implement.

OWNER'S MANUAL

**MODEL NO.
HK-102**

**WHEN ORDERING
REPAIR PARTS, ALWAYS
GIVE THE FOLLOWING
INFORMATION:**

1. PART NUMBER
2. PART DESCRIPTION
3. MODEL NUMBER
4. NAME OF ITEM

JANUARY 1999

Please work, drive, play and live each day with care and concern for your safety and that of your family and fellow citizens.

**MAKE EVERY DAY
A HOLIDAY FROM ACCIDENTS**

3 PT. HITCH ADAPTER KIT
For IHC/Farmall Models C, Super C, 200, 230

WORKSAVER LIMITED WARRANTY

W orksaver warrants its implements, parts and accessories to be free from defects in materials and workmanship for a period of six (6) months from date of purchase. Upon written approval, W orksaver will repair or exchange without charge any part, which upon examination by W orksaver or its authorized agent, shall disclose to be defective.

This does not apply to (1) parts that have worn out in normal use, (2) parts broken because of improper assembly or operation by the customer, (3) parts accidentally damaged, (4) failure of parts traceable to improper care, (5) parts failing through use of implement for purposes other than those for which it was designed.

The obligations assumed by W orksaver and the limitations expressed herein are in lieu of all other warranties expressed or implied.

W O R K S A V E R , I N C .

P.O. BOX 100 LITCHFIELD, IL 62056-0100 (217) 324-5973

WEB: <http://www.worksaver.com> E-MAIL: sales@worksaver.com

WS-HK009-OG

Free Manuals Download Website

<http://myh66.com>

<http://usermanuals.us>

<http://www.somanuals.com>

<http://www.4manuals.cc>

<http://www.manual-lib.com>

<http://www.404manual.com>

<http://www.luxmanual.com>

<http://aubethermostatmanual.com>

Golf course search by state

<http://golfingnear.com>

Email search by domain

<http://emailbydomain.com>

Auto manuals search

<http://auto.somanuals.com>

TV manuals search

<http://tv.somanuals.com>