



# **X-Micro EPIC MP3 Player**

*MP3 Music Player+Digital Voice Recorder+USB Flash Drive*

## **User Manual**

V1.2

## Table of Contents

1.	Introduction	
1.1	About X-Micro EPIC MP3 Player	2
1.2	Features	2
2.	Illustration of function keys and LCD display	3-4
3.	Quick start	5
4.	Function and operation	
4.1	MP3 / WMA playback	6
4.2	Recording operation	7
4.3	Selection / Fast forward / fast backward	8
4.4	Equalizer settings	9
4.5	Volume control	9
4.6	Repeat section	10
4.7	Menu operation	10
4.8	Connect to computer	11
4.9	Key lock	12
5.	How to Install / Modify / Repair / Remove driver	
5.1	Windows 98 / 98SE Installation	13
5.2	Windows 2000 / ME / XP Installation	15
6.	Remove X-Micro EPIC MP3 Player from computer	15-16
7.	Linux 2.4.0 + / Mac 8.6 + Installation	16
8.	MobileMail Function and Installation	16-17
	<b>IMPORTANT NOTICES</b>	17
	<b>Disclaimer</b>	18

---

## 1. Introduction

---

### 1.1 About X-Micro EPIC MP3 Player

X-Micro EPIC MP3 Player is the brand new multi-function MP3/WMA player from our EPIC series. Compared with the single-function MP3 Player, X-MICRO EPIC MP3 PLAYER owns not only the stylish outlook with an EQ built in LCD, but also a high quality digital voice recording function. We successfully combined well-known USB flash drive, popular MP3/WMA player and delicately designed digital voice recorder in one stick. With two AAA batteries, you can take advantage of 15 hours non-stop playing time. X-MICRO EPIC MP3 PLAYER is suitable for each occasion — meeting, data storage and of course, music enjoyment. It is absolutely your best choice from various consumer products.

### 1.2 Features

- Current available: 128MB / 256MB / 512MB
- Supports USB specification revision 1.1
- Transferring rate up to 12Mbit per second at "Full Speed".
- Supports power saving mode to reduce power consumption while not playing X-Micro EPIC MP3 Player.
- Supports Windows 2000, ME, XP, Mac OS 8.6 or above and Linux 2.4.0 or above without device driver.
- Supports Windows 98/98SE with device driver.
- LED indicator when X-Micro EPIC MP3 Player is working.
- Key lock / write protect switch.
- Hot Plug & Play.
- Durable solid-state storage – data retention for at least 10 years.
- Erase Cycles: 100,000 times
- No external power is required - DC 4.5V ~ 5.5V from USB port.
- Low Power consumption : Write 39.1mA ~ 39.4mA / Read 35.0mA ~ 36.1mA.
- Support music format: MP3 / WMA
- Earphone jack: 3.5 mm
- Audio output: 5mW + 5mW
- Output frequency range: 20HZ – 20KHZ
- Power supply: by two of AAA battery.
- Continuous playing time: more than 15hours.
- EQ choices: Normal / Rock / Classic / POP / Jazz
- LCD display: 13mm (H) x 30mm (L)
- Digital voice record in ADPCM 32kbps (WAV) format through internal microphone.
- Repeat read function (A - B).
- Unit weight: approximate 30g (not including battery)

-CE and FCC certificate of approval.

---

## 2. Illustration of function keys and LCD display

---

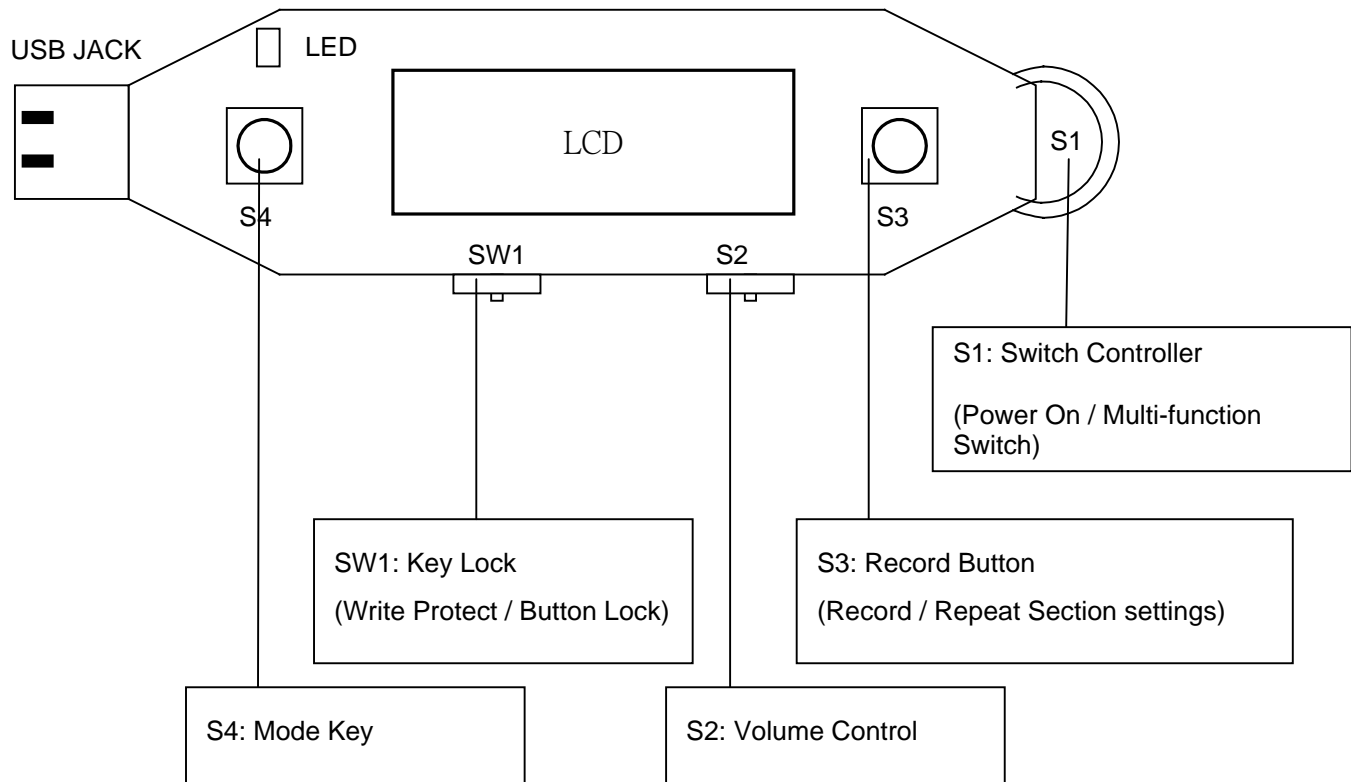

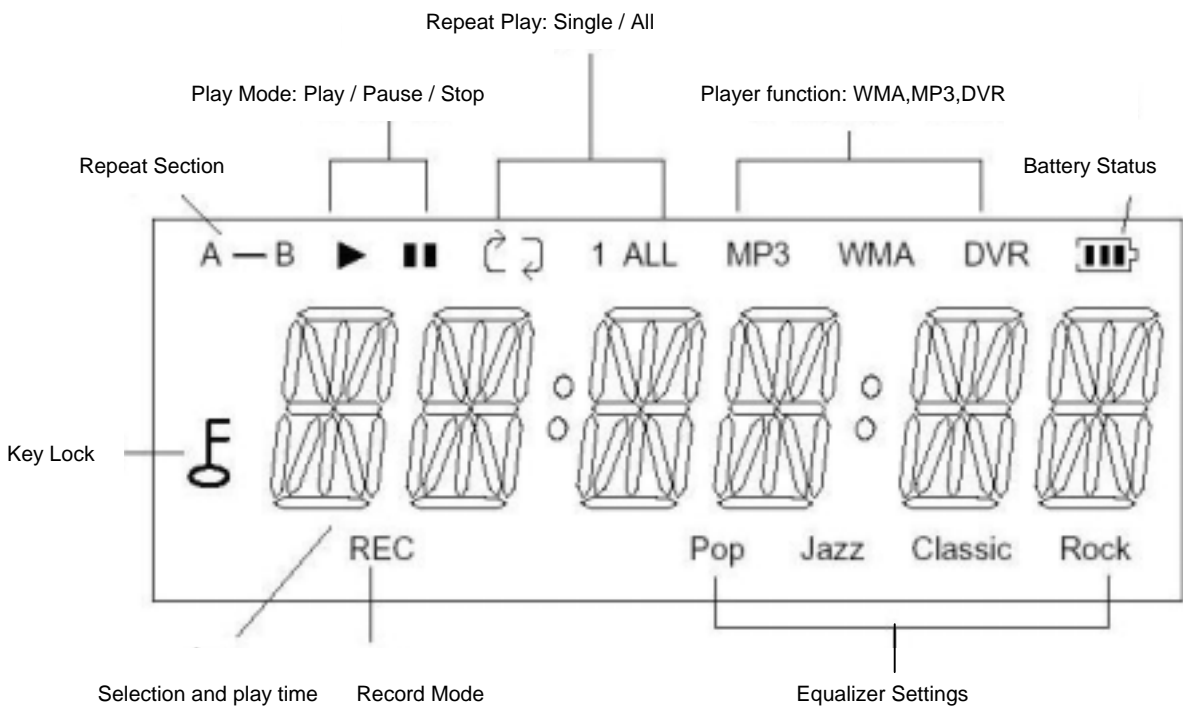

---

## 3. Quick Start

---

### MP3/WMA Playback

Steps:

1. Press 3 seconds on **Switch Controller** to turn on the player.
2. LED will blink when you press **Switch Controller**. After blinking, LCD will show 「HELLO」.
3. If there are already MP3 or WMA files in the Flash Memory, the LCD will show 「01 0:00」, and the LED will light up. To begin the playback of MP3 or WMA file, press again **Switch Controller**.

### Record Operation

Steps:

1. Press 3 seconds on **Switch Controller** to turn on the player.
2. Press **Record Button** to enter record mode. LED will blink, and the "REC" icon in the display will blink, too. The time in the display will increase from 「0:00」.
3. Press again **Record Button** to stop record and then enter the record playback mode. The "REC" icon will disappear and the "DVR" icon will show up in the display. LED will light off.
4. To play the previous recorded WAV files, press **Switch Controller** in record playback mode.

### Connecting to PC

Steps:

1. Use USB cable to connect to PC's USB port, the player will be turned on automatically.
2. The USB indication will show up in the display. While connecting to PC, the display will show "--USB--", and LED will blink.
4. Once the connection is completed, LED will light up, and "--PC--" will appear in the display. You will see a "Removable Disk" in My Computer.

## 4. Function & Operation

### 4.1. MP3/WMA Playback

- (1) Press **Switch Controller** to turn on the player. LED will blink.  
The display will show 「HELLO」 as **Figure 4.1.1**.



Figure 4.1.1

- (2) The player will automatically read the content of the Flash Memory. If there are already MP3 or WMA files in the Flash Memory, the display will show as **Figure 4.1.2**.

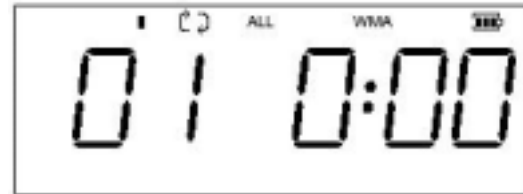

Figure 4.1.2

- (3) Press **Switch Controller** to start playing the first selection.  
The music format such as MP3 or WMA will be indicated in the display. LED will keep blinking and the selection number as well as the playing time will also be indicated in the display. (**Figure 4.1.3**)



Figure 4.1.3

- (4) To pause during playback, press **Switch Controller**, and the pause symbol will appear. Elapsed playing time will be paused, too. (**Figure 4.1.4**). LED will light up instead of flashing.



Figure 4.1.4

- (5) Press **Switch Controller** to resume playback.

- (6) To stop playing, press **Switch Controller** for 2 seconds, LED will light up instead of blinking, and the playing time will be reset to zero. (**Figure 4.1.5**)

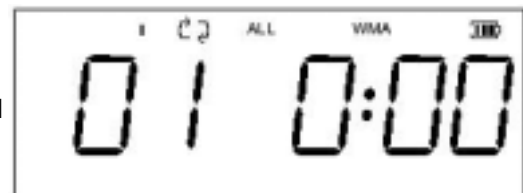

Figure 4.1.5

- (7) Press **Switch Controller** again for 2 seconds in stop mode, the player will turn off and the display will appear 「OFF」.

(**Figure 4.1.6**)

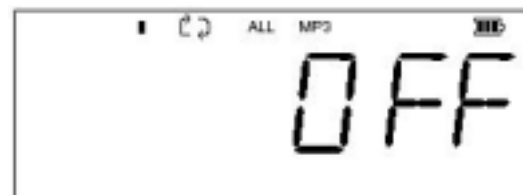

Figure 4.1.6

(8) If no operations occurred for 60 seconds in stop mode, the player will turn off automatically.

#### 4.2. Recording Operation

(1) Press **Record Button** to start recording. LED will keep blinking, and the "REC" icon will flash, too. Elapsed recording time will be shown in the display. **(Figure 4.2.1)**



Figure 4.2.1

(2) To stop record, press **Record Button** again. LED will light off, and the beginning of the playing time will be indicated in the display. "DVR" icon turns up while "REC" icon disappears. **(Figure 4.2.2)**

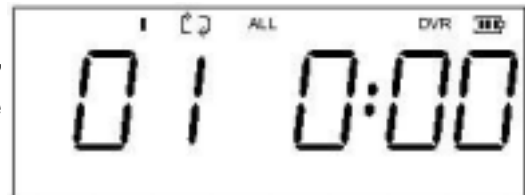

Figure 4.2.2

※ To pause the record, press **Switch Controller**. To resume it, press **Switch Controller** again.

(3) To play the previous recorded WAV files in stop mode, press **Switch Controller**. The display will show the selection number and the playing time. **(Figure 4.2.3)**

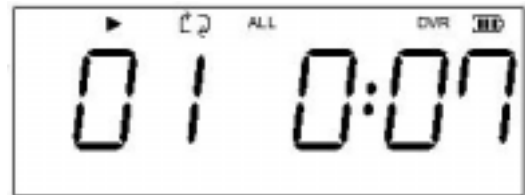

Figure 4.2.3

※ To switch between MP3 and record mode in stop mode, press **Mode Key**.

(4) Press **Switch Controller** to pause the playback, playing time will be paused as well. **(Figure 4.2.4)**

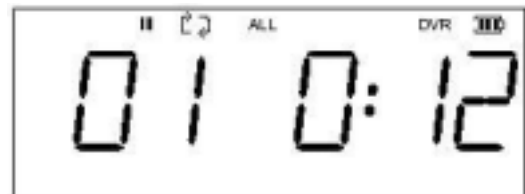

Figure 4.2.4

(5) Press **Switch Controller** to resume playback.

(6) If the space in the Flash Memory is used up during record, LCD will show "FULL" **(Figure 4.2.5)** and record will stop.

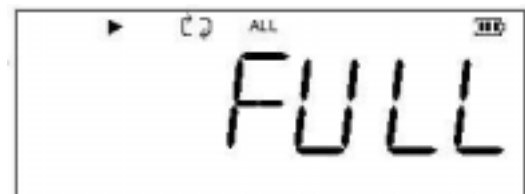

Figure 4.2.5

※ Press any key to go back to record stop mode.

※ File deletion, selection, fast forward and fast backward in record mode are the same as in MP3 / WMA mode.



### 4.3. Selection / Fast Forward / Fast Backward

- (1) To select during playback, slide **Switch Controller** upward once for the previous file, and downward for the next one. Playback will start from the beginning of the selection.

**(Figure 4.3.1)**

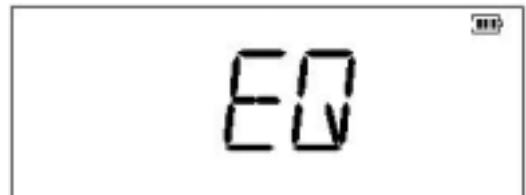

**Figure 4.3.1**

- (2) To select in stop mode, slide **Switch Controller** until the desired selection shows up in the display. Press **Switch controller** to start play.
- (3) To locate a particular point in a selection, Slide **Switch Controller** up for fast backward and down for fast forward. Playing time in the display will change accordingly. Release **Switch Controller** and the playback will start from the time indicated in the display.

### 4.4. Equalizer Settings

- (1) Press **Mode Key** for 2 seconds until "EQ" appears in the display. **(Figure 4.4.1)** Press **Switch Controller** to enter the menu of **Equalizer Settings**.



**Figure 4.4.1**

- (2) Slide **Switch Controller** to select the following settings:  
Normal → POP → JAZZ → CLASSICAL → ROCK → Normal.  
Press **Switch Controller** again for confirmation, then the icon will come out in the display. **(Figure 4.4.2)**



Figure 4.4.2

**4.5. Volume Control**

(1) During playback, slide **Volume Controller** to the left to turn down and right to turn up the volume which will be shown in the display. **(Figure 4.5.1)** -- Sound Level: 0 ~ 63



Figure 4.5.1

(2) To continuously increase or decrease the volume, slide **Volume Controller** to the right / left and hold. To stop volume control, stop sliding **Volume Controller** and the LCD will resume the normal display.

**4.6. Repeat Section**

(1) During playback, press **Record Button** once to enter the repeat read mode. The start point A will be marked. "A-B" icon will appear and "B" starts flashing. **(Figure 4.6.1)**



Figure 4.6.1

(2) Press **Record Button** again to mark the end point "B" whose icon will stop flashing. A→B repeat read will go on. **(Figure 4.6.2)**



Figure 4.6.2

※ If point "B" is not marked until the end of the selected MP3 file, the playback of the next selection will start and point "A" will disappear.

(3) During A→B repeat read, press **Record Button** again to leave this mode. Normal playback will resume from point "B", and the "A-B" icon will disappear from the display. **(Figure 4.6.3)**



Figure 4.6.3

※ During A→B repeat read, press **Switch Controller** once to pause the repeat read, press **Switch controller** once again to resume it.

## 4.7. Menu Operation

(1) In stop status, press **Mode Key** to enter Menu selection

which contains 3 functions:

- (i) Equalizer Settings (EQ)
- (ii) Playback Settings (REP)
- (iii) File Deletion (DEL)

To select, slide **Switch Controller** up and down and the function will change cyclically as follows:

EQ → REP → DEL → EQ. Press **Switch Controller** again to confirm the selection. **(Figure 4.7.1)**

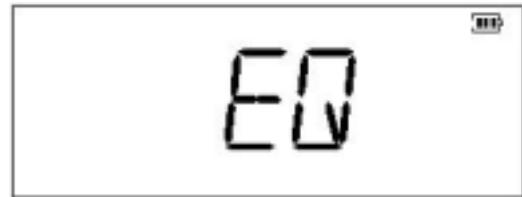

Figure 4.7.1

(2) EQ Menu: Under Equalizer Settings, slide **Switch Controller**

to select among 5 settings with the following cycle:

Normal → POP → JAZZ → CLASSICAL → ROCK → Normal

Press **Switch Controller** to confirm the setting. **(Figure 4.7.2)**



Figure 4.7.2

(3) REP Menu **(Figure 4.7.3)**: Under playback settings, slide **Switch Controller** to select among the following 3 settings:

- (i) Repeat ALL: repeat all the selections
- (ii) Repeat 1: repeat a single selection
- (iii) NO Repeat: to cancel repeat

Slide **Switch Controller** to select among 3 settings with the following cycle:

Repeat ALL → Repeat 1 → NO Repeat → Repeat ALL

Press **Switch Controller** again to confirm the setting.

**(Figure 4.7.4)**

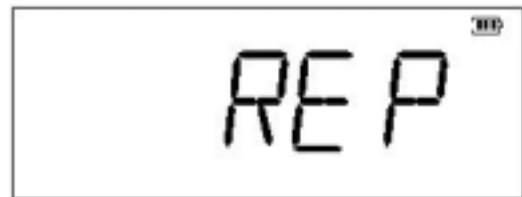

Figure 4.7.3

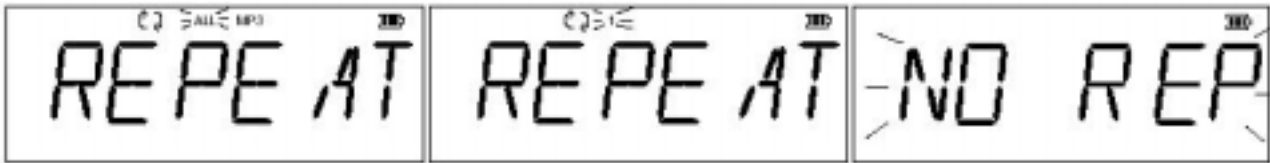

Figure 4.7.4

- (4) DEL Menu(**Figure 4.7.5**): Under file deletion, slide **Switch Controller** to select among the deletion of a single file or all files with the following cycle:



Figure 4.7.5

DEL ONE → DEL ALL → DEL ONE

Press **Switch Controller** again to confirm the setting.

(**Figure 4.7.6**)

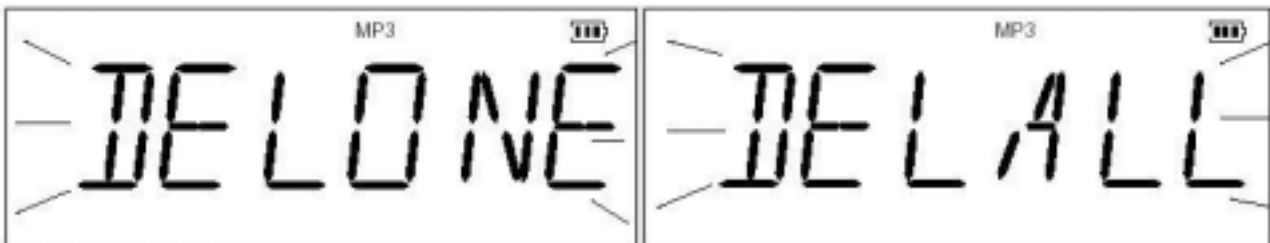

Figure 4.7.6

- (5) To delete single file: Choose the file to be delete then select DEL Mode, select DEL ONE and LCD will display “DEL\_\_\_” (**Figure 4.7.7**). Press **Switch Controller** to confirm deletion.



Figure 4.7.7

#### 4.8. Connect to Computer

- (1) Use the USB cable to connect to PC's USB port, and the display will appear “--USB--”.
- (3) During USB operations (including connection with PC, file copy / delete, Flash Memory format), the LED will blink and “--USB--” will appear in the display. (**Figure 4.8.1**)

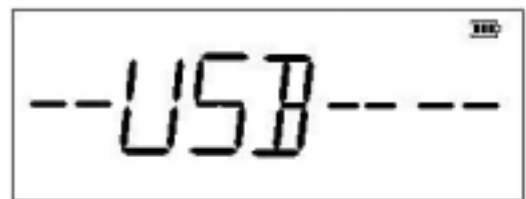

Figure 4.8.1

- (4) Once the connection is completed, LED will light up, and “---PC---” will appear in the display. You will see a “Removable Disk” in My Computer. (**Figure 4.8.2**)

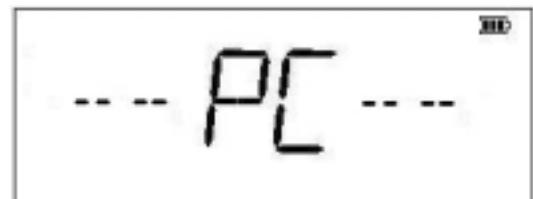

Figure 4.8.2

(5) Remove the unit from the USB port of PC to return the player back to stop mode, and the removable disk will disappear from My Computer. Playing time of the 1<sup>st</sup> file will be displayed in the display. **(Figure 4.8.3)**

※ When file copy / delete through PC is finished, make sure the USB operation has come to a complete stop and the display appears "--PC--" before unplugging the player from PC's USB port. Otherwise it may result in damages to the files in the Flash Memory.



Figure 4.8.3

#### 4.9. Key Lock

(1) Player status: click switch toward to **Switch Controller**, all buttons and switch controller will be locked and stop working. The display will appear symbol "Ⓜ". **(Figure 4.9.1)**



Figure 4.9.1

(2) Removable disk status: click switch toward to **Switch Controller**, writing will be protected. **(Figure 4.9.2)**

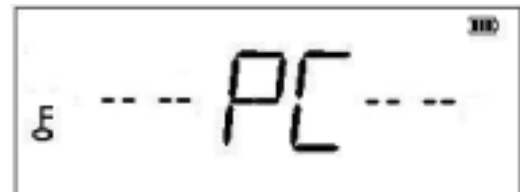

Figure 4.9.2

(3) If you try to press any button or switch, the display will appear "LOCK" to remind users. **(Figure 4.9.3)**

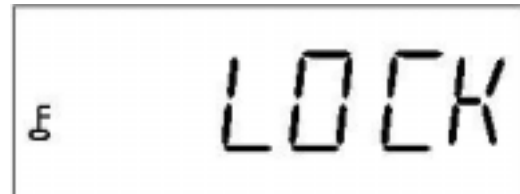

Figure 4.9.3

---

## 5. How to install driver

---

### 5.1 Windows 98/98SE Installation :

- (1) Plug X-Micro EPIC MP3 Player into USB port. System will detect one new hardware and search for proper driver to install.



- (2) Choose the first recommend to install.



- (3) Choose setting up from CD ROM.



(4) To execute installation by press “Next”.



(5) Press “Finish” to complete installation.



## 5.2 Windows ME / Windows 2000 / XP Installation

For these three operating systems, ***NO Driver is needed***, because Windows has built-in driver to support USB removable disk. Simply plug X-Micro EPIC MP3 Player into the USB port and it will be recognized by the system. System will setup X-Micro EPIC MP3 Player automatically without any further installation of driver.

Once installation is completed, you will see a “Removable Disk” drive in My Computer.

## 6. Remove X-Micro EPIC MP3 Player from computer

After using X-Micro EPIC MP3 Player, please choose one of the methods below according to your Operating System to remove X-Micro EPIC MP3 Player from USB port:

**Windows 98/98SE :** You could unplug X-Micro EPIC MP3 Player from the USB port directly once the LED stops blinking and its icon would disappear automatically.

**Windows Me/2000/XP :** Click the icon of X-Micro EPIC MP3 Player at the right down corner, and a “Stop USB Mass Storage Device-Drive(H:)” menu appears (Fig.6.1). Click the menu, and the below window appears telling you “the ‘USB Mass Storage Device’ device can be safely removed from the system”. Click “OK” to close the window (Fig.6.2), then you can safely remove X-Micro EPIC MP3 Player.

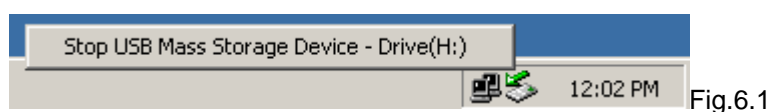



## 7. Linux 2.4.0 + / Mac 8.6 + Installation

Again, **No Driver is required** for these two operating systems. Simply plug the X-Micro EPIC MP3 Player into the USB port and the system will automatically find X-Micro EPIC MP3 Player. After using X-Micro EPIC MP3 Player, you could unplug X-Micro EPIC MP3 Player from the USB port directly once the LED stops blinking, then its icon would disappear automatically. **For Linux user, please refer to Important Notices.**

### Important Notices :

- (i) In OS Windows 98/98SE, if you don't set up installation firstly, system will ask you to put driver disk for running installation. Be sure to unplug X-Micro EPIC MP3 Player before running setup programs. If you install the driver with X-Micro EPIC MP3 Player plugged, it may cause setup error or failure.
- (ii) If you plug X-Micro EPIC MP3 Player into the USB port. System can find X-Micro EPIC MP3 Player, but you are unable to access it. Please **FORMAT** X-Micro EPIC MP3 Player.
- (iii) Before unplugging X-Micro EPIC MP3 Player from the USB port in **Windows ME/2000/XP**, make sure you go to the right hand bottom of the screen to stop the USB device. Otherwise, it may result in losing data that you have saved on X-Micro EPIC MP3 Player. (Please refer to 6.2.)
- (iv) Linux uses a so-called "USB Manager", which does automatically load kernel modules (drivers) for USB devices. It loads only drivers for devices that are present on the USB bus to reduce memory usage. Per default, the USB Manager does not come with the USB Drive pre-configured. However, you can easily configure the USB Manager to automatically recognize the USB Drive yourself. Just add the following to the configuration file,

```
usbmgr.conf (usually in /etc/usbmgr): vendor 0x11E9 product 0x1004 module scsi_mod,  
usb-storage
```

This line identifies the USB Drive and tells the USB Manager to load the SCSI as well as the USB storage module. The SCSI module is needed in order to talk to both SCSI and USB storage devices, while the usb-storage module is needed to talk to USB storage devices.

Do not forget to either reload the USB Manager's configuration or to restart the USB Manager (for instance, do as root: /etc/init.d/usbmgr reload).

### Disclaimer

All the information in this document is subject to change without prior notice. The manufacturer does not make any representations or any warranties (implied or otherwise) regarding the accuracy and completeness of this document and shall in no event be liable for any loss of profit or any other commercial damage, including but not limited to special, incidental, consequential, or other damages.

No part of this document may be reproduced or transmitted in any form by any means without the express written permission of the manufacturer.

All brand names and product names used in this document are trademarks or registered trademarks of their respective holders.

**X - MICRO**  
*Plug & fly*

[www.x-micro.com](http://www.x-micro.com)

## Free Manuals Download Website

<http://myh66.com>

<http://usermanuals.us>

<http://www.somanuals.com>

<http://www.4manuals.cc>

<http://www.manual-lib.com>

<http://www.404manual.com>

<http://www.luxmanual.com>

<http://aubethermostatmanual.com>

Golf course search by state

<http://golfingnear.com>

Email search by domain

<http://emailbydomain.com>

Auto manuals search

<http://auto.somanuals.com>

TV manuals search

<http://tv.somanuals.com>