

X-Micro

WLAN 11b Access Point

User's Manual

Terminology

ANSI	American National Standards Institute
AP	Access Point
CCK	Complementary Code Keying
CSMA/CA	Carrier Sense Multiple Access/ Collision Avoidance
CSMA/CD	Carrier Sense Multiple Access/ Collision Detection
DHCP	Dynamic Host Configuration Protocol
DSSS	Direct Sequence Spread Spectrum
FCC	Federal Communications Commission
FTP	File Transfer Protocol
IEEE	Institute of Electrical and Electronic Engineers
IP	Internet Protocol
ISM	Industrial, Scientific and Medical
LAN	Local Area Network
MAC	Media Access Control
NAT	Network Address Translation
NT	Network Termination
PSD	Power Spectral Density
RF	Radio Frequency
SNR	Signal to Noise Ratio
SSID	Service Set Identification
TCP	Transmission Control Protocol
TFTP	Trivial File Transfer Protocol
WEP	Wired Equivalent Privacy
WLAN	Wireless Local Area Network

Table of Contents

TERMINOLOGY I

1 INTRODUCTION..... 1

1.1 PACKAGE CONTENTS 1

1.2 PRODUCT SPECIFICATIONS 1

1.3 PRODUCT FEATURES 2

1.4 TOP PANEL DESCRIPTION 2

1.5 REAR PANEL DESCRIPTION..... 3

2 INSTALLATION 4

2.1 HARDWARE INSTALLATION 4

2.2 SOFTWARE INSTALLATION..... 4

3 SOFTWARE CONFIGURATION 5

3.1 PREPARE YOUR PC TO CONFIGURE X-MICRO WLAN 11B ACCESS POINT 5

3.2 CONNECT TO X-MICRO WLAN 11B ACCESS POINT 7

3.3 MANAGEMENT AND CONFIGURATION ON X-MICRO WLAN 11B ACCESS POINT 7

3.3.1 STATUS..... 7

3.3.2 WIRELESS BASIC SETTINGS 8

3.3.3 WIRELESS ADVANCED SETTINGS 9

3.3.4 WIRELESS SECURITY SETUP..... 11

3.3.5 WIRELESS ACCESS CONTROL..... 12

3.3.6 LAN INTERFACE SETUP 14

3.3.7 STATISTICS 15

3.3.8 UPGRADE FIRMWARE 16

3.3.9 SAVE /RELOAD SETTINGS..... 17

3.3.10 PASSWORD SETUP 17

4 FREQUENTLY ASKED QUESTIONS (FAQ)..... 19

4.1 WHAT AND HOW TO FIND MY PC'S IP AND MAC ADDRESS? 19

4.2 WHAT IS WIRELESS LAN? 19

4.3 WHAT ARE ISM BANDS? 19

4.4 HOW DOES WIRELESS NETWORKING WORK?..... 19

4.5 WHAT IS BSSID? 20

4.6	WHAT IS ESSID?	20
4.7	WHAT ARE POTENTIAL FACTORS THAT MAY CAUSES INTERFERENCE?	21
4.8	WHAT ARE THE OPEN SYSTEM AND SHARED KEY AUTHENTICATIONS?	21
4.9	WHAT IS WEP?	21
4.10	WHAT IS FRAGMENT THRESHOLD?.....	21
4.11	WHAT IS RTS (REQUEST TO SEND) THRESHOLD?	22
4.12	WHAT IS BEACON INTERVAL?.....	22
4.13	WHAT IS PREAMBLE TYPE?	23
4.14	WHAT IS SSID BROADCAST?	23
5	CONFIGURATION EXAMPLES.....	24
5.1	EXAMPLE ONE – DHCP ON THE LAN.....	24
5.2	EXAMPLE TWO – FIXED IP ON THE LAN.....	26

1 Introduction

X-Micro WLAN 11b Access Point is a portal that can act as the connection point between the Ethernet CSMA/CD protocol and the wireless CSMA/CA protocol. The Access Point can be easily integrated into your existing wireless network. In large installations, the roaming functionality provided by multiple Access Points allows wireless users to move freely throughout the facility while maintaining seamless, uninterrupted access to the network.

This document describes the steps required for the initial IP address assign and other AP configuration. The description includes the implementation of the above steps.

Notice: It will take about 25 seconds to complete the boot up sequence after powered on X-Micro WLAN 11b Access Point; all LEDs are blank while booting except the Power LED, and after that the WLAN Activity LED will be flashing to show the WLAN interface is enabled and working now.

1.1 Package contents

The package of X-Micro WLAN 11b Access Point includes the following items,

- ✓ X-Micro WLAN 11b Access Point
- ✓ The AC to DC power adapter
- ✓ The Documentation CD

1.2 Product Specifications

Product Name	X-Micro WLAN 11b Access Point
Standard	802.11b(Wireless), 802.3(10BaseT), 802.3u(100BaseT)
Data Transfer Rate	11Mbps(Wireless), 100Mbps(Ethernet)
Modulation Method	DBPSK/ DQPSK/ CCK
Frequency Band	2.4GHz – 2.497GJz ISM Band, DSSS
RF Output Power	< 17 dBm
Receiver Sensitivity	11Mbps better than 8% PER @ -78 dBm
Operation Range	30 to 300 meters (depend on surrounding)
Antenna	External Antenna
LED	Power, Active (WLAN), Act/Link (Ethernet)
Security	64 bit/ 128 bit WEP, MAC address filtering
LAN interface	One 10/100BaseT with RJ45 connector
Power Consumption	7.5V DC Power Adapter

Dimension	120 * 75 * 34 mm
Operating Temperature	0 – 50°C ambient temperature
Storage Temperature	-20 - 70°C ambient temperature
Humidity	5 to 90 % maximum (non-condensing)

1.3 Product Features

- Complies with IEEE 802.11b standard for 2.4GHz Wireless LAN.
- Supports 11Mbps data transfer rate with automatic fallback to 5.5M, 2M and 1Mbps.
- Supports bridging function between wireless and wired Ethernet interfaces.
- Supports 64-bit and 128-bit WEP encryption/decryption function to protect the wireless data transmission.
- Supports IEEE 802.3x full duplex flow control on 10/100M Ethernet interface.
- Supports DHCP client for Ethernet LAN interface auto IP address assignment.
- Supports clone MAC address function.
- Supports WEB based management and configuration.

1.4 Top Panel Description

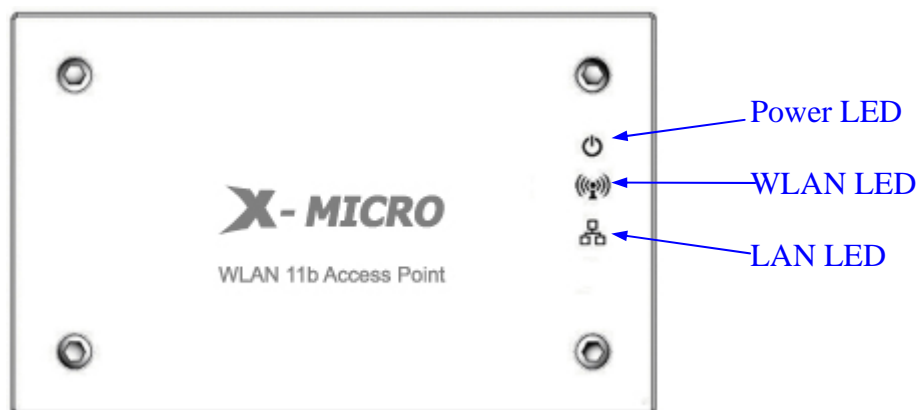





Figure 1 –X-Micro WLAN 11b Access Point Top Panel

LED Indicator	State	Description
1. Power LED 	On	X-Micro WLAN 11b AP is powered on.
	Off	X-Micro WLAN 11b AP is powered off.
2. WLAN Activity LED 	Flashing	Data is transmitting or receiving on the antenna.
	Off	No data is transmitting or receiving on the antenna.
3. LAN LINK/ACT LED 	Flashing	Data is transmitting or receiving on the LAN interface.
	Off	No connection is established on LAN interface.

1.5 Rear Panel Description

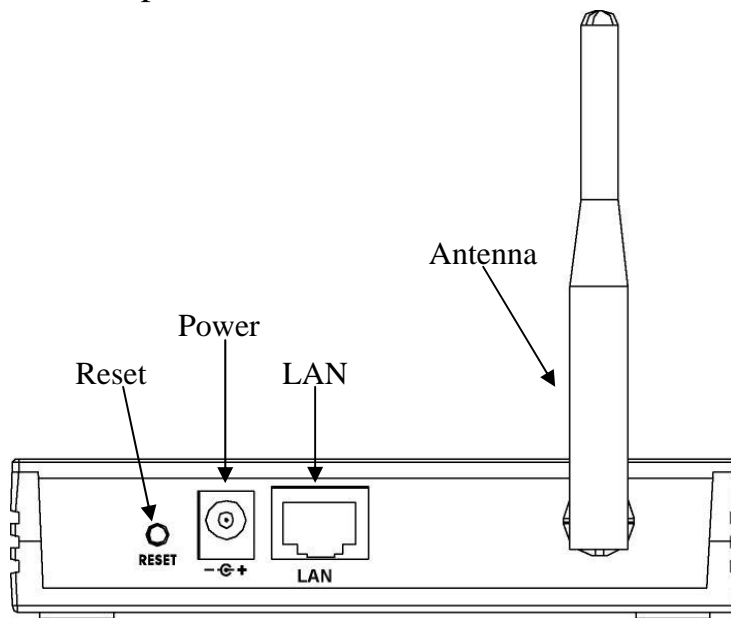

Figure 2 – X-Micro WLAN 11b Access Point Rear Panel

Interfaces	Description
1. Reset	Push continually the reset button 5 seconds to reset the configuration parameters to factory defaults.
2. Power	The power jack allows an external DC +7.5 V power supply connection. The external AC to DC adaptor provide adaptive power requirement to the WLAN AP.
3. LAN	The RJ-45 socket allows LAN connection through a Category 5 cable. Support auto-sensing on 10/100M speed and half/ full duplex; comply with IEEE 802.3/ 802.3u respectively.
4. Antenna	The Wireless LAN Antenna.

2 Installation

2.1 Hardware Installation

Step One: Place X-Micro WLAN 11b Access Point to the best optimum transmission location.

The best transmission location for your X-Micro WLAN 11b Access Point is usually at the geographic center of your wireless network, with line of sight to all of your mobile stations.

Step Two: Connect X-Micro WLAN 11b Access Point to your wired network.

Connect X-Micro WLAN 11b Access Point by category 5 Ethernet cable to your switch/ hub/ router/ xDSL modem or cable modem. A straight-through Ethernet cable with appropriate cable length is needed.

Step Three: Supply DC power to X-Micro WLAN 11b Access Point.

Use only the AC/DC power adapter supplied with X-Micro WLAN 11b Access Point; it may occur damage by using a different type of power adapter.

The hardware installation finished.

2.2 Software Installation

- There are no software drivers, patches or utilities installation needed, but only the configuration setting. Please refer to chapter 3 for software configuration.

3 Software configuration

There are web based management and configuration functions allowing you to have the jobs done easily.

X-Micro WLAN 11b Access Point is delivered with the following factory default parameters.

Default IP Address: **192.168.1.254**

Default IP subnet mask: **255.255.255.0**

WEB login User Name: **<empty>**

WEB login Password: **<empty>**

3.1 Prepare your PC to configure X-Micro WLAN 11b Access Point

For OS of Microsoft Windows 95/ 98/ Me:

1. Click the **Start** button and select **Settings**, then click **Control Panel**. The **Control Panel** window will appear.
Note: Windows Me users may not see the Network control panel. If so, **select View all Control Panel options** on the left side of the window
2. Move mouse and double-click the right button on **Network** icon. The **Network** window will appear.
3. Check the installed list of **Network Components**. If TCP/IP is not installed, click the **Add** button to install it; otherwise go to step 6.
4. Select **Protocol** in the **Network Component Type** dialog box and click **Add** button.
5. Select **TCP/IP** in **Microsoft** of **Select Network Protocol** dialog box then click OK button to install the TCP/IP protocol, it may need the Microsoft Windows CD to complete the installation. Close and go back to **Network** dialog box after the TCP/IP installation.
6. Select **TCP/IP** and click the **properties** button on the **Network** dialog box.
7. Select **Specify an IP address** and type in values as following example.
 - ✓ IP Address: **192.168.1.1**, any IP address within 192.168.1.1 to 192.168.1.253 is good to connect the Wireless LAN Access Point.
 - ✓ IP Subnet Mask: **255.255.255.0**
8. Click OK and reboot your PC after completes the IP parameters setting.

For OS of Microsoft Windows 2000, XP:

1. Click the **Start** button and select **Settings**, then click **Control Panel**. The **Control Panel** window will appear.
2. Move mouse and double-click the right button on **Network and Dial-up**

Connections icon. Move mouse and double-click the **Local Area Connection** icon. The **Local Area Connection** window will appear. Click **Properties** button in the **Local Area Connection** window.

3. Check the installed list of **Network Components**. If TCP/IP is not installed, click the **Add** button to install it; otherwise go to step 6.
4. Select **Protocol** in the **Network Component Type** dialog box and click **Add** button.
5. Select **TCP/IP** in **Microsoft** of **Select Network Protocol** dialog box then click OK button to install the TCP/IP protocol, it may need the Microsoft Windows CD to complete the installation. Close and go back to **Network** dialog box after the TCP/IP installation.
6. Select **TCP/IP** and click the **properties** button on the **Network** dialog box.
7. Select **Specify an IP address** and type in values as following example.
 - ✓ IP Address: **192.168.1.1**, any IP address within 192.168.1.1 to 192.168.1.253 is good to connect the Wireless LAN Access Point.
 - ✓ IP Subnet Mask: **255.255.255.0**
8. Click OK to completes the IP parameters setting.

For OS of Microsoft Windows NT:

1. Click the **Start** button and select **Settings**, then click **Control Panel**. The **Control Panel** window will appear.
2. Move mouse and double-click the right button on **Network** icon. The **Network** window will appear. Click **Protocol** tab from the **Network** window.
3. Check the installed list of **Network Protocol** window. If TCP/IP is not installed, click the **Add** button to install it; otherwise go to step 6.
4. Select **Protocol** in the **Network Component Type** dialog box and click **Add** button.
5. Select **TCP/IP** in **Microsoft** of **Select Network Protocol** dialog box then click OK button to install the TCP/IP protocol, it may need the Microsoft Windows CD to complete the installation. Close and go back to **Network** dialog box after the TCP/IP installation.
6. Select **TCP/IP** and click the **properties** button on the **Network** dialog box.
7. Select **Specify an IP address** and type in values as following example.
 - ✓ IP Address: **192.168.1.1**, any IP address within 192.168.1.1 to 192.168.1.253 is good to connect the Wireless LAN Access Point.
 - ✓ IP Subnet Mask: **255.255.255.0**
8. Click OK to completes the IP parameters setting.

3.2 Connect to X-Micro WLAN 11b Access Point

Open a WEB browser, i.e. Microsoft Internet Explorer, then enter 192.168.1.254 on the URL to connect X-Micro WLAN 11b Access Point.

3.3 Management and configuration on X-Micro WLAN 11b Access Point

3.3.1 Status

This page shows the current status and some basic settings of the device, includes system, wireless and TCP/IP configuration information.

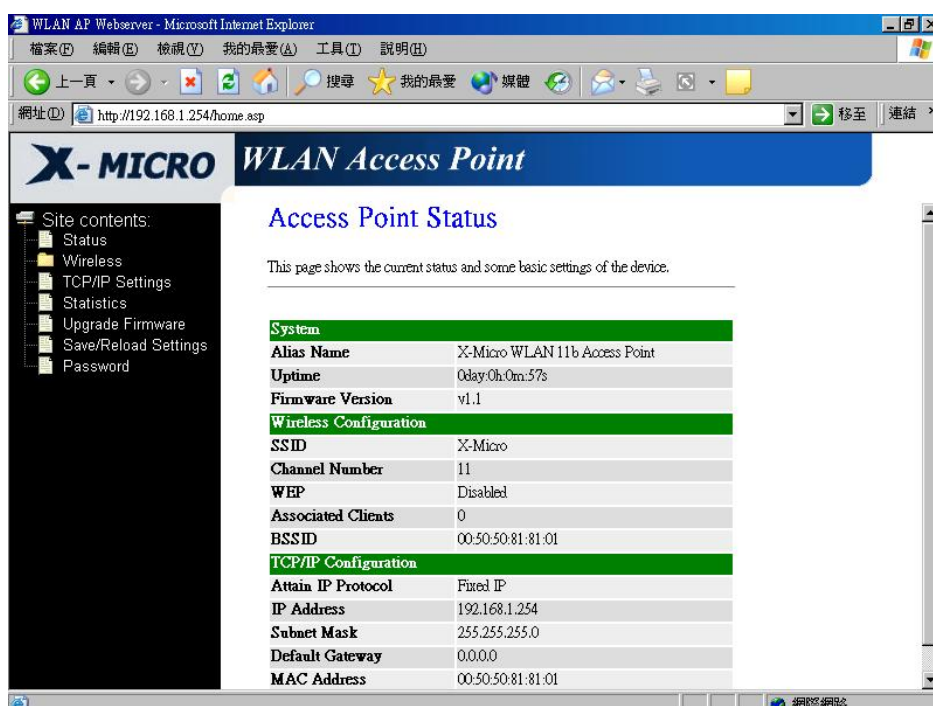

Screenshot – Status

Item	Description
<u>System</u>	
<i>Alias Name</i>	It shows the alias name of X-Micro WLAN 11b Access Point.
<i>Uptime</i>	It shows the duration since X-Micro WLAN 11b Access Point is powered on.
<i>Firmware version</i>	It shows the firmware version of X-Micro WLAN 11b Access Point.
<u>Wireless configuration</u>	

<i>SSID</i>	It shows the SSID of X-Micro WLAN 11b Access Point. The SSID is the unique name of X-Micro WLAN 11b Access Point and shared among its service area, so all devices attempts to join the same wireless network can identify it.
<i>Channel Number</i>	It shows the wireless channel connected currently.
<i>WEP</i>	It shows the status of WEP encryption function.
<i>Associated Clients</i>	It shows the number of connected clients (or stations, PCs).
<i>BSSID</i>	It shows the BSSID address of X-Micro WLAN 11b Access Point. BSSID is a six-byte address.
<u>LAN configuration</u>	
<i>Attain IP Protocol</i>	It shows how X-Micro WLAN 11b Access Point gets the IP address. The IP address can be set manually to a fixed one or set dynamically by DHCP server.
<i>IP Address</i>	It shows the IP address of X-Micro WLAN 11b Access Point.
<i>Subnet Mask</i>	It shows the IP subnet mask of X-Micro WLAN 11b Access Point.
<i>Default Gateway</i>	It shows the default gateway setting for the outgoing data packets.
<i>MAC Address</i>	It shows the MAC address of X-Micro WLAN 11b Access Point.

3.3.2 Wireless Basic Settings

This page is used to configure the parameters for wireless LAN clients that may connect to your Access Point. Here you may change wireless encryption settings as well as wireless network parameters.

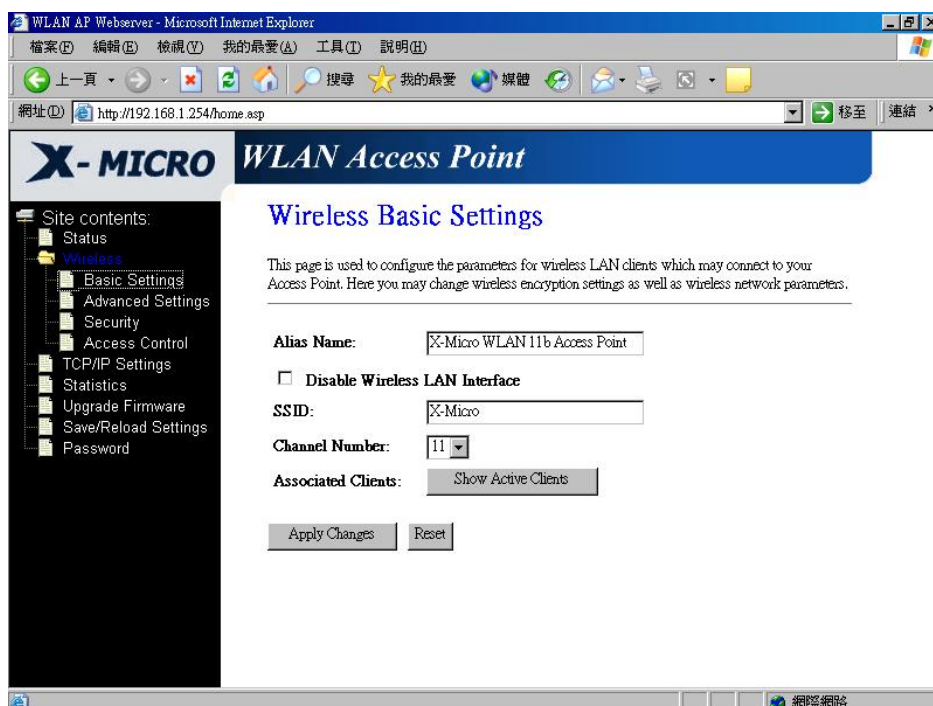

Screenshot – Wireless Basic Settings

Item	Description
Alias Name	It is the alias name of X-Micro WLAN 11b Access Point. The alias name can be 32 characters long.
Disable Wireless LAN Interface	Tick on to disable the wireless LAN data transmission.
SSID	It is the wireless network name. The SSID can be 32 bytes long.
Channel Number	Select the wireless communication channel from pull-down menu.
Associated Clients	Click the Show Active Clients button to open Active Wireless Client Table that shows the MAC address, transmit-packet, receive-packet and transmission-rate for each associated wireless client.
Apply Changes	Click the Apply Changes button to complete the new configuration setting.
Reset	Click the Reset button to abort change and recover the previous configuration setting.

3.3.3 Wireless Advanced Settings

These settings are only for more technically advanced users who have a sufficient

knowledge about wireless LAN. These settings should not be changed unless you know what effect the changes will have on your Access Point.

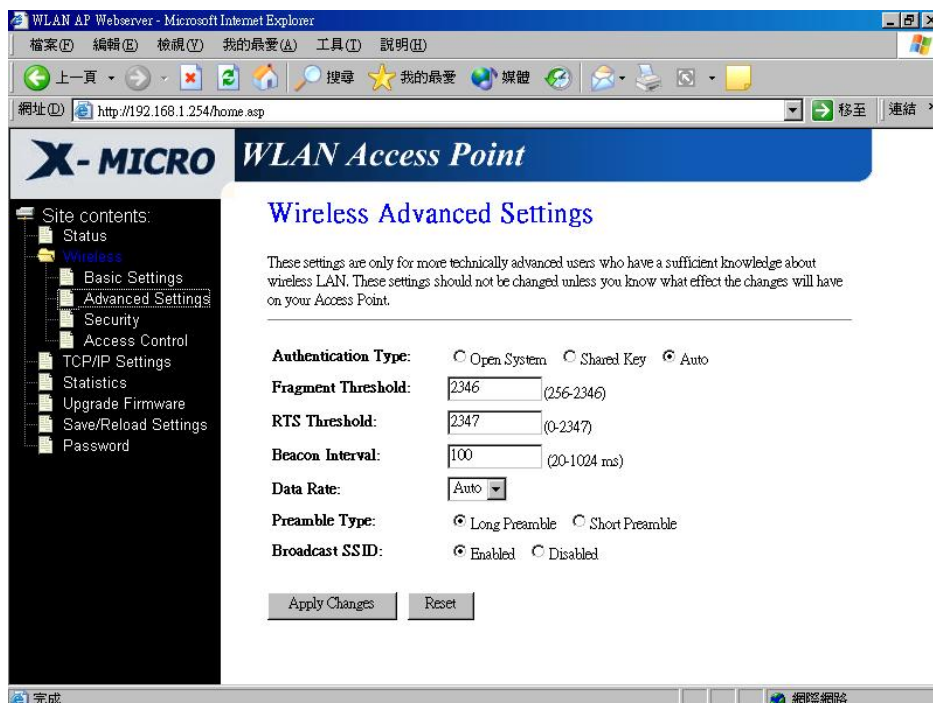

Screenshot – Wireless Advanced Settings

Item	Description
Authentication Type	Click to select the authentication type in <i>Open System</i> , <i>Shared Key</i> or <i>Auto selection</i> .
Fragment Threshold	Set the data packet fragmentation threshold, value can be written between 256 and 2346 bytes. Refer to 4.10 What is Fragment Threshold?
RTS Threshold	Set the RTS Threshold, value can be written between 0 and 2347 bytes. Refer to 4.11 What is RTS (Request To Send) Threshold?
Beacon Interval	Set the Beacon Interval, value can be written between 20 and 1024 ms. Refer to 4.12 What is Beacon Interval?
Data Rate	Select the transmission data rate from pull-down menu. Data rate can be auto-select, 11M, 5.5M, 2M or 1Mbps.
Preamble Type	Click to select the <i>Long Preamble</i> or <i>Short Preamble</i> support on the wireless data packet transmission. Refer to

4.13 What is Preamble Type?

Broadcast SSID	Click to enable or disable the SSID broadcast function. Refer to 4.14 What is SSID Broadcast?
Apply Changes	Click the Apply Changes button to complete the new configuration setting.
Reset	Click the Reset button to abort change and recover the previous configuration setting.

3.3.4 Wireless Security Setup

This page allows you setup the WEP security. Turn on WEP by using encryption keys could prevent any unauthorized access to your wireless network.

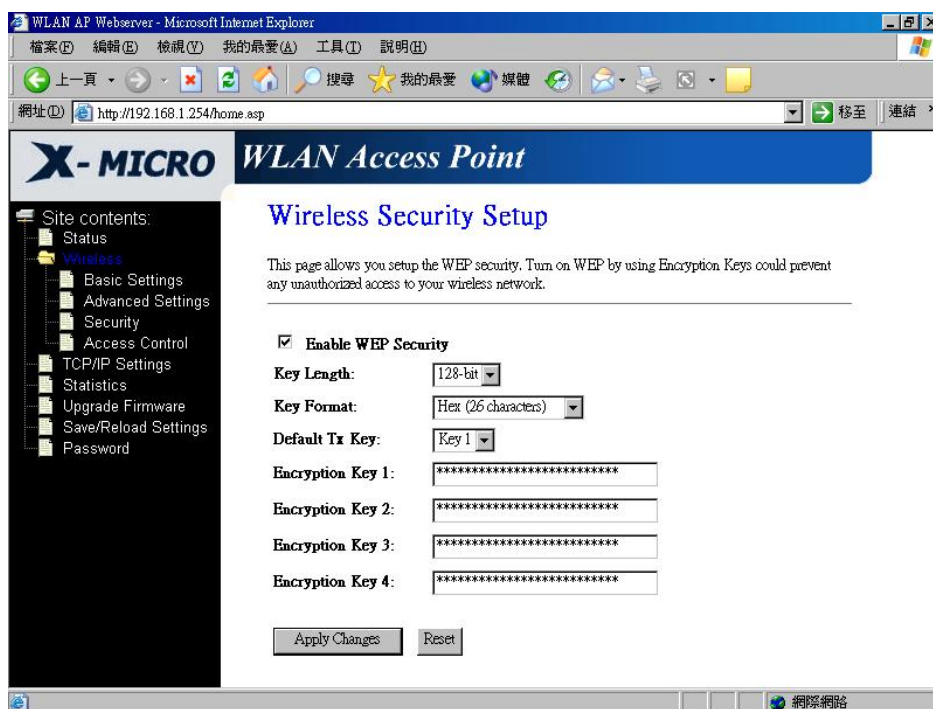

Screenshot – Wireless Security Setup

Item	Description
Enable WEP Security	Click the check box to enable WEP security function. Refer to 4.9 What is WEP?
Key Length	Select the WEP shared secret key length from pull-down menu. The length can be chose between 64-bit and 128-bit (known as “WEP2”) keys. The WEP key is composed of initialization vector (24

	bits) and secret key (40-bit or 104-bit).
Key Format	Select the WEP shared secret key format from pull-down menu. The format can be chose between plant text (ASCII) and hexadecimal (HEX) code.
Default Tx Key	Set the default secret key for WEP security function. Value can be chose between 1 and 4.
Encryption Key 1	Secret key 1 of WEP security encryption function.
Encryption Key 2	Secret key 2 of WEP security encryption function.
Encryption Key 3	Secret key 3 of WEP security encryption function.
Encryption Key 4	Secret key 4 of WEP security encryption function.
Apply Changes	Click the Apply Changes button to complete the new configuration setting.
Reset	Click the Reset button to abort change and recover the previous configuration setting.

WEP encryption key (secret key) length:

Format \ Length	64-bit	128-bit
ASCII	5 characters	13 characters
HEX	10 hexadecimal codes	26 hexadecimal codes

3.3.5 Wireless Access Control

If you enable wireless access control, only those clients whose wireless MAC addresses are in the access control list will be able to connect to your Access Point. When this option is enabled, no wireless clients will be able to connect if the list contains no entries.

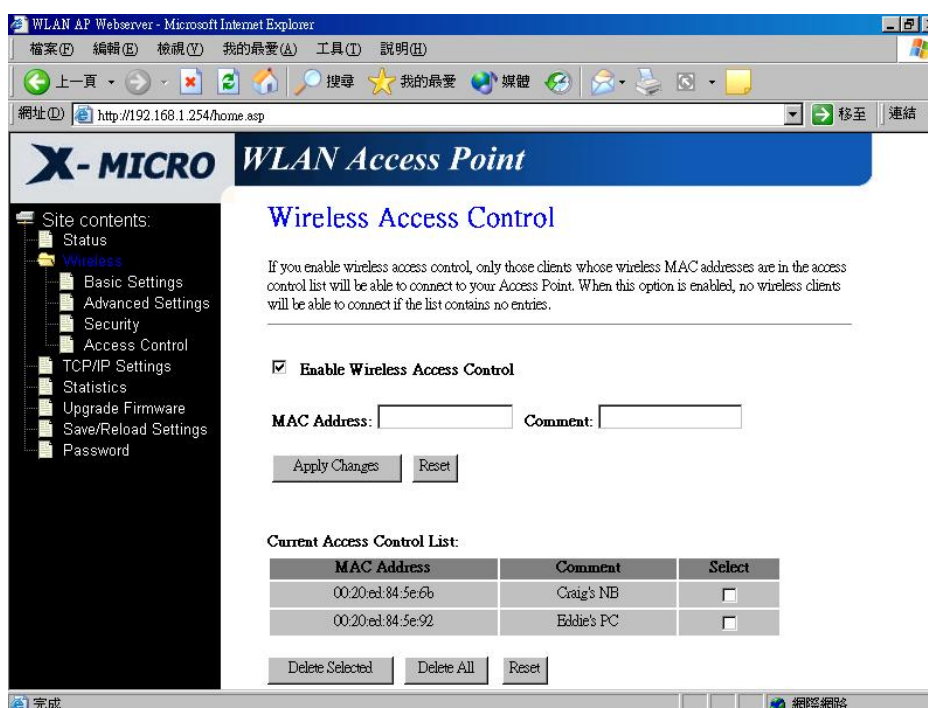

Screenshot – Wireless Access Control

Item	Description
Enable WEP Security	Click the check box to enable wireless access control. This is a security control function; only those clients registered in the access control list can link to X-Micro WLAN 11b Access Point.
MAC Address	Fill in the MAC address of client to register X-Micro WLAN 11b Access Point access capability.
Comment	Fill in the comments for the registered client.
Apply Changes	Click the Apply Changes button to register the client to new configuration setting.
Reset	Click the Reset button to abort change and recover the previous configuration setting.
Current Access Control List	It shows the registered clients that are allowed to link to X-Micro WLAN 11b Access Point.
Delete Selected	Click to delete the selected clients that will be access right removed from X-Micro WLAN 11b Access Point.
Delete All	Click to delete all the registered clients from the access allowed list.
Reset	Click the Reset button to abort change and recover the

previous configuration setting.

3.3.6 LAN Interface Setup

This page is used to configure the parameters for local area network that connects to the LAN port of your Access Point. Here you may change the setting for IP address, subnet mask, DHCP, etc.

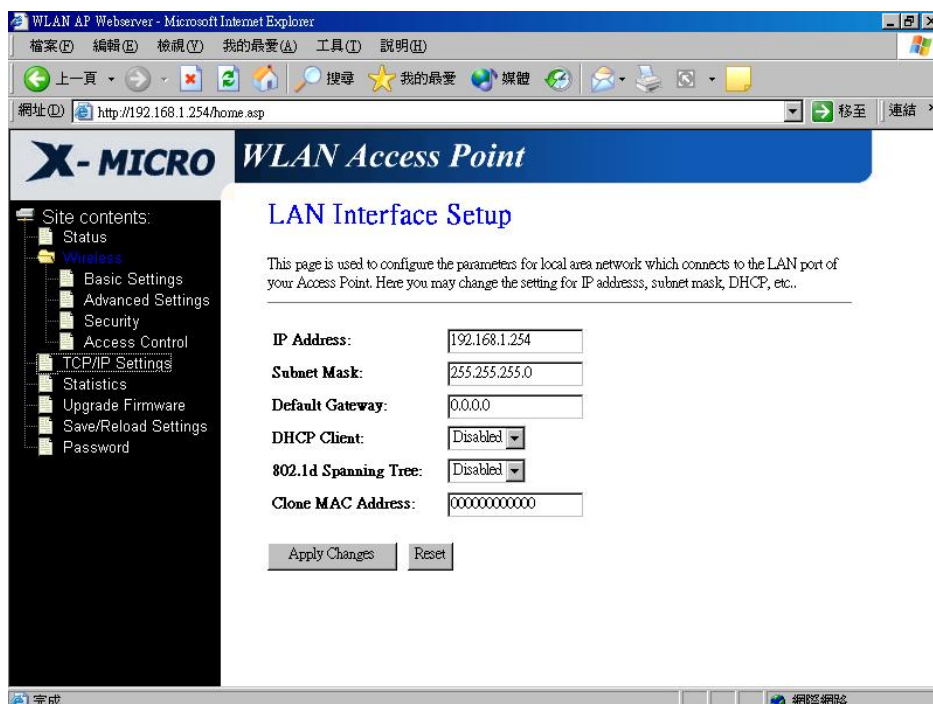

Screenshot – LAN Interface Setup

Item	Description
<i>IP Address</i>	If the DHCP Client function is disabled, fill in the IP address of X-Micro WLAN 11b Access Point.
<i>Subnet Mask</i>	If the DHCP Client function is disabled, fill in the subnet mask of X-Micro WLAN 11b Access Point.
<i>Default Gateway</i>	If the DHCP Client function is disabled, fill in the default gateway for out going data packets.
<i>DHCP Client</i>	Select to enable or disable the DHCP client function from pull-down menu.
<i>802.1d Spanning Tree</i>	Select to enable or disable the IEEE 802.1d Spanning Tree function from pull-down menu.
<i>Clone MAC Address</i>	Fill in the MAC address that is the MAC address to be

cloned.

Clone MAC address is designed for your special application that request the clients to register to a server machine with one identified MAC address.

Since that all the clients will communicate outside world through X-Micro WLAN 11b Access Point, so have the cloned MAC address set on the wireless LAN access point will solve the issue.

Apply Changes Click the **Apply Changes** button to complete the new configuration setting.

Reset Click the **Reset** button to abort change and recover the previous configuration setting.

3.3.7 Statistics

This page shows the packet counters for transmission and reception regarding to wireless and Ethernet networks.

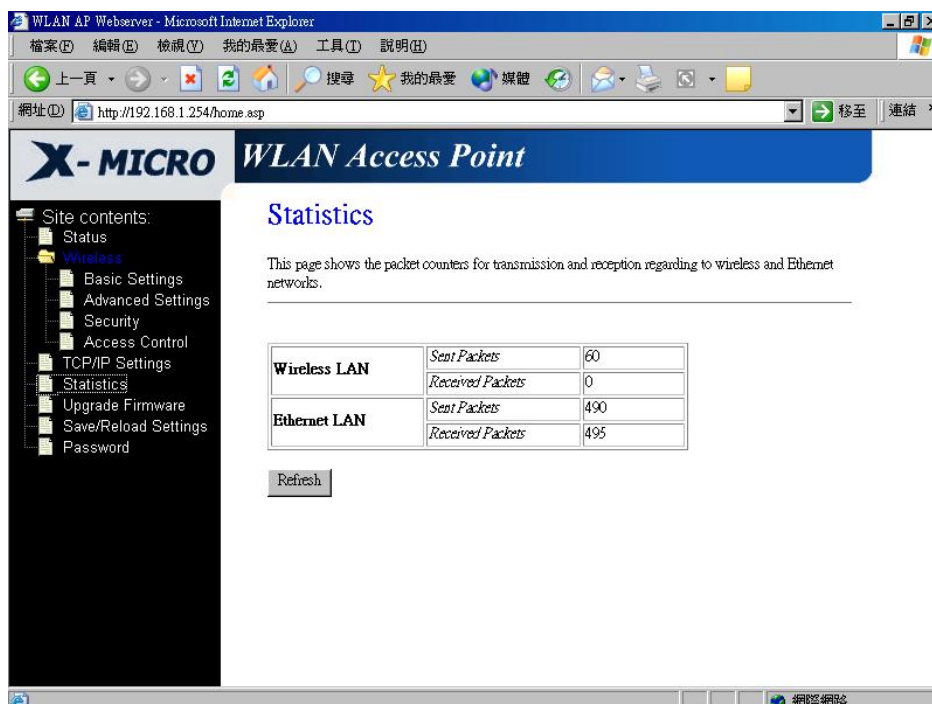

Screenshot – Statistics

Item	Description
Wireless LAN Sent Packets	It shows the statistic count of sent packets on the wireless LAN interface.

Wireless LAN Received Packets	It shows the statistic count of received packets on the wireless LAN interface.
Ethernet LAN Sent Packets	It shows the statistic count of sent packets on the Ethernet LAN interface.
Ethernet LAN Received Packets	It shows the statistic count of received packets on the Ethernet LAN interface.
Refresh	Click the refresh the statistic counters on the screen.

3.3.8 Upgrade Firmware

This page allows you upgrade the Access Point firmware to new version. Please note, do not power off the device during the upload because it may crash the system.

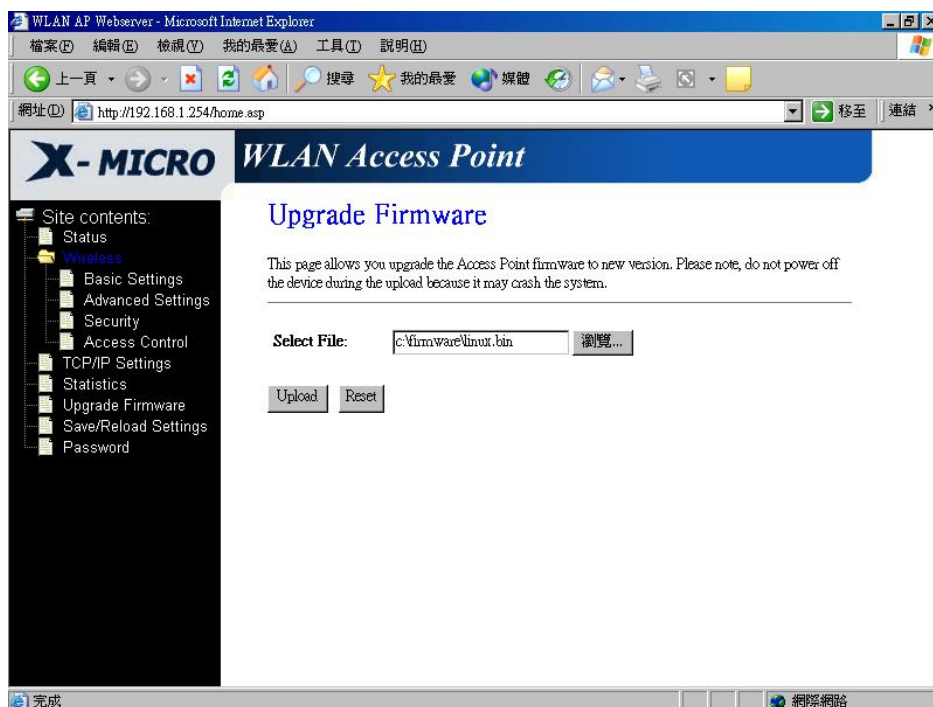

Screenshot – Upgrade Firmware

Item	Description
Select File	Click the Browse button to select the new version of web firmware image file.
Upload	Click the Upload button to update the selected web firmware image to X-Micro WLAN 11b Access Point.
Reset	Click the Reset button to abort change and recover the

previous configuration setting.

3.3.9 Save /Reload Settings

This page allows you save current settings to a file or reload the settings from the file that was saved previously. Besides, you could reset the current configuration to factory default.

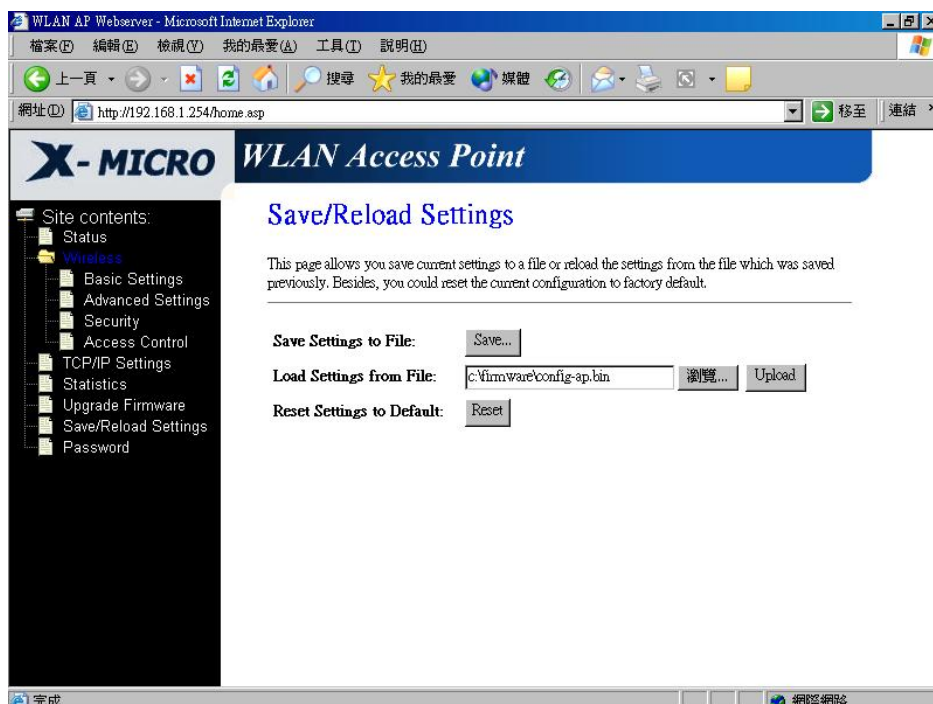

Screenshot – Save/Reload Settings

Item	Description
Save Settings to File	Click the Save button to download the configuration parameters to your personal computer.
Load Settings from File	Click the Browse button to select the configuration files then click the Upload button to update the selected configuration to X-Micro WLAN 11b Access Point.
Reset Settings to Default	Click the Reset button to reset the configuration parameter to factory defaults.

3.3.10 Password Setup

This page is used to set the account to access the web server of Access Point. Empty user name and password will disable the protection.

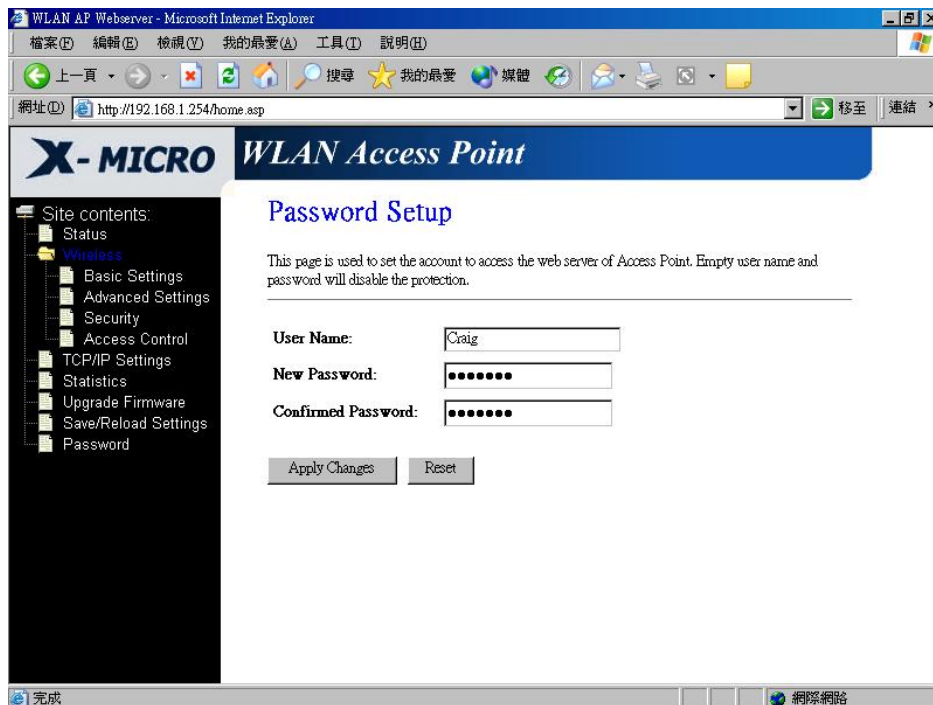

Screenshot – Password Setup

Item	Description
<i>User Name</i>	Fill in the user name for web management login control.
<i>New Password</i>	Fill in the password for web management login control.
<i>Confirmed Password</i>	Because the password input is invisible, so please fill in the password again for confirmation purpose.
<i>Apply Changes</i>	Clear the <i>User Name</i> and <i>Password</i> fields to empty, means to apply no web management login control. Click the <i>Apply Changes</i> button to complete the new configuration setting.
<i>Reset</i>	Click the <i>Reset</i> button to abort change and recover the previous configuration setting.

4 Frequently Asked Questions (FAQ)

4.1 What and how to find my PC's IP and MAC address?

IP address is the identifier for a computer or device on a TCP/IP network. Networks using the TCP/IP protocol route messages based on the IP address of the destination. The format of an IP address is a 32-bit numeric address written as four numbers separated by periods. Each number can be zero to 255. For example, 191.168.1.254 could be an IP address.

The MAC (Media Access Control) address is your computer's unique hardware number. (On an Ethernet LAN, it's the same as your Ethernet address.) When you're connected to the Internet from your computer (or host as the Internet protocol thinks of it), a correspondence table relates your IP address to your computer's physical (MAC) address on the LAN.

To find your PC's IP and MAC address,

- ✓ Open the Command program in the Microsoft Windows.
 - ✓ Type in *ipconfig /all* then press the *Enter* button.
- Your PC's IP address is the one entitled IP Address and your PC's MAC address is the one entitled Physical Address.

4.2 What is Wireless LAN?

A wireless LAN (WLAN) is a network that allows access to Internet without the need for any wired connections to the user's machine.

4.3 What are ISM bands?

ISM stands for Industrial, Scientific and Medical; radio frequency bands that the Federal Communications Commission (FCC) authorized for wireless LANs. The ISM bands are located at 915 +/- 13 MHz, 2450 +/- 50 MHz and 5800 +/- 75 MHz.

4.4 How does wireless networking work?

The 802.11 standard define two modes: infrastructure mode and ad hoc mode. In infrastructure mode, the wireless network consists of at least one access point connected to the wired network infrastructure and a set of wireless end stations. This configuration is called a Basic Service Set (BSS). An Extended Service Set (ESS) is a set of two or more BSSs forming a single subnetwork. Since most corporate WLANs require access

to the wired LAN for services (file servers, printers, Internet links) they will operate in infrastructure mode.

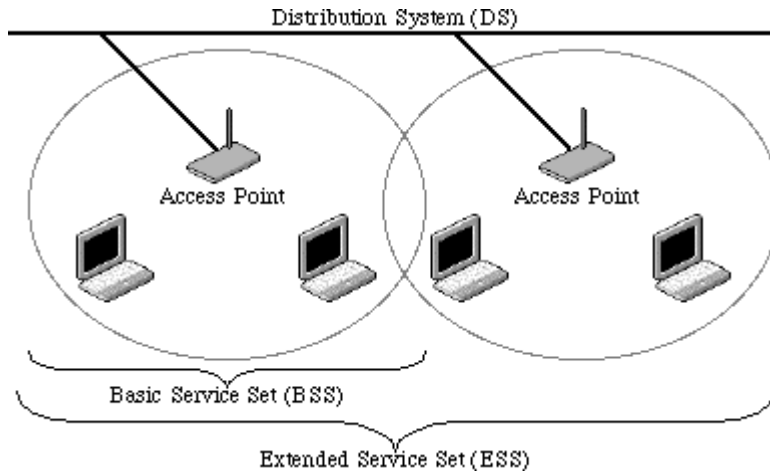

Example 1: wireless Infrastructure Mode

Ad hoc mode (also called peer-to-peer mode or an Independent Basic Service Set, or IBSS) is simply a set of 802.11 wireless stations that communicate directly with one another without using an access point or any connection to a wired network. This mode is useful for quickly and easily setting up a wireless network anywhere that a wireless infrastructure does not exist or is not required for services, such as a hotel room, convention center, or airport, or where access to the wired network is barred (such as for consultants at a client site).

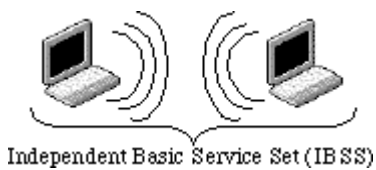

Example 2: wireless Ad Hoc Mode

4.5 What is BSSID?

A six-byte address that distinguishes a particular a particular access point from others. Also know as just SSID. Serves as a network ID or name.

4.6 What is ESSID?

The Extended Service Set ID (ESSID) is the name of the network you want to access. It is used to identify different wireless networks.

4.7 What are potential factors that may causes interference?

Factors of interference:

- Obstacles: walls, ceilings, furniture... etc.
- Building Materials: metal door, aluminum studs.
- Electrical devices: microwaves, monitors and electrical motors.

Solutions to overcome the interferences:

- ✓ Minimizing the number of walls and ceilings.
- ✓ Position the WLAN antenna for best reception.
- ✓ Keep WLAN devices away from other electrical devices, eg: microwaves, monitors, electric motors, ... etc.
- ✓ Add additional WLAN Access Points if necessary.

4.8 What are the Open System and Shared Key authentications?

IEEE 802.11 supports two subtypes of network authentication services: open system and shared key. Under open system authentication, any wireless station can request authentication. The station that needs to authenticate with another wireless station sends an authentication management frame that contains the identity of the sending station. The receiving station then returns a frame that indicates whether it recognizes the sending station. Under shared key authentication, each wireless station is assumed to have received a secret shared key over a secure channel that is independent from the 802.11 wireless network communications channel.

4.9 What is WEP?

An optional IEEE 802.11 function that offers frame transmission privacy similar to a wired network. The Wired Equivalent Privacy generates secret shared encryption keys that both source and destination stations can use to alert frame bits to avoid disclosure to eavesdroppers.

WEP relies on a secret key that is shared between a mobile station (e.g. a laptop with a wireless Ethernet card) and an access point (i.e. a base station). The secret key is used to encrypt packets before they are transmitted, and an integrity check is used to ensure that packets are not modified in transit.

4.10 What is Fragment Threshold?

The proposed protocol uses the frame fragmentation mechanism defined in IEEE 802.11 to achieve parallel transmissions. A large data frame is fragmented into several

fragments each of size equal to fragment threshold. By tuning the fragment threshold value, we can get varying fragment sizes. The determination of an efficient fragment threshold is an important issue in this scheme. If the fragment threshold is small, the overlap part of the master and parallel transmissions is large. This means the spatial reuse ratio of parallel transmissions is high. In contrast, with a large fragment threshold, the overlap is small and the spatial reuse ratio is low. However high fragment threshold leads to low fragment overhead. Hence there is a trade-off between spatial re-use and fragment overhead.

Fragment threshold is the maximum packet size used for fragmentation. Packets larger than the size programmed in this field will be fragmented.

If you find that your corrupted packets or asymmetric packet reception (all send packets, for example). You may want to try lowering your fragmentation threshold. This will cause packets to be broken into smaller fragments. These small fragments, if corrupted, can be resent faster than a larger fragment. Fragmentation increases overhead, so you'll want to keep this value as close to the maximum value as possible.

4.11 What is RTS (Request To Send) Threshold?

The RTS threshold is the packet size at which packet transmission is governed by the RTS/CTS transaction. The IEEE 802.11-1997 standard allows for short packets to be transmitted without RTS/CTS transactions. Each station can have a different RTS threshold. RTS/CTS is used when the data packet size exceeds the defined RTS threshold. With the CSMA/CA transmission mechanism, the transmitting station sends out an RTS packet to the receiving station, and waits for the receiving station to send back a CTS (Clear to Send) packet before sending the actual packet data.

This setting is useful for networks with many clients. With many clients, and a high network load, there will be many more collisions. By lowering the RTS threshold, there may be fewer collisions, and performance should improve. Basically, with a faster RTS threshold, the system can recover from problems faster. RTS packets consume valuable bandwidth, however, so setting this value too low will limit performance.

4.12 What is Beacon Interval?

In addition to data frames that carry information from higher layers, 802.11 includes management and control frames that support data transfer. The beacon frame, which is a type of management frame, provides the "heartbeat" of a wireless LAN, enabling

stations to establish and maintain communications in an orderly fashion.

Beacon Interval represents the amount of time between beacon transmissions. Before a station enters power save mode, the station needs the beacon interval to know when to wake up to receive the beacon (and learn whether there are buffered frames at the access point).

4.13 What is Preamble Type?

There are two preamble types defined in IEEE 802.11 specification. A long preamble basically gives the decoder more time to process the preamble. All 802.11 devices support a long preamble. The short preamble is designed to improve efficiency (for example, for VoIP systems). The difference between the two is in the Synchronization field. The long preamble is 128 bits, and the short is 56 bits.

4.14 What is SSID Broadcast?

Broadcast of SSID is done in access points by the beacon. This announces your access point (including various bits of information about it) to the wireless world around it. By disabling that feature, the SSID configured in the client must match the SSID of the access point.

Some wireless devices don't work properly if SSID isn't broadcast (for example the D-link DWL-120 USB 802.11b adapter). Generally if your client hardware supports operation with SSID disabled, it's not a bad idea to run that way to enhance network security. However it's no replacement for WEP, MAC filtering or other protections.

5 Configuration Examples

5.1 Example One – DHCP on the LAN

Sales division of Company ABC likes to establish a WLAN network to support mobile communication on sales' Notebook PCs. MIS engineer collects information and plans the WLAN Access Point implementation by the following configuration.

All the sales' Notebook PCs will get IP address automatically from the DHCP server. DHCP server also assigns the IP address of WLAN Access Point LAN interface, so before you can manage the WLAN Access Point through the WEB browser, you need to get the IP address of the LAN interface.

LAN configuration

Attain IP Automatically (DHCP); enable DHCP client function.

WLAN configuration

SSID	SDWLAN
Channel Number	1

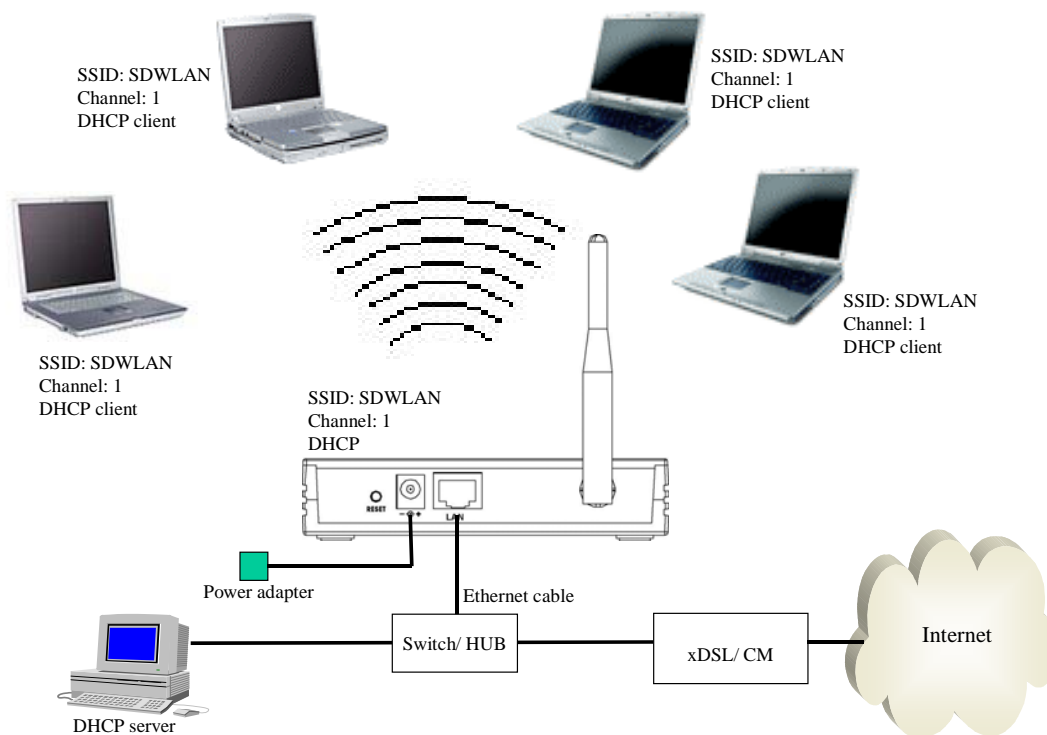
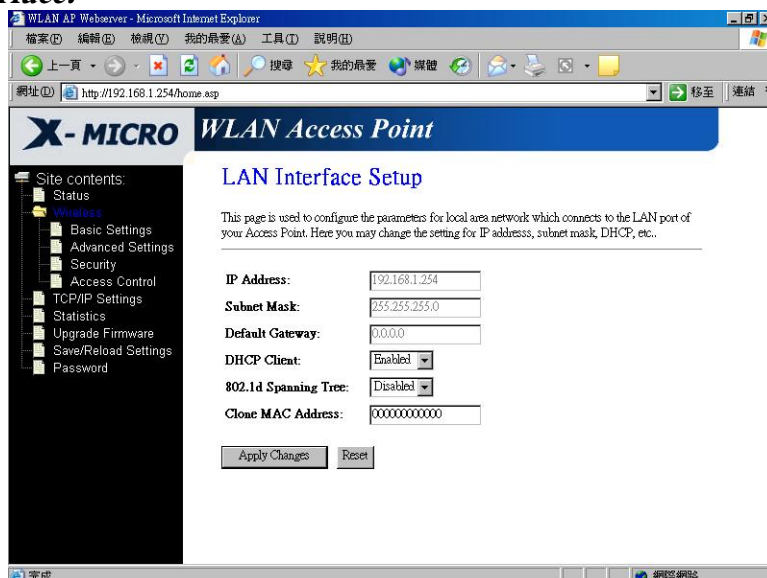
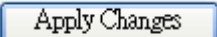

Figure 3 – Configuration Example One – DHCP on the LAN

Configure the LAN interface:

Open LAN Interface Setup page and enable the DHCP Client function.



Press  button to confirm the configuration setting.

Configure the WLAN interface:

Open WLAN Interface Setup page, enter the SSID "SDWLAN", Channel Number "1".

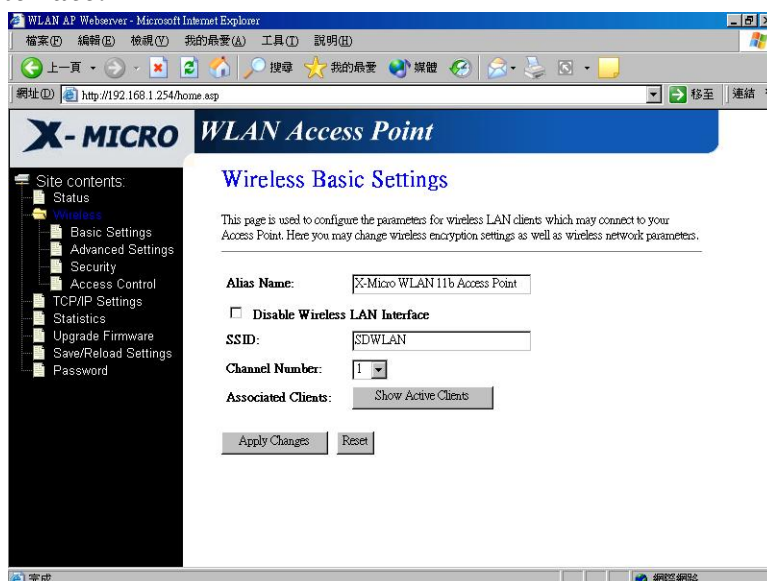

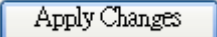
Press  button to confirm the configuration setting.

5.2 Example Two – Fixed IP on the LAN

Company ABC likes to establish a WLAN network to support mobile communication on all employees' Notebook PCs. MIS engineer collects information and plans the WLAN Access Point implementation by the following configuration.

LAN configuration

<i>IP Address</i>	192.168.1.254
<i>Subnet Mask</i>	255.255.255.0
<i>Default Gateway</i>	192.168.1.10

WLAN configuration

<i>SSID</i>	MyWLAN
<i>Channel Number</i>	6

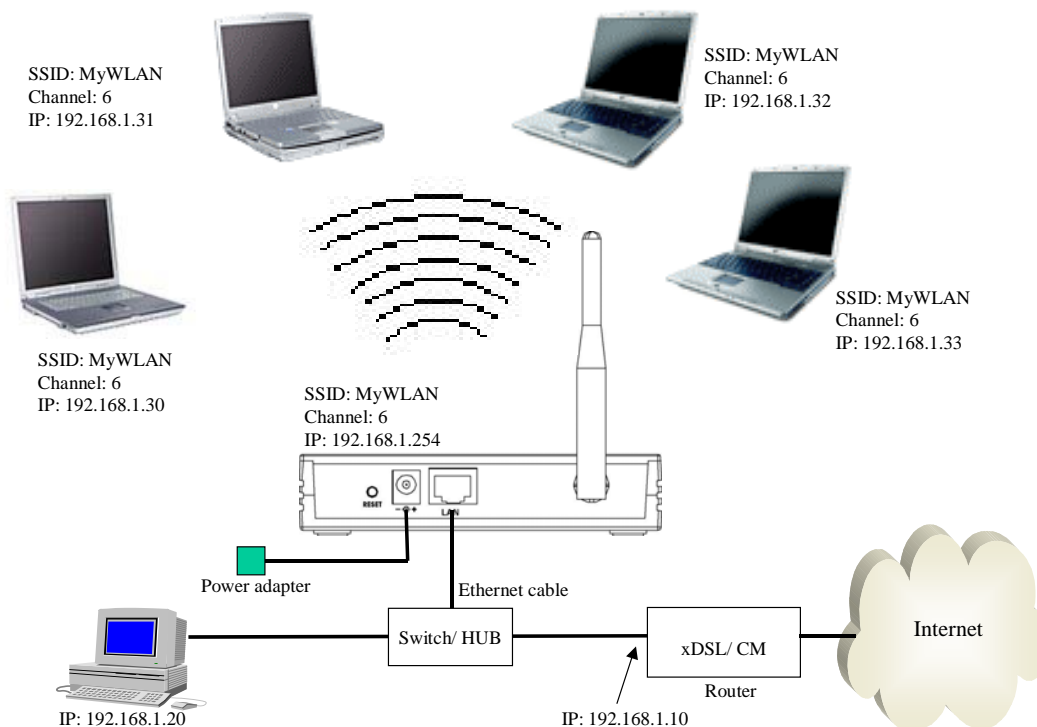
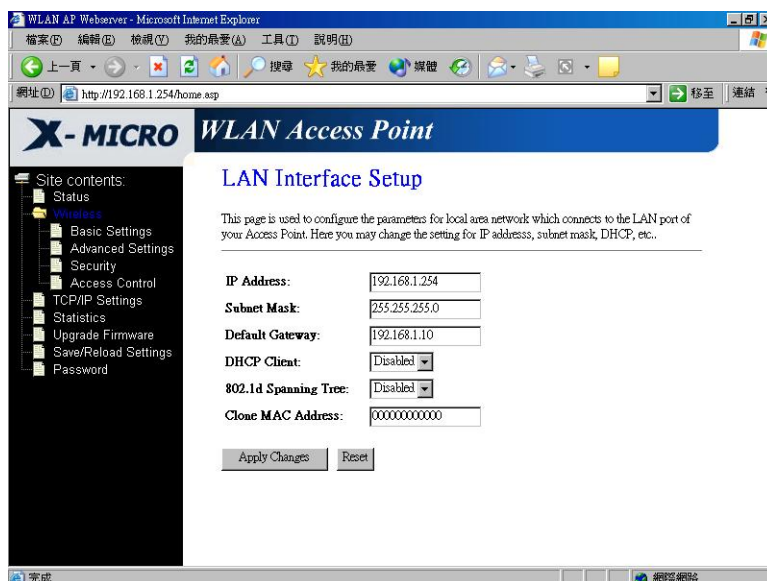
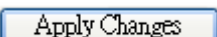

Figure 4 – Configuration Example Two – Fixed IP on the WAN

Configure the LAN interface:

Open LAN Interface Setup page, enter the IP Address "192.168.1.254", Subnet Mask "255.255.255.0", Default Gateway "192.168.1.10".



Press  button to confirm the configuration setting.

Configure the WLAN interface:

Open WLAN Interface Setup page, enter the SSID "MyWLAN", Channel Number "6".

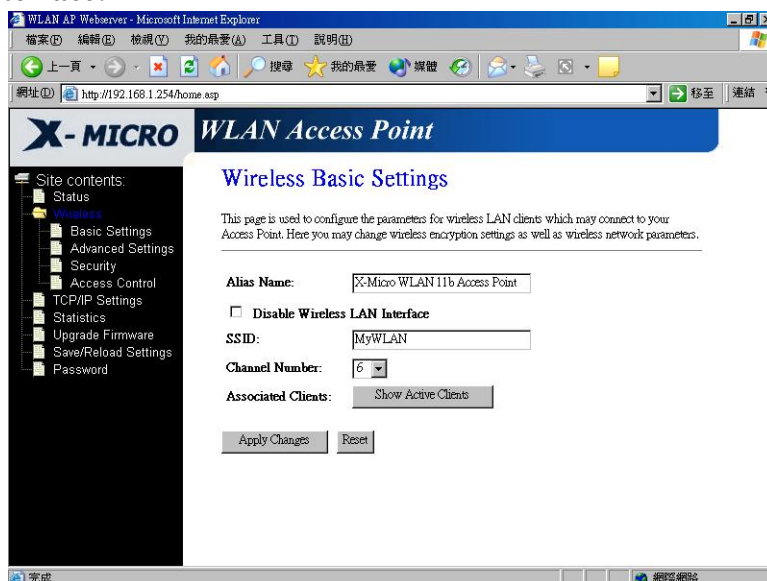

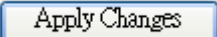
Press  button to confirm the configuration setting.

X - MICRO
Plug & fly

www.x-micro.com

Free Manuals Download Website

<http://myh66.com>

<http://usermanuals.us>

<http://www.somanuals.com>

<http://www.4manuals.cc>

<http://www.manual-lib.com>

<http://www.404manual.com>

<http://www.luxmanual.com>

<http://aubethermostatmanual.com>

Golf course search by state

<http://golfingnear.com>

Email search by domain

<http://emailbydomain.com>

Auto manuals search

<http://auto.somanuals.com>

TV manuals search

<http://tv.somanuals.com>