

Initializing Motion Detectors

Remove the cover on the front of the Motion Detector and install 2 AA alkaline batteries in the compartment.

Replace the cover to deactivate the tamper switch.

Press and hold the TEST button on the back of the Motion Detector for 3-4 seconds and then release it. This initializes the Motion Detector and picks a random code that is used when it is registered with the Console. Place the unit face down, so that it won't see any motion during the registering process below.

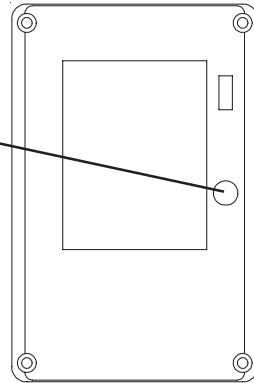

Registering the Motion Detector with the Console

Press either of the Menu Start up/down buttons (under the Console's lid to the left of the display). The display then shows ENTER PIN (Personal Identification Number) in the top line.

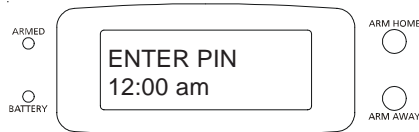

The default PIN is 0000, so press 0000 on the keypad, or enter your PIN if you changed it (see Security System Owner's Manual). This clears the top line and shows * for each number entered.

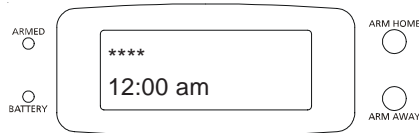

This takes you to the first level of the menu at step 1. This is the INSTALLATION level. When you see INSTALL on the display, press OK. The display then looks like this:

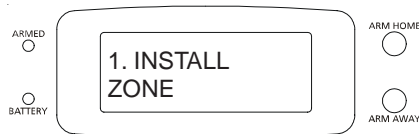

Now simply press the TEST button on the back of the Motion Detector (or turn the unit over so that it sees motion). The Console will acknowledge that it has been registered by displaying (for example) ZONE 3 SET.

Repeat this for any other Motion Detectors you want to register. The display increments to ZONE 4 SET, etc. as you install more Motion Detectors.

If desired, you can specify what zone you want the Motion Detector to be installed into. Just press the number of the zone you want on the Console's keypad, before you press the TEST button on the back of the Motion Detector.

Press Clear to back out of the menus. You are asked to confirm, 1. YES, 2 NO. Press 1 to go back to the HOME CONTROL screen. Press 2 to stay in the INSTALL menu.

Installing the Motion Detector

- Attach the Motion Detector to a wall at a height of 5 to 6 ft. using the mounting bracket and screws provided.
- Point the Motion Detector so that it looks slightly downwards.
- Set the slide switch (on the back) to position 1 for instant triggering for maximum sensitivity, or position 2 to trigger only after two movements have been sensed.

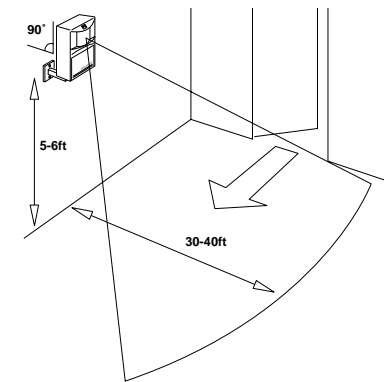
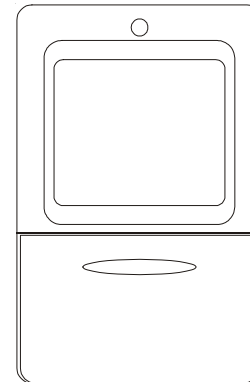

Testing the Motion Detector

- Set the slide switch on the Motion Detector to position 1.
- Press and hold the TEST button for about a second. The LED flashes twice when you release it.
- Wait 20 seconds for the Motion Detector to settle.
- Walk in front of the Motion Detector. The indicator LED lights each time it senses movement. Check the coverage area and reposition the sensor as required.
- Press the TEST button to return to normal operating mode.

Note: The Motion Detector will automatically return to normal operating mode after about 2 minutes.

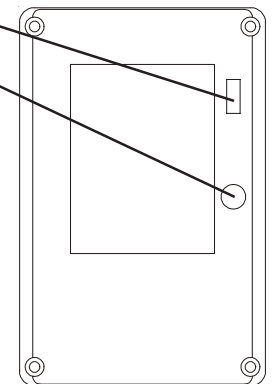

Battery Replacement

If a zone has not reported in during the last four hours, the display will show PROBLEM. This is most likely caused by dead batteries.

As long as the batteries have not completely failed they can be replaced with fresh batteries without the need to reinstall the Motion Detector. After removing the old batteries fresh batteries must be fitted within 30 seconds to ensure that the security code is retained.

To test the Motion Detector:

Once the batteries have been replaced, the Motion Detector should be tested as follows:

- Make sure the system is NOT armed.
- Press the TEST button on the back of the Motion Detector. The Console chimes to acknowledge and the zone # is displayed on the LCD.

If the batteries had failed, the security code will have been lost. You will need to reinstall the Motion Detector following the directions in this instruction sheet.

FCC Statement

THIS DEVICE COMPLIES WITH PART 15 OF THE FCC RULES. OPERATION IS SUBJECT TO THE FOLLOWING TWO CONDITIONS: (1) THIS DEVICE MAY NOT CAUSE HARMFUL INTERFERENCE, AND (2) THIS DEVICE MUST ACCEPT ANY INTERFERENCE RECEIVED, INCLUDING INTERFERENCE THAT MAY CAUSE UNDESIRE OPERATION.

NOTE: NO CHANGES OR MODIFICATIONS MAY BE MADE TO THE UNITS. ANY CHANGES MADE TO THE UNITS WILL VOID THE USER'S AUTHORITY TO OPERATE THE EQUIPMENT.

Please visit: <http://www.x10.com/support> for additional help and warranty conditions.

Also see www.x10.com for more accessories that work with your Security System, including Lamp Modules and Wall Switch Modules to flash lights when the alarm trips, and remote controls that let you remotely control lights (and appliances) connected to X10 Modules.

X10 Wireless Technology, Inc. Kent WA 98032

MS18A-1/05



Motion Detector Model MS18A



The X10 Supervised Security System includes a Security Console with an automatic dialer that calls friends or relatives in the event of a break in. Accessories include battery powered Radio Frequency (RF) Door/Window Sensors, battery powered RF Motion Detectors, and RF Keyfob Remote Controls for arming and disarming the system. All sensors and remotes incorporate random digital security coding.

The system can be configured with any combination of the following items:

- Up to 16* Wireless Keyfob Security Remotes with arm/disarm and panic functions, and buttons to control security lights in and around the home.
- Up to 30* magnetic switch operated Wireless Door/Window Sensors.
- Up to 30* Wireless PIR Motion Detectors.
- Optional X10 Home Automation modules such as plug-in lamp and appliance modules and wired-in replacement wall switches can be added to the system.

The Owner's Manual for the Security System describes the full installation process for the Security System, and should be referred to as a supplement to this instruction sheet.

***Note: Door/Window Sensors and Motion Detectors may be added in any combination up to a total of 30, e.g. 15 Door/Window Sensors and 15 Motion Detectors, or any combination up to a total of 30. There are also 2 hard wired inputs, which are zones 31 and 32.**

Free Manuals Download Website

<http://myh66.com>

<http://usermanuals.us>

<http://www.somanuals.com>

<http://www.4manuals.cc>

<http://www.manual-lib.com>

<http://www.404manual.com>

<http://www.luxmanual.com>

<http://aubethermostatmanual.com>

Golf course search by state

<http://golfingnear.com>

Email search by domain

<http://emailbydomain.com>

Auto manuals search

<http://auto.somanuals.com>

TV manuals search

<http://tv.somanuals.com>