

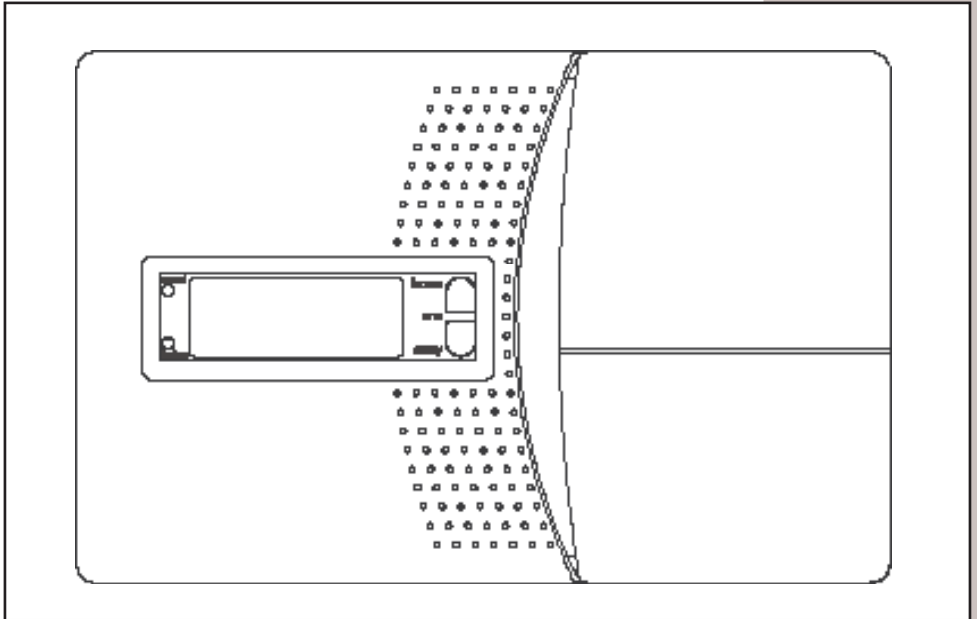

Supervised Security System

Model SC1200



Owner's Manual

Read This First

This equipment generates and uses radio frequency energy, and if not installed and used properly, that is, in strict accordance with the manufacturers instructions, may cause interference to radio and television reception. It has been type tested and found to comply with the limits for remote control security devices in accordance with the specifications in Sub-Parts B and C of Part 15 of *FCC Rules*, which are designed to provide reasonable protection against such interference in a residential installation. However, there is no guarantee that interference will not occur in a particular installation. If this equipment does cause interference to radio or television reception, which can be determined by unplugging the equipment, try to correct the interference by one or more of the following measures.

- Reorient the antenna of the radio/TV experiencing the interference.
- Relocate the Console with respect to the radio/TV.
- Move the Console away from the radio/TV.
- Plug the Console into an outlet on a different electrical circuit from the radio/TV experiencing the interference.

If necessary, contact www.x10.com for additional suggestions.

This equipment complies with Part 68 of the FCC rules and the requirements adopted by the ACTA. On the bottom of this equipment is a label that contains, among other information, a product identifier US: B4SAL11B-SC12A. If requested, this number must be provided to the telephone company.

Note: The security functions of this system have not been tested by Underwriters Laboratories.

Contents

Introduction	4
Installation	5
Locating Security System components	5
Attaching the cables	6
Fitting the backup batteries	7
Wall mounting.....	7
Overview	8
Registering Remotes	12
Registering Door/Window Sensors.....	13
Removing Door/Window Sensors.....	14
Installing Door/Window Sensors.....	15
Registering Motion Detectors	16
Removing Motion Detectors	17
Installing Motion Detectors	18
Setting the Clock	20
Setting the Phone Numbers	21
Setting the Outgoing Message	22
Setting the PIN	24
Clearing the Memory	25
Setting the Options	26
Setting the Delays	27
Setting the Timers	28
Using the System	32
Arming and Disarming	32
Problem zones.....	33
When there's an alarm	34
Controlling Lights and Appliances	35
Setting up Optional Lamp Modules	36
Operation from an Outside Telephone	37
Replacing Batteries	38
Troubleshooting	38

Introduction

The X10 Supervised Security System Console with automatic dialer calls neighbors or friends in the event of a break in. Battery powered Wireless Door/Window Sensors trigger the alarm when a door or window is opened. A battery powered RF Motion Detector protects an indoor area. The Keychain Remote Control is used for arming and disarming the system. It can also turn lights on and off (requires X10 Modules). All sensors and remotes incorporate random digital security coding.

The system may be configured with any combination of the following items:

- Up to 16 Keychain Security Remotes with arm/disarm and panic functions, and buttons to control security lights in and around the home.
- Up to 30* magnetic switch operated Wireless Door/Window Sensors.
- Up to 30* Wireless Motion Detectors.
- Additional X10 Home Automation modules such as plug-in Lamp and Appliance Modules and wired-in replacement Wall Switch Modules can be added to the system to flash lights on and off when the alarm trips.

***Note: Door/Window Sensors and Motion Detectors may be added in any combination up to a total of 30, e.g., 15 Door/Window Sensors and 15 Motion Detectors, or any combination up to a total of 30. There are also 2 hard wired inputs, which are zones 31 and 32.**

Installation

Locating Security System components

Locating the Security Console

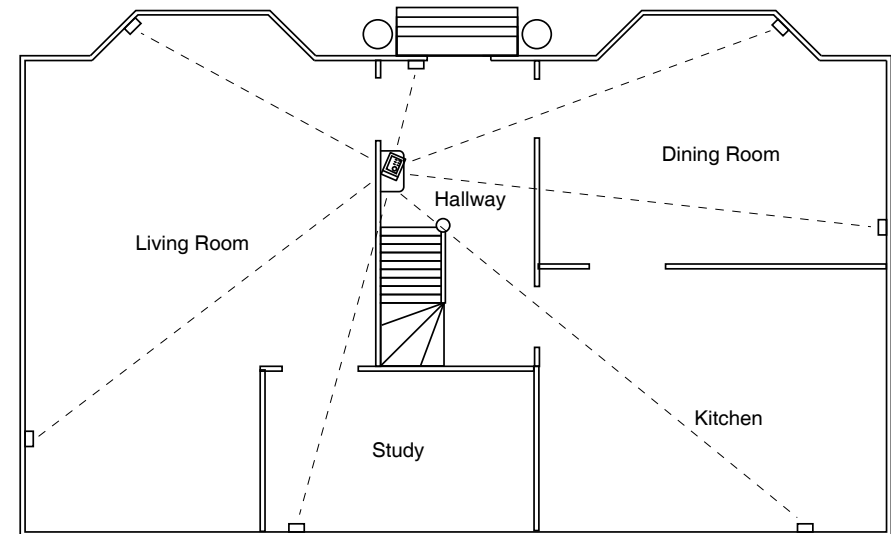

Choose a location for the Security Console which is as central as possible in the house, while providing access to a modular telephone jack and an AC outlet. The Console may be placed on a shelf or table, or may be wall mounted.

Locating Door/Window Sensors and Motion Detectors

Plan the location of the Door/Window Sensors and Motion Detectors so that the RF path which runs in a straight line from sensor to Console is not obstructed by large metal objects such as a refrigerators or freezers, and passes through as few walls as possible.

Door/Window Sensors may be hidden behind drapes for a more discreet installation.

Installation

Security Console

Attaching cables

A telephone cord terminated at each end with an RJ11 connector is provided for telephone connection. If possible, the Console should be connected to its own telephone line to ensure that the line cannot be busy when the Console attempts to dial out. For applications where this is not practical, the Console may also share a line with an existing telephone using a 'T' adapter (supplied).

Note: The Security Console is not designed to operate with an RJ31X type telephone connection.

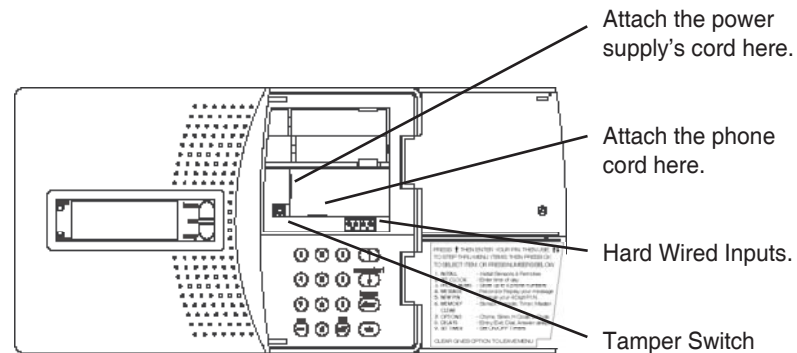

Open the lid on the Console and attach the power supply's cord to the connector labeled power supply (see above). Plug the power supply into any convenient (unswitched) AC outlet.

NOTE: you must use the power supply that came with the Security System. The power supply contains circuitry required to control X10 Modules, so you CANNOT replace it with a regular 8V DC power supply.

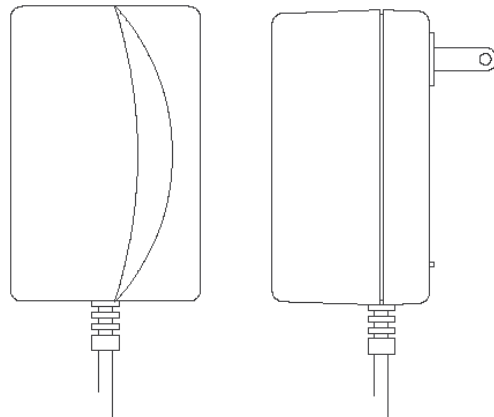

Installation

Fitting the backup batteries

Open the battery compartment cover at the top right hand side of the Console and install 4 AA alkaline batteries (not supplied). It is not necessary to disconnect power to the Console when fitting or replacing batteries.

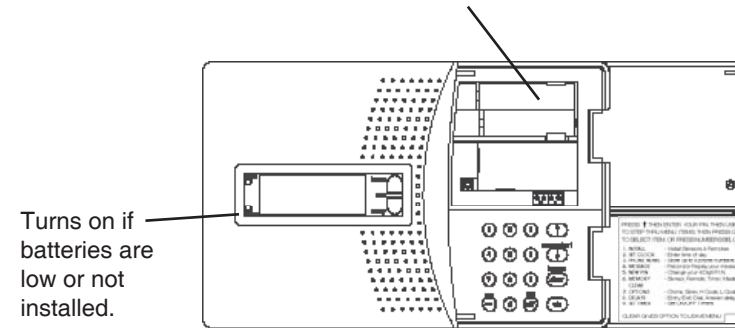

Mounting the Console

The Security Console is designed to be installed freestanding on a table top or shelf. Or it can be wall mounted using the two slotted holes on the back of the Console.

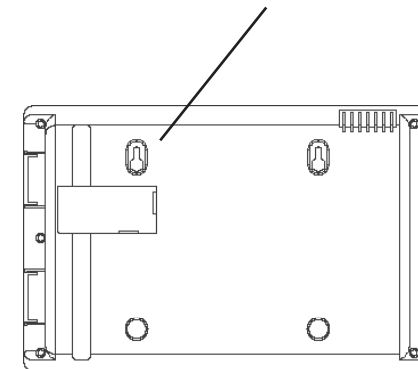

If you don't want to wall mount the console, you can insert the included rubber plugs into the two slotted mounting holes so as to tilt the console slightly forward for better viewing of the display.

Installation

Console setup Overview

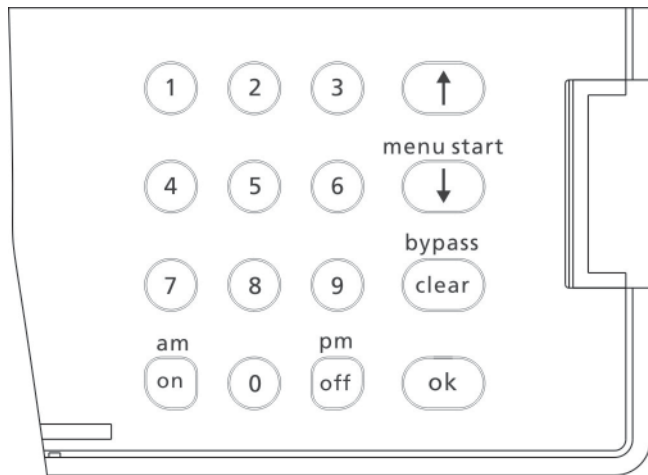

Console keyboard buttons are as follows:

0-9 Used for all number entries.

On Used to send an X10 On message or to enter am in a time.

Off Used to send an X10 Off message or to enter pm in a time.

Menu up Used to initially enter the menu and then to move up through the items.

Menu down Used to initially enter the menu and then to move down through the items.

Clear Used to clear entries, back up through the menu levels, and to bypass problem Door/Window Sensors or Motion Detectors.

Enter Used to terminate an entry.

Arm Home Used to arm the console in the Home mode.

Arm Away Used to arm the console in the Away mode.

Installation

Console setup Overview, cont.

After you've followed the steps on page 6 and 7 and connected power to the Console, the display shows the time of day at the left of the bottom line, with HOME CONTROL in the top line. See below:



All features (except Home Control) require access to the Menu mode. To do this, press either of the Menu up/down buttons (under the lid to the bottom right of the display). The display then shows ENTER PIN (Personal Identification Number) in the top line.



The default PIN is 0000, you'll find out later (page 24) how you can change this, but for now press 0000 on the keypad (under the lid to the bottom right of the display). This clears the top line and shows * for each number entered.

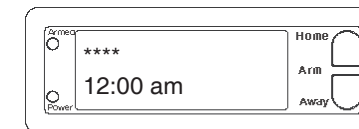

When you enter the PIN the display shows the First Level of the menu at step 1, below. See next page.



Installation

First Menu Level

After pressing a menu up/down button and entering the PIN, the First level menu is displayed, as shown below:



To select a menu option, press the up or down Menu button repeatedly to step through the menu items 1 through 9 below (or you can press the number buttons 1 thru 9 on the control panel (under the lid to the bottom right of the display) to go directly to that menu item. Once you arrive at the menu item you desire, press OK to select it.

- | | |
|-----------------|---|
| 1. INSTALL | Allows installation/removal of sensors, and/or remotes. |
| 2. SET CLOCK | Enter time followed by am or pm. |
| 3. PHONE NUMS | Store up to six (16 digit) phone numbers. |
| 4. MESSAGE | 1. RECORD (This is your own alarm message)
2. REPLAY (Replays your message). |
| 5. NEW PIN | Enter new 4 digit PIN. |
| 6. MEMORY CLEAR | Clear all Sensors, Remotes, Timers, or Master Clear. |
| 7. OPTIONS | Set Chime On/Off, Siren On/Off, Set Housecode or Light Code. |
| 8. DELAYS | Set Exit, Entry, Dial, and Answer Delays. |
| 9. SET TIMER | Enter unit code, then On and Off time, then Daily, Once or Random. |

To leave the first level menu press the Clear button. If you are entering numbers (for the time, etc.), Clear will clear all numbers entered. Otherwise Clear gives the option of leaving the menu completely and going back to the HOME CONTROL mode, or staying in the INSTALL mode.

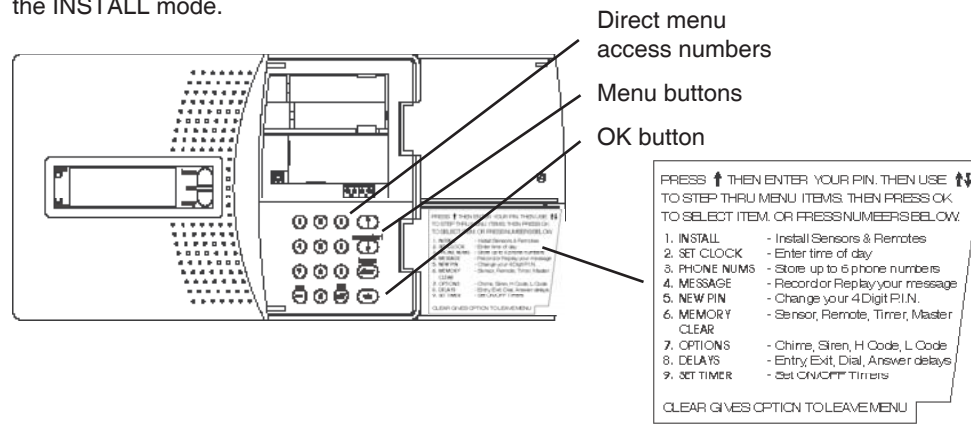

Installation

Sub-menus

Once you've arrived at your desired first level menu and pressed OK, you can select the sub-menus under that menu item. Alternatively you can go directly to the sub-menu item by pressing the appropriate number button.

Phone Numbers Sub-menu

Enter number up to 16 digits. Off/pm gives a pause.

- PHONE 1
- PHONE 2
- PHONE 3
- PHONE 4
- PHONE 5
- PHONE 6

Delays Sub-menu

All times are entered in seconds, up to 99.

- ENTRY DELAY
- EXIT DELAY
- DIAL DELAY
- ANSWER DELAY

Options Sub-menu

- | | |
|-----------|---|
| CHIME | 1. CHIME ON
2. CHIME OFF (No chimes when doors/windows are opened) |
| SIREN | 1. SIREN ON
2. SIREN OFF (Silent Alarm) |
| HOUSECODE | Chosen by Menu up/down buttons |
| LIGHTCODE | Chosen by Menu up/down buttons |

Memory Clear Sub-menu

- CLEAR ALL SENSORS
- CLEAR ALL REMOTES
- CLEAR ALL TIMERS
- MASTER RESET

Installation

Initializing Keychain Remotes

Press and hold the ARM button on the Keychain remote for 3-4 seconds and then release it. This initializes the remote and picks a random code that is used when it is registered with the Console. **Note, if the Keychain remote you purchased is different from shown here, refer to the installation instructions that came with it.**



Registering the Keychain Remote with the Console

Press either of the Menu up/down buttons (under the lid to the bottom right of the display). The display then shows ENTER PIN (Personal Identification Number) in the top line.

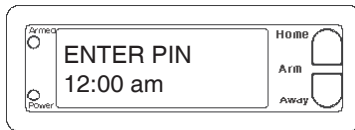

The default PIN is 0000, you'll find out later (page 24) how you can change this, but for now press 0000 on the keypad (under the lid to the bottom right of the display). This clears the top line and shows * for each number entered.

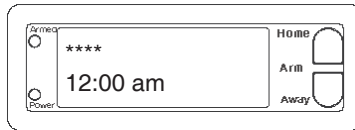

This takes you to the first level of the menu at step 1. This is the INSTALLATION level. When you see INSTALL on the display, press OK. The display then looks like this:



Now simply press any button on the Keychain remote. The Console acknowledges that it has been registered by beeping and displaying RMOT 1 SET, RMOT 2 SET, etc., as you install more remotes.

Repeat this for any other Keychain Remotes you want to register.

Press Clear to back out of the menu. You are asked to confirm, 1. YES, 2 NO. Pressing 1 takes you back to the HOME CONTROL screen. Pressing 2 takes you up one level of menu.

Installation

Initializing Door/Window Sensors

Remove the screw from the front of the Door/Window Sensor and install 2 AAA alkaline batteries inside. Observe polarity.

Set switch to MAX (left) for doors, or MIN (right) for windows.

Press and hold the button inside the Sensor for 3-4 seconds and then release it. This initializes the Sensor and picks a random code that is used when it is registered with the Console. Replace cover and place the magnet next to the Sensor (with the arrows aligned). See pages 14 and 15 if you want to use an additional magnetic contact switch. **Note, if the Sensors you purchased are different from shown here, refer to the installation instructions that came with them.**

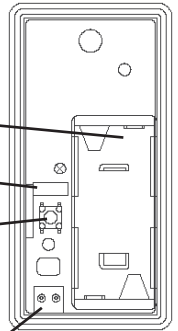

Registering Door/Window Sensors with the Console

Press either of the Menu up/down buttons (under the lid to the right of the display). The display then shows ENTER PIN (Personal Identification Number) in the top line.

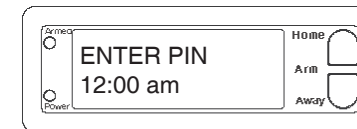

The default PIN is 0000, you'll find out later (page 24) how you can change this, but for now press 0000 on the keypad (under the lid to the bottom right of the display). This clears the top line and shows * for each number entered.

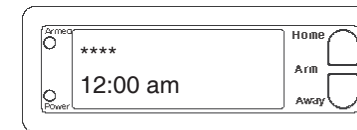

This takes you to the first level of the menu at step 1. This is the INSTALLATION level. The display looks like this:



Press OK and the display looks like this:



Installation

Now move the magnet away from the Door/Window Sensor. The Console acknowledges that it has been registered with a chime and by displaying ZONE 1 SET.

Repeat this for any other Door/Window Sensors you want to register. The display increments to ZONE 2 SET, etc., as you install more Door Window Sensors. If you connected a second magnetic switch to the contacts on the sensor (as shown on the next page) move its magnet away to install the second magnetic switch as a separate zone.

If desired, you can specify what zone you want the Door Window Sensor to be registered into. Just press the number of the zone you want on the Console's keypad, before you register the Door Window Sensor.

Press Clear to back out of the menu. After a short delay the display reverts to showing HOME CONTROL on the top line and the time of day on the bottom line.

Removing Door/ Window Sensors

Follow the steps above to install a sensor. Then when the display shows:



Press the number of the zone you desire (just as if you were going to register the Door/ Window Sensor into that zone) but instead of registering the Door/Window Sensor, press CLEAR on the Console's keypad. The display asks you to confirm the deletion:

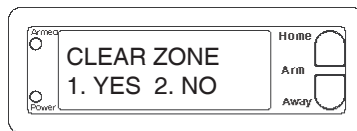

Pressing 1 on the Console's keypad changes the display to:



Where 13 is the zone you selected. Pressing 2 instead takes you back to the INSTALL ZONE screen.

Press Clear to back out of the menu. You are asked to confirm, 1. YES, 2 NO. Pressing 1 takes you back to the HOME CONTROL screen. Pressing 2 takes you up one level of menu.

Installation

Installing the Door/Window Sensors

Note, if the Sensors you purchased are different from shown here, refer to the installation instructions that came with them.

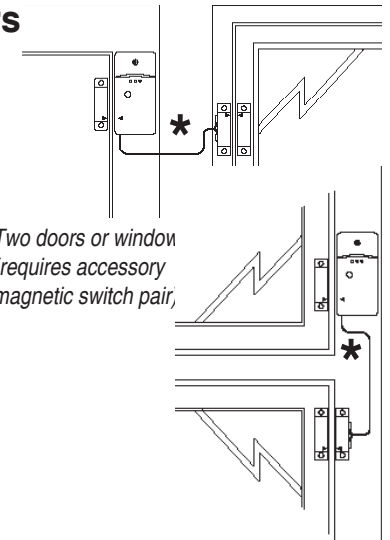
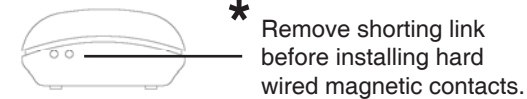
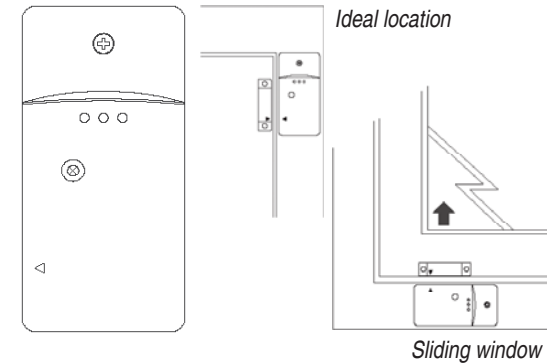

Note when you add a magnetic switch to a sensor you can register it with the console as its own zone, e.g., the sensor itself can be zone 1 and the extra magnet zone 2. See previous page.

- Attach the Door/Window Sensor to the wall using the mounting screws provided.
- Fit the Door/Window Sensor as high as possible at the top of the door/window.
- Make sure the arrows on the magnetic and the Door/Window Sensor are facing each other and that they separate cleanly when the door or window is opened.
- To protect two doors or windows close to each other, use the Door/Window Sensor with an additional set of magnetic switch contacts as shown in the diagrams above.
- Set the DELAY slide switch (inside the Sensor) to MIN to always trigger the alarm instantly (for windows), or to MAX to trigger the alarm after a preset entry delay when the system is armed in the AWAY mode (for doors).

The numbers 1 – 32 in the display refer to up to 32 “zones.” These represent up to 30 Door/Window Sensors and/or Motion Detectors you install, plus the 2 hard wired zones. The numbers show open zones, problem zones and bypassed zones by being displayed as steady on (door or window open), slow flash (there's a problem with that zone) or fast flash (that zone has been bypassed). Attempting to arm with an open or problem zone makes the Console beep continuously and it will display in words on the display what the cause is, but only for one zone at a time. Bypassing that zone (by pressing the Clear button) moves on to the next problem zone, if there is one.

Initializing Motion Detectors

Remove the cover on the front of the Motion Detector and install 2 AAA alkaline batteries in the compartment. Replace the cover. Press and hold the TEST button on the back of the Motion Detector for 3-4 seconds and then release it. This initializes the Motion Detector and picks a random code that is used when it is registered with the Console. Place the unit face down, so that it won't see any motion during the registering process below. **Note, if the Motion Detectors you purchased are different from shown here, refer to the installation instructions that came with them.**

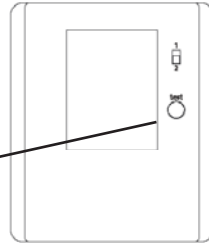

Registering the Motion Detector with the Console

Press either of the Menu up/down buttons (under the lid to the right of the display). The display then shows ENTER PIN (Personal Identification Number) in the top line.

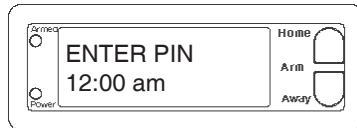

The default PIN is 0000, you'll find out later (page 24) how you can change this, but for now press 0000 on the keypad (under the lid to the bottom right of the display). This clears the top line and shows * for each number entered.

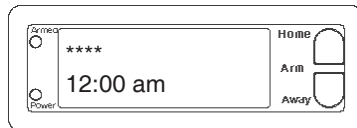

This takes you to the first level of the menu at step 1. This is the INSTALLATION level. The display looks like this:



Press OK and the display looks like this:



Now simply press the TEST button on the back of the Motion Detector (or turn the unit over so that it sees motion). The Console will acknowledge that it has been registered by displaying (for example) ZONE 3 SET.

Repeat this for any other Motion Detectors you want to register. The display increments to ZONE 4 SET, etc., as you install more Motion Detectors.

If desired, you can specify what zone you want the Motion Detector to be installed into. Just press the number of the zone you want on the Console's keypad, before you press the TEST button on the back of the Motion Detector.

Press Clear to back out of the menu. You are asked to confirm, 1. YES, 2 NO. Pressing 1 takes you back to the HOME CONTROL screen. Pressing 2 take you up one level of menu.

Removing Motion Detectors

Follow the steps above to install a Motion Detector. When the display shows:



Press the number of the zone you desire (just as if you were going to register the Motion Detector into that zone) but instead of pressing the TEST button on the Motion Detector (to register it) press CLEAR on the Console's keypad. The display ask you to confirm the deletion:

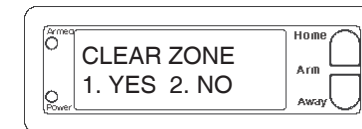

Pressing 1 on the Console's keypad changes the display to:



Where 13 is the zone you selected. Pressing 2 instead takes you back to the INSTALL ZONE screen.

Press Clear to back out of the menu. You are asked to confirm, 1. YES, 2 NO. Pressing 1 takes you back to the HOME CONTROL screen. Pressing 2 takes you up one level of menu.

Installation

Installing the Motion Detector

- Attach the Motion Detector to a wall at a height of 5 to 6 ft. using the mounting bracket and screws provided.
- Point the Motion Detector so that it looks slightly downwards.
- Set the slide switch (on the back) to position 1 for instant triggering for maximum sensitivity or position 2 to trigger only after two movements have been sensed.

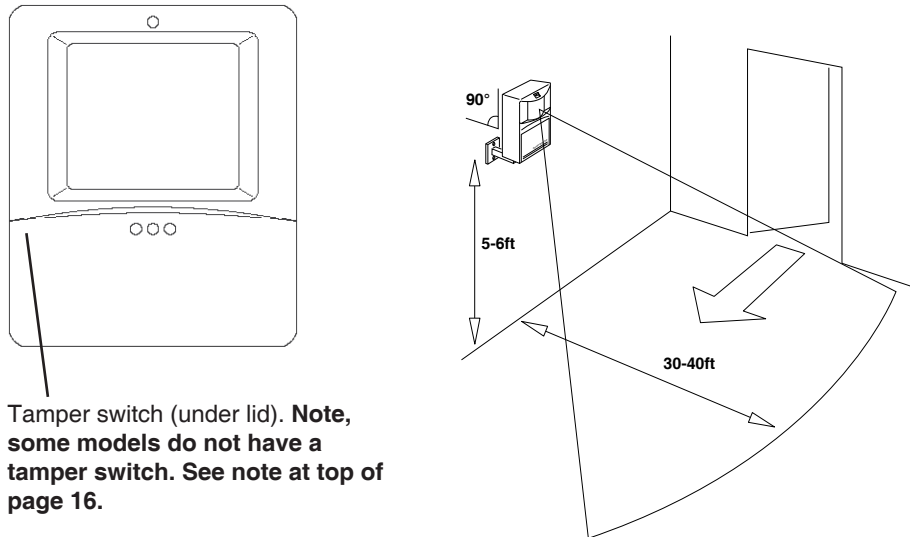

Testing the Motion Detector

- Set the slide switch on the Motion Detector to position 1.
- Press and hold the TEST button for about a second (until the LED flashes twice) and then release it.
- Wait 20 seconds for the Motion Detector to settle.
- Walk in front of the Motion Detector. The indicator LED lights each time it senses movement. Check the coverage area and reposition the sensor as required.
- Press the TEST button to return to normal operating mode.

Note: The Motion Detector will automatically return to normal operating mode after about 2 minutes.

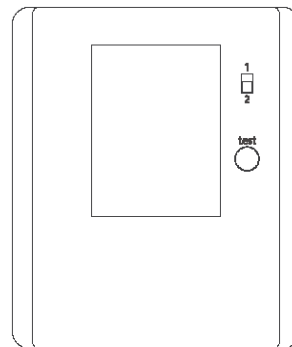

Installation

Hard-Wired Inputs

You can also connect two hard-wired magnetic contact switches to the console.

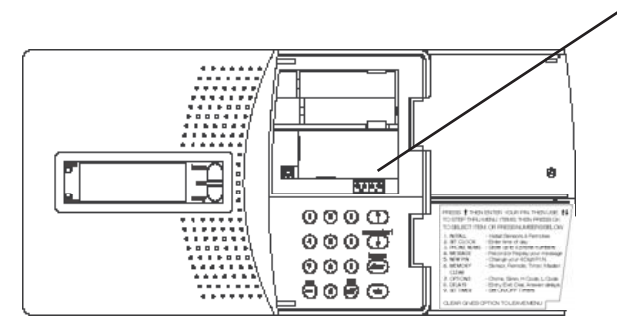

These will be zones 31 and 32.

You can install a total of 30 additional zones, which can be a combination of Door/Window Sensors and Motion Detectors. So, for example, you could have 15 Door/Window Sensors, 15 Motion Detectors, and 2 hard-wired zones. The hard wired zones are treated as delayed zones (i.e. they have exit and entry delays if you arm the system in the Away mode).

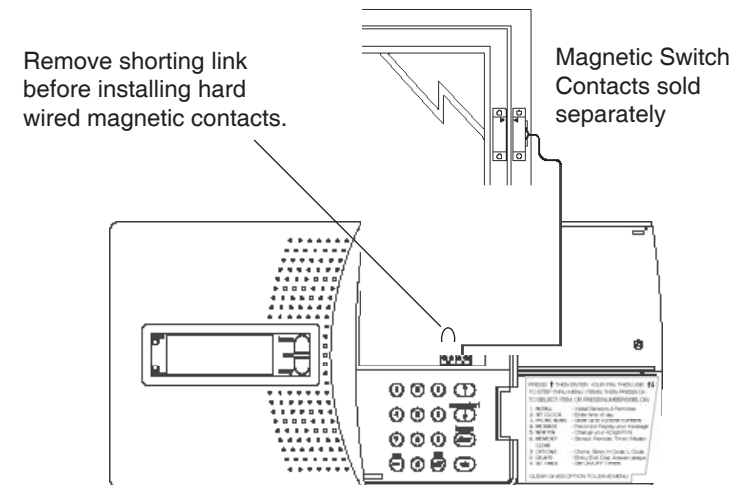

Installation

Setting the Clock

Press either of the Menu up/down buttons (under the lid to the bottom right of the display). The display then shows ENTER PIN (Personal Identification Number) in the top line.

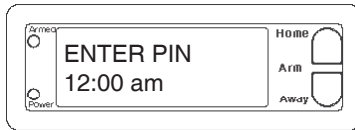

The default PIN is 0000, you'll find out later (page 24) how you can change this, but for now press 0000 on the keypad (under the lid to the bottom right of the display). This clears the top line and shows * for each number entered.

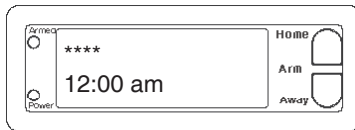

This takes you to the first level of the menu at step 1. This is the INSTALLATION level. The display looks like this:



Press an up or down menu button until you reach the SET CLOCK menu, and then press OK (or press 2 to go directly to the screen below):

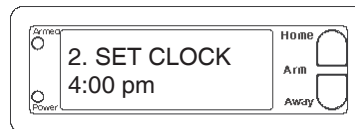

Enter the time by pressing the digits on the Console's keyboard. Then press am or pm. Then press OK.

Press Clear to back out of the menu. If you press Clear while entering numbers, before you're finished setting the clock, it clears the numbers. If you press Clear after you've set the time and pressed OK, you are asked to confirm, 1. YES, 2 NO. Pressing 1 takes you back to the HOME CONTROL screen. Pressing 2 stays in INSTALL mode.

Installation

Setting the phone numbers

Press either of the Menu up/down buttons (under the lid to the bottom right of the display). The display then shows ENTER PIN (Personal Identification Number) in the top line.

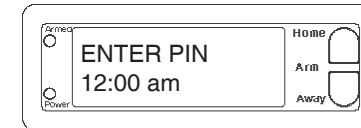

The default PIN is 0000, you'll find out later (page 24) how you can change this, but for now press 0000 on the keypad (under the lid to the bottom right of the display). This clears the top line and shows * for each number entered.

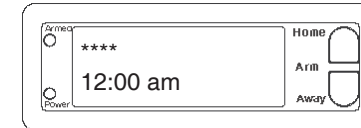

This takes you to the first level of the menu at step 1. This is the INSTALLATION level. The display looks like this:



Press an up or down menu button until you reach the PHONE NUMS menu, and then press OK to go to the screen below (or press 3 to go into the PHONE NUMS menu):

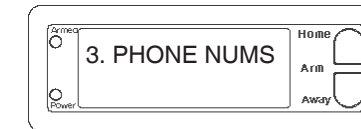

Press an up or down Menu button to select the desired sub-menu:

- PHONE 1
- PHONE 2
- PHONE 3
- PHONE 4
- PHONE 5
- PHONE 6

Press OK at the desired number (1-6). The display shows SET PH1, SET PH2, etc. Enter the phone number, up to 16 digits. off/pm gives a pause. Press OK. This takes you to the next phone number to be stored.

Press Clear to back out of the menu. If you press Clear while entering numbers, before you've finished setting the phone number, it clears the numbers. If you press Clear after you finished entering the phone number and pressed OK, you are asked to confirm, 1. YES, 2 NO. Pressing 1 takes you back to the HOME CONTROL screen. Pressing 2 stays in INSTALL mode.

Installation

Recording your outgoing phone message

Press either of the Menu up/down buttons (under the lid to the bottom right of the display). The display then shows ENTER PIN (Personal Identification Number) in the top line.

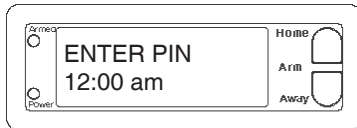

The default PIN is 0000, you'll find out later (page 24) how you can change this, but for now press 0000 on the keypad (under the lid to the bottom right of the display). This clears the top line and shows * for each number entered.

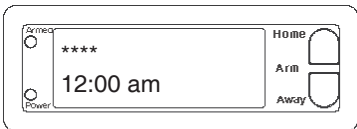

This takes you to the first level of the menu at step 1. This is the INSTALLATION level. The display looks like this:



Press an up or down menu button until you reach the MESSAGE menu, and then press OK to go to the screen below (or press 4 to go into the MESSAGE menu):



Press 1 or 2 to select one of the options below:



1. RECORD (This is your own alarm message).
2. REPLAY (This replays a previously recorded message).

Installation

Press 1 for RECORD, then press OK. The display shows:

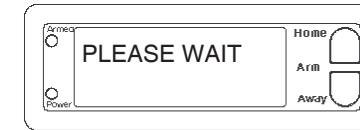

Then:

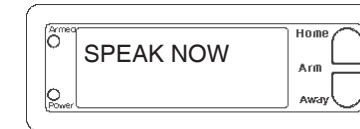

Clearly speak your message into the Console's microphone (up to 12 seconds max.). A typical message could be: "There's an alarm in progress at (your address), at the end of this message please press any button on your touch-tone phone to listen in." After you've finished speaking (12 seconds max), wait for the display shown below:



Now press 2 for REPLAY the display shows:

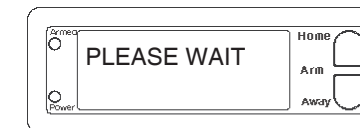

It then plays back your recorded message. Wait for the display shown below:

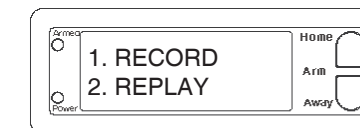

Press Clear to back out of the menu. You are asked to confirm, 1. YES, 2 NO. Pressing 1 takes you back to the HOME CONTROL screen. Pressing 2 stays in the INSTALL mode.

Note: you cannot record messages remotely via telephone.

Installation

Changing your Personal Identification Number (PIN)

Press either of the Menu up/down buttons (under the lid to the bottom right of the display). The display then shows ENTER PIN (Personal Identification Number) in the top line.

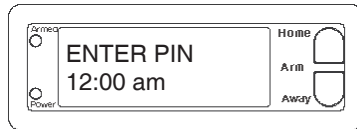

The default PIN is 0000, so press 0000 on the keypad (under the lid to the bottom right of the display). This clears the top line and shows * for each number entered.

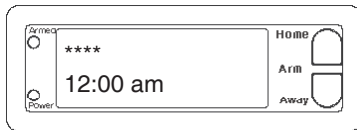

This takes you to the first level of the menu at step 1. This is the INSTALLATION level. The display looks like this:



Press an up or down menu button until you reach the NEW PIN menu, and then press OK (or press 5 to go directly to the screen below):



Enter your new PIN (4 digits). Press OK.

Note, choose a PIN that you are not likely to forget (a birthday, for example). If you forget your PIN you will not be able use the system. If you do forget your PIN contact www.x10.com to find out how to reset your system.

Press Clear to back out of the menu. If you press Clear while entering numbers, before you're finished setting the new PIN, it clears the numbers. If you press Clear after you've set the new PIN and pressed OK, you are asked to confirm, 1. YES, 2 NO. Pressing 1 takes you back to the HOME CONTROL screen. Pressing 2 stays in INSTALL mode.

Installation

Clearing the memory

Press either of the Menu up/down buttons (under the lid to the bottom right of the display). The display then shows ENTER PIN (Personal Identification Number) in the top line.

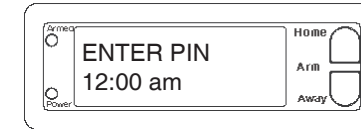

The default PIN is 0000, you'll find out later (page 24) how you can change this, but for now press 0000 on the keypad (under the lid to the bottom right of the display). This clears the top line and shows * for each number entered.

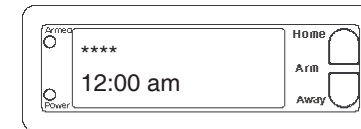

This takes you to the first level of the menu at step 1. This is the INSTALLATION level. The display looks like this:



Press an up or down menu button until you reach the MEMORY CLEAR menu, and then press OK to go to the screen below (or press 6 to go into the MEMORY CLEAR menu):

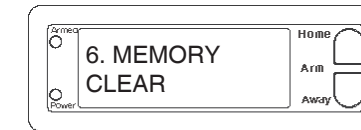

Press an up or down Menu button to select the desired sub-menu.

CLEAR ALL SENSORS
CLEAR ALL REMOTES
CLEAR ALL TIMERS
MASTER RESET

Select the desired sub-menu item and then press OK. Press Clear to back out of the menu. You are asked to confirm, 1. YES, 2 NO. Pressing 1 takes you back to the HOME CONTROL screen. Pressing 2 stays in the MEMORY CLEAR menu. Note, selecting 4. MASTER RESET immediately takes you back to the HOME CONTROL screen.

Installation

Setting Options

Press either of the Menu up/down buttons (under the lid to the bottom right of the display). The display then shows ENTER PIN (Personal Identification Number) in the top line.

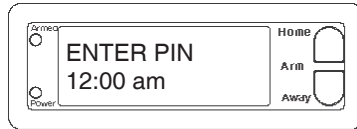

The default PIN is 0000, you'll find out later (page 24) how you can change this, but for now press 0000 on the keypad (under the lid to the bottom right of the display). This clears the top line and shows * for each number entered.

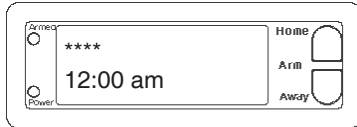

This takes you to the first level of the menu at step 1. This is the INSTALLATION level. The display looks like this:



Press an up or down menu button until you reach the OPTIONS menu, and then press OK to go to the screen below (or press 7 to go into the OPTIONS menu):



Press an up or down Menu button to select the desired sub-menu:

- | | |
|-----------|--|
| CHIME | 1. CHIME ON |
| | 2. CHIME OFF (No chimes when doors/windows are opened) |
| SIREN | 1. SIREN ON |
| | 2. SIREN OFF (Silent Alarm) |
| HOUSECODE | (Chosen by Menu up/down buttons) |
| LIGHTCODE | (Chosen by Menu up/down buttons) |

Select the desired sub-menu item and then press OK. Press 1 or 2 in CHIME and SIREN sub-menus. Select the desired Housecode letter, or desired Security Light Code, using the up/down buttons. Press OK. Press Clear to back out of the menu. You are asked to confirm, 1. YES, 2 NO. Pressing 1 takes you back to the HOME CONTROL screen. Pressing 2 stays in INSTALL mode.

Installation

Setting Delays

Press either of the Menu up/down buttons (under the lid to the bottom right of the display). The display then shows ENTER PIN (Personal Identification Number) in the top line.

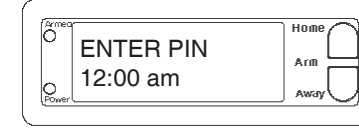

The default PIN is 0000, you'll find out later (page 24) how you can change this, but for now press 0000 on the keypad (under the lid to the bottom right of the display). This clears the top line and shows * for each number entered.

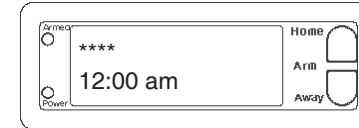

This takes you to the first level of the menu at step 1. This is the INSTALLATION level. The display looks like this:



Press an up or down menu button until you reach the DELAYS menu, and then press OK to go to the screen below (or press 8 to go into the DELAYS menu):



Press the up or down Menu button to select the desired sub-menu:

- | | |
|--------------|----------------------|
| ENTRY DELAY | (Default 30 seconds) |
| EXIT DELAY | (Default 60 seconds) |
| DIAL DELAY | (Default 5 seconds) |
| ANSWER DELAY | (Default 30 seconds) |
- Select the desired sub-menu item and then press OK. Then enter the desired delay time in seconds up to 99. Press OK.

Press Clear to back out of the menu. You are asked to confirm, 1. YES, 2 NO. Pressing 1 takes you back to the HOME CONTROL screen. Pressing 2 stays in INSTALL mode. Pressing Clear while entering a number (for a delay time) just clears the numbers.

Installation

Setting Timers

Press either of the Menu up/down buttons (under the lid to the bottom right of the display). The display then shows ENTER PIN (Personal Identification Number) in the top line.

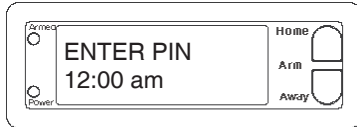

The default PIN is 0000, you'll find out later (page 24) how you can change this, but for now press 0000 on the keypad (under the lid to the bottom right of the display). This clears the top line and shows * for each number entered.

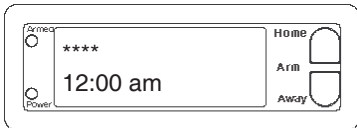

This takes you to the first level of the menu at step 1. This is the INSTALLATION level. The display looks like this:



Press an up or down menu button until you reach the SET TIMER menu, and then press OK to go to the screen below (or press 9 to go to the NEW TIMER menu):

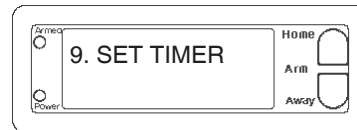

You will see NEW TIMER on the top line. If no timers have yet been entered the up and down Menu buttons will do nothing. If there are other timers already in memory the up and down buttons will cycle around them and will always include NEW TIMER in the loop if there is empty space in the memory.



Installation

To enter a new timer you must be on the NEW TIMER screen. Then press OK. The display shows UNIT NUMBER on the top line. Using the number keys, enter a valid number (1-16) and press OK.

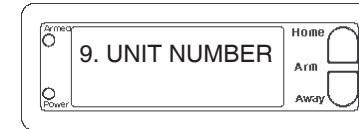

Say for example you enter 12. The top line displays TIMER 12 ON. The bottom line displays a colon, :

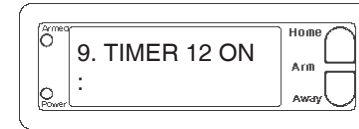

Enter your desired ON time with the number keys followed by **am** or **pm** in the format shown below, (or just press OK if you don't want to set an ON time). Press Clear if you enter a wrong time.

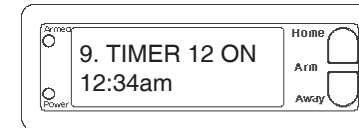

Then press OK. The top line displays TIMER 12 OFF. The bottom line displays a colon, :

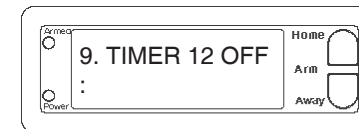

Enter the OFF time as above and press OK, (or just press OK if you don't want to set an OFF time). Press Clear if you enter a wrong time. The display shows 1. DAILY on the bottom line (top line blank).



Using the up or down Menu buttons you can cycle around 1. DAILY, 2. ONCE ONLY, and 3. RANDOM. Select the one of your choice and press OK. The display again shows NEW TIMER. Now the up and down Menu buttons will cycle through the entered events in the form
12ON 12:34am
OFF 12:45pm

Note you can set a total of 12 "timer pairs" i.e. ON-OFF times. If you choose to set an ON time with no corresponding OFF time for that unit code (or vice versa) it still counts as a "timer pair." RANDOM varies the time during the programmed hour.

Installation

Reviewing/Canceling Timers

Press either of the Menu up/down buttons (under the lid to the bottom right of the display). The display then shows ENTER PIN (Personal Identification Number) in the top line.

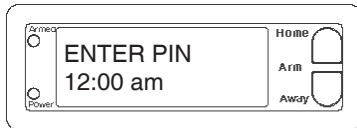

The default PIN is 0000, you'll find out later (page 24) how you can change this, but for now press 0000 on the keypad (under the lid to the bottom right of the display). This clears the top line and shows * for each number entered.

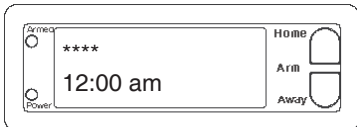

This takes you to the first level of the menu at step 1. This is the INSTALLATION level. The display looks like this:



Press an up or down menu button until you reach the SET TIMER menu, and then press OK to go to the screen below (or press 9 to go into the SET TIMER menu):



You will see NEW TIMER on the top line. If no timers have yet been entered the up and down Menu buttons will do nothing. If there are other timers already in memory the up and down buttons will cycle around them and will always include NEW TIMER in the loop if there is empty space in the memory.

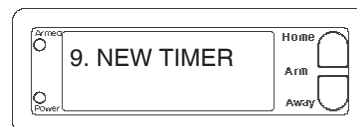

Installation

You can cycle through (Review) your stored timers by pressing the up or down Menu buttons. This will show the stored timers in the form below

12ON 12:34am
OFF 12:45pm

While a timer is on the display, pressing Clear deletes it. You are first asked: CLEAR TIMER 1. YES 2. NO .

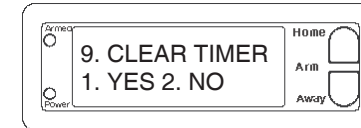

Pressing 1 (for YES) deletes the timer and takes you to NEW TIMER to allow you to start entering a new timer. Pressing 2 takes you to NEW TIMER without deleting the one that was on the screen. Press Clear to back out of the Menu.

Replacing Timers

You can cycle through (Review) your timers by pressing the up or down Menu buttons. This will show the stored timers in the form below

12ON 12:34am
OFF 12:45pm

While a timer is on the display, pressing OK takes you to the Replace Timer screen below.

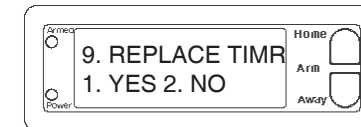

Selecting 1 for YES, takes you to the UNIT NUMBER screen below where you can continue to enter a new timer as described on page 29. Selecting 2 for NO takes you to the NEW TIMER screen so you can enter a new timer without replacing the existing one. Press Clear the back out of the menus.

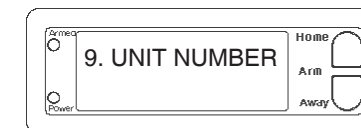

Note you can also clear ALL timers as described on page 25.

Using the system

Arming the system

Press ARM HOME on the Console to arm all Door/Window Sensors instantly. Motion Detectors will not trip the system when it is armed in the ARM HOME mode.

Press ARM AWAY to arm all Door/Window Sensors and Motion Detectors. This arms the system after a set delay. The delay will be what you specified as the EXIT DELAY on page 27 (1 minute default). If you arm the system in the AWAY mode you will also have an entry delay when you enter your home before the alarm trips, to give you time to disarm it. This delay will be what you specified for your ENTRY DELAY on page 27 (30 second default).

Pressing ARM on the Keychain remote always arms in the AWAY mode, but arms instantly.

Disarming the system

Pressing DISARM on the Keychain remote disarms the system instantly. The zone that was violated is shown in the display.

To remove this press Arm and Disarm again.

To disarm from the Console: Enter your 4 digit PIN (Personal Identification Number) this will be 0000 unless you changed it (see page 24).

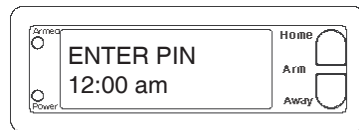

Entering the PIN clears the top line and shows * for each number entered.

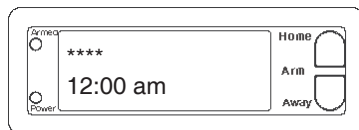

If the unit was armed, (in either ARMED HOME or ARMED AWAY modes) it will disarm when the PIN is entered, and return to the time display, with DISARMED in the top line.



Using the system

If there's a problem

If a door or window is open and you try to arm the system the display looks as below. Where ZONE 9 is the door or window that's open.

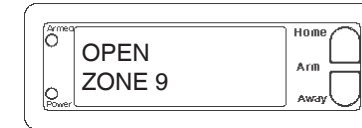

If a Door/Window Sensor or Motion Detector has not reported in within the last 4 hours and you try to arm the system the display shows:

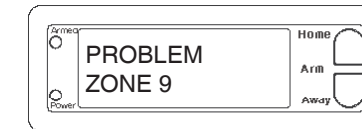

If a Door/Window Sensor has been tampered with, e.g. the cover is open, and you try to arm the system the display shows:

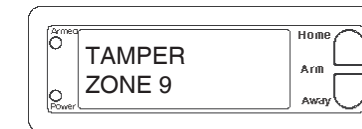

For all the above situations, pressing the Clear (Bypass) button bypasses the problem zone and lets you arm the system. After pressing Bypass the next problem zone is displayed, (if there is more than one).

You can't arm the system while there's a problem zone unless you fix the problem, or bypass the zone. If you try to arm the system while there's a problem with one or more zone you will hear a repetitive "trouble alarm" to alert you that you need to bypass or fix the problem zone(s).

Note also, if the Console itself has been tampered with, i.e. the door to the upper right of the display is open, the problem must be fixed (close the door) before you can arm the system. **Note if the system is armed and this door is tampered with, the alarm trips.**

If you bypass a zone and then arm the system, that zone stays bypassed until you disarm the system.

Using the system

When there's an alarm

When the system is armed (in Home or Away mode) and you open a protected door or window, or walk past a Motion Detector (if armed in the Away Mode), or activate the Panic feature (by pressing Arm and Disarm at the same time on the Key Chain Remote) the alarm trips. The following then happens:

A loud siren sounds.

Lights (set to the two security codes) flash on and off (if you set up X10 Modules). See page 36.

The Console dials the first phone number you set up. It then starts to play the recorded message you stored. E.G. *"There's an alarm in progress at (your address), at the end of this message please press any button on your touch-tone phone to listen in."* Note, it might take a while before the person the Console called picks up the phone so they might miss the first part of your message, but the message is repeated 3 times, so they will get to hear the complete message.

When the person who was called answers the call and presses a button on their phone this activates a microphone in the Console and they will be able to listen in to you home, and will be able to determine if there is suspicious activity going on. They can then take action. E.G. call the Police for you.

IMPORTANT: Do NOT program the Console to call the Police directly.

NOTES:

The person who answers the phone needs to wait for a gap between the messages before they can press a button on their phone to listen in (the message repeats three times, but might have already played once or twice before the person answers the phone).

If no one answers the call (and presses a button on their phone) before the third message is played, the Console dials the next number stored. It can take quite a long time to dial all the numbers if you've stored 6 of them, and no one answers. But the siren stops sounding after 4 minutes in any case (the unit still dials all the numbers stored unless someone answers the call (and presses a button on their phone).

If the system is tampered with

If the system is armed and someone tampers with (opens the cover) on a Door/Window Sensor or the Console, the same thing happens as when the alarm is tripped by any other method. If the system is **NOT** armed and someone tampers with a Sensor or the Console, the word TAMPER appears in the display but the system does not trip. You must fix the tamper before you can arm the system. Press Arm then Disarm to remove the word TAMPER from the display.

Controlling Lights and Appliances

If you install one or more Lamp Modules (sold separately), see next page, you can control lights around your home from the Console. When the Console is in its normal state it displays HOME CONTROL in the display. When its in this state you can simply press the number button on the Console corresponding to the number set on the module and then press On or Off on the Console's control panel to control the light connected to the module.

You can also control lights set to your Security LIGHTCODEs from the A and B buttons on the Key Chain Remote. The A buttons on the Key Chain Remote control lights connected to X10 Modules that are set to the Security LIGHTCODE you set in the Console. (See step 4 on page 26). The B buttons control modules set to the next sequential number. I.E. if you set your Security LIGHTCODE to 1, the A and B buttons on the Key Chain Remote will control X10 Modules that are set to Unit Codes 1 and 2. If your Security LIGHTCODE is 10, the A and B buttons will control Modules 10 and 11. If your Security LIGHTCODE to 16, the A and B buttons will control 16 and 1, etc.

Any lights set to your two Security LIGHTCODEs flash on and off when the alarm trips. They stay on after an alarm until you turn them off, either from the Console, or from the Key Chain Remote.

These lights also blink on for a second when the alarm is armed in the HOME Mode, or turn on for the exit delay time when the alarm is armed in the AWAY Mode.

Refer to either version below depending on which version you purchased.

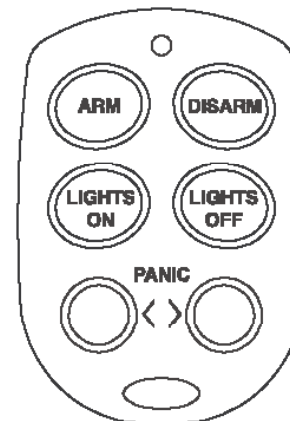

Pressing both PANIC buttons at the same time activates the panic alarm, even if the Console is not armed.

LIGHTS ON/OFF control lights connected to X10 Modules that are set to the Security LIGHT CODE you set in the Console (see page 26).

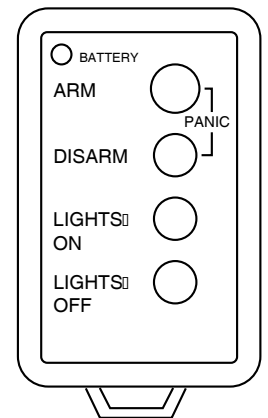

Optional Lamp Modules

Setting the (optional) Lamp Module's Code

Using a small screwdriver, set the red House Code dial to the same letter as your Console is set to. Set the Black Unit Code dial to any unused number.

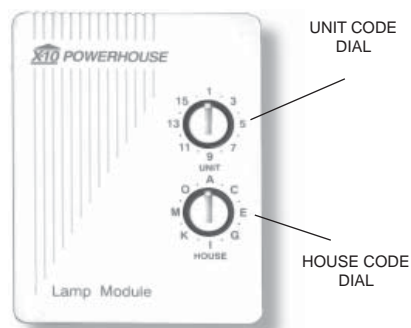

Ratings

The Lamp Module can be used to control an incandescent lamp rated up to 300W. It is not suitable for other types of lamps such as fluorescent or energy saving lamps, low voltage lamps, or lamps that include a dimmer control. **Caution:** Do not connect an appliance such as a coffee pot or heater to a Lamp Module. It may damage the Module and/or the appliance and could cause a fire hazard. Use an Appliance Module instead.

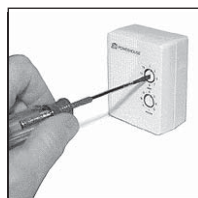

1 Set the House Code and Unit Code.



2 Plug a lamp into the Module.

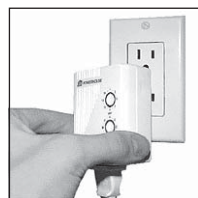

3 Plug the Module into the same wall outlet as your controller (see testing below).

Testing The Module

Make sure the lamp's switch is on. Plug the Module into the same wall outlet as your Console's power supply, press the On and Off buttons on the Console that correspond to the Unit Code setting on the Module. If the Module turns on and off you can unplug the Module and move it to its permanent location.

If you can't control the module, visit www.x10.com for help.

Operation from an Outside Telephone

The Console has remote telephone access, with voice responses to acknowledge receipt of remote commands.

When you call home, the Console answers and says "Please enter PIN." You enter your PIN using the touch tone buttons on the remote telephone.

If the PIN is entered correctly it says "PIN accepted". If wrong it says "Error."

Pressing 0, then * (on the remote telephone's touch tone keypad) arms the Console. Pressing 0, then # disarms the Console.

Pressing 9, then 9, then * tells you the current system status: I.E. it says Armed Home, Armed away, Disarmed, Panic alarm, or Alarm in zone (1 – 32).

The numbers 1 – 32 in the display refer to up to 32 "zones." These represent the Door/Window Sensors and/or Motion Detectors you installed. Therefore if the alarm tripped because zone 3 was violated, when you call in and press 9, 9, * you will hear "Alarm in zone 3."

Remotely controlling lights (or appliances) via telephone

If you install one or more X10 Modules (sold separately), see previous page, you can control lights and appliances around your home from any touch tone telephone in the world.

When you call home, the Console answers and says "Please enter PIN." If the PIN is entered correctly it says "PIN accepted". If wrong it says "Error." If you then press 4, then * on the touch tone phone, it says "4 On" and turns on any X10 Module(s) set to Unit Code 4 (and the same Housecode as the Console is set to). If you then press 1, then 6, then # on the touch tone phone, it says "16 Off" and turns off any X10 Module(s) set to Unit Code 16 (and the same Housecode as the Console is set to).

If you own an answering machine.

If you own an answering machine, you will normally set it to answer after a few rings. In this case, when the answering machine answers a call (or if there's someone home who picks up the phone), the security system will NOT answer the call and will NOT say "Please enter PIN." You can still however go ahead and enter the PIN to access the security system features above. Just wait until your answering machine finishes its outgoing message and then enter your security system PIN. Note, your answering machine will record the touch tones you hear when you press buttons to turn lights on and off, etc., and will also record the messages played back by the security system.

Battery Information

General

Door/Window Sensors, Motion Detectors and Keychain remotes are designed to operate for approximately one year when fitted with the appropriate batteries. Since operating conditions vary from installation to installation however, it is recommended that all batteries are replaced every 6 months.

Security Console

Battery backup

The batteries in the Security Console are used as a backup when there has been a power failure. The batteries provides approximately 12 hours of backup time provided the alarm has not been triggered.

While on battery backup, the Console will continue to operate, and will sound the siren and dial out if the alarm is tripped. It will not, of course, flash the house lights (because there's no AC power).

If both the AC supply and the batteries fail, the Console will no longer dial out or sound the siren. You will not lose its telephone numbers, recorded message, or installed sensors and remotes, but you will need to reset the clock for the correct time of day.

Battery Replacement

Batteries can be replaced at any time, even while the unit is powered up. There is no special procedure for battery replacement. Use 4 AA alkaline batteries.

Keychain Remotes

Battery Replacement

Providing the batteries have not already failed, they can be replaced with fresh batteries without the need to reregister the remote. After removing the old batteries fresh batteries must be fitted within 30 seconds to ensure that the security code is retained.

Gently pry the 2 halves of the Keychain Remote's case apart and install two CR2016 lithium batteries in the compartment (+ facing up). Press the 2 halves of the cabinet back together.

Once the batteries have been replaced, confirm that the remote is still registered with the Console by arming the system. If it does not arm, the code has been lost and you will need to proceed as described below.

If the batteries have failed completely, the remote's code will have been lost. The remote will need to be reinstalled following the procedure on page 12.

Battery Information

Door/Window Sensors and Motion Detectors

Battery Replacement

If a zone has not reported in to the Console during the last four hours, the display will show PROBLEM and the appropriate zone number when you try to arm the system. This is most likely caused by dead batteries in the Motion Detector or Door/Window Sensor for that zone.

As with the remotes, as long as the batteries have not completely failed they may be replaced with fresh batteries without the need to reinstall the Motion Detector or Door/Window Sensor. After removing the old batteries the new batteries must be fitted within 30 seconds to ensure that the code is retained.

Testing the Door/Window Sensor

Once the batteries have been replaced, the Door/Window Sensor should be tested as follows:

- Make sure the system is NOT armed.
- Open the door or window with the sensor attached. The Console chimes to acknowledge and the zone # is displayed on the LCD.
- If you don't hear a chime, reregister the Door/Window Sensor, as described on page 13

Testing the Motion Sensor

To test the Motion Detector:

- Make sure the system is armed.
- Press the TEST button on the back of the Motion Detector. The alarm trips. Press disarm on the Keychain Remote.
- If the alarm doesn't trip, reregister the Motion Detector, as described on page 16.

Clearing Remotes & Sensors from the Console

If you suspect that a neighbor's system is causing false alarms, or if you need to reinstall remotes, Door/Window Sensors, and Motion Detectors for any other reason, you can clear all sensors and remotes from the Console's memory by following the steps on page 25. Before reregistering your remotes, Door/Window Sensors, and Motion Detectors you should reinitialize them - remove the batteries, press a button for 5 seconds then refit the batteries. Then follow the steps to reinitialize the unit (pages 12, 13, or 16 as appropriate).

Troubleshooting

PROBLEM	SOLUTION
If the system does not arm.	<ul style="list-style-type: none"> Check that the indicator on the Remote turns on when you press ARM. Replace the batteries and reregister the Remote with the Console if necessary.
Console displays PROBLEM followed by Zone number when you try to arm it.	<p>One of the sensors/motion detectors has not reported in, in the last 4 hours.</p> <p>Check that the batteries in the sensor/ motion detector are good.</p> <p>Or a protected door or window is open.</p> <p>If you need to arm the system and want to ignore a sensor/motion detector which is not functioning:</p> <ol style="list-style-type: none"> Press CLEAR on the Console while the problems is being displayed. Then press ARM on the Remote. The problem zone is not protected but all other zones are armed.

Troubleshooting

PROBLEM	SOLUTION
If you hear a repetitive trouble alarm when you try to arm the system, and it does not arm.	<p>Check the Console's display. If a door or window is open, its zone # will indicate there's a PROBLEM.</p> <ul style="list-style-type: none"> Press DISARM. Check each Door/ Window Sensor is working properly and that no doors or windows are open. Then arm the system. <p>Or:</p> <ul style="list-style-type: none"> While the trouble alarm is sounding, press CLEAR on the Console to bypass the problem zone (the display shows that it has been BYPASSED). Then arm the system again. Or if the display shows TAMPER, check the cover on the Door/ Window Sensor for that zone. Or check that the upper right lid on the Console it closed.
If the alarm trips when you enter the house before you have time to disarm it.	Arm the system in the AWAY mode.
Lights will not turn on or off from the ON or OFF buttons on the Keychain Remote.	<ul style="list-style-type: none"> Be sure you set the correct SECURITY LIGHT Code in the Console, see pages 26 and 35. Be sure the light you are trying to control has its on/off switch in the on position. Be sure its bulb is good. Plug the Module into another outlet near the Console. Check that the indicator on the Remote comes on when you press a button. Replace batteries and reregister remote if necessary. Check the dials on the Modules.

Troubleshooting

PROBLEM	SOLUTION
You open a door or window and the alarm does not trip.	<ul style="list-style-type: none"> • Check that the system is armed. • Check to see if the alarm trips when you press TEST inside the Door/Window Sensor. • If the alarm does not trip when you press TEST, check that the indicator on the sensor comes on when you press TEST. <p>If the indicator does not come on, replace the batteries and reinstall the sensor if necessary.</p>
If appliances turn off during an alarm.	<p>The system flashes lights by repetitively transmitting the SECURITY light on and off codes.</p> <p>Any Appliance Modules set to the same codes will therefore turn on and off.</p>
If you do not hear a beep from the Console when you press ARM to install a Remote.	<ul style="list-style-type: none"> • Re-initialize the remote (see page 12).

Troubleshooting

PROBLEM	SOLUTION
If you do not hear a beep from the Console when you register a Door/Window Sensor or Motion Detector.	<p>With the Console NOT armed check that it chimes when you press TEST on the Door/Window Sensor, or the alarm trips when you press test on a Motion Detector (when the system IS armed). If it does, then the sensor is already installed and no further action is necessary. If not:</p> <ul style="list-style-type: none"> • Reregister the sensor/motion detector (see Setting Up Door/Window Sensors and Setting Up Motion Detectors).
If the battery indicator on the Console is on.	<p>Replace the Console's batteries. Four AA alkaline batteries provides approximately 12 hours of backup. Replace batteries at least once a year.</p>
If you lose your remote control.	<p>Reinstall your complete system to prevent someone else from using the lost remote control. See bottom of page 39.</p>
If the system Arms or Disarms by itself	<p>A neighbor may have a compatible system. Reinstall the complete system so that it chooses different RF codes. See bottom of page 39.</p>
If the light on the Keychain Remote stays on during initialization.	<p>Remove the batteries, press a button for a few seconds, release, then replace the batteries. Press and hold the ARM button on the Keychain Remote for a few seconds and then release it. This initializes the remote and picks a random code that is used when it is registered with the Console. Reregister the remote.</p>

Troubleshooting

PROBLEM	SOLUTION
The alarm cause is shown on the display even after disarming.	To remove, Arm and Disarm from a remote, or disarm by pressing a menu key and entering the PIN on the Console.
If the optional PowerHorn does not trip when the alarm trips.	<ul style="list-style-type: none">• Be sure you set the dials on the PowerHorn to the same SECURITY LIGHT code as set in the Console.• Plug the PowerHorn into another outlet near the Console.
The Motion Detector causes false alarms.	<ul style="list-style-type: none">• All brands of motion detectors sense motion by detecting a change in temperature, therefore do not place the detector near any sources of heat such as over a heating vent or an air conditioner.• Do not place in a direct source of bright light, such as sunlight.

Special Note

Intercom Systems

Intercom systems which send voice signals over existing electrical wiring may interfere with the ability to control modules from your security system with the intercom in use. If the intercom system has its own separate wiring it will not cause a problem.

LIMITED ONE YEAR WARRANTY

X10 Wireless Technology, Inc. Limited One Year Warranty

X10.com, a division of X10 Wireless Technology, Inc. (X10) warrants X10 products to be free from defective material and workmanship for a period of one (1) year from the original date of purchase at retail. X10 agrees to repair or replace, at its sole discretion, a defective X10 product if returned to X10 within the warranty period and with proof of purchase. If service is required under this warranty:

Call 1-800-442-5065, visit www.x10.com, or e-mail support@x10.com.

For help or more information on setup, please visit:

www.x10.com/support

Expanding Your System

The X10 Security System can flash lights on and off when the alarm trips. You connect the lights you want it to control to X10 Lamp Modules and Wall Switch Modules (sold separately). The Security Console also acts as a "Transceiver" and passes commands received from wireless remote controls onto your house wiring, so you can use X10 wireless remote controls to control the same lights that the Security System flashes. You can also use the X10 remote controls to control Appliance Modules, etc.

The Security Console also works with X10 EagleEye and ActiveEye wireless motion sensors, again acting as a Transceiver, to pass the commands from the motion sensors to the X10 Modules. The modules and controllers illustrated below represent just a few of the wide range of X10 modules you can choose from to expand your Security System.

Visit our Web Site at: ww.x10.com
for more information on these and many other X10 products.

*The **EagleEye and ActiveEye Motion Sensors MS14A and MS16A** can turn on lights when someone enters a room or approaches your home.*

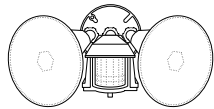

*The **Dual Floodlight Motion Detector PR511** turns on at dusk and/or when it detects movement, and sends X10 signals to control other modules, or to trigger ActiveHome Pro macros.*

*Fit a **Wireless Wall Switch SS13A/SS15A** anywhere you need an extra switch – with no wires. Sends commands to the Security Console, which passes them to the X10 modules, just like a remote control does.*



*Turn entrance or garage lights on from your car with the convenient **Keychain Remote KR21A** (or KR19A).*

*Replace your existing wall switches with the **Wall Switch Module WS467**. Installs like a regular dimmer. On/Off and Bright/Dim functions. Other models available for 3-way and fluorescent lighting.*

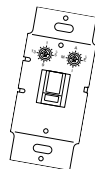

Expanding Your System



*Control an incandescent ceiling light, closet light, etc., with the convenient **Screw-in Lamp Module LM15A**.*

*Replace existing AC wall outlets with the **Receptacle Module SR227**. Has one 15A/1800W controlled outlet and one outlet which is always on.*

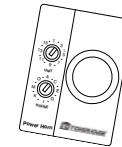
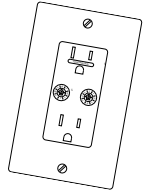

*Use a controller to trigger the **Remote Chime Module SC546** to call Dad for dinner, or warn people you're about to turn on the sprinklers.*

*Use the isolated contacts on the **Universal Module UM506** to control pool pumps, sprinklers, drapes and other low voltage equipment. Includes built in warning beeper.*

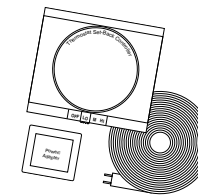

*The **Thermostat Setback Controller TH2807** mounts below your thermostat to reduce the room temperature at night or at the times you set to save energy. No wiring needed to your existing thermostat.*

*Plug in a **Heavy Duty Module HD245** to control 220V appliances such as air conditioners and water heaters.*



Also compatible with ActiveHome Pro, and FireCracker Computer Interface.

Visit www.x10.com for more details.

You can add X10 2.4 GHz wireless cameras to your system. These work independently of your security system but can be remotely controlled using the same remote controls that you use to turn lights and appliances on and off remotely. This adds another level of protection for your home – not only will your security system trip if someone breaks in, but you can also use X10 cameras with your VCR to capture images of the burglar!

There is even software available that lets your PC capture images from X10 cameras and e-mail them to you.

The Vanguard Professional Pan/Tilt/Zoom Camera is X10's premier video surveillance solution. It has superior image quality, a high powered zoom, and pan and tilt motion. You can operate the camera through walls using the remote control included with it.

The camera uses X10's 2.4 GHz wireless technology to transmit live video through walls to a television up to 100 feet away. If you prefer a secure video connection, you can use a video cable to connect the camera directly to your TV.

You can combine multiple cameras to provide comprehensive coverage of your home or business. Use the remote control to switch between cameras so that you don't miss anything that goes on.



VCR Commander

Record only when there's movement in your camera's field of view. The VCR Commander issues "STOP" and "START" commands to your VCR anytime there's movement within 30 feet of your camera.



Visit www.x10.com for more details.

Ninja Pan 'n Tilt Unit

Increase the viewable area of your camera by 400%. The standard XCam2 records everything within a 60° x 60° field of view. But with the Ninja Robotic Mount, you get sweeping 240° x 130° views.



XRy Vision

Monitor your home from any city in the world! With XRy Vision Software you can monitor your home from any computer with an Internet connection.

E-mail video snapshots to your personal account or view them on your own secure Web Site.

**X10.com, a Division of
X10 Wireless Technology, Inc.
400 Forge Way, Suite 409-412,
Rockaway, NJ 07866**

SC1200 -12/10
Supervised Security System

Free Manuals Download Website

<http://myh66.com>

<http://usermanuals.us>

<http://www.somanuals.com>

<http://www.4manuals.cc>

<http://www.manual-lib.com>

<http://www.404manual.com>

<http://www.luxmanual.com>

<http://aubethermostatmanual.com>

Golf course search by state

<http://golfingnear.com>

Email search by domain

<http://emailbydomain.com>

Auto manuals search

<http://auto.somanuals.com>

TV manuals search

<http://tv.somanuals.com>