

*Indoor/Outdoor Color Camera
with Built-in 2.4 GHz Wireless
Video Sender, plus X10
controlled power supply, and
separate Video Receiver.*

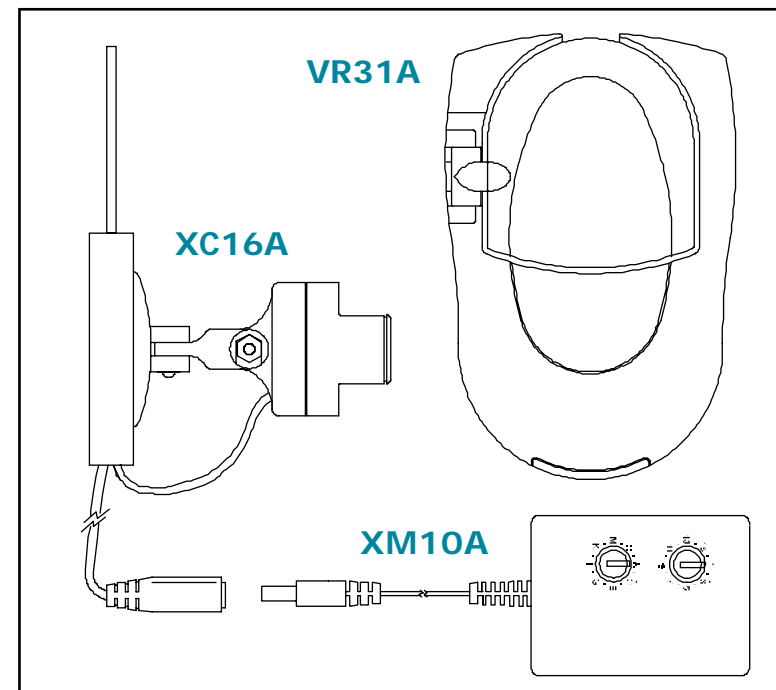

OWNER'S MANUAL



MODEL VK58A

**(INCLUDES XC16A CAMERA, XM10A ADDRESSABLE
POWER SUPPLY, AND VR31A VIDEO RECEIVER)**

INTRODUCTION

Your Wireless Camera Kit consists of a Color Video Camera with built-in 2.4 GHz Video Sender, and a Video Receiver unit which you connect to a TV anywhere in your home (up to 100 ft. away from the Camera). The Camera/Video Sender converts the video and audio signals from the camera into a radio signals and transmits them (even through walls) to the Video Receiver. The Video Receiver converts the signals back to video and audio signals which are fed through a cable to your TV's COAX or A/V input jacks.

Also included is a remote controlled power supply, Model XM10A, which lets you turn the camera on and off by remote control from any X10 remote control (sold separately). You can purchase additional cameras and power supplies so you can have a multiple camera system. You can then set all cameras to the same channel as the receiver and turn the cameras on and off remotely so as to only ever have one camera turned on at a time.

There are just a few simple steps to follow to hook up your Camera and Video Sender kit.

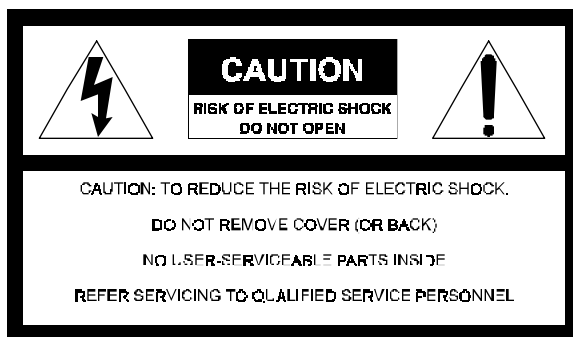

WARNING:

To reduce the risk of fire or electric shock, do not expose this product to rain or moisture.

IMPORTANT SAFETY INSTRUCTIONS

1. Read Instructions - All the safety and operating instructions should be read before the product is operated.
2. Retain Instructions - The safety and operating instructions should be retained for future reference.
3. Heed Warnings - All warnings on the product and in the operating instructions should be adhered to.
4. Follow Instructions - All operating and use instructions should be followed.
5. Cleaning - Unplug this product from the wall outlet before cleaning. Do not use liquid cleaners or aerosol cleaners. Use a damp cloth for cleaning.
6. Attachments - Do not use attachments not recommended by the product manufacturer as they may cause hazards.
7. Water and Moisture - Do not use this product near water - for Example, near a bath tub, wash bowl, kitchen sink, or laundry tub, in a wet basement, or near a swimming pool; and the like.
8. Accessories - Do not place this product on an unstable cart, stand, tripod, bracket, or table. The product may fall, causing serious injury to a child or adult, and serious damage to the product. Use only with a cart, stand, tripod, bracket, or table recommended by the manufacturer, or sold with the product. Any mounting of the product should follow the manufacturer's instructions, and should use a mounting accessory recommended by the manufacturer.
9. A product and cart combination should be moved with care. Quick stops, excessive force and uneven surfaces may cause the product and cart combination to overturn.
10. Ventilation - Slots and openings in the cabinet are provided for ventilation and to ensure reliable operation of the product and to protect it from overheating, and these openings must not be blocked or covered. The openings should never be blocked by placing the product on a bed, sofa, rug, or other similar surface. This product should not be placed in a built-in installation such as a bookcase or rack unless proper ventilation is provided or the manufacturer's instructions have been adhered to.





11. Power Sources - This product should be operated only from the type of power source indicated on the marking label. If you are not sure of the type or power supply to your home, consult your product dealer or local power company. For products intended to operate from battery power, or other sources, refer to the operating instructions.
12. Grounding or Polarization - This product is equipped with a polarized alternating current line plug (a plug having one blade wider than the other). This plug will fit into the power outlet only one way. This is a safety feature. If you are unable to insert the plug fully into the outlet, try reversing the plug. If the plug should still fail to fit, contact your electrician to replace your obsolete outlet. Do not defeat the safety purpose of the polarized plug.
13. Power-Cord Protection - Power supply cords should be routed so that they are not likely to be walked on or pinched by items placed upon or against them, paying particular attention to cords at plugs, convenience receptacles, and the point where they exit from the product.
14. Lightning - For added protection for this product during a lightning storm, or when it is left unattended and unused for long periods of time, unplug it from the wall outlet and disconnect the antenna or cable system. This will prevent damage to the product due to lightning and power-line surges.
15. Overloading - Do not overload wall outlets, extension cords, or integral convenience receptacles as this can result in a risk of fire or electric shock.
16. Object and Liquid Entry - Never push objects of any kind into this product through openings as they may touch dangerous voltage points or short-out parts that could result in a fire or electric shock. Never spill liquid of any kind on the product.
17. Servicing - Do not attempt to service this product yourself as opening or removing covers may expose you to dangerous voltage or other hazards. Refer all servicing to qualified service personnel.
18. Damage Requiring Service - Unplug this product from the wall outlet and refer servicing to qualified service personnel under the following conditions:
 - a) When the power-supply cord or plug is damaged,
 - b) If liquid has been spilled, or objects have fallen into the product,



- c) If the product has been exposed to rain or water,
 - d) If the product does not operate normally by following the operating instructions. Adjust only those controls that are covered by the operating instructions as an improper adjustment of other controls may result in damage and will often require extensive work by a qualified technician to restore the product to its normal operation,
 - e) If the product has been dropped or damaged in any way, and
 - f) When the product exhibits a distinct change in performance - this indicates a need for service.
19. Heat - The product should be situated away from heat sources such as radiators, heat registers, stoves, or other products including amplifiers) that produce heat.

FCC CAUTION

THIS DEVICE COMPLIES WITH PART 15 OF THE FCC RULES.

OPERATION IS SUBJECT TO THE FOLLOWING TWO CONDITIONS:

- (1) THIS DEVICE MAY NOT CAUSE HARMFUL INTERFERENCE, AND
- (2) THIS DEVICE MUST ACCEPT ANY INTERFERENCE RECEIVED, INCLUDING INTERFERENCE THAT MAY CAUSE UNDESIRABLE OPERATION.

This equipment generates and uses radio frequency energy, and if not installed and used properly, that is, in strict accordance with the manufacturers instructions, it may cause interference to radio and television reception. It has been type tested and found to comply with the limits for remote control devices in accordance with the specifications in Sub-Parts B and C of Part 15 of FCC Rules, which are designed to provide reasonable protection against such interference in a residential installation. However, there is no guarantee that interference will not occur in a particular installation. If this equipment does cause interference to radio or television reception, which can be determined by unplugging the equipment, try to correct the interference by one or more of the following measures.

- Reorient the antenna of the radio/TV experiencing the interference.
- Relocate the equipment with respect to the radio/TV.
- Move the equipment away from the radio/TV.
- Plug the equipment into an outlet on a different electrical circuit from the radio/TV experiencing the interference.
- If necessary, consult your local Dealer for additional suggestions.

NOTE: Modifications to this product will void the user's authority to operate this equipment.

CONTENTS

CONTROLS AND CONNECTIONS	7
CAMERA/VIDEO SENDER, REMOTE CONTROLLED	
POWER SUPPLY, AND VIDEO RECEIVER	7
CAMERA/VIDEO SENDER	8
VIDEO RECEIVER	9
CONNECTING UP	10
SETTING UP THE REMOTE CONTROLLED POWER SUPPLY	10
SETTING UP THE CAMERA/VIDEO SENDER	11
SETTING UP THE VIDEO RECEIVER	12
FINE TUNING YOUR SYSTEM	14
WARRANTY	15

CONTROLS AND CONNECTIONS

CAMERA/VIDEO SENDER

VIDEO RECEIVER (BOTTOM VIEW)

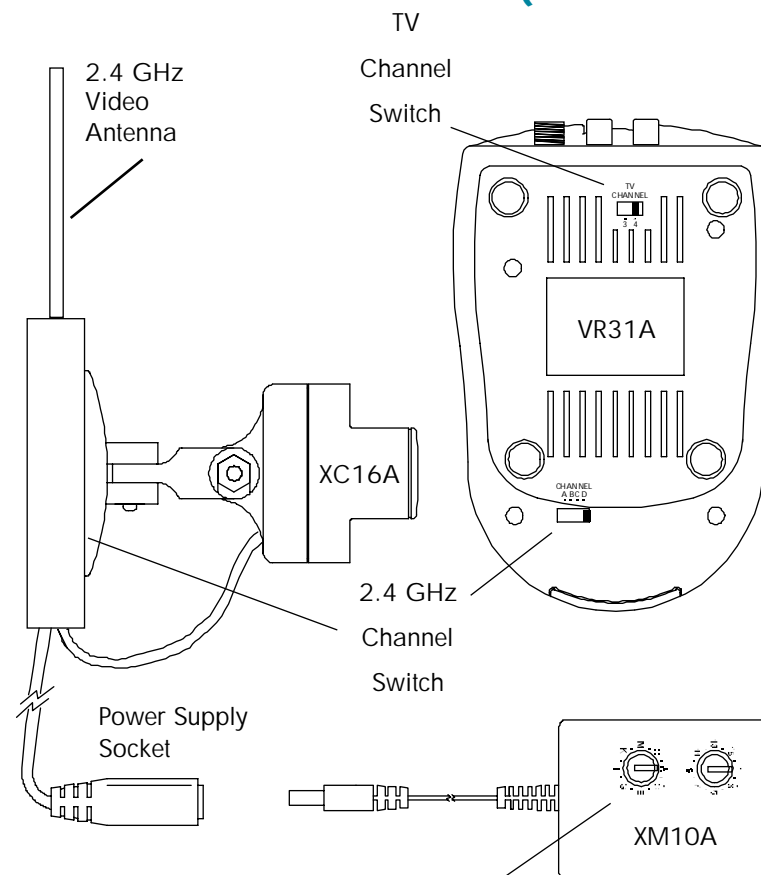

Used to set the code that the XM10A responds to, so you can turn the camera connected to it on and off by remote control (using X10 remote controls, sold separately).

CONTROLS AND CONNECTIONS

CAMERA/VIDEO SENDER

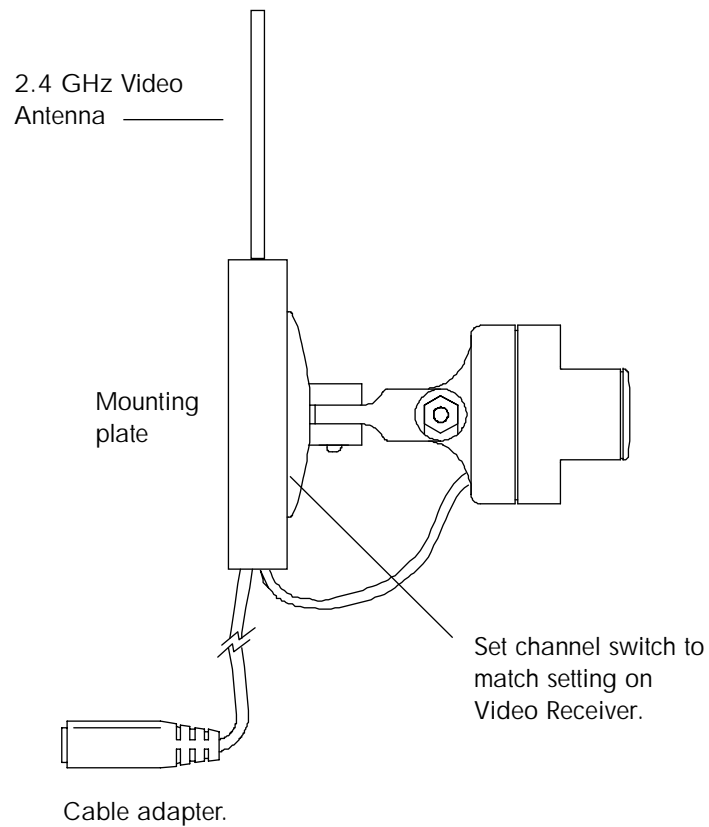

8

VIDEO RECEIVER

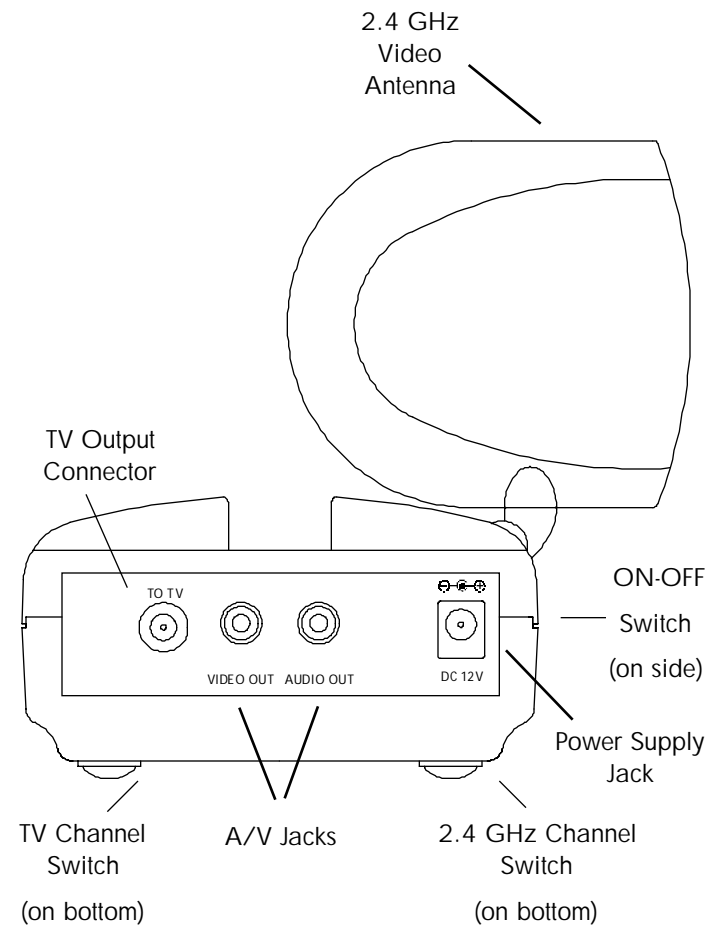

9

CONNECTING UP

SETTING UP THE CAMERA/VIDEO SENDER, AND REMOTE CONTROLLED POWER SUPPLY

Referring to the diagrams below and on the next page:

1. Attach the camera to a wall using the screws provided.
2. If you install the camera outdoors, make a small hole in your exterior wall and pass the low voltage power jack through it.
3. Plug the XM10A's power supply jack into the socket on the adapter cable from the camera.
4. Plug the power supply into any 120V AC outlet.
5. Set the channel switch on the camera to any letter A, B, C, or D
6. Adjust the antenna if necessary to aim it in the direction of the TV or monitor that you will view the camera on.
7. Set the Housecode dial to a letter between A and P that matches the Housecode dial on the X10 remote controls you want to use it with. Set the Unit Code dial to a number between 1 and 16. This lets you turn the camera connected to the XM10A on and off by remote control (using X10 remote controls, sold separately). See the owner's manual supplied with X10 remote controls for more details.

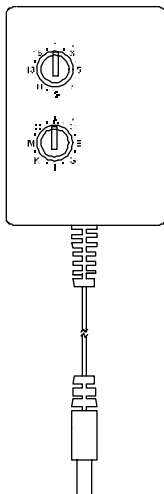

10

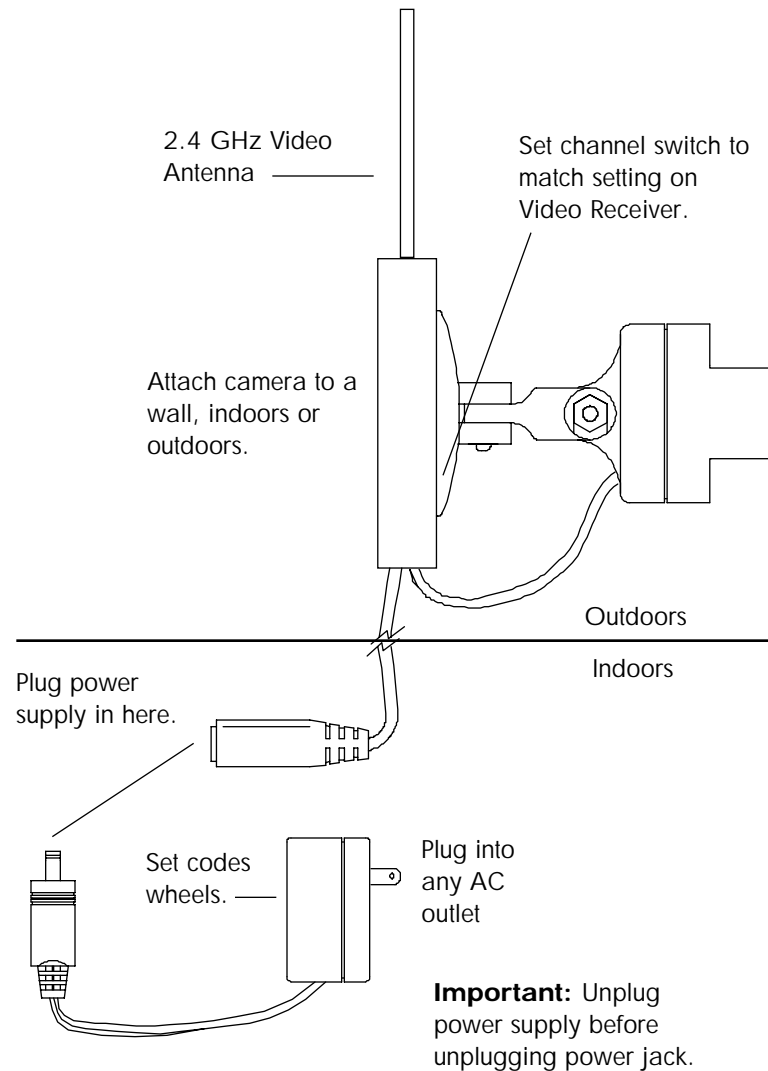

11

HOOKING UP THE VIDEO RECEIVER

1. Connect a set of Audio/Video cables to the A/V OUT jacks on the Video Receiver. Connect the other end to your TV (use either L or R channel for audio).
2. Plug the Video Receiver's Power Supply jack (the power supply with NO code wheels) into the Video Receiver and plug the power supply into a 120 volt wall outlet.
3. Turn the Video Receiver's power switch (on side of unit) on.
4. Set the channel switch to the same letter as you set on the camera, A, B, C, or D.
5. Position the Video Receiver in a convenient location such as on top of the TV and orient the antenna so that the flat side points in the direction of the room where you set up the Camera/Video Sender.

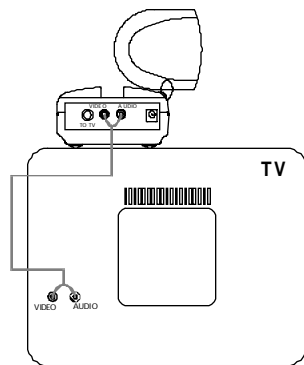

IF YOUR TV DOES NOT HAVE A/V CONNECTORS

You can use the supplied coaxial cable to connect the TV OUT socket on the Video Receiver to the Antenna input on your TV. If you already have an antenna connected to your TV, you will need to use a TV antenna splitter.

Set your TV and the TV Channel switch on the Video Receiver (on bottom) to the same channel (3 or 4).

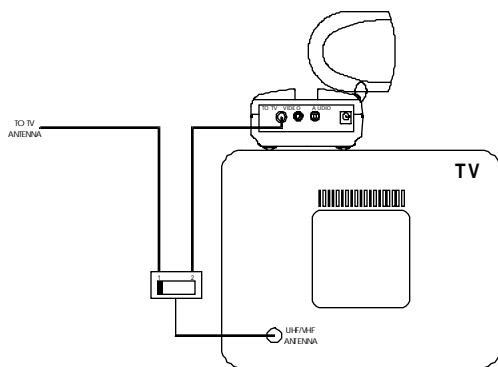

12

IF YOUR TV IS ALREADY HOOKED UP TO A DBS RECEIVER OR OTHER A/V DEVICE

If a DBS Receiver or other A/V component is connected to the TV using A/V cables, you can connect the Video Receiver to the free LINE IN jacks on the component. If there are no LINE IN jacks, you will need to use a TV antenna splitter as described earlier.

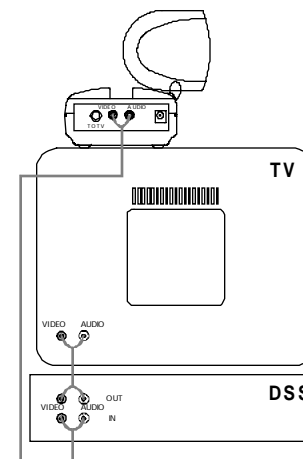

13

FINE TUNING YOUR SYSTEM

The Wireless Video Sender usually works best with the flat faces of the antennas on the Sender and Receiver unit facing each other (i.e. in "Line of sight" - see diagram below). Sometimes, however, reflections and other effects in the home may affect the signal so that some adjustment of either the Sender or Receiver antenna may be necessary to get the best the signal.

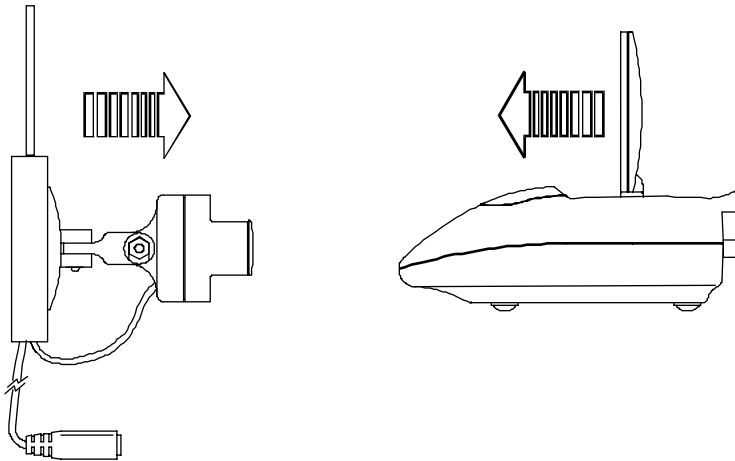

IF YOU ARE NOT GETTING ANY SIGNAL AT ALL

Check that the CHANNEL slide switch (labeled A, B, C, D) on both units (on bottom) is set to the same letter.

If you are using coaxial TV connections from the Video Receiver, check that the TV is tuned to the same channel as the TV Channel switch on the bottom of the Video Receiver (3 or 4).

Check that the camera's remote controlled power supply is turned on (using any X10 remote control, sold separately). Note, when you first plug the power supply in, it will normally be ON.

IF THE SIGNAL IS POOR, OR THERE IS INTERFERENCE

Try changing the channel on both units. Do this by adjusting the CHANNEL slide switch on each unit to any position (A, B, C, or D). Make sure both units are set to the same letter.

WARRANTY

12 MONTH LIMITED WARRANTY

X10 WIRELESS TECHNOLOGY, INC. (X10WTI) WARRANTS ITS PRODUCTS TO BE FREE FROM DEFECTIVE MATERIAL AND WORKMANSHIP FOR A PERIOD OF ONE (1) YEAR FROM THE ORIGINAL DATE OF PURCHASE AT RETAIL. X10WTI AGREES TO REPAIR OR REPLACE, AT ITS SOLE DISCRETION, A DEFECTIVE X10WTI PRODUCT IF RETURNED TO X10WTI WITHIN THE WARRANTY PERIOD AND WITH PROOF OF PURCHASE.

IF SERVICE IS REQUIRED UNDER THIS WARRANTY:

1. RETURN THE DEFECTIVE UNIT POSTAGE PREPAID TO THE ADDRESS ON BACK COVER.
2. ENCLOSE A CHECK FOR \$4.00 TO COVER HANDLING AND RETURN POSTAGE.
3. ENCLOSE A DATED PROOF OF PURCHASE.
4. X10 IS NOT RESPONSIBLE FOR SHIPPING DAMAGE. UNITS TO BE RETURNED SHOULD BE PACKED CAREFULLY.

THIS WARRANTY DOES NOT EXTEND TO ANY X10WTI PRODUCTS WHICH HAVE BEEN SUBJECT TO MISUSE, NEGLIGENCE, ACCIDENT, INCORRECT WIRING OR TO USE IN VIOLATION OF OPERATING INSTRUCTIONS FURNISHED BY US, NOR EXTEND TO ANY UNITS ALTERED OR REPAIRED FOR WARRANTY DEFECT BY ANYONE OTHER THAN X10. THIS WARRANTY DOES NOT COVER ANY INCIDENTAL OR CONSEQUENTIAL DAMAGES AND IS IN LIEU OF ALL OTHER WARRANTIES EXPRESSED OR IMPLIED AND NO REPRESENTATIVE OR PERSON IS AUTHORIZED TO ASSUME FOR US ANY OTHER LIABILITY IN CONNECTION WITH THE SALE OF OUR PRODUCTS.

SOME STATES DO NOT ALLOW LIMITATIONS ON HOW LONG AN IMPLIED WARRANTY LASTS, AND/OR THE EXCLUSION OR LIMITATION OF INCIDENTAL OR CONSEQUENTIAL DAMAGES SO THE ABOVE LIMITATIONS AND EXCLUSIONS MAY NOT APPLY TO THE ORIGINAL CUSTOMER. THIS WARRANTY GIVES YOU SPECIFIC RIGHTS AND YOU MAY ALSO HAVE OTHER RIGHTS WHICH VARY FROM STATE TO STATE.



**X10.com, a Division of
X10 Wireless Technology, Inc.
3824 North 5th St.,
Suite C, North Las Vegas, NV 89030**

Web Site: www.x10.com

VK58A-11/3/00



Free Manuals Download Website

<http://myh66.com>

<http://usermanuals.us>

<http://www.somanuals.com>

<http://www.4manuals.cc>

<http://www.manual-lib.com>

<http://www.404manual.com>

<http://www.luxmanual.com>

<http://aubethermostatmanual.com>

Golf course search by state

<http://golfingnear.com>

Email search by domain

<http://emailbydomain.com>

Auto manuals search

<http://auto.somanuals.com>

TV manuals search

<http://tv.somanuals.com>