

OPERATING INSTRUCTIONS

R-672
Audio/Video Receiver

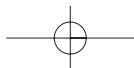



SAFETY INSTRUCTIONS

1. **Read Instructions** - All the safety and operating instructions should be read before the product is operated.
2. **Retain instructions** - The safety and operating instructions should be retained for future reference.
3. **Heed Warnings** - All warnings on the product and in the operating instructions should be adhered to.
4. **Follow Instructions** - All operating and use instructions should be followed.
5. **Cleaning** - Unplug this product from the wall outlet before cleaning. Do not use liquid cleaners or aerosol cleaners. Use a damp cloth for cleaning.
6. **Attachments** - Do not use attachments not recommended by the product manufacturer as they may cause hazards.
7. **Water and Moisture** - Do not use this product near water - for example, near a bath tub, wash bowl, kitchen sink, or laundry tub; in a wet basement, or near a swimming pool; and the like.
8. **Accessories** - Do not place this product on an unstable cart, stand, tripod, bracket, or table. The product may fall, causing serious injury to a child or adult, and serious damage to the product. Use only with a cart, stand, tripod, bracket, or table recommended by the manufacturer, or sold with the product. Any mounting of the product should follow the manufacturer's instructions, and should use a mounting accessory recommended by the manufacturer.
9. A product and cart combination should be moved with care. Quick stops, excessive force, and uneven surfaces may cause the product and cart combination to overturn.
10. **Ventilation** - Slots and openings in the cabinet are provided for ventilation and to ensure reliable operation of the product and to protect it from overheating, and these openings must not be blocked or covered. The openings should never be blocked by placing the product on a bed, sofa, rug, or other similar surface. This product should not be placed in a built-in installation such as a bookcase or rack unless proper ventilation is provided or the manufacturer's instructions have been adhered to.
11. **Power Sources** - This product should be operated only from the type of power source indicated on the marking label. If you are not sure of the type of power supply to your home, consult your product dealer or local power company. For products intended to operate from battery power, or other sources, refer to the operating instructions.
12. **Grounding or Polarization** - This product may be equipped with a polarized alternating-current line plug (a plug having one blade wider than the other). This plug will fit into the power outlet only one way. This is a safety feature. If you are unable to insert the plug fully into the outlet, try reversing the plug. If the plug should still fail to fit, contact your electrician to replace your obsolete outlet. Do not defeat the safety purpose of the polarized plug.
Alternate Warnings - This product is equipped with a three-wire grounding-type plug, a plug having a third (grounding) pin. This plug will only fit into a grounding-type power outlet. This is a safety feature. If you are unable to insert the plug into the outlet, contact your electrician to replace your obsolete outlet. Do not defeat the safety purpose of the grounding-type plug.
13. **Power-Cord Protection** - Power-supply cords should be routed so that they are not likely to be walked on or pinched by items placed upon or against them, paying particular attention to cords at plugs, convenience receptacles, and the point where they exit from the product.
14. **Outdoor Antenna Grounding** - If an outside antenna or cable system is connected to the product, be sure the antenna or cable system is grounded so as to provide some protection against voltage surges and built-up static charges. Article 810 of the National Electrical Code, ANSI/NFPA 70, provides information with regard to proper grounding of the mast and supporting structure, grounding of the lead-in wire to an antenna discharge unit, size of grounding conductors, location of antenna-discharge unit,



PORTABLE CART WARNING

connection to grounding electrodes, and requirements for the grounding electrode. See Figure 1.

Figure 1
Example of antenna grounding as per
National Electrical Code, ANSI/NFPA 70

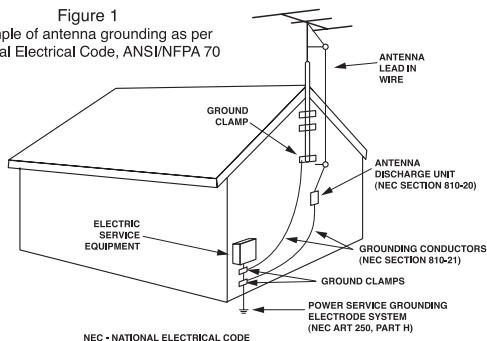



15. **Lightning** - For added protection for this product during a lightning storm, or when it is left unattended and unused for long periods of time, unplug it from the wall outlet and disconnect the antenna or cable system. This will prevent damage to the product due to lightning and power-line surges.
16. **Power Lines** - An outside antenna system should not be located in the vicinity of overhead power lines or other electric light or power circuits, or where it can fall into such power lines or circuits. When installing an outside antenna system, extreme care should be taken to keep from touching such power lines or circuits as contact with them might be fatal.
17. **Overloading** - Do not overload wall outlets, extension cords, or integral convenience receptacles as this can result in a risk of fire or electric shock.
18. **Object and Liquid Entry** - Never push objects of any kind into this product through openings as they may touch dangerous voltage points or short-out parts that could result in a fire or electric shock. Never spill liquid of any kind on the product.
19. **Servicing** - Do not attempt to service this product yourself as opening or removing covers may expose you to dangerous voltage or other hazards. Refer all servicing to qualified service personnel.
20. **Damage Requiring Service** - Unplug this product from the wall outlet and refer servicing to qualified service personnel under the following conditions:
 - a) When the power-supply cord or plug is damaged,
 - b) If liquid has been spilled, or objects have fallen into the product,
 - c) If the product has been exposed to rain or water,
 - d) If the product does not operate normally by following the operating instructions. Adjust only those controls that are covered by the operating instructions as an improper adjustment of other controls may result in damage and will often require extensive work by a qualified technician to restore the product to its normal operation.
 - e) If the product has been dropped or damaged in any way, and
 - f) When the product exhibits a distinct change in performance - this indicates a need for service.
21. **Replacement Parts** - When replacement parts are required, be sure the service technician has used replacement parts specified by the manufacturer or have the same characteristics as the original part. Unauthorized substitutions may result in fire, electric shock, or other hazards.
22. **Safety Check** - Upon completion of any service or repairs to this product, ask the service technician to perform safety checks to determine that the product is in proper operating condition.
23. **Wall or Ceiling Mounting** - The product should be mounted to a wall or ceiling only as recommended by the manufacturer.
24. **Heat** - The product should be situated away from heat sources such as radiators, heat registers, stoves, or other products (including amplifiers) that produce heat.

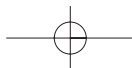





Introduction

READ THIS BEFORE OPERATING YOUR UNIT

	CAUTION <small>RISK OF ELECTRIC SHOCK DO NOT OPEN</small>	
CAUTION : TO REDUCE THE RISK OF ELECTRIC SHOCK, DO NOT REMOVE COVER (OR BACK). NO USER-SERVICEABLE PARTS INSIDE. REFER SERVICING TO QUALIFIED SERVICE PERSONNEL.		

	This symbol is intended to alert the user to the presence of uninsulated "dangerous voltage" within the product's enclosure that may be of sufficient magnitude to constitute a risk of electric shock to persons.
	This symbol is intended to alert the user to the presence of important operating and maintenance (servicing) instructions in the literature accompanying the appliance.

ENGLISH

WARNING : TO REDUCE THE RISK OF FIRE OR ELECTRIC SHOCK, DO NOT EXPOSE THIS APPLIANCE TO RAIN OR MOISTURE.

Caution regarding installation
 Note : For heat dispersal, do not install this unit in a confined space such as a bookcase or similar enclosure.

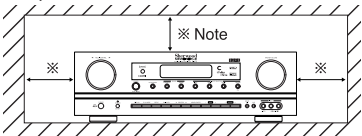

※ Note

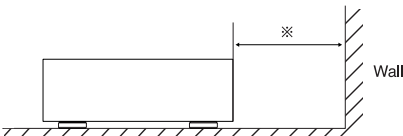

※ Wall

Do not block ventilation openings or stack other equipment on the top.

Note to CATV System Installer :

This reminder is provided to call the CATV system installer's attention to Article 820-40 of the NEC that provides guidelines for proper grounding and, in particular, specifies that the cable ground shall be connected to the grounding system of the building, as close to the point of cable entry as practical.

FCC INFORMATION

This equipment has been tested and found to comply with the limits for a Class B digital device, pursuant to Part 15 of the FCC Rules. These limits are designed to provide reasonable protection against harmful interference in a residential installation. This equipment generates, uses and can radiate radio frequency energy and, if not installed and used in accordance with the instructions, may cause harmful interference to radio communications. However, there is no guarantee that interference will not occur in a particular installation. If this equipment does cause harmful interference to radio or television reception, which can be determined by turning the equipment off and on, the user is encouraged to try to correct the interference by one or more of the following measures:

- Reorient or relocate the receiving antenna.
- Increase the separation between the equipment and receiver.
- Connect the equipment into an outlet on a circuit different from that to which the receiver is connected.
- Consult the dealer or an experienced radio/TV technician for help.

Caution : Any changes or modifications in construction of this device which are not expressly approved by the party responsible for compliance could void the user's authority to operate the equipment.

FOR YOUR SAFETY

U.S.A CANADA	120 V	Units shipped to the U.S.A and CANADA are designed for operation on 120 V AC only. Safety precaution with use of a polarized AC plug. However, some products may be supplied with a nonpolarized plug. CAUTION : To prevent electric shock, match wide blade of plug to wide slot, fully insert. ATTENTION : Pour éviter chocs électriques, introduire la lame la plus large de la fiche dans la borne correspondante de la prise et pousser jusqu' au fond.
-------------------------	--------------	--

CAUTION

- Leave a space around the unit for sufficient ventilation.
 - Avoid installation in extremely hot or cold locations, or in an area that is exposed to direct sunlight or heating equipment.
 - Keep the unit free from moisture, water, and dust.
 - Do not let foreign objects in the unit.
 - The ventilation should not be impeded by covering the ventilation openings with items, such as newspapers, table-cloths, curtains, etc.
 - No naked flame sources, such as lighted candles, should be placed on the unit.
 - Please be care the environmental aspects of battery disposal.
 - The unit shall not be exposed to dripping or splashing for use.
 - No objects filled with liquids, such as vases, shall be placed on the unit.
 - Do not let insecticides, benzene, and thinner come in contact with the set.
 - Never disassemble or modify the unit in any way.
- Notes on the AC power cord and the wall outlet.
- The unit is not disconnected from the AC power source(mains) as long as it is connected to the wall outlet, even if the unit has been turned off.
 - When disconnecting the power cord from the wall outlet, always pull the plug, not the power cord.
 - Disconnect the plug from the wall outlet when not using the unit for long periods of time.
 - The wall outlet shall be installed near the unit and shall be easily accessible.



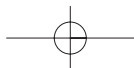

CONTENTS

SAFETY INSTRUCTIONS | 2

Introduction

- READ THIS BEFORE OPERATING YOUR UNIT | 3

System Connections | 5

Front Panel Controls | 11

Remote Controls | 13

- REMOTE CONTROL OPERATION RANGE | 14
- LOADING BATTERIES | 14

Operations

- LISTENING TO A PROGRAM SOURCE | 15
- SURROUND SOUND | 18
- ENJOYING SURROUND SOUND | 20
- LISTENING TO RADIO BROADCASTS | 26
- LISTENING TO XM SATELLITE RADIO
(XM Satellite Radio (only for North America)) | 28
- RECORDING | 31
- DIGITAL AUDIO RECORDING WITH MD RECORDER | 32
- OTHER FUNCTIONS | 33

System Setup | 34

- SETTING THE SYSTEM | 37
- SETTING THE INPUT | 39
- SETTING THE SPEAKER SETUP | 41
- SETTING THE CH LEVEL | 48
- SETTING THE SOUND PARAMETER | 50

Troubleshooting Guide | 54

Specifications | 55



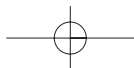

System Connections

- Do not plug the AC input cord into the wall AC outlet until all connections are completed.
- Be sure to observe the color coding when connecting audio, video and speaker cords.
- Make connections firmly and correctly. If not, it can cause loss of sound, noise or damage to the receiver.

ENGLISH

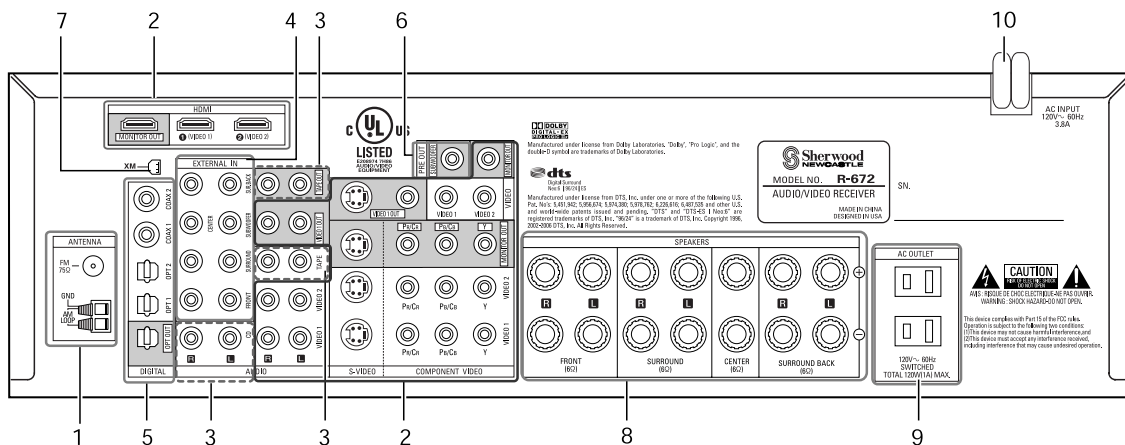

1. CONNECTING ANTENNAS

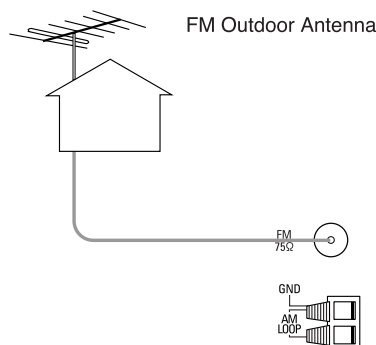
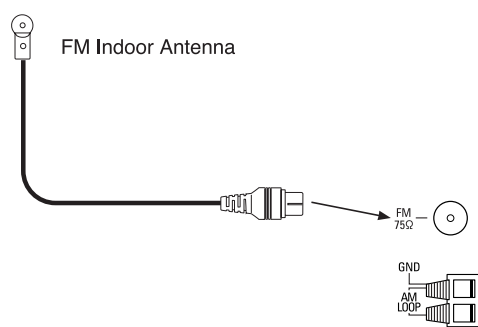

- Change the position of the FM indoor antenna until you get the best reception of your favorite FM stations.

- A 75Ω outdoor FM antenna may be used to further improve the reception. Disconnect the indoor antenna before replacing it with the outdoor one.

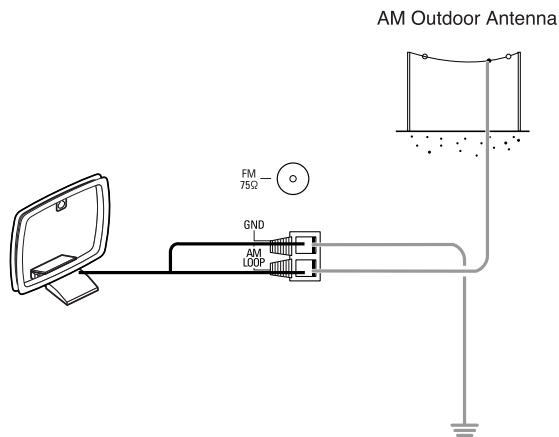
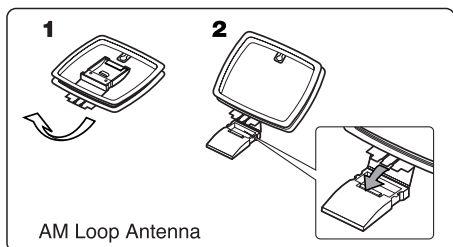

- Place the AM loop antenna as far as possible from the receiver, TV set, speaker cords and the AC input cord and set it to a direction for the best reception.
- If the reception is poor with the AM loop antenna, an AM outdoor antenna can be used in place of the AM loop antenna.



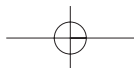

2. CONNECTING VIDEO COMPONENTS

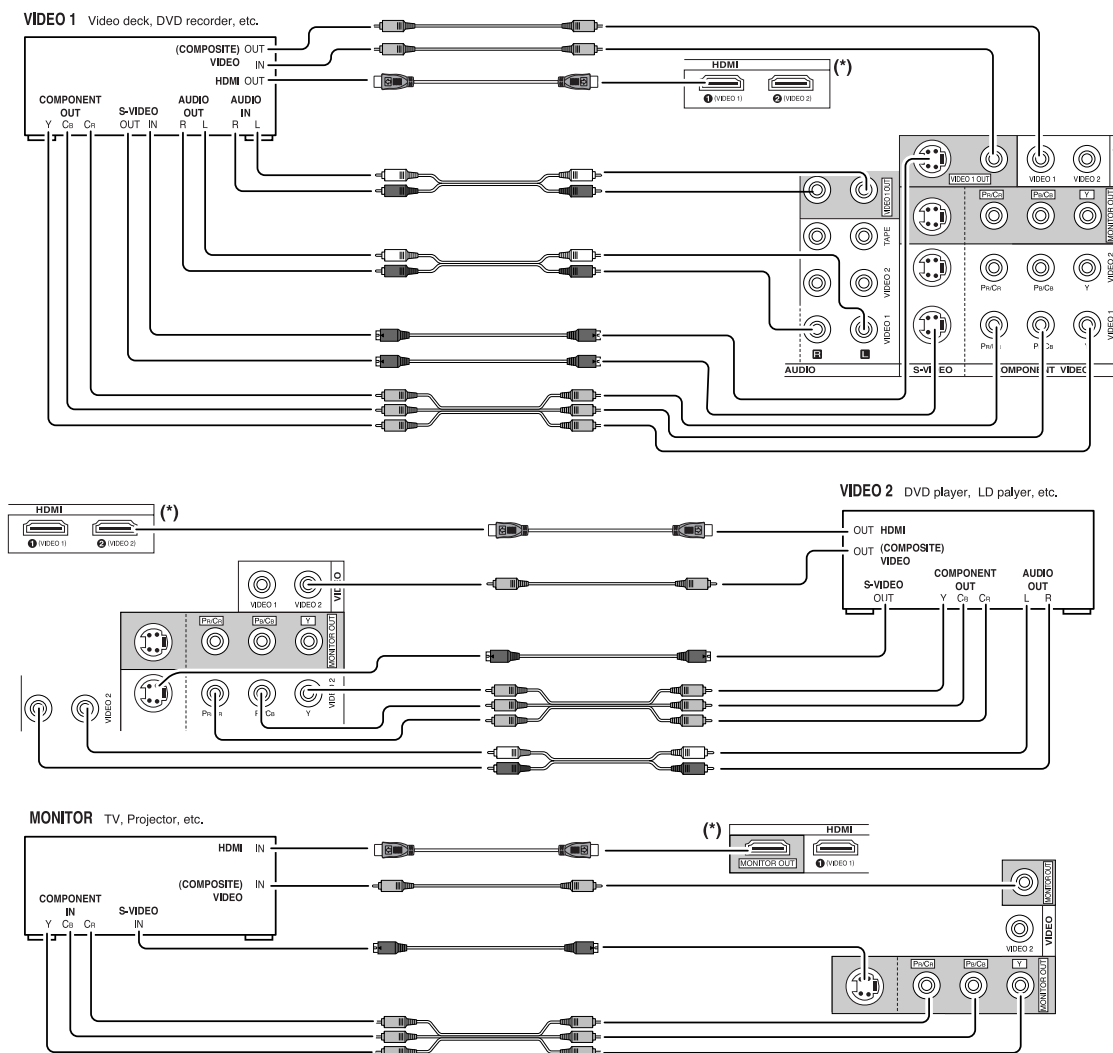

- The jacks of VIDEO 1 may also be connected to a DVD recorder or other digital video recording component. For details, refer to the operating instructions of the component to be connected.
- The jacks of VIDEO 2 can also be connected to an additional video component such as a cable TV tuner, an LD player or satellite system.

HDMI(High Definition Multimedia Interface) connection : (*)

- You can connect the source component (DVD player, etc.) to the display component (TV, projector, etc.) through this receiver with using a commercially available HDMI cord.
- The HDMI connection can carry uncompressed digital video signals and digital audio signals.
- This receiver can output digital video and digital audio signals from the MONITOR HDMI OUT of this receiver without passing through any circuits as they were input into the HDMI IN.
- HDMI, the HDMI logo and High-Definition Multimedia Interface are trademarks or registered trademarks of HDMI licensing LLC.

Note: Depending on the connected component, unreliable signal transfer may happen.
(For details, refer to the operating instruction of your component.)



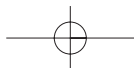

Continued

- There are three types of video jacks (COMPONENT, S-VIDEO, (composite) VIDEO) for connecting video components. Connect them to the corresponding video jacks according to their capability.
- For your reference, the excellence in picture quality is as follows: "COMPONENT" > "S-VIDEO" > "(composite) VIDEO".
- When making COMPONENT VIDEO connections, connect "Y" to "Y", "PB/CB" to "CB" (or "B-Y", "PB") and "PR/CR" to "CR" (or "R-Y", "PR").
- When recording video program sources through VIDEO 1 OUT jacks, you must use the same type of video jacks that you did connect to video playback components such as DVD player, LD player, etc.
- This unit is equipped with a function that up-converts composite video or S-Video signals to component video signals or down-converts S-Video signals to composite video signals and outputs them from the MONITOR OUTs. Because of this, you need not connect all the types of MONITOR OUT jacks to the MONITOR TV.
- After connecting the video components, you should set the video mode correctly, referring to the following table.
(For details, refer to "When selecting the VIDEO MODE" on page 40.)

ENGLISH

Relationship between the video input signal and the video output signal

Video input signals			Video Mode Setting	MONITOR OUTs		
COMPONENT	S-VIDEO	(composite) VIDEO		COMPONENT	S-VIDEO	(composite) VIDEO
			"AT"(Auto)	Component	S-Video	Composite video
			"CPN"(Component)*1	Component	x	x
			"SVD"(S-Video)*2	S-Video	S-Video	S-Video
			"CPS"(Composite)*2	Composite video	Composite video	Composite video
		x	"AT"(Auto)	Component	S-Video	S-Video
	x		"AT"(Auto)	Component	Composite video	Composite video
	x	x	"AT"(Auto)	Component	x	x
x			"AT"(Auto)	S-Video	S-Video	Composite video
x		x	"AT"(Auto)	S-Video	S-Video	S-Video
x	x		"AT"(Auto)	Composite video	Composite video	Composite video

*1 : Component video signal can be output from the MONITOR COMPONENT OUT jacks only.

*2 : The video signal set in the VIDEO MODE menu can be output from all the types of MONITOR OUT jacks.



3. CONNECTING AUDIO COMPONENTS

- The TAPE IN/OUT jacks can be connected to audio recording equipment such as a tape deck, an MD recorder, etc.

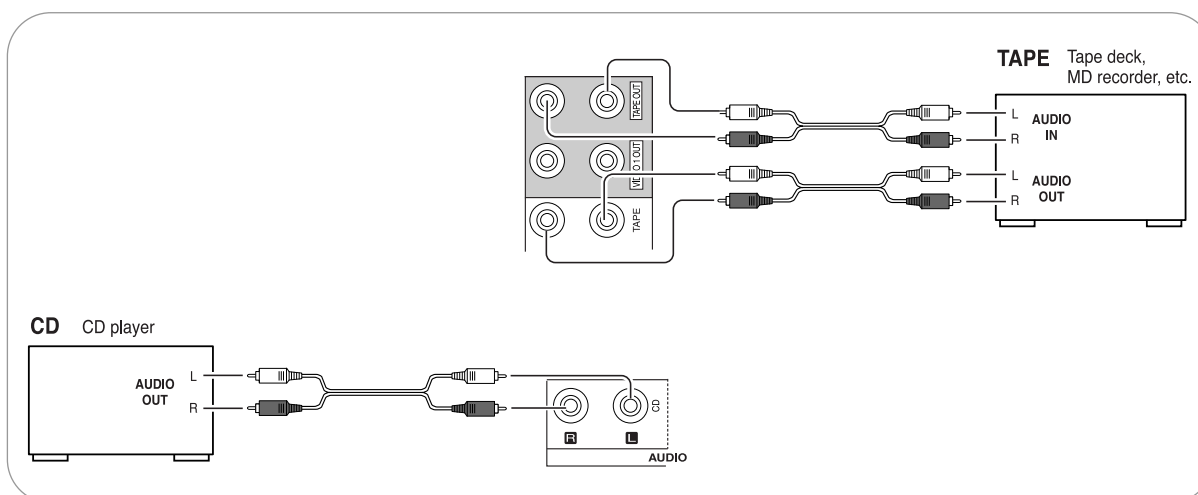

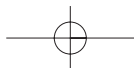

4. CONNECTING EXTERNAL INS

- Use these jacks to connect the corresponding outputs of a DVD player or external decoder, etc. that has 6, 7 or 8 channel analog audio outputs
- In case of 6 or 7 channel outputs, do not connect both of the SURROUND BACK L and R inputs or the SURROUND BACK R input of this unit. (For details, refer to the operating instructions of the component to be connected.)

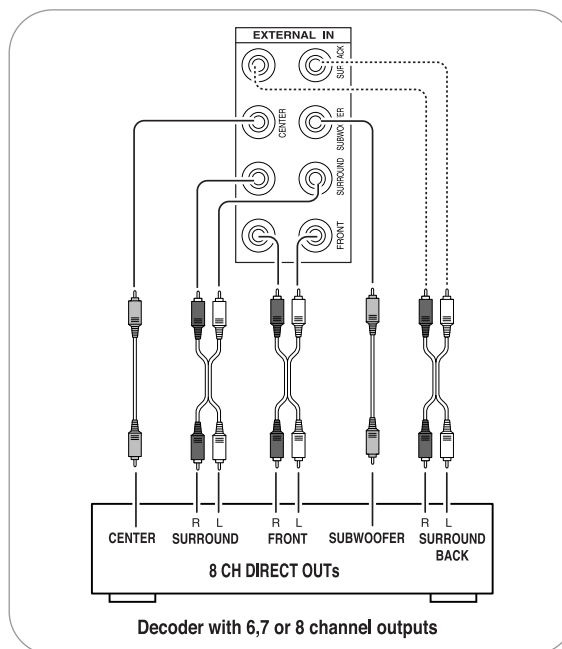

5. CONNECTING DIGITAL INS AND OUT

- The OPTICAL and the COAXIAL DIGITAL OUTs of the components that are connected to this unit can be connected to these DIGITAL INs.
- A digital input should be connected to the components such as a CD player, LD player, DVD player, etc. capable of outputting DTS Digital Surround, Dolby Digital or PCM format digital signals, etc.
- If the component with OPTICAL IN jack is connected to the OPTICAL OUT jack of this unit, you can record the high quality sound of CDs, etc. without degradation.
- For details, refer to the operating instructions of the component connected.
- When making the COAXIAL DIGITAL connection, be sure to use a 75 Ω COAXIAL cord, not a conventional AUDIO cord.
- All of the commercially available optical fiber cords cannot be used for the equipment. If there is an optical fiber cord which cannot be connected to your equipment, consult your dealer or nearest service organization.

Note :

- Be sure to make either a OPTICAL or a COAXIAL DIGITAL connection on each component. (You don't need to do both.)

Digital input default settings

- If you connect the DIGITAL INs to your components, it is easier to do so following the default settings.
- If your DIGITAL connections are different from default settings, you should assign the DIGITAL INs you used with the "When selecting the DIGITAL IN" procedure on page 39.
- The default settings are as follows :
OPTICAL IN 1 : VIDEO 1, OPTICAL IN 2 : VIDEO 2, COAXIAL IN 1 : CD, COAXIAL IN 2 : AUX.

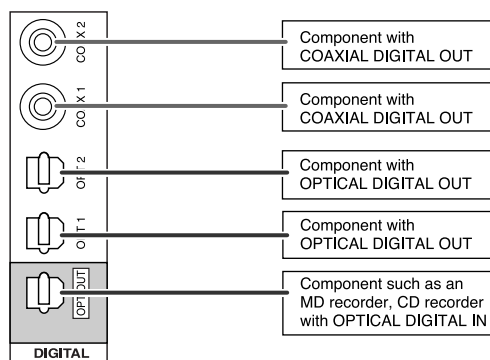

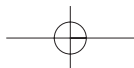

6. CONNECTING SUBWOOFER PRE OUT

- To emphasize the deep bass sounds, connect a powered subwoofer.

Note :

- When the power amplifier is assigned to "SB+W" (Surround Back+Subwoofer), no signals are output from the SUBWOOFER PRE OUT jack. (For details, refer to "When selecting the AMP ASSIGN" on page 37.)

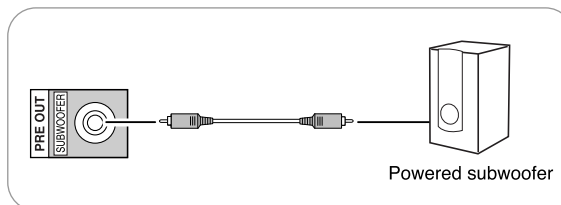

ENGLISH

7. CONNECTING XM (only for North America)

- Connect the XM terminal to the XM Mini-Tuner system (sold separately).
- Position the XM Mini-Tuner system near a south-facing window to receive the best signal. When making connections, also refer to the operating instructions of the XM Mini-Tuner system.
- For the best reception, check the signal strength of the XM radio signal with using signal strength display mode, then adjust the position of the XM Mini-Tuner system until "GOOD" is displayed. (For details, refer to "Displaying XM information" on page 30.)
- To listen to XM Satellite Radio, refer to "XM Satellite Radio (only for North America)" on page 28.

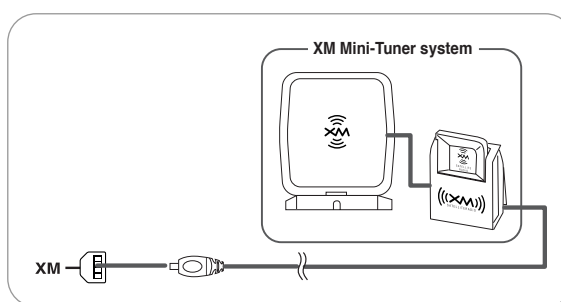

8. CONNECTING SPEAKERS

- Be sure to connect speakers firmly and correctly according to the channel (left and right) and the polarity (+ and -). If the connections are faulty, no sound will be heard from the speakers, and if the polarity of the speaker connection is incorrect, the sound will be unnatural and lack bass.
- For installing the speakers, refer to "Speaker placement" on page 10.
- After installing the speakers, first adjust the speaker settings according to your environment and speaker layout. (For details, refer to "SETTING THE SPEAKER SETUP" on page 41.)

Surround back speakers

- When using only one surround back speaker, you should connect it to SURROUND BACK LEFT channel. In this case, you can connect a subwoofer without built-in amplifier to the SURROUND BACK RIGHT channel. (For details, refer to "When selecting the AMP ASSIGN" on page 37.)

Caution :

- Be sure to use the speakers with the impedance of 6 ohms or above.
- Do not let the bare speaker wires touch each other or any metal part of this unit. This could damage this unit and/or the speakers.

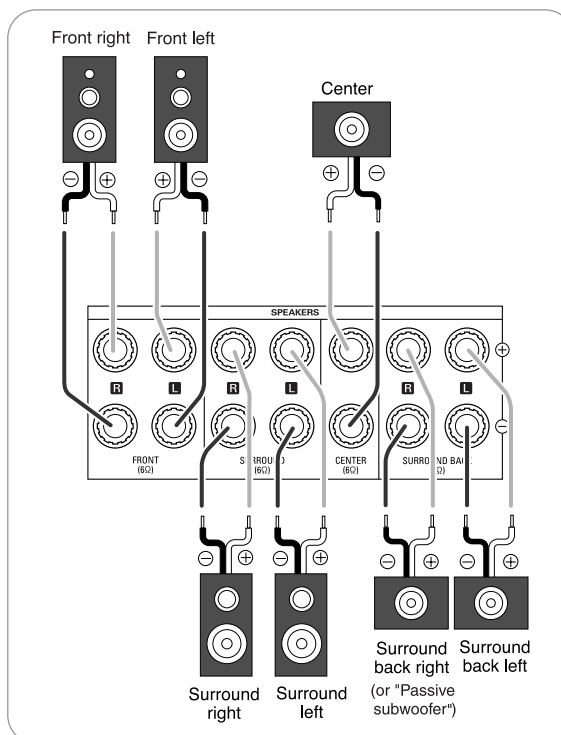

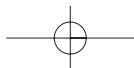

9. SWITCHED AC OUTLETS

- These outlets are switched on (power-on mode) and off (standby mode) according to power control as follows (Maximum total capacity is 120 W (1 A)).

- Standby mode - Switched AC outlet off
 Power-on mode - Switched AC outlet on

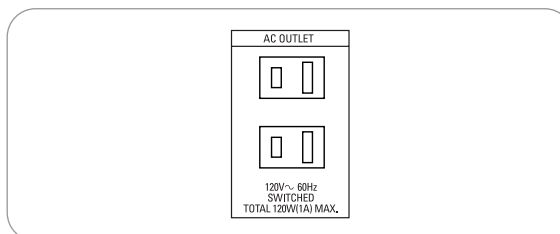

10. AC INPUT CORD

- Plug this cord into a wall AC outlet.

Speaker placement

Ideal speaker placement varies depending on the size of your room and the wall coverings, etc. The typical example of speaker placement and recommendations are as follows :

Front left and right speakers and center speaker

- Place the front speakers with their front surfaces as flush with TV or monitor screen as possible.
- Place the center speaker between the front left and right speakers and no further from the listening position than the front speakers.
- Place each speaker so that sound is aimed at the location of the listener's ears when at the main listening position.

Surround left and right speakers

- Place the surround speakers approximately 1 meter (40 inches) above the ear level of a seated listener on the direct left and right of them or slightly behind.

Surround back left and right speakers

- Place the surround back speakers at the back facing the front at a narrower distance than front speakers.
- When using a single surround back speaker, place it at the rear center facing the front at a slightly higher position (0 to 20 cm) than the surround speakers.
- We recommend installing the surround back speaker(s) at a slightly downward facing angle. This effectively prevents the surround back channel signals from reflecting off the TV or screen at the front center, resulting in interference and making the sense of movement from the front to the back less sharp.

Subwoofer

- The subwoofer reproduces powerful deep bass sounds. Place a subwoofer anywhere in the front as desired.

Notes :

- When using a conventional TV, to avoid interference with the TV picture, use only magnetically shielded front left and right and center speakers.
- To obtain the best surround effects, the speakers except the subwoofer should be full range speakers.

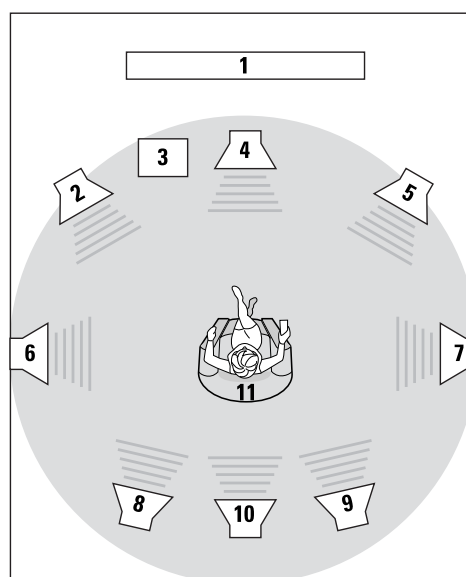

- | | |
|--------------------------|--------------------------------|
| 1. TV or screen | 7. Surround right speaker |
| 2. Front left speaker | 8. Surround back left speaker |
| 3. Subwoofer | 9. Surround back right speaker |
| 4. Center speaker | 10. Surround center speaker |
| 5. Front right speaker | 11. Listening position |
| 6. Surround left speaker | |

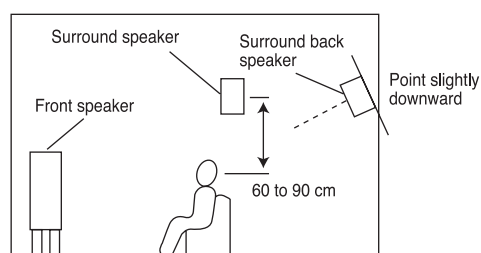

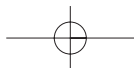

Front Panel Controls

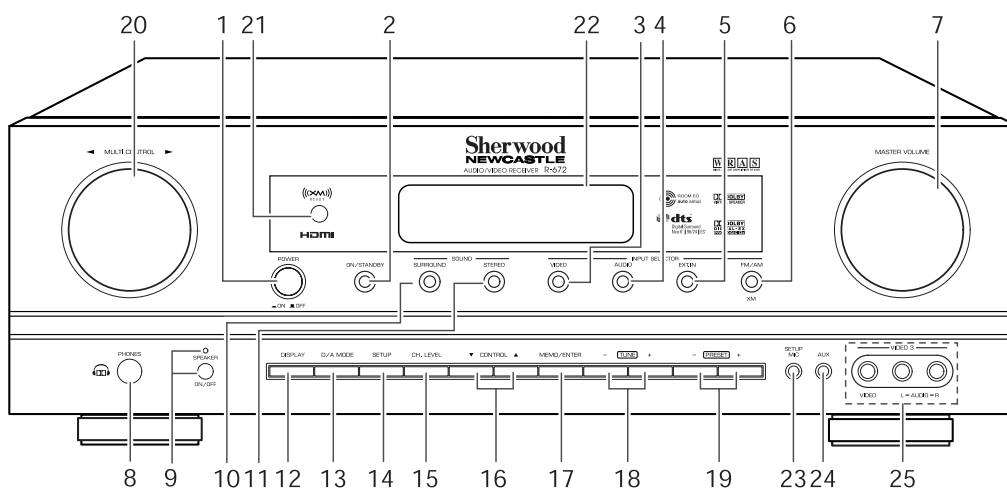

- | | |
|--------------------------------------|----------------------------------|
| 1. POWER switch | 16. CONTROL UP/DOWN(/) buttons |
| 2. POWER ON/STANDBY button/indicator | 17. MEMORY/ENTER button |
| 3. VIDEO INPUT SELECTOR button | 18. TUNING UP/DOWN(+/-) buttons |
| 4. AUDIO INPUT SELECTOR button | 19. PRESET UP/DOWN(+/-) buttons |
| 5. EXTERNAL IN button | 20. MULTI CONTROL knob |
| 6. BAND button | 21. REMOTE SENSOR |
| 7. MASTER VOLUME CONTROL knob | 22. FLUORESCENT DISPLAY |
| 8. HEADPHONE jack | For details, see below. |
| 9. SPEAKER button/indicator | 23. SETUP MIC jack |
| 10. SURROUND MODE button | For details, see next page. |
| 11. STEREO button | 24. AUX IN jack |
| 12. DISPLAY button | For details, see next page. |
| 13. DIGITAL / ANALOG MODE button | 25. VIDEO 3 IN jacks |
| 14. SETUP button | For details, see next page. |
| 15. CHANNEL LEVEL button | |

FLUORESCENT DISPLAY

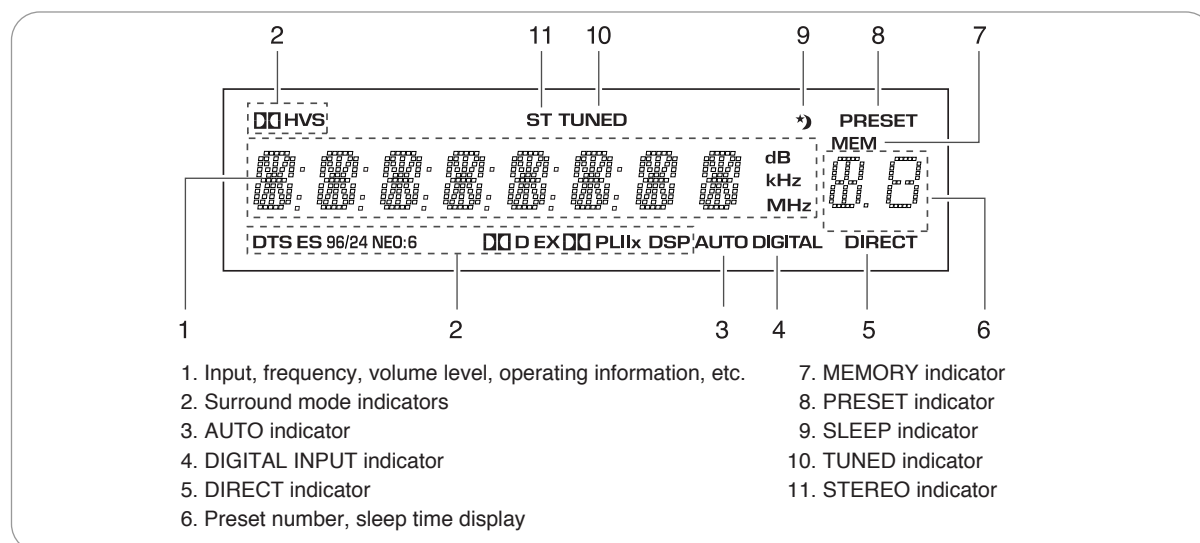

- | | |
|--|----------------------|
| 1. Input, frequency, volume level, operating information, etc. | 7. MEMORY indicator |
| 2. Surround mode indicators | 8. PRESET indicator |
| 3. AUTO indicator | 9. SLEEP indicator |
| 4. DIGITAL INPUT indicator | 10. TUNED indicator |
| 5. DIRECT indicator | 11. STEREO indicator |
| 6. Preset number, sleep time display | |

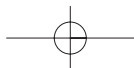

SETUP MIC JACK

- To use Auto Setup function, connect the supplied microphone to the SETUP MIC jack. (For details, refer to "When selecting the AUTO SETUP" on page 41.)

Notes:

- Because the microphone for Auto Setup is designed for use with this receiver, do not use a microphone other than the one supplied with this receiver.
- After you have completed the auto setup procedure, disconnect the microphone.

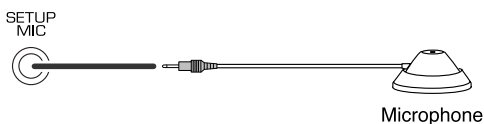

AUX IN JACK

- The AUX IN jack can be connected to an additional audio component such as an MP3 player, etc.

Note:

- When connecting this jack to an MP3 player, etc., you should use the stereo mini cord, not a mono mini cord.

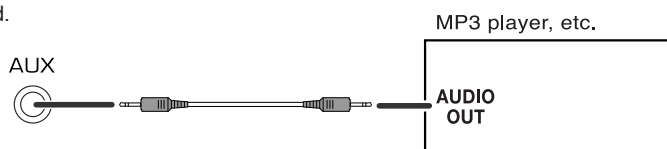

VIDEO 3 IN JACKS

- The VIDEO 3 IN jacks may be also connected to an additional video component such as a camcorder, video game player, etc.

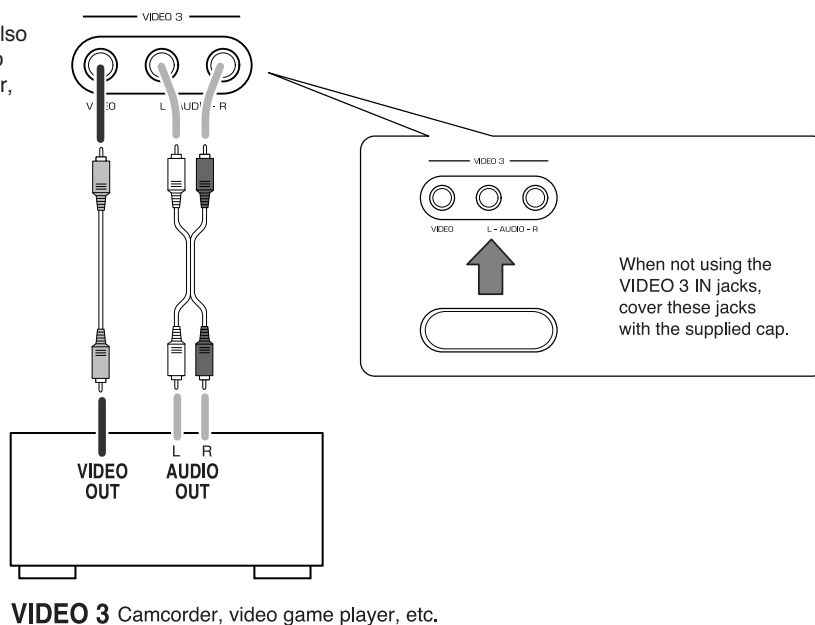

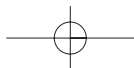

Remote Controls

ENGLISH

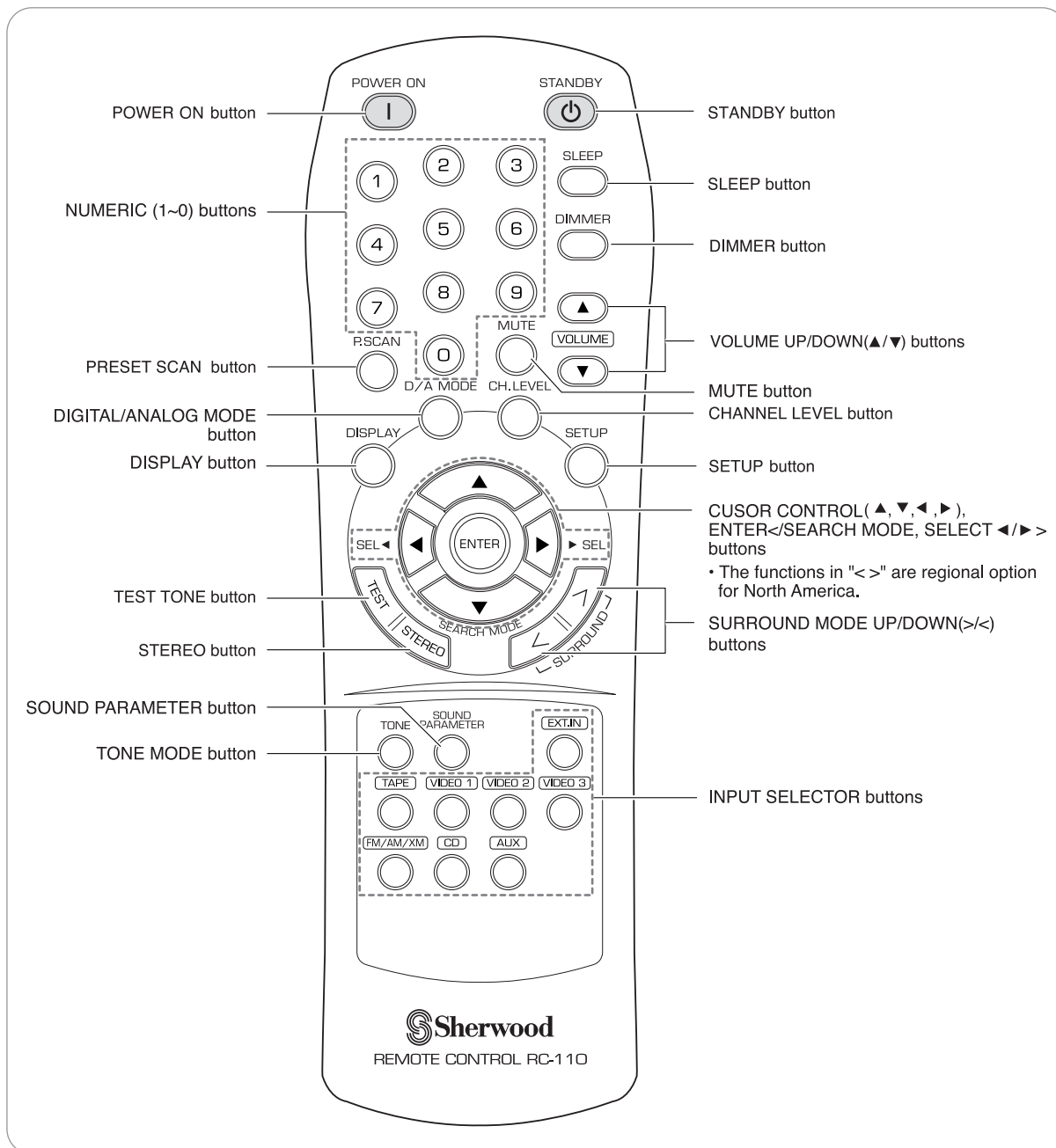

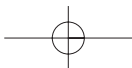

REMOTE CONTROL OPERATION RANGE

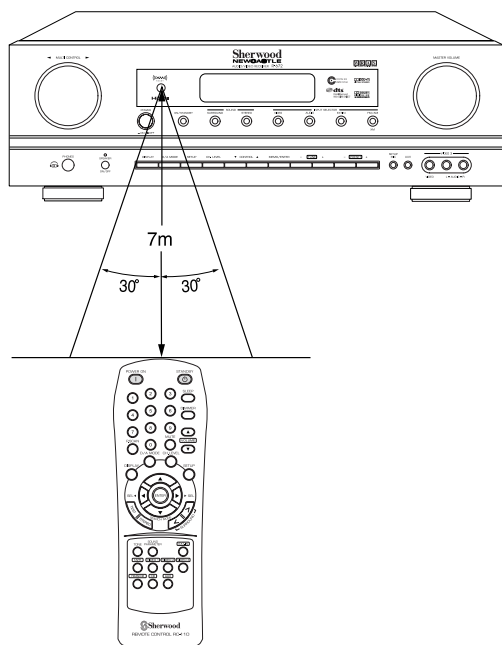

- Use the remote control unit within a range of about 7 meters (23 feet) and angles of up to 30 degrees aiming at the remote sensor.

LOADING BATTERIES

1. Remove the cover.

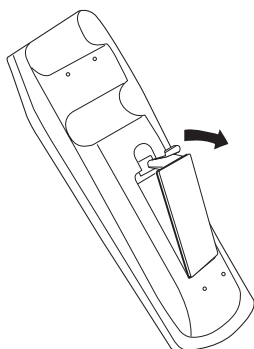

2. Load two batteries ("AAA" size, 1.5V) matching the polarity.

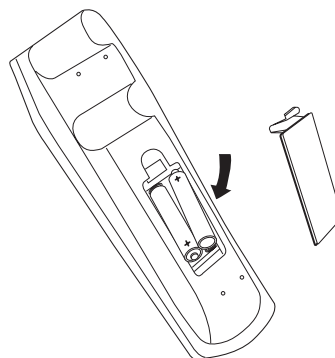

- Remove the batteries when they are not used for a long time.
- Do not use the rechargeable batteries (Ni-Cd type).



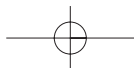

Operations

Notes:

- Before operating this receiver, first set this unit as desired for optimum performance, doing the system setup procedures. (For details, refer to "System Setup" on page 34)

ENGLISH

LISTENING TO A PROGRAM SOURCE

Before operation

- Enter the standby mode.

- The POWER ON/STANDBY button lights up. This means that the receiver is not disconnected from the AC mains and a small amount of current is retained to support the operation readiness.
- To switch the power off, push the POWER switch again.
- Then the power is cut off and the POWER ON / STANDBY button goes off.



1. In the standby mode, turn the power on.

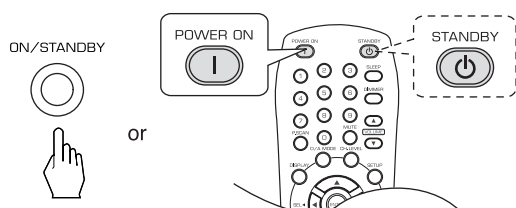

- Each time the POWER ON/STANDBY button on the front panel is pressed, the receiver is turned on to enter the operating mode or off to enter the standby mode.
- On the remote control, press the POWER ON button to enter the operating mode or press the STANDBY button to enter the standby mode.
- In the standby mode, if the INPUT SELECTOR button is pressed, the receiver is turned on automatically and the desired input is selected.

2. Switch the speakers on.

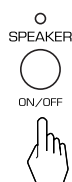

- Then the SPEAKER indicator lights up and the sound can be heard from the speakers connected to the speaker terminals.
- When using the headphone for private listening, press the SPEAKER button again to switch the speakers off.

3. Select the desired input source.

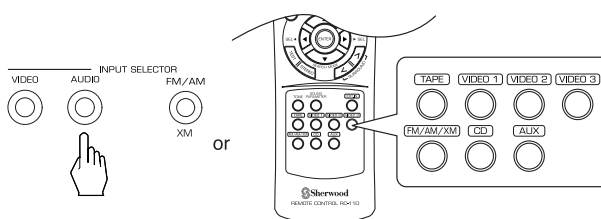

- Each time the "VIDEO" button on the front panel is pressed, the input source changes as follows:

VIDEO 1 VIDEO 2 VIDEO 3

- Each time the "AUDIO" button on the front panel is pressed, the input source changes as follows:

CD AUX TAPE

- Each time the BAND button is pressed, the band changes as follows;

FM ST FM MONO AM XM

When selecting the EXTERNAL IN as desired,

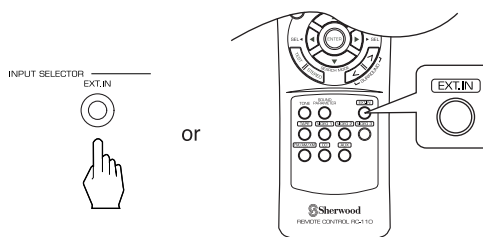

- Depending on the surround back speaker setting, "EXT IN" is displayed and 8(/7/6) separate analog signals from the component connected to this input pass through the tone and volume circuits only and can be heard from your speakers.
- Press the EXTERNAL IN button or select the desired input source to cancel the external in function.
- These analog signals can be heard only, not recorded.

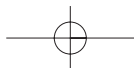

When CD, AUX, VIDEO 1~2 is selected as an input source

4. Select the digital or analog input connected as desired.

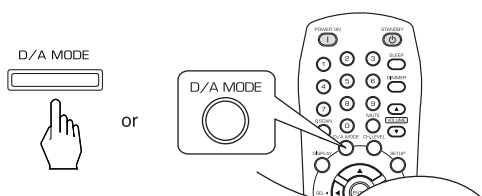

- Each time this button is pressed, the corresponding input is selected as follows:

A(nalog)	o(ptical) 1	o(ptical) 2
c(oaxial) 2	c(oaxial) 1	

Notes :

- When TUNER, TAPE, EXTERNAL IN or VIDEO 3 is selected as an input source, the analog input is selected automatically.
- When the selected digital input is not connected, the "DIGITAL" indicator flickers and the analog input is automatically selected.
- The selected digital or analog input is automatically assigned to the corresponding input source on the INPUT setup menu. (For details, refer to "SETTING THE INPUT" on page 39.)
- The sound from the component connected to the selected digital input can be heard regardless of the selected input source.

5. Operate the selected component for playback.

- When playing back the program sources with surround sound, refer to "ENJOYING SURROUND SOUND" on page 20.

6. Adjust the (overall) volume.

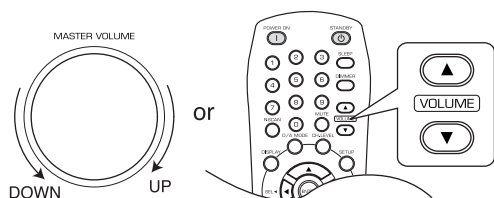

7. To mute the sound.

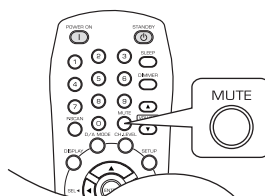

- "MUTE" will flicker.
- To resume the previous sound level, press it again.

8. To listen with the headphones.

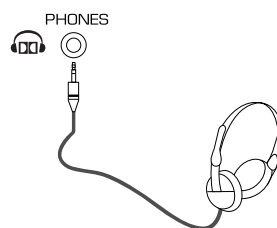

- Ensure that the SPEAKER button is set to off.
- Depending on the signal format which is being input, you can listen in different Dolby Headphone modes, stereo mode, etc. (For details, refer to "Listening in a Dolby Headphone mode" on page 21).
- When the EXTERNAL IN is selected as an input source, only front left and front right channel signals can be reproduced through the headphones.

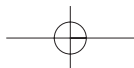

Adjusting the tone (bass and treble)

9. Enter the tone mode.

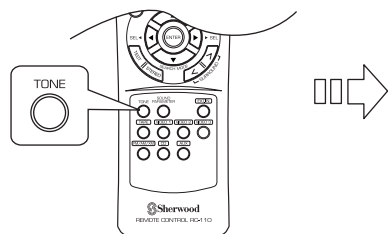

TONE: OFF

- The tone mode is displayed for several seconds.
- Note :** When the digital signals from DTS, Dolby Digital program sources are input or the EXTERNAL IN is selected can listen to a program source without the tone effect.

10. Press the CURSOR LEFT()/RIGHT() buttons to select the desired tone mode.

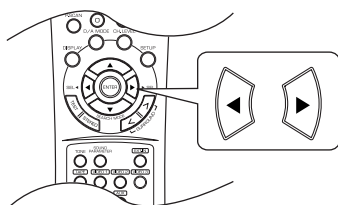

- Each time these buttons are pressed, the tone mode is selected as follows:

OFF : To listen to a program source without the tone effect. ("DIRECT" indicator lights up.)



ON : To adjust the tone for your taste. ("DIRECT" indicator goes off.)

When the "TONE" is set to ON to adjust the tone (bass and treble).

11. Press the CURSOR UP()/DOWN() buttons to select the desired tone.

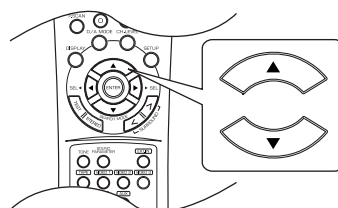

- Each time these buttons are pressed, the tone is selected as follows:

┆ BASS ┆ TRBL(treble) ┆ TONE ON ┆

12. Press the CURSOR LEFT()/RIGHT() buttons to adjust the selected tone as desired.

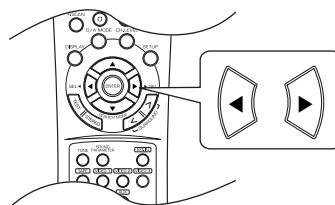

- The tone level can be adjusted within the range of -10 ~ +10 dB.
- In general, we recommend the bass and treble to be adjusted to 0 dB (flat level).
- Extreme settings at high volume may damage your speakers.
- To complete tone adjustment, repeat the above steps 11 and 12.
- If the tone display disappears, start from the step 9 again.



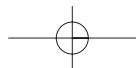

SURROUND SOUND

- This receiver incorporates a sophisticated Digital Signal Processor that allows you to create optimum sound quality and sound atmosphere in your personal Home Theater.

Surround modes

DTS Digital Surround

DTS Digital Surround (also called simply DTS) is a multi-channel digital signal format which can handle higher data rates. Discs bearing the "  " include the recording of

up to 5.1 channels of digital signals, which can be generally thought to provide better sound quality due to the lower audio compression required.

It also provides wide dynamic range and separation, resulting in magnificent sound.

DTS - ES Extended Surround™ ()

This is a new multi channel digital signal format which greatly improves the 360-degree surround impression and space expression thanks to further expanded surround signals, offering high compatibility with the conventional DTS format.

In addition to the 5.1 channels, DTS-ES Extended Surround also offers the surround back (sometimes also referred to as "surround center") channel for surround playback with a total of 6.1 channels. DTS-ES Extended Surround includes two signal formats with different surround signal recording methods as follows:

• DTS-ES™ Discrete 6.1

Because the signals for 6.1 channels (including the surround back channel) are fully independent, it is possible to achieve a sense that the acoustic image are moving about freely among the background sounds surrounding the listener from 360 degrees. Though maximum performance is achieved when sound tracks recorded with this system are played using a DTS-ES decoder, when played with a conventional DTS decoder, the surround back channel signals are automatically downmixed to the surround left and surround right channels so that none of the signal components are lost.

• DTS - ES™ Matrix 6.1

With this format, the additional surround back channel signals undergo matrix encoding and are input to the surround left and surround right channels beforehand. During playback, they are decoded to the surround left, surround right and surround back channels.

Because the bit stream format is 100% compatible with conventional DTS signals, the effect of the DTS-ES Matrix 6.1 format can be achieved even with DTS 5.1-channel signal sources. Of course, it is possible to play DTS-ES Matrix 6.1-channel signal sources with a DTS 5.1-channel decoder. When DTS-ES Discrete 6.1 or Matrix 6.1 sources are decoded with a DTS-ES decoder, the format is automatically detected upon decoding and the optimum surround mode is selected. However, some DTS-ES Matrix 6.1 sources may be detected as DTS sources. In this case, the DTS-ES Matrix mode should be selected manually to play these sources.

DTS Neo : 6™ surround

This mode applies conventional 2-channel signals such as digital PCM or analog stereo signals to the high precision digital matrix decoder used for DTS-ES Matrix 6.1 to achieve 6.1-channel surround playback. DTS Neo : 6 surround includes two modes for selecting the optimum decoding for the signal source.

• DTS Neo : 6 Cinema

This mode is optimum for playing movies. Decoding is performed with emphasis on separation performance to achieve the same atmosphere with 2-channel sources as with 6.1-channel sources.

• DTS Neo : 6 Music

This mode is suited mainly for playing music. The front left and front right signals bypass the decoder and are played directly so there is no loss of sound quality, and the effect of the surround signals from the center, surround left, surround right and surround back channels adds a natural sense of expansion to the sound field.

DTS 96/24

Conventional surround formats used sampling frequencies of 48 or 44.1 kHz, so 20 kHz was about the maximum playback signal frequency. With DTS 96/24, the sampling frequency is increased to 96 or 88.2 kHz to achieve a wide frequency range of over 40 kHz. In addition, this format has a resolution of 24 bits, resulting in the same frequency band and dynamic range as 96kHz / 24 bit PCM signals.

As with conventional DTS surround, DTS 96/24 is compatible with a maximum of 5.1 channels. DTS 96/24 is fully compatible with the conventional DTS surround format, so DTS 96/24 sources can be played using a conventional DTS 5.1 channel decoder.

"DTS" and "DTS-ES | Neo:6" are registered trademarks of DTS, Inc. "96/24" is a trademarks of DTS, Inc.

Dolby Digital

Dolby Digital is the multi-channel digital signal format developed by Dolby Laboratories. Discs bearing the "  " includes the recording of up to 5.1 channels of digital signals, which can reproduce much better sound quality, spatial expansion and dynamic range characteristics than the previous Dolby Surround effect.

Dolby Digital EX

This mode creates the back (sometimes also referred to as "surround center") signals from the surround left and right signals in Dolby Digital 5.1 channel source using a matrix decoder and provides 6.1 channel surround playback. For the best results, this mode should be selected during playback of sources (bearing the "  ") recorded in Dolby Digital EX.

With this additional channel, you can experience more dynamic and realistic moving sound especially. When Dolby Digital EX sources are decoded with a Dolby Digital EX decoder, the format is automatically detected upon decoding and the Dolby Digital EX mode is selected. However, some Dolby Digital EX sources may be detected as Dolby Digital sources. In this case, the Dolby Digital EX mode should be selected manually to play these sources.

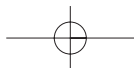

Dolby Pro Logic IIx surround

Dolby Pro Logic IIx decodes all stereo (2 channel) and 5.1 channel sources and extends to 7.1 channel surround playback. It delivers the most natural, full range and immersing 7.1 channel listening experience. Dolby Pro Logic IIx surround includes two modes as follows:

• Dolby Pro Logic IIx Movie

When enjoying movies, this mode allows you to further enhance the cinematic quality by adding processing that emphasizes the sounds of the action special effects.

• Dolby Pro Logic IIx Music

When listening to music, this mode allows you to further enhance the sound quality by adding processing that emphasizes the musical effects.

Dolby Pro Logic II surround

This mode applies conventional 2-channel signals such as digital PCM or analog stereo signals as well as Dolby Surround signals, etc. to surround processing to offer improvements over conventional Dolby Pro Logic circuits.

Dolby Pro Logic II surround includes Dolby Pro Logic II Movie and Dolby Pro Logic II Music like Dolby Pro Logic IIx surround.

Dolby Virtual Speaker

This mode creates a virtual surround sound field using as few as two front speakers, allowing you to experience listening from 5.1 channel speakers.

This mode is effective not only for 5.1 channel sources but also for stereo(2 channel) sources.

Dolby Virtual Speaker includes two listening mode as follows:

• Dolby Virtual Speaker Reference

The width of the front sound image is defined by the actual distance between front speakers.

• Dolby Virtual Speaker Wide

The width of the front sound image seems to extend beyond the front speakers.

- When using the EXTERNAL INs to play back the sound from the additional multi-channel decoder for surround sound, you can enjoy the corresponding surround sound, too.(For details, refer to the operating instructions of the component to be connected.)

For your reference, the sound from each channel can be reproduced according to the surround modes as follows:

Modes	Channels	FRONT L/R	CENTER	SURROUND L/R	SURROUND BACK L/R	SUBWOOFER
DTS, DTS 96/24					—	
DTS ES DISCRETE/MATRIX						
DTS NEO: 6 CINEMA/MUSIC						—(*)
DOLBY DIGITAL					—	
DOLBY DIGITAL EX						
DOLBY PRO LOGIC IIx MOVIE/MUSIC						
DOLBY PRO LOGIC II MOVIE/MUSIC					—	
DOLBY PRO LOGIC					—	—(*)
DOLBY VIRTUAL SPEAKER					—	—(*)
Other Surrounds						—(*)
STEREO		—		—	—	—(*)
EXTERNAL IN						

(*): Depending on the subwoofer setting, the sound from the subwoofer channel may be reproduced.

- Depending on the speaker settings and the number of the encoded channels, etc., the sound from the corresponding channels cannot be reproduced.(For details, refer to "SETTING THE SPEAKER SETUP" on page 41.)



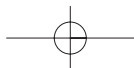

ENJOYING SURROUND SOUND

Notes:

- Before surround playback, first perform the speaker setup procedure, etc. on the SETUP menu for optimum performance. (For details, refer to "SETTING THE SPEAKER SETUP" on page 41.)
- When the EXTERNAL IN is selected as an input source, the surround modes cannot be selected.

Depending on how to select a surround mode, select the auto surround mode or the manual surround mode.

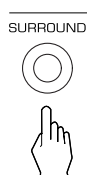

- Each time this button is pressed, the mode changes as follows :
 Auto surround mode : The optimum surround mode will be automatically ("AUTO" indicator lights up) selected depending on the signal format being input.
 Manual surround mode : You can select the desired of different surround modes selectable for the signal being input with using the MULTI CONTROL knob or the SURROUND MODE UP/DOWN (>/<) buttons.

Notes :

- When the SPEAKER button is set to off, the auto surround mode is invalid.
- Even when the auto surround mode is selected and the same type of digital signal format is being input, the optimum surround mode may vary depending on whether the speaker type is set to "N"(None) or not.
- When the auto surround mode is selected and the PCM (2 channel) digital signal or the analog stereo signal is being input, only the stereo mode will be selected.
- When the auto surround mode is selected, the surround modes other than the optimum surround mode cannot be selected.

When selecting the manual surround mode with pressing the SURROUND MODE button on the front panel.

Select the desired surround mode.

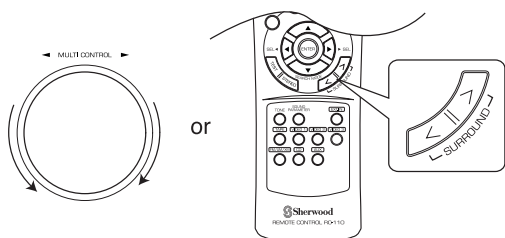

- Each time the MULTI CONTROL knob is rotated or the SURROUND MODE UP / DOWN (>/<) buttons are pressed, the surround mode changes depending on the input signal format as follows :

Signal format being input	Selectable surround mode
Dolby Digital EX6.1 channel sources, Dolby Digital 5.1 channel sources	(DOLBY D + PLIix MOVIE), < DOLBY D + PLIix MUSIC, DOLBY DIGITAL EX>, DOLBY DIGITAL, DOLBY VS REF, DOLBY VS WIDE
Dolby Digital 2 channel sources	<DOLBY PLIix MOVIE, DOLBY PLIix MUSIC>, [DOLBY PLII MOVIE, DOLBY PLII MUSIC], DOLBY PRO LOGIC, DOLBY VS REF, DOLBY VS WIDE
DTS sources	corresponding DTS mode, DOLBY VS REF, DOLBY VS WIDE, {DTS + NEO:6}
96 kHz PCM (2channel) sources	<DOLBY PLIix MOVIE, DOLBY PLIix MUSIC>, [DOLBY PLII MOVIE, DOLBY PLII MUSIC], DOLBY PRO LOGIC, NEO:6 CINEMA, NEO:6 MUSIC, THEATER, HALL, STADIUM
PCM (2channel) sources, Analog stereo sources	<DOLBY PLIix MOVIE, DOLBY PLIix MUSIC>, [DOLBY PLII MOVIE, DOLBY PLII MUSIC], DOLBY PRO LOGIC, DOLBY VS REF, DOLBY VS WIDE, NEO:6 CINEMA, NEO:6 MUSIC, THEATER, HALL, STADIUM

- Depending on surround speaker setting, some surround modes can be selected or not as follows:
 < > : Possible only when surround back speaker is not set to "N"(None).
 [] : Possible only when surround back speaker is set to "N"(None).
 () : Possible only when surround back speaker is set to "2c"(2ch).
 { } : Possible only when surround back speaker is not set to "N"(None) while playing the digital signals from DTS 5.1 channel sources only(, not DTS 96/24 sources).

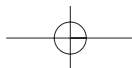

Continued

To cancel the surround mode for stereo operation

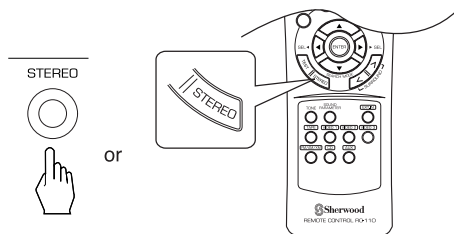

- Depending on the signal format which is being input, either the stereo mode or the 2CH downmix mode is selected.
- To cancel either the stereo mode or the 2CH downmix mode, select the surround mode with using the MULTI CONTROL knob on the front panel or the SURROUND MODE UP/DOWN (>/<) buttons on the remote control.

ENGLISH

2CH downmix mode

- This mode allows the multi-channel signals encoded in DTS or Dolby Digital format to be mixed down into 2 front channels and to be reproduced through only two front speakers or through headphones.
- When the SPEAKER button is set to off to listen with headphones, if the STEREO button is pressed while playing the multi-channel digital signals from DTS or Dolby Digital sources, it will enter the 2CH downmix mode automatically.
- To cancel the 2CH downmix mode, select the desired Dolby Headphone mode with using the MULTI CONTROL knob on the front panel or the SURROUND MODE UP/DOWN (>/<) buttons on the remote control.

Listening in a Dolby Headphone mode

- The Dolby Headphone function simulates 5.1 channel surround sound, which allows you to enjoy 5.1 channel surround sound through 2 channel headphones, just like listening from 5.1 channel speakers.

Notes :

- Only when the SPEAKER button is set to off, the Dolby Headphone mode can be selected.
- When playing the 96 kHz PCM(2 channel) digital signals, only the stereo mode can be selected.
- While listening with headphones, select the desired Dolby Headphone mode.

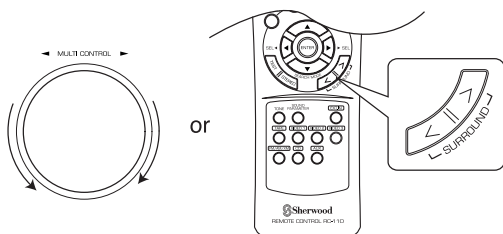

- Each time the MULTI CONTROL knob is rotated or the SURROUND MODE UP/DOWN (>/<) buttons are pressed, the mode changes as follows :
- | | |
|---|---|
| † | DH 1 : This simulates the soundfield as if you were in a relatively small room with less reverberations. |
| ‡ | DH 2 : This simulates the soundfield as if you were in a typical listening room with moderate reverberations. |
| § | DH 3 : This simulates the soundfield as if you were in a large space like theater. |

When adjusting the sound parameters

- While playing digital signals from Dolby Digital or DTS program source or listening in a surround mode such as Dolby Pro Logic II / Dolby Pro Logic IIx Music, Dolby Headphone, Dolby Virtual Speaker mode, you can adjust their parameters for optimum surround effect.

1. Press the SOUND PARAMETER button.

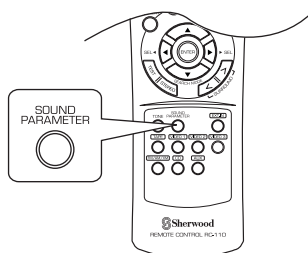

- Depending on the kind of digital input signal or/and the selected surround mode, the corresponding parameter mode is displayed for several seconds as follows:

- * **"NIGHT" (Night mode) :**
Selectable only while playing digital signals from Dolby Digital or DTS source.
- * **"PANO" (Panorama mode) :**
Selectable only while listening in Dolby Pro Logic II/Dolby Pro Logic IIx Music mode.
- * **"REF" or "WIDE" (Dolby VS Reference/Wide mode) :**
Selectable only while listening in Dolby Virtual Speaker mode.
- * **"DH 1" (Dolby Headphone 1 mode) :**
Selectable only while listening in Dolby Headphone mode.

- If the parameter mode disappears, press this button again.

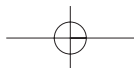

Continued

2. Press the CURSOR UP()/DOWN() buttons to select the desired parameter.

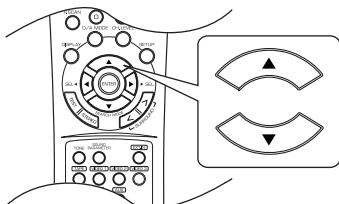

• Depending on the surround mode, each time these buttons are pressed, the parameter mode changes as follows:

* When listening in Dolby Pro Logic II/Dolby Pro Logic IIx Music mode, you can adjust the various surround parameters for optimum surround effect.

↑ “PANO” ↓ “C.WIDTH” ↓ “DIMEN” ↓
(Panorama mode) (Center width control) (Dimension control)

* When listening in Dolby Virtual Speaker mode, you can select the speaker layout to be used actually for each Dolby Virtual Speaker mode.

REF ↓ WIDE
(Dolby VS Reference mode) (Dolby VS Wide mode)

* When listening in Dolby Headphone mode, you can select the desired listening mode for each Dolby Headphone mode.

↑ DH 1 ↓ DH 2 ↓ DH 3 ↓
(Dolby Headphone 1 mode)

3. Press the CURSOR LEFT()/RIGHT() buttons to adjust the selected parameter as desired.

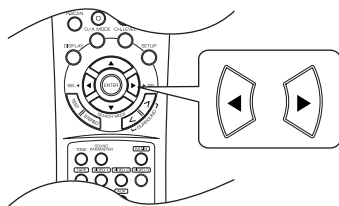

When selecting the “NIGHT” (Night mode)

This function compresses the dynamic range of previously specified parts of the Dolby Digital or DTS sound track (with extremely high volume) to minimize the difference in volume between the specified and non specified parts.

This makes it easy to hear all of the sound track when watching movies at night at low levels.

The night mode can be set in 11 steps from 0.0 to 1.0 (default value : 0.0)

Note: In some Dolby Digital or DTS softwares, the night mode may not be valid.

[Dolby Pro Logic II/Dolby Pro Logic IIx Music Parameters]

When selecting the “PANO” (Panorama) mode

This mode extends the front stereo image to include the surround speakers for an exciting “wraparound” effect with side wall imaging. Select “OFF” or “ON” (default value : OFF).

When selecting the “C.WIDTH” (Center width) control

This adjusts the center image so it may be heard only from the center speaker, only from the left/right speakers as a phantom image, or from all three front speakers to varying degrees.

The control can be set it 8 steps from 0 to 7 (default value : 3).

When selecting the “DIMEN” (Dimension) control

This gradually adjusts the soundfield either towards the front or towards the rear. The control can be set in 7 steps from -3 to +3 (default value : 0).

[Dolby Virtual Speaker Parameters]

When selecting the “REF” (Dolby Virtual Speaker Reference) mode

2 SP : When using 2 front speakers only.

↓

3 SP : When using 2 front and center speakers.



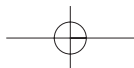

Continued

When selecting the "WIDE" (Dolby Virtual Speaker Wide) mode

- 2 SP : When using 2 front speakers only.
- 3 SP : When using 2 front and center speakers
- 4 SP : When using 2 front and 2 surround speakers.
- 5 SP : When using 2 front, center and 2 surround speakers.

Note: When the speakers are set to "N" (None), the corresponding speaker layouts cannot be selected.

[Dolby Headphone Parameters]

When selecting the "DH 1", "DH 2", "DH 3" (Dolby Headphone 1,2,3) mode

- MOVIE : This provides the surround effect suitable for movie sources.
- MSC 1 : This provides the surround effect suitable for music sources.
- MSC 2 : This provides less surround effect compared to Music 1 mode.

Note : You can select the listening mode only when playing analog stereo, PCM 2 channel or Dolby Digital 2 channel source.

4. Repeat the above steps 2 and 3 to adjust other parameters

Adjusting each channel level with test tone

- The volume level of each channel can be adjusted easily with the test tone function.

Note : When the SPEAKER button is set to off or it is in the stereo mode, etc., the test tone function does not work.

1. Enter the test tone mode.

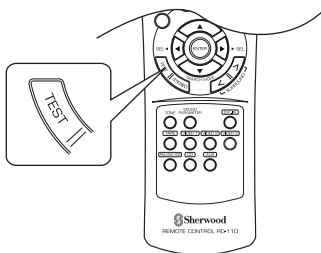

- The test tone will be heard from the speaker of each channel for 2 seconds as follows:

FL	C	FR	SR
Front Left	Center	Front Right	Surround Right
SW	SL (SB) or (BL BR)
Subwoofer	Surround Left	Surround Back	Surr.Back Left Surr.Back Right

- When the speaker setting is "N" (None or No), the test tone of the corresponding channel is not available.
- () : Possible depending on whether the surround back channel is set to "2c" (2ch) or "1c" (1ch).

2. At each channel, adjust the level as desired until the sound level of each speaker is heard to be equally loud.

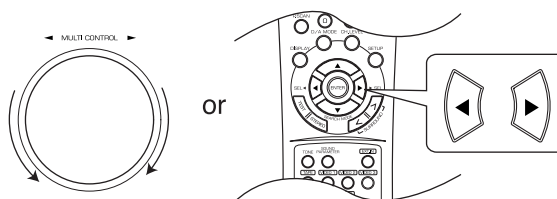

- You can select the desired channel with pressing the CONTROL UP()/DOWN() buttons or the CURSOR UP()/DOWN() buttons.

3. Cancel the test tone function.

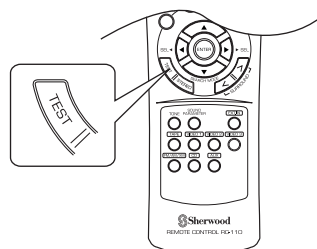

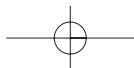

Adjusting the current channel level

- After adjusting each channel level with test tone, adjust the channel levels either according to the program sources or to suit your tastes.
- You can adjust the current channel levels as desired. These adjusted levels are just memorized into user's memory ("CAL"), not into preset memory("REF 1", "REF 2").

1. Press the CHANNEL LEVEL button.

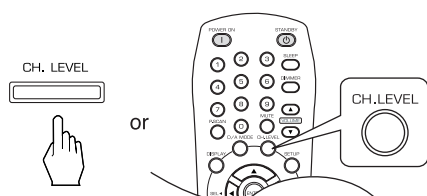

- Then the memory mode ("CAL" or "REF 1", etc.) is displayed for several seconds.
- When the memory mode or channel level disappears, press this button again.

2. Select the desired channel.

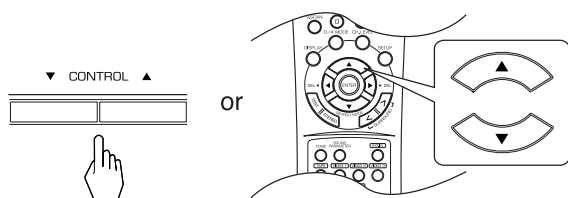

- Each time these buttons are pressed, the corresponding channel is selected as follows:

REF 1,2 (or CAL)	FL	C	FR	SR
<DTS or DD>	SW	SL(SB) or(BL BR)
DTS LFE	Dolby Digital LFE			

(): Possible depending on whether the surround back channel is set to "2c" or "1c".

<>: Possible only when the digital signals from Dolby Digital or DTS program sources that include LFE signal are input.

- Depending on the speaker settings("N"(None or No) and surround mode, etc., some channels cannot be selected.

3. Adjust the level of the selected channel as desired.

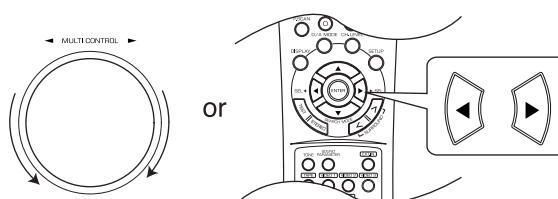

- The LFE level can be adjusted within the range of -10 ~ 0 dB and other channel levels within the range of -15 ~ +15 dB.
- In general, we recommend the LFE level to be adjusted to 0 dB. (However, the recommended LFE level for some early DTS software is -10 dB.) If the recommended levels seem too high, lower the setting as necessary.

4. Repeat the above steps 2 and 3 to adjust each channel level.



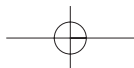

Memorizing the adjusted channel levels

- You can memorize the adjusted channel levels into preset memory("REF 1", "REF 2") and recall the memorized whenever you want.

- After performing the steps 1~4 in "Adjusting the current channel level" procedure on page 24, press the (MEMORY) ENTER button.

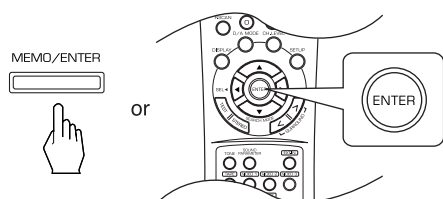

- The "1" of "REF 1" indication flickers for several seconds.

- Select the desired one of REF 1 and REF 2.

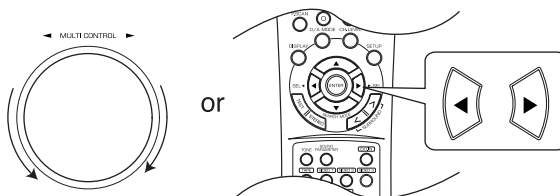

- If the preset memory disappears, perform the above step 1 again.

- Confirm your selection.

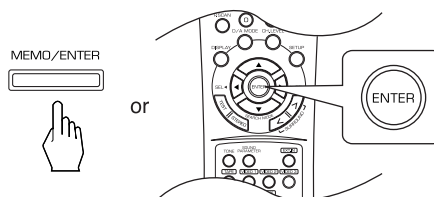

- The adjusted channel levels have now been memorized into the selected memory.

Recalling the memorized channel levels

- Press the CHANNEL LEVEL button.

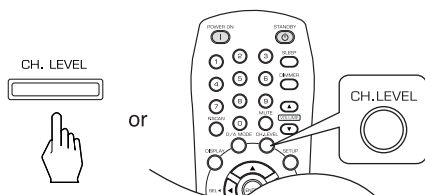

- "CAL" (or "REF 1", etc.) is displayed for several seconds.
- If the channel level mode display disappears, press this button again.

- Select the desired one of REF 1 and REF 2.

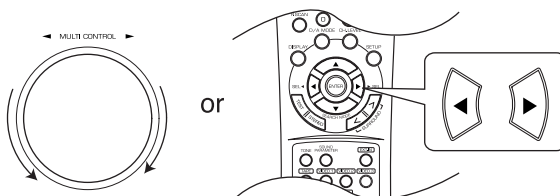

- Then the channel levels memorized into the selected preset memory are recalled.

ENGLISH

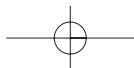

LISTENING TO RADIO BROADCASTS

Auto tuning

1. Select the desired band.

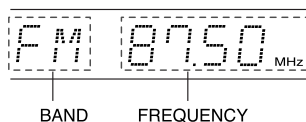
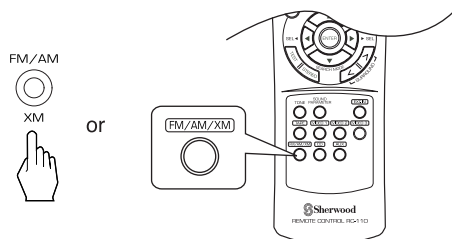

- Each time this button is pressed, the band changes as follows:

FM ST	FM MONO	AM	XM
("ST" lights up) ("ST" goes off)			

- When FM stereo broadcasts are poor because of weak broadcast signals, select the FM mono mode to reduce the noise, then FM broadcasts are reproduced in monaural sound.
- To listen to XM Satellite Radio, select XM mode. (For details, refer to "XM Satellite Radio (only for North America)" on page 28.)

2. Press the TUNING UP(+)/DOWN(-) buttons or the SELECT UP() / DOWN() buttons for more than 0.5 second.

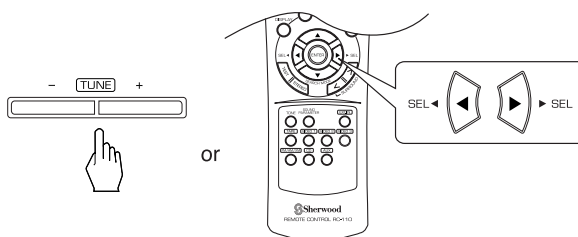

- The tuner will now search until a station of sufficient strength has been found. The display shows the tuned frequency and "TUNED".
- If the station found is not the desired one, simply repeat this operation.
- Weak stations are skipped during auto tuning.

Manual tuning

- Manual tuning is useful when you already know the frequency of the desired station.
- After selecting the desired band, press the TUNING UP(+)/DOWN(-) buttons or the SELECT UP() / DOWN() buttons repeatedly until the right frequency has been reached.

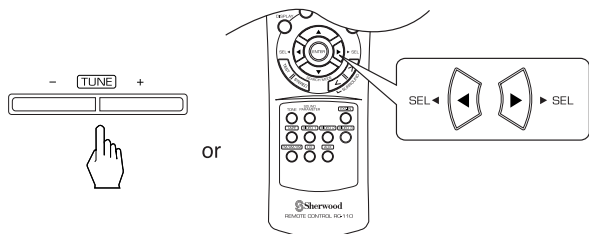

Auto presetting

- Auto presetting function automatically searches for FM stations only and store them in the memory.
- While listening to radio broadcasts, press and hold down the (MEMORY)/ENTER button for more than 2 seconds.

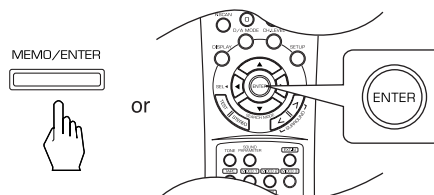

- Then "AUTO MEM" flickers and this receiver starts auto presetting.
 - Up to 30 FM stations can be stored.
- Notes:**
- FM stations of weak strength cannot be memorized.
 - To memorize AM stations or weak stations, perform "Manual presetting" procedure with using "Manual tuning" operation.
 - In the XM mode, auto presetting doesn't work.

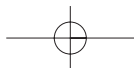

Manual presetting

- You can store up to 30 preferred stations in the memory.

1. Tune in the desired station with auto or manual tuning.

2. Press the (MEMORY/) ENTER button.

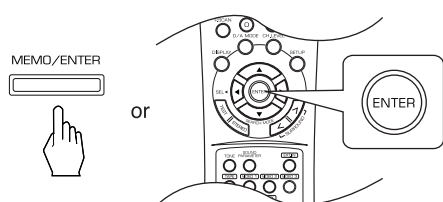

- "MEM" is flickering for several seconds.

3. Select the desired preset number (1~30) and press the (MEMORY/)ENTER button.

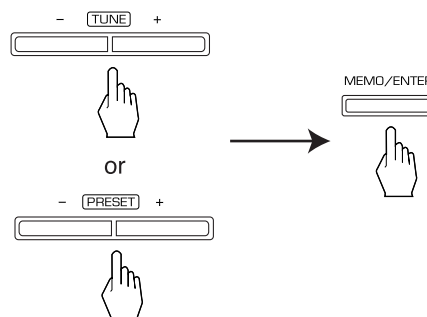

- When using the NUMERIC buttons on the remote control.

Examples) For "3" :

③

For "15" :

①

within 2 seconds → ⑤

For "30" :

③

within 2 seconds → ⑩

- The station has now been stored in the memory.
- When using the NUMERIC buttons, the station is stored automatically without pressing the (MEMORY/)ENTER button.
- A stored frequency is erased from the memory by storing another frequency in its place.
- If "MEM" goes off, start again from the above step 2.

4. Repeat the above steps 1 to 3 to memorize other stations.

MEMORY BACKUP FUNCTION

The following items, set before the receiver is turned off, are memorized.

- INPUT SELECTOR settings
- Surround mode settings
- Preset stations, etc.

Tuning to preset stations

- After selecting the tuner as an input source, select the desired preset number.

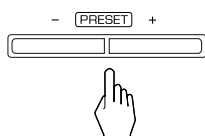

- When using the NUMERIC buttons on the remote control.

Examples) For "3" :

③

For "15" :

①

within 2 seconds → ⑤

For "30" :

③

within 2 seconds → ⑩

Scanning preset stations in sequence

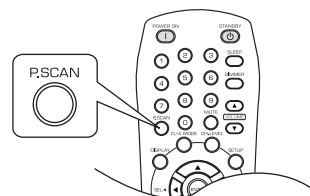

- The receiver will start scanning the stations in the preset sequence and each station is received for 5 seconds.
- At the desired station, press this button again to stop scanning.

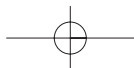

XM Satellite Radio (only for North America)

- This receiver is the XM Ready® receiver. You can receive XM Satellite Radio® by connecting to the XM Mini-Tuner system (sold separately) and subscribing the XM service.

About XM Satellite Radio for U.S. & Canadian products

XM Satellite Radio offers an extraordinary variety of commercial-free music, plus the best in sports, news, talk and entertainment. XM is broadcast in superior digital audio from coast to coast. From rock to reggae, from classical to hip hop, XM has something for every music fan. XM's dedication to playing the richest selection of music is matched by its passion for live sporting events, talk radio, up-to-the-minute news, stand-up comedy, children's programming, and much more. For U.S. customers, information about XM Satellite Radio is available online at www.xmradio.com. For Canadian customers, information about XM Canada is online at www.xmradio.ca.

XM Ready® legal for U.S. & Canadian products

Hardware and required monthly subscription sold separately. Other fees and taxes, including a one-time activation fee may apply. Subscription fee is consumer only. All fees and programming subject to change. Channels with frequent explicit language are indicated with an XL. Channel blocking is available for XM radio receivers by calling 1-800-XMRADIO (US residents) and 1-877-GET-XMSR (Canadian residents). For a full listing of the XM commercial-free channels and advertising-supported channels, visit lineup.xmradio.com (US residents) or xmradio.ca (Canadian residents). Subscriptions subject to Customer Agreement available at xmradio.com (US residents) and xmradio.ca (Canadian residents). Only available in the 48 contiguous United States and Canada. ©2006 XM Satellite Radio Inc. All rights reserved. All other trademarks are the property of their respective owners.

XM Ready® subscriptions for U.S. Products & Canadian products

Once you have installed the XM Mini-Tuner Dock, inserted the XM Mini-Tuner, connected the XM Dock to your XM Ready® home audio system, and installed the antenna, you are ready to subscribe and begin receiving XM programming. There are three places to find your eight character XM Radio ID: on the XM Mini-Tuner, on the XM Mini-Tuner package, and on XM Channel 0. Record the Radio ID in the following eight squares for reference.



Note: The XM Radio ID does not use the letters "I", "O", "S" or "F". Activate your XM Satellite Radio service in the U.S. online at <http://activate.xmradio.com> or call 1-800-XM-RADIO (1-800-967-2346). You will need a major credit card. XM will send a signal from the satellites to activate the full channel lineup. Activation normally takes 10 to 15 minutes, but during peak busy periods you may need to keep your XM Ready home audio system on for up to an hour. When you can access the full channel lineup on your XM Ready home audio system you are done. For more information or to subscribe in Canada, visit XM on the Web at www.xmradio.ca or call XM's Listener Care at 1-877-GET-XMSR (1-877-438-9677).

LISTENING TO XM SATELLITE RADIO

Signing up for XM Satellite Radio

- Before using XM Satellite Radio, you must first sign up for an account. You will need a major credit card and your XM Satellite Radio ID, which you can get from this receiver as explained below.

1. Press the BAND button repeatedly to select XM mode.

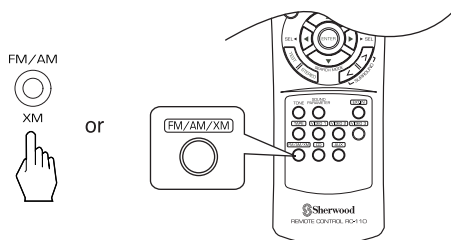

- Then "XM ~" is displayed.

2. Press the TUNING UP(+)/DOWN(-) buttons or the SELECT UP() / DOWN() buttons repeatedly to select "XM 000".

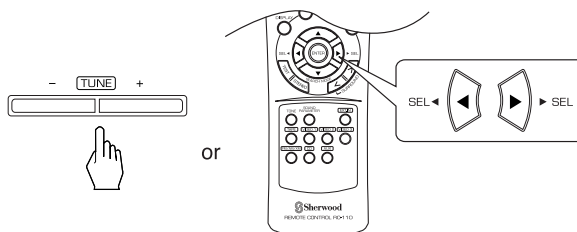

- Then your XM Satellite Radio ID is displayed.
- You can find the XM Satellite Radio ID on the XM Mini-Tuner itself and the XM Mini-Tuner package, too.

3. To sign up, access the website at "<http://activate.xmradio.com>" or call "1-800-967-2346".

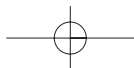

Channel search

- In the XM mode, press the TUNING UP (+)/DOWN (-) buttons or the SELECT UP() / DOWN() buttons repeatedly to select the desired channel.

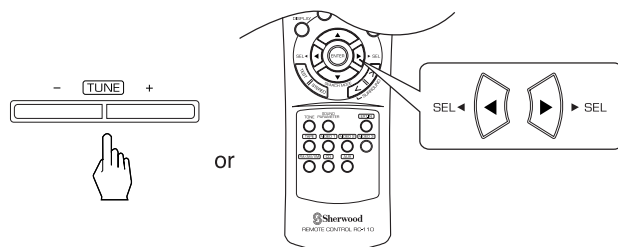

ENGLISH

Direct search

- Direct search is useful when you already know the channel number.

- In the XM mode, select the direct search mode.

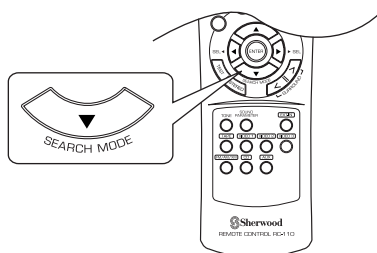

- Each time this button is pressed, the search mode changes as follows:

XM ---	Category name	OFF
(Direct search)	(Category search)	

Note: When using channel search or preset search, press this button to select the search off.

- While displaying "XM ---", select the desired channel number with pressing the NUMERIC buttons.

Examples) For "3" :

③

For "27" : ② within 5 seconds → ⑦

For "124" : ① within 5 seconds → ② within 5 seconds → ④

- When "XM ---" disappears, repeat again from the above step 1.

Category search

- Category search allows you to select the desired channel by the selected category.

- In the XM mode, select the category search mode.

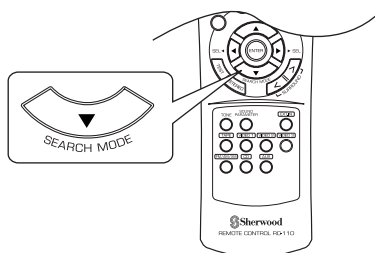

- Then a category name is displayed.

- While displaying a category name, select the desired category.

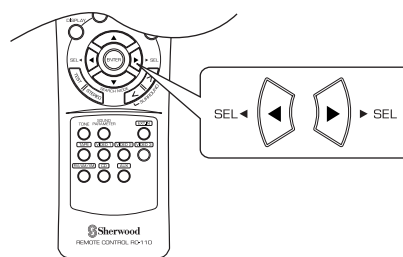

- Each time these buttons are pressed, one of different categories is selected.
- When a category name disappears, repeat again from the above step 1.

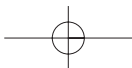

Continued

3. Select the desired channel in the selected category.

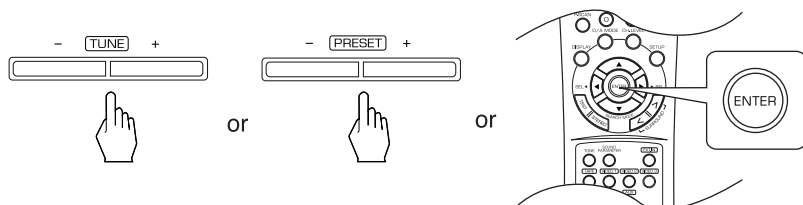

Presetting channels

• You can store up to 30 preferred channels in the memory.

1. Select the desired channel with performing channel search, direct search or category search.

2. To memorize the channels, perform the steps 2 to 4 in "Manual presetting" procedure on page 27.

Preset search

• In the XM mode, select the desired preset channel.

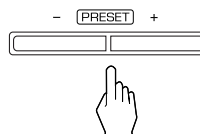

• When using the NUMERIC buttons on the remote control.

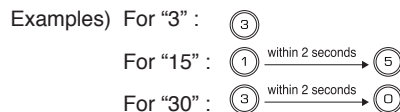

Displaying XM information

• You can display XM information such as channel name, artist name, song title and signal strength.

• In the XM mode,

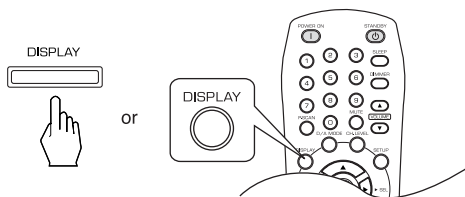

Note:

• If the information on artist name, song title or category is not available, it will not be displayed correctly.

Signal strength display mode

• If the reception is poor, you can check the signal strength of the XM radio signal and adjust the position of the XM antenna until "GOOD" is displayed.

• Each time the DISPLAY button is pressed, the display mode changes as follows:

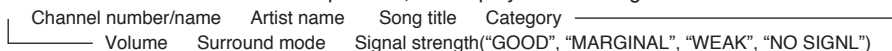

Error message and status

• If an operation takes longer than usual or an error occurs, one of the following messages may be displayed.

Message	Status
ANTENNA	The XM Mini-Tuner system is not connected correctly. Check the antenna.
UPDATING	The XM user encryption code is being updated. Please wait.
NO SIGNAL	The signal is too weak. Check the antenna connection and reposition it for the best reception.
LOADING	This receiver is tuning or decoding audio or text data. Please wait.
OFF AIR	The selected XM channel is not currently broadcasting. Select another channel.

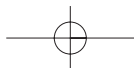

RECORDING

- The analog signals from the EXTERNAL INs as well as the digital signals from the coaxial or optical digital input can be heard but cannot be recorded.
- When recording the analog signals from CD, AUX, VIDEO 1~2, be sure to make the analog audio connection between components.
- The volume and tone (bass, treble) settings have no effect on the recording signals.

Recording with TAPE

1. Select the desired input as a recording source except for TAPE.

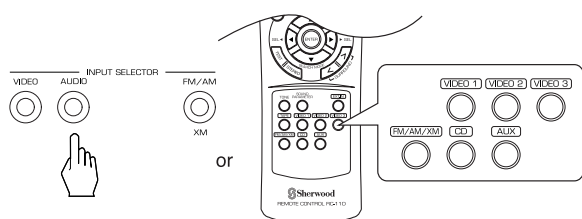

2. Start recording on the TAPE.

3. Start play on the desired input.

Dubbing from video components onto VIDEO 1

1. Select the desired of VIDEO 2 ~ 3 as a recording source except VIDEO 1.

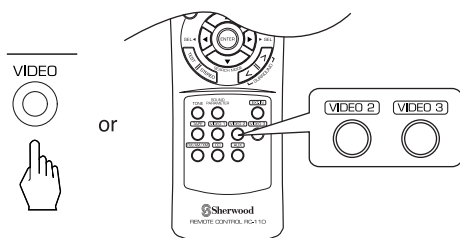

2. Start recording on the VIDEO 1.

3. Start play on the desired input.

- The audio and video signals from the desired input will be dubbed onto the VIDEO 1 and you can enjoy them on the TV set and from the speakers.

Dubbing the audio and video signals separately onto VIDEO 1

Example) When dubbing the VIDEO 2 video signal and the CD audio signal separately onto VIDEO 1.

1. Select VIDEO 2 as a video recording source.

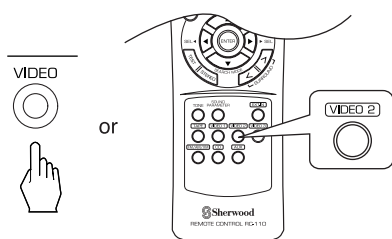

2. Select CD as an audio recording source.

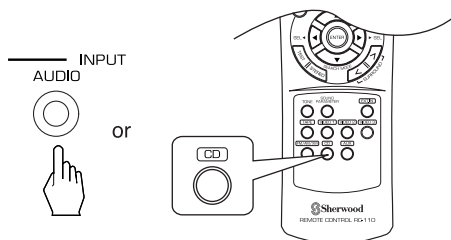

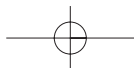

Continued

3. Start recording on the VIDEO 1.

4. Start play on the VIDEO 2 and the CD respectively.

- The audio signal from the CD and the video signal from the VIDEO 2 will be dubbed and you can enjoy them on the TV set and from the speakers.

Note: Be sure to observe the order of the above steps 1 and 2.

DIGITAL AUDIO RECORDING WITH MD RECORDER

- Only when the OPTICAL DIGITAL OUT of this receiver is connected to the OPTICAL DIGITAL IN of the MD recorder or CD recorder, you can enjoy high-quality sound of digital recording without converting the original signals. Refer to "CONNECTING VIDEO COMPONENTS", "CONNECTING AUDIO COMPONENTS" and "CONNECTING DIGITAL INS and OUT" on pages 6~8 and the operating instructions of the MD recorder or CD recorder.

Notes:

- Digital recording is available for the digital audio program sources such as CDs, MDs, some DVDs, etc.
- In most DVDs as well as some CDs, etc., digital recording may not be available depending on the signal format.
- There are some restrictions on recording digital signals. When making digital recordings, refer to the operating instructions of your digital recording equipment to know what restrictions are imposed.

1. Select the desired of CD, AUX, VIDEO 1~2 as a recording source.

2. For digital recording, select the digital input as recording signal input.

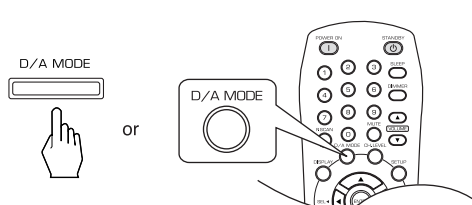
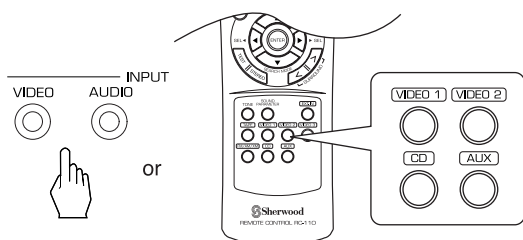

Note :

- When the digital signals are not input from the selected digital input, there will be no recording. (For details, refer to "When CD, AUX, VIDEO 1 ~ 2 is selected as an input source" on page 16.)

3. Start recording on the component connected to the OPTICAL DIGITAL OUT.

4. Start play on the desired input.

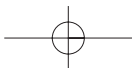

OTHER FUNCTIONS

Operating the sleep timer

- The sleep timer allows the system to continue to operate for a specified period of time before automatically shutting off.
- To set the receiver to automatically turn off after the specified period of time.

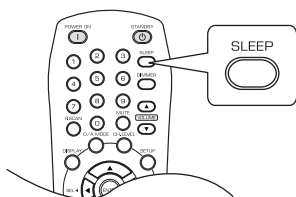

- Each time this button is pressed, the sleep time changes as follows:

10	20	30	---	90	OFF
Unit : minutes					

- While operating the sleep timer, "  " lights up.
- When the sleep time is selected, the fluorescent display is dimly lit.

Adjusting the brightness of the fluorescent display

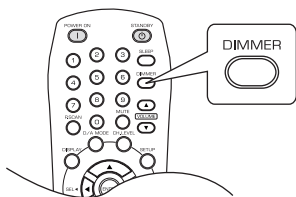

- Each time this button is pressed, the brightness of the fluorescent display changes as follows:

ON	dimmer	OFF
----	--------	-----

- In the display OFF mode, pressing any button will restore the display ON mode.

Displaying the operation status

- During playback,

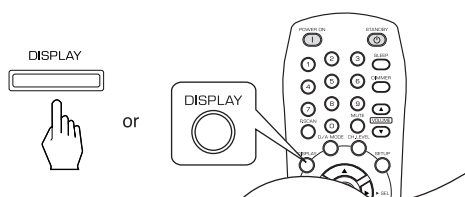

- Each time this button is pressed, the display mode changes as follows:

Surround mode	Volume	Input source
---------------	--------	--------------

- When the EXTERNAL IN is selected as an input source, the surround mode is not displayed.
- When XM Satellite Radio function is available in your country, for details on the XM information, see "Displaying XM information" on page 30.

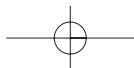

System Setup

- The setup menu is displayed on the fluorescent display and allows you to perform the setup procedures easily. In most situations, you will only need to set this once during the installation and layout of your home theater, and it rarely needs to be changed later.

The setup menu consists of 5 main menus ; system , input, speaker setup, CH level and parameter.
These menus are then divided up into various sub-menus.

Navigating through the setup menu

- The explanations here assume you are using the buttons on the remote control when performing the setup menu operation. However, you can use the buttons on the front panel as well.

The buttons on the front panel correspond to those on the remote control as shown below.

Button on the remote control				
Button on the front panel				

1. Turn the setup menu on.

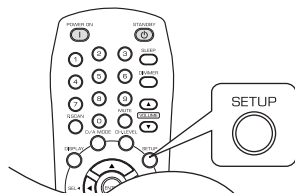

SYSTEM

- The setup menu will be shown.
- To turn the menu off, press this button again.

2. Select the desired menu using the CURSOR UP() / DOWN() buttons.

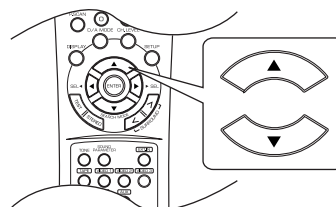

3. Confirm your selection.

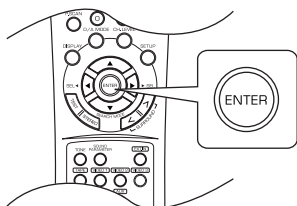

- When selecting "SYSTEM", see "SETTING THE SYSTEM" on page 37.
- When selecting "INPUT", see "SETTING THE INPUT" on page 39.
- When selecting "SPK SET", see "SETTING THE SPEAKER SETUP" on page 41.
- When selecting "CH LEVEL", see "SETTING THE CH LEVEL" on page 48.
- When selecting "PARAMTR", see "SETTING THE SOUND PARAMETER" on page 50.
- When selecting "EXIT", the setup menu will be turned off.

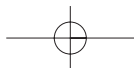

Setup menu flow

• The setup menu flow is as follows:

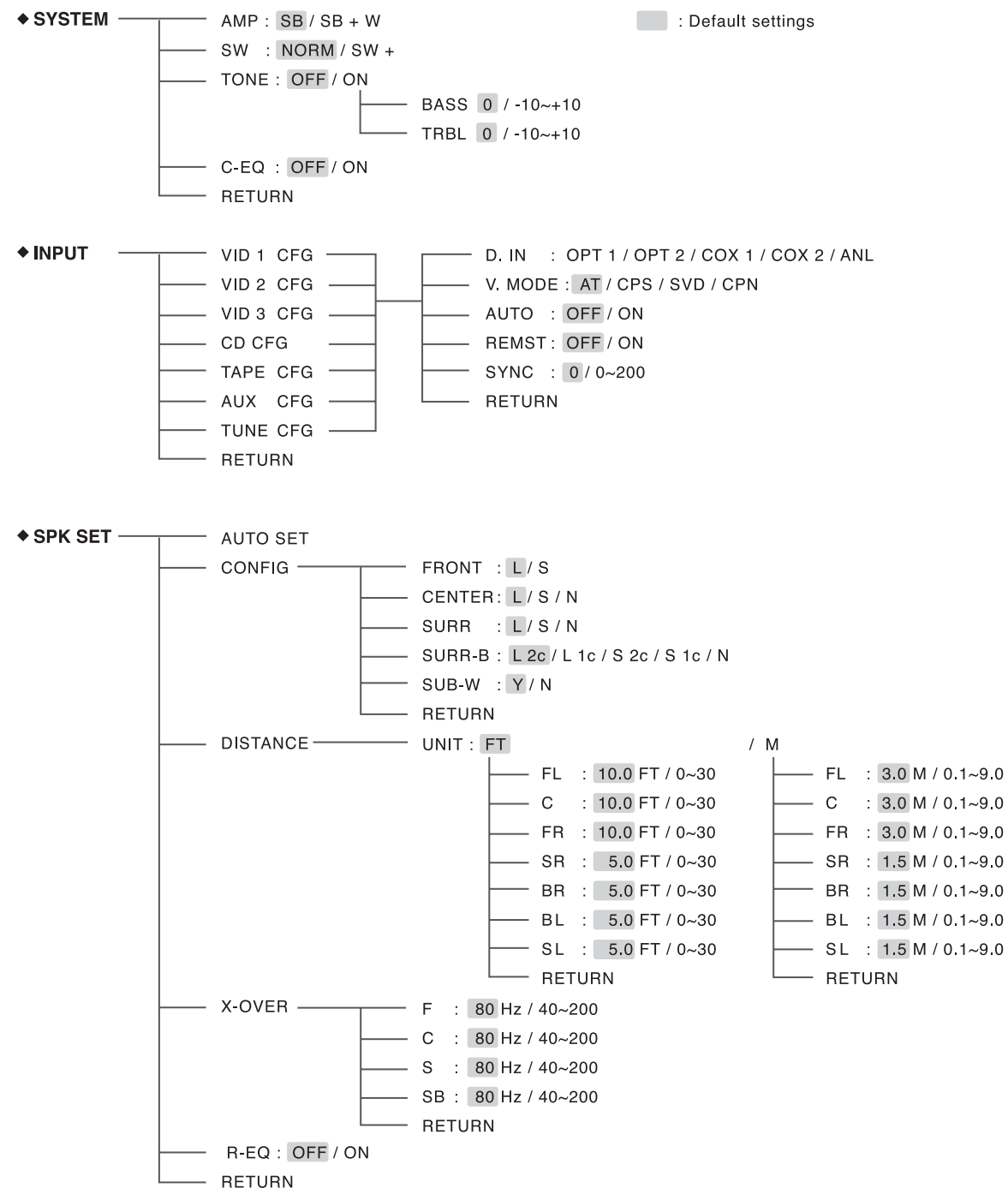

ENGLISH



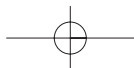

Continued

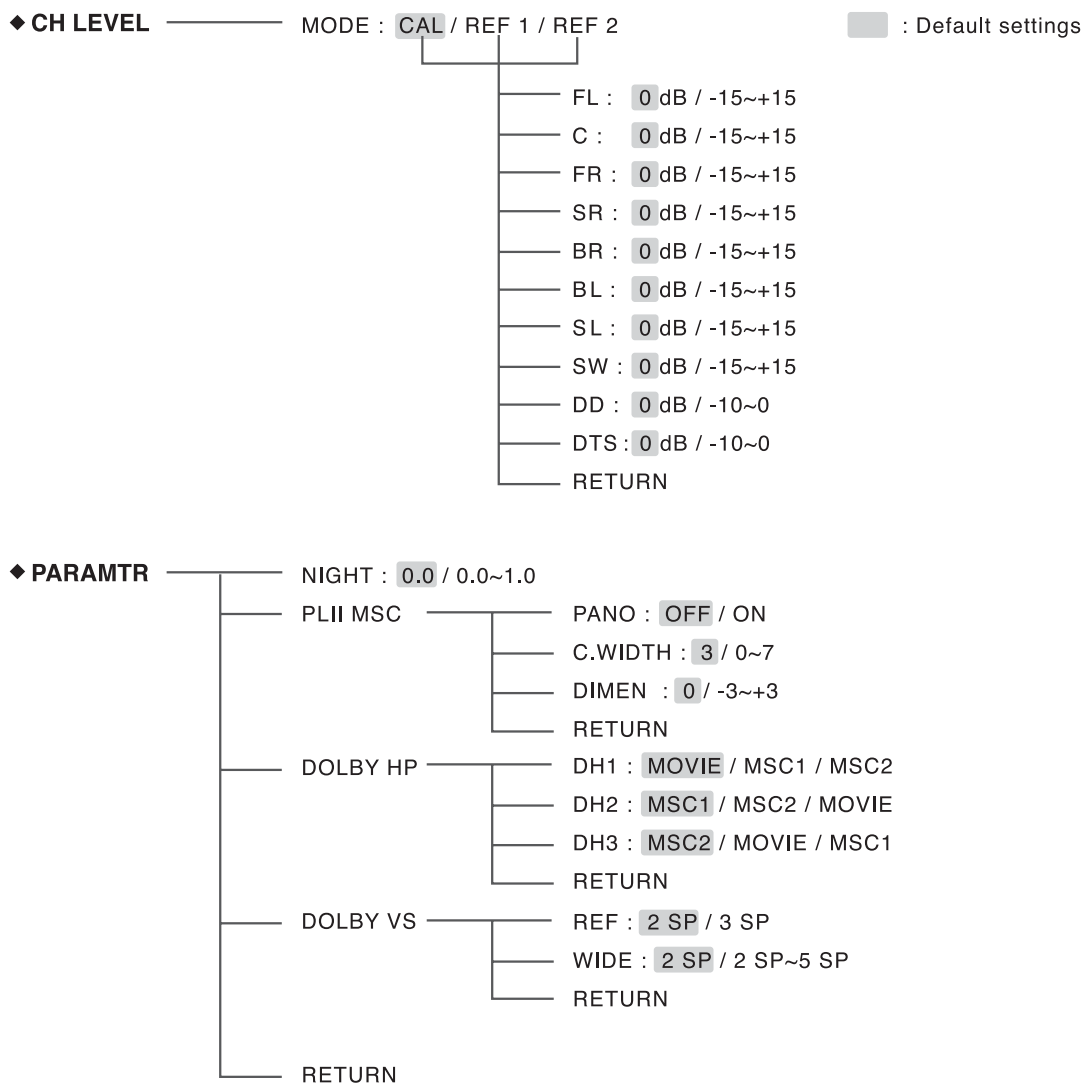

- When "RETURN" is selected on a sub-menu, it will returns to the previous menu.

Note: During setup menu operation, only the (POWER ON)/STANDBY button and the buttons required for system setup will function.



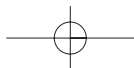

SETTING THE SYSTEM

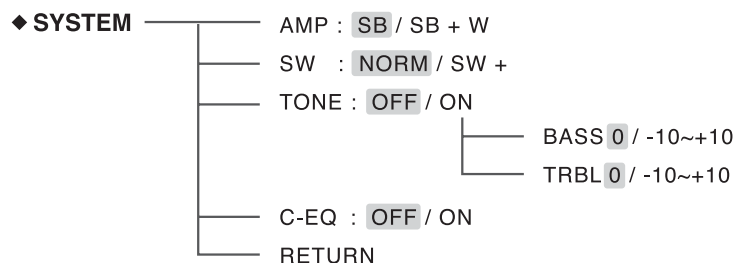

- AMP (AMP ASSIGN) : To assign the power amplifier to the surround back left and right channels or the surround back and the subwoofer channels.
- SW (SUBWOOFER) : To select the desired subwoofer mode.
- TONE : To adjust the tone (bass and treble) as desired.
- C-EQ (CINEMA EQ) : To select the desired cinema EQ mode.
- RETURN : To return to the previous menu.

ENGLISH

- 1.** Press the CURSOR UP()/DOWN() buttons to select the desired item.

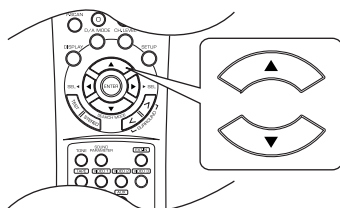

- 2.** Press the CURSOR LEFT()/RIGHT() buttons to set the selected item as desired.

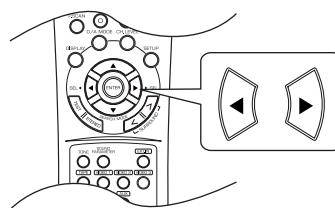

When selecting the AMP ASSIGN

- When connecting one surround back speaker and the subwoofer without built-in amplifier to the SURROUND BACK LEFT and RIGHT channels respectively, you should assign the power amplifier to "SB+W" (Surround Back+Subwoofer). (For details on speaker connection, refer to "CONNECTING SPEAKERS" on page 9.)

SB (Surround Back) : To assign the power amplifier to the surround back left and right channels.

SB+W (Surround Back+Subwoofer) : To assign it to the surround back and the subwoofer channels.

When selecting the SUBWOOFER mode

- "SW +" mode is valid only when "FRONT" and "CENTER" are set to "L" and "SUB-W" is set to "Y" on the SPEAKER SETUP menu. (For details, refer to "SETTING THE SPEAKER SETUP" on page 41.)

NORM : When the low frequency signals of channels set to "L" are reproduced from those channels only.



In this mode, the low frequency signals that are reproduced from the subwoofer channel is only the low frequency signals of LFE (from the multi-channel sources that contains LFE (Low Frequency Effects) channel, also called the ".1" channel) and the channels set to "S".

SW + : When the low frequency signals of channels set to "L" are reproduced simultaneously from those channels and the subwoofer channel.

In this mode, the low frequency range expands more uniformly through the room, but depending on the size and shape of the room, interference may result in a decrease of the actual volume of the low frequency range.



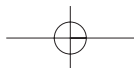

Continued

When selecting the TONE

Note : When the digital signals from DTS, Dolby Digital program sources are input or the EXTERNAL IN is selected as an input source, you cannot adjust the tone and can listen to a program source without the tone effect.

OFF : To listen to a program source without the tone effect. ("DIRECT" indicator lights up.)

ON : To adjust the tone for your taste. ("DIRECT" indicator goes off.)

When the TONE is set to ON to adjust the tone (bass and treble)

Press the CURSOR UP()/DOWN() buttons to select the desired tone.

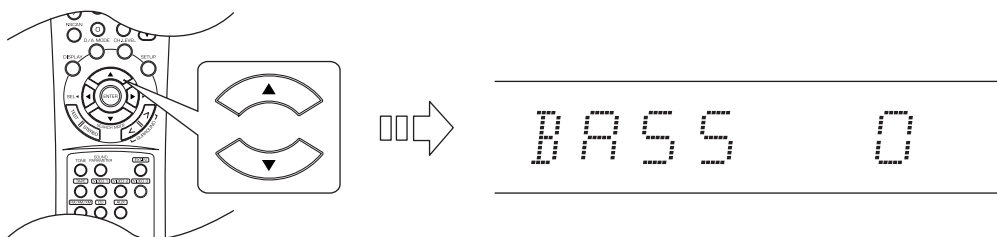

Press the CURSOR LEFT()/RIGHT() buttons to adjust the selected tone as desired.

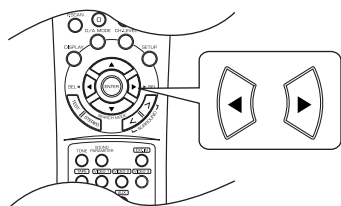

- The tone level can be adjusted within the range of -10 ~ +10 dB.
- In general, we recommend the bass and treble to be adjusted to 0 dB (flat level).
- Extreme settings at high volume may damage your speakers.
- To complete tone adjustment, repeat the above steps and .

When selecting the CINEMA EQ

OFF : To turn off the cinema EQ function.

ON : To compensate for edgy or shrill movie sound tracks.

Note : When the EXTERNAL IN is selected as an input source, the CINEMA EQ is automatically set to OFF.



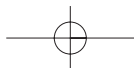

SETTING THE INPUT

◆ INPUT

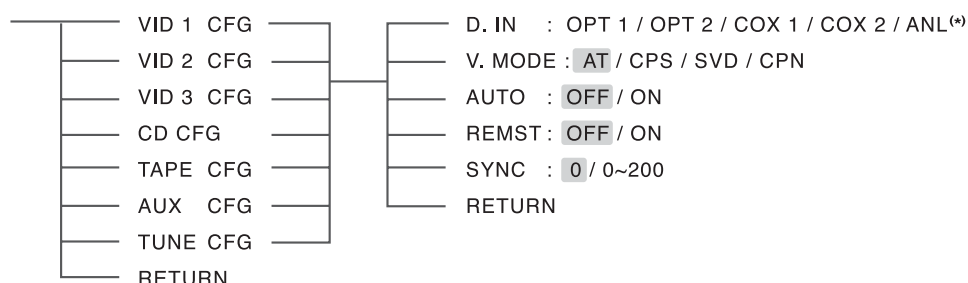

- D.IN (DIGITAL IN) : To assign the connected DIGITAL INs to the desired input.
- V.MODE (VIDEO MODE) : To output the video input signal to be output from the MONITOR OUTs other than the HDMI MONITOR OUT.
- AUTO (AUTO SURROUND) : To select the auto surround mode or the manual surround mode.
- REMST (REMASTER) : To process the input digital signal and to convert its digital sampling frequency to 88.2/96 kHz for a more detailed sound reproduction.
- SYNC (AV SYNC) : To adjust the time delay of audio signals to synchronize the sound with the picture.
- RETURN : To return to the previous menu.

Digital input default settings (*)

"OPT 1" (OPTICAL IN 1) : VIDEO 1, "OPT 2" : "VIDEO 2", "COX 1" (COAXIAL IN 1) : CD, "COX 2" : AUX

ENGLISH

1. Press the CURSOR UP()/DOWN() buttons to select the desired input source, then press the ENTER button.

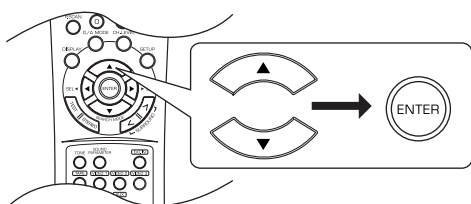

Example: When selecting the VIDEO 1

VIDEO OPT 1

2. Press the CURSOR UP()/DOWN() buttons to select the desired item.

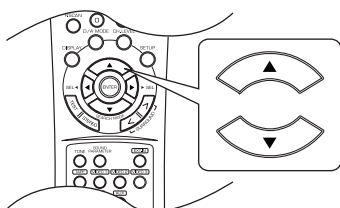

Note :

- Depending on the input source, some items other than "AUTO" (AUTO SURROUND) cannot be selected.

3. Press the CURSOR LEFT()/RIGHT() buttons to set the selected item as desired.

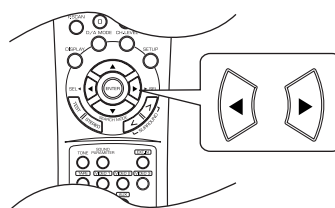

When selecting the DIGITAL IN

- You should assign the connected DIGITAL INs to the desired of CD, AUX and VIDEO 1 ~ VIDEO 2. (For details, refer to "CONNECTING DIGITAL INs and OUT" on page 8.)
- You can select the desired of OPT 1 (optical 1), OPT 2 (optical 2), COX 1 (coaxial 1), COX 2 (coaxial 2) and ANL (analog).

Note :

- In such a case that a DIGITAL IN is assigned to two input sources or more, when these input sources are selected, the digital audio signals can be heard from the same DIGITAL IN.

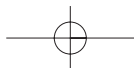

Continued

When selecting the VIDEO MODE

- You can select the video input signal to be output from the MONITOR OUTs other than the HDMI MONITOR OUT.
 - “AT” (AUTO) : When there are multiple video input signals, the video input signals are detected and the video input signal to be output from the MONITOR OUTs is selected automatically in the following order : component video, S-video, composite video.
 - “CPS” (COMPOSITE) : The signal that is input into the (COMPOSITE) VIDEO jack is always played. The composite video input signal is up-converted and output from the S-VIDEO and COMPONENT MONITOR OUT jacks.
 - “SVD” (S-VIDEO) : The signal that is input into the S-VIDEO jack is always played. The S-video input signal is converted and output from the (COMPOSITE) VIDEO and COMPONENT MONITOR OUT jacks.
 - “CPN” (COMPONENT) : The signals that are input into the COMPONENT jacks are always played. Because video conversion is not performed, no video signals are output from the MONITOR OUT jacks when there are no video signals that are input into the COMPONENT jacks.
- For details, refer to "Relationship between the video input signal and the video output signal" on page 7.

When selecting the AUTO SURROUND

- Depending on how to select a surround mode, you can select the auto surround mode or the manual surround mode.
 - OFF (Manual surround mode) : You can select the desired of different surround modes selectable for the signal being input with using the MULTI CONTROL knob or the SURROUND MODE UP/DOWN (>/<) buttons. (For details, refer to "When selecting the manual surround mode with pressing the SURROUND MODE button on the front panel" on page 20.)
 - ON (Auto surround mode) : The optimum surround mode will be automatically selected depending on the signal format being input.

Notes :

- When the SPEAKER button is set to off, the auto surround mode is invalid.
- Even when the auto surround mode is selected and the same type of digital signal format is being input, the optimum surround mode may vary depending on whether the speaker type is set to "N" (None) or not.
- When the auto surround mode is selected and the PCM (2 channel) digital signal or the analog stereo signal is being input, only the stereo mode will be selected.
- When the auto surround mode is selected, the surround modes other than the optimum surround mode cannot be selected.

When selecting the REMASTER

- The remastering processes the input digital signal and converts its digital sampling frequency to twice the current frequency (88.2/96 kHz) for a more detailed sound reproduction.
 - OFF : To turn off the remastering function.
 - ON : To process the input digital signal and to convert its sampling frequency to 88.2/96 kHz for a more detailed sound reproduction.

Notes:

- The remastering function have no effect on the input digital signal from the 88.2/96 kHz source or higher as well as the digital signal that is output from the OPTICAL DIGITAL OUT of this receiver.
- When playing an analog input source, the remastering function cannot be activated.

When selecting the AV SYNC

- There may be a slight time delay between the video and audio signals in case that some video playback equipments may process the video signals later than the audio signals due to signal processing procedure, etc.. Should this happen, you can adjust the time delay of audio signals to synchronize the sound with the picture.
- The time delay can be adjusted within the range of 0 ~ 200 msec.

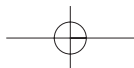

SETTING THE SPEAKER SETUP

- After you have installed this receiver and connected all the components, you should adjust the speaker settings for the optimum sound acoustics according to your environment and speaker layout.
- Even when you change speakers, speaker positions, or the layout of your listening environment, you should adjust the speaker settings, too.
- When performing the AUTO SETUP procedure, you need not perform the SPEAKER CONFIGURATION, SPEAKER DISTANCE, SPEAKER CROSSOVER and CH LEVEL setup procedures.

ENGLISH

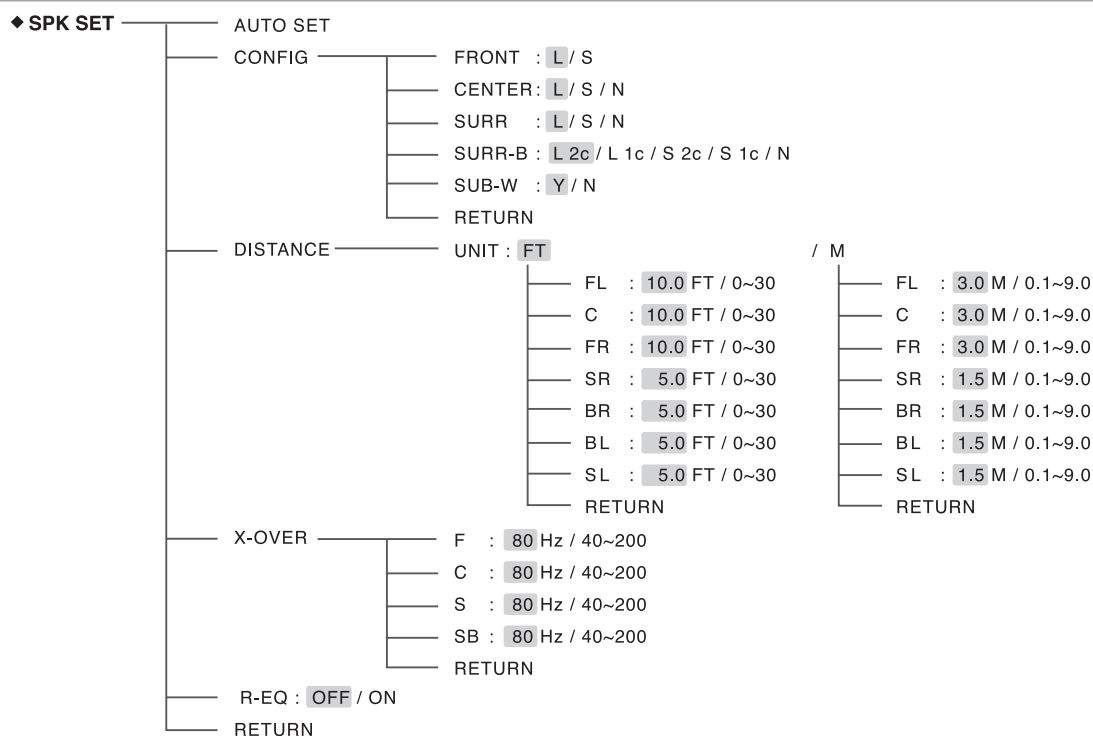

- AUTO SET (AUTO SETUP) : To set the speaker setup and channel level setup automatically.
- CONFIG (SPEAKER CONFIGURATION) : To select the sizes of the speakers that are connected.
- DISTANCE (SPEAKER DISTANCE) : To enter the distance between the listening position and each speaker to set the delay time automatically for optimum surround playback.
- X-OVER (SPEAKER CROSSOVER) : To select the desired crossover frequency.
- R-EQ (ROOM EQ) : To turn on or off the room EQ.
- RETURN : To return to the previous menu.

When selecting the AUTO SETUP

- Auto Setup lets you avoid troublesome listening-based speaker setup and achieve good surround sound. Auto Setup has the feature that provides the optimum listening environment at two main listening positions in your room, where there are often multiple listeners viewing programs together. You should connect the supplied microphone to the SETUP MIC jack so that this receiver can analyze the information from a series of test tones emitted from speakers at two main listening positions and can adjust the size, distance, sound level, crossover frequency and frequency response of each speaker automatically. For optimum effectiveness, move the microphone from first position to second position within the listening area surrounded by the speakers while performing the auto setup.



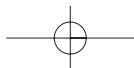

Continued

About the first listening position

The first listening position is the point where a listener sits most often or the listening position when only one person is listening. Measurements start from this point.

- If you want to personalize your speaker setup and channel level setup by making the settings manually, perform "When selecting the SPEAKER CONFIGURATION" on page 44, "When selecting the SPEAKER DISTANCE" on page 45, "When selecting the SPEAKER CROSSOVER" on page 46, "Adjusting each channel level with test tone" on page 23 and "Adjusting the current channel level" on page 24.
- After the auto setup has been completed, set the room EQ mode as desired. (For details, refer to "When selecting the ROOM EQ" on page 47.)

Preparations

Check that the speakers are securely connected to this receiver.

- If your subwoofer has adjustable volume and crossover frequency, set the volume halfway and set the crossover frequency to the maximum or the low pass filter off.

Connect the supplied microphone to the SETUP MIC jack on the front panel. (For details, refer to "SETUP MIC JACK" on page 12.)

Notes :

- Because the microphone for Auto Setup is designed for use with this receiver, to use the auto setup function, do not use a microphone other than the one supplied with this receiver.
- After you have completed the auto setup procedure, disconnect the microphone.

1. Place the microphone on a flat level surface at the first main listening position.

- If possible, use a tripod, etc. to attach the microphone at the same height as your ears would be when you are seated in your listening position.
- Ensure there are no obstacles between the speakers and the microphone.

2. Press the CURSOR UP()/DOWN() buttons to select the "AUTO SET", then press the ENTER button.

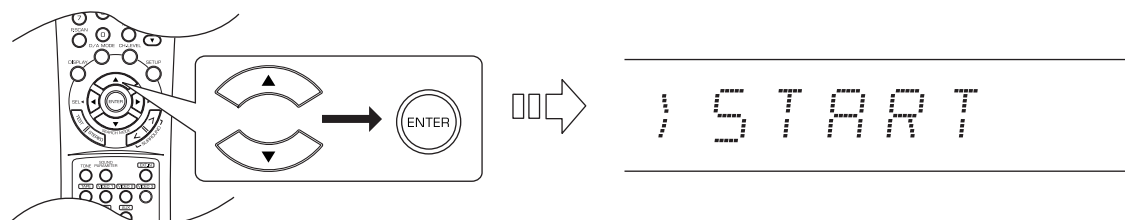

3. Press the CURSOR UP()/DOWN() buttons to select the "START", then press the ENTER button

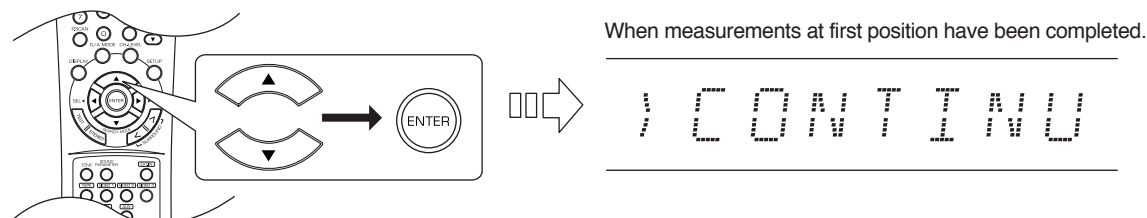

- Each time the CURSOR UP()/DOWN() buttons are pressed, "START" or "RETURN" is selected.
- Loud test tones are output from each speaker and then if measurements at the first position have been completed, "CONTINUE" will be displayed.

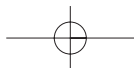

Continued

4. Place the microphone on a flat level at the second main listening position.

- For optimum effectiveness, place the microphone at the second main position within the listening area surrounded by the speakers.

5. Press the CURSOR UP()/DOWN() buttons to select the "CONTINUE", then press the ENTER button.

ENGLISH

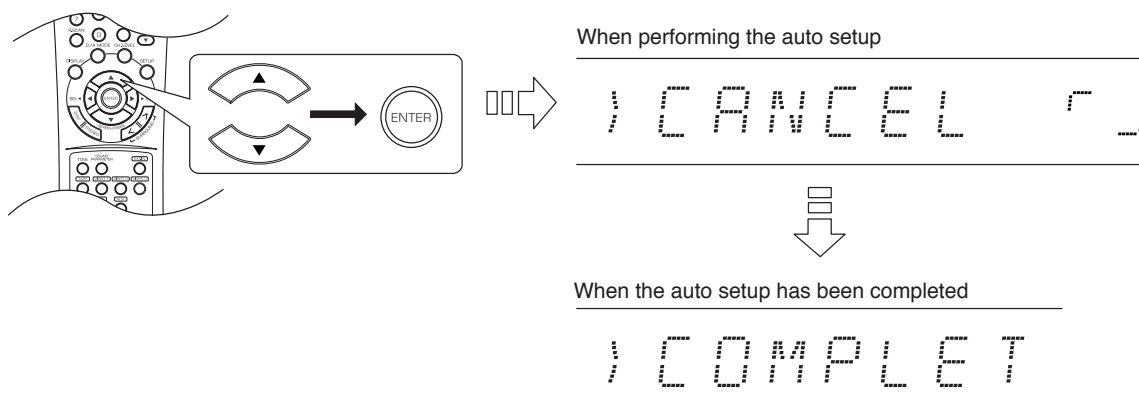

- Loud test tones are output again successively and then if a series of auto setup procedure has been completed, "COMPLETE" will be displayed.
- To stop the auto setup procedure while performing it, (press the CURSOR UP()/DOWN() buttons to select "CANCEL", then) press the ENTER button.
In such a case that the auto setup procedure is stopped before "COMPLETE", the results of each adjustment may not be memorized.
- If there may be a problem with front speakers or microphone connection, "ERROR" will be displayed. In this case, turn off the power, check the connection and then retry the auto setup procedure.

Notes :

- It takes several minutes to complete the auto setup.
- Before starting auto setup, be sure not to set the SPEAKER button to off.
- Because the test tones are loud, ensure there no infants or small children in the room.
- For best results, ensure the room is as quiet as possible during the auto setup procedure.
If there is too much ambient noise, the results may not be satisfactory.

6. To check the results, press the ENTER button.

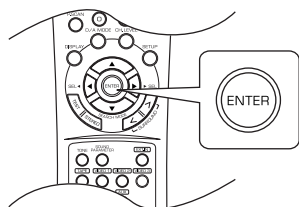

- Then the results are memorized and the previous menu is displayed.
- Check the results on each setup menu(SPEAKER CONFIGURATION menu on page 44, SPEAKER DISTANCE menu on page 45, SPEAKER CROSSOVER menu on page 46 and CH LEVEL menu for "CAL" mode on page 48).
- If the results are not satisfactory, you can retry the auto setup procedure or personalize your speaker setup and channel level setup by making the settings manually. (For details, refer to "When selecting the SPEAKER CONFIGURATION" on page 44, "When selecting the SPEAKER DISTANCE" on page 45, "When selecting the SPEAKER CROSSOVER" on page 46, "Adjusting each channel level with test tone" on page 23 and "Adjusting the current channel level" on page 24.)

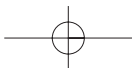

Continued

When selecting the SPEAKER CONFIGURATION

1. Press the CURSOR UP()/DOWN() buttons to select the "CONFIG", then press the ENTER button.

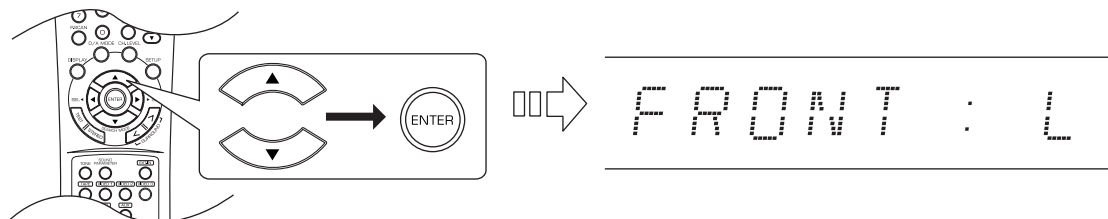

2. Press the CURSOR UP()/DOWN() buttons to select the desired speaker.

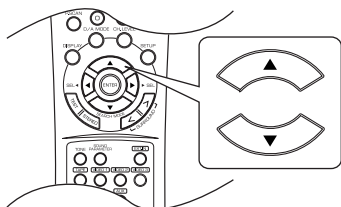

3. Press the CURSOR LEFT()/RIGHT() buttons to set the selected speaker as desired.

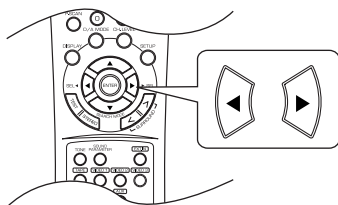

- Depending on your speaker type, you can select one of these following speaker types.
 - L (Large) : Select this when connecting speakers that can fully reproduce sounds below crossover frequency.
 - S (Small) : Select this when connecting speakers that can not fully reproduce sounds below crossover frequency. When this is selected, sounds below crossover frequency are sent to the subwoofer or speakers which are set to "L" (Large) (when not using a subwoofer).
 - N (None) : Select this when no speakers are connected. When this is selected, sounds are sent to the speakers which are not set to "N" (None).
 - 2c (2ch) / 1c (1ch) : Select the desired depending on the number of surround back speakers.
 - Y (Yes) / N (No) : Select the desired depending on whether a subwoofer is connected or not.

Notes :

- When speakers are set to "S" (Small), you should set their crossover frequency correctly according to their frequency characteristics. (For details, refer to "When selecting the SPEAKER CROSSOVER" on page 46.)
- When "SUB-W" (Subwoofer) is set to "N" (No), "FRONT" is automatically set to "L" (Large).
- When the "FRONT" is set to "S" (Small), "CENTER", "SURR" (Surround), "SURR -B" (Surround Back) cannot be set to "L" (Large) and "SUB-W" (Subwoofer) is automatically set to "Y" (Yes).
- When the "SURR" (Surround) is set to "S" (Small), "SURR -B" (Surround Back) cannot be set to "L" (Large).
- When the power amplifier is assigned to "SB+W" (Surround Back+Subwoofer), the "SURR-B" (Surround Back) cannot be set to "2c" (2ch). (For details, refer to "When selecting the AMP ASSIGN" on page 37.)

When setting the speaker size by performing the auto setup.

If the speakers may not be detected properly because of incorrect connection, measurement environment, or other factors, the speakers are set as follows :

- When a pair of speakers such as front, surround or surround back speakers are detected differently (i.e, one is detected as "L" (Large), the other as "S" (Small)), both are automatically set to "S" (Small).
- When only one surround speaker is detected, both are automatically set to "N" (None).
- When only the surround back right speaker is detected, both are automatically set to "N" (None).

In this case, connect that speaker to the SURROUND BACK LEFT speaker terminals and retry the auto setup, then it will be automatically set to "1c" (1ch).

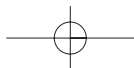

Continued

- Repeat the above steps 2 and 3 until the speakers are all set to the desired mode.

About the speaker size

- Select "L" (Large) or "S" (Small) not according to the actual size of the speaker but according to the speaker's capacity for playing low frequency (bass sound below frequency set on the SPEAKER CROSSOVER menu) signals.
- If you do not know, try comparing the sound at both settings (setting the volume to a level low enough so as not to damage the speakers) to determine the proper setting.
- When setting the speaker size by performing the auto setup, depending on whether the measured crossover frequency of each speaker is lower or higher than 80 Hz, its size is automatically set to "L" (Large) or "S" (Small). (For details, refer to "When selecting the SPEAKER CROSSOVER" on page 46.)

ENGLISH

When selecting the SPEAKER DISTANCE

- Press the CURSOR UP()/DOWN() buttons to select the "DISTANCE", then press the ENTER button.

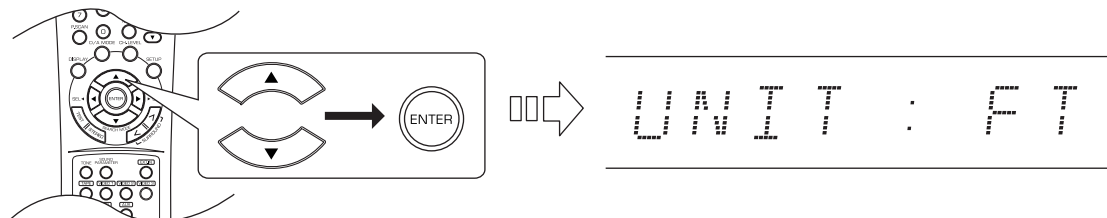

- Press the CURSOR UP()/DOWN() buttons to select the desired item.

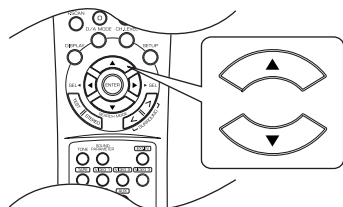

Note :

- You cannot select the subwoofer and the speakers set to "N" (None).

- Press the CURSOR LEFT()/RIGHT() buttons to set the selected item as desired.

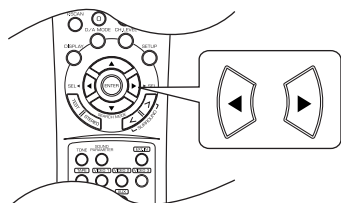

When selecting the desired unit

- You can select either "M" (Meter) or "FT" (Feet).
- Once a unit is selected, the distances are automatically changed in the selected unit.

When setting the distance

- You can set the distance within the range of 0.1 ~ 9.0 meters in 0.1 meter intervals (or 0 ~ 30 feet in 0.5 feet intervals).

- Repeat the above steps 2 and 3 until the distances are all set as desired .

About the speaker distance

When enjoying multi-channel surround playback with Dolby Digital and DTS sources, etc., it is ideal that the center, surround and surround back speakers should be the same distance from the main listening position as the front speakers. By entering the distance between the listening position and each speaker, the delay times of center, surround and surround back speakers are automatically adjusted to create an ideal listening environment virtually as if the center, surround and surround back speakers were at their ideal locations respectively.

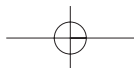

Continued

When selecting the SPEAKER CROSSOVER

- When speakers are set to "S" (Small), be sure to set their crossover frequency correctly according to their frequency characteristics.

1. Press the CURSOR UP()/DOWN() buttons to select the "X-OVER", then press the ENTER button.

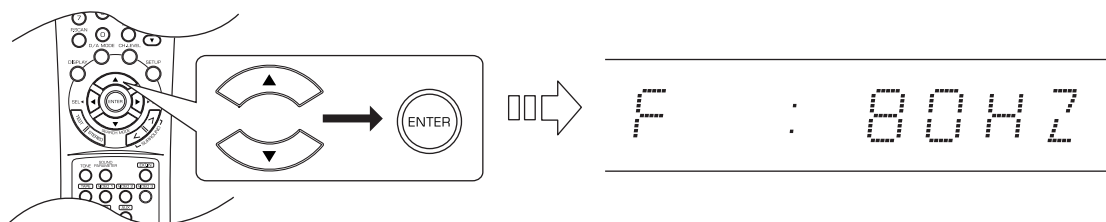

2. Press the CURSOR UP()/DOWN() buttons to select the desired speaker.

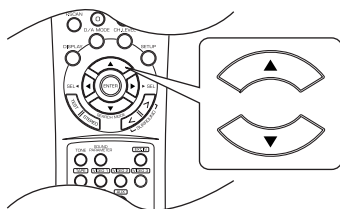

- Each time CURSOR UP()/DOWN() buttons are pressed, "F" (Front), "C" (Center), "S" (Surround) or "SB" (Surround Back) is selected.

Note :

- You cannot select the subwoofer and the speakers set to "N" (None).

3. Press the CURSOR LEFT()/RIGHT() buttons to set the crossover frequency as desired.

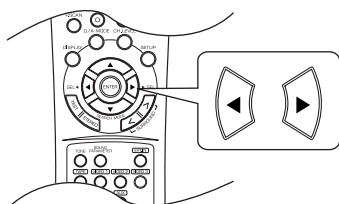

- You can adjust the crossover frequency within the range of 40 ~ 200 Hz in 10 Hz intervals.

4. Repeat the above steps 2 and 3 until the crossover frequencies are all set as desired.

About the crossover frequency

- When speakers are set to "S" (Small), low frequencies in those channels that are below the crossover frequency are to output from subwoofer or front speakers which are set to "L" (Large) (when not using a subwoofer).
- Refer to the operating instructions of the speakers to be connected. If the frequency range of your speaker is 100 Hz~20 kHz, the crossover frequency should be set to 100 Hz(or slightly higher).



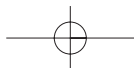

Continued

When selecting the ROOM EQ

- The room EQ is a kind of room equalizer for your speakers. According to the acoustic characteristics of your room measured by the auto setup, the room EQ automatically adjusts the frequency response of speakers.
- If you use different brands or sizes of speakers for some channels or have a room with unique acoustic characteristics, such as walls, furniture, and the dimensions or the shape of the room, we recommend using the room EQ.

Note :

- To use the room EQ, first you should finish measuring the acoustic characteristics of your room performing the auto setup. (For details, refer to "When selecting the AUTO SETUP" on page 41.)

1. Press the CURSOR UP()/DOWN() buttons to select the "R-EQ".

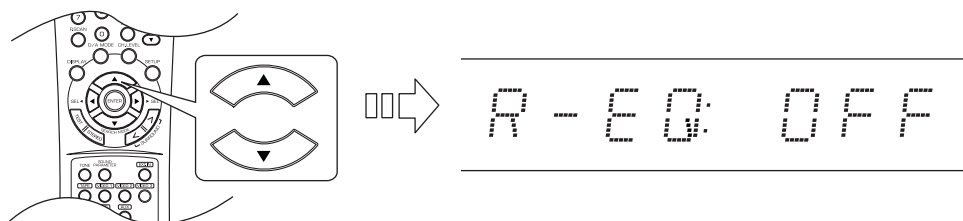

2. Press the CURSOR LEFT()/RIGHT() buttons to select the desired room EQ mode.

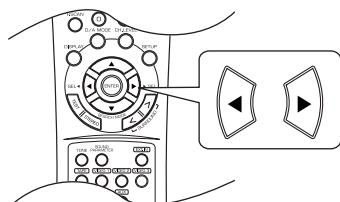

OFF : When turning off the room EQ mode.

ON : When turning it on.



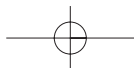

SETTING THE CH LEVEL

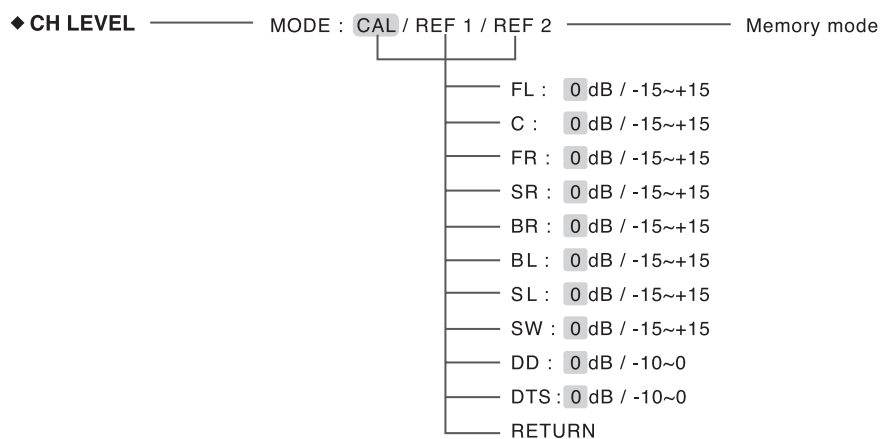

Note :

- Depending on the speaker settings("N" (None or No)), some channels cannot be selected.

Adjusting the current channel level

- You can adjust the current channel levels as desired. These adjusted levels are just memorized into user's memory("CAL"), not into preset memory("REF 1", "REF 2").
- After adjusting each channel level with test tone, adjust the channel levels either according to the program sources or to suit your tastes.(For details, refer to "Adjusting each channel level with test tone" on page 23.)

- Press the CURSOR UP()/DOWN() buttons to select the desired channel.

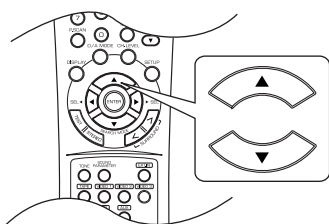

Example) When selecting Dolby Digital source's LFE.

DD: 0dB

- Press the CURSOR LEFT()/RIGHT() buttons to adjust the level of the selected channel or program sources LFE as desired.

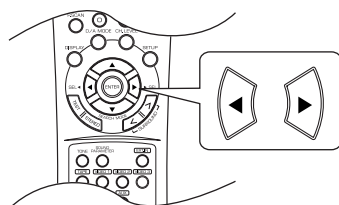

- The LFE level can be adjusted within the range of -10 ~ 0 dB and other channel levels within the range of -15 ~ +15 dB.
- In general, we recommend the LFE level to be adjusted to 0 dB.(However, the recommended LFE level for some early DTS software is -10 dB.) If the recommended levels seem too high, lower setting as necessary.

- Repeat the above steps 1 and 2 to adjust each channel level.

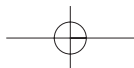

Continued

Memorizing the adjusted channel levels

- You can memorize the adjusted channel levels into preset memory("REF 1", "REF 2") and recall the memorized whenever you want.

- After performing the steps 1~3 in "Adjusting the current channel level" procedure on page 48, press the ENTER button.

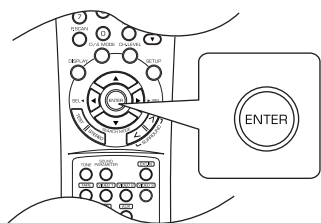

MODE:REF 1

- The "1" of "REF 1" indication flickers.

- Press the CURSOR LEFT()/RIGHT() buttons to select the desired preset memory, then press the ENTER button.

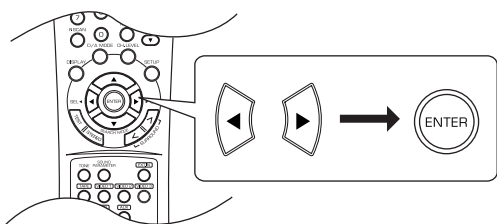

- Each time the CURSOR LEFT()/RIGHT() buttons are pressed, "REF 1" or "REF 2" is selected.
- The adjusted channel levels have now been memorized into the selected memory.

Recalling the memorized channel levels

- Press the CURSOR UP()/DOWN() buttons to select the "MODE~".

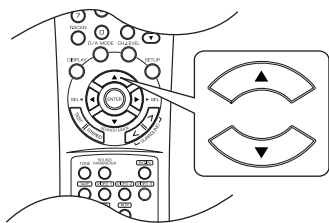

MODE: CAL

- "CAL" may be displayed instead of "REF 1" or "REF 2".

- Press the CURSOR LEFT()/RIGHT() buttons to select the desired one of REF 1 and REF 2.

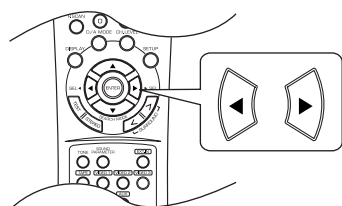

- Then the channel levels memorized into the selected preset memory are recalled.

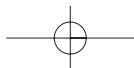

SETTING THE SOUND PARAMETER

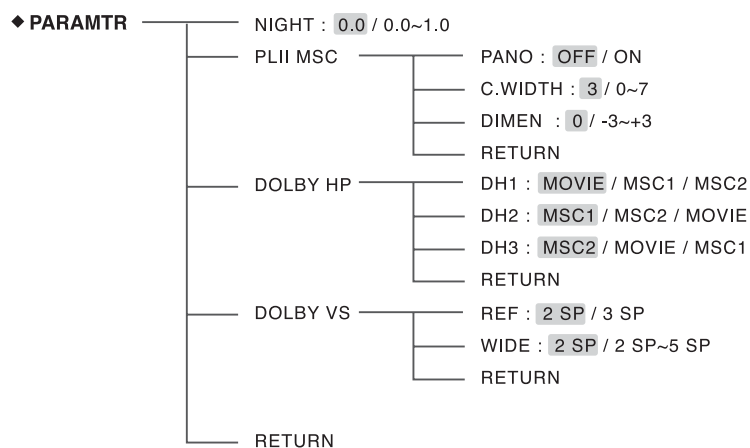

- NIGHT (NIGHT MODE) : To adjust the dynamic range compression that makes faint sound easier to hear at low volume levels.
- PLII MSC (DOLBY PLII MUSIC) : To adjust the various surround parameters for optimum surround effect.
- DOLBY HP (DOLBY HEADPHONE) : To select the desired listening mode for each Dolby Headphone mode.
- DOLBY VS (DOLBY VIRTUAL SPEAKER) : To select the speaker layout to be used actually for each Dolby Virtual Speaker mode.
- RETURN : To return to the previous menu.

When selecting the NIGHT MODE

- This function compresses the dynamic range of previously specified parts of the Dolby Digital or DTS sound track (with extremely high volume) to minimize the difference in volume between the specified and non-specified parts. This makes it easy to hear all of the sound track when watching movies at night at low levels.

Notes:

- The night mode setting is valid only when the digital signals from the Dolby Digital or DTS program source are being input.
- In some Dolby Digital or DTS softwares, the night mode setting may not be valid.

1. Press the CURSOR UP()/DOWN() buttons to select the "NIGHT".

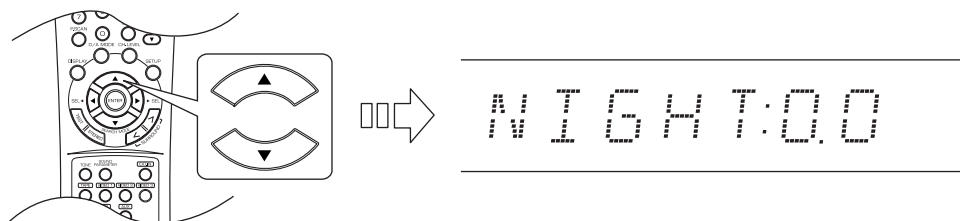

2. Press the CURSOR LEFT() / RIGHT() buttons to adjust the dynamic range compression as desired.

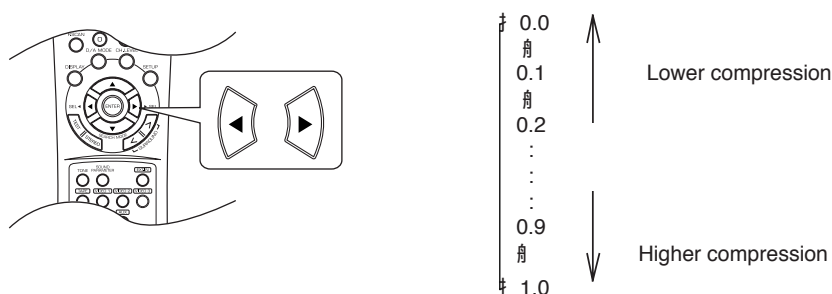

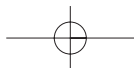

Continued

When selecting the DOLBY PLII MUSIC

• You can adjust the various surround parameters for optimum surround effect.

Note: The parameter settings are valid only when listening in either Dolby Pro Logic II Music mode or the Dolby Pro Logic IIx Music mode.

1. Press the CURSOR UP()/DOWN() buttons to select the “PLII MSC”, then press the ENTER button.

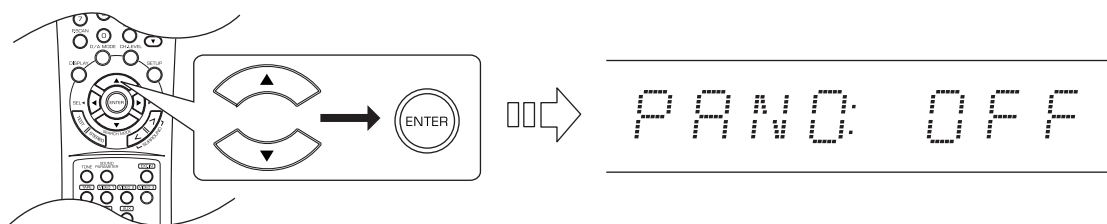

2. Press the CURSOR UP()/DOWN() buttons to select the desired parameter.

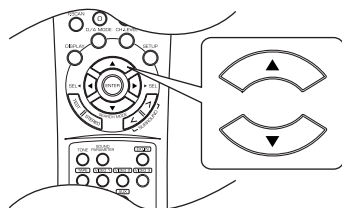

• Each time the CURSOR UP()/DOWN() buttons are pressed, “PANO” (Panorama), “C.WIDTH” (Center width) or “DIMEN” (Dimension) is selected.

3. Press the CURSOR LEFT()/RIGHT() buttons to adjust the selected parameter as desired.

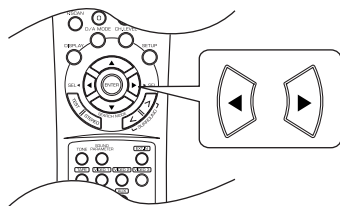

When selecting the “PANO” (Panorama) mode

This mode extends the front stereo image to include the surround speakers for an exciting "wraparound" effect with side wall imaging. Select "OFF" or "ON"(default value:OFF).

When selecting the “C. WIDTH” (Center width) control

This adjusts the center image so it may be heard only from the center speaker, only from the left/right speakers as a phantom image, or from all three front speakers to varying degrees. The control can be set in 8 steps from 0 to 7(default value : 3).

When selecting the “DIMEN” (Dimension) control

This gradually adjusts the soundfield either towards the front or towards the rear. The control can be set in 7 steps from -3 to +3(default value : 0).

4. Repeat the above steps 2 and 3 to adjust other parameters.



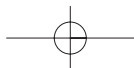

Continued

When selecting the DOLBY HEADPHONE

- You can select the desired listening mode for each Dolby Headphone mode.

Note: The listening mode setting is valid only when playing analog stereo, PCM 2 channel or Dolby Digital 2 channel source in a Dolby Headphone mode.

- Press the CURSOR UP()/DOWN() buttons to select the "DOLBY HP", then press the ENTER button.

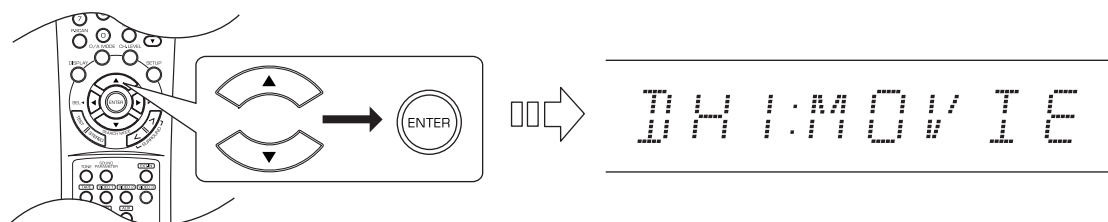

- Press the CURSOR UP()/DOWN() buttons to select the desired Dolby Headphone mode.

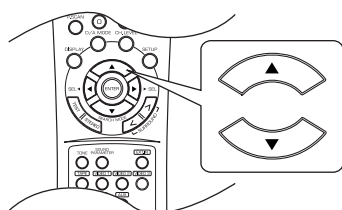

- Each time the CURSOR UP() / DOWN() buttons are pressed, "DH 1" (Dolby Headphone 1), "DH 2" or "DH 3" is selected.

- Press the CURSOR LEFT()/RIGHT() buttons to select the desired listening mode.

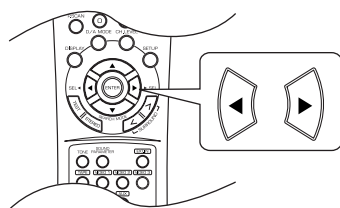

- † MOVIE : This provides the surround effect suitable for movie sources.
- † MSC 1 (MUSIC 1) : This provides the surround effect suitable for music sources.
- † MSC 2 (MUSIC 2) : This provides less surround effect compared to MUSIC 1 mode.

- Repeat the above steps 2 and 3 to select the desired listening modes for other Dolby Headphone modes.

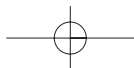

Continued

When selecting the DOLBY VIRTUAL SPEAKER

- You can select the speaker layout to be used actually for each Dolby Virtual Speaker mode.
- Note :** The speaker layout settings are valid only when listening in a Dolby Virtual Speaker mode.

- Press the CURSOR UP()/DOWN() buttons to select the "DOLBY VS", then press the ENTER button.

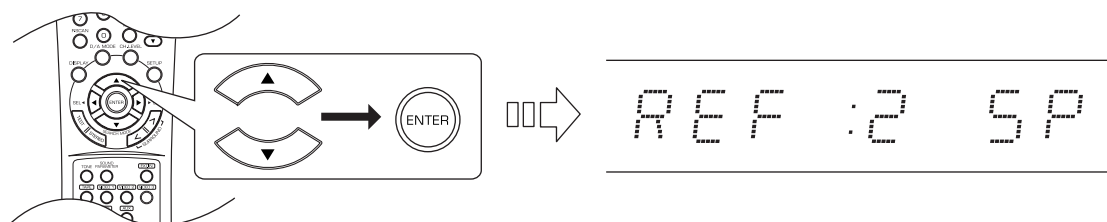

- Press the CURSOR UP()/DOWN() buttons to select the desired Dolby Virtual Speaker mode.

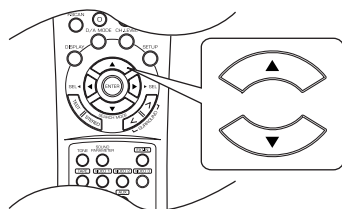

- Each time the CURSOR UP()/DOWN() buttons are pressed, "REF" (Dolby Virtual Speaker Reference) mode or "WIDE" (Dolby Virtual Speaker Wide) mode is selected.

- Press the CURSOR LEFT()/RIGHT() buttons to select the desired speaker layout.

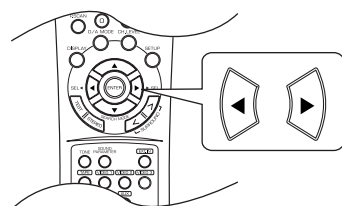

When selecting the "REF" (Dolby Virtual Speaker Reference) mode

2 SP : When using 2 front speakers only.

角

3 SP : When using 2 front and center speakers.

When selecting the "WIDE" (Dolby Virtual Speaker Wide) mode

2 SP : When using 2 front speakers only.

角

3 SP : When using 2 front and center speakers.

角

4 SP : When using 2 front and 2 surround speakers.

角

5 SP : When using 2 front, center and 2 surround speakers.

Note: When the speakers are set to "N" (None), the corresponding speaker layouts cannot be selected.

- Repeat the above steps 2 and 3 to select the desired speaker layout for another Dolby Virtual Speaker mode.

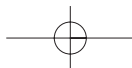

Troubleshooting Guide

If a fault occurs, run through the table below before taking your receiver for repair.

If the fault persists, attempt to solve it by switching the receiver off and on again. If this fails to resolve the situation, consult your dealer. Under no circumstances should you attempt to repair the receiver yourself. This could void the warranty.

PROBLEM	POSSIBLE CAUSE	REMEDY
No power	<ul style="list-style-type: none"> The AC input cord is disconnected. Poor connection at AC wall outlet or the outlet is dead or off. 	<ul style="list-style-type: none"> Connect cord securely. Check the outlet using a lamp or another appliance.
No sound	<ul style="list-style-type: none"> The speaker wires are disconnected. The master volume is adjusted too low. The MUTE button is pressed to ON. Incorrect selection of input source. Incorrect connections between the components. 	<ul style="list-style-type: none"> Check the speaker connections. Adjust the master volume. Press the MUTE button to cancel the muting effect. Select the desired input source correctly. Make connections correctly.
No sound from the surround speakers	<ul style="list-style-type: none"> Surround mode is switched off (stereo mode). Master volume and surround level are too low. Monaural source is used. Surround speaker setting is "N" (None). 	<ul style="list-style-type: none"> Select a surround mode. Adjust master volume and surround level. Select a stereo or surround source. Select the desired surround speaker setting.
No sound from the center speaker	<ul style="list-style-type: none"> Dolby Virtual Speaker, stereo mode, etc is selected. Center speaker setting is "N" (None). Master volume and center level are too low. 	<ul style="list-style-type: none"> Select the desired surround mode. Select the desired center speaker setting. Adjust master volume and center level.
No sound from the surround back speakers	<ul style="list-style-type: none"> The input signal format or the current surround mode cannot support the 7.1 (or 6.1) surround. Master volume and surround back level are too low. Surround back speaker setting is "N" (None). 	<ul style="list-style-type: none"> Under the proper situations, perform the 7.1 (or 6.1) surround playback. (For details, refer to "ENJOYING SURROUND SOUND" on page 20.) Adjust master volume and surround back level. Select the desired surround back speaker setting.
Stations cannot be received	<ul style="list-style-type: none"> No antenna is connected. The desired station frequency is not tuned in. Antenna is in wrong position. 	<ul style="list-style-type: none"> Connect an antenna. Tune in the desired station frequency. Move antenna and retry tuning.
Preset stations cannot be received	<ul style="list-style-type: none"> An incorrect station frequency has been memorized. The memorized stations are cleared. 	<ul style="list-style-type: none"> Memorize the correct station frequency. Memorize the stations again.
Poor FM reception	<ul style="list-style-type: none"> No antenna is connected. The antenna is not positioned for the best reception. 	<ul style="list-style-type: none"> Connect an antenna. Change the position of the antenna.
Continuous hissing noise during FM reception, especially when a stereo broadcast is received.	<ul style="list-style-type: none"> Weak signals. 	<ul style="list-style-type: none"> Change the position of the antenna. Install an outdoor FM antenna.
Continuous or intermittent hissing noise during AM reception, especially at night.	<ul style="list-style-type: none"> Noise is caused by motors, fluorescent lamps or lightning, etc. 	<ul style="list-style-type: none"> Keep the receiver away from noise sources. Install an outdoor AM antenna.
Remote control unit does not operate.	<ul style="list-style-type: none"> Batteries are not loaded or exhausted. The remote sensor is obstructed. 	<ul style="list-style-type: none"> Replace the batteries. Remove the obstacle.

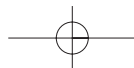

Specifications

ENGLISH

AMPLIFIER SECTION

- Power output, stereo mode, 6 Ω , THD 0.2 %, 40 Hz~20 kHz | **2 x 100 W**
- Total harmonic distortion, 6 Ω , 95 W, 1 kHz | **0.05 %**
- Intermodulation distortion
60 Hz : 7 kHz= 4 : 1 SMPTE, 6 Ω , 95 W | **0.1 %**
- Input sensitivity/impedance
Line (CD, TAPE, VIDEO) | **300 mV/47k Ω**
- Signal to noise ratio, IHF "A" weighted
Line (CD, TAPE, VIDEO) | **100 dB**
- Frequency response
Line (CD, TAPE, VIDEO), 10 Hz~100 kHz | **+0, -3 dB**
- Output level
TAPE OUT, 2.2 k Ω | **300 mV**
- Bass/Treble control, 100 Hz/10 kHz | **± 10 dB**
- Surround mode, only channel driven
Front power output, 6 Ω , 1 kHz, THD 0.7 % | **110 W / 110 W**
Center power output, 6 Ω , 1 kHz, THD 0.7 % | **110 W**
Surround power output, 6 Ω , 1 kHz, THD 0.7 % | **110 W / 110 W**
Surround back power output, 6 Ω , 1 kHz, THD 0.7 % | **110 W / 110 W**

DIGITAL AUDIO SECTION

- Sampling frequency | **32, 44.1, 48, 96 kHz**
- Digital input level
Coaxial, 75 Ω | **0.5 Vp-p**
Optical, 660 nm | **-15~-21 dBm**

VIDEO SECTION

- Video format | **NTSC**
- Input sensitivity(=Output level), 75 Ω
Video (Composite(normal)) | **1 Vp-p**
S-Video (luminance signal) | **1 Vp-p**
(chrominance signal) | **0.286 Vp-p**
Component video (R-Y signal) | **0.5 Vp-p**
(B-Y signal) | **0.5 Vp-p**
(Y signal) | **1.0 Vp-p**
- HDMI connector | **19 pin**

FM TUNER SECTION

- Tuning frequency range | **87.5~108 MHz**
- Usable sensitivity, THD 3%, S/N 30 dB | **12 dBf**
- 50 dB quieting sensitivity, mono/stereo | **20.2 / 45.3 dBf**
- Signal to noise ratio, 65 dBf, mono/stereo | **60 / 55 dB**
- Total harmonic distortion, 65 dBf, 1 kHz, mono/stereo | **0.5 / 0.8 %**
- Frequency response, 30 Hz~15 kHz | **± 3 dB**
- Stereo separation, 1 kHz | **32 dB**
- Capture ratio | **4.0 dB**
- IF rejection ratio | **75 dB**

AM TUNER SECTION

- Tuning frequency range | **520~1710 kHz**
- Usable sensitivity | **500 μ V/m**
- Signal to noise ratio | **40 dB**
- Selectivity | **25 dB**

GENERAL

- Power supply | **120 V ~ 60 Hz**
- Power consumption | **3.8 A**
- Switched AC outlets | **TOTAL 120 W (1 A) max.**
- Dimensions (W x H x D, including protruding parts) | **440 x 141 x 370 mm(17-3/8 x 5-1/2 x 14-1/2 inches)**
- Weight (Net) | **10.1 kg (22.3 lbs)**

Note: Design and specifications are subject to change without notice for improvements.

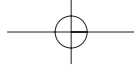

R-672

Audio/Video Receiver



5707-00000-052-0S



Free Manuals Download Website

<http://myh66.com>

<http://usermanuals.us>

<http://www.somanuals.com>

<http://www.4manuals.cc>

<http://www.manual-lib.com>

<http://www.404manual.com>

<http://www.luxmanual.com>

<http://aubethermostatmanual.com>

Golf course search by state

<http://golfingnear.com>

Email search by domain

<http://emailbydomain.com>

Auto manuals search

<http://auto.somanuals.com>

TV manuals search

<http://tv.somanuals.com>