

Smart choice for power

xantrex



ICA

Owner's Manual

Inverter Communications Adapter (ICA)

www.xantrex.com

Inverter Communications Adapter

Owner's Manual

About Xantrex

Xantrex Technology Inc. is a world-leading supplier of advanced power electronics and controls with products from 50 watt mobile units to one MW utility-scale systems for wind, solar, batteries, fuel cells, microturbines, and backup power applications in both grid-connected and stand-alone systems. Xantrex products include inverters, battery chargers, programmable power supplies, and variable speed drives that convert, supply, control, clean, and distribute electrical power.

Trademarks

Inverter Communications Adapter is a trademark of Xantrex International. Xantrex is a registered trademark of Xantrex International.

Other trademarks, registered trademarks, and product names are the property of their respective owners and are used herein for identification purposes only.

Notice of Copyright

Inverter Communications Adapter (ICA) Owner's Manual © June 2005 Xantrex International. All rights reserved.

Disclaimer

UNLESS SPECIFICALLY AGREED TO IN WRITING, XANTREX TECHNOLOGY INC. ("XANTREX")

- (a) MAKES NO WARRANTY AS TO THE ACCURACY, SUFFICIENCY OR SUITABILITY OF ANY TECHNICAL OR OTHER INFORMATION PROVIDED IN ITS MANUALS OR OTHER DOCUMENTATION.
- (b) ASSUMES NO RESPONSIBILITY OR LIABILITY FOR LOSS OR DAMAGE, WHETHER DIRECT, INDIRECT, CONSEQUENTIAL OR INCIDENTAL, WHICH MIGHT ARISE OUT OF THE USE OF SUCH INFORMATION. THE USE OF ANY SUCH INFORMATION WILL BE ENTIRELY AT THE USER'S RISK.

Date and Revision

June 2005 Revision A

Part Number

975-0052-01-01 Rev A

Contact Information

Telephone: 1 800 670 0707 (toll free North America)
1 360 925 5097 (direct)

Fax: 1 360 925 5143 (direct)

Email: customerservice@xantrex.com

Web: www.xantrex.com

About This Manual

Purpose

The purpose of this Owner's Manual is to provide explanations and procedures for installing, operating, maintaining, and troubleshooting the Inverter Communications Adapter (ICA).

Scope

The Sine Wave Plus Inverter Communications Adapter (ICA) Owner's Manual provides safety guidelines, planning and setup information, procedures for installing the ICA and its software (ICAP), as well as information about operating and troubleshooting the unit.

Audience

This Manual is intended for anyone who has a Sine Wave Plus Inverter/Charger and needs to install and operate the Inverter Communications Adapter (ICA) and its software.

Organization

This Manual is organized into three chapters.

Chapter 1, "Installation" describes how to install the ICA cable with or without a modem. The following topics are covered in this chapter.

Chapter 2, "Configuration" describes how to install the ICAP software provided with the ICA and how to set up a modem (if used).

Chapter 3, "Operation" describes how to operate the ICAP software, change the ICAP settings, test, and troubleshoot the connection.

Warranty and product information is provided at the end of the Guide.

Conventions Used

The following conventions are used in this guide.



WARNING

Warnings identify conditions that could result in personal injury or loss of life.



CAUTION

Cautions identify conditions or practices that could result in damage to the unit or to other equipment.

Important: These notes describe an important action item or an item that you must pay attention to.

Illustrations

Since software levels can change frequently to incorporate upgrades and improvements, it is recommended that you visit www.xantrex.com for the latest version of this software.

Therefore, please keep in mind that software levels shown in the illustrations within this manual may not represent the most current version.

Abbreviations and Acronyms

AC	Alternating Current
ASC	Authorized Service Center
AHJ	Authority Having Jurisdiction
COM	COMmunications Port
DC	Direct Current
DOS	Disk Operating System
ICA	Inverter Communications Adapter
ICAP	Inverter Communications Adapter Program (software)
ICM	Inverter Control Module
ID	IDentification
LCD	Liquid Crystal Display
LED	Light Emitting Diode
PC	Personal Computer
PV	Photovoltaic
PVGFP	PV Ground Fault Protection
RMA	Return Material Authorization

Related Information

You can find more information about Xantrex Technology Inc. as well as its products and services at **www.xantrex.com**.

Important Safety Instructions



WARNING

This chapter contains important safety and operating instructions as prescribed by UL and CSA standards for the Sine Wave Plus Inverter Communications Adapters (ICA) used in residential, RV, and marine applications. Read and keep this Owner's Manual for future reference.

1. Before installing the ICA, read all instructions and cautionary markings on the ICA, the inverter, the batteries, and all appropriate sections of this guide.
2. Do not expose the ICA to rain, snow, or spray.
3. Use only attachments recommended or sold by the manufacturer. Doing otherwise may result in a risk of fire, electric shock, or injury to persons.
4. Do not install the ICA if it has been damaged in any way. If the unit is damaged, see the Warranty section at the end of this guide.
5. Do not disassemble the ICA. See "How do you get service?" on page 45 for instructions on obtaining service. Attempting to service the unit yourself may result in a risk of electrical shock or fire.
6. To reduce the risk of electrical shock, disconnect both AC and DC power from the inverter before attempting any maintenance or cleaning or working on any circuits associated with the ICA.

Contents

Important Safety Instructions -----	vii
--	-----

1 Installation

Introduction-----	2
Features/Components-----	2
Connecting the ICA Cable-----	4
Connecting the ICA to a Computer using a Modem-----	6
Connecting Multiple ICAs to a Single Computer-----	8
Positive Ground or PV Ground Fault Protection Installations	10
Additional Possible Requirements-----	12
Advanced Monitoring Software-----	12

2 Configuration

Installing the ICA Software: ICAP-----	14
Starting the Setup Program Using Autorun-----	14
Starting Setup Manually-----	19
Starting Setup From a Command Prompt-----	20
Setting Up a Modem Connection-----	21
Make a New Connection-----	21
Establish the Type of Connection-----	22
Enter COM Port Property Values-----	23

3 Operation

Starting ICAP-----	26
User Interface Features-----	27
ICAP Menu Bar-----	28
Exit-----	28
Go Past END MENU-----	29
ICA Commands-----	29
Communications-----	30

Contents

Help - - - - -	30
LEDs and LCD Display - - - - -	30
Multiple-Unit Drop-Down Box - - - - -	30
Navigation Buttons - - - - -	31
ICAP Keyboard and Terminal Emulation Keyboard Shortcut	
Commands - - - - -	31
Changing ICAP Settings - - - - -	34
Identifying Single or Multiple ICAs - - - - -	35
Assigning ID Numbers to the ICA - - - - -	36
Assigning Customer IDs (Optional) - - - - -	36
Reset to Defaults - - - - -	36
Advanced Configuration Settings - - - - -	38
Changing the PC's COM Port Number - - - - -	39
Testing the ICA - - - - -	40
Troubleshooting the ICA - - - - -	40
Troubleshooting if No Response comes from the ICA - - - -	41
Check ID - - - - -	41
Reset Defaults - - - - -	41
Check Settings - - - - -	41
Reset Program - - - - -	42
Phone Connections - - - - -	42
Hardware Connectors - - - - -	42
Check Configuration - - - - -	43
Display Anomaly - - - - -	43
Warranty and Return Information - - - - -	45
Index - - - - -	51

Figures

Figure 1-1	Inverter Communications Adapter (ICA) -----	3
Figure 1-2	Connecting Directly to the Inverter -----	5
Figure 1-3	Connecting the ICA to a Computer using a Modem ---	7
Figure 1-4	Connecting Multiple ICAs -----	9
Figure 1-5	Enlargements of pin assignments and color coding on ICA cable and connectors 11	
Figure 2-1	ICAP Welcome Screen -----	14
Figure 2-2	ICAP License Agreement Screen-----	15
Figure 2-3	ICAP Important Information Screen-----	15
Figure 2-4	ICAP Install Folder Screen-----	16
Figure 2-5	ICAP Shortcut Folder Screen -----	16
Figure 2-6	Ready to Install Screen -----	17
Figure 2-7	Installing Files Screen -----	17
Figure 2-8	Installed Screen -----	18
Figure 2-9	Readme Option Screen -----	18
Figure 2-10	Run Window -----	20
Figure 2-11	Making a New Connection-----	21
Figure 2-12	Phone Number Dialog-----	22
Figure 2-13	COM Port Properties Dialog-----	23
Figure 3-1	ICAP Splash Screen -----	26
Figure 3-2	ICAP User Interface Window -----	27
Figure 3-3	Identifying the Number of ICAs attached -----	35
Figure 3-4	Assigning ID Numbers to the ICA-----	37
Figure 3-5	Changing the Advanced Configuration Settings-----	38
Figure 3-6	Changing the PC's COM Port Number-----	39
Figure 3-7	Screen Display Startup Anomaly #1-----	43
Figure 3-8	Screen Display Startup Anomaly #2-----	44

Tables

Table 3-1	Keyboard Commands -----	32
Table 3-2	Keyboard Commands (ICAP Only) -----	32
Table 3-3	Keyboard Commands (Terminal Emulation Programs Only) -----	33
Table 3-4	Troubleshooting the ICA -----	40

1 Installation

Chapter 1, “Installation” describes how to install the ICA cable with or without a modem. The following topics are covered in this chapter.

For this topic...	See...
“Introduction”	page 2
“Features/Components”	page 2
“Connecting the ICA Cable”	page 4
“Connecting the ICA to a Computer using a Modem”	page 6
“Connecting Multiple ICAs to a Single Computer”	page 8
“Positive Ground or PV Ground Fault Protection Installations”	page 10
“Additional Possible Requirements”	page 12
“Advanced Monitoring Software”	page 12

Introduction

The Inverter Communications Adapter (ICA) allows any Sine Wave Plus Inverter/Charger to be connected to a computer serial port or directly to a modem to be controlled and monitored over long distances. It uses the Inverter Communications Adapter Program (ICAP) to communicate with the inverters and emulates the inverter control module on the inverter. Virtually everything that can be done with the inverter's control module can be emulated by ICAP. The ICAP can also be used to monitor up to eight inverters within the same system.

Features/Components

The ICA package includes the following items. See Figure 1-1 on page 3.

- ICA adapter: gray plastic housing with green LED, phone (RJ11) jack and a 25-pin RS232 connector
- Serial Port Adapter: black plastic housing with RJ11 jack and 9-pin connector. This part is custom-made. It is not intended for use as a standard RJ11 to DB-9 adapter.
- 25-foot, 4-conductor phone cable, with RJ11 jacks on each end (Telephone Standard)
- CD with the Windows™ based software program, ICAP.exe, creating a simulation of the Sine Wave Plus Inverter/Charger control panel
- This Inverter Communications Adapter (ICA) Owner's Manual

Please be sure all of these parts are included before trying to use the ICA.

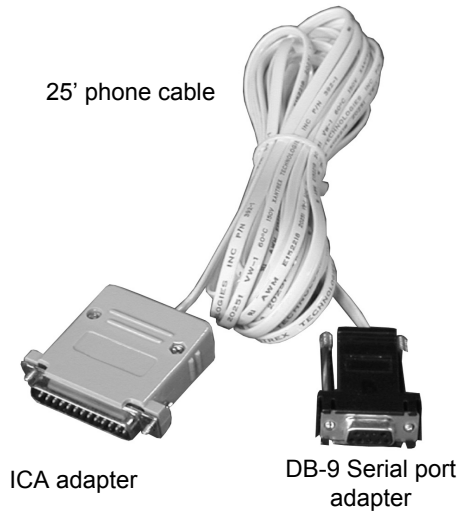

Figure 1-1 Inverter Communications Adapter (ICA)

Connecting the ICA Cable

The ICA converts the REMOTE port on the Sine Wave Plus Inverter/Charger into a standard RS232 type communications port interface.

See Figure 1-2 for the location of the Remote Port on the Sine Wave Plus Inverter/Charger.

Important: There are two ports located on the inverter – one is used for the stacking cable and the other is for the remote control port. Make sure you connect the ICA to the correct port. If a Remote Inverter Control Module (ICM-Remote) is being used, it will have to be disconnected while the ICA is in use.

To install the ICA:

1. Connect the ICA adapter to the Sine Wave Plus Inverter/Charger remote port located on the left end of the inverter, near the AC wiring compartment (Figure 1-2).
2. Connect the phone cable to the RJ11 jack on the gray ICA adapter and to the black serial port adapter.
3. Plug the serial port adapter into the computer's serial port (Figure 1-2).
4. Check that the LED has illuminated to indicate that it can communicate with the inverter.

Important: On some computers, a DB9-to-25-pin adapter may be needed to allow connection.

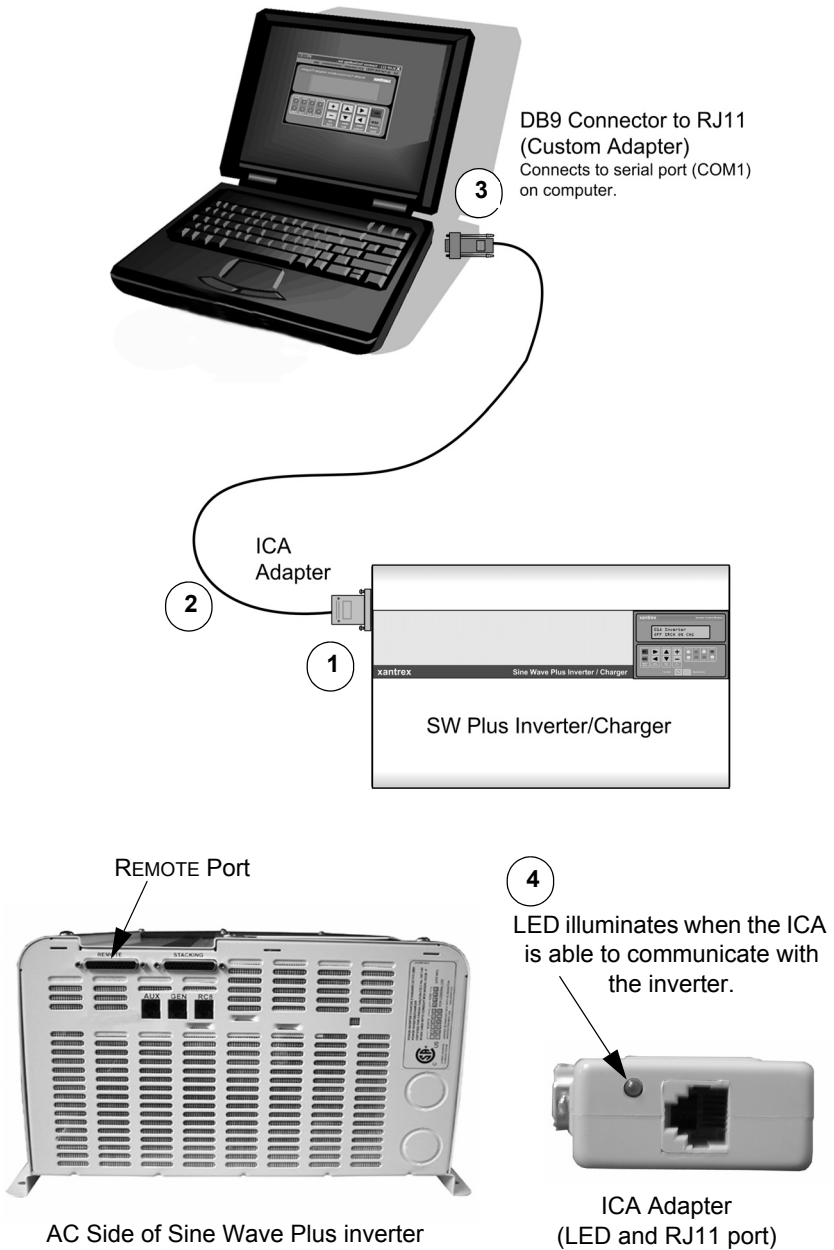

Figure 1-2 Connecting Directly to the Inverter

Connecting the ICA to a Computer using a Modem

The ICA can be connected directly to a modem for use in remote sites where a computer may not be available or desired. Any computer that has an available serial communications port and terminal emulation software can communicate with the SW Plus series inverter through a cable or modem connection.

To use a modem, the following is required:

- a terminal emulation program (see “Setting Up a Modem Connection” on page 21)
- a modem capable of auto answer, which must be set at a 9600/N81 BAUD connection

Important: Some modems automatically adjust to the highest transmission speed. The ICA communicates at 9600 BAUD only and the modem must be able to stay at this setting.

- an adapter for the DB9 connection from the phone cable to serial port adapter.
- A NULL MODEM adapter will be required for most applications. Contact the modem provider and modem documentation for more information.
- The program also assumes that the ICA is connected to a serial port with a COM number of 1. If you are using a COM port other than 1, refer to “Enter COM Port Property Values” on page 23.

To connect a modem to an inverter:

1. Install the cables as illustrated in Figure 1-3.
2. Load the ICAP software on the computer. (page 14).
3. Set up your terminal emulation program. (page 21).
4. Configure the ICAP software if necessary. (page 34).

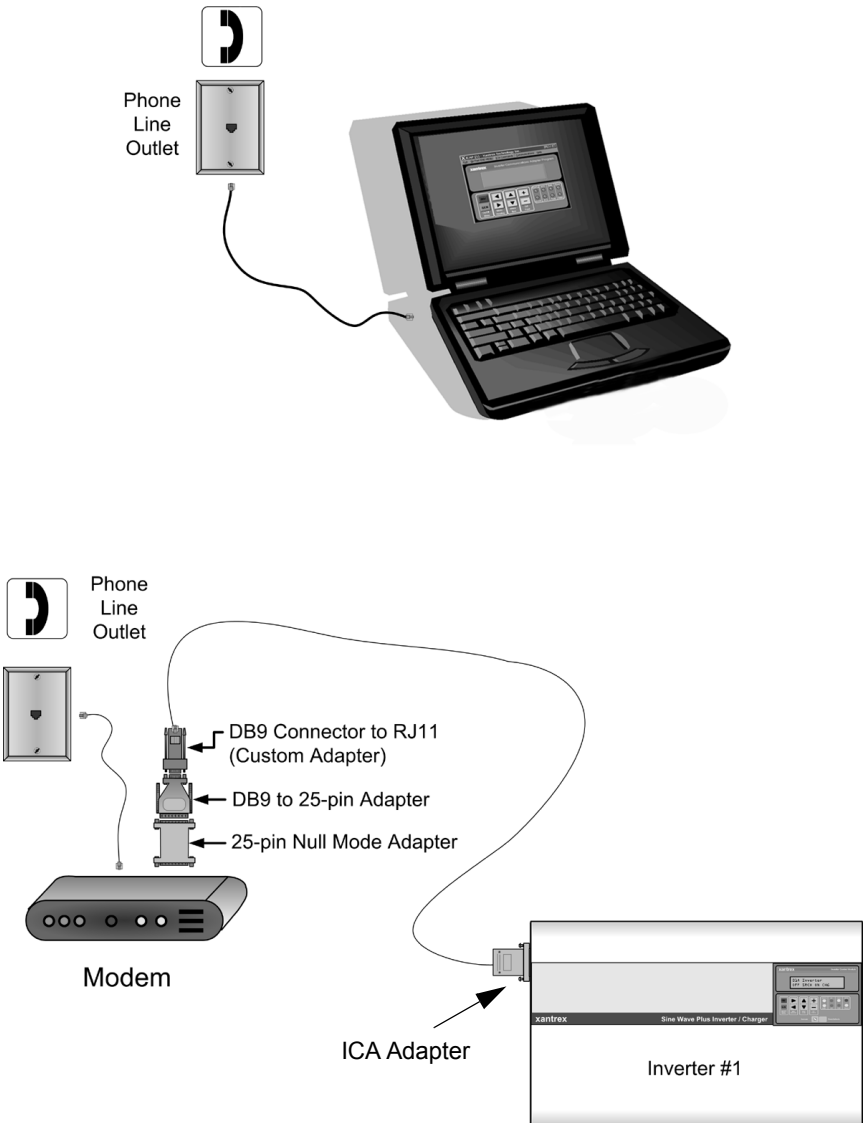

Figure 1-3 Connecting the ICA to a Computer using a Modem

Connecting Multiple ICAs to a Single Computer

Up to eight ICAs can be used with a single computer serial port. The four phone cable conductors are simply run in parallel using standard phone cable line “splitters”.

To connect multiple adapters to a single serial port:

1. Connect each ICA adapter individually to the computer (or modem) to ensure it operates properly. Once functionality has been confirmed on each inverter, disconnect the ICAs.
2. Assign the ID number for each ICA adapter following the instructions in “Assigning ID Numbers to the ICA” on page 36. The ID number can only be changed with a single adapter connected to the computer’s serial port.
3. Write each new ID number on the outside of the ICA’s gray housing to make later identification of the adapter easier.
4. Use a standard phone cable line splitter to connect each individual ICA to a single serial port adapter. Ensure that wires of the same color in each RJ11 connector are connected together—do not switch the colors around.

See Figure 1-5 for details on the phone line connections.

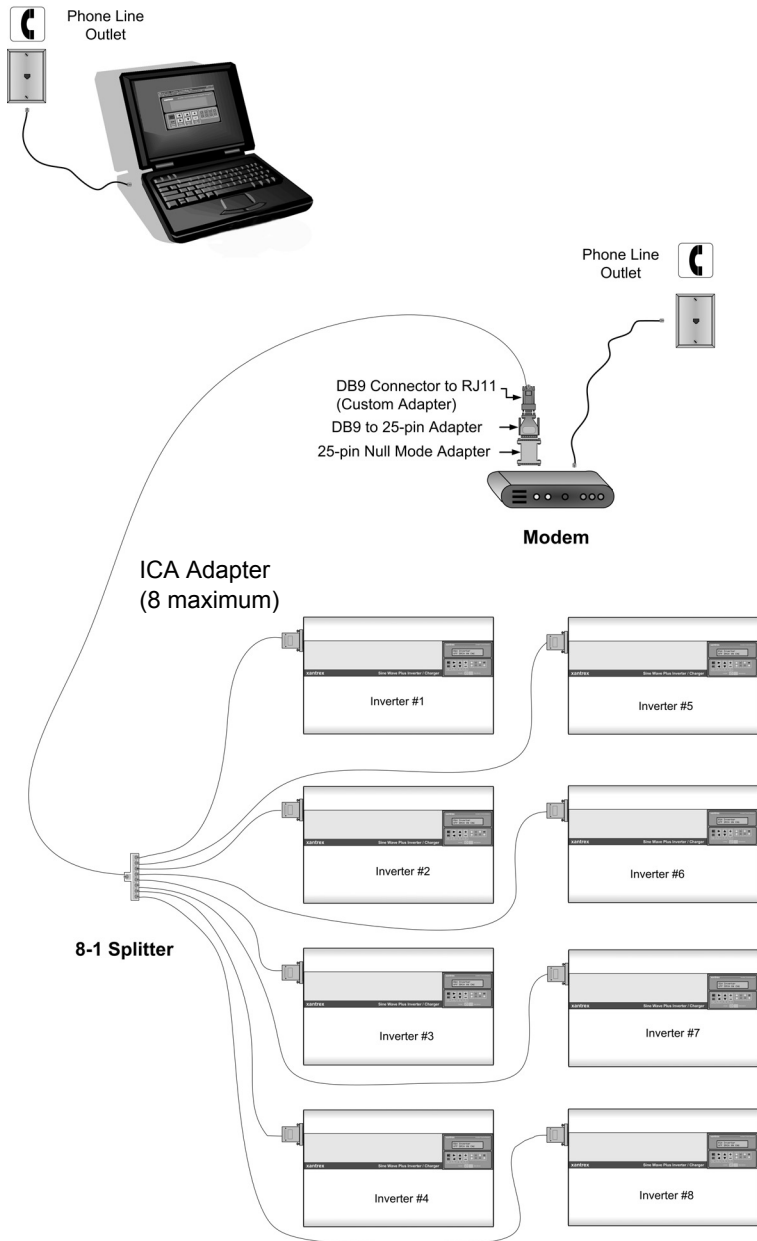

Figure 1-4 Connecting Multiple ICAs

Positive Ground or PV Ground Fault Protection Installations

When using the ICA in inverter installations that have DC ground fault protection (PVGFP-CF) or where the inverter is connected in a “positive ground” configuration, an opto-isolator must be connected somewhere between the ICA and the computer com port. Opto-isolators can be obtained through www.blackbox.com (part SP400A-R3 and PS576 - 9 Vdc power supply).



CAUTION: Equipment Damage

Damage to the inverter and ICA can occur if an opto-isolator is not used in a “positive ground” configuration or in installations that have DC ground fault protection.

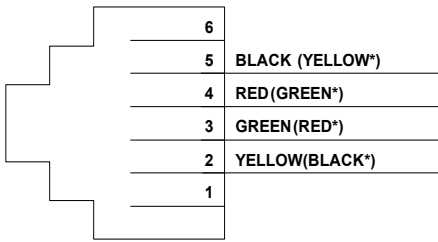

RJ 11 connector on
ICA Serial Port Adapter

*Depending on the Cable Installation

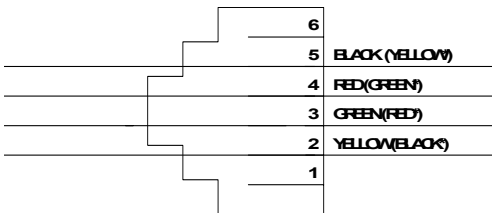

RJ 11 connector on 25-foot
(4-conductor, telephone
standard) cable

*Depending on the Cable Installation

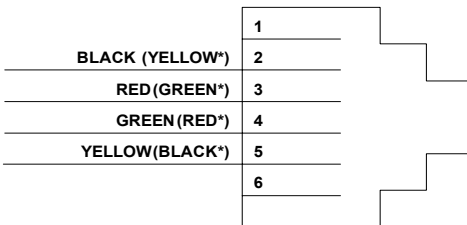

RJ 11 connector on
ICA Adapter

*Depending on the Cable Installation

Figure 1-5 Enlargements of pin assignments and color coding on ICA cable and connectors

Additional Possible Requirements

The modem at the inverter location may need to be DC powered if it is necessary to connect to the inverter during a fault condition where the inverter has shut off its AC output.

Advanced Monitoring Software

The ICA was developed to change the Sine Wave Plus Inverter/Charger raw data output to an RS232 protocol output. The ICA code only manipulates the inverter's control panel keypad strokes. The included software emulates these keystrokes.

There are companies that have used these keystroke bits of information (coming from the ICA) to develop advanced monitoring software that provides monitoring and data logging capability. Additional information on these programs can be found at www.righthandeng.com or www.mauisolarsoftware.com.

Important: Xantrex Technology Inc. assumes no responsibility for the use or function of these advanced monitoring software programs.

2 Configuration

Chapter 2, “Configuration” describes how to install the ICAP software provided with the ICA and how to set up a modem (if used).

The following topics are covered in this chapter.

For this topic...	See...
“Installing the ICA Software: ICAP”	page 14
“To install the software with Autorun enabled on your CDROM drive:”	page 14
“To start the program from the CD if Autorun is disabled on your computer:”	page 19
“To start the program from a command prompt:”	page 20
“Setting Up a Modem Connection”	page 21

Installing the ICA Software: ICAP

The Inverter Communications Adapter software program (ICAP) is included on the CD in the ICA package. It allows a personal computer to operate as a virtual control panel for up to eight Sine Wave Plus Inverter/Chargers.

For other computer platforms, See “Setting Up a Modem Connection” on page 21.

Select one of the following methods to install the software:

- Use Autorun (must be enabled on your CDROM drive).
- Manual Start (assumes that Autorun is not enabled on your CDROM drive).
- Use a Command prompt to initiate the installation program.

Important: Software levels shown in these illustrations may not represent the most current version.

Starting the Setup Program Using Autorun

To install the software with Autorun enabled on your CDROM drive:

1. Insert the CD into your computer’s CDROM drive. If autorun has not been disabled for the CDROM in your computer, the *Welcome* screen shown in Figure 2-1 will appear.

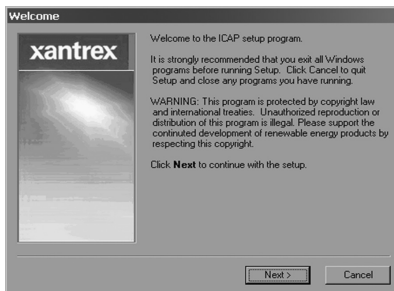

Figure 2-1 ICAP Welcome Screen

2. Click on the **NEXT** button to start the setup program. The *License Agreement* screen should appear next.
3. Click on the **ACCEPT** button to accept the License Agreement and continue with the installation. The *Important Information* screen will appear next.



Figure 2-2 ICAP License Agreement Screen

4. Review the list of required components and ensure your system meets all the requirements. If you do not have the required components in place, click on the **CANCEL** button. This will terminate the installation program. If you do have all the components required for this installation, then click on the **NEXT** button to continue with the installation.

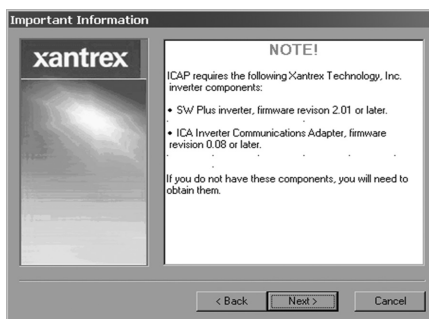

Figure 2-3 ICAP Important Information Screen

5. The ICAP installation folder will default to the location shown in Figure 2-4. If you do not want the software installed at the default location, enter the desired location in the window below “Install files to this location” or use the BROWSE button to navigate to the desired location.
6. Click on the **NEXT** button to continue with the installation. The *Shortcut Folder* screen will appear next. The shortcut folder is where you will find the shortcut to start the program within the “START/Programs” menu.



Figure 2-4 ICAP Install Folder Screen

7. If the location of the *Shortcut Folder* is acceptable, click on the **NEXT** button to continue with the installation. If you want to change the location of the shortcut folder, enter a different name for the folder in the window below the line “Shortcut Folder”, then click on the **NEXT** button.



Figure 2-5 ICAP Shortcut Folder Screen

- The *Ready To Install* screen should appear next. If you want to have a shortcut put on your desktop, click in the small box next to the question “Do you want a shortcut on your desktop?” A small check mark should appear in the box. If you do not want a shortcut placed on your desktop, be sure this box is empty.

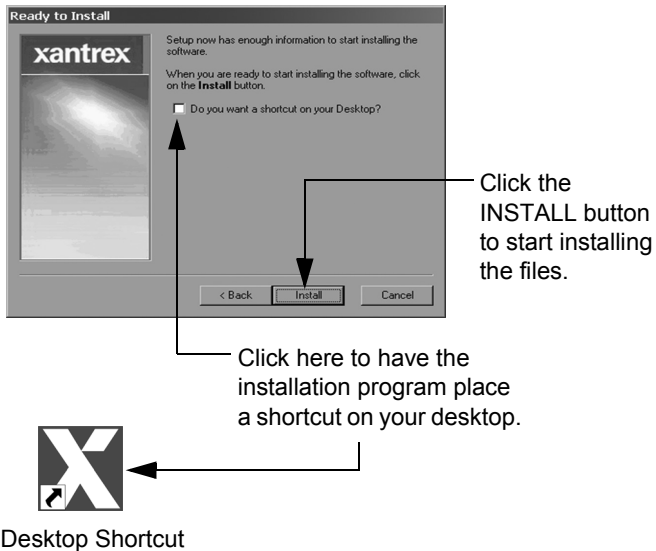

Figure 2-6 Ready to Install Screen

- Click on the **INSTALL** button to start installing the software. The *Installing Files* screen will appear and the progress bar will indicate the progress of the installation.

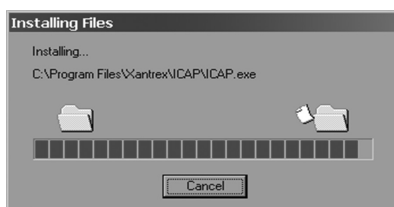

Figure 2-7 Installing Files Screen

10. After the setup program has updated your system, the *Installed* screen will appear to confirm that the installation was successful. Click on the **NEXT** button to proceed to the final step.



Figure 2-8 Installed Screen

11. When the setup program has finished installing the software the *Readme Option* screen will appear. If you do not want to read the Readme file, then click on the check within the white box to remove it.

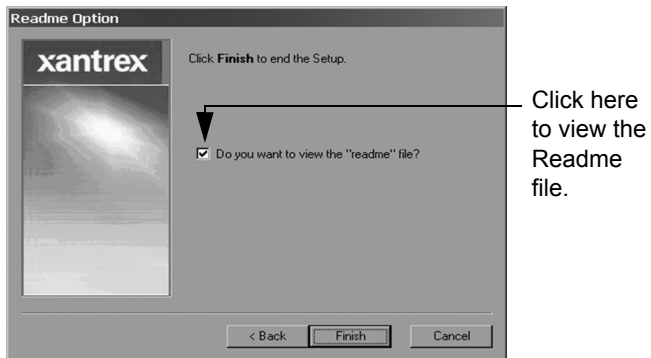

Figure 2-9 Readme Option Screen

12. Click on the **Finish** button to finalize the installation.

Starting Setup Manually

To start the program from the CD if Autorun is disabled on your computer:

1. Insert the ICAP CD into your CDROM drive.
2. Open Windows Explorer (or Click on My Computer) and navigate to the CDROM drive to view the contents of the disk.
3. Either:
 - a) Double-click on the file *ICAPxxx.exe* where xxx = software level (e.g., ICAP102.exe, ICAP103.exe, or ICAP104.exe) or



- b) Copy the file *ICAPxxx.exe* from the CD to the hard drive on the computer. Be sure to remember the location where you've copied the file. After the COPY function is complete, navigate to the location of the file and double-click on it.

Important: Software version shown in this illustration may not represent the most current version.

4. Follow the setup wizard instructions as described on page 15 to page 18 to complete the installation.

Starting Setup From a Command Prompt

To start the program from a command prompt:

1. Insert the ICAP CD into your CDROM drive.
2. Click on START and select “RUN”.
3. Enter the drive letter assigned to your CDROM and the name of the installation program as shown in Figure 2-10.

Important: The drive letter assigned to your CDROM may be different from the one shown in Figure 2-10. Be sure to use the correct letter for your drive or the program will not start.

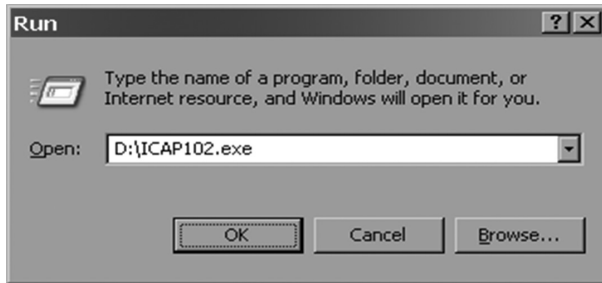

Figure 2-10 Run Window

4. Follow the setup wizard instructions as described on page 15 to page 18 to complete the installation.

Important: Software levels shown in these illustrations may not represent the most current version.

Setting Up a Modem Connection

Modem connection requires the use of a terminal emulation program. A modem is required at both the inverters and at the computer, with a phone line available to make the connection.

The ICA supports use with most “terminal emulation” programs. Any computer that has available serial communications port and terminal emulation software can communicate with the Sine Wave Plus Inverter/Charger using a cable and modem connection.

This manual provides basic keyboard instructions for using terminal emulation; for detailed information, refer to the documentation for the chosen terminal emulation program.

Make a New Connection

1. Start the terminal emulation software of your choice. (HyperTerminal™ was used in this manual). The Connection Description dialog (Figure 2-11) appears.



Figure 2-11 Making a New Connection

2. Enter “ICA” in the Name field of the dialog.
3. Select the desired icon.
4. Click **OK**. The Connection Description dialog is closed and the Phone Number dialog appears.

Establish the Type of Connection

To establish the type of modem connection:

1. In the Phone Number dialog box (Figure 2-12), enter the following information.

Country code:	(e.g., United States of America (1))
Area code:	(e.g., 360)
Phone Number:	(e.g., 123-4567)

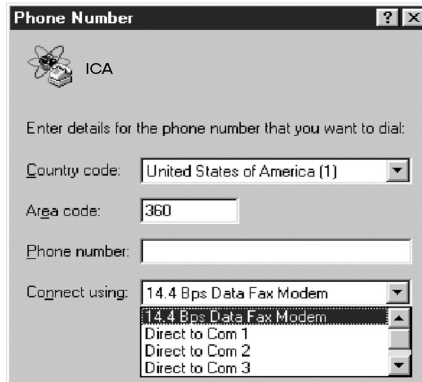

Figure 2-12 Phone Number Dialog

2. Select one of the following in the “Connect Using” drop down list:

Direct to COMx:	for connections to the ICA with a cable, where “x” is a number from 1 to 4. Most common will be “1”
xxx Bps Data Fax Modem	for connections to the ICA with a modem, where “xxx” is the transmission speed of the modem being used.

3. Click **OK**. The Phone Number dialog is closed.

Enter COM Port Property Values

To enter the COM port values:

1. In the COM1 Properties dialog (Figure 2-13) enter the following:

Bits per second:	9600 BAUD*
Data bits:	8
Parity:	No or None
Stop Bits:	1
Flow control:	Either setting

*This setting must be “fixed”. Some programs will over-ride this setting and will attempt to find the fastest speed.

Ensure the accuracy of these settings. Other settings will not produce the desired results.

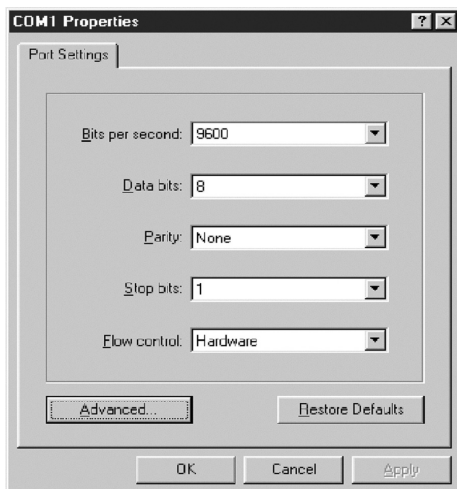

Figure 2-13 COM Port Properties Dialog

2. Click **OK** and a blank window opens.

3 Operation

Chapter 3, “Operation” describes how to operate the ICAP software, change the ICAP settings, test, and troubleshoot the connection.

The following topics are covered in this chapter.

For this topic...	See...
“Starting ICAP”	page 26
“User Interface Features”	page 27
“Changing ICAP Settings”	page 34
“Testing the ICA”	page 40
“Troubleshooting the ICA”	page 40

Starting ICAP

The ICA program can be started with either of the following methods.

Method 1: If you allowed the setup program to put an application shortcut on your desktop:

- Double click on the  shortcut icon on your desktop.

Method 2: If you did NOT allow the setup program to put an application shortcut on your desktop:

1. Click **START**, then **PROGRAMS**, then **XANTREX**.
2. Then select  **ICAP**.

When the program starts, the following splash screen will appear briefly.

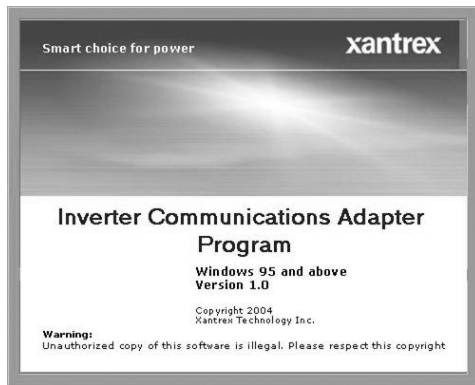

Figure 3-1 ICAP Splash Screen

After which will follow the Inverter Control Module (ICM) Emulation Screen. This screen emulates all the features and functions of the ICM.

See the Inverter's Owner's Guide for details on operational functions of the ICM.

User Interface Features

The ICAP User Interface has the following features. The user can either click on the virtual buttons or use keyboard commands to navigate through the program.

- The ICAP Menu Bar is used for setting ICA parameters (such as number of connected inverters, port usage, customer ID etc.)
- Navigation Buttons are used to navigate through and alter SW Plus Menu Maps.
 - Click on these buttons to navigate through the Menu maps.
 - Holding your mouse over these buttons will make a keyboard command display. Keyboard commands are also listed starting on page 32 of this manual.
- LEDs and LCD - Displays system status.
- Multiple Unit Drop-Down box - Only appears if ICAP has been set up for multiple ICAs (page 35).

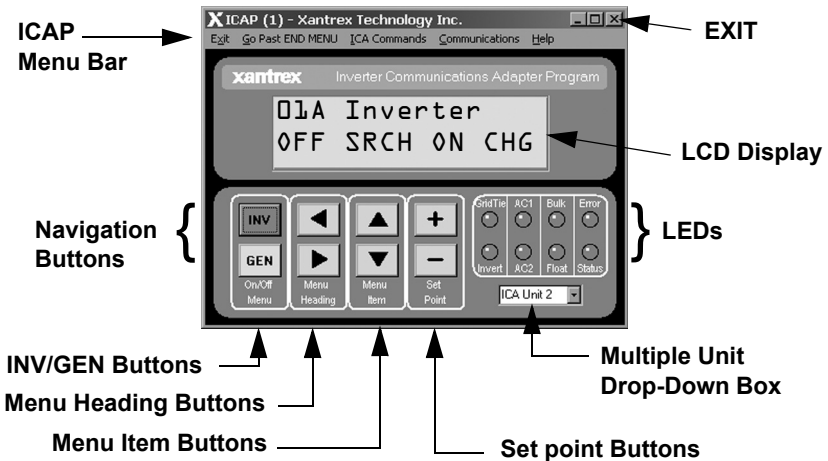

Figure 3-2 ICAP User Interface Window

ICAP Menu Bar

Use the features of the ICAP Menu Bar to access and/or alter programmable parameters for the ICA Adapter. The ICAP Menu bar consists of the following commands:

- Exit
- Go Past END MENU
- ICA Commands
- Communications
- Help

Exit

Exit the ICAP program by using one of the following methods:

- Click on  in upper right corner of window. Or click on the word “Exit” in the Menu bar.
- Press ESC
- Press ALT + X or Press ALT + F4

Go Past END MENU

This command provides the means for the user to move past the END MENU of each menu map for the SW Plus Inverter. Pressing the virtual Navigation Buttons in ICAP will not take the user past the End Menu in each Menu Map like the ICM does.

Menu maps include the User Menu, the Setup Menu, and the Advanced Setup Menu. Each Menu Map has an “END MENU” menu item (e.g., END USER MENU, END SETUP MENU, END ADVANCED SETUP MENU).

To use the “Go Past END MENU” feature:

- When the “END MENU” menu item is displayed in the LCD, click on the “Go Past END MENU” command on the Menu Bar. The program will take the user forward to the next menu map. Or use the keyboard command ALT+G.

ICA Commands

This drop-down menu item provides a means to reconnect, reset, and alter the configuration of the ICAs connected.

Commands include the following:

- Reconnect to ICA
- Reset All ICAs
- Read Configuration
- Read ICA Version

Communications

This drop-down menu item provides a means to reset the RS232-port used by the ICA and select the number of ICAs attached.

HELP

Access help information by using one of the following methods:

- Click here on the Menu Bar
- Press F1
- Press ALT + H + H

To leave **HELP**, press ESC.

LEDs and LCD Display

The LEDs and LCD display show inverter status.

Multiple-Unit Drop-Down Box

Directly below the LEDs is the Multiple-unit Drop-down box. Use this drop-down box to select which unit (inverter) to access.

See Figure 3-2, “ICAP User Interface Window” on page 27 for the location of the LEDs, LCD, and Multiple-Unit Drop-down Box.

Navigation Buttons

Use the virtual Navigation Buttons to move around within the Menu Maps. Navigation buttons are grouped into four categories:

- INV or GEN buttons access Inverter or Generator features.
- The Menu Heading buttons access the Menu Headings for each menu map.
- The Menu Item buttons navigate through the menu items associated with each menu heading.
- The (+) or (–) buttons modify system parameters.

Pressing the virtual Navigation Buttons in ICAP will not take the user past the End Menu in each Menu Map like the ICM does.

ICAP Keyboard and Terminal Emulation Keyboard Shortcut Commands

The keystrokes listed in the following tables enable navigation through the menus and provide the means to monitor or change available settings using a computer keyboard.

- Table 3-1 lists keystrokes available in both ICAP and when using terminal emulation with the ICA program.
- Table 3-2 lists keystrokes available only in ICAP.
- Table 3-3 lists keystrokes available only when using terminal emulation with the ICA program.

Table 3-1 Keyboard Commands







Keystroke	Function
L, l	Menu Headings  (Previous Menu Heading)
R, r	Menu Headings  (Next Menu Heading)
U, u	Menu Item  (Previous Menu Item)
D, d	Menu Item  (Next Menu Item)
+	Set Point  (higher value)
-	Set Point  (lower value)
I, i	Inverter ON/OFF Menu (same as the RED button on the Inverter Control Panel)
G, g	Generator ON/OFF Menu (same as the GREEN button on the Inverter Control Panel)

Table 3-2 Keyboard Commands (ICAP Only)

Keystroke	Function
ALT+G	Go past END MENU command - Accesses either “BEGIN BASIC SETUP” or “BEGIN ADVANCED SETUP” Menus.
ALT+X	Exits the ICAP program.
ALT+I	Accesses the ICA Commands.
ALT+C	Accesses the Communications Commands.
ALT+H	Accesses the Help Commands.
Tab or arrow	Select inverter: move through all buttons to reach the Multiple Unit box. When that box is selected, press arrow to select a particular number (inverter).

Table 3-3 Keyboard Commands (Terminal Emulation Programs Only)

Keystroke	Function
1-8	Select inverter: 1 through 8 is the inverter's ID number, 1 is the default.
S	Setup Menu - Accesses either "BEGIN BASIC SETUP" or "BEGIN ADVANCED SETUP" Menus.
? or /	Sends ASCII LED Status. The information displayed on the screen mimics the layout of the LEDs on the inverter control module : each LED is represented by a dash or a character, laid out in two rows of four characters. <ul style="list-style-type: none"> • Dash: the LED is not lit. • Non-blinking character: the LED is solid (lit). • Blinking character: the LED is blinking. See Sine Wave Plus Inverter/Charger Owner's Manual for details.
V, v	Version number of ICA
T, t	Set terminal mode. If you see a display of many strange characters, try pressing "T" to clear it up.
~	Adapter Reset
ESC	Retransmit LCD screen, LED's, and Adapter ID number

Changing ICAP Settings

ICAP enables you to change certain settings to accommodate your specific configuration. This is done by using the ICA COMMANDS and COMMUNICATION commands on the ICAP Menu Bar. Use the ICA Commands to change configuration parameters for the ICA adapter. Use the Communications Commands to control how the ICA communicates with the inverter.

General settings include:

- Identifying a single (default) or multiple configuration. The unit defaults to a one-inverter configuration. *No additional setting changes should need to be made for single-inverter systems.*
- Assigning the ID numbers for multiple ICAs
- Assigning customer numbers (optional)

Advanced Settings include:

- Changing configuration settings
- Changing port assignments
- Assigning a specific serial number.

Important: Advanced Settings should only be changed as directed by Customer Service or Technical Support personnel.

Once the program has started, it looks for an ICA programmed with an ID number of “1”. This is the default ID number of all adapters.

If two adapters are connected to a PC with the same ID number, you will not be able to communicate correctly with either until the adapters have different ID numbers. It is, therefore, necessary to assign different ID Numbers to each ICA when using more than one.

Identifying Single or Multiple ICAs

To establish multiple inverters in ICAP, start ICAP and follow the steps illustrated in Figure 3-3.

1. Select the **COMMUNICATIONS** Menu.
2. Click this drop down box to display the options.
3. Select the appropriate number for the number of ICAs connected.
4. Click on the **SAVE** button to save the changes.
5. Note and verify change to the ICAP emulation screen. Use this drop down box to switch between inverters.

Figure 3-3 Identifying the Number of ICAs attached

Assigning ID Numbers to the ICA

If you are installing a multiple-inverter system, you will need to identify each inverter to be monitored and assign an ID number to that inverter and ICA. It is recommended that you label each cable as well for ease of identification at a later date.

To change ID Number on the ICA:

1. Connect one ICA to a Sine Wave Plus Inverter/Charger. See Figure 3-4. Only one ICA can be connected at a time for this procedure to be successful.
2. Select ICA COMMANDS, then READ CONFIGURATION. A dialog box will appear allowing you to change the Unit ID number.
3. Enter the Unit ID Number (1 through 8) for each ICA to be attached. Once you change the number in this box, a “WRITE NEW ID” button will appear.
4. Click on the WRITE NEW ID button.
5. Click OK to close the window.
6. Repeat this procedure for each ICA to be connected.

Assigning Customer IDs (Optional)

You can also assign a unique Customer ID if desired. The Customer ID may be any alphanumeric name up to 31 characters long. This step is optional.

Use the ICA COMMANDS/READ CONFIGURATION command to access the window to assign unique customer IDs.

Reset to Defaults

The factory default settings for the ICA can be restored by clicking on the **RESET TO DEFAULT** button. This does not reset the inverter settings.

Use the ICA COMMANDS/READ CONFIGURATION command to access the window containing the RESET TO DEFAULTS button.

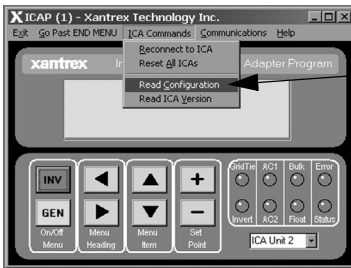

1. Click on **ICA COMMANDS** Menu, then select **READ CONFIGURATION**

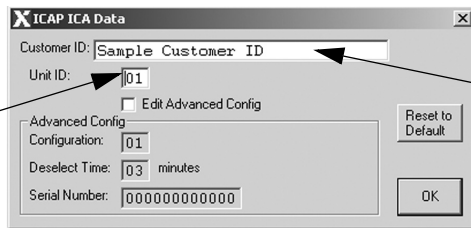

2. Click in this box to change the **Unit ID Number**

Click in this box to change the **Customer ID Number** (Optional)

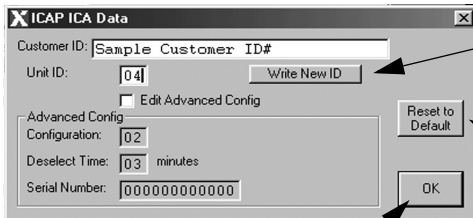

3. Click **Write New ID** to save changes.

Click **Reset to Default** to restore factory settings for the ICAP (Optional)

4. Click **OK** to close the window.

Figure 3-4 Assigning ID Numbers to the ICA

Important: You must click on the **WRITE New ID** button to save changes made to the **Advanced Configuration Settings**. Clicking on the **OK** button will only exit the window without saving the changes.

Advanced Configuration Settings

The Advanced Configuration settings include the **CONFIGURATION PARAMETER**, the **DESELECT TIME**, and the **SERIAL NUMBER** and should only be changed as directed by Xantrex personnel.

To make changes to the Advanced Configuration settings:

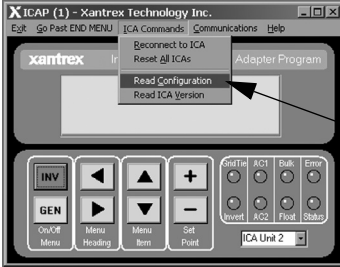

1. Click on **ICA COMMANDS** Menu, then select **READ CONFIGURATION**

2. Click in the **Edit Advanced Config** box to allow access to changing these settings.

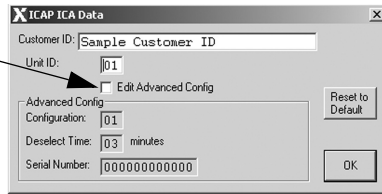

3. Enter new parameters as directed by authorized personnel.

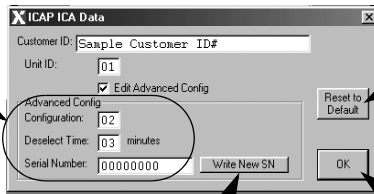

4. Click one of these buttons to save changes

Click **Reset to Default** to restore factory settings for the ICAP (Optional)

5. Click **OK** to close the window.

Figure 3-5 Changing the Advanced Configuration Settings

Important: You must click on one of the buttons to save changes made to the Advanced Configuration Settings. Clicking on the **OK** button will only exit the window without saving the changes.

Changing the PC's COM Port Number

To change the COM port number, start ICAP and follow the procedure illustrated in Figure 3-6. COM Port options range from 1 to 8.

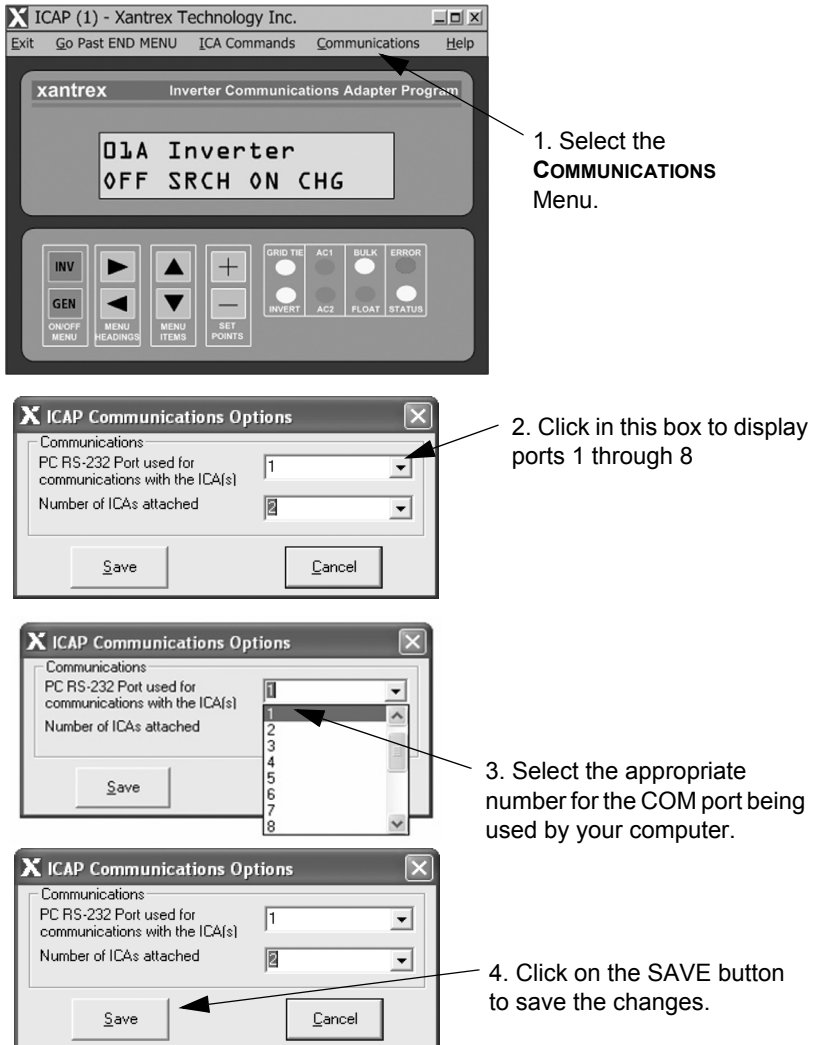

Figure 3-6 Changing the PC's COM Port Number

Testing the ICA

In order to test the ICA, it must be plugged into an inverter that is powered up on batteries or other suitable power supply.

Press the first unit's ID number (1 is the default) on your computer keyboard. If everything is correct, the inverter's display will change (and reflect) the same as the ICAP window.

Troubleshooting the ICA

Table 3-4 below lists some of the problems and solutions that you may encounter with your ICA.

Table 3-4 Troubleshooting the ICA

Symptom	Recommendation
<p>There is no adapter response, or</p> <p>Display reads: "ADAPTER OFFLINE"</p> <p>See "Troubleshooting if No Response comes from the ICA" on page 41 for details.</p>	<ol style="list-style-type: none"> 1. Ensure the inverter has power. The display on the inverter should be ON. 2. Check the unit's ID number of the ICA adapter you are trying to access. Ensure that it is correct. This will display when there is no adapter with the ID number you are entering. 3. Check the connection from the adapter to the remote port. 4. Check the connection from the COM Port to the Remote Port on the inverter. 5. Check the LED on the ICA Adapter. <ul style="list-style-type: none"> • If it illuminates when connected to the inverter's Remote Port, then the adapter is recognized. • If it does not illuminate when connected to the inverter's Remote Port, then the adapter may be malfunctioning.
ICA display is blank	Normal upon initial startup. Push any system button to get a display.
Data (via modem) is not recognizable	Ensure that the BAUD rate for the modem and the dial-up program is fixed at 9600.

Table 3-4 Troubleshooting the ICA (Continued)

Symptom	Recommendation
Modem is not connecting	Run the ICAP program directly to the ICA to determine if the adapter is functioning and all connections to the adapter are correct.
ICA and inverter spontaneously jump menus or give false indicators	DC power was cycled on the inverter with ICAP already running. This does not cause harm to the system; it is just a nuisance. To avoid it, make sure ICAP is started after the inverter is powered up.

Troubleshooting if No Response comes from the ICA

Check ID

If the ICA is not responding, ensure you have the correct “ICA unit number” selected on the ICAP user interface window, see figure 3-2. If you selected “ICA Unit 1” and nothing happened, then try selecting “ICA Unit 2” and so forth.

Reset Defaults

If the ICA is still not responding, then click on the “RESET TO DEFAULT” button, click “OK” (see figure 3-3), and select “ICA Unit 1” again.

Check Settings

If there is still no response from the ICA, then check your settings.

- Ensure you are selecting the correct COM port
- Ensure your computer communication baud rate is fixed at 9600 Baud.

Reset Program

Reset the program by closing the ICAP program. Then disconnect the ICA adapter and plug it back in, making sure the phone cord is securely plugged in. When you plug in the ICA, the green LED on the ICA adapter should light up.

Phone Connections

Be sure that the phone cable is the correct type. The small clip on the crimped on jacks must be located on the same side of the cable or it will cause garbled characters or no communication.

If the LED turns off when the cable is connected, check the cable for proper orientation of the phone jacks. They must be crimped onto the phone cable with the small tabs on each end located on the same side of the cable. If the cable is not correct, replace it with another one. This is the standard phone cable orientation.

Hardware Connectors

Tighten the two small screws located on the ICA into the stand-offs on the connectors of the inverters.

Also check the tightness of the thumb screws on the DB9 adapter for the phone cable to the serial port.

After tightening the screws, retest the ICA adapter.

Ensure the DB9 adapter is the one provided with the ICA. This is not a standard DB9 to RJ45 adapter. It was custom-made especially for the ICA.

Confirm that the cable is the correct type. Make sure the adapter is plugged into the remote port and not the stacking port of the inverter.

Check Configuration

With the ICAP software, only have one ICA adapter connected. Check the ICA adapter's configuration code (02) and deselected time (03). Reset if needed and retry.

If multiple ICA adapters are connected, disconnect them and try each individually with a single cable and no other adapters or splitters in the cable.

Try the adapter on another computer or inverter.

Display Anomaly

Sometimes, when you first run the ICAP software after a power-up, the ICAP software window may display strange characters or a blank screen for less than a minute.

This occurs because the first time the ICAP program starts, the display of the SW Plus inverter is at an unknown location. The location may be one of the menu areas that is continually being refreshed with data. If the ICAP software starts up and the SW Plus inverter's display is parked on a menu that is continually being refreshed, you will notice that strange characters get displayed on the software window for a few seconds.

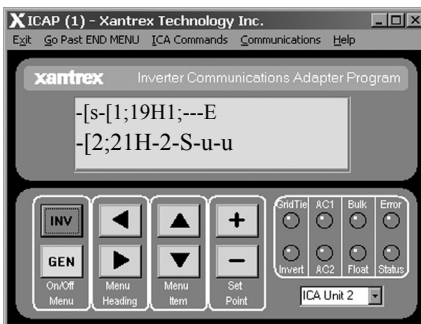

Figure 3-7 Screen Display Startup Anomaly #1

On the other hand, if the SW Plus inverter's display is parked on a static menu item, then when you startup, the software window may show a blank display for a few seconds.

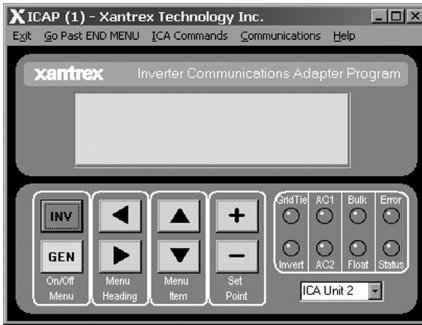

Figure 3-8 Screen Display Startup Anomaly #2

This condition is nothing to worry about and should correct itself in about 1 minute.

When the ICAP software shuts down, it will try to park the inverter's display at a more friendly menu location so that the next time it starts up it doesn't have these problem.

Warranty and Return Information

Warranty

What does this warranty cover? This Limited Warranty is provided by Xantrex Technology, Inc. ("Xantrex") and covers defects in workmanship and materials in your Inverter Communications Adapter. This warranty period lasts for two (2) years from the date of purchase at the point of sale to you, the original end user customer. You require proof of purchase to make warranty claims.

This Limited Warranty is transferable to subsequent owners but only for the unexpired portion of the Warranty Period. Subsequent owners also require proof of purchase.

What will Xantrex do? Xantrex will, at its option, repair or replace the defective product free of charge, provided that you notify Xantrex of the product defect within the Warranty Period, and provided that Xantrex through inspection establishes the existence of such a defect and that it is covered by this Limited Warranty.

Xantrex will, at its option, use new and/or reconditioned parts in performing warranty repair and building replacement products. Xantrex reserves the right to use parts or products of original or improved design in the repair or replacement. If Xantrex repairs or replaces a product, its warranty continues for the remaining portion of the original Warranty Period or 90 days from the date of the return shipment to the customer, whichever is greater. All replaced products and all parts removed from repaired products become the property of Xantrex.

Xantrex covers both parts and labor necessary to repair the product, and return shipment to the customer via a Xantrex-selected non-expedited surface freight within the contiguous United States and Canada. Alaska and Hawaii are excluded. Contact Xantrex Customer Service for details on freight policy for return shipments outside of the contiguous United States and Canada.

How do you get service? If your product requires troubleshooting or warranty service, contact your merchant. If you are unable to contact your merchant, or the merchant is unable to provide service, contact Xantrex directly at:

Telephone: 1 800 670 0707 (toll free North America)

1 360 925 5097 (direct)

Fax: 1 360 925 5143 (direct)

Email: customerservice@xantrex.com

Direct returns may be performed according to the Xantrex Return Material Authorization Policy described in your product manual. For some products, Xantrex maintains a network of regional Authorized Service Centers. Call Xantrex or check our website to see if your product can be repaired at one of these facilities.

Warranty and Return

What proof of purchase is required? In any warranty claim, dated proof of purchase must accompany the product and the product must not have been disassembled or modified without prior written authorization by Xantrex.

Proof of purchase may be in any one of the following forms:

- The dated purchase receipt from the original purchase of the product at point of sale to the end user, or
- The dated dealer invoice or purchase receipt showing original equipment manufacturer (OEM) status, or
- The dated invoice or purchase receipt showing the product exchanged under warranty

What does this warranty not cover? This Limited Warranty does not cover normal wear and tear of the product or costs related to the removal, installation, or troubleshooting of the customer's electrical systems. This warranty does not apply to and Xantrex will not be responsible for any defect in or damage to:

- a) the product if it has been misused, neglected, improperly installed, physically damaged or altered, either internally or externally, or damaged from improper use or use in an unsuitable environment;
- b) the product if it has been subjected to fire, water, generalized corrosion, biological infestations, or input voltage that creates operating conditions beyond the maximum or minimum limits listed in the Xantrex product specifications including high input voltage from generators and lightning strikes;
- c) the product if repairs have been done to it other than by Xantrex or its authorized service centers (hereafter "ASCs");
- d) the product if it is used as a component part of a product expressly warranted by another manufacturer;
- e) the product if its original identification (trade-mark, serial number) markings have been defaced, altered, or removed.

Disclaimer

Product

THIS LIMITED WARRANTY IS THE SOLE AND EXCLUSIVE WARRANTY PROVIDED BY XANTREX IN CONNECTION WITH YOUR XANTREX PRODUCT AND IS, WHERE PERMITTED BY LAW, IN LIEU OF ALL OTHER WARRANTIES, CONDITIONS, GUARANTEES, REPRESENTATIONS, OBLIGATIONS AND LIABILITIES, EXPRESS OR IMPLIED, STATUTORY OR OTHERWISE IN CONNECTION WITH THE PRODUCT, HOWEVER ARISING (WHETHER BY CONTRACT, TORT, NEGLIGENCE, PRINCIPLES OF MANUFACTURER'S LIABILITY, OPERATION OF LAW, CONDUCT, STATEMENT OR OTHERWISE), INCLUDING WITHOUT RESTRICTION ANY IMPLIED WARRANTY OR CONDITION OF QUALITY, MERCHANTABILITY OR FITNESS FOR A PARTICULAR PURPOSE. ANY IMPLIED WARRANTY OF MERCHANTABILITY OR FITNESS FOR A PARTICULAR PURPOSE TO THE EXTENT REQUIRED UNDER APPLICABLE LAW TO APPLY TO THE PRODUCT SHALL BE LIMITED IN DURATION TO THE PERIOD STIPULATED UNDER THIS LIMITED WARRANTY.

IN NO EVENT WILL XANTREX BE LIABLE FOR ANY SPECIAL, DIRECT, INDIRECT, INCIDENTAL OR CONSEQUENTIAL DAMAGES, LOSSES, COSTS OR EXPENSES HOWEVER ARISING WHETHER IN CONTRACT OR TORT INCLUDING WITHOUT RESTRICTION ANY ECONOMIC LOSSES OF ANY KIND, ANY LOSS OR DAMAGE TO PROPERTY, ANY PERSONAL INJURY, ANY DAMAGE OR INJURY ARISING FROM OR AS A RESULT OF MISUSE OR ABUSE, OR THE INCORRECT INSTALLATION, INTEGRATION OR OPERATION OF THE PRODUCT.

Exclusions

If this product is a consumer product, federal law does not allow an exclusion of implied warranties. To the extent you are entitled to implied warranties under federal law, to the extent permitted by applicable law they are limited to the duration of this Limited Warranty. Some states and provinces do not allow limitations or exclusions on implied warranties or on the duration of an implied warranty or on the limitation or exclusion of incidental or consequential damages, so the above limitation(s) or exclusion(s) may not apply to you. This Limited Warranty gives you specific legal rights. You may have other rights which may vary from state to state or province to province.

Warning: Limitations On Use

Please refer to your product manual for limitations on uses of the product.

SPECIFICALLY, PLEASE NOTE THAT THE INVERTER COMMUNICATIONS ADAPTER SHOULD NOT BE USED IN CONNECTION WITH LIFE SUPPORT SYSTEMS OR OTHER MEDICAL EQUIPMENT OR DEVICES. WITHOUT LIMITING THE GENERALITY OF THE FOREGOING, XANTREX MAKES NO REPRESENTATIONS OR WARRANTIES REGARDING THE USE OF THE XANTREX INVERTER COMMUNICATIONS ADAPTER IN CONNECTION WITH LIFE SUPPORT SYSTEMS OR OTHER MEDICAL EQUIPMENT OR DEVICES.

Return Material Authorization Policy

Before returning a product directly to Xantrex you must obtain a Return Material Authorization (RMA) number and the correct factory "Ship To" address. Products must also be shipped prepaid. Product shipments will be refused and returned at your expense if they are unauthorized, returned without an RMA number clearly marked on the outside of the shipping box, if they are shipped collect, or if they are shipped to the wrong location.

When you contact Xantrex to obtain service, please have your instruction manual ready for reference and be prepared to supply:

- The serial number of your product
- Information about the installation and use of the unit
- Information about the failure and/or reason for the return
- A copy of your dated proof of purchase

Record these details in "Information About Your System" on page 49.

Return Procedure

1. Package the unit safely, preferably using the original box and packing materials. Please ensure that your product is shipped fully insured in the original packaging or equivalent. This warranty will not apply where the product is damaged due to improper packaging.
2. Include the following:
 - The RMA number supplied by Xantrex Technology, Inc. clearly marked on the outside of the box.
 - A return address where the unit can be shipped. Post office boxes are not acceptable.
 - A contact telephone number where you can be reached during work hours.
 - A brief description of the problem.
3. Ship the unit prepaid to the address provided by your Xantrex customer service representative.

If you are returning a product from outside of the USA or Canada In addition to the above, you **MUST** include return freight funds and are fully responsible for all documents, duties, tariffs, and deposits.

If you are returning a product to a Xantrex Authorized Service Center (ASC) A Xantrex return material authorization (RMA) number is not required. However, you must contact the ASC prior to returning the product or presenting the unit to verify any return procedures that may apply to that particular facility.

Out of Warranty Service

If the warranty period for your Inverter Communications Adapter has expired, if the unit was damaged by misuse or incorrect installation, if other conditions of the warranty have not been met, or if no dated proof of purchase is available, your inverter may be serviced or replaced for a flat fee.

To return your Inverter Communications Adapter for out of warranty service, contact Xantrex Customer Service for a Return Material Authorization (RMA) number and follow the other steps outlined in “Return Procedure” on page 48.

Payment options such as credit card or money order will be explained by the Customer Service Representative. In cases where the minimum flat fee does not apply, as with incomplete units or units with excessive damage, an additional fee will be charged. If applicable, you will be contacted by Customer Service once your unit has been received.

Information About Your System

As soon as you open your Inverter Communications Adapter package, record the following information and be sure to keep your proof of purchase.

- Serial Number _____
- Purchased From _____
- Purchase Date _____

If you need to contact Customer Service, please record the following details before calling. This information will help our representatives give you better service.

- Type of installation [e.g. RV, truck, vehicle, home] _____
- Length of time inverter has been installed _____
- Battery/battery bank size _____
- DC wiring size and length _____
- Warning, Error or Panel Fault Message _____
- Appliances operating when problem occurred _____
- Description of problem _____

Index

A

Abbreviations and Acronyms v

C

CD with ICAP Software 2

changing the COM port number 39

color coding for ICA phone cable 11

connecting multiple ICAs to a single computer 8

Customer Service

preparing to call 49

I

ICAP software

configuring 34

installing 14

keyboard commands in 31

using advanced monitoring software with 12

Information about Your System form 49

installing the ICA 4

Inverter Communications Adapter (ICA) 2

connecting to a modem 6

installing 4

installing the ICAP software 14

pin assignments for RJ11 connectors 11

testing 40

troubleshooting 40

K

keyboard commands, using 31

M

modem connection for remote locations 6

modem connection, setting up 21

multiple adapters 8

N

NULL MODEM adapter 6

O

opto-isolators in positive ground configurations 10

P

pin assignments for RJ11 connectors 11

proof of purchase 49

purchase date 49

PV ground fault protection 10

R

remote locations, using a modem with the ICA 6

S

setting up a modem connection 21

T

terminal emulation programs 21

testing the ICA 40

troubleshooting the ICA 40

W

warranty

out of warranty service 48

terms and conditions 45

X

Xantrex

web site vi

Xantrex Technology Inc.

1 800 670 0707 Tel toll free NA

1 360 925 5097 Tel direct

1 360 925 5143 Fax direct

customerservice@xantrex.com

www.xantrex.com

Free Manuals Download Website

<http://myh66.com>

<http://usermanuals.us>

<http://www.somanuals.com>

<http://www.4manuals.cc>

<http://www.manual-lib.com>

<http://www.404manual.com>

<http://www.luxmanual.com>

<http://aubethermostatmanual.com>

Golf course search by state

<http://golfingnear.com>

Email search by domain

<http://emailbydomain.com>

Auto manuals search

<http://auto.somanuals.com>

TV manuals search

<http://tv.somanuals.com>