

Smart choice for power

# xantrex

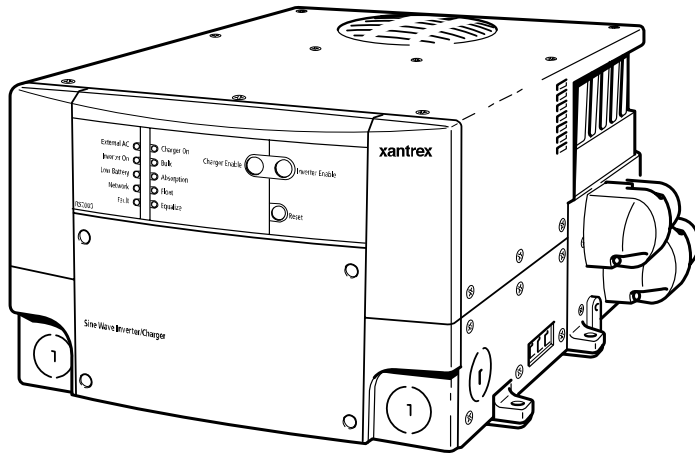

RS2000

## Operation Guide

### RS2000 Sine Wave Inverter/Charger



[www.xantrex.com](http://www.xantrex.com)



# RS2000 Sine Wave Inverter/Charger

## Operation Guide

## About Xantrex

Xantrex Technology Inc. is a world-leading supplier of advanced power electronics and controls with products from 50 watt mobile units to one MW utility-scale systems for wind, solar, batteries, fuel cells, microturbines, and backup power applications in both grid-connected and stand-alone systems. Xantrex products include inverters, battery chargers, programmable power supplies, and variable speed drives that convert, supply, control, clean, and distribute electrical power.

## Trademarks

RS2000 Sine Wave Inverter/Charger is a trademark of Xantrex International. Xantrex and Xanbus are registered trademarks of Xantrex International.

Other trademarks, registered trademarks, and product names are the property of their respective owners and are used herein for identification purposes only.

## Notice of Copyright

*RS2000 Sine Wave Inverter/Charger Operation Guide* © June 2004 Xantrex International. All rights reserved.

## Disclaimer

UNLESS SPECIFICALLY AGREED TO IN WRITING, XANTREX TECHNOLOGY INC. ("XANTREX")

(a) MAKES NO WARRANTY AS TO THE ACCURACY, SUFFICIENCY OR SUITABILITY OF ANY TECHNICAL OR OTHER INFORMATION PROVIDED IN ITS MANUALS OR OTHER DOCUMENTATION.

(b) ASSUMES NO RESPONSIBILITY OR LIABILITY FOR LOSS OR DAMAGE, WHETHER DIRECT, INDIRECT, CONSEQUENTIAL OR INCIDENTAL, WHICH MIGHT ARISE OUT OF THE USE OF SUCH INFORMATION. THE USE OF ANY SUCH INFORMATION WILL BE ENTIRELY AT THE USER'S RISK.

## Date and Revision

June 2004 Rev A

## Part Number

975-0125-01-01

## Contact Information

Telephone: 1 800 670 0707 (toll free North America)  
1 360 925 5097 (direct)

Fax: 1 800 994 7828 (toll free North America)  
1 360 925 5143 (direct)

Email: [customerservice@xantrex.com](mailto:customerservice@xantrex.com)

Web: [www.xantrex.com](http://www.xantrex.com)

# About This Guide

## Purpose

The *RS2000 Sine Wave Inverter/Charger Operation Guide* provides explanations and procedures for operating, configuring, and troubleshooting the RS2000 Sine Wave Inverter/Charger (RS2000).

## Scope

The guide provides safety guidelines and information about operating, configuring, and troubleshooting the unit. It does not include information for installing the inverter/charger. Refer to the *RS2000 Sine Wave Inverter/Charger Installation Guide*.

The guide also provides general guidelines on batteries; it does not provide details about particular brands of batteries. You need to consult individual battery manufacturers for this information.

## Audience

The guide is intended for users who need to configure and operate the RS2000 Sine Wave Inverter/Charger.

## Organization

This guide is organized into four chapters and three appendixes.

Chapter 1, “Introduction”, outlines the main performance and safety features of the RS2000 Sine Wave Inverter/Charger. Reading this chapter will give you a clear understanding of the inverter/charger’s capabilities.

Chapter 2, “Operation”, provides information about operating the RS2000. Details are provided on how to read the front panel indicators to monitor the RS2000.

Chapter 3, “Configuration”, explains how to configure the RS2000 from the control panel.

Chapter 4, “Troubleshooting”, explains how to identify and solve problems that can occur with the RS2000.

Appendix A, “Specifications” provides electrical, physical, and performance specifications for the inverter/charger.

Appendix B, “Battery Charging Reference” provides information on three-stage charging, two-stage charging, and charging times.

Appendix C, “Terminology” provides a glossary and a listing of commonly used abbreviations and acronyms.

“Warranty and Product Information” contains the product warranty, explains how to return a product for service, and describes what to prepare for a call to Xantrex Customer Service.

## Conventions Used

The following conventions are used in this guide.



### **WARNING**

Warnings identify conditions or practices that could result in personal injury or loss of life.

---



### **CAUTION**

Cautions identify conditions or practices that could result in damage to the RS2000 or other equipment.

---

---

**Important:** These notes describe an important action item or an item that you must pay attention to.

---

## Symbols Used

The following symbols are used on the product labels or in this guide.

|  |  |
|--|--|
|  | In this guide: Important information, warnings or cautions.<br>On the product: Important information, warnings or cautions with further explanation in the product guides. |
|  | AC – Alternating current   |
|  | DC – Direct current  |

## Related Information

For related materials on this product and its available accessories, see also:

*RS2000 Sine Wave Inverter/Charger Installation Guide (975-0126-01-01)*

*System Control Panel Owner's Guide (975-0083-01-01)*

*Automatic Generator Start Owner's Guide (975-0082-01-01)*

*Xanbus System Installation Guide (975-0136-01-01)*

More information about Xantrex Technology Inc. as well as its products and services, including a complete list of Xanbus-enabled devices, is available at **[www.xantrex.com](http://www.xantrex.com)**

## Contact Information

Telephone: 1 800 670 0707 (toll free North America)  
1 360 925 5097 (direct)

Fax: 1 800 994 7828 (toll free North America)  
1 360 925 5143 (direct)

Email: [customerservice@xantrex.com](mailto:customerservice@xantrex.com)

Web: [www.xantrex.com](http://www.xantrex.com)





# Important Safety Instructions

## READ AND SAVE THESE INSTRUCTIONS

The *RS2000 Sine Wave Inverter/Charger Operation Guide* contains important safety instructions.

Before you install and use your RS2000 Sine Wave Inverter/Charger, be sure to read, understand and save these safety instructions and those in the other product guides.

Read all instructions and cautionary markings on the inverter/charger, the batteries and all appropriate sections of this guide.



### **WARNING: Risk of injury or loss of life**

The RS2000 Sine Wave Inverter/Charger shall not be used in connection with life support systems or other medical equipment or devices.

---



### **WARNING**

The following warnings identify conditions or practices that could result in personal injury or loss of life.

---

1. Use of accessories not recommended or sold by Xantrex Technology, Inc. may result in a risk of fire, electric shock, or injury to persons.
2. The inverter/charger is designed to be permanently connected to your AC and DC electrical systems. Xantrex recommends that all wiring be done by a certified technician or electrician to ensure adherence to the local and national electrical codes applicable in your application.
3. To avoid a risk of fire and electric shock, make sure that existing wiring is in good condition and that wire is not undersized. Do not operate the inverter/charger with damaged or substandard wiring.
4. To reduce risk of damage and injury, charge only rechargeable lead-acid batteries (flooded, gel, or absorbed glass mat (AGM) types). Other types of batteries may burst causing personal injury and damage.

5. Do not operate the inverter/charger if it has received a sharp blow, been dropped, or otherwise damaged in any way. If the unit is damaged, see the “Warranty and Product Information” section in the *RS2000 Sine Wave Inverter/Charger Operation Guide*.
6. Do not disassemble the inverter/charger; it does not contain user serviceable parts. Take it to a qualified service person when service or repair is required. Incorrect reassembly may result in a risk of electrical shock or fire. Internal capacitors remain charged after all power is disconnected. For instructions on obtaining service, see the “Warranty and Product Information” section in the *RS2000 Sine Wave Inverter/Charger Operation Guide*.
7. Do not expose the inverter/charger to rain, snow, or water.
8. To reduce risk of electric shock, disconnect all sources of AC and DC power from the inverter/charger attempting any maintenance or cleaning. Turning off controls will not reduce this risk.
9. The inverter/charger must be provided with equipment grounding conductors connected to the AC input ground and chassis ground terminals.



### CAUTION

Cautions identify conditions or practices that could result in damage to the unit or other equipment.

---

To reduce the risk of overheating, keep the ventilation openings clear and do not install the inverter/charger in a compartment with limited airflow or inadequate clearances around the unit. Refer to the *RS2000 Sine Wave Inverter/Charger Installation Guide* for required clearance.

---

## Explosive Gas Precautions

---



### **WARNING: Risk of explosive gases**

Working in vicinity of a lead-acid battery is dangerous. Batteries generate explosive gases during normal battery operation. For this reason, it is of utmost importance that you must read this guide and follow its instructions closely each time before you service equipment in the vicinity of the battery.

---

1. To reduce risk of battery explosion, follow these instructions and those published by the battery manufacturer and manufacturer of any equipment you intend to use in vicinity of battery. Review cautionary markings on these products and on the engine.
2. This equipment contains components which tend to produce arcs or spark. To prevent fire or explosion, do not install the inverter/charger in compartments containing batteries or flammable materials or in locations that require ignition-protected equipment. This includes any space containing gasoline-power machinery, fuel tanks, as well as joints, fittings, or other connections between components of the fuel system.

## Personal Precautions When Working With Batteries

1. Someone should be within range of your voice or close enough to come to your aid when you work near a lead-acid battery.
2. Have plenty of fresh water and soap nearby in case battery acid contacts your skin, clothing, or eyes.
3. Wear complete eye protection and clothing protection. Avoid touching your eyes while working near batteries.
4. If battery acid contacts your skin or clothing, wash immediately with soap and water. If acid enters your eye, immediately flood the eye with running cold water for at least ten minutes and get medical attention immediately.
5. Never smoke or allow a spark or flame in vicinity of battery or engine.
6. Be extra cautious to reduce risk of dropping a metal tool onto battery. It might spark or short-circuit battery or other electrical part that may cause explosion.

7. Remove personal metal items such as rings, bracelets, necklaces, and watches when working with a lead-acid battery. A lead-acid battery can produce a short-circuit current high enough to weld a ring or the like to metal, causing a severe burn.
8. Never charge a frozen battery.
9. If necessary to remove the battery, always remove the grounded terminal from the battery first. Make sure all accessories are off, so as not to cause an arc.
10. Be sure area around battery is well ventilated.
11. Clean battery terminals. Be careful to keep corrosion from coming in contact with your eyes.
12. Study all battery manufacturer's specific precautions such as removing or not removing cell caps while charging and recommended rates of charge.
13. For refillable (flooded) batteries, add distilled water in each cell until the battery acid reaches the level specified by the battery manufacturer. This helps to purge excessive gas from cells. Do not overfill. Carefully follow manufacturer's recharging instructions.

## FCC Information to the User

This equipment has been tested and found to comply with the limits for a Class B digital device, pursuant to part 15 of the FCC Rules. These limits are designed to provide reasonable protection against harmful interference when the equipment is operated in a residential environment. This equipment generates, uses and can radiate radio frequency energy and, if not installed and used in accordance with the instruction guide, may cause harmful interference to radio communications. However, there is no guarantee that interference will not occur in a particular installation. If this equipment does cause harmful interference to radio or television reception, which can be determined by turning the equipment off and on, the user is encouraged to try to correct the interference by one or more of the following measures:

- Reorient or relocate the receiving antenna.
- Increase the separation between the equipment and the receiver.
- Connect the equipment into an outlet on a circuit different from that to which the receiver is connected.
- Consult the dealer or an experienced radio/TV technician for help.

# Contents

## Important Safety Instructions

|  |    |
|--|----|
| Explosive Gas Precautions .....                        | ix |
| Personal Precautions When Working With Batteries ..... | ix |
| FCC Information to the User .....                      | x  |

## 1 Introduction

|   |      |
|---|------|
| About the RS2000 Sine Wave Inverter/Charger .....       | 1-2  |
| Premium Power and Ease of Use .....                     | 1-2  |
| How RS2000 Works .....                                  | 1-3  |
| Inverting .....   | 1-3  |
| Charging .....  | 1-3  |
| Xanbus System .....                                     | 1-5  |
| Xanbus Enabled .....                                    | 1-5  |
| Comprehensive Electronic Protection .....               | 1-6  |
| RS2000 Features .....                                   | 1-7  |
| Front Panel Features .....                              | 1-7  |
| Side Panel Features .....                               | 1-9  |
| DC Terminal Covers and Battery Temperature Sensor ..... | 1-11 |
| DC Terminal Covers .....                                | 1-11 |
| Battery Temperature Sensor .....                        | 1-11 |
| System Accessories and Network Components .....         | 1-12 |

## 2 Operation

|  |      |
|--|------|
| Operating the RS2000 with the System Control Panel ..... | 2-2  |
| Using the System Control Panel .....                     | 2-3  |
| On Start Up .....  | 2-4  |
| System Start-up Check .....                              | 2-5  |
| System Modes .....                                       | 2-6  |
| Operate Mode .....                                       | 2-7  |
| Power Save Mode .....                                    | 2-7  |
| Safe Mode .....  | 2-8  |
| Putting the System into Safe Mode .....                  | 2-9  |
| Hibernate mode .....                                     | 2-11 |
| Operation in Invert Mode .....                           | 2-12 |
| Load Sense Mode .....                                    | 2-12 |
| Operating Limits for Inverter Operation .....            | 2-13 |
| Power Output .....                                       | 2-13 |

## Contents

---

|  |      |
|--|------|
| Operating in Charger Mode - - - - -                              | 2-14 |
| Charger Operation with Battery Temperature Sensor - - - - -      | 2-15 |
| Operating in Equalization Mode - - - - -                         | 2-16 |
| Equalizing Batteries - - - - -                                   | 2-17 |
| Terminating the Equalization Process - - - - -                   | 2-20 |
| Operating Limits for Charger Operation - - - - -                 | 2-20 |
| Power Share - - - - -  | 2-20 |
| Monitoring the RS2000 Indicator Lights - - - - -                 | 2-21 |
| Faults and Warnings - - - - -                                    | 2-22 |
| Monitoring Status Messages on the System Control Panel - - - - - | 2-22 |

## 3 Configuration

|   |      |
|---|------|
| General Configuration Information - - - - -                 | 3-2  |
| System Control - - - - -                                    | 3-2  |
| System Menu Map - - - - -                                   | 3-3  |
| Viewing the System Screen - - - - -                         | 3-4  |
| Viewing the Select Device Menu - - - - -                    | 3-4  |
| Selecting the RS2000 Basic Menu - - - - -                   | 3-5  |
| Selecting and Adjusting the Configurable settings - - - - - | 3-6  |
| RS2000 Configuration Menus - - - - -                        | 3-7  |
| RS2000 Device Menu - - - - -                                | 3-9  |
| Mode - - - - -  | 3-9  |
| Battery - - - - -   | 3-10 |
| AC Input - - - - -  | 3-10 |
| AC Out - - - - -  | 3-10 |
| RS2000 Menu (Basic) - - - - -                               | 3-11 |
| Inverter - - - - -  | 3-11 |
| Charger - - - - -   | 3-12 |
| Power Share - - - - -                                       | 3-13 |
| Equalize - - - - -  | 3-13 |
| Batt Type - - - - -   | 3-16 |
| Batt Size - - - - -   | 3-17 |
| Clear Faults - - - - -                                      | 3-17 |
| RS2000 Menu (Advanced) - - - - -                            | 3-18 |
| Inverter - - - - -  | 3-18 |
| Charger - - - - -   | 3-18 |
| Power Share - - - - -                                       | 3-18 |
| Configure Inv/Chg (Configure Inverter/Charger) - - - - -    | 3-18 |
| Max Chg Rate - - - - -                                      | 3-19 |
| Load Sense - - - - -  | 3-19 |

---

|  |      |
|--|------|
| Equalize   | 3-20 |
| Clear Faults   | 3-20 |
| View Device Info   | 3-20 |
| Basic Menu   | 3-20 |
| Selecting the RS2000 Advanced Menu                       | 3-21 |
| Returning to RS2000 Basic Menu                           | 3-22 |
| Sub-Menus  | 3-23 |
| Configure Inv/Chg Menu (Configure Inverter/Charger Menu) | 3-23 |
| Lo DC Volt   | 3-23 |
| Batt Type  | 3-23 |
| Batt Size  | 3-23 |
| Sense Below  | 3-23 |
| Sense Interval   | 3-24 |
| Cfg AC Limits (Configure AC Limits)                      | 3-24 |
| # Chg Stages   | 3-24 |
| Eqz Volts  | 3-25 |
| Force Charge   | 3-25 |
| Cfg AC Limits (Configure AC Limits)                      | 3-26 |
| Lo AC Volt   | 3-26 |
| Lo AC Freq   | 3-26 |
| Hi AC Volt   | 3-27 |
| Hi AC Freq   | 3-27 |
| View Device Info Menu (Device Information Menu)          | 3-28 |
| View Fault Log   | 3-28 |
| View Warning Log   | 3-28 |
| View Event Log   | 3-28 |
| Restore Defaults   | 3-29 |

## 4 Troubleshooting

|                                    |      |
|------------------------------------|------|
| Faults and Warnings                | 4-2  |
| Fault Types                        | 4-2  |
| Warning Types                      | 4-3  |
| Troubleshooting Reference          | 4-4  |
| General Troubleshooting Guidelines | 4-5  |
| Warning Messages                   | 4-7  |
| Fault Messages                     | 4-11 |
| Inverter Applications              | 4-17 |
| Resistive Loads                    | 4-17 |
| Motor Loads                        | 4-17 |
| Problem Loads                      | 4-17 |

## Contents

---

|  |      |
|--|------|
| Very small loads                             | 4-17 |
| Fluorescent Lights & Power Supplies          | 4-18 |
| Clocks                                       | 4-18 |
| Searching                                    | 4-18 |
| <b>A Specifications</b>                      |      |
| Inverter Specifications                      | A-2  |
| Charger Specifications                       | A-3  |
| Transfer and General Specifications          | A-4  |
| Environmental Specifications                 | A-4  |
| Physical Specifications with Projections     | A-5  |
| Regulatory Approvals                         | A-5  |
| Fan Operation                                | A-5  |
| Invert Power Derating vs Ambient Temperature | A-6  |
| Charger Mode                                 | A-6  |
| <b>B Battery Charging Reference</b>          |      |
| Charging Algorithms (Formulas)               | B-2  |
| Battery Type                                 | B-2  |
| Charge Algorithm Stages                      | B-2  |
| Three-stage charging                         | B-2  |
| Bulk Charge                                  | B-3  |
| Absorption Charge                            | B-3  |
| Float Charge                                 | B-4  |
| Equalization Charge                          | B-4  |
| Two-Stage Charging                           | B-5  |
| Charge Algorithm Graph                       | B-6  |
| Charge Algorithm Definitions                 | B-6  |
| AC Reconnect Summary                         | B-7  |
| <b>C Terminology</b>                         |      |
| Glossary                                     | C-2  |
| Abbreviations                                | C-5  |



---

|   |      |
|---|------|
| <b>Warranty and Product Information</b> ----- | WA-1 |
| Warranty-----                                 | WA-1 |
| Return Procedure-----                         | WA-3 |
| Out of Warranty Service-----                  | WA-4 |
| Information About Your System-----            | WA-4 |
| <b>Index</b> -----                            | IX-1 |



# Figures

|             |   |      |
|-------------|---|------|
| Figure 1-1  | Typical Xanbus System Diagram-----                  | 1-5  |
| Figure 1-2  | Front Panel of the RS2000 -----                     | 1-7  |
| Figure 1-3  | Front Panel Lights and Buttons -----                | 1-8  |
| Figure 1-4  | Completed Connections on Side Panel -----           | 1-9  |
| Figure 1-5  | Battery Terminal Covers -----                       | 1-11 |
| Figure 1-6  | Battery Temperature Sensor -----                    | 1-11 |
| Figure 2-1  | System Control Panel -----                          | 2-3  |
| Figure 2-2  | System Control Panel -----                          | 2-6  |
| Figure 2-3  | Operate Mode-----                                   | 2-7  |
| Figure 2-4  | Power Save Mode -----                               | 2-8  |
| Figure 2-5  | Select Device Menu-----                             | 2-9  |
| Figure 2-6  | System Settings Menu -----                          | 2-10 |
| Figure 2-7  | Safe Mode -----                                     | 2-10 |
| Figure 2-8  | Battery Temperature Sensor -----                    | 2-15 |
| Figure 2-9  | Equalize On -----                                   | 2-17 |
| Figure 2-10 | Equalize Confirmation Warning -----                 | 2-18 |
| Figure 2-11 | Equalization Home Screen -----                      | 2-18 |
| Figure 2-12 | Equalize Cancellation Warning -----                 | 2-19 |
| Figure 3-1  | System Menu Map -----                               | 3-3  |
| Figure 3-2  | RS2000 Float System Screen (Example)-----           | 3-4  |
| Figure 3-3  | Select Device Menu-----                             | 3-4  |
| Figure 3-4  | RS2000 Basic Menu in Invert Mode-----               | 3-5  |
| Figure 3-5  | RS2000 Menu -----                                   | 3-7  |
| Figure 3-6  | RS2000 Menu Structure — Overview -----              | 3-8  |
| Figure 3-7  | Invert Mode -----                                   | 3-9  |
| Figure 3-8  | Equalize On -----                                   | 3-14 |
| Figure 3-9  | Equalize Confirmation Warning -----                 | 3-14 |
| Figure 3-10 | Equalization System Home Screen-----                | 3-15 |
| Figure 3-11 | Equalize Cancellation Warning -----                 | 3-15 |
| Figure 3-12 | Highlighting System on the Select Device Menu ----- | 3-21 |
| Figure 3-13 | Highlighting Global Menus -----                     | 3-21 |
| Figure 3-14 | Restore Defaults Warning-----                       | 3-29 |
| Figure A-1  | Inverter Output Power vs Ambient Temperature -----  | A-6  |
| Figure B-1  | Three-stage Charging Profile -----                  | B-6  |



# 1

## Introduction

Congratulations on your purchase of the RS2000 Sine Wave Inverter/Charger.

The RS2000 has been designed to give you premium power, ease of use, and outstanding reliability.

Please read this chapter to familiarize yourself with the main performance and protection features of the RS2000.

---

## About the RS2000 Sine Wave Inverter/Charger

The RS2000 Sine Wave Inverter/Charger is a convenient combination of an inverter, multistage battery charger, and transfer switch in one electronic device.

- As an inverter, the RS2000 provides sine wave power for your microwave, entertainment system, computer, and other loads. This power is identical to the AC source provided from the utility grid (power company).

Some of the benefits of sine wave power include consistent cooking in your microwave, handling of sensitive loads such as your TV set, dimmer switches, and appliances with speed controls.

- As a 100 amp charger, the RS2000 quickly and completely recharges your batteries.
- The built-in transfer switch automatically transfers between inverter power and incoming qualified AC power.

### Premium Power and Ease of Use

For managing your onboard power system, the RS2000 provides superior features and rugged durability combined with ease of use:

- 2000 watt inverter/charger with 5000 watt surge for 5 seconds
- Three-stage charge with 100 amps of output and charge formulas for flooded, gel, and AGM deep cycle batteries plus equalization for flooded batteries
- Sine wave output powers sensitive entertainment electronics
- Built-in 30 amp transfer switch provides automatic transfer between AC input and inverter power
- Easy-to-read indicator lights on the front panel
- Automatic cooling fans
- Power sharing reduces charging current to prevent tripping of AC input breaker

---

## How RS2000 Works

The RS2000 is designed to:

- invert
- charge

With AC input available from the utility grid or a generator, power is passed through the RS2000 Sine Wave Inverter/Charger to operate connected AC loads. The remaining AC power not used by loads is converted to DC power and used to charge batteries.

If AC input power becomes disconnected, fails, or falls out of specification and is no longer qualified as good AC, a quick transfer takes place and the RS2000 begins converting DC power from the batteries into AC power, with no interruption in power supplied to the AC loads.

### Inverting

The RS2000's inverting function:

- produces 120 volts AC from your batteries
- delivers 2000 watts of power on a continuous basis and 5000 watts of surge power to start loads like pumps and refrigerators.

To prevent power being drawn needlessly from the batteries, Xantrex® has included the load sensing feature.

**Load Sense Mode** To reduce battery draw, you can turn on Load Sense Mode with the System Control Panel. In Load Sense Mode, the inverter/charger periodically sends out a search pulse to see whether a load is present. If it finds a load, the inverter/charger will turn on. You can adjust the interval between load sense pulses, and you can also adjust the load power at which the inverter will turn on. If no load is found, then the inverter will continue in load sense mode, which reduces the inverter draw from the battery to a minimum.

In Load Sense mode, there's a short delay—up to the interval you've set—between the time you turn on a load and the time the inverter/charger delivers power. Load Sense mode can be disabled at any time if you find the delay to be inconvenient.

### Charging

The RS2000's charging function:

- produces 100 amps to charge your batteries
- equalizes flooded, lead acid batteries

**Built-in Charge Formulas** For the inverter to perform at the highest level, the batteries must be charged correctly. The RS2000 has optimized algorithms for flooded, gel, and AGM batteries.

**Battery Temperature Sensor** Since battery temperature is a key factor in correct charging, the charging formula must be adjusted (automatically and in real time) according to the actual battery temperature to ensure that batteries are fully charged, but not overcharged. For this reason, Xantrex has included a battery temperature sensor with your RS2000 Sine Wave Inverter/Charger and has temperature compensated the charge formula.

**Manual Equalization** Over a period of time, the cells in a flooded battery can develop uneven chemical states. This can result in a weak (undercharged) cell which, in turn, can reduce the overall capacity of the battery. To improve the life and performance of a non-sealed, flooded battery, the RS2000's multi-stage charging cycle includes a manual equalize mode that can be used, if recommended by the battery manufacturer.

**Dead Battery Charging** Another feature that the RS2000 includes is dead battery charging. The RS2000—unlike many chargers— has the ability to recharge batteries even if the battery voltage is very low.

**Load Management** The RS2000 has a built-in transfer relay that connects AC input from the utility grid, generator, or inverter output to your loads. Because the usual AC power sources such as campground outlets or small generators often have limited current availability, having the capability to manage your AC loads is extremely valuable. The RS2000 provides a number of features to facilitate this:

- The charger is power factor corrected to use AC current as efficiently as possible and only requires 15 amps to provide rated charger output. Minimizing the AC current used by the charger means more current is available for your AC loads.
- RS2000 uses a power share feature which monitors the AC load on the system. It reduces the charge current and gives priority to the AC load to avoid nuisance tripping of the breaker.
- Occasionally, AC input sources have low voltage. To avoid loading these weak sources any further, the charger automatically reduces its AC current draw as the AC voltage approaches the minimum acceptable level.



## Xanbus System

The RS2000 is the device in a Xanbus® system that typically provides network power—800 mA at 15 volts DC. All of the Xanbus-enabled devices, such as the RS2000, the System Control Panel (SCP), and the Automatic Generator Start (AGS) are able to communicate their settings and activity to each other. See Figure 1-1.

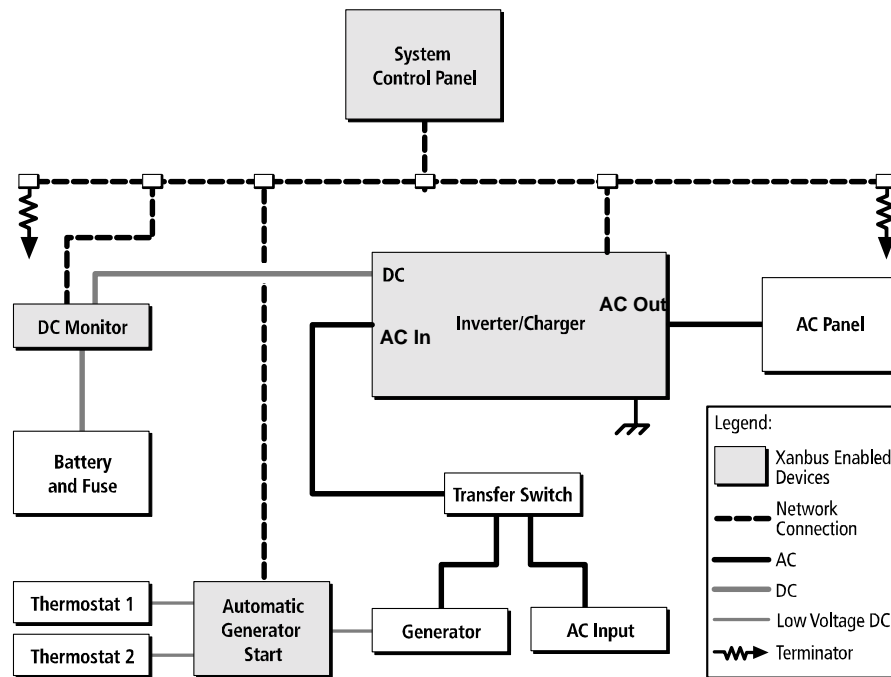

Figure 1-1 Typical Xanbus System Diagram

## Xanbus Enabled

The Xanbus-enabled designation means that this product works on a Xanbus network. Xanbus-enabled products are:

- Easy to use. The Xanbus network simplifies operation and automates routine tasks.
- Reliable. Software control eliminates errors due to analog signalling.
- Accurate. Digital information is less susceptible to interference and line loss.
- Upgradeable. Software upgrades mean your purchase will remain up to date.

For detailed instructions and a complete list of Xanbus-enabled devices, visit [www.xantrex.com](http://www.xantrex.com)



---

## Comprehensive Electronic Protection

RS2000 is approved to meet a number of safety standards including UL 458, 4th edition, and CSA C22.2 No. 107.1. See “Regulatory Approvals” on page A-5 for more information.

RS2000 is equipped with numerous protection features to ensure safe operation.

| Protection feature               | This feature...  |
|----------------------------------|--|
| Battery over-voltage protection  | Keeps the battery voltage from getting too high in charge mode. Shuts the inverter off in invert mode.   |
| Battery under-voltage protection | Prevents inverter from discharging your batteries too low. The inverter doesn't run if battery voltage is too low.   |
| Over-temperature protection      | Protects the unit from overheating by either derating (charge mode) or by shutting down (invert mode). See “Invert Power Derating vs Ambient Temperature” on page A-6.   |
| Automatic over load protection   | Protects the unit from excessive loads. The unit will provide 5000 watts (2.5 times of the rated load) for up to 5 seconds, and then protect itself by shutting down. See Specifications on page A-2 for more information. |
| Short circuit protection         | Detects short circuits and protects the unit by shutting it down.  |

# RS2000 Features

## Front Panel Features

Before you begin to operate the RS2000, review the front panel features shown in Figure 1-2 and described in Table 1-1. A detailed view of the lights and buttons on the front panel is shown in Figure 1-3 and described in Table 1-2.

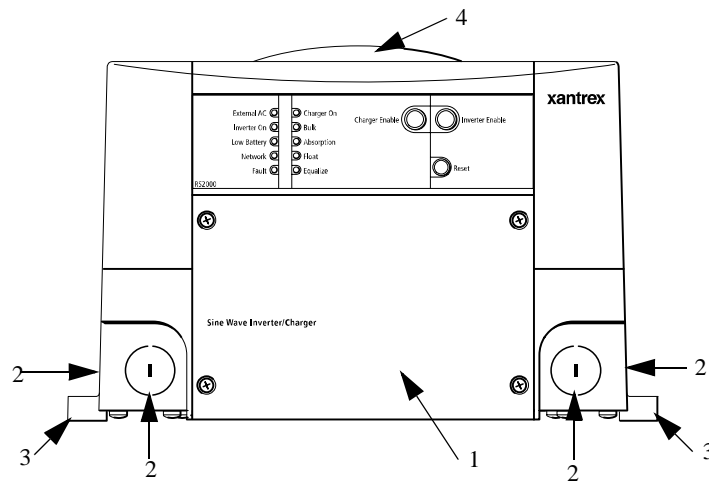
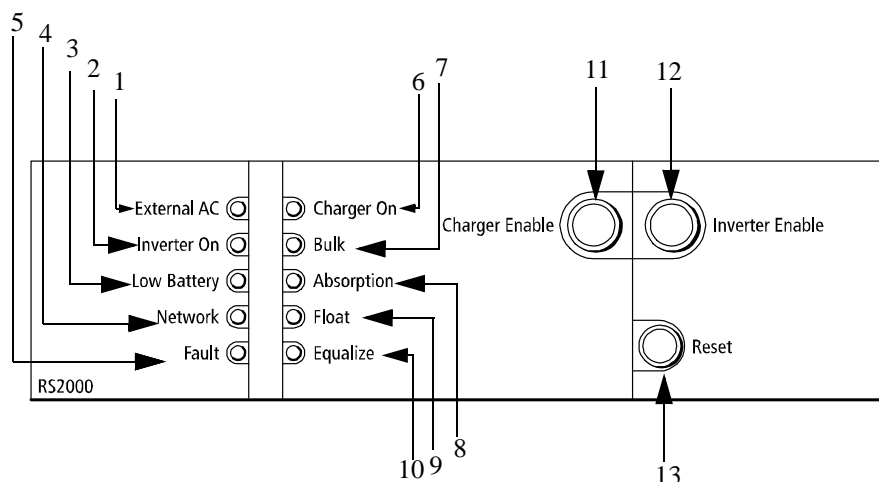

Figure 1-2 Front Panel of the RS2000

Table 1-1 Front Panel Features

| Feature | Description   |
|---------|---|
| 1       | <b>AC wiring compartment access panel</b> provides access to the terminal block for wiring the AC input and AC output.  |
| 2       | <b>AC knockouts</b> provide access for AC input and AC output wiring. A total of four knockouts are provided on the unit: two on the front and one on each side (not shown).  |
| 3       | <b>Mounting flanges</b> are used for mounting the unit. A total of six flanges are provided on the unit.  |
| 4       | <p><b>Fans</b> are located on the top of the unit and the bottom of the unit.</p> <ul style="list-style-type: none"> <li>• Top external fan is an intake fan that activates when the internal temperature of the inverter/charger increases. The fan speed varies with the internal temperature and turns off when the inverter/charger cools down. (This internal temperature may be caused by heat in the inverter/charger or by high ambient temperature.)</li> <li>• Bottom internal fan (not shown) is an exhaust fan and runs continuously if the unit is inverting or charging.</li> </ul> |



**Figure 1-3** Front Panel Lights and Buttons

**Table 1-2** Description of Front Panel Lights and Buttons

| Feature | Description  |
|---------|--|
| 1       | <b>External AC light</b> illuminates when you are connected to an AC source like the utility grid or a generator and the AC is qualified.  |
| 2       | <b>Inverter ON</b> light illuminates when the RS2000 is operating in invert mode.  |
| 3       | <b>Low Battery</b> light illuminates when the battery voltage is low.  |
| 4       | <b>Network</b> light illuminates when there is activity on the network.  |
| 5       | <b>Fault</b> light illuminates if a fault condition occurs.  |
| 6       | <b>Charger ON</b> light illuminates when the RS2000 is in charge mode and is producing DC output to charge your batteries.   |
| 7       | <b>Bulk</b> light illuminates when the charger is in the bulk stage of battery charging.   |
| 8       | <b>Absorption</b> light illuminates when the charger is in the absorption stage of battery charging.   |
| 9       | <b>Float</b> light illuminates when the charger is in the float stage of battery charging.   |
| 10      | <b>Equalize</b> light illuminates when the unit is equalizing the batteries.   |
| 11      | <b>Charger Enable</b> button toggles between enable (On) and disable (Off). When the charger is enabled, it can produce DC output to charge your batteries. When the charger is disabled, it does not produce DC output to charge your batteries, but still passes AC input through to AC loads (if present).          |
| 12      | <b>Inverter Enable</b> button toggles between enable (On) and disable (Off). When the inverter is enabled, it can produce AC output to run your AC loads. When the inverter is disabled, it does not produce AC output to run your loads; however, if qualified AC is present, the unit passes AC through to AC loads. |
| 13      | <b>Reset</b> button is used for several functions: to reset after a fault, to perform a power on reset, to wake the RS2000 from Power Save mode or Hibernate mode. See “System Modes” on page 2–6 for a description of the different modes.  |

## Side Panel Features



### CAUTION: Equipment Damage

Connect only to other Xanbus compatible devices.

Although the cabling and connectors used in this network system are the same as Ethernet connectors, **this network is not an Ethernet system**. Equipment damage may result from attempting to connect two different systems.

For your reference, the side panel features with all connections completed is shown in Figure 1-4.

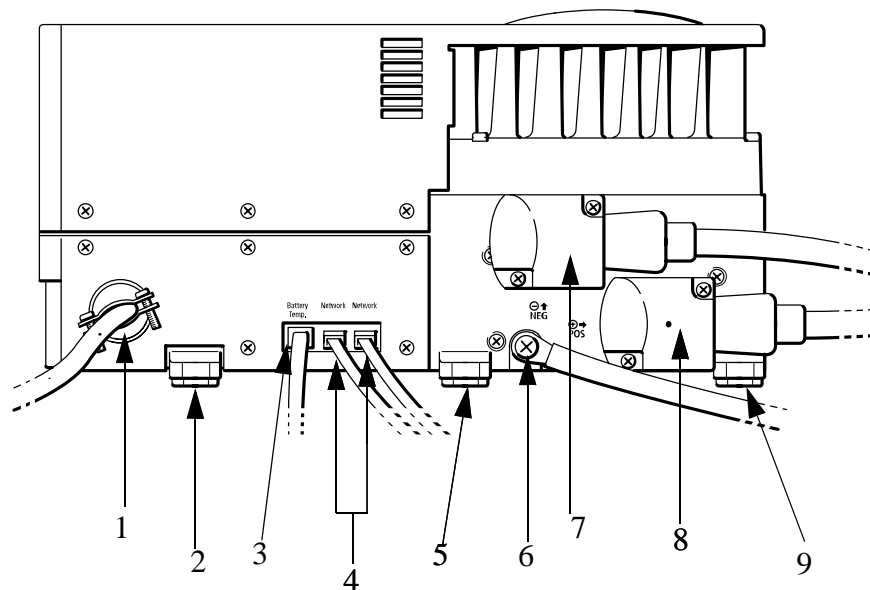

Figure 1-4 Completed Connections on Side Panel

Table 1-3 Description of Side Panel Features

| Feature | Description  |
|---------|--|
| 1       | <b>AC knockout</b> provides access for AC input and AC output wiring (shown with strain-relief clamp installed). There are four knockouts on the unit: two on the front and two on the side. |
| 2, 5, 9 | <b>Mounting flanges</b> are used for mounting the unit. A total of six flanges are on the unit.  |
| 3       | <b>Battery temperature sensor jack</b> provides connection for the battery temperature sensor.   |

---

**Table 1-3** Description of Side Panel Features

| Feature | Description   |
|---------|---|
| 4       | <b>Dual network jacks</b> provide connection for network-enabled devices. (The number of connections depends on your layout. Your connections may not be the same as shown here.) |
| 6       | <b>Chassis ground point</b> connects the chassis of the RS2000 to your system's chassis grounding point.  |
| 7 & 8   | <b>DC terminals – negative (black) (7) and positive (red) (8)</b> —shown here with DC covers on.  |

## DC Terminal Covers and Battery Temperature Sensor

### DC Terminal Covers

Two covers are supplied to prevent accidental contact with the cabling connectors after installation. The red cover is for the positive cabling terminal, and the black cover is for the negative cabling terminal.

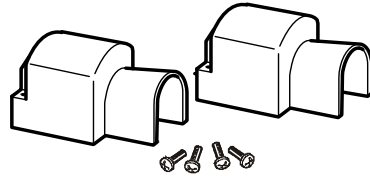

Figure 1-5 Battery Terminal Covers

### Battery Temperature Sensor

The battery temperature sensor continuously measures the temperature of the battery and adjusts the charger output for a more accurate, temperature-compensated charge.

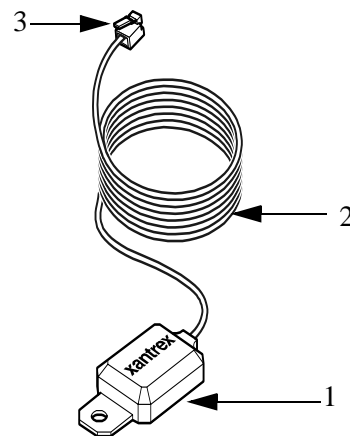

Figure 1-6 Battery Temperature Sensor

Table 1-4 Description of Battery Temperature Sensor Features

| Feature | Description   |
|---------|---|
| 1       | <b>Sensor</b> can be mounted on the side of the battery case or on the negative battery terminal. |
| 2       | <b>Sensor cable</b> is 25 feet (7.6 meters).  |
| 3       | <b>Connector</b> plugs into the Battery Temp. jack (battery temperature sensor) on the RS2000.    |

## System Accessories and Network Components

System accessories can be used with the RS2000 in a Xanbus system. The System Control Panel (SCP) provides configuration and monitoring capability for Xanbus-enabled devices such as the RS2000. Automatic Generator Start (AGS) automatically starts and stops your generator. It continuously monitors your battery system and thermostats and starts the generator if the battery state of charge or the voltage reaches preset limits, or the air conditioner or heater needs to be run.

Table 1-5 provides the part numbers for the system accessories.

**Table 1-5** System Accessories

| Accessory                       | Part number |
|---------------------------------|-------------|
| System Control Panel (SCP)      | 809-0910    |
| Automatic Generator Start (AGS) | 809-0915    |

Consult with your local system designer to determine what network components will be needed for your specific installation. Table 1-6 provides a list of network components and part numbers. Pre-made cables are available in standard lengths ranging from 3 feet to 75 feet.

**Table 1-6** Network Components and Part Numbers

| Network Component                         | Part Number |
|---|-------------|
| Network termination — Male (2 per pack)   | 809-0901    |
| 3-way network connector                   | 809-0903    |
| Network termination — Female (2 per pack) | 809-0905    |
| Network cable 3 ft. (0.9 m)               | 809-0935    |
| Network cable 5 feet (1.5 m)              | 809-0936    |
| Network cable 7 feet (2.0 m)              | 809-0937    |
| Network cable 10 feet (3.0 m)             | 809-0938    |
| Network cable 14 feet (4.3 m)             | 809-0939    |
| Network cable 25 feet (7.6 m)             | 809-0940    |
| Network cable 50 feet (15.2 m)            | 809-0941    |
| Network cable 75 feet (22.9 m)            | 809-0942    |

These accessories and network components are available from any authorized Xantrex dealer or at **www.xantrex.com**. Detailed information on planning and installing your network is available in the *Xanbus System Installation Guide*. This guide is available for downloading at **www.xantrex.com**



# 2

## Operation

Chapter 2, “Operation” contains information and procedures for using your RS2000. This chapter begins with a system startup check that you carry out after installation and configuration to verify that the RS2000 is operating correctly.

If you’re using the System Control Panel to operate or monitor the status of the unit, also refer to the *System Control Panel Owner’s Guide*.



### **WARNING: Restrictions on use**

RS2000 Sine Wave Inverter/Charger shall not be used in connection with life support systems or other medical equipment or devices.

---



### **CAUTION**

Read this chapter before operating the RS2000 Sine Wave Inverter/Charger.

---

---

## Operating the RS2000 with the System Control Panel

The System Control Panel (SCP) provides operating, configuration, and monitoring capability for your Xanbus system.

The System Control Panel:

- Monitors activity throughout your onboard power system
- Displays the latest information about your inverter/charger, battery charge level, battery charge output, and generator start and stop activity.
- Displays the settings for each Xanbus-enabled device in the system
- Enables you to adjust the settings for each Xanbus-enabled device in the system.
- Preserves all of its settings in non-volatile memory if system power is interrupted. After power is restored, you don't have to reconfigure the SCP or any of the Xanbus-enabled devices connected to it.

This section provides information on operating the RS2000 with the System Control Panel. Please refer to the *System Control Panel Owner's Guide* for complete information on using the System Control Panel.

---

**Important:** Any RS2000 setting changed from the System Control Panel will be saved if the unit is shut down by selecting Power Save mode, Safe mode or Hibernate mode. See "*System Modes*" on page 2-6 for more information about the different types of modes.

---

## Using the System Control Panel

- The System Control Panel has important features which you'll want to be familiar with, as shown in Figure 2-1.
- Display screen System information is shown on the display screen with an adjustable backlight.
  - Indicator lights Four indicator lights on the front panel indicate the operating status of the Xanbus system.
  - Push buttons Four push buttons allow you to select device menus and change or display settings. The red System button toggles the System Control Panel and Xanbus-enabled devices between Operate mode and Power Save mode. For more information on the different system modes, see "System Modes" on page 2-6.

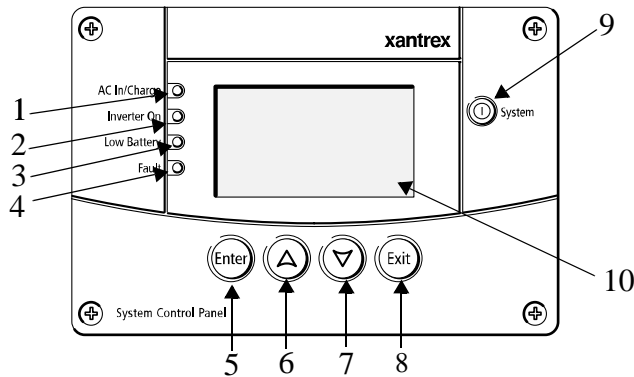

Figure 2-1 System Control Panel

Table 2-1 System Control Panel Features and Buttons

| Feature | Description   |
|---------|---|
| 1       | <b>AC In/Charge light</b> indicates that qualified AC is present at the input of an inverter/charger. When the RS2000 is connected to a qualified AC source like the utility grid or a generator, this light on the System Control Panel illuminates. |
| 2       | <b>Inverter On light</b> illuminates when the RS2000 is enabled (turned on).  |
| 3       | <b>Low Battery light</b> illuminates when the battery voltage on the RS2000 is low.   |

**Table 2-1** System Control Panel Features and Buttons

| Feature | Description  |
|---------|--|
| 4       | <b>Fault light</b> indicates a condition that requires user attention and intervention. The Fault light illuminates when any Xanbus-enabled device connected to the network is in fault. See “Faults and Warnings” on page 4–2 for the definitions of a fault and warning. |
| 5       | <b>Enter button</b> <ul style="list-style-type: none"> <li>• Confirms selection of a menu item.</li> <li>• Moves you to the next screen.</li> </ul>  |
| 6       | <b>Up arrow button</b> <ul style="list-style-type: none"> <li>• Scrolls up one line of text.</li> <li>• Increases a selected value.</li> </ul>   |
| 7       | <b>Down arrow button</b> <ul style="list-style-type: none"> <li>• Scrolls down one line of text.</li> <li>• Decreases a selected value.</li> </ul>   |
| 8       | <b>Exit button</b> <ul style="list-style-type: none"> <li>• Cancels selection of a menu item.</li> <li>• Returns you to the previous screen.</li> </ul>  |
| 9       | <b>System button:</b> <ul style="list-style-type: none"> <li>• Toggles all Xanbus-enabled devices on the system between Operate mode and Power Save mode. See “System Modes” on page 2–6.</li> </ul>   |
| 10      | <b>Screen</b> displays menus, settings, and system information.  |

## On Start Up

When the RS2000 is powered up or comes out of a reset state, all of the front panel lights illuminate and remain on for a minimum of five seconds. After five seconds, the lights remain illuminated until the front panel has status information for all the lights.

The RS2000 is disabled every time the unit is powered up. The inverter must then be enabled. When a function is disabled, it is not allowed to occur and if it is occurring, it is terminated. Regardless of other conditions, the function will not be activated. For example, even if AC power is present, if the charger is disabled, the unit will not charge.

When a function is enabled, it is allowed to occur but other conditions may have to be met before the function is activated or turned on. For example, the charger function on the RS2000 may be enabled, but it will not charge unless qualified AC power is present.

---

## System Start-up Check

---



### WARNING

Review the “Important Safety Instructions” on page vii before operating the inverter/charger.

---

#### **To test the charging and inverting functions from the RS2000 front panel:**

1. Disconnect AC power from inverter input by opening the breaker or disconnect. Press the Inverter Enable button on the RS2000. The Inverter On light illuminates.
2. Place a load on the inverter. For example, plug a 100 watt light bulb into an outlet that the inverter is powering and make sure it works. The inverter should run the load using battery power.
3. To test the charger, reconnect the AC input power to allow AC to the AC input. The Charger On light should illuminate after a brief delay. Any AC loads previously powered by the inverter will also work at this time.
4. Remove the AC input power. The inverter/charger should transfer to invert mode immediately. (The transfer relay will make a clicking sound and the Inverter On light will illuminate.) Loads should continue to operate uninterrupted.

#### **To test the transfer switch:**

1. Press the Inverter Enable button on the unit to disable. The Inverter On light is not illuminated.
2. Apply qualified AC power to the RS2000 input. After a brief delay, the External AC light should illuminate and AC loads on the output should operate.

If any part of this procedure fails, determine the cause before using the inverter/charger. Consult the “Troubleshooting” chapter starting on page 4-1.

## System Modes

This section provides an overview of the four different system modes.

The system modes described in this section affect the performance and behavior of the RS2000 and all other Xanbus-enabled devices on the Xanbus system. You'll have to change the system mode when travelling, putting your vehicle in storage, or when installing a Xanbus-enabled device.

You can change system modes using the System Settings menu on the System Control Panel.

You can also use the red System button on the System Control Panel to put the System Control Panel and all other Xanbus-enabled devices into Power Save mode only.

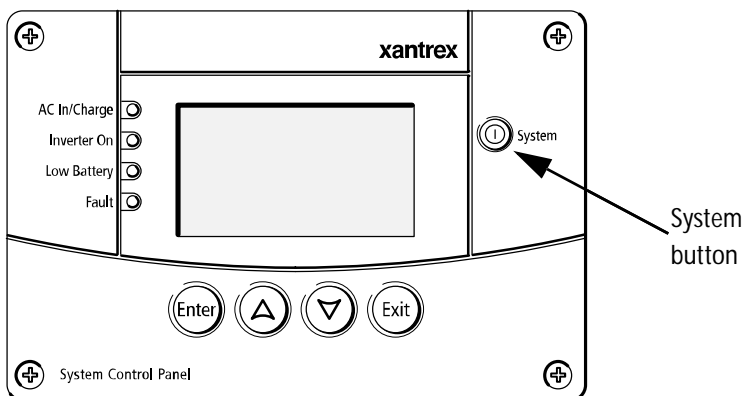

Figure 2-2 System Control Panel

System modes are changed using the System Settings menu. The four system modes are:

- Operate
- Power Save
- Safe
- Hibernate

Please read the section about each system mode to find out which mode is appropriate for different conditions or situations.

## Operate Mode

- Characteristics** In Operate mode, all communications are enabled on the Xanbus system. All power conversion functions are enabled. Each Xanbus-enabled device is monitoring and communicating its input.
- The basic state of the System Control Panel is Operate mode. In Operate mode, the System Control Panel communicates with other Xanbus-enabled devices and displays all the network information which it is configured to display.
- Whenever the System Control Panel or any other device on the Xanbus system is powered on or reset, it will be in Operate mode.

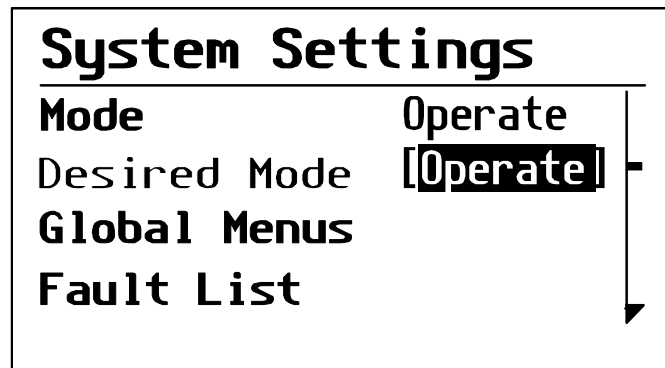

Figure 2-3 Operate Mode

## Power Save Mode

- Characteristics** Power Save mode minimizes power draw by the System Control Panel and other Xanbus-enabled devices on the Xanbus system. Power Save mode stops all communication on the network, and disables the power conversion functions of Xanbus devices. For example, in Power Save mode, the inverter/charger will not invert and an Automatic Generator Start will not start a generator.
- When to use** Use Power Save mode during periods when your power needs are minimal—while you are driving, for example. Putting the system in Power Save mode will help preserve the charge in your batteries during periods of minimal power usage.
- Entering and exiting Power Save mode also serves as a “reset” command for the system.
- If there are active faults in the system, you cannot put the system into Power Save mode. Clear any active fault, correct the condition that caused the fault, then put the system into Power Save mode.

**To enter or exit Power Save mode:**

- ◆ Press and hold the System button on the System Control Panel for one second.

After you release the System button, the System Control Panel screen and indicator lights will turn off.

You can also enter or exit Power Save mode on the System Settings menu by selecting Desired Mode and scrolling to PowerSave as shown in Figure 2-4.

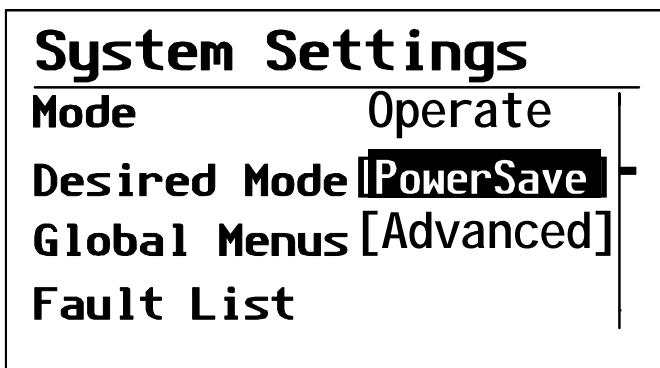

Figure 2-4 Power Save Mode

Returning to Operate mode

If an inverter/charger supplies power to the network, applying AC input with utility power or generator power automatically returns the system to Operate mode.

## Safe Mode



### CAUTION: Unexpected behavior

Before installing or removing a device on the network, put the network into Safe mode. This prevents unexpected behaviour.

---

Characteristics

Selecting Safe mode stops the generator (if it is running) and puts the System Control Panel (and all Xanbus-enabled devices) into Safe mode. While in Safe mode, the System Control Panel remains powered, “listening” to and reporting its status to the network. However, the output power of all Xanbus-enabled devices is disabled and all inverting, charging, and generator starting activity stops. In Safe mode, the RS2000 will not pass AC.



## When to use

In Safe mode, the RS2000 continues to communicate, but the inverting and charging functions are disabled.

Use Safe mode when you are adding or removing devices from the network. Authorized service personnel must also put the System Control Panel in Safe mode before performing software upgrades and diagnostics with the Xantrex Diagnostic Tool.

If the System Control Panel is powered off while in Safe mode, it will be in Safe mode when it is powered up again.

**To return to Operate mode:**

- ◆ On the System Settings menu, under Desired Mode, select “Operate.”

## Putting the System into Safe Mode

When you are installing or removing devices from the Xanbus system, putting the system into Safe mode prevents unexpected behavior.

**To enter Safe mode:**

1. On the Select Device menu, use the down arrow button to highlight System.

The cursor on the right of the screen indicates where you are in the menu.

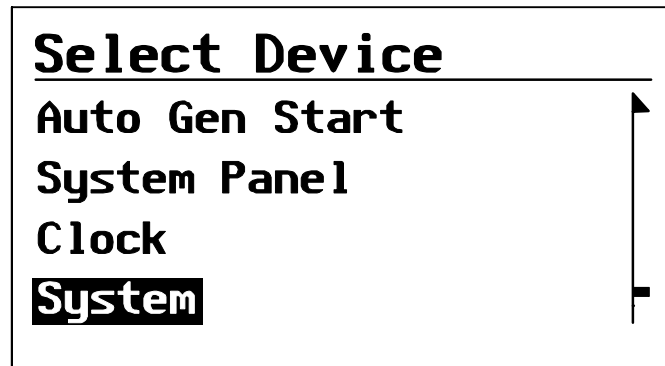

Figure 2-5 Select Device Menu

2. Press Enter.  
The System Settings menu appears.

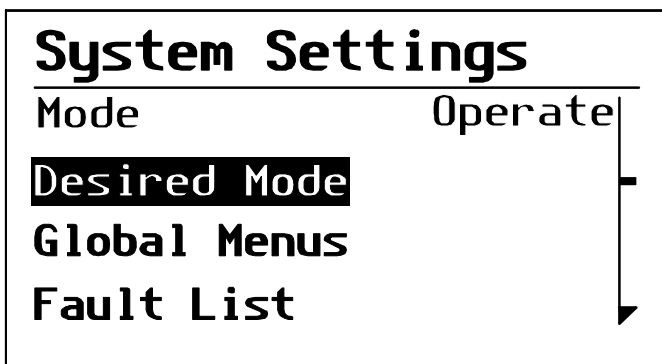

Figure 2-6 System Settings Menu

3. On the System Settings menu, with Desired Mode highlighted, press Enter.
4. Use the down arrow button to scroll through the other modes to select Safe mode.

For more information on the different system modes: Operate, Power Save, and Hibernate see “System Modes” on page 2–6.

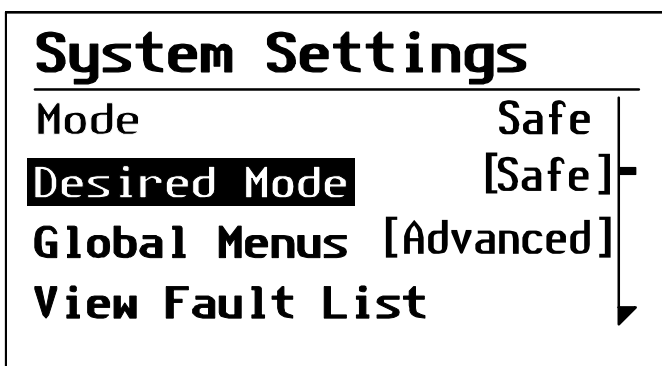

Figure 2-7 Safe Mode

5. Press Enter.  
You are now in Safe mode.
6. Press Exit twice to return to the System Home Screen.

**To exit Safe mode and return to Operate mode:**

1. On the System Settings menu, under Desired Mode, select “Operate.”
2. Press Enter.

---

## Hibernate mode

|                 |  |
|-----------------|--|
| Characteristics | Hibernate mode removes network power from the System Control Panel and all Xanbus-enabled devices on the Xanbus system. The System Control Panel suspends all operations (including starting and stopping the generator) until power is restored to the network. All Xanbus-enabled devices other than the RS2000 have no network power.   |
| When to use     | <p>Use Hibernate mode when the Xanbus system is left unattended for long-periods of time to prevent any unattended system activity and to prevent battery drain during long periods of inactivity.</p> <p>The system will automatically enter Hibernate mode if it is in Power Save mode for more than two hours.</p> <hr/> <p><b>Important:</b> To prevent any unattended system activity, put the system into Hibernate mode from the System Control Panel before putting your RV or boat into storage.</p> <hr/> <p>If there are active faults in the system, you cannot force the system into Hibernate mode. Clear any active faults, correct the condition that caused the fault, then put the system into Hibernate mode. The RS2000 can enter hibernate mode with an active fault.</p> |
| Restoring power | <p>Once in Hibernate mode, the System Control Panel cannot return the System to Operate mode. You must restore power to the network by pressing the Reset button on the RS2000 front panel for several seconds.</p> <p>If an inverter/charger supplies power to the network, you can bring the system out of Hibernate mode either by pressing the reset button on the inverter/charger front panel or by applying AC input with utility power or generator power.</p>   |

---

## Operation in Invert Mode

---



### WARNING

Review the “Important Safety Instructions” on page vii before operating the inverter/charger.

---

Once the inverter/charger is installed, you can operate it in invert mode.

#### To operate in invert mode from the front panel:

1. Press the Inverter Enable button on the RS2000.
2. If external AC is present, the External AC light illuminates. If AC is present and you want to run the inverter, remove AC so the inverter turns on.

Once the Inverter On light is on, the RS2000 inverter is ready to deliver AC power to the loads.

- ◆ To operate the inverter with the System Control Panel, refer to Chapter 3, “Configuration”.

---

**Important:** If you are having problems with any of your loads, refer to “Inverter Applications” on page 4–17.

---

## Load Sense Mode

The load sense mode of the RS2000 reduces battery power consumption in order to conserve battery capacity.

When the inverter is enabled, the inverter/charger can be configured to search for an acceptable AC load. (It does this when you enable (turn on) “Load Sense” on the RS2000 Advanced Menu on the System Control Panel and set the load sense power threshold “Sense Below.”)

The inverter output turns off if the unit doesn’t detect a load that meets the load sense parameters. When the load sense feature is disabled (turned off), the inverter is continuously on. When an acceptable load is detected, the inverter output is turned on and provide full output power.

The unit will “sleep” if it doesn’t detect a load that meets the load sense parameters. If a load exceeds the “Sense Below” threshold set in the RS2000 advanced menu, the RS2000 will “wake up” and deliver full power to the load.”

---

## Operating Limits for Inverter Operation

### Power Output

#### Temperature

The continuous output rating for the RS2000 is 2000 watts or 17 amps at 120 volts AC. The RS2000 can deliver this power in an ambient (surrounding) temperature up to 122 °F (50 °C). Above this temperature, you must reduce the power demand or the unit may shut down to protect itself against overheating.

As with all inverters, the amount of continuous power that the RS2000 can deliver without overheating is limited by the ambient air temperature. The RS2000 will operate and deliver its continuous power rating at higher temperatures, but the ambient temperature as well as the input voltage from the battery will limit the extent to which it can run continuously. Operating the inverter/charger in conditions outside of power and temperature limits will result in thermal shutdown and/or significantly decreased performance. In addition, operation in this range is outside the ratings covered by the regulatory approvals of the product. See “*Invert Power Derating vs Ambient Temperature*” on page A-6.

#### Difficulty on starting loads

The inverter/charger should be able to operate all AC loads rated at or below its power rating. Some high horsepower induction motors used in pumps and other motor-operated equipment require very high surge currents to start, and the inverter/charger may have difficulty starting these loads. See “Inverter Applications” on page 4-17.

If you have problems starting certain loads, ensure that:

- the battery connections are tight and clean
- the DC cabling is no longer than the recommended length. Refer to the *RS2000 Sine Wave Inverter/Charger Installation Guide* for this information.
- the AC wiring is of recommended size. Refer to the *RS2000 Sine Wave Inverter/Charger Installation Guide* for this information.
- the battery is of sufficient capacity and is fully charged.

---

## Operating in Charger Mode

---



### **WARNING: Explosive Gases**

Review the “Important Safety Instructions” on page vii before operating the inverter/charger. During charging, batteries may generate explosive gases. Thoroughly ventilate the areas around the batteries and ensure that there are no sources of flames or spark in the vicinity.

Study all battery manufacturer’s precautions such as removing or not removing cell caps while charging and the recommended rates of charge.

---

**Important:** If you are charging a non-sealed battery, ensure there is sufficient distilled water in each cell. The battery acid should be at the level specified by the battery manufacturer. This helps prevent over-heating and purges excessive gases from the cells. Do not overfill. For a battery without cell caps, follow the manufacturer’s recharging instructions carefully.

---

### **To operate the RS2000 in charger mode from the front panel:**

1. Connect AC input power.

The charger automatically starts up when qualified AC power is connected if the charger is enabled, or the charger is disabled but the Force Charge enable override is On. See “Force Charge” on page 3–25.

- The batteries are charged according to the two-stage or three-stage formula you have selected on the System Control Panel. (See “Battery Charging Reference” on page B–1 for more information on two-stage or three-stage charging.)
  - You can interrupt the charge cycle any time you desire by disabling the charger from the System Control Panel or by pressing the Charger Enable button (on the front panel of the RS2000) so it is no longer illuminated.
  - To maintain optimal performance in flooded batteries, an occasional equalize cycle may be required. See “Operating in Equalization Mode” on page 2–16.
  - While the batteries are being charged, you can monitor which stage they are in from the front panel of the RS2000 or from the System Control Panel.
- ◆ To operate the charger with the System Control Panel, refer to Chapter 3, “Configuration”.

---

## Charger Operation with Battery Temperature Sensor

Since battery temperature is a key factor in correct charging, the charging formula must be adjusted (automatically and in real time) according to the actual battery temperature to ensure that batteries are fully charged, but not overcharged. For this reason, Xantrex has included a battery temperature sensor (see Figure 2-8) with your RS2000 Sine Wave Inverter/Charger and has temperature compensated the charge formula.

The battery temperature sensor continuously measures the temperature of the battery and adjusts charger output for a more accurate, temperature-compensated charge.

When batteries are cold, their chemical reaction is sluggish, meaning they don't absorb charge as easily. Thus a charge level optimized for room temperature will not charge the batteries sufficiently if they are cold. The charger must compensate by increasing its voltage to achieve the compensated equivalent of a room temperature charge. If the batteries are hot, the chemical reaction is hyperactive and they absorb energy too easily; thus a standard room-temperature charge would tend to overcharge a hot battery. Therefore, the charger compensates by reducing its voltage.

The battery temperature sensor automatically, and in real time, makes adjustments to the charger's voltage setpoints to properly charge your batteries. The actual charge compensation formula can be found on page A-3.

---

**Important:** It is normal to see a voltage that is different than the specified setpoint when charging if the battery case temperature is above or below 77 °F (25 °C)

---

If a battery temperature sensor is not present, the RS2000 uses the cold, warm, and hot settings. Charging may not be effective at extreme temperatures. See "Charger Specifications" on page A-3.

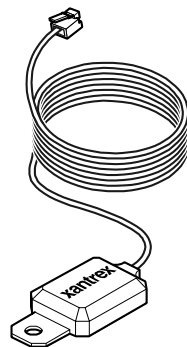

Figure 2-8 Battery Temperature Sensor

---

## Operating in Equalization Mode

---



### **WARNING: Explosive gases**

Equalization generates explosive gases. Ensure adequate ventilation.

---



### **CAUTION: Batteries may be damaged**

Sealed lead-acid batteries and gel batteries must NEVER be equalized or premature battery failure will result. Equalize mode is disabled if you have selected “Gel” and “AGM” as the battery type.

Only flooded (wet) lead-acid batteries should be equalized. As a general rule, do not equalize a battery unless there are provisions to add water to it and the manufacturer recommends equalization.

---



### **CAUTION: Batteries may be damaged**

If carried out too frequently or done improperly, equalization can damage your batteries. Never equalize a battery more than necessary. Always check electrolyte level before AND after equalization. Fill with distilled water per the battery manufacturer’s recommendation.

---



### **CAUTION: Risk of damage to DC load equipment**

Equalization voltage may be as high as 15.8 volts DC. Disconnect sensitive loads from the battery before equalizing.

---

Follow the battery manufacturer’s recommendations for equalizing your batteries. As a guide, a heavily used flooded battery may need to be equalized once a month, and a battery in light service may only need to be equalized every two to four months.

Measure the specific gravity (S.G.) of each cell using a hydrometer. For fully charged lead-acid batteries, the reading should be approximately 1.265. Low specific gravity after charging or a 0.25 difference from cell to cell indicates the need for equalization.



---

## Equalizing Batteries

---

**Important:** Equalization will be carried out after an absorption charge. Equalization only runs for 60 minutes and may need to be restarted if the specific gravity is still uneven.

---

**To equalize your batteries:**

1. Turn off or disconnect all loads on the battery.  
The voltage applied to the battery during equalization may damage your electronic equipment. As well, equalization won't proceed correctly if loads are drawing current from the battery.
2. Check electrolyte level.  
Fill with distilled water if the electrolyte level is low.
3. To request the equalization charge, ensure the Charger switch is enabled, and then scroll to the Equalize setting on the System Control Panel.
4. In the RS2000 home menu, highlight Equalize, as shown in Figure 2-9.

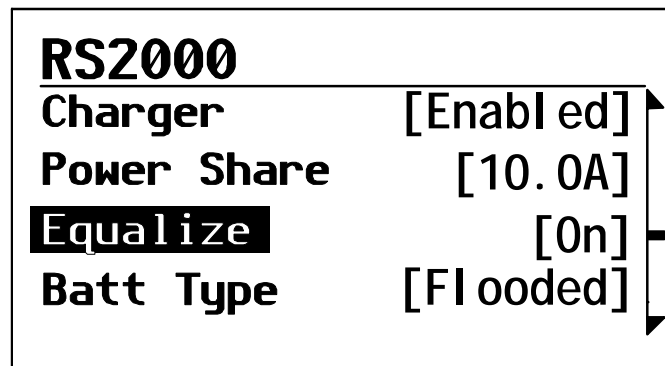

Figure 2-9 Equalize On

When you select On, the equalization confirmation warning appears, as shown in Figure 2-10.

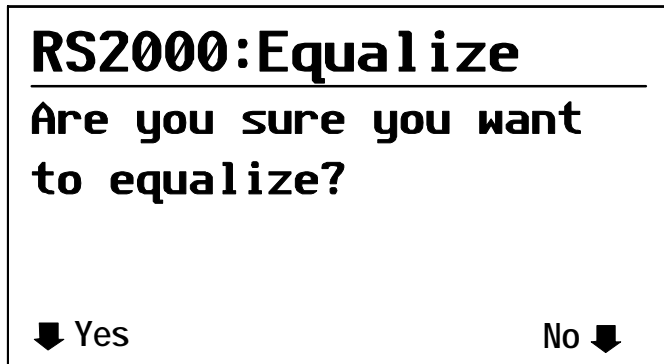

Figure 2-10 Equalize Confirmation Warning

Selecting Yes by pressing the Enter button takes you to the equalization system home screen, as shown in Figure 2-11.

OR

Selecting No by pressing the Exit button on Figure 2-10 takes you to the RS2000 device screen.

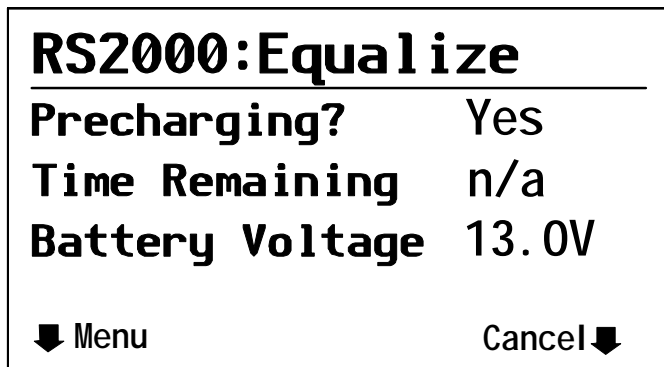

Figure 2-11 Equalization Home Screen

See Table 2-2 for an explanation of the equalize home screen content.

Table 2-2 Equalization Home Screen Content

| Equalization Home Screen content | Explanation of items displayed   |
|----------------------------------|--|
| Precharging                      | <ul style="list-style-type: none"> <li>• “Yes”—precharging occurs if batteries are not fully charged before equalization. Batteries must be fully charged before equalization.</li> <li>• “Done”—indicates the precharge is complete or if it was not required.</li> </ul> |



## Terminating the Equalization Process

The equalization process can be terminated in three ways:

- user cancellation from the System Control Panel as shown in Figure 2-12
- inverter/charger cancellation if AC is removed or the charger is disabled
- successful completion of the equalization process

## Operating Limits for Charger Operation

The maximum output current for the RS2000 is 100 amps. You can reduce the total output if you change the “Charge Rate” setting on the RS2000 Advanced Menu or the maximum Power Share setting on the RS2000 Basic Menu.

The charger can operate over an AC input range of 90–135 volts AC. This is the default setting and can be adjusted to 85–145 volts AC as a maximum range and to 110–120 volts AC as a minimum range. This wide range allows the RS2000 to charge your batteries even when incoming AC voltage is less than ideal.

## Power Share

The RS2000 charger shares incoming power with AC loads. The AC loads have priority, which means that the charger will reduce its output with large AC loads and increase the output again when the AC load decreases. The regulatory maximum for continuous AC loads is 80% of the breaker rating that the loads are connected to.

The RS2000 senses pass-through current going to the AC load. The difference between the pass-through (load) and 80% of the Power Share setting is the current that is available for charging the batteries.

For example, if the AC input of the RS2000 is from an AC panel with a 30A breaker, the Power Share setting on the System Control Panel should be selected as 30A. Based on this, the charger will control the charge current so that the total current draw is equal to or less than 24A in this case. Should the load current be more than 24A, the charger output will reduce to 0A, but the RS2000 will continue to supply the loads. The RS2000 will continue to pass-through power to the loads, even if the load current exceeds the Power Share setting. In this case, it will be up to the user to remove/disconnect loads if tripping the AC input breaker supplying the RS2000 is to be avoided.

## Monitoring the RS2000 Indicator Lights

The ten indicator lights on the front panel show you the operating status of the RS2000. A description of the lights is provided in Table 2-3.

If none of the front panel lights are on, see “Troubleshooting Reference” on page 4–4.

**Table 2-3** Front Panel Lights

| Light Illuminated  | Color  | Status  | Action or Status Item  |
|--------------------|--------|---|--|
| <b>External AC</b> | Green  | When the RS2000 is connected to a qualified AC source or a generator, the External AC light illuminates.  | You can run your appliances from an AC source like the utility grid or a generator.  |
| <b>Inverter ON</b> | Green  | When the RS2000 is enabled (on) and producing AC or load sensing, the Inverter ON light illuminates. This light is not illuminated if the unit is charging.   | You can run your appliances from the inverter.   |
| <b>Low Battery</b> | Yellow | When the Low Battery light illuminates, the battery level is low.   | You can run your appliances but your battery level is low. Charge your battery or connect to an AC source or turn off the inverter.                        |
| <b>Network</b>     | Green  | Indicates that there is activity on the network.  | Communication on the network   |
| <b>Fault</b>       | Red    | A fault has occurred on the network.  | Investigate and clear the fault condition.   |
| <b>Charger ON</b>  | Green  | When the RS2000 is in charge mode, the Charger ON light is illuminated. In three-stage charging, charging occurs in 3 stages: bulk, absorption, and float. One of these 3 lights will be illuminated at the same time the Charger ON light is illuminated.<br>If the Charger ON light is off, the RS2000 is not in any charge mode. | The charger is active and charging your batteries. The Charger ON light is always illuminated if charging, whether the unit is putting out current or not. |

**Table 2-3** Front Panel Lights

| Light Illuminated | Color  | Status  | Action or Status Item   |
|-------------------|--------|---|---|
| <b>Bulk</b>       | Green  | RS2000 is in bulk mode of battery charging.   | These lights indicate which state of charge the RS2000 is in. |
| <b>Absorption</b> | Green  | RS2000 is in absorption mode of battery charging.   |   |
| <b>Float</b>      | Green  | RS2000 is in float mode of battery charging. The Float light illuminates in three-stage charging. |   |
| <b>Equalize</b>   | Yellow | RS2000 is in equalize mode of battery charging.   |   |

## Faults and Warnings

A fault affects the operation of the unit. A manual fault requires user intervention by clearing the condition and then pressing the Reset button on the inverter/charger’s front panel. See the *System Control Panel Owner’s Guide* for information on clearing faults from the System Control Panel.

A warning alerts you to a condition that could possibly affect operation of the unit.

See “Faults and Warnings” on page 4–2 for more explanation on the difference between faults and warnings.

## Monitoring Status Messages on the System Control Panel

Refer to “System Menu Map” on page 3–3 of the Configuration chapter.

# 3

## Configuration

Chapter 3, “Configuration” contains information about all configurable settings and procedures for the RS2000.

## General Configuration Information

### System Control

All changes to the configuration of the RS2000 are made with the System Control Panel (SCP). The System Control Panel provides configuration and monitoring capability for all Xanbus-enabled devices on the network.

The front panel of the RS2000 provides limited control, including reset; charger enable and disable; and inverter enable and disable. When a function is disabled, it is not allowed to occur and if it is occurring, it is terminated. Regardless of other conditions, the function will not be activated. For example, even if AC power is present, if the charger is disabled, the unit will not charge.

When a function is enabled, it is allowed to occur but other conditions may have to be met before the function is activated or turned on. For example, the charger function on the RS2000 may be enabled, but it will not charge unless qualified AC power is present.

These functions can also be controlled from the System Control Panel.



# System Menu Map

Figure 3-1 provides a map of how the menus are organized. The order of devices appearing on the System Control Panel will vary, depending on the order in which they've been connected to the network.

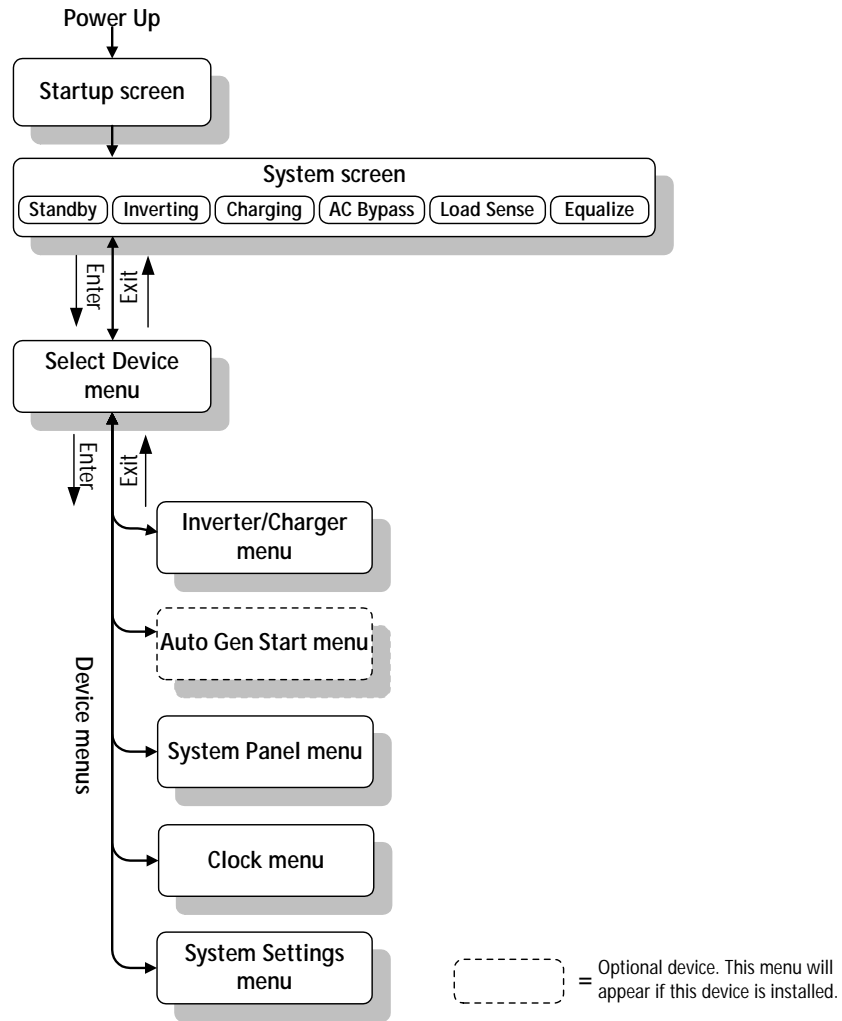

Figure 3-1 System Menu Map

## Viewing the System Screen

The System screen, as shown in Figure 3-2, is used to monitor system activity. You cannot select or change any of the information on the System screen. If you would like to view more detailed information, press menu to go to the Select Device menu.

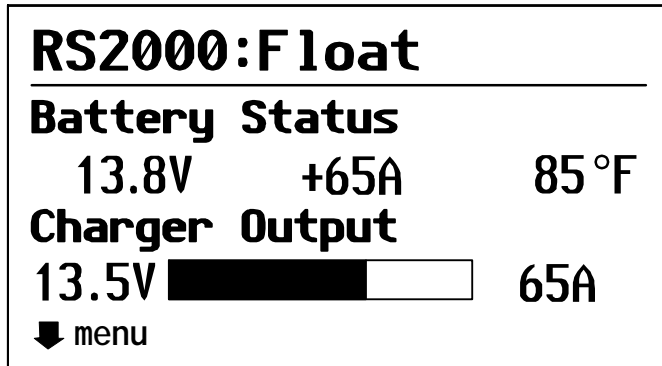

Figure 3-2 RS2000 Float System Screen (Example)

## Viewing the Select Device Menu

The Select Device menu is where you can view a list of all the Xanbus-enabled devices in your power system. The number of items appearing on the Select Device menu depends on how many devices are installed as part of your system.

**To view the Select Device menu:**

- ◆ On the System screen, press Enter.

The Select Device menu appears with RS2000 highlighted.

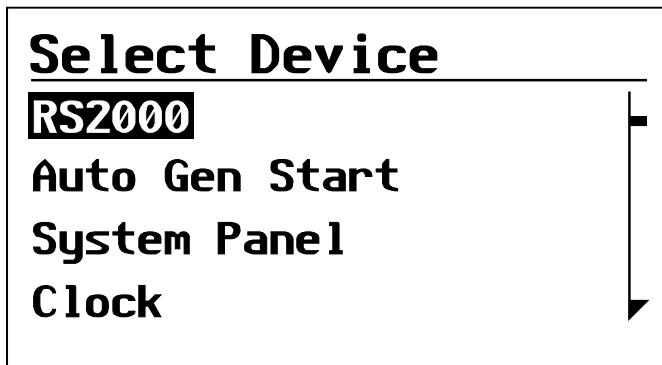

Figure 3-3 Select Device Menu

---

## Selecting the RS2000 Basic Menu

To select the RS2000 from the Select Device menu:

1. On the Select Device menu, RS2000 appears highlighted.
2. Press Enter. The RS2000 basic menu appears.

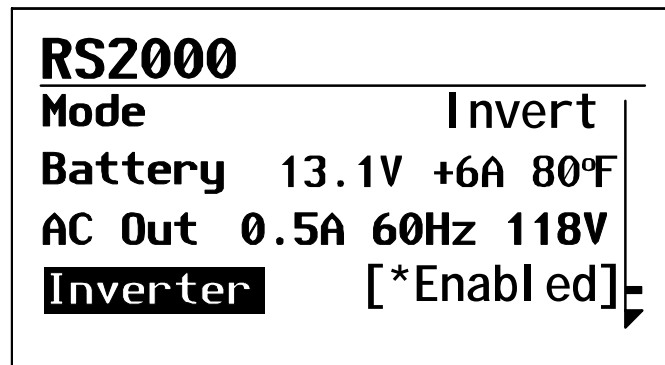

Figure 3-4 RS2000 Basic Menu in Invert Mode

## Selecting and Adjusting the Configurable settings

You can view RS2000 settings or change RS2000 settings from the RS2000 menu. Display settings show status items and cannot be changed. Configurable settings are indicated by square brackets [ ] and can be adjusted, as shown in Figure 3-4.

Follow these steps to change any RS2000 setting.

1. On the RS2000 menu, use the up arrow or down arrow button to highlight the setting you want to change.
2. Press Enter to highlight the value of that Configurable setting, indicated by square brackets [ ].

The previously set value appears with an asterisk beside it, as shown in Figure 3-4.

3. Use the up arrow or down arrow button to change the value. Holding down a button lets you scroll through values quickly.
4. Press Enter to select the value.
5. If you have another setting to change, return to step 1.

Or

If you have no more settings to change, press Exit to return to the Select Device menu.

---

## RS2000 Configuration Menus

The System Control Panel displays the RS2000 configuration menu in two formats: basic and advanced.

RS2000 basic menu list status information and settings you may have to adjust on a routine basis. It provides access to basic control of the inverter/charger.

RS2000 advanced menu settings require that you understand and plan for the changes you make. You may not have to adjust these settings as part of regular operation. Advanced Menu can be enabled or disabled through the System Control Panel. See “Selecting the RS2000 Advanced Menu” on page 3–21.

To access the RS2000 configurations menus, select the RS2000 menu, as shown in Figure 3-5.

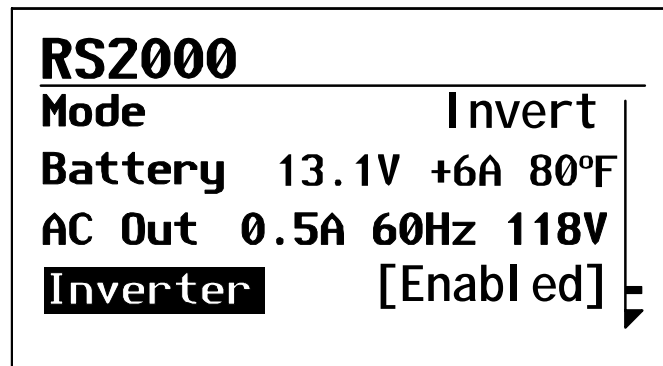

Figure 3-5 RS2000 Menu

The RS2000 menu structure is shown in Figure 3-6. The first four lines appearing in both menus: Mode, Battery, AC Input or AC Out, are status items only and are not configurable.

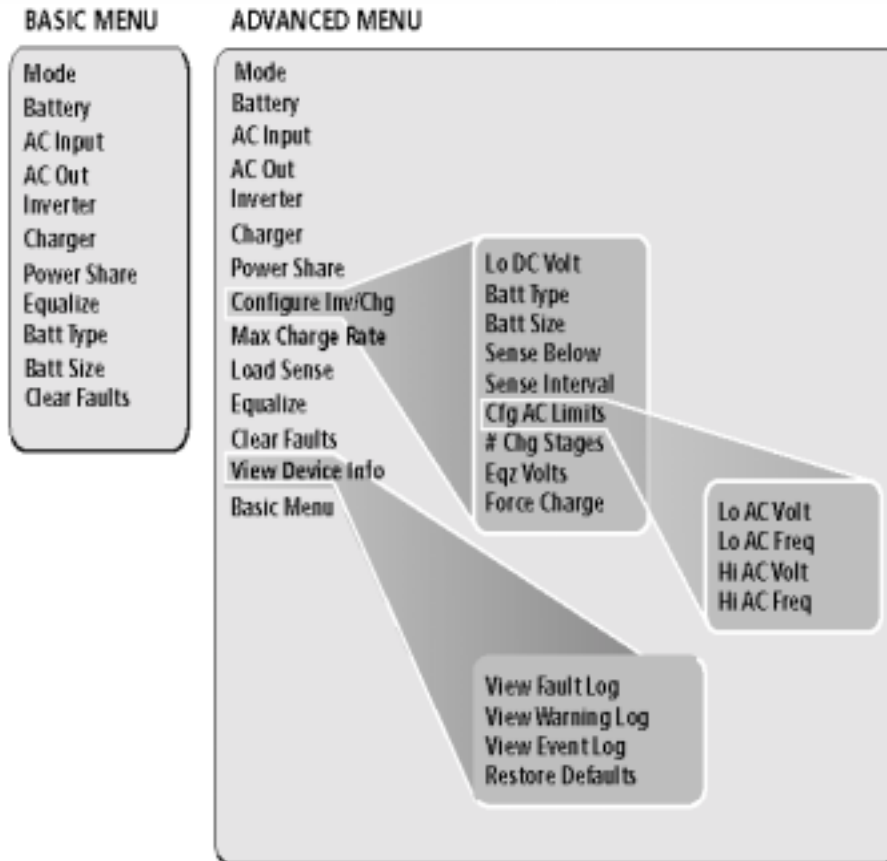

Figure 3-6 RS2000 Menu Structure — Overview

## RS2000 Device Menu

The RS2000 device menu displays status information on the different modes of the inverter/charger. The first three lines of the device screen displays dynamic content that changes, depending on what operation mode that the RS2000 is in. Status information is not configurable; configurable items are indicated by square brackets [ ]. An asterisk indicates the value that was previously set.

For example, in Figure 3-7, the RS2000 is in invert mode with AC current going out.

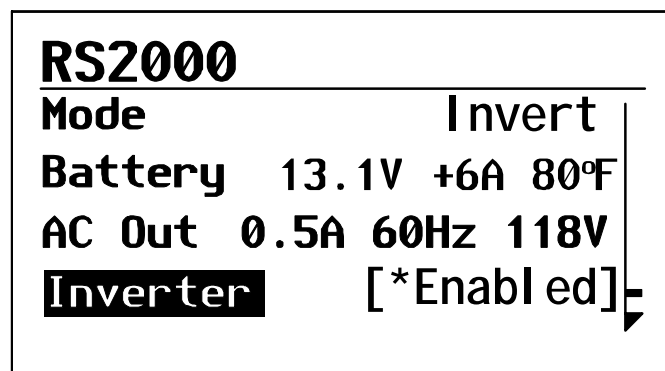

Figure 3-7 Invert Mode

## Mode

The first line indicates which mode that the RS2000 is in. Table 3-1 defines the different modes.

Table 3-1 Modes

| Mode              | Description  |
|-------------------|--|
| Bulk Charge       | The first stage of three-stage battery charging. Current is supplied to the batteries at a constant rate while voltage gradually rises.                        |
| Absorption Charge | The second stage of three-stage battery charging. Voltage remains constant and current reduces as the battery becomes charged. This ensures complete charging. |

**Table 3-1 Modes**

| Mode         | Description  |
|--------------|--|
| Float Charge | The third stage of three-stage battery charging. After batteries reach full charge, charging voltage is reduced to a lower level to prevent gassing and to prolong battery life. This stage is often referred to as a maintenance charge. Rather than charging a battery, it keeps an already-charged battery from discharging while providing load current. |
| Invert       | The RS2000 is converting DC power to AC power.   |
| AC Bypass    | AC input from an AC source like the utility grid or from a generator is allowed to pass through the unit to operate connected AC loads. The charger is not enabled but AC is qualified and passed through the unit.  |
| Equalize     | To improve the life and performance of a non-sealed, flooded (or wet) battery, the RS2000's multi-stage charging cycle includes a manual equalize mode that can be used if recommended by the battery manufacturer.  |
| Load Sense   | In order to minimize power draw from the battery, the inverter will periodically check if a load is connected when the inverter is enabled.  |

## Battery

The second line of the device screen indicates the status of the battery. This line displays the volts (V), current (A) as either (+) positive amps (indicating that the battery is charging) or (-) negative amps (indicating the battery is discharging because you're inverting) and battery temperature in either °F or °C.

## AC Input

When the RS2000 is in charge mode, this line indicates whether you have AC input from the utility grid or from a generator. This line shows the values for current (A), the frequency (Hz), and the AC voltage in (V).

## AC Out

This line is displayed when the RS2000 is in invert mode or in AC bypass mode. This line indicates the AC output and shows the values for current (A), the frequency (Hz), and the AC voltage in (V).



## RS2000 Menu (Basic)

The RS2000 basic menu indicates the status of items and lists settings that you may have to adjust on a routine basis.

If advanced menu is enabled, scroll through the RS2000 advanced menu items until Basic Menu is highlighted and press enter.

This section describes each display item and configurable item in detail with an example of the line item. Each item is described in terms of its purpose, whether it is a display or configurable setting, when to use, and the outcome of changing a setting.

### Inverter

#### Configurable setting

This setting lets you enable or disable the inverter. In the example shown, the inverter is enabled. For an explanation of enable and disable, see “Terminology” on page C-1.

|          |           |
|----------|-----------|
| Inverter | [Enabled] |
|----------|-----------|

| Value    | Default  |
|----------|----------|
| Enabled  |          |
| Disabled | Disabled |

#### When to use

Enable the inverter when you would like to have AC power from the inverter.

#### Outcome

The inverter is enabled. The inverter provides power from the batteries unless qualified AC input power is present.

## Charger

**Configurable setting** This setting lets you enable or disable the operation of the charger. When the charger is enabled, and AC is connected to the input, your batteries will be charged. The charger can be disabled, if desired, anytime during the charge cycle.

If the charger is enabled and the AC is not qualified as good, then the charger will not operate until AC qualifies as good.

The charger can be enabled or disabled from the front panel of the RS2000 or from the System Control Panel (SCP). In the example shown, the charger is enabled.

|         |           |
|---------|-----------|
| Charger | [Enabled] |
|---------|-----------|

| Value    | Default |
|----------|---------|
| Enabled  | Enabled |
| Disabled |         |

**Outcome** Use the default Enabled setting to ensure batteries are always being charged when connected to an AC source. Disabling the charger will turn off the charge function. Then the next time qualified AC power is connected, the charger is automatically enabled and charging will begin, if Force Charge is enabled. If Force Charge is not enabled, charging will not occur until the Charger setting is changed from disabled to enabled. See “Force Charge” on page 3–25 for more information on this feature.

## Power Share

**Configurable setting** Power Share is a configurable setting that you set to match to the breaker rating on the AC input. This setting is used to ensure that the charger limits its output to try to prevent nuisance tripping of the AC input breaker due to the total current drawn by the charger and your other AC loads. See also “*Power Share*” on page 2–20.

|             |       |
|-------------|-------|
| Power Share | [10A] |
|-------------|-------|

| Range of values | Increment        | Default |
|-----------------|------------------|---------|
| 5 to 50 amps    | 5 amp increments | 30 amps |

**When to use** Set the Power Share setting to match the AC input breaker. Use this setting when connecting to an AC source. If using multiple AC sources via an AC transfer switch, adjust this setting to the smaller AC breaker size.

**Outcome** Setting the value higher than the AC source’s external breaker could cause the external breaker to trip.

## Equalize

**Configurable setting** This setting lets you enable or disable charger equalization, if the battery type is flooded (or wet).

Equalization can be turned on (enabled) or off (disabled).

|          |       |
|----------|-------|
| Equalize | [Off] |
|----------|-------|

| Value | Default |
|-------|---------|
| On    |         |
| Off   | Off     |

**When to use** Review the section, “Operating in Equalization Mode” on page 2–16 before adjusting this setting. This menu item is displayed if the battery type allows equalization.

In the RS2000 home menu, highlight Equalize, as shown in Figure 3-8.

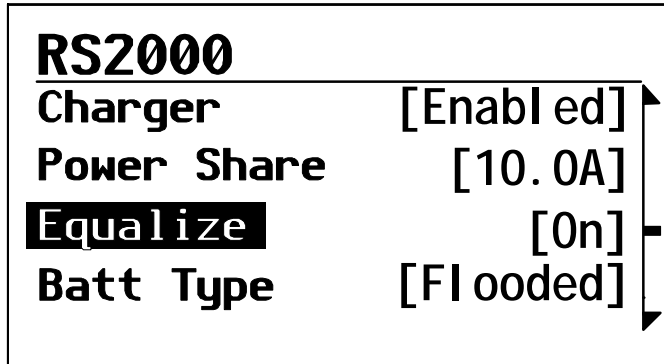

Figure 3-8 Equalize On

When you select On, the equalization confirmation warning appears, as shown in Figure 3-9.

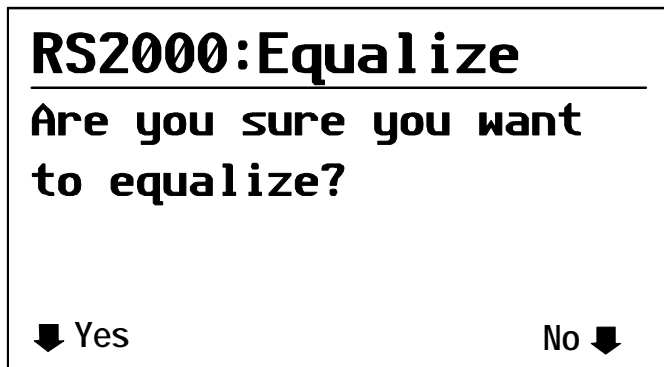

Figure 3-9 Equalize Confirmation Warning

Selecting Yes takes you to the equalization system home screen, as shown in Figure 3-10.



## Batt Type

Full name Battery Type

Configurable setting Select the type of battery from flooded, AGM, gel or custom. If a battery temperature sensor is not present, the RS2000 uses cold, warm or hot settings with the hot setting as the default.

|           |           |
|-----------|-----------|
| Batt Type | [Flooded] |
|-----------|-----------|

| Value   | Default Battery Type |
|---------|----------------------|
| Flooded | Flooded              |
| Custom  |                      |
| AGM     |                      |
| Gel     |                      |

When to use This setting is adjusted for the type of battery you have. It is important during installation to choose the correct setting (battery type) to optimize the charge algorithm for your battery and to properly enable or disable equalization. See “*Battery Charging Reference*” on page B-1 for more information.

The custom setting is selected to get the battery settings programmed by the dealer.

## Batt Size

Full name Battery size

Configurable setting This features let you select the size of the battery bank being charged.

|           |          |
|-----------|----------|
| Batt Size | [440 Ah] |
|-----------|----------|

| Range of values  | Increment | Default |
|------------------|-----------|---------|
| 50 Ah to 2000 Ah | 10 Ah     | 440 Ah  |

When to use Adjust this setting to your actual battery bank size.

Outcome Reduces the maximum charger current to protect against charging smaller batteries too aggressively. This setting charges batteries appropriately based on capacity. See “Battery Charging Reference” on page B-1 for more information.

## Clear Faults

Purpose Clear RS2000 faults is a command which clears all active faults in the RS2000. When faults are cleared, the device will resume normal operation. If the fault condition still exists, the fault will reoccur.

|              |
|--------------|
| Clear Faults |
|--------------|

| Value | Effect             |
|-------|--------------------|
| Yes   | Faults are cleared |
| No    | No action          |

## RS2000 Menu (Advanced)

The RS2000 advanced menu lists settings that provide you with additional control over RS2000. However, you may not have to adjust these settings as part of regular operation. For a listing of advanced menu items, see “RS2000 Menu Structure — Overview” on page 3–8.

These settings are only visible if Advanced Menu is selected. To select the RS2000 Advanced Menu, see “Selecting the RS2000 Advanced Menu” on page 3–21.

In addition to several items from the basic menu, the RS2000 advanced menu contains the following sub-menus and commands:

- Configure Inv/Chg (Configure Inverter/Charger)
  - Cfg AC Limits (Configure AC Limits)
- Dev Info (Device Info)

When you select a sub-menu and press Enter, a list of menu items appears.

This section describes each display item and configurable item in detail. Each item is described as a display or configurable setting, when to use the setting, and the outcome of changing a setting.

### Inverter

See a description of this feature on page 3–11.

### Charger

See a description of this feature on page 3–12.

### Power Share

See a description of this feature on page 3–13.

### Configure Inv/Chg (Configure Inverter/Charger)

Cfg Inv/Chg is a sub menu command. If you select this item, you’ll access a list of sub-menu items. See “Configure Inv/Chg Menu (Configure Inverter/Charger Menu)” on page 3–23.



## Max Chg Rate

Full name Maximum charge rate

Configurable setting The actual battery charge rate is determined by two things. First, the RS2000 uses the bank size setting (C) divided by 5 ( $C \div 5$ ). This value is then regulated by the charge rate setting. For example, if the battery bank size is set to 300 Ah and the charge rate was set at 100%, the calculation would be:  $300 \div 5$  or 60 amps  $\times$  100% which is a 60 amp charge rate. If the charge rate is adjusted to 50%, the resulting charge rate would be 30 amps (60 amps  $\times$  50%).

The RS2000 has a maximum charge rate of 100 amps. Even though you can set a bank size of 2000 Ah, where  $C \div 5$  is 400 amps, the RS2000 would still charge at 100 amp maximum.

|              |        |
|--------------|--------|
| Max Chg Rate | [100%] |
|--------------|--------|

| Range of values | Increment | Default |
|-----------------|-----------|---------|
| 10% to 100%     | 10        | 100%    |

When to use Displayed only if in charger mode when you wish to control the maximum charge rate to your batteries.

## Load Sense

Configurable setting This setting lets you enable or disable the load sensing function.

|            |      |
|------------|------|
| Load sense | [On] |
|------------|------|

| Value | Default |
|-------|---------|
| On    |         |
| Off   | Off     |

When to use Enable this setting if you want the inverter to conserve battery power when there are small loads or no loads applied.

Outcome A small load like a clock display on a microwave may not get power. When loads are below the load sense threshold, the inverter will turn off the output to save battery power.

## Equalize

See a description of this feature on page 3–13.

## Clear Faults

See a description of this feature on page 3–17.

## View Device Info

For more information on this sub menu, Device Information, see “View Device Info Menu (Device Information Menu)” on page 3–28.

## Basic Menu

### Purpose

Selecting Basic Menu takes you back to the basic menu of the RS2000 only. Advanced menu items will no longer be visible on the System Control Panel.

### When to use

Use this setting when you want to return to the basic menu of the RS2000.

## Selecting the RS2000 Advanced Menu

The System Control Panel shows the RS2000 basic menu by default. If you would like to view the advanced menu, you must go to the System Settings menu and select Global Menus.

**Important:** When you select Advanced on the Global Menu, the System Control Panel will display the advanced menus for all devices. To return to viewing the basic menu for any Xanbus-enabled devices, select Basic Menu from the advanced menu for that device.

### To select the RS2000 Advanced Menu:

1. On the Select Device menu with System highlighted, press Enter.

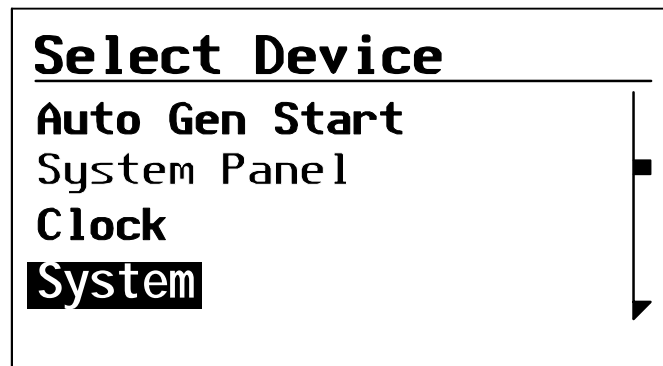

Figure 3-12 Highlighting System on the Select Device Menu

2. Scroll with the down arrow button to highlight Global Menus.

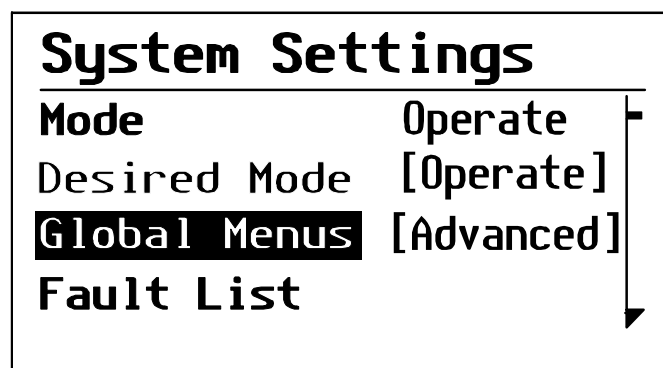

Figure 3-13 Highlighting Global Menus

3. Press Enter.

4. Select Advanced and press Enter.
5. Press Exit to return to Select Device menu.

## Returning to RS2000 Basic Menu

You can return to viewing the RS2000 basic menu by selecting Basic Menu from the RS2000 advanced menu. See “Basic Menu” on page 3–20.

## Sub-Menus

### Configure Inv/Chg Menu (Configure Inverter/Charger Menu)

Cfg/Inv Chg is a sub-menu. If selected, a list of sub-menu items appears.

#### Lo DC Volt

Full name Low DC input voltage shutdown

Configurable setting This setting lets you set the low voltage shutdown level for the inverter.

|            |         |
|------------|---------|
| Lo DC Volt | [10.0V] |
|------------|---------|

| Range          | Increment | Default  |
|----------------|-----------|----------|
| 10 to 13 volts | 0.1 volt  | 10 volts |

When to use This setting limits the depth of discharge on your battery.

#### Batt Type

See a description of this feature on page 3–16.

#### Batt Size

See a description of this feature on page 3–23.

#### Sense Below

Configurable setting This setting lets you set the threshold for load sense power. This setting saves battery consumption by keeping the inverter disabled (turned off) except when load demand is present.

|             |       |
|-------------|-------|
| Sense Below | [50W] |
|-------------|-------|

| Range of values       | Increment | Default  |
|-----------------------|-----------|----------|
| 40 watts to 150 watts | 10 watts  | 10 watts |

When to use Adjust this setting to control the inverter based on the load.

Outcome Sets the load threshold at a power level where you want the inverter to stay on, for example, when a sufficient load is applied.

## Sense Interval

**Configurable setting** This setting lets you adjust the interval of load sensing. The longer the interval, the more power you will save. However, the longer intervals may cause delays in the inverter power up and starting your loads.

|                |      |
|----------------|------|
| Sense Interval | [1s] |
|----------------|------|

| Range of values        | Increment | Default  |
|------------------------|-----------|----------|
| 1 second to 25 seconds | 1 second  | 1 second |

## Cfg AC Limits (Configure AC Limits)

Cfg AC Limits is a sub-menu. If selected, a list of sub-menu items appear. For more information on this sub menu, Configure AC Limits, see page 3–26.

## # Chg Stages

**Full name** Number of charge stages

**Configurable setting** These settings let you adjust your charger stages to either two-stage charging or three-stage charging. See “*Battery Charging Reference*” on page B–1 for an explanation of two-stage and three-stage charging.

|              |          |
|--------------|----------|
| # Chg Stages | [3Stage] |
|--------------|----------|

| Value  | Default |
|--------|---------|
| 2Stage |         |
| 3Stage | 3Stage  |

## Eqz Volts

**Full name** Equalization voltage

**Configurable setting** This setting lets you set the desired equalization voltage. This menu is displayed only if charger equalization is enabled. Select a setting based on the battery manufacturer’s recommendation. For more information, see “Battery Charging Reference” on page B–1.

|           |         |
|-----------|---------|
| Eqz Volts | [15.8V] |
|-----------|---------|

| Range of values  | Increment | Default  |
|------------------|-----------|----------|
| 13.5 to 15.8 VDC | 0.1 volts | 15.8 VDC |

## Force Charge

**Full name** Force Charge

**Configurable setting** This setting forces the charger to be enabled (On) whenever you have qualified AC or reacquired qualified AC. If Force Enabled is not on, you must turn it to On using the System Control Panel.

|              |      |
|--------------|------|
| Force Charge | [On] |
|--------------|------|

| Values | Default |
|--------|---------|
| On     | On      |
| Off    |         |

**When to use** If you want the charger to automatically start when you connect to qualified AC input.

**Outcome** The charger starts whenever qualified AC input appears.

## Cfg AC Limits (Configure AC Limits)



### CAUTION: Risk of damage to equipment

The following configuration settings adjust the quality of the AC input source that the inverter/charger will qualify and pass through to your AC loads. Voltage or frequency that is too high or too low for a particular piece of load equipment may cause damage to that load.

Before adjusting these settings, refer to the electrical rating of connected load equipment. Most equipment that is marked with a single voltage (120 VAC, for example) rather than a range (110–125 VAC) can be expected to run properly over the range of 108 VAC to 125 VAC, since this is the normal operating range of electrical utilities.

### Lo AC Volt

Full name Low AC Transfer voltage (AC under voltage level)

Configurable setting Low AC Transfer voltage is the voltage below which the inverter/charger no longer qualifies AC as “good”, opens the relay, and attempts to transfer to Invert mode if Invert is enabled.

|            |         |
|------------|---------|
| Lo AC Volt | [90.0V] |
|------------|---------|

| Range of values | Increment | Default |
|-----------------|-----------|---------|
| 85 to 110 VAC   | 1 volt    | 90 VAC  |

When to use This setting lets you adjust the AC parameters when AC supply is outside of the lower voltage range required for electrical equipment.

Outcome The lower level of voltage that will be accepted as “good” by the inverter/charger can be varied.

### Lo AC Freq

Full name Low AC transfer frequency (AC under frequency level)

Configurable setting This setting lets you adjust the frequency at which the inverter/charger no longer qualifies AC as “good” and attempts to transfer to invert mode.

|            |        |
|------------|--------|
| Lo AC Freq | [55Hz] |
|------------|--------|

| Range of values | Increment | Default |
|-----------------|-----------|---------|
| 55 to 58 Hz     | 1 Hz      | 55 Hz   |



**When to use** This setting lets you adjust the AC parameters when the AC supply is outside the lower frequency range required for electrical equipment.

**Outcome** The lower frequency of voltage that will be qualified as “good” by the inverter/charger can be varied.

### Hi AC Volt

**Full name** Hi AC transfer voltage (AC over voltage level)

**Configurable setting** This setting lets you adjust the voltage above which the inverter/charger no longer qualifies AC as “good” and attempts to transfer to Invert.

|            |        |
|------------|--------|
| Hi AC Volt | [135V] |
|------------|--------|

| Range of values | Increment | Default |
|-----------------|-----------|---------|
| 120 to 145 VAC  | 1 volt    | 135 VAC |

**When to use** This setting lets you adjust the AC parameters when AC supply is outside the upper voltage range required for electrical equipment.

**Outcome** The upper level of voltage that will be qualified as “good” by the inverter/charger can be varied.

### Hi AC Freq

**Full name** Hi AC transfer frequency (AC over frequency level)

**Configurable setting** This setting lets you adjust the frequency at which the RS2000 no longer qualifies AC as “good” and attempts to transfer to Invert.

|            |        |
|------------|--------|
| Hi AC Freq | [65Hz] |
|------------|--------|

| Range of values | Increment | Default |
|-----------------|-----------|---------|
| 62 to 70 Hz     | 1 Hz      | 65 Hz   |

**When to use** This setting lets you adjust the AC parameters when the AC supply is outside the higher frequency range required for electrical equipment.

**Outcome** The higher frequency of voltage that will be qualified as “good” by the inverter/charger can be varied.

## View Device Info Menu (Device Information Menu)

The View Device Info menu allows you to view the Fault, Warning and Event logs. On the View Device Info menu, you can also restore the default setting for the RS2000.

For a definition of faults and warnings, see “Faults and Warnings” on page 4–2. An event is an indicator of the system modes that the unit has been in.

### View Fault Log

Display setting      The Fault log displays the 20 most recent faults for your reference.

### View Warning Log

Display setting      The Warning log displays the 10 most recent warnings.

### View Event Log

Display setting      The Event log displays the 10 most recent events. Events can include:

- Changing the system mode
- Enabling or disabling the charger

When to use      The list provides useful information to a technical user about events on the system, including an event ID, number ID, and the date and time of the event.

## Restore Defaults

Configurable setting The Restore Default command restores the default settings for each device.

Restore Defaults

When to use Adjust this setting when you wish to restore your settings to defaults.

---

**Important:** Restoring to defaults will overwrite all of the stored values.

---

When you select Restore Defaults, a warning message appears, as shown in Figure 3-14:

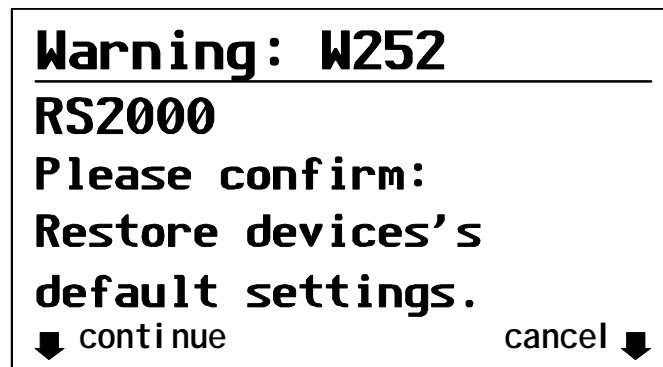

Figure 3-14 Restore Defaults Warning

If you select continue, your settings will be restored to default.

If you select cancel, your existing settings will be retained and the Device Info menu appears.

Defaults If your dealer has created a set of defaults tailored to your unit, those will automatically be used in place of the factory defaults. The user cannot select between these two sets of defaults.



# 4

## Troubleshooting



### **WARNING: Electrical shock and fire hazard**

Do not disassemble the RS2000. It does not contain any user serviceable parts. Attempting to service the unit yourself could result in electrical shock or fire.

---

The RS2000 is designed for high reliability of operation and has a number of protection features to provide trouble free operation. If, however, you have any problems operating your inverter/charger read this troubleshooting chapter.

If you cannot resolve the problem, record the necessary information on the form, “Information About Your System” on page WA-4. This information will help your dealer or Xantrex Customer Service to assist you better when you contact them.

## Faults and Warnings

When a fault or warning message appears, you can acknowledge the message to clear the screen. To acknowledge a fault or warning message, press the Enter button on the System Control Panel. This action does not clear the fault or warning condition, so you should consult Table 4-3 and Table 4-4 for suggested actions after you have acknowledged the message. Refer to the *System Control Panel Owner's Guide* for more information on faults and warnings.

### Fault Types

There are three types of fault messages: automatic faults, manual faults, and escalating automatic faults. Table 4-1 describes how they differ in their behavior and how you can respond to them when they appear on the System Control Panel.

**Table 4-1** Faults Types and Behaviors

| Fault type                  | Behaviour  |
|-----------------------------|--|
| Automatic faults            | Clear automatically if the fault condition that generated the message goes away. You can also acknowledge automatic faults without waiting for them to clear automatically.  |
| Manual faults               | Require you to clear them by: <ul style="list-style-type: none"> <li>• selecting Clear Faults on the RS2000 or on the device that generated the fault (if the fault condition still exists, the fault message reappears)</li> <li>• correcting the condition that caused the fault</li> </ul>  |
| Escalating automatic faults | Clear automatically if the fault condition goes away, just like an automatic fault. However, if an escalating automatic fault occurs several times within a defined time period, the escalating automatic fault becomes a manual fault, requiring user intervention. For example, three faults occur in one minute. It will no longer clear itself but becomes a manual fault. Then you must identify the problem, correct the fault condition, and clear the fault or reset the device. |

---

## Warning Types

There are two types of warnings: automatic and manual. When the RS2000 detects a warning condition, it displays a warning message on the System Control Panel.

Table 4-2 describes how they differ in their behavior and in how you can respond to them when they appear on the System Control Panel.

**Table 4-2** Warning Types and Behavior

| Warning type      | Behaviour  |
|-------------------|--|
| Automatic warning | Clear automatically if the fault condition that generated the message goes away. You can also acknowledge automatic warnings without waiting for them to clear automatically.  |
| Manual warning    | Require you to acknowledge them before you can proceed with configuring or operating the RS2000. Manual warnings are usually in the form of a Yes/No question that you may acknowledge by pressing the Enter button on the System Control Panel for Yes and the Exit button for No. Refer to the <i>System Control Panel Owner's Guide</i> for more information. |

## Troubleshooting Reference

This chapter provides you with troubleshooting tips to identify and solve most problems that can occur with the RS2000.

This chapter is divided into the following four sections:

| Section                            | Page Number    |
|------------------------------------|----------------|
| General Troubleshooting Guidelines | See page 4–5.  |
| Warning Messages                   | See page 4–7.  |
| Fault Messages                     | See page 4–11. |
| Inverter Applications (Loads)      | See page 4–17. |



---

## General Troubleshooting Guidelines

This section will help you narrow down the source of any problem you may encounter. Please read the following troubleshooting steps:

1. Check for a Warning or Fault message on the System Control Panel. See “Warning Messages” on page 4–7 and “Fault Messages” on page 4–11 for descriptions of these messages and the specific actions to take. If a message is displayed, record it before doing anything further.
2. As soon as possible, record on the form, “Information About Your System” on page WA–4, the conditions at the time the problem occurred. These details should include the following as well as any other information asked for on page WA–4:
  - Loads the RS2000 was running or attempting to run
  - Battery condition at the time of failure (voltage, state of charge, for example), if known
  - Recent sequence of events (for example, charging had just finished, we disconnected shore power as were preparing to leave the RV park, but the inverter didn’t come on)
  - Any known unusual AC input factors such as low voltage or unstable generator output
  - Extreme conditions which may have existed at the time (temperature, vibrations, moisture, for example).
3. Attempt the solution indicated in Table 4-3 or Table 4-4.
4. If your RS2000 or System Control Panel is not displaying a Fault light, check the following list to make sure that the present state of the installation allows proper operation of the unit:
  - Is the inverter/charger located in a clean, dry, adequately ventilated place?
  - Are the battery cables adequately sized and short enough?
  - Is the battery in good condition and are all DC connections tight?
  - Are the AC input and output connections and wiring in good condition?
  - Are the configuration settings correct for your particular installation?
  - Are the display panel and the communications cable properly connected and undamaged?
  - Is the battery temperature sensor and its cable properly connected and undamaged?

5. Contact Xantrex Customer Service for further assistance. Please be prepared to describe details of your system installation and provide the model and serial number of the unit. See “Contact Information” on page v for contact information.

---

## Warning Messages

Warning messages appear on the System Control Panel to alert you to an impending system change. You can retrieve and view the last ten warning messages using the control panel. The warnings have been recorded with a time stamp to let you know the date and time that the warning appeared. See “Warning Types” on page 4-3 for an explanation of automatic and manual warnings.

You can view the most recent fault messages of the RS2000 (up to 20) by selecting Fault Log from the Device Info menu in the RS2000 Advanced Menu.

If several warning messages occur before you can acknowledge or clear them, they are displayed together on a warning list. This list contains messages from every Xanbus-enabled device, not just the RS2000. You can select a message and view its details from warning list.

### **To view a message from a warning list:**

1. On the list, use the up arrow or down arrow button to highlight the message you want to view.
2. Press Enter.

The complete message appears.

After viewing the message, you can return to the warning list by pressing Exit or continue to the menu for the device that caused the fault by pressing Enter. Each time you return to the list after viewing a complete message, the viewed message is removed from the list.

If you have left the warning list, you can view them at any time from the System Settings menu.

### **To view a fault list:**

1. On the Select Device menu, highlight System and press Enter.
2. On the System Settings menu, highlight View Warning List.
3. Press Enter.

Table 4-3 provides a detailed description of the warning messages and solutions.

**Table 4-3** Warning Messages

| Warning Number | Message  | Warning Type | Cause  | Solution  |
|----------------|--|--------------|--|---|
| W0             | FET1 over-temp.<br>Check airflow around it.        | Automatic    | FET1 Over Temperature Warning  | Ensure adequate ventilation around the RS2000. Reduce the AC loads.   |
| W1             | FET2 over-temp.<br>Check airflow around it.        | Automatic    | FET2 Over Temperature Warning  | Ensure adequate ventilation around the RS2000. Reduce the AC loads.   |
| W2             | Bulk cap. over-temp.<br>Check airflow around it.   | Automatic    | DC Bulk Capacitor Over Temperature Warning   | Ensure adequate ventilation around the RS2000. Reduce the AC loads.   |
| W3             | Transf'r over-temp.<br>Check airflow around it.    | Automatic    | Transformer Over Temperature Warning   | Ensure adequate ventilation around the RS2000. Reduce the AC loads.   |
| W4             | Battery over-temp.<br>Check battery settings.      | Automatic    | Battery Over Temperature Warning   | Check battery voltage and battery cable connections. Stop charging, if necessary. Check for excessive ambient temperature and adequate ventilation in the battery compartment |
| W5             | Over-temperature.<br>Check airflow around it.      | Automatic    | Ambient Over Temperature Warning   | Ensure adequate ventilation around the RS2000. Reduce charge rate or AC load.   |
| W6             | Too many AC loads.<br>Turn some off.               | Automatic    | AC Overload Warning (AC OUPUT)   | Turn off some AC loads.   |
| W7             | You have enabled system restart after faults.      | Automatic    | Auto Restart After Fault Feature Enabled. (This parameter is not accessible through the System Control Panel. In the future, this feature may be configurable with advanced panels.) | If in invert mode, the unit may start up unexpectedly.  |
| W8             | You have enabled battery equalization. See manual. | Automatic    | Equalization Enabled Warning   | Make sure voltage sensitive loads are disconnected from batteries.  |

**Table 4-3 Warning Messages**

| Warning Number | Message   | Warning Type | Cause                                      | Solution   |
|----------------|---|--------------|--|--|
| W9             | Battery temp sensor not detected. Check connections.        | Automatic    | Battery Temperature Sensor Not Present     | Install a battery temperature sensor (BTS). This warning will continue to display as long as no BTS is connected.                                      |
| W10            | Battery temp sensor failure.                                | Automatic    | Battery Temperature Sensor Shorted         | Replace battery temperature sensor.  |
| W11            | Batt voltage too high. Check DC wiring to inverter/charger. | Automatic    | DC Over Voltage Warning                    | Turn off or check additional charging sources to batteries. Check battery cables.  |
| W12            | Battery voltage is getting low. Recharge battery.           | Automatic    | DC Under Voltage Warning                   | Recharge batteries and check battery cables from inverter to batteries for loose connections.  |
| W13            | Line 1 AC voltage too high. System may shut down            | Automatic    | AC Over Voltage Warning (AC Line 1 input)  | Check AC input voltage. Check high AC input voltage setting.   |
| W14            | Line 1 AC voltage too low. System may shut down.            | Automatic    | AC Under Voltage Warning (AC Line 1 input) | Check AC input voltage. Check low AC input voltage setting.  |
| W15            | Line 2 AC voltage too high. System may shut down.           | Automatic    | AC Over Voltage Warning (AC Line 2 input)  | Not applicable to RS2000.  |
| W16            | Line 2 AC voltage too low. System may shut down.            | Automatic    | AC Under Voltage Warning (AC Line 2 input) | Not applicable to RS2000.  |
| W18            | Cannot Equalize   | Manual       | Cannot equalize                            | Wrong battery type. Change battery type only if the battery type setting is not the same as actual battery type. Cannot equalize a gel or AGM battery. |
| W19            | Equalization terminated abnormally                          | Manual       | Equalization terminated abnormally         | Investigate cause of problem.  |
| W500           | Lost network connection                                     | Automatic    | Lost network connection                    | Check network cables or terminators.   |

**Table 4-3** Warning Messages

| Warning Number | Message                                   | Warning Type | Cause                       | Solution   |
|----------------|---|--------------|-----------------------------|--|
| W501           | Inv/Chg is trying to fix a memory problem | Manual       | Non-volatile memory warning | Normal operation may return or may go to fault. Push Reset button if normal operation does not resume. |

---

## Fault Messages

When the RS2000 detects a fault condition, the fault is displayed on the System Control Panel and also is indicated by the illuminated red Fault light on the RS2000 front panel. A fault affects the operation of the unit. See “Fault Types” on page 4–2 for an explanation of the different fault types.

You can view the 20 most recent fault messages of the RS2000 by selecting Fault Log from the Device Info menu in the RS2000 Advanced Menu.

If several faults occur before you can acknowledge or clear them, they are displayed together on a warning list. This list contains messages from every Xanbus-enabled device, not just the RS2000. You can select a message and view its details from the fault list.

### **To view a message from a fault list:**

1. On the list, use the up arrow or down arrow button to highlight the message you want to view.
2. Press Enter.

The complete message appears.

After viewing the message, you can return to the fault list by pressing Exit or continue to the menu for the device that caused the fault by pressing Enter. Each time you return to the list after viewing a complete message, the viewed message is removed from the list.

If you have left the fault list, you can view them at any time from the System Settings menu.

### **To view a fault list:**

1. On the Select Device menu, highlight System and press Enter.
2. On the System Settings menu, highlight View Fault List.
3. Press Enter.

Table 4-4 provides a detailed description of the fault messages and solutions. If you are unable to resolve the problem after referring to this table, contact your dealer or Customer Service.

**Table 4-4** Fault Messages

| Fault Number | Message   | Fault Type  | Cause                                 | Solution  |
|--------------|---|---|---------------------------------------|---|
| F0           | is too hot and has shut down. See guide.                  | Automatic   | FET1 Over Temperature Shutdown        | Clear the fault and attempt restart. Ensure adequate ventilation around the RS2000. Reduce AC loads.  |
| F2           | is too hot and has shut down. See guide.                  | Automatic   | FET2 Over Temperature Shutdown        | Clear the fault and attempt restart. Ensure adequate ventilation around the RS2000. Reduce AC loads.  |
| F3           | is too hot and has shut down. See guide.                  | Automatic   | Transformer Over Temperature Shutdown | Clear the fault and attempt restart. Ensure adequate ventilation around the RS2000. Reduce AC loads.  |
| F4           | Battery over-temp. Inv/Chg has shut down. See guide.      | Automatic   | Battery Over Temperature Shutdown     | Clear the fault and attempt restart. Stop charging, check battery voltage and temperature. Check for excessive ambient temperature and adequate ventilation in the battery compartment. |
| F5           | is too hot and has shut down. See guide.                  | Automatic   | Ambient Over Temperature Shutdown     | Clear the fault and attempt restart. Ensure adequate ventilation around RS2000. Reduce AC loads.  |
| F6           | Too many AC loads. Turn some off, clear fault, try again. | Escalating Auto Fault. Must occur 3 times in 30 seconds before becoming a manual fault. | AC Overload Shutdown (AC OUTPUT)      | Clear the fault and attempt restart. Reduce AC loads.   |



Table 4-4 Fault Messages

| Fault Number | Message   | Fault Type  | Cause  | Solution  |
|--------------|---|---|--|---|
| F7           | Too many AC loads. Turn some off, clear fault, try again. | Escalating Auto Fault. Must occur 3 times in 30 seconds before becoming a manual fault. | AC Overload (PEAK CURRENT) Shutdown (AC OUTPUT)                                | Clear the fault and attempt restart. Reduce AC loads.   |
| F8           | has lost input neutral connection. See guide.             | Manual  | Neutral loss shutdown  | Clear the fault and attempt restart. Check AC input wiring for presence of a proper neutral connection and ground connection. Check the AC input source to make sure the neutral is bonded to ground. |
| F9           | Battery voltage is too high. See guide.                   | Automatic   | DC Over Voltage Shutdown   | Clear the fault and attempt restart. Ensure battery voltage is 10–16 VDC at RS2000 terminals. Check all other charging source outputs, battery cables.  |
| F10          | Battery is too low, can't invert. Recharge battery.       | Automatic   | DC Under Voltage Shutdown (Immediate) occurs if DC voltage is below 8 volts DC | Clear the fault and attempt restart. Recharge batteries. Check battery cable connections.   |
| F11          | Battery is too low, can't invert. Recharge battery.       | Automatic   | DC Under Voltage Shutdown occurs if DC voltage is below 10 volts DC.           | Clear the fault and attempt restart. Recharge batteries. Check battery cable connections.   |
| F12          | Input AC too high. Check source, clear fault, try again.  | Automatic   | AC Over Voltage Shutdown (AC Line 1 input)                                     | Clear the fault and attempt restart. Check AC input voltage. Check and adjust AC input high voltage settings.   |
| F13          | Input AC too low. Check source, clear fault, try again.   | Automatic   | AC Under Voltage Shutdown (AC Line 1 input)                                    | Clear the fault and attempt restart. Check AC input voltage. Check and adjust AC input low voltage setting.   |

## Troubleshooting

**Table 4-4** Fault Messages

| Fault Number | Message   | Fault Type  | Cause   | Solution   |
|--------------|---|---|---|--|
| F14          | Input AC too high. Check source, clear fault, try again.      | Automatic   | AC Over Voltage Shutdown (AC Line 2 input)    | Not applicable for RS2000  |
| F15          | Input AC too low. Check source, clear fault, try again.       | Automatic   | AC Under Voltage Shutdown (AC Line 2 input)   | Not applicable to RS2000.  |
| F16          | AC input frequency problem. Check gen for overspeed.          | Automatic   | AC Over Frequency Shutdown (AC Line 1 input)  | Clear the fault and attempt restart. Check AC input frequency. Check and adjust AC input high frequency setting. |
| F17          | AC input frequency problem. Check gen for underspeed.         | Automatic   | AC Under Frequency Shutdown (AC Line 1 input) | Clear the fault and attempt restart. Check AC input frequency. Check and adjust AC input low frequency setting.  |
| F18          | AC input frequency problem. Check gen for overspeed.          | Automatic   | AC Over Frequency Shutdown (AC Line 2 input)  | Not applicable to RS2000.  |
| F19          | AC input frequency problem. Check gen for underspeed.         | Automatic   | AC Under Frequency Shutdown (AC Line 2 input) | Not applicable to RS2000.  |
| F23          | Reset the RS2000. If problem persists, call customer service. | Escalating Auto Fault. Must occur 3 times in 30 seconds before becoming a manual fault. | AC Over Voltage Shutdown (Inverter AC output) | Clear the fault and attempt restart. If problem persists, call customer service.                                 |

**Table 4-4** Fault Messages

| Fault Number | Message   | Fault Type  | Cause  | Solution  |
|--------------|---|---|--|---|
| F24          | Reset the RS2000. If problem persists, call customer service. | Escalating Auto Fault. Must occur 3 times in 60 seconds before becoming a manual fault. | AC Under Voltage Shutdown (Inverter AC output) | Clear the fault and attempt restart. If problem persists, call customer service.  |
| F25          | Reset the RS2000. If problem persists, call customer service. | Escalating Auto Fault. Must occur 3 times in 30 seconds before becoming a manual fault. | Auxiliary Power Supply Over Voltage Shutdown   | Clear the fault and attempt restart. If problem persists, call customer service.  |
| F26          | Reset the RS2000. If problem persists, call customer service. | Escalating Auto Fault. Must occur 3 times in 30 seconds before becoming a manual fault. | Auxiliary Power Supply Under Voltage Shutdown  | Clear the fault and attempt restart. If problem persists, call customer service.  |
| F29          | Reset the RS2000. If problem persists, call customer service. | Manual  | AC Backfeed Shutdown                           | Clear the fault and attempt restart. If problem persists, call customer service.  |
| F30          | is too cold and has shut down. See guide.                     | Manual  | Battery Under Temperature Fault                | Clear the fault and attempt one restart. Try restart again when ambient temperature is warmer or gently warm the battery. |
| F40          | Reset the RS2000. If problem persists, call customer service. | Manual  | No IPC communication                           | Service required.   |

## Troubleshooting

**Table 4-4** Fault Messages

| Fault Number | Message   | Fault Type | Cause                        | Solution   |
|--------------|---|------------|------------------------------|--|
| F41          | Reset the RS2000. If problem persists, call customer service. | Manual     | Dead battery charger timeout | Try restarting dead battery charging once. Then check the condition of the battery and replace if necessary. |
| F500         | Silicon Serial ID Failure                                     | Manual     | Silicon Serial ID Failure    | Service required.  |
| F502         | Watchdog reset error  | Manual     | Watchdog reset error         | Service required.  |
| F505         | Controller fault  | Manual     | Controller fault             | Service required.  |
| F506         | Wrong fault identifier  | Manual     | Wrong fault identifier       | Service required.  |
| F507         | Wrong identifier  | Manual     | Wrong identifier             | Service required.  |
| F508         | Invalid interrupt   | Manual     | Invalid interrupt            | Service required.  |

---

## Inverter Applications

The Xanbus system performs differently depending on the AC loads connected to it. If you are having problems with any of your loads, read this section. The Xanbus system perform differently based on different loads.

### Resistive Loads

These are the loads that the inverter finds the simplest and most efficient to drive. Voltage and current are in phase, which means they are in step with one another. Resistive loads usually generate heat in order to accomplish their tasks. Toasters, coffee pots, and incandescent lights are typical resistive loads. It is usually impractical to run larger resistive loads—such as electric stove and water heaters—from an inverter due to their high current requirements. Even though the inverter may be able to accommodate the load, the size of battery bank required would be impractical if the load is to be run for long periods.

### Motor Loads

Induction motors (motors without brushes) require two to six times their running current on start up. The most demanding are those that start under load (for example, compressors and pumps). Of the capacitor start motors (typical in drill presses, band saws for example), the largest you can expect to run is ½ to 1 hp (the 30 amp transfer relay is rated at 1 ½ hp). Universal motors are generally easier to start. Since motor characteristics vary, only testing will determine whether a specific load can be started and how long it can be run.

If a motor fails to start within a few seconds or loses power after running for a time, it should be turned off. When the inverter attempts to start a load that is greater than it can handle, the inverter will turn itself off after a few seconds.

### Problem Loads

#### Very small loads

If the power consumed by a device is less than the threshold of the Load Sense mode circuitry, and load sense is enabled, the inverter will not run. Most likely the solution will be to defeat the Load Sense mode feature or lower the sense threshold. Refer to Xantrex Tech Note TN3 (979-0003-01-01 Rev. A) for more information.

## Fluorescent Lights & Power Supplies

Some devices cannot be detected when scanned by Load Sense circuitry. Small fluorescent lights are the most common example. Some computers and sophisticated electronics have power supplies that do not present a load until line voltage is available. When this occurs, each unit waits for the other to begin. To drive these loads, either a small companion load must be used to bring the inverter out of its search mode, or the inverter may be programmed to remain on by defeating the search mode feature.

## Clocks

The inverter's crystal-controlled oscillator keeps the frequency accurate to within a few seconds a day. Most clocks do not draw enough power to trigger the load sensing circuit. In order to operate without other loads present, the load sensing will have to be defeated. The best solution is to buy a battery-operated clock or a clock that is not dependent on line frequency and voltage.

## Searching

If the amount of power which a load draws decreases after the load turns on, and if this "on" load is less than the load sensing threshold, it will be turned on and off by the inverter. Incandescent light bulbs may present this problem when the load sensing threshold is set near the wattage rating of the bulb. The solution is to reduce the load sense power threshold.

# A

## Specifications

Appendix A, “Specifications” contains the electrical and physical specifications for the RS2000 Sine Wave Inverter/Charger.

All specifications are subject to change without notice.

## Inverter Specifications

All inverter specifications are at nominal conditions: ambient temperature of 77 °F (25 °C), 2000 watt resistive load, 12 volts DC inverting on the RS2000, 120 volts AC, unless otherwise specified.

**Table A-1** Inverter Specifications

|                                   |                              |
|-----------------------------------|------------------------------|
| Output wave form                  | Sine wave                    |
| Total harmonic voltage distortion | <3%                          |
| Output power continuous           | 2000 W/2000 VA continuous    |
| Surge rating                      | 5000 W/5000 VA for 5 seconds |
| AC output voltage                 | 120 VAC $\pm$ 5%             |
| Input DC voltage rating           | 12 VDC nominal, 10 to 16 VDC |
| AC output frequency               | 60.0 $\pm$ 0.05 Hz           |
| Power factor (lag or lead)        | 0 to 1.0                     |
| Peak efficiency                   | >89%                         |
| Efficiency at 2000W               | >85%                         |
| Load sense consumption            | <5 W                         |
| DC low voltage shutdown           | 10 volts                     |
| DC over voltage shutdown          | 16 volts                     |



## Charger Specifications

All charging specifications are at nominal conditions: ambient temperature of 77 °F (25 °C), 120 VAC, 60 Hz input, unless otherwise specified.

**Table A-2** Charger Specifications

|  |   |
|--|---|
| Charging method                        | <ul style="list-style-type: none"> <li>• Three-stage charge (Bulk, Absorption, Float)</li> <li>• Two-stage charge (Bulk, Absorption)</li> </ul> The default charging method is three-stage.   |
| Without a battery temperature sensor   | Three settings with the following temperature values: <ul style="list-style-type: none"> <li>• Cool 50 °F (10 °C)</li> <li>• Warm 77 °F (25 °C)</li> <li>• Hot 104 °F (40 °C)</li> </ul> The default value for this setting is Hot, and it can only be changed by a dealer, factory, or service centre. |
| With a battery temperature sensor      | The temperature compensation coefficients on a 12 volt battery are as follows: <ul style="list-style-type: none"> <li>• Flooded: 27 mV × (25 °C – BTS °C)</li> <li>• Gel: 27 mV × (25 °C – BTS °C)</li> <li>• AGM: 21 mV × (25 °C – BTS °C)</li> </ul>  |
| Equalization cycle                     | Yes, manual via System Control Panel  |
| Number of independent battery banks    | 1   |
| Battery bank size settings             | 50 – 2000 Ahr   |
| Battery type settings                  | Flooded, AGM, Gel, Custom   |
| Power factor corrected charging        | Yes   |
| AC input voltage                       | 90 – 135 VAC  |
| AC input frequency                     | 60 Hz nominal, 55 – 65 Hz operating range   |
| Minimum battery voltage                | 3.0 VDC   |
| Maximum DC output voltage              | 16.0 VDC  |
| Charger efficiency                     | ≥ 85%   |
| Input power factor at full charge rate | > 0.95  |
| Maximum charge current                 | 100 A   |

## Transfer and General Specifications

All transfer specifications are at nominal conditions: ambient temperature of 77 °F (25 °C), 120 VAC, 60 Hz input, unless otherwise specified.

**Table A-3** Transfer and General Specifications

|   |                                     |
|---|-------------------------------------|
| Transfer time—utility to invert         | 20 ms                               |
| Minimum AC input voltage for transfer   | 90 VAC RMS                          |
| Maximum AC input voltage for transfer   | 135 VAC RMS                         |
| Minimum AC input frequency for transfer | 55 Hz                               |
| Maximum AC input frequency for transfer | 65 Hz                               |
| Cooling                                 | Fan-cooled, temperature controlled. |
| Network power supply                    | 800 mA at 15 VDC                    |

## Environmental Specifications

**Table A-4** Environmental Specifications

|  |                                 |
|--|---------------------------------|
| Nominal Ambient temperature                    | 77 °F (25 °C)                   |
| Full Power Operating Ambient Temperature Range | −4 ° to 122 °F (−20 ° to 50 °C) |
| Maximum Operating Temperature                  | 140 °F (60 °C)                  |
| Storage temperature range                      | −40 ° to 185 °F (−40 to 85 °C)  |
| Humidity: Operation/Storage                    | ≤ 95% RH, non-condensing        |

---

## Physical Specifications with Projections

Table A-5 Physical Specifications

|        |                       |
|--------|-----------------------|
| Length | 16.19 inches (411 mm) |
| Width  | 14.20 inches (361 mm) |
| Height | 8.1 inches (208 mm)   |
| Weight | 67 lbs (30 kg)        |

## Regulatory Approvals

|        |   |
|--------|---|
| Safety | CSA certified to CSA C22.2 No. 107.1-01 and UL 458, 4th edition |
| EMC    | FCC and Industry Canada Class B                                 |

## Fan Operation

The internal cooling fans are automatic temperature-controlled.

---

**Important:** This internal temperature of the inverter/charger may be caused by heat in the inverter/charger or by high ambient temperature.

---

The bottom fan is an exhaust fan and runs continuously.

## Invert Power Derating vs Ambient Temperature

The inverter/charger delivers up to 2000 watts continuous of sine wave output to 50 °C ambient temperature and 1500 watts continuous of sine wave output to 60 °C ambient temperature, derated linearly from 50 °C to 60 °C.

If the unit is in elevated ambient temperature above 50 °C, you are required to reduce power draw according to the Figure A-1 to avoid over-temperature shutdown.

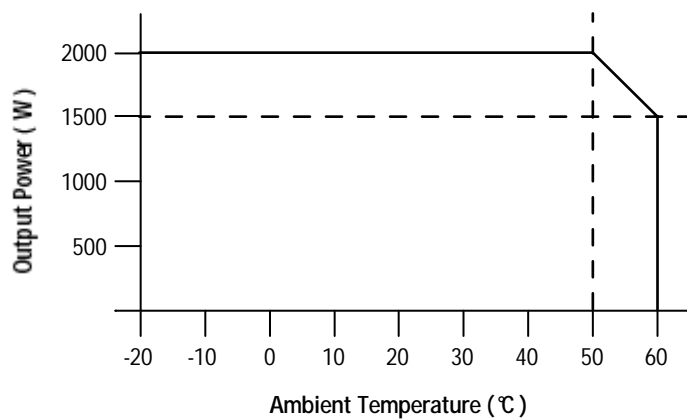

Figure A-1 Inverter Output Power vs Ambient Temperature

## Charger Mode

Charger output (bulk mode) is 100 amps DC to 50 °C ambient. In higher ambients, the charger will automatically derate (reduce output current) to maintain internal temperatures at a safe level. Output at 60 °C ambient is approximately 75 amperes.

# B

## Battery Charging Reference

Appendix B, “Battery Charging Reference” describes the multistage charging algorithm (formula) of the RS2000.

## Charging Algorithms (Formulas)

### Battery Type

|                  |  |
|------------------|--|
|                  | RS2000 charges flooded (or wet) lead-acid, gel, AGM (absorbed glass mat), and custom batteries.  |
| Flooded (or wet) | Flooded (or wet) batteries have removable battery caps for refilling with distilled water and testing the electrolyte.   |
| Gel              | Gel batteries have the electrolyte in the form of a gel rather than a liquid and do not require topping up. Gel batteries are sealed and the battery caps are not removable. |
| AGM              | AGM (absorbed glass mat) batteries are similar to gel batteries except that the electrolyte is absorbed into a fiberglass matting.   |
| Custom           | Custom is configured by the dealer, factory, or service center for battery types other than those listed above.  |



### **WARNING: Risk of battery damage**

Since the RS2000 has only one battery type setting for all batteries connected to its bank, *do not mix* battery types. All connected batteries should be of one kind: Flooded (or wet) *or* Gel *or* AGM *or* Custom.

---

## Charge Algorithm Stages

### Three-stage charging

If three-stage charging is enabled, the RS2000 will charge batteries in a sequence known as three-stage charging. The charging voltage delivered to the battery depends on the battery:

- type setting
- temperature (by switch setting or battery temperature sensor)
- state of charge

The three automatic stages are:

- bulk
- absorption
- float

See Figure B-1 for a graph of the three-stage charging profile.

There is a fourth stage, equalization, which is initialized manually as it is only performed occasionally and only on flooded (or wet) batteries.

## Bulk Charge

In the first stage—the bulk charge—RS2000 delivers its full-rated output current. This constant current is delivered to the batteries until the battery voltage approaches its gassing voltage—typically around 13.5 volts for 12 volt batteries. The bulk charge stage restores about 75% of the battery's charge.

The exit from bulk stage to the next stage, absorption, occurs under the following condition:

- battery voltage is more than the gassing voltage ( $V_G$ ) for a specified amount of time (3 minute default).

With an AC reconnect to qualified AC from the utility power or a generator during the bulk stage, the unit will return to the bulk stage. See “AC Reconnect Summary” on page B-7.

## Absorption Charge

During the first part of absorption charge, the RS2000 delivers its full rated output current until the absorption voltage is reached. At this point, the RS2000 will transition to a constant voltage mode by keeping the charge voltage constant at the absorption voltage level, and the battery gradually reduces the charging current it demands as the battery attains full charge.

The absorption stage has the following exit criteria:

- Overall time in absorption timeout ( $\Delta T_A$ ) has a default of 6 hours.
- Time in constant voltage absorption timeout ( $\Delta T_{CV}$ ) has a default of 1 hour.
- Charge current level drops below a specified limit ( $I_H$ ) for a specified amount of time, which has a default of 2% of C in Ah for 3 minutes.

See “Charge Algorithm Definitions” on page B-6 for more information.

With an AC reconnect during the absorption stage, the unit will transition to the float stage for three-stage charging and no-float stage for two-stage charging. See “AC Reconnect Summary” on page B-7.

## Float Charge

In the third stage—the float charge—which is a maintenance mode, the output voltage of the charger is reduced to a lower level, typically about 13.5 ( $V_{F1}$ ) volts to maintain the battery's charge without losing electrolyte through gassing.

In the float mode, the charger will initiate a new three-stage charge cycle under any of these conditions:

- any battery drops below 12.5 VDC for 15 minutes ( $V_{F2}$ )
- 21 days have passed from the time the charger completed Absorption ( $\Delta T_F$ )

With AC reconnect during this stage, the unit will return to the float stage. See “AC Reconnect Summary” on page B-7.

## Equalization Charge

The equalization charge must be manually initiated from the System Control Panel because it is not required each time the battery is recharged. Equalization is a deliberate overcharge designed to return each cell to optimum condition by reducing sulfation and stratification in the battery. The overcharge helps the battery to reach and maintain peak capacity.

An equalization charge should be performed *only* on flooded, vented (non-sealed or “wet”) batteries. It should be performed only if recommended by the battery manufacturer and only as often as specified.

After initiating an equalize charge cycle, the charger will always execute a bulk and absorption charge stage before starting the actual equalize charge stage. The equalize charge stage has a default current and voltage setpoint at 10% of C in Ah and 15.8 VDC, respectively. During the equalize charge stage, the charger will produce current equal to the current setpoint as long as the battery voltage is still less than the voltage setpoint. When the voltage setpoint is reached, the charger will change its current output to keep the battery voltage steady at the voltage setpoint level.

There is a timeout (default is 1 hour) for the equalize charge stage. The charger will exit equalize after the timeout has occurred, even if the voltage setpoint has not been reached. Should another equalize cycle be required, it has to be manually initiated from the System Control Panel.

Should an AC reconnect occur during the equalize charge stage, the charger will return to the float/no-float charge stage, depending on which one is selected.



## Two-Stage Charging

If the two-stage charge is enabled, the charger finishes the absorption charge but does not go to float mode because some battery manufacturers advise against floating their batteries. The RS2000 goes into a monitoring mode instead where the charger monitors the batteries but does not float them.

A new two-stage charge cycle will be initiated under the same conditions as for three-stage charging.

## Charge Algorithm Graph

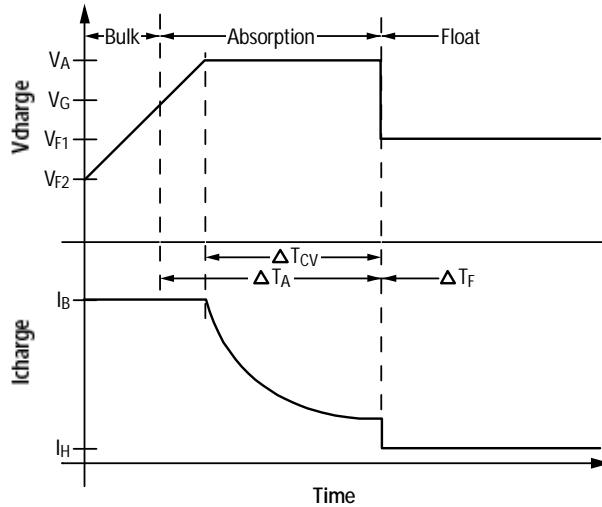

Figure B-1 Three-stage Charging Profile

## Charge Algorithm Definitions

Table B-1 Battery Defaults

| Voltage  |                               | Flooded (or wet) | Gel    | AGM    |
|----------|-------------------------------|------------------|--------|--------|
| $V_A$    | Absorption Voltage (VDC)      | 14.4             | 14.4   | 14.3   |
| $V_G$    | Gassing Voltage (VDC)         | 13.5             | 13.8   | 13.45  |
| $V_{F1}$ | Float Voltage (VDC)           | 13.5             | 13.8   | 13.45  |
| $V_{F2}$ | Float Exit Voltage (VDC)      | 12.5             | 12.5   | 12.5   |
| $V_E$    | Equalize Voltage (VDC)        | 15.8             | NA     | NA     |
| Current  |                               | Flooded (or wet) | Gel    | AGM    |
| $I_B$    | Bulk Current (ADC)            | 20% Ah           | 20% Ah | 20% Ah |
| $I_H$    | Absorption Exit Current (ADC) | 2% Ah            | 2% Ah  | 2% Ah  |
| $I_E$    | Equalize Current (ADC)        | 10% Ah           | NA     | NA     |

| Time            |   | Flooded (or wet) | Gel | AGM |
|-----------------|---|------------------|-----|-----|
| $\Delta T_A$    | Absorption Timeout (hours)                  | 6                | 6   | 6   |
| $\Delta T_{CV}$ | Constant Voltage Absorption Timeout (hours) | 1                | 1   | 1   |
| $\Delta T_F$    | Float Timeout (days)                        | 21               | 21  | 21  |
| $\Delta T_E$    | Equalize Timeout (hours)                    | 1                | NA  | NA  |

---

**Important:** The custom battery factory defaults are the same as for an AGM battery.

---

## AC Reconnect Summary

If AC is disconnected during charging, the charge stage after AC is reconnected is indicated in Table B-2.

Table B-2 AC Reconnect Summary

| Charge Stage        |                    |
|---------------------|--------------------|
| Before AC Reconnect | After AC Reconnect |
| Bulk                | Bulk               |
| Absorption          | Float/No Float     |
| Float/No Float      | Float/No Float     |
| Equalize            | Float/No Float     |



# C

## Terminology

This section provides a glossary of terms and a listing of abbreviations used in this guide.

---

## Glossary

|                                  |  |
|----------------------------------|--|
| <b>Absorption Charge</b>         | The second stage of three-stage battery charging. Voltage remains constant and current reduces as the battery becomes charged. This ensures complete charging.   |
| <b>Alternating Current (AC)</b>  | The type of electrical power supplied by the power utility or an AC generator. The unique characteristic of this form of electricity is that it reverses direction at regular intervals. For example, 120 VAC 60 Hz power reverses flow 60 times a second, hence the rating 60 Hz (cycles per second).                           |
| <b>Ambient Temperature</b>       | Refers to the air temperature around the inverter, which will affect its output power.   |
| <b>Ampere (Amp)</b>              | A measurement of the flow of electrical current. One amp is equal to the current that flows when one volt is acting across the resistance of one ohm. (Ohm's law: $I = V/R$ where $I$ =current, $V$ =volts, $R$ =resistance)   |
| <b>Ampere Hour (Amp Hour/Ah)</b> | One amp of electrical current flowing for one hour. One way to measure the capacity of batteries.  |
| <b>Bulk Charge</b>               | The first stage of three-stage battery charging. Current is supplied to the batteries at a constant rate while voltage gradually rises.  |
| <b>Charger, DC</b>               | A device that is used to replenish the capacity of a battery (its "charge") by supplying DC current to the battery.  |
| <b>Current</b>                   | The rate of flow of electrical charge measured in amps.  |
| <b>Direct Current (DC)</b>       | The type of electricity stored in batteries and generated by solar electric devices. Current flows in a single direction without alternating.  |
| <b>Disable</b>                   | When a function is disabled, it is not allowed to occur and if it is occurring, it is terminated. Regardless of other conditions, the function will not be activated. For example, even if AC power is present, if the charger is disabled, the unit will not charge. The charger must be enabled. See "Enable" in the glossary. |
| <b>Discharge</b>                 | Stored energy being released from a battery  |
| <b>DC Loads</b>                  | These loads are those that run off a DC electrical system (battery). A few examples of DC loads are pumps, lights, fans, power vents, toilet, inverters, and some water heaters. DC loads rely on the batteries for power.   |

|   |  |
|---|--|
| <b>Electrolyte</b>                      | The liquid found inside storage batteries. Electrolyte is a conductive medium in which the flow of electricity takes place. In lead-acid batteries, the electrolyte is an acid-water mixture.  |
| <b>Enable</b>                           | When a function is enabled, it is allowed to occur but other conditions may have to be met before the function is activated or turned on. For example, the charger function on the RS2000 may be enabled, but it will not charge unless qualified AC power is present.   |
| <b>Float Charge</b>                     | The third stage of three-stage battery charging. After batteries reach full charge, charging voltage is reduced to a lower level to prevent gassing and to prolong battery life. This stage is often referred to as a maintenance charge. Rather than charging a battery, it keeps an already-charged battery from discharging while providing load current. |
| <b>Hertz (Hz)</b>                       | The frequency, or number of times per second, that the flow of AC electricity reverses itself. Also referred to as cycles per second (see alternating current).  |
| <b>Idle Current</b>                     | The amount of electrical current drawn from the battery to keep an inverter running without a load.  |
| <b>Inductive Loads</b>                  | TVs, VCRs, stereos, computers, and electric motors (power tools, vacuum cleaners, for example) are examples of inductive loads which surge on start up. They require a high startup current compared to a resistive load such as a toaster or a coffee pot.  |
| <b>Inverter</b>                         | A device that converts DC power to AC power.   |
| <b>Light Emitting Diode (LED)</b>       | An LED is a type of solid-state lamp used to display various status functions.   |
| <b>Load</b>                             | Any device that consumes electricity in order to operate. Appliances, tools, and lights are examples of electrical loads. There are different types of loads such as AC loads and DC loads.  |
| <b>Low Battery Protection</b>           | A control circuit that minimizes the flow of electricity from batteries to the inverter when battery voltage drops below a determined level.   |
| <b>National Electric Code</b>           | The electrical wiring and installation code used in the United States (NFPA 70).   |
| <b>Overload/Over-current Protection</b> | A control circuit designed to protect a device (wire, inverter or charger, for example) from loads exceeding its capacity. A fuse, for example, is an over-current protection device. All Xantrex inverters have internal circuitry to protect themselves from overload/over-current conditions.   |

## Terminology

|                            |  |
|----------------------------|--|
| <b>Parallel Wiring</b>     | A group of electrical devices, such as batteries or PV modules, wired together to increase current, while voltage remains constant. Two 100 amp-hour 12 VDC batteries wired in parallel form a 200 amp-hour 12 VDC battery bank.   |
| <b>Resistive Loads</b>     | Toasters, coffee pots, and incandescent lights are examples of resistive loads. They use a resistive heater element to generate heat or light.   |
| <b>Series Wiring</b>       | A group of electrical devices, such as batteries or PV modules, wired together to increase voltage, while current remains constant. Two 100 amp-hour 12 VDC batteries wired in series form a 100 amp hour 24 VDC battery bank.   |
| <b>Sine Wave</b>           | The standard waveform of electric utility AC power. A sine wave is a rounded, smooth waveform alternating above and below zero volts.  |
| <b>Surge Capacity</b>      | The amount of current an inverter can deliver for short periods of time. Most electric motors draw up to six to ten times their rated current when starting. An inverter will “surge” to meet these motor-starting requirements. Most Xantrex inverters have surge capacities at least twice their continuous ratings. |
| <b>Transfer Switch, AC</b> | A switch that selects between two sources of AC power and isolates those sources from each other.  |
| <b>Volts</b>               | A unit of measure of electric potential. Voltage is often explained using a liquid analogy, comparing water pressure to voltage. For example, a high pressure hose would be similar to high voltage.   |
| <b>Watt(s)</b>             | A measure of true electrical power. Watts are calculated by multiplying volts times amps for resistive loads. For non-resistive loads, watts are calculated by multiplying volts times amps times power factor. ( $P=I \times V$ , where P=power, I=current, V=volts)  |
| <b>Watt Hour (W/h)</b>     | Electrical power measured over a period of time. One watt hour of electricity is equivalent to one watt of power being consumed for one hour. A 3-watt light operated for 2 hours would consume 6 Wh (watt hour) of electricity.   |
| <b>Volt-amps (VA)</b>      | A measure of the “apparent” power equivalent to the true power (watts) in resistive loads, but exceeding watts in non-resistive loads. VA is calculated by multiplying volts times amps without using power factor.  |



## Abbreviations

| Abbreviation | Full name                         | Definition  |
|--------------|-----------------------------------|---|
| A            | Ampere (Amps)                     | See Glossary.   |
| AC           | Alternating Current               | See Glossary.   |
| AGM          | Absorbed Glass Mat                | A type of battery in which the electrolyte or battery fluid is contained in glass-fibre mats between battery plates.  |
| Ah           | Ampere hour (amp hour)            | See Glossary.   |
| ASC          | Authorized Service Center         | ASC's are service centers affiliated with Xantrex to provide repair service.  |
| AWG          | American Wire Gauge               | A standard used for indicating wire size: the larger the AWG number, the smaller the wire size.   |
| BTS          | Battery Temperature Sensor        | A BTS is a device attached to a battery and inverter/charger to ensure that charge delivered to the batteries is adjusted according to their actual temperatures. |
| CEC          | Canadian Electric Code            | The CEC is the Canadian national electrical code providing the industry standard for safe electrical installations.   |
| CSA          | Canadian Standards Association    | A standards writing and certification body which tests and approves products for regulatory compliance to international standards.                                |
| DC           | Direct Current                    | See Glossary.   |
| EMC          | Electro-Magnetic Compatibility    | The ability of an electronic device to operate without causing or suffering from radio frequency interference.  |
| FCC          | Federal Communications Commission | US agency which regulates EMC and television, radio, wireless, cable, and satellite in the US.  |
| GFCI         | Ground Fault Circuit Interrupter  | GFCI is a device that protects against electric shock. A GFCI trips and stops the flow of power when leakage current is detected.                                 |
| Hz           | Hertz                             | see Glossary  |
| LED          | Light Emitting Diode              | see Glossary  |
| mA           | Milliamps                         | 1/1000 of an amp  |
| NEC          | National Electric Code            | See Glossary.   |
| RMA          | Return Material Authorization     | The authorization provided to a customer to return materials to Xantrex.  |
| RMS          | Root Mean Square                  | A measure of the effective value of an alternating (AC) voltage, current or power.  |

## Terminology

| Abbreviation | Full name                 | Definition   |
|--------------|---------------------------|--|
| SOC          | State of charge           | Indicates the quantity of electrical energy stored inside a battery.   |
| UL           | Underwriters Laboratory   | A standards writing and certification body which tests and approves products for regulatory compliance to international standards. |
| THD          | Total Harmonic Distortion | A measure of how pure or clean a waveform is.  |
| VAC          | Volts Alternating Current | See Alternating Current in Glossary.   |
| VDC          | Volts Direct Current      | See Direct Current in Glossary.  |
| W            | Watts                     | See Glossary.  |
| °C           | Degrees Celsius           | Temperature system that uses 0 °C for the freezing point and 100 °C for the boiling point of water.                                |
| °F           | Degrees Fahrenheit        | Temperature system that uses 32 °F as the freezing point and 212 °F as the boiling point of water.                                 |

# Warranty and Product Information

## Warranty

**What does this warranty cover?** This Limited Warranty is provided by Xantrex Technology, Inc. ("Xantrex") and covers defects in workmanship and materials in your RS2000 Sine Wave Inverter/Charger. This warranty period lasts for 36 months from the date of purchase at the point of sale to you, the original end user customer. You require proof of purchase to make warranty claims.

This Limited Warranty is transferable to subsequent owners but only for the unexpired portion of the Warranty Period. Subsequent owners also require proof of purchase.

What will Xantrex do?

Xantrex will, at its option, repair or replace the defective product free of charge, provided that you notify Xantrex of the product defect within the Warranty Period, and provided that Xantrex through inspection establishes the existence of such a defect and that it is covered by this Limited Warranty.

Xantrex will, at its option, use new and/or reconditioned parts in performing warranty repair and building replacement products. Xantrex reserves the right to use parts or products of original or improved design in the repair or replacement. If Xantrex repairs or replaces a product, its warranty continues for the remaining portion of the original Warranty Period or 90 days from the date of the return shipment to the customer, whichever is greater. All replaced products and all parts removed from repaired products become the property of Xantrex.

Xantrex covers both parts and labor necessary to repair the product, and return shipment to the customer via a Xantrex-selected non-expedited surface freight within the contiguous United States and Canada. Alaska and Hawaii are excluded. Contact Xantrex Customer Service for details on freight policy for return shipments outside of the contiguous United States and Canada.

**How do you get service?** If your product requires troubleshooting or warranty service, contact your merchant. If you are unable to contact your merchant, or the merchant is unable to provide service, contact Xantrex directly at:

Telephone: 1 800 670 0707 (toll free North America)  
1 360 925 5097 (direct)

Fax: 1 800 994 7828 (toll free North America)  
1 360 925 5143 (direct)

Email: customerservice@xantrex.com

Direct returns may be performed according to the Xantrex Return Material Authorization Policy described in your product manual. For some products, Xantrex maintains a network of regional Authorized Service Centers. Call Xantrex or check our website to see if your product can be repaired at one of these facilities.

## Warranty and Return

---

**What proof of purchase is required?** In any warranty claim, dated proof of purchase must accompany the product and the product must not have been disassembled or modified without prior written authorization by Xantrex.

Proof of purchase may be in any one of the following forms:

- The dated purchase receipt from the original purchase of the product at point of sale to the end user, or
- The dated dealer invoice or purchase receipt showing original equipment manufacturer (OEM) status, or
- The dated invoice or purchase receipt showing the product exchanged under warranty

**What does this warranty not cover?** This Limited Warranty does not cover normal wear and tear of the product or costs related to the removal, installation, or troubleshooting of the customer's electrical systems. This warranty does not apply to and Xantrex will not be responsible for any defect in or damage to:

- a) the product if it has been misused, neglected, improperly installed, physically damaged or altered, either internally or externally, or damaged from improper use or use in an unsuitable environment;
- b) the product if it has been subjected to fire, water, generalized corrosion, biological infestations, or input voltage that creates operating conditions beyond the maximum or minimum limits listed in the Xantrex product specifications including high input voltage from generators and lightning strikes;
- c) the product if repairs have been done to it other than by Xantrex or its authorized service centers (hereafter "ASCs");
- d) the product if it is used as a component part of a product expressly warranted by another manufacturer;
- e) the product if its original identification (trade-mark, serial number) markings have been defaced, altered, or removed.

## Disclaimer

### Product

THIS LIMITED WARRANTY IS THE SOLE AND EXCLUSIVE WARRANTY PROVIDED BY XANTREX IN CONNECTION WITH YOUR XANTREX PRODUCT AND IS, WHERE PERMITTED BY LAW, IN LIEU OF ALL OTHER WARRANTIES, CONDITIONS, GUARANTEES, REPRESENTATIONS, OBLIGATIONS AND LIABILITIES, EXPRESS OR IMPLIED, STATUTORY OR OTHERWISE IN CONNECTION WITH THE PRODUCT, HOWEVER ARISING (WHETHER BY CONTRACT, TORT, NEGLIGENCE, PRINCIPLES OF MANUFACTURER'S LIABILITY, OPERATION OF LAW, CONDUCT, STATEMENT OR OTHERWISE), INCLUDING WITHOUT RESTRICTION ANY IMPLIED WARRANTY OR CONDITION OF QUALITY, MERCHANTABILITY OR FITNESS FOR A PARTICULAR PURPOSE. ANY IMPLIED WARRANTY OF MERCHANTABILITY OR FITNESS FOR A PARTICULAR PURPOSE TO THE EXTENT REQUIRED UNDER APPLICABLE LAW TO APPLY TO THE PRODUCT SHALL BE LIMITED IN DURATION TO THE PERIOD STIPULATED UNDER THIS LIMITED WARRANTY.

IN NO EVENT WILL XANTREX BE LIABLE FOR ANY SPECIAL, DIRECT, INDIRECT, INCIDENTAL OR CONSEQUENTIAL DAMAGES, LOSSES, COSTS OR EXPENSES HOWEVER ARISING WHETHER IN CONTRACT OR TORT INCLUDING WITHOUT RESTRICTION ANY ECONOMIC LOSSES OF ANY KIND, ANY LOSS OR DAMAGE TO PROPERTY, ANY PERSONAL INJURY, ANY DAMAGE OR INJURY ARISING FROM OR AS A RESULT OF MISUSE OR ABUSE, OR THE INCORRECT INSTALLATION, INTEGRATION OR OPERATION OF THE PRODUCT.

### Exclusions

If this product is a consumer product, federal law does not allow an exclusion of implied warranties. To the extent you are entitled to implied warranties under federal law, to the extent permitted by applicable law they are limited to the duration of this Limited Warranty. Some states and provinces do not allow limitations or exclusions on implied warranties or on the duration of an implied warranty or on the limitation or exclusion of

incidental or consequential damages, so the above limitation(s) or exclusion(s) may not apply to you. This Limited Warranty gives you specific legal rights. You may have other rights which may vary from state to state or province to province.

## Warning: Limitations On Use

Please refer to your product manual for limitations on uses of the product.

SPECIFICALLY, PLEASE NOTE THAT THE RS2000 SINE WAVE INVERTER/CHARGER SHOULD NOT BE USED IN CONNECTION WITH LIFE SUPPORT SYSTEMS OR OTHER MEDICAL EQUIPMENT OR DEVICES. WITHOUT LIMITING THE GENERALITY OF THE FOREGOING, XANTREX MAKES NO REPRESENTATIONS OR WARRANTIES REGARDING THE USE OF THE XANTREX RS2000 SINE WAVE INVERTER/CHARGER IN CONNECTION WITH LIFE SUPPORT SYSTEMS OR OTHER MEDICAL EQUIPMENT OR DEVICES.

Please note that the RS2000 Sine Wave Inverter/Charger is not intended for use as an uninterruptible power supply and Xantrex makes no warranty or representation in connection with any use of the product for such purposes.

Before returning a product directly to Xantrex you must obtain a Return Material Authorization (RMA) number and the correct factory "Ship To" address. Products must also be shipped prepaid. Product shipments will be refused and returned at your expense if they are unauthorized, returned without an RMA number clearly marked on the outside of the shipping box, if they are shipped collect, or if they are shipped to the wrong location.

When you contact Xantrex to obtain service, please have your instruction manual ready for reference and be prepared to supply:

- The serial number of your product
- Information about the installation and use of the unit
- Information about the failure and/or reason for the return
- A copy of your dated proof of purchase

Record these details in on page WA-4.

## Return Procedure

1. Package the unit safely, preferably using the original box and packing materials. Please ensure that your product is shipped fully insured in the original packaging or equivalent. This warranty will not apply where the product is damaged due to improper packaging.
2. Include the following:
  - The RMA number supplied by Xantrex Technology, Inc. clearly marked on the outside of the box.
  - A return address where the unit can be shipped. Post office boxes are not acceptable.
  - A contact telephone number where you can be reached during work hours.
  - A brief description of the problem.
3. Ship the unit prepaid to the address provided by your Xantrex customer service representative.

**If you are returning a product from outside of the USA or Canada** In addition to the above, you MUST include return freight funds and are fully responsible for all documents, duties, tariffs, and deposits.

**If you are returning a product to a Xantrex Authorized Service Center (ASC)** A Xantrex return material authorization (RMA) number is not required. However, you must contact the ASC prior to returning the product or presenting the unit to verify any return procedures that may apply to that particular facility.

## Out of Warranty Service

If the warranty period for your RS2000 Sine Wave Inverter/Charger has expired, if the unit was damaged by misuse or incorrect installation, if other conditions of the warranty have not been met, or if no dated proof of purchase is available, your inverter may be serviced or replaced for a flat fee.

To return your RS2000 Sine Wave Inverter/Charger for out of warranty service, contact Xantrex Customer Service for a Return Material Authorization (RMA) number and follow the other steps outlined in "Return Procedure" on page WA-3.

Payment options such as credit card or money order will be explained by the Customer Service Representative. In cases where the minimum flat fee does not apply, as with incomplete units or units with excessive damage, an additional fee will be charged. If applicable, you will be contacted by Customer Service once your unit has been received.

## Information About Your System

As soon as you open your RS2000 Sine Wave Inverter/Charger package, record the following information and be sure to keep your proof of purchase.

- Serial Number \_\_\_\_\_
- Purchased From \_\_\_\_\_
- Purchase Date \_\_\_\_\_

If you need to contact Customer Service, please record the following details before calling. This information will help our representatives give you better service.

- Type of installation (e.g. RV, truck) \_\_\_\_\_
  - Length of time inverter/charger has been installed \_\_\_\_\_
  - Battery/battery bank size \_\_\_\_\_
  - Battery type (e.g. flooded (or wet), sealed gel cell, AGM) \_\_\_\_\_
  - DC wiring size and length \_\_\_\_\_
  - Description of indicators on front panel \_\_\_\_\_
  - Appliances operating when problem occurred \_\_\_\_\_
  - Description of problem \_\_\_\_\_
- 
- Any fault or warning displayed if using a System Control Panel?

# Index

## A

- absorption charge B-3
- AC knockout
  - illustrated 1-9
  - locations of 1-7
- AC reconnect summary B-7
- AC wiring compartment access panel 1-7
- AGM (absorbed glass mat) batteries B-2

## B

- batteries
  - AGM (absorbed glass mat) B-2
  - custom B-2
  - flooded B-2
  - gel B-2
  - wet B-2
- battery damage, risk of B-2
- battery temperature sensor
  - charger operation 2-15
  - features 1-11
  - illustrated 1-11
- battery temperature sensor jack, described 1-9
- battery types, description of B-2
- bulk charge B-3

## C

- charge algorithm definitions B-6
- charge algorithm graph B-6
- charge algorithm stages
  - three-stage B-2
  - two-stage B-5
- charger mode A-6
- charger operation, operating limits 2-20
- charging
  - battery temperature sensor 1-4
  - built-in charge formulas 1-4
  - dead battery 1-4
  - described 1-3
  - equalization 1-4
  - load management 1-4
- charging formulas. See charging algorithms. B-2
- chassis ground point, described 1-10
- configurable settings
  - how to select and adjust 3-6

- configuration sub-menus 3-18
- configure RS2000 menu
  - advanced 3-18
  - basic 3-11
- Customer Service
  - email v
  - fax number v
  - phone number 1-v
  - preparing to call WA-4

## D

- DC terminal covers 1-11
- DC terminals
  - described 1-10
  - negative 1-10
  - positive 1-10
- dead battery charging 1-4
- Down arrow button 2-4
- dual network jacks, described 1-10

## E

- electronic protection 1-6
- Enter button 2-4
- equalization
  - precharging 2-18
  - procedure 2-16, 2-17
  - recommended frequency 2-16
  - terminating 2-20
- equalization charge B-4
- Ethernet incompatibility 1-9

## F

- fan
  - bottom 1-7
  - operation A-5
  - top fan 1-7
- fault
  - automatic 4-2
  - definition 2-22, 4-11
  - escalating automatic 4-2
  - manual 2-22, 4-2
- fault types 4-2
- faults and warnings 4-2

**FCC**

- compliance A-5
- regulations x

float charge B-4

Force Charge, defined 3-25

front panel

- described 1-7
- illustrated 1-7

front panel light

- Absorption 2-22
- Bulk 2-22
- Charger ON 2-21
- Equalize 2-22
- External AC 2-21
- Fault 2-21
- Float 2-22
- Inverter ON 2-21
- Low Battery 2-21
- Network 2-21

front panel lights and buttons

- described 1-8
- illustrated 1-8

**H**

hibernate mode 2-11

- bringing system out of 2-11
- when to use 2-11

**I**

Information about Your System form WA-4

invert power derating A-6

inverter

- purchase date WA-4
- serial number WA-4

inverter operation, operating limits 2-13

inverting, described 1-3

**L**

load sense mode 1-3, 2-12

**M**

mounting flanges

- described 1-9

**P**

power save mode

- entering and exiting 2-8

when to use 2-7

power share, described 2-20

proof of purchase WA-4

protection features 1-6

purchase date WA-4

**R**

regulatory approvals A-5

RS2000 advanced menu, selecting 3-21

RS2000 basic menu

- example of 3-5
- returning to 3-22
- selecting 3-5

RS2000 configuration menus, described 3-7

RS2000 device menu, described 3-9

RS2000 menu structure, illustrated 3-8

**S**

safe mode

- caution 2-8
- exiting 2-10

safety instructions vii

Select Device menu, viewing 3-4

serial number WA-4

side panel features

- described 1-9
- illustrated 1-9

specifications

- charger A-3
- environmental A-4
- general A-4
- inverter A-2
- physical A-5
- transfer A-4

system button

- described 2-6
- illustrated 2-6

system check

- charging and inverting 2-5
- transfer switch 2-5

System Control Panel

- buttons described 2-3
- function of 2-2
- illustrated 2-6
- using 2-3

system menu map 3-3

system mode

- operate 2-7
- power save 2-7



---

system screen, example of 3–4

## T

three-stage charging algorithm B–2  
three-stage charging profile, illustrated B–2  
troubleshooting  
    fault messages 4–11  
    general guidelines 4–5  
    motor loads 4–17  
    problem loads 4–17  
    resistive loads 4–17  
    warning messages 4–7

## U

Up arrow button 2–4

## W

warning  
    automatic 4–3  
    definition 2–22  
    manual 4–3  
warning types 4–3  
warranty  
    out of warranty service WA–4  
    terms and conditions WA–1  
web site v

## X

Xanbus system  
    described 1–5  
    illustrated 1–5  
Xanbus-enabled 1–5  
Xantrex, web site v





**Xantrex Technology Inc.**

1 800 670 0707 Tel toll free NA  
1 360 925 5097 Tel direct  
1 800 994 7828 Fax toll free NA  
1 360 925 5143 Fax direct  
customerservice@xantrex.com  
www.xantrex.com

## Free Manuals Download Website

<http://myh66.com>

<http://usermanuals.us>

<http://www.somanuals.com>

<http://www.4manuals.cc>

<http://www.manual-lib.com>

<http://www.404manual.com>

<http://www.luxmanual.com>

<http://aubethermostatmanual.com>

Golf course search by state

<http://golfingnear.com>

Email search by domain

<http://emailbydomain.com>

Auto manuals search

<http://auto.somanuals.com>

TV manuals search

<http://tv.somanuals.com>