

Smart choice for power™

**xantrex™**

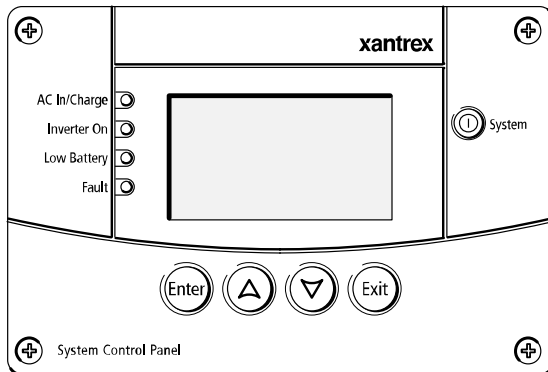

**Owner's Guide**

# System Control Panel



[www.xantrex.com](http://www.xantrex.com)



# System Control Panel

## Owner's Guide

## About Xantrex

Xantrex Technology Inc. ([www.xantrex.com](http://www.xantrex.com)), a subsidiary of Schneider Electric, is a world leader in the development, manufacturing and marketing of advanced power electronic products and systems for the renewable and mobile power markets. The company's products convert and control raw electrical power from any central, distributed, renewable, or backup power source into high-quality power required by electronic equipment and the electricity grid. Xantrex is headquartered in Vancouver, Canada, with facilities in the United States, Germany, Spain, India, and a joint venture in China.

## Trademarks

**Xantrex**, **Smart choice for power**, and **Xanbus** are trademarks of Schneider Electric International Services sprl, registered in the U.S. and other countries. Other trademarks, registered trademarks, and product names are the property of their respective owners and are used herein for identification purposes only.

## Notice of Copyright

System Control Panel Owner's Guide © February 2010 Xantrex Technology Inc. All rights reserved. No part of this document may be reproduced in any form or disclosed to third parties without the express written consent of: Xantrex Technology Inc., 161-G South Vasco Road, Livermore, California, USA 94551. Xantrex Technology Inc. reserves the right to revise this document and to periodically make changes to the content hereof without obligation or organization of such revisions or changes unless required to do so by prior arrangement.

## Exclusion for Documentation

UNLESS SPECIFICALLY AGREED TO IN WRITING, XANTREX TECHNOLOGY INC. ("XANTREX")

(A) MAKES NO WARRANTY AS TO THE ACCURACY, SUFFICIENCY OR SUITABILITY OF ANY TECHNICAL OR OTHER INFORMATION PROVIDED IN ITS MANUALS OR OTHER DOCUMENTATION;

(B) ASSUMES NO RESPONSIBILITY OR LIABILITY FOR LOSSES, DAMAGES, COSTS OR EXPENSES, WHETHER SPECIAL, DIRECT, INDIRECT, CONSEQUENTIAL OR INCIDENTAL, WHICH MIGHT ARISE OUT OF THE USE OF SUCH INFORMATION. THE USE OF ANY SUCH INFORMATION WILL BE ENTIRELY AT THE USER'S RISK; AND

(C) REMINDS YOU THAT IF THIS GUIDE IS IN ANY LANGUAGE OTHER THAN ENGLISH, ALTHOUGH STEPS HAVE BEEN TAKEN TO MAINTAIN THE ACCURACY OF THE TRANSLATION, THE ACCURACY CANNOT BE GUARANTEED. APPROVED XANTREX CONTENT IS CONTAINED WITH THE ENGLISH LANGUAGE VERSION WHICH IS POSTED AT [WWW.XANTREX.COM](http://WWW.XANTREX.COM).

## Date and Revision

February 2010 Revision D

## Part Number

975-0083-01-01

## Product Number

809-0910

## Contact Information

Telephone: 1 800 670 0707 (toll free North America)  
1 408 987 6030 (direct)

Fax: 1 800 994 7828 (toll free North America)

Email: [customerservice@xantrex.com](mailto:customerservice@xantrex.com)

Web: [www.xantrex.com](http://www.xantrex.com)

# About This Guide

## Purpose

The purpose of this Owner's Guide is to provide explanations and procedures for installing, operating, maintaining, and troubleshooting the System Control Panel.

## Scope

The Guide provides safety guidelines, setup information, and procedures for installing and configuring the System Control Panel. This Guide also includes information about operating and troubleshooting the unit. This Guide does not contain guidelines for configuring every Xanbus-enabled device that the System Control Panel monitors and controls. See the owner's guide or operation guide for each Xanbus-enabled device for detailed configuration information.

## Firmware Revision

The information in this manual applies to firmware revision 2.01.00. Some System Control Panel features and functions described in this manual may be incompatible with earlier firmware revisions. To view the firmware revision number of your product, see "Viewing device information" on page 4–11.

## Audience

The Guide is intended for anyone who needs to install and/or operate the System Control Panel. Installers should be certified technicians or electricians.

## Organization

This Guide is organized into six chapters and one appendix.

Chapter 1, "Introduction", introduces and describes features of the Xantrex System Control Panel.

Chapter 2, “Installation”, contains information and procedures for installing the System Control Panel.

Chapter 3, “System Configuration”, contains general information for using the System Control Panel to configure another device on the Xanbus system.

Chapter 4, “Configuration”, contains information and procedures for configuring the System Control Panel.

Chapter 5, “Operation”, contains information and procedures for operating the System Control Panel.

Chapter 6, “Troubleshooting”, contains reference tables of warning and fault messages.

Appendix A, “Specifications”, contains the electrical, mechanical, and environmental specifications for the System Control Panel.

## Conventions Used

The following conventions are used in this guide.



### WARNING

Warnings identify conditions or practices that could result in personal injury or loss of life

---



### CAUTION

Cautions identify conditions or practices that could result in damage to the unit or other equipment.

---

**Important:** These notes contain information that is important for you to know, but is not as critical as a caution or warning.

---

## Related Information

For more information about related products, refer to:

*Xanbus System Installation Guide* (975-0136-01-01)

*Automatic Generator Start Owner’s Guide* (975-0082-01-01)

You can find more information about Xantrex Technology Inc. as well as its products and services at [www.xantrex.com](http://www.xantrex.com).

# Important Safety Instructions



## **WARNING: Save these instructions**

This Owner's Guide contains important safety and operating instructions. Before using your System Control Panel, be sure to read, understand, and save these safety instructions.

---



## **WARNING: Restrictions on use**

The System Control Panel shall not be used in connection with life support systems or other medical equipment or devices.

---

## General Precautions

1. Before installing and using this device, read all appropriate sections of this guide and any cautionary markings on the System Control Panel and the devices to which it connects.
2. If the System Control Panel has been damaged, see "Warranty and Return Information" on page WA-1.
3. Do not dismantle the System Control Panel; it contains no user serviceable parts. See "Information About Your System" on page WA-4 for instructions on obtaining service.
4. Protect the System Control Panel from rain, snow, spray, and water.

## Explosive Gas Precautions



## **WARNING: Explosion hazard**

This equipment is not ignition protected. To prevent fire or explosion, do not install the System Control Panel in compartments containing flammable materials or in locations that require ignition-protected equipment. This includes any space containing gasoline-powered machinery, fuel tanks, as well as joints, fittings, or other connections between components of the fuel system.

---

## FCC Information to the User

This equipment has been tested and found to comply with the limits for a Class B digital device, pursuant to part 15 of the FCC Rules. These limits are designed to provide reasonable protection against harmful interference when the equipment is operated in a residential environment. This equipment generates, uses and can radiate radio frequency energy and, if not installed and used in accordance with the instruction guide, may cause harmful interference to radio communications. However, there is no guarantee that interference will not occur in a particular installation. If this equipment does cause harmful interference to radio or television reception, which can be determined by turning the equipment off and on, the user is encouraged to try to correct the interference by one or more of the following measures:

- Reorient or relocate the receiving antenna.
- Increase the separation between the equipment and the receiver.
- Connect the equipment into an outlet on a circuit different from that to which the receiver is connected.
- Consult the dealer or an experienced radio/TV technician for help.



# Contents

<b>Important Safety Instructions</b> .....	v
--	---

## **1 Introduction**

About the System Control Panel .....	1-2
Operational Features .....	1-3
Physical Features .....	1-3
Front panel features .....	1-3
Back panel features .....	1-5
System components .....	1-6

## **2 Installation**

Installing the System Control Panel .....	2-2
---	-----

## **3 System Configuration**

Configuring the System .....	3-2
Using System Control Panel buttons .....	3-2
Menu map .....	3-3
Changing settings for a device .....	3-4
Viewing the Select Device menu .....	3-4
Selecting the device from the Select Device menu .....	3-5
Selecting and adjusting the changeable setting .....	3-5

## **4 Configuration**

Configuring the System Control Panel .....	4-2
The System Panel Menu .....	4-2
Basic Menu Configuration Items .....	4-4
Advanced Menu Configuration Items .....	4-5
Using the Clock Menu .....	4-6
Clock Menu Configuration Items .....	4-7
Setting the time .....	4-7
Setting the date .....	4-8

Using the System Settings Menu----- 4-9  
System Settings Menu Configuration Items ----- 4-10  
    Changing the system mode ----- 4-10  
    Viewing device information ----- 4-11

## 5 Operation

Reading Screens and Menus----- 5-2  
    System screen ----- 5-2  
    Select Device menu ----- 5-3  
    Device menu ----- 5-4  
Viewing Advanced Menus----- 5-5  
    Displaying advanced menus for all devices ----- 5-5  
    Combining basic and advanced menus ----- 5-6  
Startup Behavior ----- 5-7  
System Modes ----- 5-7  
    Changing system modes ----- 5-7  
    Operating mode ----- 5-7  
    Safe mode ----- 5-7  
Warnings and Faults ----- 5-8  
    Warning messages ----- 5-8  
        Acknowledging warning messages ----- 5-9  
        Clearing warning messages ----- 5-9  
        Viewing multiple warning messages ----- 5-9  
        Viewing the System Control Panel warning log ----- 5-10  
        Viewing individual warning messages from the warning log ----- 5-11  
    Fault messages ----- 5-11  
        Viewing the System Control Panel fault log ----- 5-12  
        Viewing individual fault messages from the fault log ----- 5-13  
        Viewing multiple fault messages ----- 5-13

## 6 Troubleshooting

Troubleshooting Reference ----- 6-2  
    Types of Faults and Warnings ----- 6-2  
    Warning Reference Table ----- 6-2  
    Fault Reference Table ----- 6-4

**A Specifications**

Electrical Specifications----- A-2  
Mechanical Specifications ----- A-2  
Environmental Specifications ----- A-2

**Warranty and Return Information ----- WA-1**

**Index----- IX-1**



# 1

## Introduction

Chapter 1 introduces and describes features of the Xantrex System Control Panel, including the:

- Display screen
- Indicator lights
- Push Buttons
- Connector jacks
- Time-keeping, warning, and power-saving features

## About the System Control Panel

Complete system control

The Xantrex System Control Panel provides configuration and monitoring capability for a Xanbus system. The System Control Panel:

- Monitors activity throughout your power system.
- Displays the settings and status of each Xanbus-enabled device.
- Enables you to adjust settings for each Xanbus-enabled device.

System component

The System Control Panel uses Xanbus™, a network communications protocol developed by Xantrex, to communicate its settings and activity to other Xanbus-enabled devices.

Xanbus-enabled products are:

- Easy to use. The Xanbus network simplifies operation and automates routine tasks.
- Reliable. Software control eliminates errors due to analog signaling.
- Accurate. Digital information is less susceptible to interference and line loss.
- Upgradable. Software upgrades mean your purchase will remain up to date.



---

**Important:** The System Control Panel is compatible with Xanbus-enabled devices including RS, MS, TS and IS Series, and Freedom SW 3000 inverter/chargers as well as the Xantrex Automatic Generator Start. The System Control Panel is not compatible with Prosine, Freedom SW 2000, Freedom HW, and Freedom HF, RV, or SW Series inverter/chargers from Xantrex.

---

System requirements

The System Control Panel requires a Xanbus power supply to operate. Network power is carried by the network cables, and can be supplied by a Xanbus-enabled product (such as an inverter/charger) or an external Xanbus power supply.

As a device that draws network power, the System Control Panel consumes a maximum of 3 watts.

For detailed instructions and a complete list of Xanbus-enabled devices, visit the website at [www.xantrex.com](http://www.xantrex.com).

# Operational Features

Other features of the System Control Panel include:

- Time and date—has an internal clock that keeps time for the entire system.
- Audible alarm—if enabled, alerts you to a low battery condition in the system and notifies you when a fault condition arises.
- Low power consumption—automatically turns off the backlight and displays a screensaver after a period of inactivity to minimize battery drain.
- Non-volatile memory—preserves all its settings if network power is interrupted or network communication is disrupted.

## Physical Features

The System Control Panel has important features on the front and back of the unit. Features on the front of the System Control Panel are the display, indicator lights, and buttons for selecting device menus and changing settings (see Figure 1-1). The back of the unit features the inputs where the System Control Panel connects to the Xanbus system (see Figure 1-2).

### Front panel features

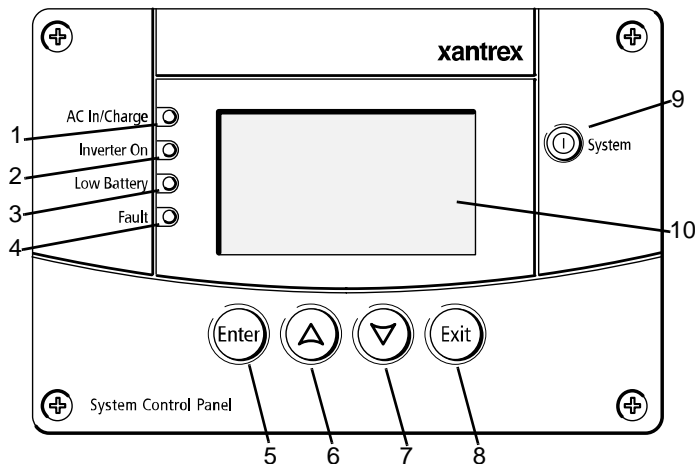

**Figure 1-1** System Control Panel front panel

Feature	Description
1	<b>AC In/Charge light</b> (green) indicates qualified AC is present at the input of an inverter/charger or charger.
2	<b>Inverter On light</b> (green) indicates an inverter is using energy from batteries to provide AC to your appliances.
3	<b>Low Battery light</b> (yellow) indicates that a low battery voltage condition exists in the system.
4	<b>Fault light</b> (red) indicates a device on the network is experiencing a fault and requires user attention and intervention.
5	<b>Enter button</b> <ol style="list-style-type: none"><li>1. Confirms selection of a menu item</li><li>2. Displays the next screen</li></ol>
6	<b>Up arrow button</b> <ol style="list-style-type: none"><li>1. Scrolls up one line of text</li><li>2. Increases a selected value</li></ol>
7	<b>Down arrow button</b> <ol style="list-style-type: none"><li>1. Scrolls down one line of text</li><li>2. Decreases a selected value</li></ol>
8	<b>Exit button</b> <ol style="list-style-type: none"><li>1. Cancels selection of a menu item</li><li>2. Displays the previous screen</li></ol>
9	<b>System button</b> puts all devices in the system into Safe mode (see page 5–7). <ul style="list-style-type: none"><li>• Hold for five seconds to activate Safe mode.</li><li>• Press momentarily to clear active faults.</li></ul>
10	<b>Screen</b> shows menus, settings, and system information.



## Back panel features

### Connectors

Two network connector inputs on the back panel let you connect the System Control Panel to other Xanbus-enabled devices. See Figure 1-2.

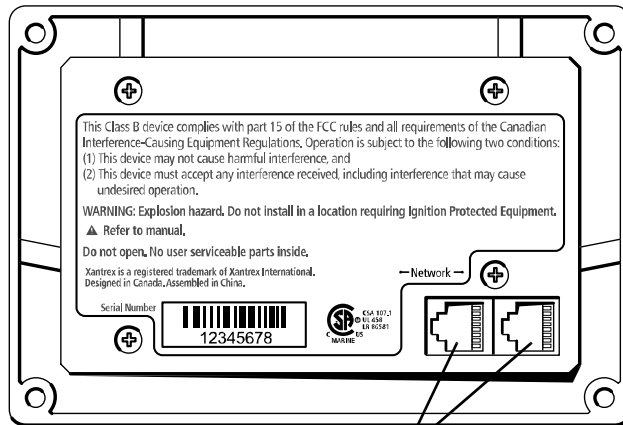

Network connectors (8-pin RJ45)

**Figure 1-2** System Control Panel rear panel

# System components

System description

The Xanbus system includes the System Control Panel and other Xanbus-enabled devices. Each device interacts and communicates with the other devices.

Network diagram

In Figure 1-3, network connections are represented by dotted lines and conventional electrical connections are represented by solid lines.

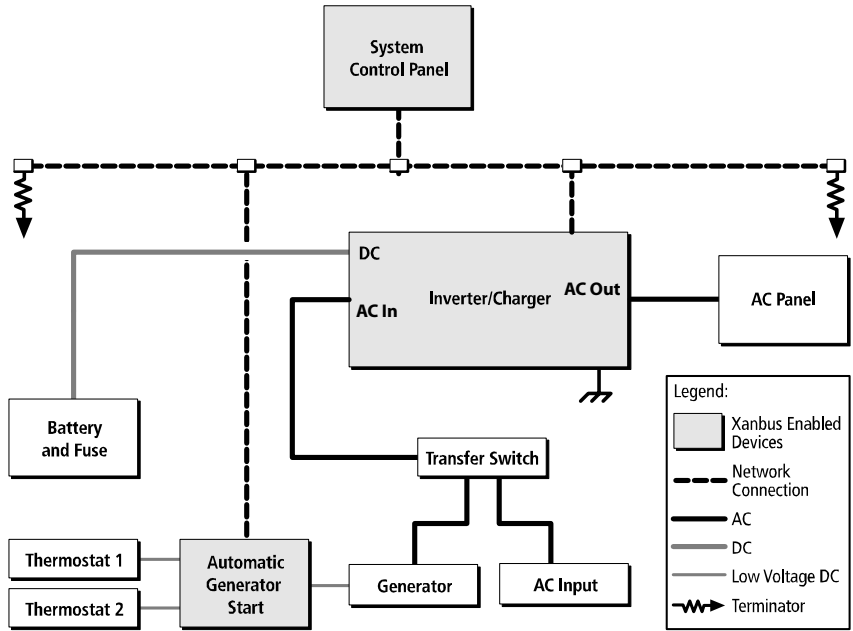

Figure 1-3 Network diagram

# 2

## Installation

Chapter 2 contains information and procedures for planning and performing a System Control Panel installation, including:

- Materials and tools required
- Choosing a location
- Mounting the unit
- Connecting the System Control Panel to other devices

## Installing the System Control Panel

The System Control Panel is designed to be flush mounted through an opening in a wall and secured with four #6 screws. Use the supplied mounting template to precisely mark the opening and screw hole locations.

Planning an installation      The System Control Panel requires no connections other than the network cables that plug into the back of the unit. Because you cannot access the network inputs once the unit is mounted, the network cables need to be routed through the wall before securing the System Control Panel.



### CAUTION

Allow at least 2 ¼ inches (57 mm) of space behind the wall to accommodate the depth of the unit and allow room for the network cables to bend.

---

Materials and tools required      Refer to the *Xanbus System Installation Guide* for more information about planning and installing a network that includes the System Control Panel.

You will need these materials and tools to complete the installation:

- mounting template sticker (supplied)
- four #6 screws (supplied)
- Phillips head screwdriver
- jigsaw or small keyhole saw
- power drill with 1/8" bit (optional)
- Xantrex network cables or equivalent

Choosing a location      Choose a location that is easily accessible. The System Control Panel should be mounted where it is easily visible, with unobstructed access to the screen and push buttons.

The location should be indoors, dry, and free from corrosive or explosive fumes.



### **WARNING: Fire hazard**

The System Control Panel is not ignition protected. Do not install in areas requiring ignition-protected equipment.

---



### **WARNING: Shock hazard**

Before making an opening in a wall, bulkhead, or panel, ensure there is no wiring or other obstruction within the wall.

---

#### **To mount the System Control Panel:**

1. Peel the backing from the supplied mounting template sticker and place it in your chosen installation location. Use the template to mark locations for the mounting holes and the area to be cut out.
  2. Pilot-drill the mounting holes (if necessary, depending on your mounting surface) and, using a jigsaw, cut out the hole in which the System Control Panel will be inserted.
  3. Route the network cable(s) from other Xanbus-enabled devices inside the wall and through the opening.
- 



### **CAUTION: Equipment damage**

Connect the System Control Panel only to other Xanbus compatible devices.

Although the cabling and connectors used in this network system are the same as Ethernet connectors, **this network is not an Ethernet system**. Equipment damage may result from attempting to connect these two different systems.

---

4. Connect the network cable(s) (and terminator if necessary) to either input on the back of the System Control Panel. See Figure 2-1.  
Connect one network cable and a network terminator to the System Control Panel if it is the last device at the end of a daisy chain-type network layout. Refer to the *Xanbus System Installation Guide* for more information.
5. Place the unit in the opening and secure it with four #6 screws.
6. Peel off the protective plastic coating covering the screen and indicator lights.

Verifying power is available

If network power (from an inverter/charger or external power supply) is present, the backlight will come on and the System Control Panel will show the startup screen (see page 3–3) for five to ten seconds, then show the System screen.

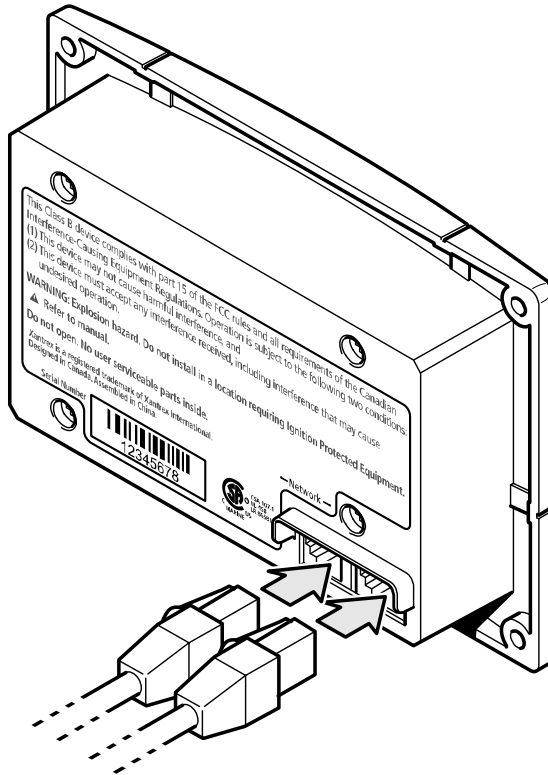

Figure 2-1 Connecting the network cables

# 3

## System Configuration

Chapter 3 contains guidelines for using the System Control Panel to configure another Xanbus-enabled device on the Xanbus system.

This chapter does not recommend specific settings for devices on your system. Refer to the Owner's Guide or Operation Guide for each Xanbus-enabled device for this information.

For information about configuring the System Control Panel itself, see Chapter 4, "Configuration".

# Configuring the System

System settings are changed from the System Control Panel. You can also use the System Control Panel to view the settings for any Xanbus-enabled device in the Xanbus system.

## Using System Control Panel buttons

The System Control Panel has four buttons for:

- moving between status screens and menus.
- highlighting settings you want to change.
- selecting values for Xanbus-enabled devices.

See Table 3-1 for the function of each button on the System Control Panel.

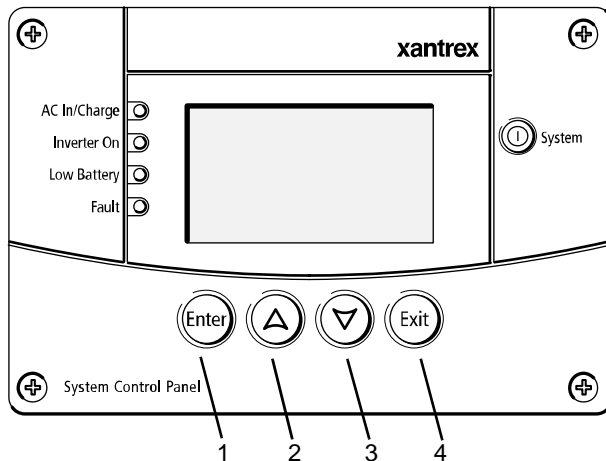

**Figure 3-1** System Control Panel

**Table 3-1** System Control Panel buttons

Number	Button	Function
1	Enter	<ul style="list-style-type: none"><li>• Displays the next screen</li><li>• Confirms selection of a menu item</li></ul>
2	Up arrow	<ul style="list-style-type: none"><li>• Scrolls up one line of text</li><li>• Increases a selected value</li></ul>
3	Down arrow	<ul style="list-style-type: none"><li>• Scrolls down one line of text</li><li>• Decreases a selected value</li></ul>
4	Exit	<ul style="list-style-type: none"><li>• Cancels selection of a menu item</li><li>• Displays the previous screen</li></ul>



## Menu map

Figure 3-2 shows how the System Control Panel screens and menus are organized. The screens and menus are described in Table 3-2.

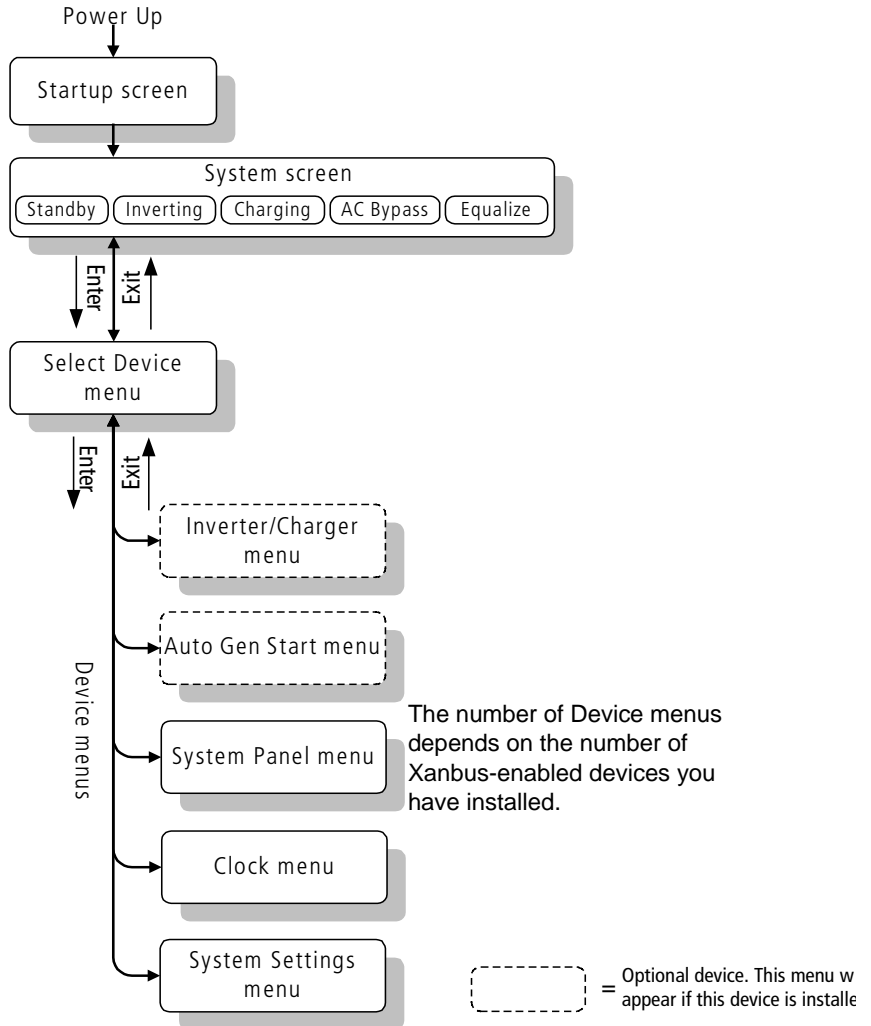

**Figure 3-2** System Control Panel menu map

**Table 3-2** Screen and menu descriptions

Screen or menu	Description
Startup screen	Appears for a few seconds after the system is powered on or after the system has been reset.
System screen	Displays status information for the power system. The System screen’s appearance varies with the status of the inverter/charger (Standby, Inverting, Charging, AC Bypass, or Equalize). The System screen always features a “Menu” arrow pointing to the Enter button.
Select Device menu	Displays a list of Xanbus-enabled devices in the system, including the System Control Panel. The length of this menu depends on how many devices are installed in the system. This menu also contains the clock menu (where you can set the time and date) and the system settings menu (where you can change system modes).
Device menus	Display status information and changeable settings. Changeable settings are identified by the square brackets [ ] around values in the right-hand column (see Figure 3-5 on page 3–6).

## Changing settings for a device

If you need to change a setting for a device on the system, use the buttons on the System Control Panel to perform these three basic steps:

- Starting at the System screen, view the Select Device menu.
- Select the device from the Select Device menu.
- Select and adjust a changeable setting on the device menu.

For more information about configuring devices on the system, see the guide for each device.

## Viewing the Select Device menu

The Select Device menu lists every Xanbus-enabled device in the power system.

### To view the Select Device menu:

- ◆ On the System screen, press Enter.

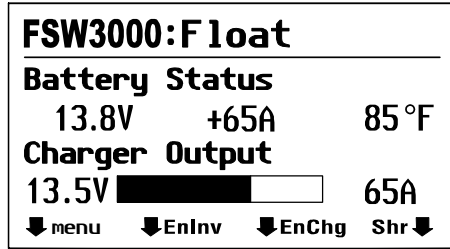

Figure 3-3 System screen of Freedom SW 3000 (example)

### Selecting the device from the Select Device menu

Use this procedure to select a device before changing a setting.

**To select a device:**

1. On the Select Device menu, press the down arrow button to highlight the device you want.

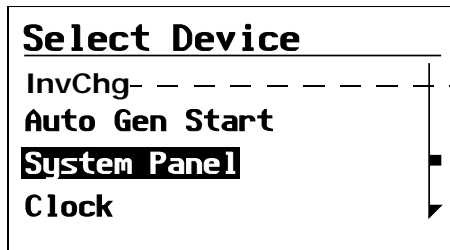

InvChg will show if there are no compatible inverter/chargers connected to the SCP.

Figure 3-4 Select Device menu

2. Press Enter.

The menu for the selected device appears.

### Selecting and adjusting the changeable setting

**Device menu** You can view and change device settings from the device menu. The number of settings on the device menu will depend on whether you have selected to view basic or advanced menus. See “Viewing Advanced Menus” on page 5–5.

**Identifying changeable settings** A device menu displays a list of status information and changeable settings. Changeable settings are enclosed in square brackets. Values in the right-hand column without brackets are status information only. You cannot select or change them.

Use this procedure to change any device setting.

**To select and adjust a setting:**

1. On the device menu, press the up arrow or down arrow button to highlight the setting you want to change.

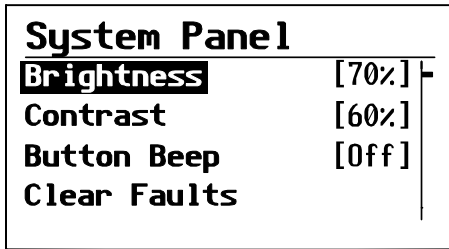

**Figure 3-5** Device menu (System Control Panel menu used for example)

2. Press Enter to highlight the current value of that changeable setting.

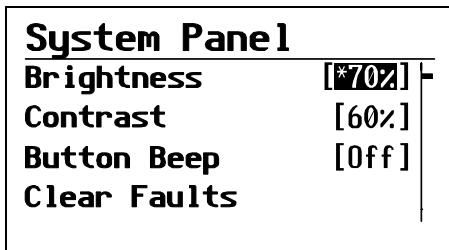

**Figure 3-6** Highlighting a setting

3. Press the up arrow or the down arrow button to change the value. Hold down the button to scroll through a large range of values quickly.

The previously set value appears with an asterisk (\*) beside it.

4. Press Enter to select the value.
5. If you have another setting to change, return to step 1.

Or

If you have no more settings to change, press Exit twice to return to the System screen.

# 4

# Configuration

Chapter 4 contains information and procedures for configuring:

- the System Control Panel on the System Panel menu.
- the time and date on the Clock menu.
- the system mode on the System Settings menu.

# Configuring the System Control Panel

You can configure the System Control Panel to suit your preferences and the requirements of the Xanbus system. Some of the configurable settings, such as the system time, affect the entire system. Other settings affect only the System Control Panel itself, such as the brightness of the display.

You can perform all these tasks on the System Panel menu, the Clock menu, and the System Settings menu.

## The System Panel Menu

Configuring the System Control Panel is done on the System Panel menu, which you can view in either basic or advanced formats. See “Viewing Advanced Menus” on page 5–5 for more information.

**Basic menu** The basic menu contains settings you may have to adjust routinely. The System Control Panel shows the basic menu by default.

**Advanced menu** The advanced menu contains all items on the basic menu, as well as additional configurable settings.

The advanced menu also contains a command to return it to the basic format.

Figure 4-1 shows which items are on the basic and advanced System Panel menus.

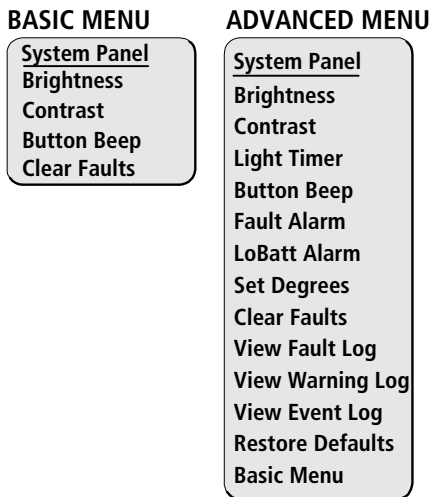

Figure 4-1 System Panel menu contents

**To view the System Panel menu:**

1. On the Select Device menu, use the down arrow button to highlight System Panel.

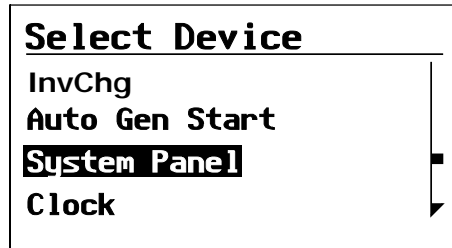

Figure 4-2 Highlighting System Panel

2. Press Enter.  
The System Panel menu appears.

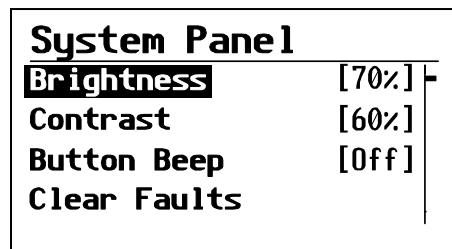

Figure 4-3 System Panel menu (basic menu shown)

**To change a setting on the System Panel menu:**

1. On the System Panel menu, use the up and down arrow buttons to highlight the setting you want to change.
2. Press Enter to highlight the current value of that setting.

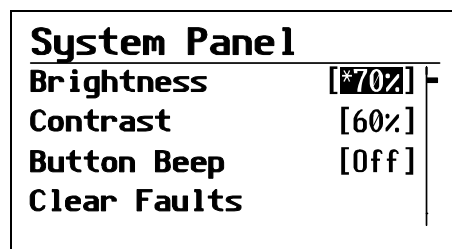

Figure 4-4 Highlighting the setting

3. Use the up and down arrow buttons to change the value. Hold down an arrow button to scroll through a large range of values quickly.
4. Press Enter to select the value.
5. If you have another setting to change, return to step 1.

Or

If you have no more settings to change, press Exit twice to return to the System screen.

## Basic Menu Configuration Items

The basic System Panel menu contains settings for changing the appearance of the display. From the basic menu you can also enable the low-battery warning buzzer and make the buttons beep when they are pressed.

Menu item	Description	Values/ Action	Default
Brightness	Adjusts the brightness of the display to suit interior light conditions and enhance visibility.	20% to 100% (increments of 10%)	60%
Contrast	Adjusts the contrast of the display to suit viewing angle and enhance visibility.	0% to 100% (increments of 5%)	60%
Button Beep	Enables buttons to beep when pressed. This feature can be a useful aid for confirming button presses.	On, Off	Off
Clear Faults	Clears active faults generated by the System Control Panel.	Press Enter to clear faults.	n/a



## Advanced Menu Configuration Items

The System Panel advanced menu provides more configuration options. The advanced menu contains all items from the basic menu, as well as settings for turning the backlight off and selecting the temperature scale. You can also restore default settings and view the fault and warning logs on the advanced menu.

Menu item	Description	Values/ Action	Default
Light Timer	Sets how long the backlight remains on after the last button press on the System Control Panel.	Off, 1mins–60mins (increments of 1 minute)	2mins
Fault Alarm	Enables an alarm to sound when a fault occurs.	On, Off	Off
LoBatt Alarm	Enables an alarm to sound when a low battery voltage condition exists.	On, Off	Off
Set Degrees	Selects the temperature scale that the System Control Panel will display.	Fahrenheit, Celsius	Fahrenheit
View Fault Log	Displays the Fault Log, containing the last 20 System Control Panel faults.	Press Enter to view log.	n/a
View Warning Log	Displays the Warning Log, containing the last 20 System Control Panel warnings.	Press Enter to view log.	n/a
View Event Log	Displays the Event Log, containing the last 20 System Control Panel events.	Press Enter to view log.	n/a
Restore Defaults	Restores the System Control Panel to its original factory or installer settings. After restoring settings, please ensure that the clock is set correctly.	Press Enter to restore defaults.	n/a
Basic Menu	Displays the basic menu for the System Control Panel only.	Press Enter to view basic menu.	n/a

## Using the Clock Menu

Use the Clock menu to set the clock, the date, and the time format you prefer.

The clock is listed as a separate device on the Select Device menu.

**To view the Clock menu:**

1. On the Select Device menu, use the up arrow or down arrow button to highlight Clock.

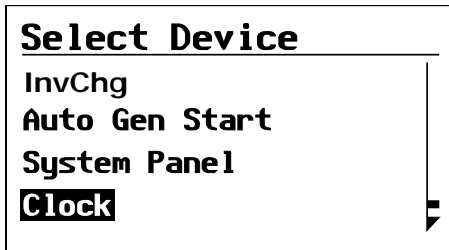

Figure 4-5 Selecting the Clock menu

2. Press Enter.  
The Clock menu appears.

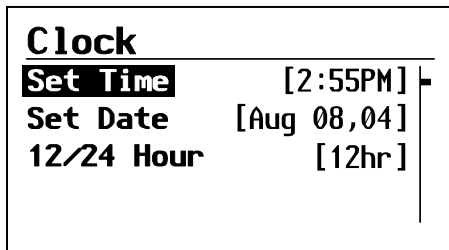

Figure 4-6 Clock menu

# Clock Menu Configuration Items

Menu item	Description	Values	Default
Set Time	Sets reference time for the power system.	12:00 AM–11:59 PM, 00:00–23:59	n/a
Set Date	Sets the reference date for the power system.	month day year (Jul 1, 04, for example)	n/a
12/24 Hour	Configures the System Control Panel to use a 12-hour clock or 24-hour clock.	12hr, 24hr	12hr

## Setting the time

Because the System Control Panel keeps time for the power system, setting the clock to the correct local time is essential for the system to operate as expected. The clock also provides the time stamps for the Warning, Fault, and Event logs.

When you first power up the System Control Panel, it will not begin operating normally until you set the time.

### To set the clock:

1. On the Clock menu, with Set Time highlighted, press Enter.
2. Press Enter to highlight the hour.
3. Use the up arrow or down arrow button to change the hour.
4. When the correct hour is shown, press Enter to select it and highlight the minute.
5. Use the up arrow or down arrow button to change the minute.
6. When the correct minute is shown, press Enter to select it and highlight the AM/PM value.

If you are using a 24-hour clock, you will return to Set Time at this point. Proceed to step 9.

7. Use the up arrow or down arrow button to choose AM or PM.
8. When the correct value is shown, press Enter to select it and return to the Clock menu.
9. Press Enter to return to the Select Device menu.

If you make an error, press Exit to move back to the value you need to reset. If you decide to abandon resetting the time, press Exit repeatedly until you return to the Clock menu.

## Setting the date

You can set the reference date for the Xanbus system from the Clock menu.

### **To set the date:**

1. On the Clock menu, use the up arrow or down arrow button to highlight Set Date.
2. Press Enter to highlight the month.
3. Use the up arrow or down arrow button to change the month.
4. When the correct month is shown, press Enter to select it and highlight the day.
5. Use the up arrow or down arrow button to change the day.
6. When the correct day is shown, press Enter to select it and highlight the year.
7. Use the up arrow or down arrow button to change the year.
8. When the correct year is shown, press Enter to select it and return to the Clock menu.

If you make an error, press Exit to move back to the value you need to reset. If you decide to abandon resetting the date, press Exit repeatedly until you return to the Clock menu.

# Using the System Settings Menu

The System Settings menu displays information related to the operation of the entire Xanbus system.

## To view the System menu:

1. On the Select Device menu, use the down arrow button to highlight System.

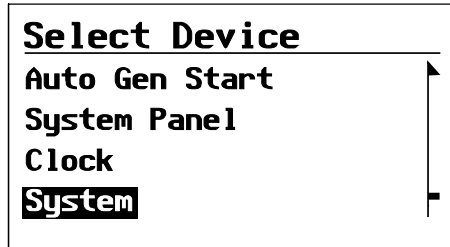

Figure 4-7 Selecting the System Settings menu

2. Press Enter.

The System Settings menu appears.

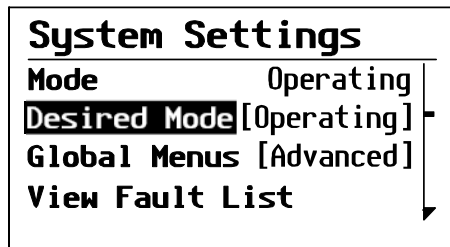

Figure 4-8 System Settings menu

## System Settings Menu Configuration Items

Menu item	Description	Values/Action	Default
Mode	Displays the current system mode as status information only.	Operating, Safe	n/a
Desired Mode	Sets the system mode.	Operating, Safe	Operating
Global Menus	Enables the display of advanced or basic menus for all Xanbus-enabled devices in the system, including the System Control Panel (see page 5–5).	Advanced, Basic	Advanced
View Fault List	Displays the Fault List screen, which shows active faults in the system (up to 20). See page 5–14.	Press Enter to view list.	n/a
View Warning List	Displays the Warning List screen, which shows active warnings in the system (up to 20). See page 5–10.	Press Enter to view list.	n/a
View Device Info	Displays the Device Info screen, which lists the serial number and software version for each Xanbus-enabled device in the system.	Press Enter to view screen.	n/a

### Changing the system mode

#### To change the System mode:

1. On the System Settings menu, with Desired Mode highlighted, press Enter.
2. Use the up arrow or down arrow button to view the available system modes—Operating and Safe.
3. Press Enter to select a system mode.
4. Press Exit twice to return to the System screen.

**Safe mode** You can also use the red System button to put the System Control Panel and all other Xanbus-enabled devices into Safe mode only by pressing and holding the System button for five seconds. For more information, see “Safe mode” on page 5–7.

## Viewing device information

The Device Info screen shows the serial number and firmware revision for each Xanbus-enabled device. You cannot select or change any information on this screen.

### To view device information:

1. On the System Settings menu, press the down arrow button to highlight View Device Info.
2. Press Enter.

The Device Info screen appears.

<b>Device Info</b>	
<b>Auto Gen Start</b>	
<b>Model #</b>	<b>809-0915</b>
<b>Serial #</b>	<b>1945447</b>
<b>F/W Rev.</b>	<b>2.01.00 BN0002</b>

**Figure 4-9** Device Info screen (showing Auto Gen Start info)

3. Press the down arrow button to view information for each Xanbus-enabled device on the system.
4. Press Exit to return to the System Settings menu.





# 5

## Operation

Chapter 5 contains information and procedures for operating the System Control Panel, including:

- Reading screens and menus
- Displaying advanced menus
- Startup behavior
- System modes
- Faults and warnings

# Reading Screens and Menus

The System Control Panel displays several different screens and menus. The content of these screens and menus will change depending on power system activity or the device you have selected to view information for.

During regular operation, you may need to view three screens or menus:

- System screen
- Select Device menu
- Device menu

## System screen

**Function** The System screen is used to monitor system activity. You cannot select or change any of the information on the System screen. If you would like to view more detailed information for a Xanbus-enabled device, press Enter from the System screen to go to the Select Device menu.

**Appearance** During normal operation, the System screen is the default screen. The numbers and graphics on this screen provide a summary of current system activity. The System screen's appearance varies with the status of the inverter/charger (Standby, Inverting, Charging, AC Bypass, or Equalize). The basic elements appear as described in "System screen elements" on page 5-3.

You can always identify the System screen by the Menu arrow pointing toward the Enter button on the System Control Panel.

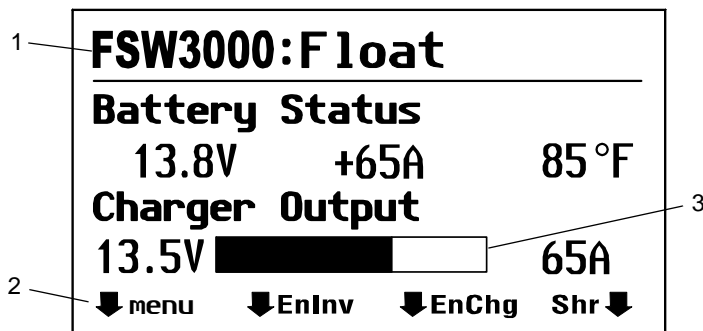

Figure 5-1 System screen (example)

**Table 5-1** System screen elements

Number	Description
1	<b>Screen Title.</b> The title is dynamic, changing as the inverter/charger status changes.
2	<b>Menu arrow.</b> This arrow points to the Enter button. Pressing the Enter button takes you to the Select Device menu.
3	<b>Graphical status bar.</b> This represents charger output voltage when inverter/charger is charging.

## Select Device menu

**Function** The Select Device menu is a list of all the Xanbus-enabled devices in your power system, including the System Control Panel. You can select a device from this list to view its status and change its settings.

**Appearance** The length of the Select Device menu will vary with the number of Xanbus-enabled devices installed.

The System Panel, Clock, and System Settings menus are always available from the Select Device menu, regardless of the number of Xanbus-enabled devices installed.

### To view the Select Device menu:

- ◆ On the System screen, press the Enter button, as indicated by the Menu arrow.

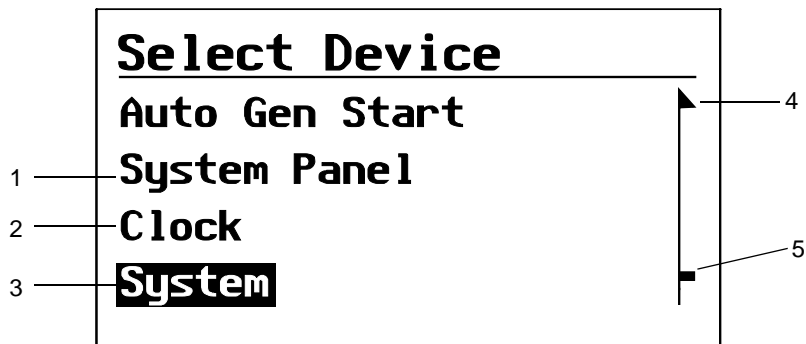

**Figure 5-2** Select Device menu

Number	Description
1	<b>System Panel.</b> Select this to view the System Panel menu and configure the appearance and behavior of the System Control Panel.
2	<b>Clock.</b> Select this to view the Clock menu and set the time, date, and 12/24-hour clock format.
3	<b>System.</b> Select this to view the System Settings menu and change System modes. See “Using the System Settings Menu” on page 4–9.
4	<b>Menu up arrow.</b> Indicates additional menu items above the top edge of the display.
5	<b>Scroll bar.</b> Moves vertically as you select each device, indicating where you are on the menu.

## Device menu

Each Xanbus-enabled device has its own menu showing its status and settings.

### To view a device menu:

1. On the Select Device menu, use the up arrow or down arrow buttons to highlight the device you want to select.
2. Press Enter.

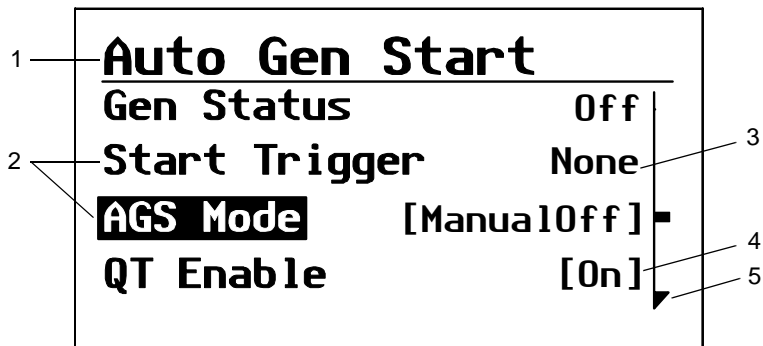

Figure 5-3 Device menu (Auto Gen Start menu used as example)

**Table 5-2** Device menu elements

Number	Description
1	<b>Title.</b> On a device menu, the title is not dynamic.
2	<b>Menu items.</b> Configurable menu items are highlighted (white letters on black background) when selected.
3	<b>Status value.</b>
4	<b>Configurable setting.</b> Enclosed by square brackets.
5	<b>Menu down arrow.</b> Indicates additional menu items below bottom edge of the display.

## Viewing Advanced Menus

The System Control Panel displays device menus in two formats: basic and advanced. The number of items on a device menu will depend on whether you have selected to view the basic or advanced menu.

Basic menus list status information and settings you may have to adjust routinely.

Advanced menus list all the items on the basic menu as well as additional configuration options. Advanced menus also give you access to Fault, Warning and Event Logs.

### Displaying advanced menus for all devices

The System Control Panel shows basic menus for all devices on the Xanbus system by default. If you would like to view advanced menus, you must go to the System Settings menu and select Global Menu.

#### To view advanced menus for all devices:

1. On the Select Device menu, use the down arrow button to highlight System.

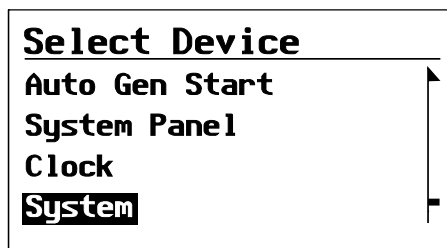

**Figure 5-4** Highlighting System on the Select Device menu

2. Press Enter.  
The System Settings menu appears.
3. On the System Settings menu, use the down arrow button to highlight Global Menu.

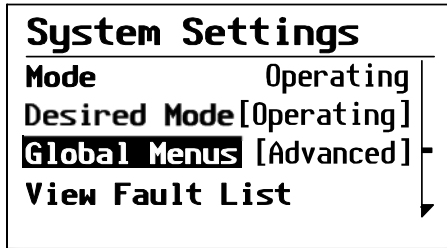

**Figure 5-5** Highlighting Global Menu

4. Press Enter.
5. Use the up or down arrow buttons to select Advanced.
6. Press Enter.

## Combining basic and advanced menus

You can return to viewing the basic menu for any device by selecting Basic Menu from the advanced menu for that device.

When the System Control Panel displays basic menus for some devices and advanced menus for other devices, you can display advanced menus for all devices again by using the following procedure.

### **To view advanced menus for all devices again:**

1. On the System Settings menu, use the down arrow button to highlight Global Menus, then press Enter.
2. Use the up or down arrow buttons to select Basic.
3. Press Enter.
4. With Global Menu highlighted again, press Enter.
5. Use the up or down arrow buttons to select Advanced.
6. Press Enter.

---

# Startup Behavior

When powering on the Xanbus system for the first time, the System Control Panel displays a fault message asking you to set the clock before proceeding. For procedures for setting the clock, see “Setting the time” on page 4–7 and “Setting the date” on page 4–8.

## System Modes

The system modes described in this section affect the performance and behavior of the System Control Panel and all other Xanbus-enabled devices. You will have to change the system mode when putting your system in storage or when installing a new Xanbus-enabled device.

### Changing system modes

System modes are changed using the System Settings menu (see “Using the System Settings Menu” on page 4–9). The four system modes are:

- Operating
- Safe

Please read the section about each system mode to find out which mode is appropriate for different conditions or situations.

### Operating mode

**Characteristics** The basic state of the System Control Panel is Operating mode. In Operating mode, the System Control Panel communicates with other Xanbus-enabled devices and displays all the network information it is configured to display.

### Safe mode

**Characteristics** Selecting Safe mode stops the generator (if it is running) and puts the System Control Panel (and all Xanbus-enabled devices) into Safe mode. While in Safe mode, the System Control Panel remains powered, “listening” to and reporting its status to the network. However, the output power of all Xanbus-enabled devices is disabled and all inverting, charging, and generator starting activity stops.

**When to use** Use Safe mode when you are adding or removing devices from the network. Authorized service personnel must also put the System Control Panel in Safe mode before performing software upgrades and diagnostics.

If the System Control Panel is powered off while in Safe mode, it will be in Safe mode when it is powered up again.

**To return to Operating mode:**

- ◆ On the System Settings menu, under Desired Mode, select “Operating”.

## Warnings and Faults

This section describes how fault and warning messages behave, and what you should do when they appear. For a complete list of System Control Panel fault and warning messages along with recommended actions to correct the fault or warning condition, please refer to Chapter 6, “Troubleshooting”.

**Important:** The System Control Panel displays fault and warning messages for all Xanbus-enabled devices in the system. For information about fault and warnings for other devices, refer to the Troubleshooting chapter in the Owner’s Guide or Operation Guide for each device.

### Warning messages

Warning messages will appear when the System Control Panel detects a condition that may eventually affect its continued operation. When a warning occurs, the System Control Panel will continue operating. However, you should consult the Troubleshooting chapter to find out what actions you can take to prevent the warning from escalating into a fault.

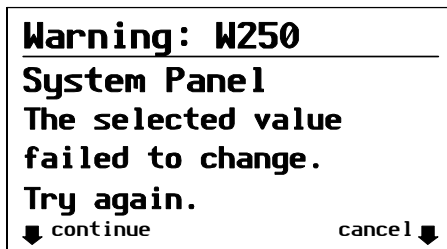

**Figure 5-6** System Control Panel warning message

#### Types

There are two types of warning messages: manual and automatic. Each differs in its behavior and appearance. For a list of System Control Panel warnings and their associated types, refer to Chapter 6, “Troubleshooting”.



If you see a warning message on the System Control Panel, you will have to acknowledge it and (if necessary) clear it. Acknowledging the warning allows you to continue operating the System Control Panel. Clearing the warning message stops the warning condition from escalating into a fault.

## Acknowledging warning messages

**Automatic warnings**      Acknowledging an automatic warning message removes the message from the System Control Panel screen.

To acknowledge an automatic warning message, press Enter. After you acknowledge the warning, the System Control Panel displays the menu for the device that caused the warning.

The System Control Panel will remove an unacknowledged automatic warning message from the screen after three minutes. However, if the condition that caused the warning still exists, the warning message will reappear.

You can view a list of the last 20 warning messages from the System Control Panel on the Warning log. See “Viewing the System Control Panel warning log” on page 5–10.

**Manual warnings**      A manual warning message requires you to make a choice (usually by pressing Enter for “yes” or Exit for “no”) before you can proceed monitoring or configuring the System Control Panel. It will not disappear after three minutes. After you respond to the warning message the System Control Panel will clear the warning message and return to the screen it was displaying before the warning message appeared.

## Clearing warning messages

Automatic warning messages clear when the warning condition on the System Control Panel disappears or when the criteria for clearing the warning are met.

You can clear a manual warning message by pressing Enter or Exit in response to the message.

## Viewing multiple warning messages

If several warning messages occur before you can acknowledge or clear them, they are displayed together on a warning list. The warning list contains messages from every Xanbus-enabled device, not just the System Control Panel. You can select a message from the warning list and view its details.

**To view a message from the warning list:**

1. On the warning list, use the up arrow or down arrow button to highlight the warning message you want to view.
2. Press Enter.

The complete warning message appears.

After viewing the warning message, you can return to the warning list by pressing Exit or continue to the menu for the device that caused the warning by pressing Enter. Each time you return to the warning list after viewing a complete message, the viewed message is removed from the list.

If you have left the warning list, you can view it at any time from the System Settings menu.

**To view the warning list:**

1. On the Select Device menu, highlight System and press Enter.
2. On the System Settings menu, highlight View Warning List and press Enter.

## Viewing the System Control Panel warning log

The System Control Panel warning log displays the 20 most recent warnings that the System Control Panel generated. These warnings can be both active and cleared. Each warning in the log is identified by a warning code and the time that it occurred. You may need to refer to the warning log before consulting Chapter 6, “Troubleshooting”, or before you call technical support.

**To view the warning log:**

1. On the System Panel menu, press the down arrow button to highlight View Warning Log.
2. Press Enter.

**To return to the System Panel menu:**

- ◆ From the Warning log, press Exit.

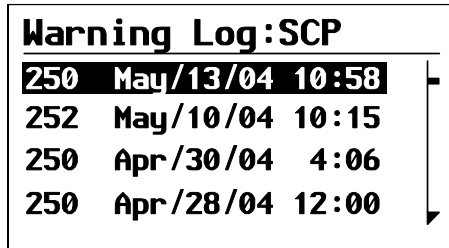

Warning Log:SCP		
250	May/13/04	10:58
252	May/10/04	10:15
250	Apr/30/04	4:06
250	Apr/28/04	12:00

Figure 5-7 System Control Panel warning log

## Viewing individual warning messages from the warning log

On the warning log, you can also select an individual warning and view its details.

### To view details for a warning:

1. Use the up arrow or down arrow button to highlight the warning message you want to view.
2. Press Enter.  
The complete message appears.

### To return to the warning log:

- ◆ Press Exit (as indicated by the arrow marked “cancel”).

### To proceed to the device menu and reconfigure the device to eliminate the warning condition:

- ◆ Press Enter (as indicated by the arrow marked “continue”).

## Fault messages

Fault messages appear when the System Control Panel’s operation is affected by a condition that requires immediate attention. When a fault occurs, the System Control Panel stops operating until either the fault condition goes away or until you manually clear the fault and take action to eliminate the fault condition.

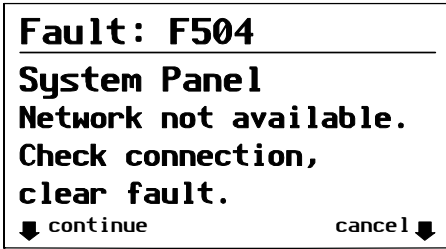

Figure 5-8 System Control Panel fault message

Types of fault messages

There are two types of System Control Panel fault messages: automatic and manual. For a list of faults and their associated types, refer to Chapter 6, “Troubleshooting”.

**Automatic faults** clear themselves automatically if the fault condition goes away.

**Manual faults** require you to clear them by:

- selecting Clear Faults on the menu of the device that generated the fault (if the fault condition still exists, the fault message will reappear).
- correcting the condition that caused the fault.

Viewing the System Control Panel fault log

The fault log lists the most recent System Control Panel faults, up to a total of 20. On each line, the log shows the fault code, the date the fault occurred, and the time the fault occurred.

To view the fault log:

1. On the System Panel advanced menu, press the down arrow button to highlight Fault log.
2. Press Enter.

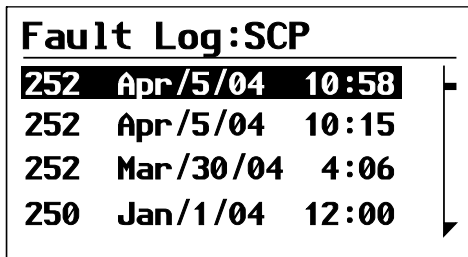

Figure 5-9 System Control Panel fault log

**To return to the System Panel menu:**

- ◆ Press Exit.

**Viewing individual fault messages from the fault log**

On the fault log, you can also select an individual fault and view its details.

**To view details for a fault:**

1. Use the up arrow or down arrow button to highlight the fault message you want to view.
2. Press Enter.

The complete fault message appears.

**To return to the fault log:**

- ◆ Press Exit (as indicated by the arrow marked “cancel”).

**To proceed to the device menu and reconfigure the device to eliminate the fault condition:**

- ◆ Press Enter (as indicated by the arrow marked “continue”).

On the device menu, you can also attempt to clear the fault by selecting Clear Faults.

**Viewing multiple fault messages**

If several faults occur before you can acknowledge or clear them, the System Control Panel displays the accumulated messages on a fault list. The fault list displays messages from all network-enabled devices, not just the System Control Panel. You can select a message and view complete information for it from the fault list.

**To view a message from the fault list:**

1. On the fault list, use the up arrow or down arrow button to highlight the fault message you want to view.
2. Press Enter.

The complete fault message appears.

3. To return to the fault list, press Exit.

Or

To return to the System Control Panel menu, press Enter.

Each time you return to the fault list after viewing a complete message, the message you viewed is removed from the list.

You can also view the fault list at any time.

**To view the fault list at any time:**

1. On the Select Device menu, use the up arrow or down arrow button to highlight System.
2. Press Enter.
3. On the System Settings menu, use the up arrow or down arrow button to highlight View Fault List.
4. Press Enter.

# 6

## Troubleshooting

Chapter 6 contains reference tables of warning and fault messages.

Use these tables to help you identify the cause of the fault or warning, and determine the best course of action to correct the condition that caused the fault or warning.

# Troubleshooting Reference

## Types of Faults and Warnings

The various types of fault and warning messages behave differently, and give you the option to treat them differently when they appear. For more information about the types of fault and warning messages, see “Types” on page 5–8 and “Types of fault messages” on page 5–12.

## Warning Reference Table

**Table 6-1** Warning reference table

Warning number	Message	Type	Cause	Action
W250	The selected value failed to change. Try again.	Automatic	A temporary communication problem stopped the System Control Panel changing a value that you entered.	Try changing the value again.
W251	Please confirm equalization process.	Manual	You have selected the Equalize command on the inverter/charger menu.	Press Enter to begin equalizing batteries or Exit to return to the inverter/charger menu.
W252	Please confirm: Restore device’s default settings.	Manual	You have selected the Restore Defaults command.	Press Enter to restore default settings or Exit to cancel.
W254	Put system in Safe mode to change setting.	Manual	The setting you are changing can only be changed when the system is in Safe mode.	Put the system in Safe mode, change the setting, then return the system to Operating mode.
W255	System clock not set. Set correct time.	Manual	On initial startup, the clock needs to be set. The system will not operate correctly until it is.	Set the clock to the correct time.
W256	No network connection. Check connection to device.	Manual	The System Control Panel has lost communications with another device on the network.	Check network connection between the System Control Panel and the device.



**Table 6-1** Warning reference table

Warning number	Message	Type	Cause	Action
W257	New device detected. Check device settings.	Manual	You have connected a new device to the network or reconnected a disconnected device.	Acknowledge the message and check that the device is properly configured.
W501	SCP has fixed a memory problem and restored default settings.	Manual	The System Control Panel encountered an internal memory problem upon startup. To remain operational, the System Control Panel restored its default settings.	Acknowledge the warning and reset configurable settings if necessary.

## Fault Reference Table

**Table 6-2** Fault reference table

Fault number	Message	Type	Cause	Action
F500	Internal failure. Service required.	Manual	The silicon serial ID number has failed and the System Control Panel has gone into Safe mode.	Reset the System Control Panel. If problem persists, call customer service.
F501	Internal failure. Service required.	Manual	The System Control Panel has suffered a non-volatile memory failure.	Reset the System Control Panel. If problem persists, call customer service.
F503	Internal failure. Service required.	Manual	The real-time clock in the System Control Panel has failed.	Reset the System Control Panel by putting it in and taking it out of Power Save mode. If problem persists, call customer service.
F504	Network not available. Check connection, clear fault.	Automatic	The System Control Panel has lost communications with the network because of a faulty connection or electronic signal disruption.	Check connection between the System Control Panel and the network.
F505	Internal failure. See guide.	Manual	A controller fault has occurred and the System Control Panel has gone into Safe mode.	Reset the System Control Panel. If problem persists, disconnect and reconnect network cables, or put it in and take it out of Safe mode.

# A

# Specifications

Appendix A contains the electrical and physical specifications for the System Control Panel.

All specifications are subject to change without notice.

## Electrical Specifications

Nominal input network voltage	15 VDC
Minimum operating network voltage	14.25 VDC
Maximum operating network voltage	15.75 VDC
Maximum operating current	200 mA @ nominal input network voltage
Communication physical layer	2, CAN
Communication protocol	Xanbus
Maximum cable length	130 ft. (40 m)
Connectors	2 RJ45—8 pins
Display	dot matrix 128 × 64 LCD with white LED backlight
Regulatory compliance	CSA Certified to CSA 107.1 and UL 458, including the Marine Supplement

## Mechanical Specifications

Dimensions	6 × 4 × 1.57 " (152 × 103 × 40 mm)
Weight	0.46 lb (207 g)
Mounting	flush mounted, 4 #6 screws

## Environmental Specifications

Operating temperature	-4 to 122 °F (-20 to 50 °C)
Storage temperature	-40 to 185 °F (-40 to 85 °C)
Maximum case temperature	140 °F (60 °C)
Operating humidity	5% to 95%
Storage humidity	5% to 95%

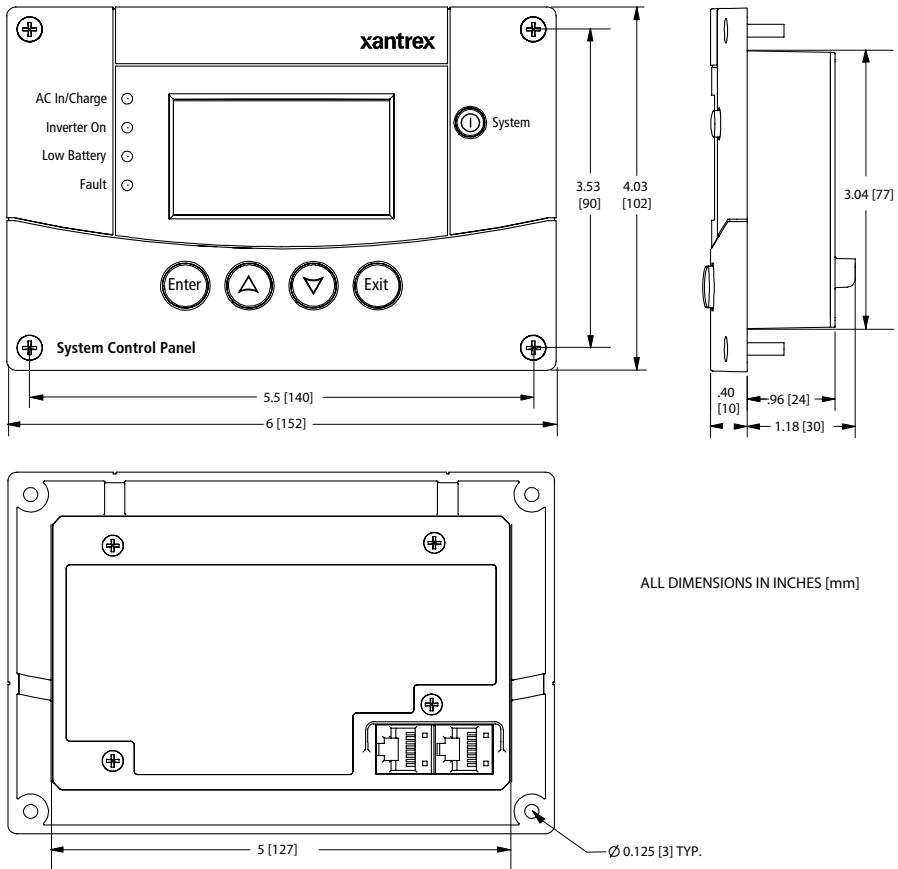

Figure A-1 System Control Panel dimensions



# Warranty and Return Information

## Warranty

**What does this warranty cover and how long does it last?** This Limited Warranty is provided by Xantrex Technology Inc. (“Xantrex”) and covers defects in workmanship and materials in your System Control Panel. This warranty period lasts for 12 months from the date of purchase at the point of sale to you, the original end user customer, unless otherwise agreed in writing (the “Warranty Period”). You will be required to demonstrate proof of purchase to make warranty claims.

This Limited Warranty is transferable to subsequent owners but only for the unexpired portion of the Warranty Period. Subsequent owners also require original proof of purchase as described in “What proof of purchase is required?”

**What will Xantrex do?** During the Warranty Period Xantrex will, at its option, repair the product (if economically feasible) or replace the defective product free of charge, provided that you notify Xantrex of the product defect within the Warranty Period, and provided that Xantrex through inspection establishes the existence of such a defect and that it is covered by this Limited Warranty.

Xantrex will, at its option, use new and/or reconditioned parts in performing warranty repair and building replacement products. Xantrex reserves the right to use parts or products of original or improved design in the repair or replacement. If Xantrex repairs or replaces a product, its warranty continues for the remaining portion of the original Warranty Period or 90 days from the date of the return shipment to the customer, whichever is greater. All replaced products and all parts removed from repaired products become the property of Xantrex.

Xantrex covers both parts and labor necessary to repair the product, and return shipment to the customer via a Xantrex-selected non-expedited surface freight within the contiguous United States and Canada. Alaska, Hawaii and outside of the United States and Canada are excluded. Contact Xantrex Customer Service for details on freight policy for return shipments from excluded areas.

**How do you get service?** If your product requires troubleshooting or warranty service, contact your merchant. If you are unable to contact your merchant, or the merchant is unable to provide service, contact Xantrex directly at:

Telephone: 1 800 670 0707 (toll free North America)  
1 408 987 6030 (direct)

Fax: 1 800 994 7828 (toll free North America)

Email: [customerservice@xantrex.com](mailto:customerservice@xantrex.com)

Website: [www.xantrex.com](http://www.xantrex.com)

Direct returns may be performed according to the Xantrex Return Material Authorization Policy described in your product manual. For some products, Xantrex maintains a network of regional Authorized Service Centers. Call Xantrex or check our website to see if your product can be repaired at one of these facilities.

**What proof of purchase is required?** In any warranty claim, dated proof of purchase must accompany the product and the product must not have been disassembled or modified without prior written authorization by Xantrex.

## Warranty and Return

---

Proof of purchase may be in any one of the following forms:

- The dated purchase receipt from the original purchase of the product at point of sale to the end user; or
- The dated dealer invoice or purchase receipt showing original equipment manufacturer (OEM) status; or
- The dated invoice or purchase receipt showing the product exchanged under warranty.

**What does this warranty not cover?** Claims are limited to repair and replacement, or if in Xantrex's discretion that is not possible, reimbursement up to the purchase price paid for the product. Xantrex will be liable to you only for direct damages suffered by you and only up to a maximum amount equal to the purchase price of the product.

This Limited Warranty does not warrant uninterrupted or error-free operation of the product or cover normal wear and tear of the product or costs related to the removal, installation, or troubleshooting of the customer's electrical systems. This warranty does not apply to and Xantrex will not be responsible for any defect in or damage to:

- a) the product if it has been misused, neglected, improperly installed, physically damaged or altered, either internally or externally, or damaged from improper use or use in an unsuitable environment;
- b) the product if it has been subjected to fire, water, generalized corrosion, biological infestations, or input voltage that creates operating conditions beyond the maximum or minimum limits listed in the Xantrex product specifications including but not limited to high input voltage from generators and lightning strikes;
- c) the product if repairs have been done to it other than by Xantrex or its authorized service centers (hereafter "ASCs");
- d) the product if it is used as a component part of a product expressly warranted by another manufacturer;
- e) component parts or monitoring systems supplied by you or purchased by Xantrex at your direction for incorporation into the product;
- f) the product if its original identification (trade-mark, serial number) markings have been defaced, altered, or removed;
- g) the product if it is located outside of the country where it was purchased; and
- h) any consequential losses that are attributable to the product losing power whether by product malfunction, installation error or misuse.

## Disclaimer

### Product

THIS LIMITED WARRANTY IS THE SOLE AND EXCLUSIVE WARRANTY PROVIDED BY XANTREX IN CONNECTION WITH YOUR XANTREX PRODUCT AND IS, WHERE PERMITTED BY LAW, IN LIEU OF ALL OTHER WARRANTIES, CONDITIONS, GUARANTEES, REPRESENTATIONS, OBLIGATIONS AND LIABILITIES, EXPRESS OR IMPLIED, STATUTORY OR OTHERWISE IN CONNECTION WITH THE PRODUCT, HOWEVER ARISING (WHETHER BY CONTRACT, TORT, NEGLIGENCE, PRINCIPLES OF MANUFACTURER'S LIABILITY, OPERATION OF LAW, CONDUCT, STATEMENT OR OTHERWISE), INCLUDING WITHOUT RESTRICTION ANY IMPLIED WARRANTY OR CONDITION OF QUALITY, MERCHANTABILITY OR FITNESS FOR A PARTICULAR PURPOSE. ANY IMPLIED WARRANTY OF MERCHANTABILITY OR FITNESS FOR A PARTICULAR PURPOSE TO THE EXTENT REQUIRED UNDER APPLICABLE LAW TO APPLY TO THE PRODUCT SHALL BE LIMITED IN DURATION TO THE PERIOD STIPULATED UNDER THIS LIMITED WARRANTY.

IN NO EVENT WILL XANTREX BE LIABLE FOR: (A) ANY SPECIAL, INDIRECT, INCIDENTAL OR CONSEQUENTIAL DAMAGES, INCLUDING LOST PROFITS, LOST REVENUES, FAILURE TO REALIZE EXPECTED SAVINGS, OR OTHER COMMERCIAL OR ECONOMIC LOSSES OF ANY KIND, EVEN IF XANTREX HAS BEEN ADVISED, OR HAD REASON TO KNOW, OF THE POSSIBILITY OF SUCH DAMAGE; (B) ANY



LIABILITY ARISING IN TORT, WHETHER OR NOT ARISING OUT OF XANTREX'S NEGLIGENCE, AND ALL LOSSES OR DAMAGES TO ANY PROPERTY OR FOR ANY PERSONAL INJURY OR ECONOMIC LOSS OR DAMAGE CAUSED BY THE CONNECTION OF A PRODUCT TO ANY OTHER DEVICE OR SYSTEM; AND (C) ANY DAMAGE OR INJURY ARISING FROM OR AS A RESULT OF MISUSE OR ABUSE, OR THE INCORRECT INSTALLATION, INTEGRATION OR OPERATION OF THE PRODUCT BY PERSONS NOT AUTHORIZED BY XANTREX.

### Exclusions

IF THIS PRODUCT IS A CONSUMER PRODUCT, FEDERAL LAW DOES NOT ALLOW AN EXCLUSION OF IMPLIED WARRANTIES. TO THE EXTENT YOU ARE ENTITLED TO IMPLIED WARRANTIES UNDER FEDERAL LAW, TO THE EXTENT PERMITTED BY APPLICABLE LAW THEY ARE LIMITED TO THE DURATION OF THIS LIMITED WARRANTY. SOME STATES, PROVINCES AND JURISDICTIONS DO NOT ALLOW LIMITATIONS OR EXCLUSIONS ON IMPLIED WARRANTIES OR ON THE DURATION OF AN IMPLIED WARRANTY OR ON THE LIMITATION OR EXCLUSION OF INCIDENTAL OR CONSEQUENTIAL DAMAGES, SO THE ABOVE LIMITATION(S) OR EXCLUSION(S) MAY NOT APPLY TO YOU. THIS LIMITED WARRANTY GIVES YOU SPECIFIC LEGAL RIGHTS. YOU MAY HAVE OTHER RIGHTS WHICH MAY VARY FROM STATE TO STATE, PROVINCE TO PROVINCE OR JURISDICTION TO JURISDICTION.

### Return Material Authorization Policy

For those products that are not being repaired in the field and are being returned to Xantrex, before returning a product directly to Xantrex you must obtain a Return Material Authorization (RMA) number and the correct factory "Ship To" address. Products must also be shipped prepaid. Product shipments will be refused and returned at your expense if they are unauthorized, returned without an RMA number clearly marked on the outside of the shipping box, if they are shipped collect, or if they are shipped to the wrong location.

When you contact Xantrex to obtain service, please have your instruction manual ready for reference and be prepared to supply:

- The serial number of your product
- Information about the installation and use of the unit
- Information about the failure and/or reason for the return
- A copy of your dated proof of purchase

Record these details on page WA-4.

### Return Procedure

Package the unit safely, preferably using the original box and packing materials. Please ensure that your product is shipped fully insured in the original packaging or equivalent. This warranty will not apply where the product is damaged due to improper packaging.

Include the following:

- The RMA number supplied by Xantrex Technology Inc. clearly marked on the outside of the box.
- A return address where the unit can be shipped. Post office boxes are not acceptable.
- A contact telephone number where you can be reached during work hours.
- A brief description of the problem.

Ship the unit prepaid to the address provided by your Xantrex customer service representative.

**If you are returning a product from outside of the USA or Canada** In addition to the above, you MUST include return freight funds and are fully responsible for all documents, duties, tariffs, and deposits.

## Warranty and Return

---

**If you are returning a product to a Xantrex Authorized Service Center (ASC)** A Xantrex return material authorization (RMA) number is not required. However, you must contact the ASC prior to returning the product or presenting the unit to verify any return procedures that may apply to that particular facility and that the ASC repairs this particular Xantrex product.

## Out of Warranty Service

If the warranty period for your product has expired, if the unit was damaged by misuse or incorrect installation, if other conditions of the warranty have not been met, or if no dated proof of purchase is available, your unit may be serviced or replaced for a flat fee.

To return your product for out of warranty service, contact Xantrex Customer Service for a Return Material Authorization (RMA) number and follow the other steps outlined in "Return Procedure" on page WA-3.

Payment options such as credit card or money order will be explained by the Customer Service Representative. In cases where the minimum flat fee does not apply, as with incomplete units or units with excessive damage, an additional fee will be charged. If applicable, you will be contacted by Customer Service once your unit has been received.

## Information About Your System

As soon as you open your System Control Panel package, record the following information and be sure to keep your proof of purchase.

- Serial Number \_\_\_\_\_
- Product Number 809-0910
- Purchased From \_\_\_\_\_
- Purchase Date \_\_\_\_\_

If you need to contact Customer Service, please record the following details before calling. This information will help our representatives give you better service.

- Type of installation (e.g. RV, truck) \_\_\_\_\_
- Length of time SCP has been installed \_\_\_\_\_
- Battery/battery bank size \_\_\_\_\_
- Battery type (e.g. flooded, sealed gel cell, AGM) \_\_\_\_\_
- DC wiring size and length \_\_\_\_\_
- Alarm sounding? \_\_\_\_\_
- Description of indicators on front panel \_\_\_\_\_
- Appliances operating when problem occurred \_\_\_\_\_
- Description of problem \_\_\_\_\_

# Index

## Numerics

12/24 Hour 4-7

## A

AC In/Charge light 1-4  
advanced menu  
    configuration reference 4-5  
    displaying for all devices 5-6  
    viewing 4-10

## B

backlight timer 4-5  
basic menu  
    configuration reference 4-4  
    reverting to viewing 4-5  
brightness 4-4  
Button Beep 4-4

## C

changing device settings 3-4  
Clear Faults 4-4  
Clock menu  
    configuration reference 4-7  
    using 4-6  
configuration  
    any network-enabled device 3-2  
contrast 4-4

## D

date, setting 4-8  
Device Information 4-10, 4-11  
Device menu  
    defined 3-4  
    illustration 3-6  
Down arrow button 1-4, 3-2

## E

electrical specifications A-2

Enter button 1-4, 3-2  
environmental specifications A-2  
Event log 4-5  
Exit button 1-4, 3-2

## F

Fault Alarm 4-5  
Fault light 1-4  
Fault list 4-10, 5-13  
Fault log 4-5, 5-12  
fault messages  
    clearing 4-4  
    types 5-11  
fault reference table 6-4  
firmware revision 1-iii, 4-11

## G

Global Menus  
    command 4-10

## I

installation  
    connecting network cables 2-4  
    mounting 2-3  
    planning 2-2  
Inverter On light 1-4

## L

Light Timer 4-5  
LoBatt Alarm 4-5  
Low Battery light 1-4

## M

mechanical specifications A-2  
Menu arrow 5-3  
menu map 3-3  
Mode 4-10  
mounting template 2-2, 2-3

## **N**

- navigation
  - menu map 3-3
  - using buttons 3-2
- network cables 2-4
- network connectors 1-5
- network diagram 1-6
- network power consumption 1-2

## **O**

- Operating mode 5-7

## **P**

- Power Save mode 5-7
- proof of purchase WA-4

## **R**

- Restore Defaults 4-5
- RJ45 connectors 1-5

## **S**

- Select Device menu 3-4, 5-3
- Select Device menu illustration 3-5
- serial number 4-10
- Set Date 4-7
- Set Degrees 4-5
- Set Time 4-7
- specifications A-2
- startup behavior 5-7
- startup screen 3-4
- System button 1-4, 4-11
- system modes 5-7
  - changing 4-10
- System screen 3-4, 5-2
- System screen illustration 3-5

## **T**

- time, format and setting 4-7

## **U**

- Up arrow button 1-4, 3-2

## **V**

- verifying network power 2-4
- View Event Log 4-5
- View Fault Log 4-5
- View Warning Log 4-5

## **W**

- Warning List 4-10
- Warning log 4-5, 5-10
- warning messages 5-8
- warning reference table 6-2

## **X**

- Xanbus 1-2
- Xantrex
  - web site iv



**Xantrex Technology Inc.**

1 800 670 0707 Tel toll free NA  
1 360 925 5097 Tel direct  
1 800 994 7828 Fax toll free NA  
1 360 925 5143 Fax direct  
customerservice@xantrex.com  
www.xantrex.com

## Free Manuals Download Website

<http://myh66.com>

<http://usermanuals.us>

<http://www.somanuals.com>

<http://www.4manuals.cc>

<http://www.manual-lib.com>

<http://www.404manual.com>

<http://www.luxmanual.com>

<http://aubethermostatmanual.com>

Golf course search by state

<http://golfingnear.com>

Email search by domain

<http://emailbydomain.com>

Auto manuals search

<http://auto.somanuals.com>

TV manuals search

<http://tv.somanuals.com>