

11Mbps Wireless Internet Broadband Router

# **ANSEL 2314**

## **Wireless BroadBand Router**

### **User Guide**

**Version 1.3**

# 11Mbps Wireless Internet Broadband Router

The information in this guide may change without notice. The manufacturer assumes no responsibility for any errors which may appear in this guide.

Fast Ethernet is a trademark of XEROX Corporation. Microsoft, Windows and Windows logo are trademarks of Microsoft Corporation.

Copyright 2002. All right reserved. No Part of the contents of this guide maybe transmitted or reproduced in any form or by any means without the written permission of the manufacturer. Printed in Taiwan.

The revision date for this guide is DEC 10<sup>th</sup>, 2002

Version 1.3

## **FCC Certifications**

You are cautioned that any changes or modifications not expressly approved in this manual could void your authorization to use the device.

**CAUTION:** Any changes or modifications not expressly approved by the party responsible for compliance could void the user's authority to operate the equipment.

## **Prohibition of co-location**

This device must not be co-located or operating in conjunction with any other antenna or transmitter.

### **15.105 Federal Communications Commission (FCC) Requirements, Part 15**

This equipment has been tested and found to comply with the limits for a class B digital device, pursuant to part 15 of the FCC Rules. These limits are designed to provide reasonable protection against harmful interference in a residential installation.

This equipment generates, uses and can radiate radio frequency energy and, if not installed and used in accordance with the instructions, may cause harmful interference to radio communications. However, there is no guarantee that interference will not occur in a particular installation. If this equipment does cause harmful interference to radio or television reception, which can be determined by turning the equipment off and on, the user is encouraged to try to correct the interference by one or more of the following measures:

- Reorient or relocate the receiving antenna.
- Increase the separation between the equipment and receiver.
- Connect the equipment into an outlet on a circuit different from that to which the receiver is connected.
- Consult the dealer or an experienced radio/TV technician for help.

## 11Mbps Wireless Internet Broadband Router

### **Regulatory information / Disclaimers**

Installation and use of this Wireless LAN device must be in strict accordance with the instructions included in the user documentation provided with the product. Any changes or modifications (including the antennas) made to this device that are not expressly approved by the manufacturer may void the user's authority to operate the equipment. The manufacturer is not responsible for any radio or television interference caused by unauthorized modification of this device, or the substitution of the connecting cables and equipment other than manufacturer specified. It is the responsibility of the user to correct any interference caused by such unauthorized modification, substitution or attachment. Manufacturer and its authorized resellers or distributors will assume no liability for any damage or violation of government regulations arising from failing to comply with these guidelines.

**CAUTION:** To maintain compliance with FCC's RF exposure guidelines, this equipment should be installed and operated with minimum distance 20 cm between the radiator and your body. Use on the supplied antenna. Unauthorized antenna, modification, or attachments could damage the transmitter and may violate FCC regulations.

### **MPE Statement (Safety Information)**

Your device contains a low power transmitter. When device is transmitted it sends out Radio Frequency (RF) signal.

### **Safety Information**

In order to maintain compliance with the FCC RF exposure guidelines, this equipment should be installed and operated with minimum distance 20 cm between the radiator and your body. Use only with supplied antenna. Unauthorized antenna, modification, or attachments could damage the transmitter and may violate FCC regulations.

**Caution Statement of the FCC Radio Frequency Exposure**

This Wireless LAN radio device has been evaluated under FCC Bulletin OET 65C and found compliant to the requirements as set forth in CFR 47 Sections 2.1091, 2.1093, and 15.247(b)(4) addressing RF Exposure from radio frequency devices. The radiation output power of this Wireless LAN device is far below the FCC radio frequency exposure limits. Nevertheless, this device shall be used in such a manner that the potential for human contact during normal operation—as a mobile or portable device but use in a body-worn way is strictly prohibit. When using this device, a certain separation distance between antenna and nearby persons has to be kept to ensure RF exposure compliance. In order to comply with the RF exposure limits established in the ANSI C95.1 standards, the distance between the antennas and the user should not be less than 20 cm.

**CE Mark Warning**

This is a Class B product. In a domestic environment, this product may cause radio interference in which case the user may be required to take adequate measures.

## **Contents**

### **1: Introduction**

- 1.1 Before You Start
- 1.2 System Requirement
- 1.3 How to Use this Guide

### **2: Hardware Installation**

- 2.1 Product Description
  - 2.1.1 Overview
  - 2.1.2 Features
  - 2.1.3 Front Panel
  - 2.1.4 LEDs and Reset Button
  - 2.1.5 Rear Panel
- 2.2 Installing the Router
  - 2.2.1 Preparing for the installation
  - 2.2.2 Getting Started

### **3: Configuration**

- 3.1 Configuring the Wireless Access Point Router
- 3.2 The Setup Wizard
  - 3.2.1 PPPoE Connection for WAN
  - 3.2.2 Fixed IP for WAN
  - 3.2.3 PPTP For WAN
  - 3.2.4 Dynamic IP for WAN
  - 3.2.5 Alias IP Setup
  - 3.2.6 DNS
  - 3.2.7 Wireless Configuration
  - 3.2.8 Time Zone
- 3.3 Browsing the Status
  - 3.3.1 Status
  - 3.3.2 Wireless Status
  - 3.3.3 DHCP Table
  - 3.3.4 Routing Table
  - 3.3.5 DDNS Status screen
- 3.4 Viewing the Tools
  - 3.4.1 System Log
  - 3.4.2 Hacker Log
  - 3.4.3 Reset
  - 3.4.4 Upgrade

# 11Mbps Wireless Internet Broadband Router

## 3.4.5 Backup

## 3.5 Setup the Advanced Features

### 3.5.1 LAN IP Setting

### 3.5.2 DHCP Setting

### 3.5.3 Firewall Setting

### 3.5.4 Privilege

### 3.5.5 Virtual Servers

### 3.5.6 Routing

### 3.5.7 WAN MAC Address Clone

### 3.5.8 DDNS Setting

### 3.5.9 MAC Control

## 3.6 Configuring your PCs to Connect to the Router

## **4: Specifications**

### 4.1 Technical Specifications

### 4.2 Environmental Information

### 4.3 Standard Conformance

### 4.4 Cable Specifications

## **Appendix**

### **A: About Static and Dynamic IP Address**

### **B: Warranty Statement**

## **1: Introduction**

The Wireless Internet Broadband Router combines the technology of Fast Ethernet and IEEE 802.11b Wireless LAN, providing the home or small office users the Cable/DSL access to the Internet via cord and cordless connection. At the same time, integrated with the firewall and 128-bit WEP (Wired Equivalent Privacy) Encryption, the Wireless Internet Broadband Router allows multiple users to share one Internet connection while ensuring the safety and security of the packet flow.

Throughout this guide, the **Wireless Internet Broadband Router** may be referred to as **the Router**.

### **1.1 Before You Start**

Check the package of the router before you start. The package contents come with:

- One Wireless Access Point Router
- One AC/DC Power Adapter
- CD
- User Guide

### **1.2 System Requirement**

Before you getting started, make sure you meet the following requirements.

- One RJ-45 Cable/DSL network connection
- One PC with installed 10/100 Mbps Ethernet Adapter
- UTP network cable with RJ-45 connector
- Windows 95/98/2000 or Windows NT for the Web-based Configuration
- Either Microsoft Internet Explorer 4.0 (or above version) or Netscape Navigator 4.0 (or above version)

For Wireless Connection

- One PC with installed Wireless Network Adapter

## 1.3 How to Use this Guide

This guide is structured as follows:

- Chapter 2, *Hardware Installation* explains the function of the router and how to physically install it.
- Chapter 3, *Configuration* explains how to set up and modify the configuration of the router with its Web-based utility. In addition, the configuration of the PCs that you want to connect to the Router can be found within this chapter.
- Chapter 4, *Specifications* contains information about the cables, environment and the technical specifications of the router.
- Appendices include the information of *Static IP address and Dynamic IP address, comparison table and warranty Statement*. Read them as necessary.



## **2: Hardware Installation**

### **2.1 Product Description**

This chapter describes the features and functions of the router and shows how to physically install it.

#### **2.1.1 Overview**

As the interface between WAN and LAN, the Wireless Internet Broadband Router combines the technology of Fast Ethernet and IEEE 802.11b Wireless LAN, providing the home and small office users the broadband access to the internet via cord and cordless connection. Meanwhile with the integration-the firewall and 128-bit WEP (Wired Encrypted Privacy) Encryption, the Wireless Internet Broadband Router allows multiple users to share one Internet connection while ensuring the safety and security of the packet flow. Also, the design of one antenna will enhance the reception of signals transmitting from wireless adapters.

Strictly compliant with IEEE 802.11b, the Wireless Internet Broadband Router features the transmission rate up to 11 Mbps and 2.4 GHz frequency band, easily building up the wireless communication with other Wireless LAN devices. The local users' IP address masking and specific port blocking offer two levels of security. Also, the Wireless Internet Broadband Router serves as a DHCP server that automatically assigns IP address to the devices on your local area network (LAN).

#### **2.1.2 Features**

- Interoperable with IEEE 802.11b (DSSS) 2.4GHz compliant equipment
- Transmission speeds adjustable at 1, 2, 5.5, and 11 Mbps.
- Features 2.4 GHz frequency band.
- Capable of up to 128-bit WEP (Wired Equivalent Privacy) Encryption secures the network connection.
- MAC address filtering
- Supports PPPoE, PPTP Client, and Dynamic DNS
- Connects to a Cable/DSL modem or to an Ethernet backbone
- Equipped with a 4-port 10/100 Mbps Switch
- Creates a firewall to protect your PCs from outside intruders
- Configurable through any networked PC's web browser
- Speeds up the gaming and multimedia connections dramatically
- Simultaneously act as either a DHCP server on the LAN or a DHCP client on the

## 11Mbps Wireless Internet Broadband Router

### WAN

- Enables outside users to access the internal IP servers via Internet. Compatible with virtually all standard Internet applications
- Compatible with all standard internet application
- Enables administrators to block specific interior users' Internet access

### 2.1.3 Front Panel

The front panel of the router has 3 LEDs for each 10/100 Mbps ports, and three Module Status LEDs at the left. The Internet LEDs are at the right. Figure 2-1 show front panels of these routers.

**Figure 2-1** Front panel of Wireless Access Point Routers with One Optional PCMCIA Card, One Fixed Antenna, and One Reverse TNC Antenna

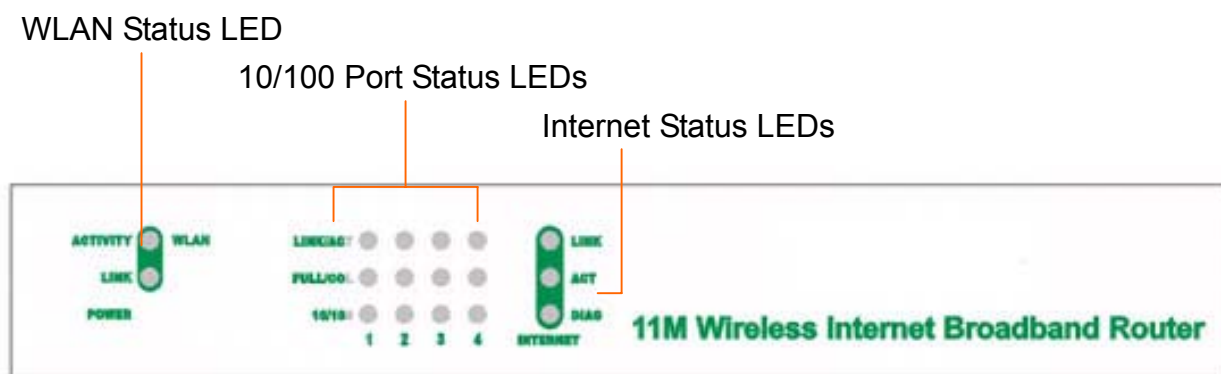

### 2.1.4 LEDs and Reset Button

The LEDs are explained in the following tables.

**Table 2-1** WAN Status LED Functionality

LED	Color	Function
WLAN Act	Green	<b>Lights</b> to indicate the router is activated.
WLAN Link	Green	<b>Lights</b> to indicate that the Router's wireless functions have been enabled through the Web-based utility.
Power	Green	<b>Lights</b> to indicate the router has power.

## 11Mbps Wireless Internet Broadband Router

**Table 2-2** 10/100 Port Status LED Functionality

LED	Color	Function
Link/Act	Green	<b>Lights</b> to indicate a functional network link through the corresponding port with an attached device. <b>Blinks</b> to indicate that the router is actively sending or receiving data over that port.
FULL/COL	Green	<b>Lights</b> to indicate that the connection made through the corresponding port is running in Full Duplex mode. <b>Blinks</b> periodically to indicate that the connection is experiencing collisions.
100	Orange	<b>Lights</b> for any port to indicate that the port is operating at 100 Mbps. <b>Off</b> to indicate that the port is operating at 10 Mbps while the network is still operating.

**Table 2-3** Internet LED Functionality

LED	Color	Function
Link	Green	<b>Lights</b> to indicate a successful connection between the Router and your broadband device or network.
Act	Green	<b>Blinks</b> to indicate that the Router is sending or receiving data over the broadband (Internet) port.
Diag	Red	<b>Lights</b> to indicate the Router's self-diagnosis mode is running during boot-up and restart. It will turn off when completing the diagnosis.

## 2.1.5 Rear Panel

The rear panel of the router has one Reset button at the left. At the right area are the Internet and LAN ports and a power connector. Figure 2-2 shows rear panels of these routers. Table 2-4 explains the function of the port.

**Figure 2-2** Rear panel of the Wireless Internet Broadband Router with Fixed Antenna and one Reverse SMA Antenna

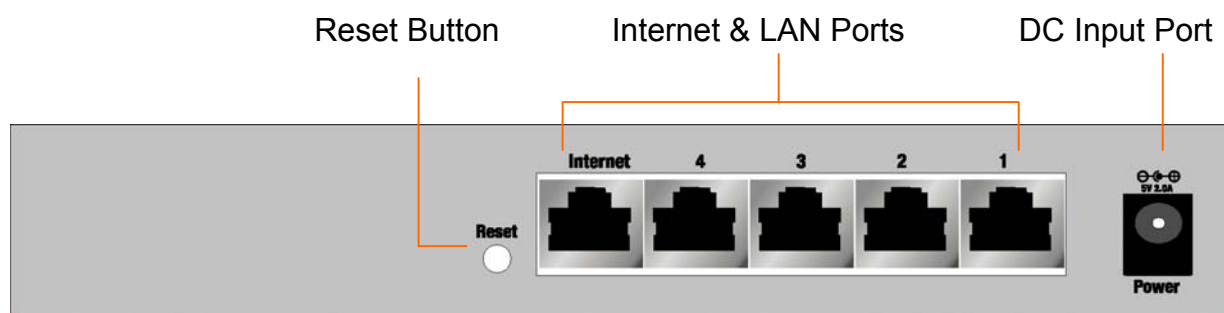

**Table 2-4** All Port Functionality

Port	Function
<b>Reset</b>	Pressing the Reset button for more than 3 seconds to restore to the factory default setting.
<b>LAN port</b>	This is where you connect to the PC.
<b>Internet port</b>	This is where you connect to the Cable/DSL modem.
<b>DC Input Port</b>	To connect the adapter to receive power.

### Caution: Reset Button

Pressing the Reset button for more than 3 seconds while the router powers up will restore to factory default setting. Note that this should be done only when you had tried all the troubleshooting options. Pressing the Reset button during operation may bring you into the risk of creating IP address conflict between your PC and the router. In such a case, you may be compelled to reboot your entire system(s).

## 2.2 Installing the Router

This section will discuss what you should do before connecting your router to the network and how to physically install it.

### 2.2.1 Preparing for Installation

Before you start to connect your router to any network device, make sure you get the following values from your ISP. You will need those values to setup the Router and configure you networked PCs to accept the IP address the Router chooses to assign them.

- PPPoE User Name and Password

or

- Fixed Internet IP Address assigned by your local ISP
- Your Subnet Mask
- Your Default Gateway
- Your Primary DNS IP address

or

- Other values may be needed for Cable Modem users, please confirm with your ISP

You are supposed to have all those information mentioned above from your ISP. If not, contact your ISP and they will be able to supply all the information you need.

### **2.2.2 Getting Started**

You may complete the following steps to install your Wireless Internet Broadband Router when you have all the information mentioned above on hand.

**Step 1.** Power all devices down. This should include your PCs, Cable or DSL modem and the Router.

**Step 2.** Connect the Router to your PCs.

- A.** Connect one end of a standard network cable to the 10/100 RJ-45 LAN ports on the back of the Wireless Access Point Router.
- B.** Connect the other end of the cable to the PC.

**Step 3.** Connect the Router to your Cable or DSL modem.

- A.** Connect one end of a standard network cable to the RJ-45 WAN port on the back of the Wireless Access Point Router.
- B.** Connect the other end of the cable to either a Cable or DSL modem

**Step 4.** Supply the power to the Router.

- A.** Connect one end of the power cable to the Wireless Access Point Router.
- B.** Connect the power cube end of the power cable to a standard wall outlet.

When the Router receives power, the Power LED should remain solid Green.

**Step 5.** Supply the power to either your Cable or DSL modem.

**Step 6.** Press the Reset button to restore the Wireless Access Point Router's default settings. Hold the button in for three seconds, or until the Diag LED illuminates red.

## 3: Configuration

### 3.1 Configuring the Wireless Access Point Router

Once you've done with the hardware installation, you may start to configure your system. Note that this high-speed Wireless Router has an internal integrated-circuit chip that programs all the administrative utility. The utility can be accessed by any PC on the network at <http://192.168.1.1> .

Typing <http://192.168.1.1> into the PC's browser address windows. (See Figure 3-1)

Then, you will receive a pop-up password request page. (See Figure 3-2) Type "admin" into the Password field and leave the User Name field empty.

After you access the Utility, you can find detailed instructions and explanations by clicking each page's **Help** button. To apply any settings you've altered on any page, click the **Apply** button, and then click **Continue**. To clear any values you've entered on any page, click **Cancel**.

**Figure 3-1** [Http://192.168.1.1](http://192.168.1.1)

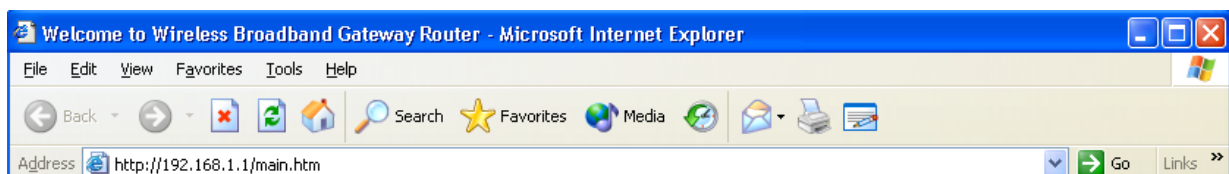

**Figure 3-2** A Password Request Page

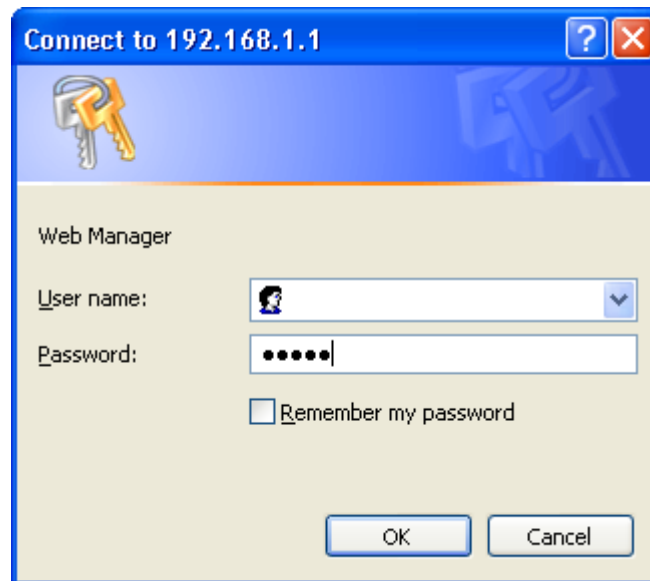

**Note:** If you have completed the basic configuration of the router, you may refer to *Section 3.6 Configuring your PCs to Connect to the Router* to configure the PCs that you plan to connect to the Router.

## 3.2 The Setup Wizard

Figure 3-3 shows the page that you will see once you have accessed to the Utility. The Setup Wizard of the router will lead you step by step to configure your Router. Please follow the instructions as the Wizard page request and change the settings in accordance to the information provided by your ISP.

If you use ADSL modem to make Cable/DSL access, please go to *3.2.1 PPPoE Connection for WAN*. If the fixed IP is used, please go to *3.2.2 Fixed IP for WAN*. As for the Cable modem, please go to *3.2.4 Dynamic IP for WAN*.



**Figure 3-3** The “Home” page of the Utility Menu Screen

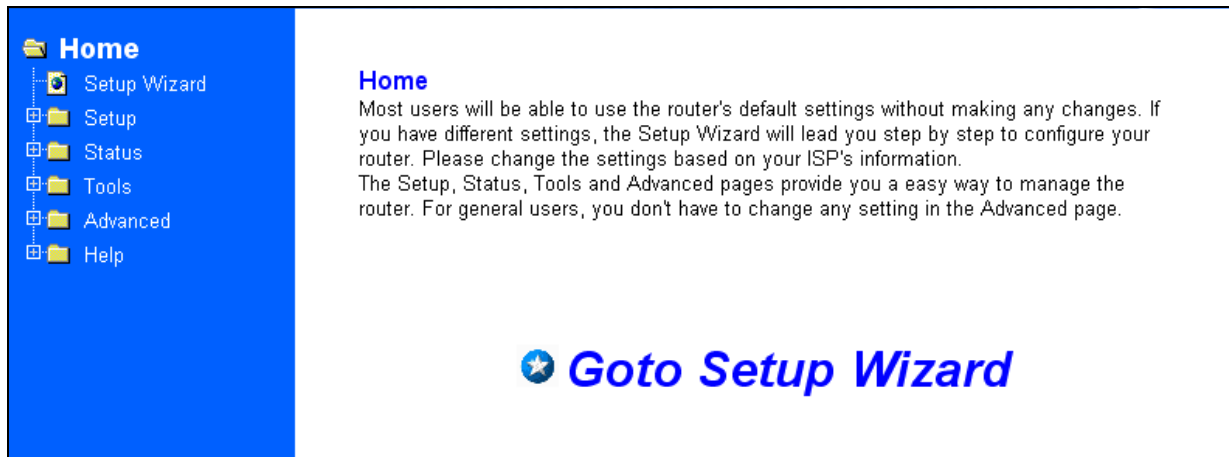

### 3.2.1 PPPoE Connection for WAN

If your ISP uses PPPoE (Point-to-Point Over Ethernet) to establish communications with end-users, you will receive information such as **User Name** and **Password** from them. To set up a PPPoE connection for WAN, follow the instructions as shown in Figure 3-4 *Cable/DSL Setup Menu Screen* and Figure 3-5 *Cable/DSL Setup Menu with “No” Option Screen*. Then, you need to configure the following values to make your router work. (See Figure 3-6 *PPPoE Menu Screen*)

- **User Name and Password**

Fill in the entries with the information you get from your ISP.

- **Service Name**

If your ISP provides this info, please type it into the field.

- **Connect on Demand**

If you have been disconnected due to inactivity, *Connect on Demand* will enable you to establish a connection again between your Router and ISP.

**- Max Idle Time**

The Max Idle time is the amount of time you would like to pass before the Router drops your Internet connection due to inactivity. Enter zero (0) in the field to remain Internet connection on at all time. The idle time ranges from 0 to 60 minutes.

**Figure 3-4 Cable/DSL Setup Menu Screen**

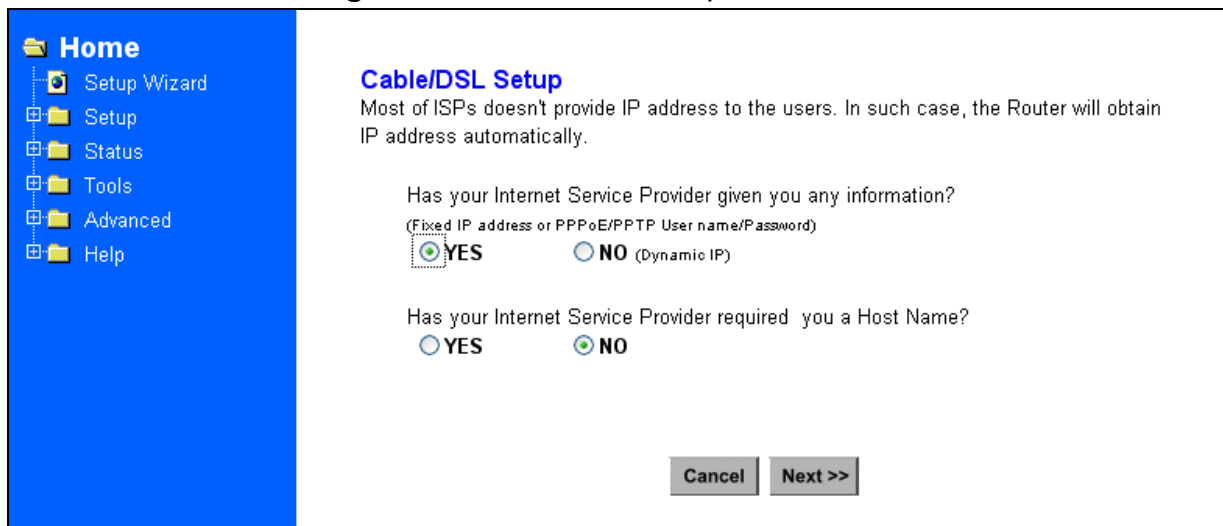

**Figure 3-5 Cable/DSL Setup Menu with "No" Option Screen**

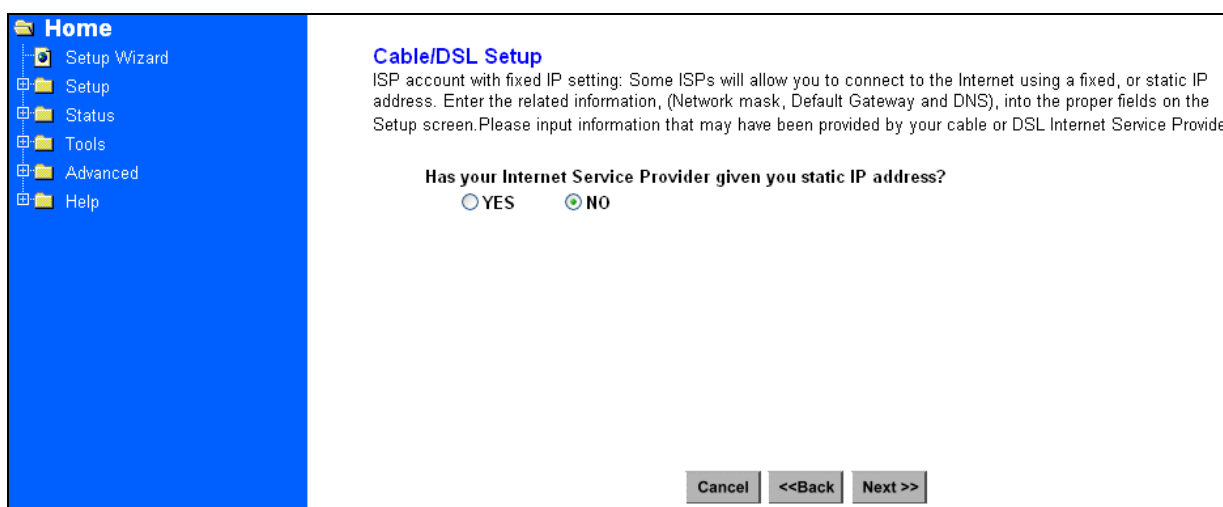

**Figure 3-6 PPPoE Menu Screen**

## 11Mbps Wireless Internet Broadband Router

**Home**

- Setup Wizard
- Setup
- Status
- Tools
- Advanced
- Help

### PPPoE

Your Internet Service Provider must provide you PPPoE authentication such as User name and password. Please fill the PPPoE information to make the route work. The Connect On Demand is to save the PPPoE connection charge. After the Max Idle Time passing without any traffic, the connection will be disconnected. And automatically establish the connection as soon as you attempt to access the Internet again.

User Name :

Password :

Confirm Password :

Service Name :

Connect on Demand :  Enabled  Disabled

Max Idle Time :  Min.

### 3.2.2 Fixed IP for WAN

If your ISP has assigned your home a static IP address (See Appendix A *About Static and Dynamic IP Address*), you may connect to the Internet by using a fixed, or static address. To set up a Fixed IP for WAN, do the following steps as an example.

**Step 1** Choose “YES” when you see the question: (See Figure 3-5 *Cable/DSL Setup Menu with “No” Option Screen*)

**Has your Internet Service Provider given you static IP address?**

Then select *Fixed IP*.

**Step 2** Enter the information of **IP Address**, **Subnet Mask** and **Default Gateway** as required. Then click the “NEXT” button. You should obtain above information from your ISP. If not, contact your ISP.

**Figure 3-7 Cable/DSL Setup Menu**

**Home**

- Setup Wizard
- Setup
- Status
- Tools
- Advanced
- Help

**Cable/DSL Setup**

ISP account with fixed IP setting: Some ISPs will allow you to connect to the Internet using a fixed, or static IP address. Enter the related information, (Network mask, Default Gateway and DNS), into the proper fields on the Setup screen. Please input information that may have been provided by your cable or DSL Internet Service Provider.

Has your Internet Service Provider given you static IP address?

YES  NO

Fixed IP  PPTP

IP Address :  .  .  .

Subnet Mask :  .  .  .

Default Gateway :  .  .  .

Cancel <<Back Next >>

**Step 3** Enter the **DNS Address**. (See Figure 3-8 *DNS Menu Screen*) Your ISP should provide you with at least one DNS IP Address. If not, contact your ISP.

**Figure 3-8 DNS Menu Screen**

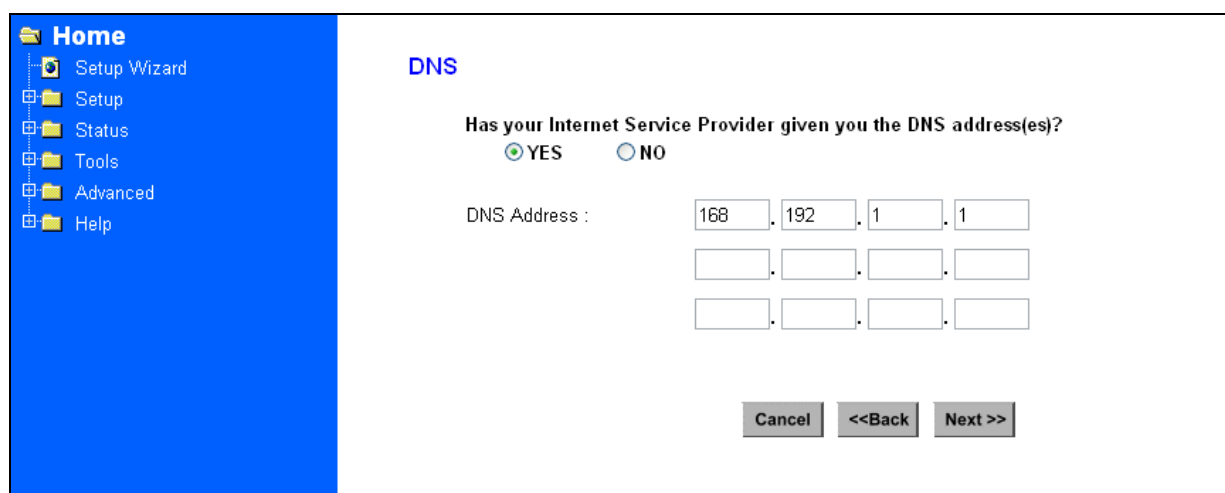

### 3.2.3 PPTP For WAN

**Step 1** Choose “YES” when you see the question: (See Figure 3-5 *Cable/DSL Setup Menu*)

**Has your Internet Service Provider given you static IP address?**

Then select “PPTP”.

**Figure 3-9**

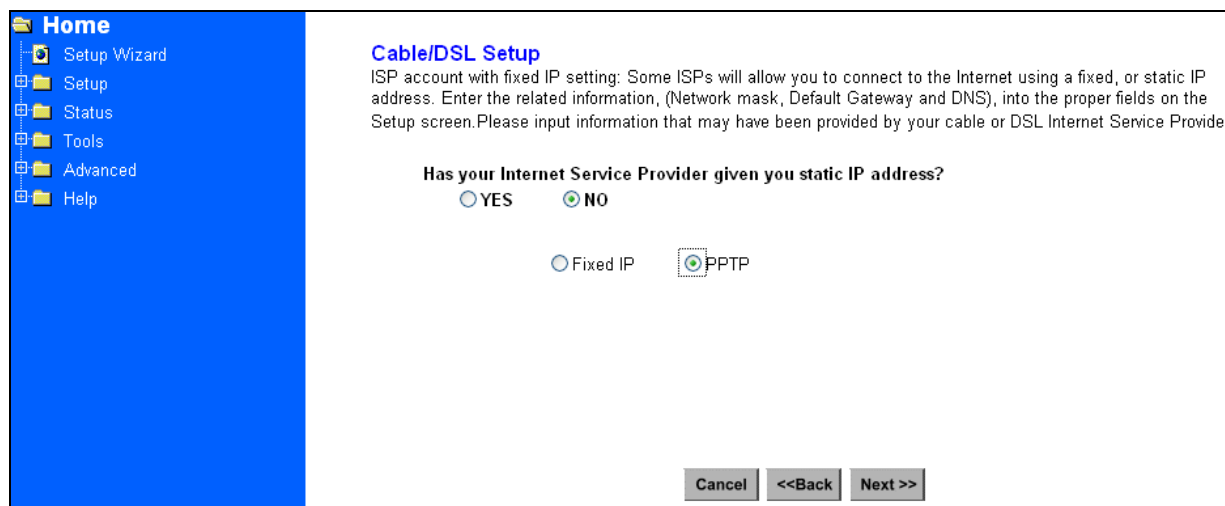

**Step 2** Click “Next>>”, and then the following screen will appear. Enter the information of “PPTP Account”, “PPTP Password”, and “Host Name”. “My IP Address” and “My Subnet Mask” assigned by your Internet Service Provider should be filled in.

**Figure 3-10 PPTP Settings Screen**

**Home**

- Setup Wizard
- Setup
- Status
- Tools
- Advanced
- Help

### PPTP Settings

Enter the PPTP user name and password assigned by your Service Provider. The Host Name is normally optional, but may be required by some service providers. 'Service IP Address' is your Internet Service Provider PPTP server IP. And You should fill 'My IP Address' and 'My Subnet Mask' assigned by your Internet Service Provider.  
Note: PPTP for a WAN connection is most popular in Europe.

PPTP Account :

PPTP Password :

Retype password :

Host Name :

Service IP Address :

My IP Address :

My Subnet Mask :

Connection ID :  (Optional)

Connect on Demand :  Enabled  Disabled

### 3.2.4 Dynamic IP for WAN

If you did not receive any values such as fixed IP address, Subnet Mask, Default Gateway and Primary DNS IP address from your ISP, choose the “**NO**” option in both Figure 3-4 *Cable/DSL Setup Menu Screen* and Figure 3-8 *DNS Menu Screen*.

**Note:** See Appendix A to learn more about static and dynamic IP address.

### 3.2.5 Alias IP Setup

The Alias IP Setup allows you to enter maximum 5 IP addresses that can be distributed to your computer. The error message will pop up if you enter more than 5 IP addresses.

See Figure 3-11 *Alias IP Setup*. Note that this function is effective only when your ISP supports it. If you want to delete the entered IP address, pull down the IP address and highlight the IP address you want to delete. Click *Delete this entry*. Then this IP address will be deleted.

The application of Virtual Server and DMZ Host IP Addresses requires more than one IP address. Alias IP provides a good support for such applications.

**Figure 3-11** Alias IP Setup

The screenshot shows the 'WAN Alias IP Setup' configuration page. On the left is a blue sidebar with a 'Home' menu containing 'Setup Wizard', 'Setup', 'Password', 'Configure', 'WAN Alias IP', 'DNS', 'Wireless', 'Time', 'Status', 'Tools', 'Advanced', and 'Help'. The main content area is titled 'WAN Alias IP Setup (Fixed IP mode only)' and includes a descriptive paragraph: 'If your Internet Service Provider has assigned a fixed address and more than one IP address, You can enter the assigned address to the 'Alias IP' for WAN port IP addresses. These Alias IP's will be used on 'Virtual server' and 'DMZ host setting'.' Below this, there is an 'IP Address' field with a dropdown menu labeled 'Select Alias Entry', a 'Delete this entry' button, and an 'Alias IP' field with four input boxes for IP octets. At the bottom are 'Apply' and 'Cancel' buttons.

### 3.2.6 DNS

Select the item of DNS from the Setup menu. The following screen will appear. You can enter the **DNS Address**. Your ISP should provide you with at least one DNS IP

# 11Mbps Wireless Internet Broadband Router

Address. If not, contact your ISP.

**Figure 3-12 DNS**

The screenshot displays the DNS configuration interface. On the left is a blue sidebar menu with the following items: Home, Setup Wizard, Setup, Password, Configure, Alias IP, DNS, Wireless, Time, Status, Tools, Advanced, and Help. The main content area is titled 'DNS' and contains the following elements:

- The text 'DNS Address :' is followed by three rows of IP address input fields.
- The first row contains the values: 168, 192, 1, 1.
- The second row contains the values: 255, 255, 255, 0.
- The third row contains the values: 168, 192, 1, 100.
- Below the input fields are two buttons: 'Apply' and 'Cancel'.

## 3.2.7 Wireless Configuration

You can access this screen at any time by clicking the Wireless button. (See Figure 3-13 *Wireless Configuration Screen*)



**Figure 3-13** Wireless Configuration Screen

Basic Settings :	
ESSID :	WLAN
Channel :	10

WEP Configuration :	
WEP :	<input type="radio"/> Enabled <input checked="" type="radio"/> Disabled
Default Key :	1 (ex: 1..4)
Encrypt Type :	<input checked="" type="radio"/> 40 bits <input type="radio"/> 128 bits
Key1 :	
Key2 :	
Key3 :	
Key4 :	

Access Control :	
Access Permission :	<input checked="" type="radio"/> Allow Everyone Access
	<input type="radio"/> Only Allow Access If On This List
Existing Stations :	
	Delete Stations
New Stations :	00 . 00 . 00 . 00 . 00 . 00
	Add Stations

Cancel <<Back Next >>

- **ESSID:** All Wireless devices in your Network must use the same ESSID. Make sure that this field reflects the correct ESSID for your network.
- **Channel No:** All Wireless devices in your Network must use the same ESSID. Make sure that this field reflects the correct channel for your network. Should you experience any interference, you may need to experiment with different channels to establish a better connection.
- **WEP:**  
WEP is Wired Equivalent Privacy, a data privacy mechanism based on a 40-bit or 128-bit shared key algorithm, as described in the IEEE 802.11b standard. Using a

128-bit shared key algorithm will increase network security. However, you may experience decreased network performance when using a 128-bit shared key algorithm. You may disable the encryption feature.

- **Default Key:** Select the algorithm key to be used in your 40-bit or 128-bit WEP-enabled wireless Network.
- **Encrypt Type:** Select 40-bit or 128-bit WEP-enabled wireless Network.
- **The WEP keys (1 - 4):** are 10 heximal numerals for 40-bit WEP or 26 heximal numerals for 128-bit WEP in length and can be any numeric combination. However, these keys must be used identically for each point on your wireless Network.
- **Access Control:** is designed to allow or prohibit others to access through the router. If you select “Allow Everyone Access”, everyone can access data through the router. If you select “Only Allow Access If On This List”, then you can add new stations allowed to access the data in the “New Stations” column. You can delete the existing stations in the “Existing Stations” column by choosing the stations you want to desert and clicking the “Delete Stations” button.

### 3.2.8 Time

You can get the data of the log files by setting the time zone. (See figure3-14 Time Zone)

**Figure 3-14 Time Zone**

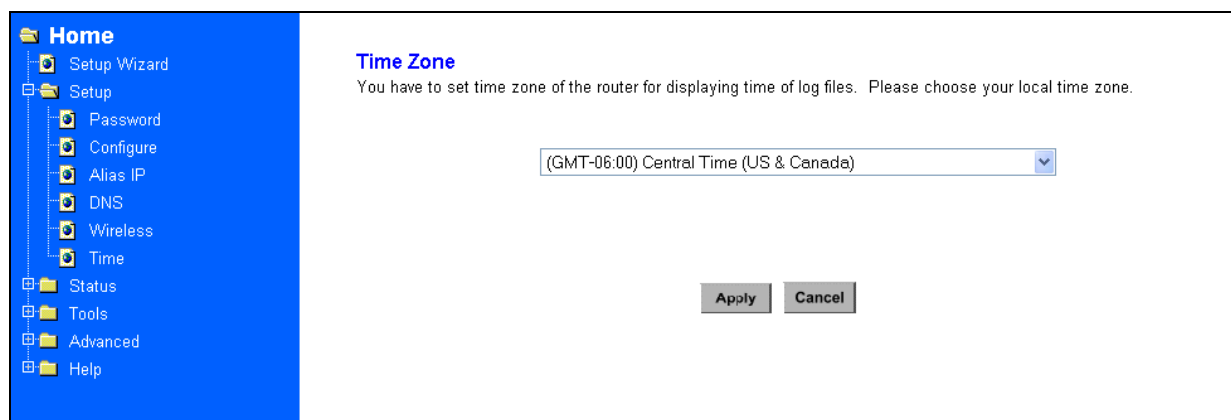

## 3.3 Browsing the Status

### 3.3.1 Status

This screen provides the current information of the device. All of the information provided is read-only. (See Figure 3-15 *Status Menu Screen*)

- **Router Name:** You will see the name of this device in this field.
- **Firmware Version:** You will see the installed version of the firmware.
- **WAN IP Configure:** This field shows whether or not you have enabled the use of PPPoE connection, Static IP or Dynamic IP.
- **Firewall Settings:**
  - NAT* allows all of the computers on your network to use one IP address.
  - Hacker Attack Protect* keeps you from hackers' attack.
  - DHCP server* shows the status of the router's DHCP server function.
  - Block Hacker Scan* makes your Router invisible so that hackers cannot find your Router on the network.
  - Remote Management* allows you to manage this device from the remote site via the network.
- **LAN:** These fields display the current *IP address* and *Subnet Mask* of the router as seen by the users on your internal network.
- **WAN:** These fields display the *IP Address*, *Subnet Mask* and *Default Gateway* of the router as seen by external users on the Internet. *DNS (Domain Name Server)* shows the IP address of the DNS currently being used.

**Figure 3-15** Status Menu Screen

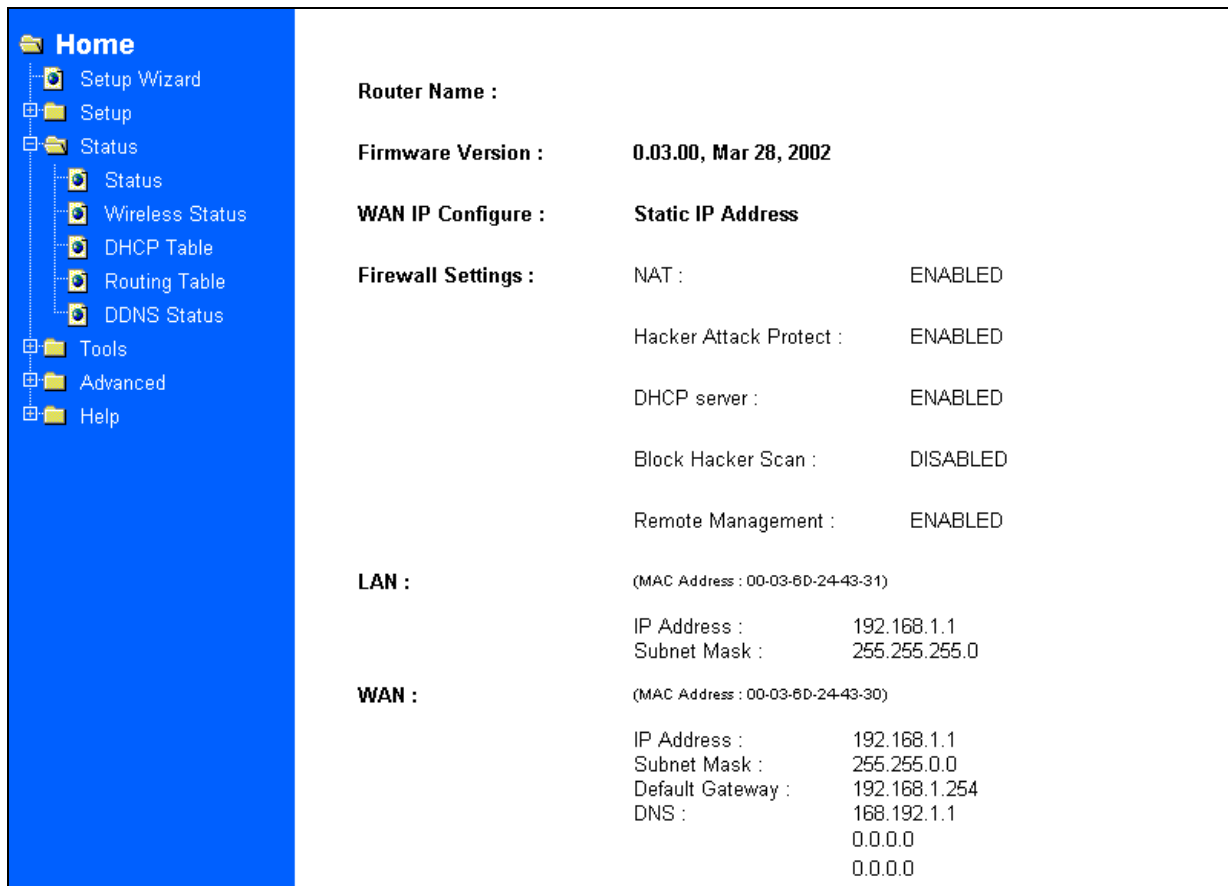

### 3.3.2 Wireless Status

This screen shows the setting status of the Wireless Channel.

**Figure 3-16** Wireless Status Screen

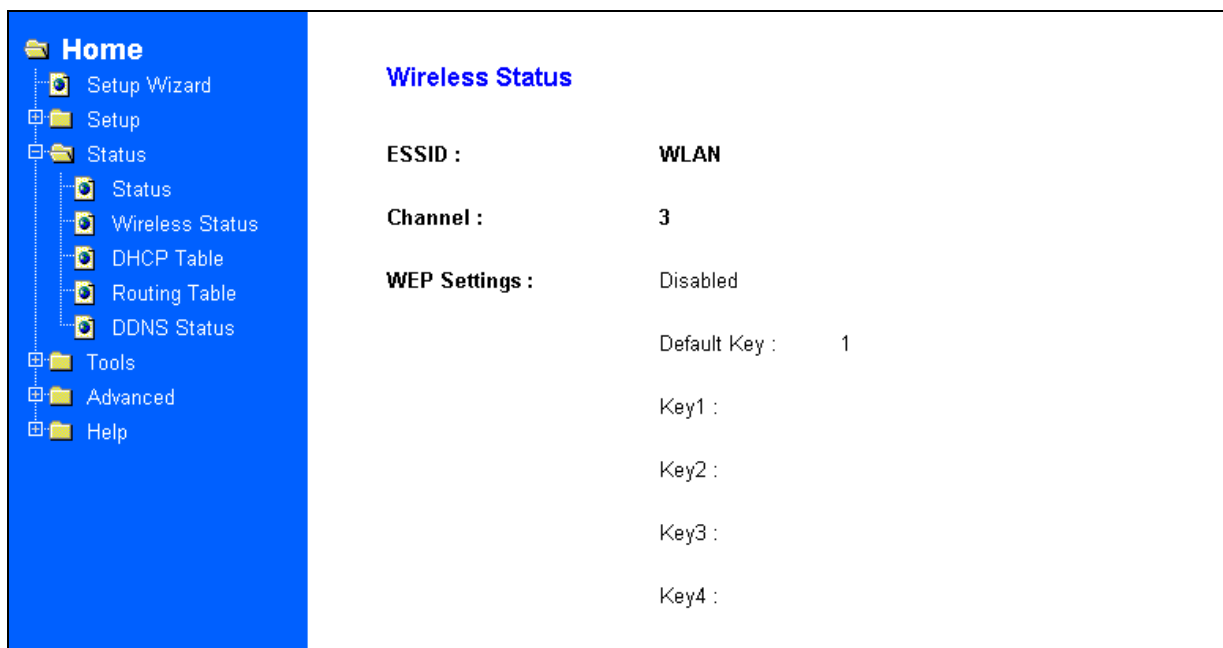

### 3.3.3 DHCP Table

This table shows the number of clients who exist on your DHCP pool and their information such as MAC Address, Computer name and IP Address. Figure 3-17 shows the *DHCP Table Screen*.

**Figure 3-17** DHCP Table Screen

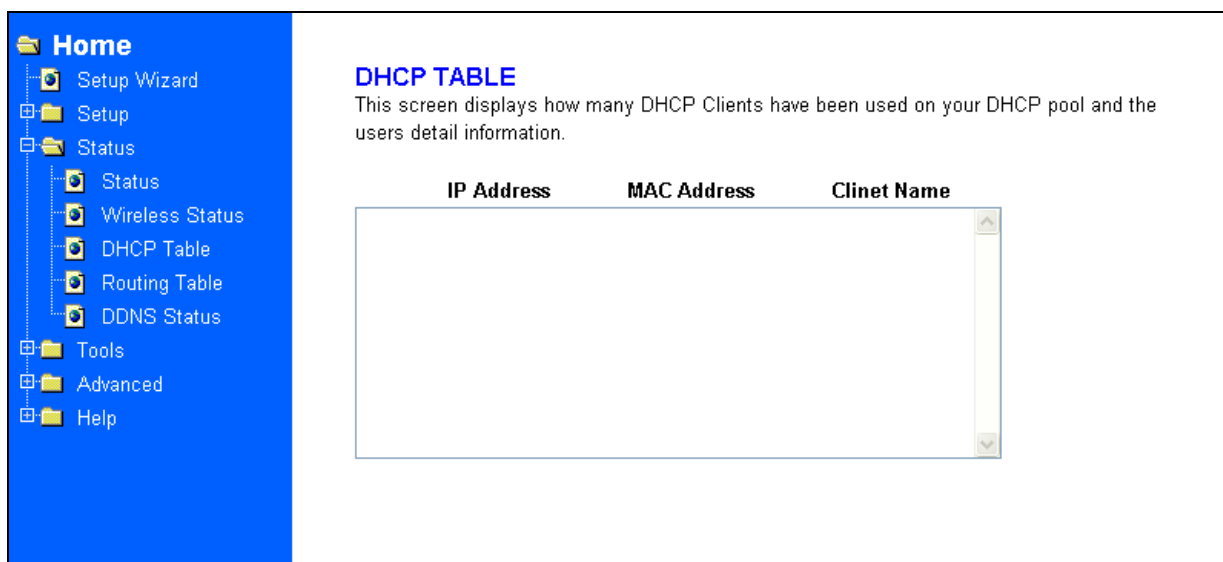

### 3.3.4 Routing Table

You will see the current routing configuration such as the address of Destination LAN IP, Default Gateway, Subnet Mask, Metric and the Interface (LAN or WAN). See Figure 3-18 *Routing Table Menu Screen*

**Figure 3-18** Routing Table Menu Screen

**Routing Table**  
This screen displays how many routings on your routing table and interface information.

Destination LAN IP	Default Gateway	Subnet Mask	Metric	Interface
0.0.0.0	192.168.1.254	0.0.0.0	0	LAN
192.168.0.0	192.168.1.1	255.255.0.0	0	WAN
192.168.1.0	192.168.1.1	255.255.255.0	0	LAN
210.61.152.0	210.61.152.101	255.255.255.0	0	WAN

### 3.3.5 DDNS Status Screen

This router supports the DDNS service allowing you to use one specific DNS name while the actual IP address changes. You can see the Dynamic DNS status from this screen. This screen shows the information of the connection status for the supported DDNS server. See Figure 3-19 DDNS Status Screen.

**Figure 3-19** DDNS Status Screen

**DDNS Status**  
This screen displays the connection status for the supported DDNS server.

Server	Status
MyDynDNS	No Account
No-IP	No Account
DtDNS	No Account

## **3.4 Viewing the Tools**

### **3.4.1 System Log**

You can acquire the information of the system in this screen, including the time, the type and the message.

Figure 3-20 System Log

Time	Type	Message
00:00:04	DHCPC	Entered WAIT_OFFER state.
00:00:04	DHCPC	Timed out in WAIT_OFFER state.
00:00:12	DHCPC	Entered WAIT_OFFER state.
00:00:12	DHCPC	Timed out in WAIT_OFFER state.
00:00:28	DHCPC	Entered WAIT_OFFER state.
00:00:28	DHCPC	Timed out in WAIT_OFFER state.
00:00:59	DHCPC	Entered WAIT_OFFER state.
00:00:59	DHCPC	Timed out in WAIT_OFFER state.
00:02:03	DHCPC	Entered WAIT_OFFER state.
00:02:03	DHCPC	Timed out in WAIT_OFFER state.
00:03:07	DHCPC	Entered WAIT_OFFER state.
00:03:07	DHCPC	Timed out in WAIT_OFFER state.
00:04:11	DHCPC	Entered WAIT_OFFER state.
00:04:11	DHCPC	Timed out in WAIT_OFFER state.
00:05:15	DHCPC	Entered WAIT_OFFER state.
00:05:15	DHCPC	Timed out in WAIT_OFFER state.
00:06:18	DHCPC	Entered WAIT_OFFER state.
00:06:18	DHCPC	Timed out in WAIT_OFFER state.
00:07:22	DHCPC	Entered WAIT_OFFER state.
00:07:22	DHCPC	Timed out in WAIT_OFFER state.
00:08:25	DHCPC	Entered WAIT_OFFER state.
00:08:25	DHCPC	Timed out in WAIT_OFFER state.
00:09:28	DHCPC	Entered WAIT_OFFER state.
00:09:28	DHCPC	Timed out in WAIT_OFFER state.
00:10:31	DHCPC	Entered WAIT_OFFER state.
00:10:31	DHCPC	Timed out in WAIT_OFFER state.
00:11:34	DHCPC	Entered WAIT_OFFER state.
00:11:34	DHCPC	Timed out in WAIT_OFFER state.
00:12:38	DHCPC	Entered WAIT_OFFER state.
00:12:38	DHCPC	Timed out in WAIT_OFFER state.
00:13:41	DHCPC	Entered WAIT_OFFER state.
00:13:41	DHCPC	Timed out in WAIT_OFFER state.

### 3.4.2 Hacker Log

You can detect the intrusion from this screen. This screen shows the information of the unauthorized access request to your network. See Figure 3-21 *Hacker Log Menu Screen*.

Figure 3-21 Hacker Log Menu Screen



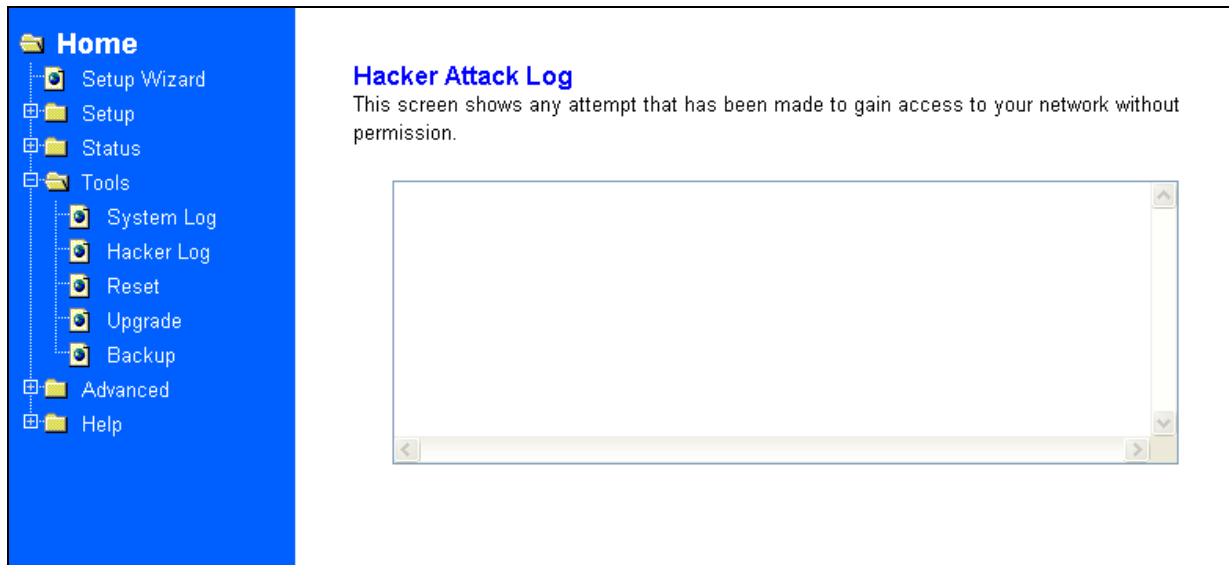

### 3.4.3 Reset

You have two options to reset your Router. If you choose “**Restart**”, the router will reboot yet retain all the previous configuration settings. On the other hand, if you choose “**Restore Factory Settings**”, the Router will remove all the previous settings and go back to the factory state. See Figure 3-22 *Reset Menu Screen*

For more information about “Reset”, see Page 10 *Caution: Reset Button*

**Figure 3-22** Reset Menu Screen

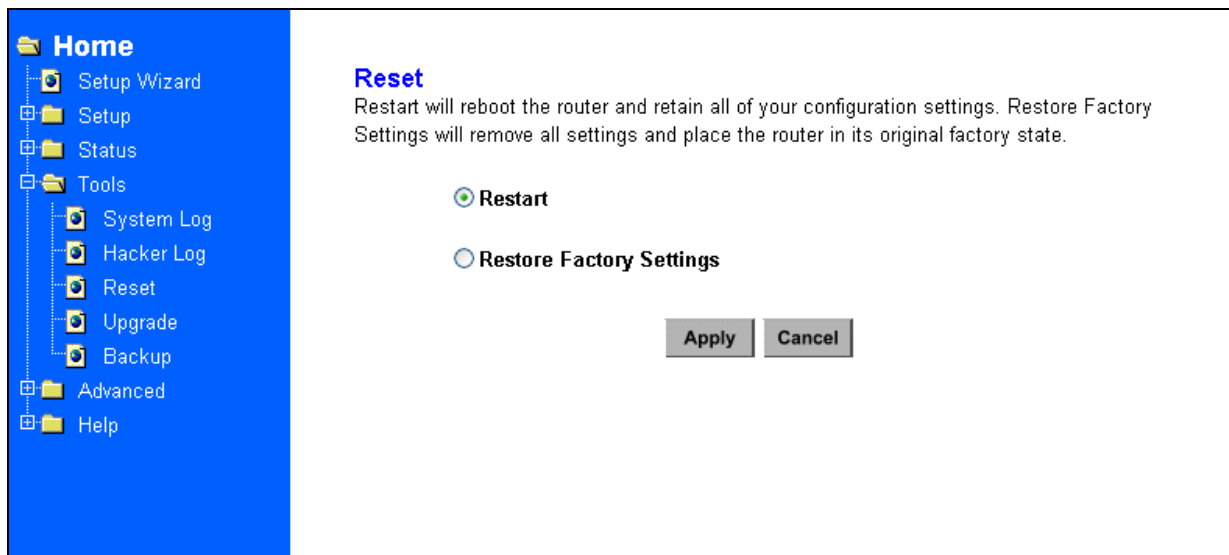

### 3.4.4 Upgrade

You may download the latest firmware version from us. To upgrade Router’s firmware, simply click the “Browse” button on the Upgrade Menu Screen and find the firmware upgrade file that you downloaded from the our website. Then, double-click the “Start” button. See Figure 3-23 *Upgrade Menu Screen*

**Figure 3-23 Upgrade Menu Screen**

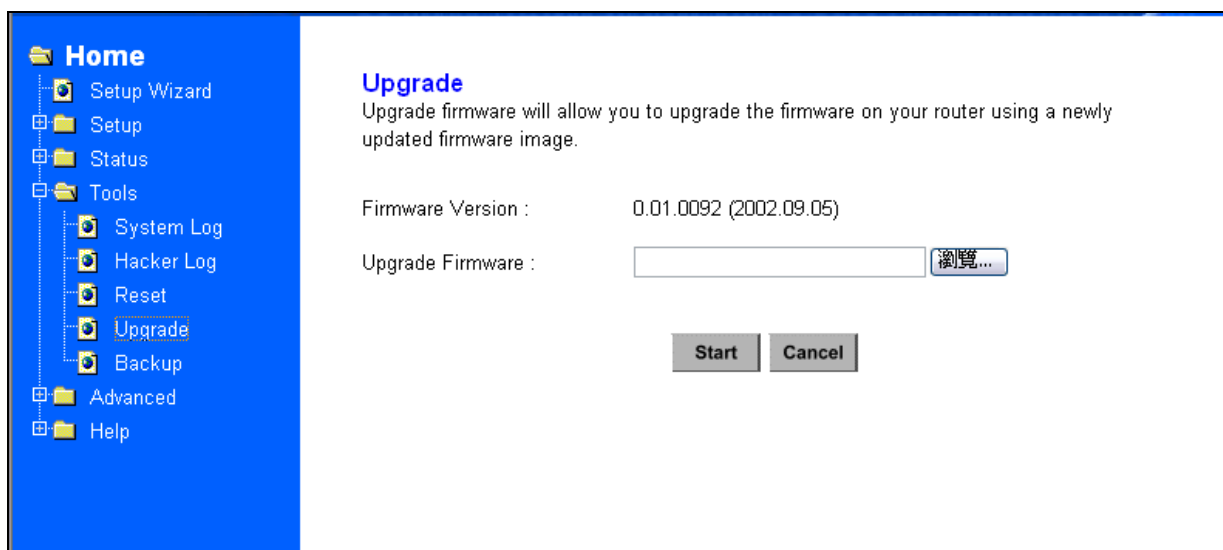

### 3.4.5 Backup

You can save the current configuration file to your PC or restore the configuration from PC.

**Figure 3-24 Backup Menu Screen**

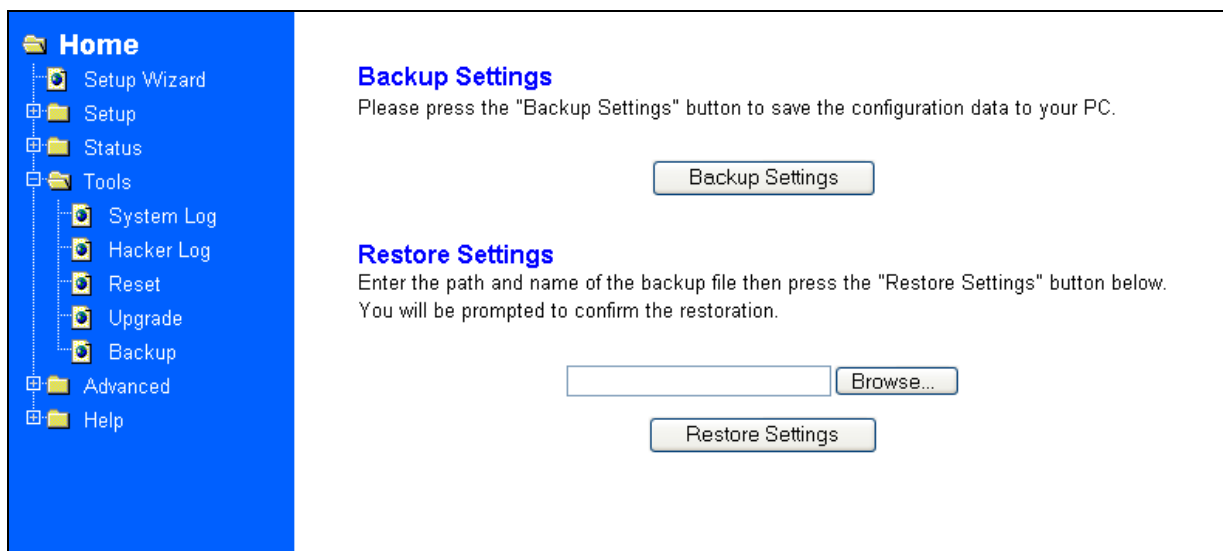

## 3.5 Setup the Advanced Features

Once you've configured the basic settings discussed in *section 3.2*, you may move to the settings of Advanced Features. In this section, we'll explain the setting of LAN IP, DHCP, Firewall, Privilege, Virtual Servers and the Routing. You may set up the

Advanced Features by clicking the “Advanced Features” button on the left column of the page.

### 3.5.1 LAN IP Setting

The LAN IP and Subnet Mask of the router are the values seen by the users on their internal network. The default value is 192.168.1.1 for IP and 255.255.255.0 for Subnet Mask. (See Figure 3-25 LAN IP Setting Menu Screen)

**Figure 3-25** LAN IP Setting Menu Screen

**Home**

- Setup Wizard
- Setup
- Status
- Tools
- Advanced
  - LAN IP Setting
  - DHCP Setting
  - Firewall Setting
  - Privilege
  - Virtual Servers
  - Routing
  - WAN MAC Clone
  - DDNS Setting
  - MAC Control
- Help

### LAN IP Setting

The function will change your router local network IP address. After the setting you may be need to change PC's IP address or renew the DHCP client IP.

IP Address :  .  .  .

Subnet Mask :  ▾

### 3.5.2 DHCP Setting

A DHCP (Dynamic Host Configuration Protocol) Server automatically assigns IP address to each computer on your network. Unless you already have one, it is highly recommended that your router be set up as a DHCP server. Figure 3-26 shows the DHCP Setting screen. Simply fill out the values of each entry and click the “**Apply**”

button. DHCP Setting:

- **Do you want to enable DHCP Server on this router?**  
Click the “**Enable**” option to enable the DHCP server. Note that you can’t have two DHCP servers on the network at the same time. Set the router’s DHCP option to “**Disable**” if you already have one DHCP server on your network.
- **Number of DHCP Users**  
Enter the maximum number of PC that you want the DHCP server to assign IP addresses to, with the absolute maximum being 253.
- **Starting IP Address**  
Enter a numerical value for the DHCP server to start with when issuing IP address.

**Figure 3-26** DHCP Setting Menu Screen

**Home**

- Setup Wizard
- Setup
- Status
- Tools
- Advanced
  - LAN IP Setting
  - DHCP Setting**
  - Firewall Setting
  - Privilege
  - Virtual Servers
  - Routing
  - WAN MAC Clone
  - DDNS Setting
  - MAC Control
- Help

**DHCP Setting**

The router can be set as a DHCP (Dynamic Host Configuration Protocol) server. If you choose to enable the DHCP server option, your PC client could get an IP address from a DHCP server.

Do you want to enable DHCP Server on this router?

YES  NO

Number of DHCP Users :

Starting IP Address :

### 3.5.3 Firewall Setting

**NAT** allows all of the computers on your network to use one IP address.

**Hacker Attack Protect** keeps your network away from hacker attacking.

**Block Hacker Scan** is used to hide the router so that the hackers won’t find it on the network.

**Remote Management** makes you be able to manage the router from Internet.  
**DMZ Host IP Addresses** can allow one local user to be exposed to the Internet, as local user wish to use some special-purpose service such as Internet game or Video-conferencing. Figure 3-27 shows the Firewall Setting screen.

**Figure 3-27** Firewall Settings Menu

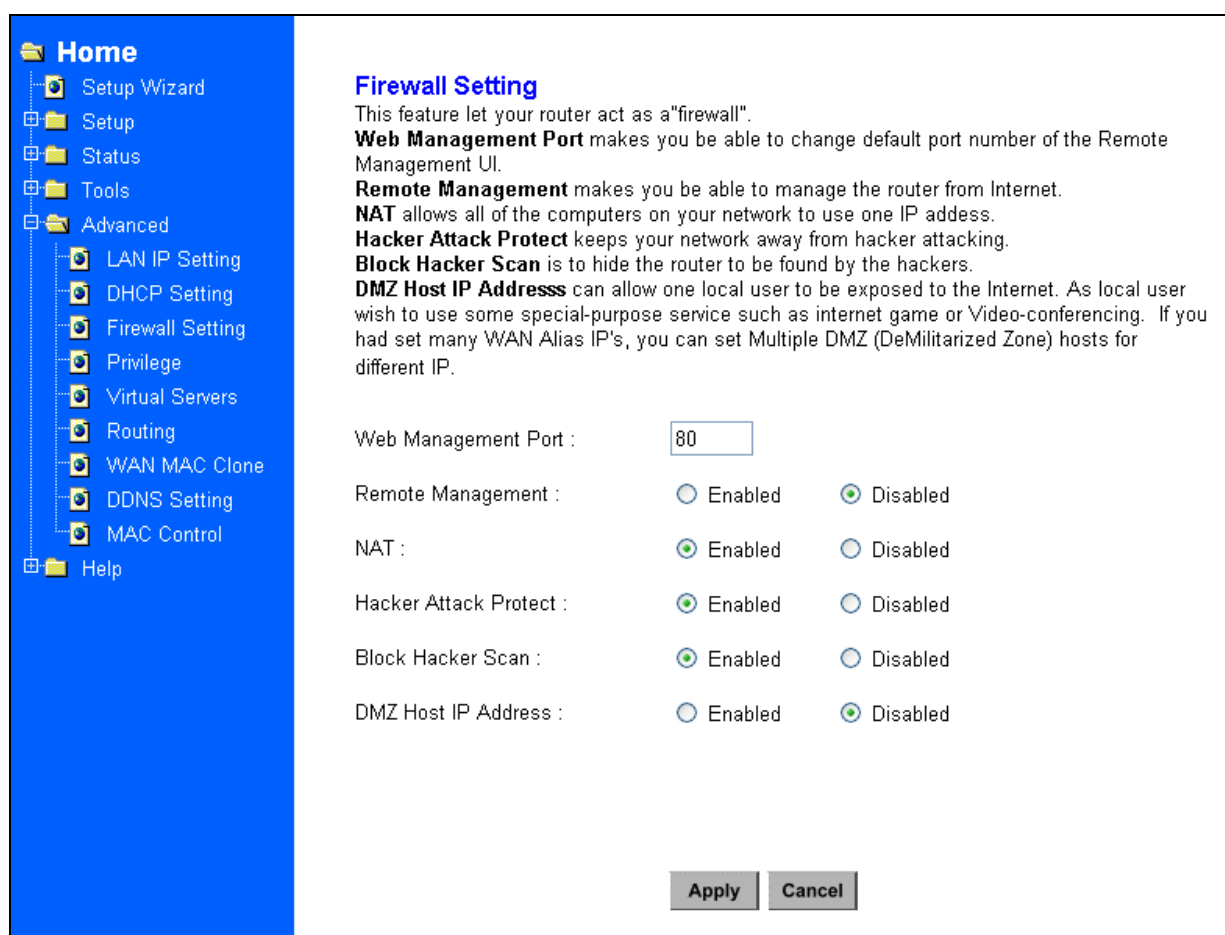

If you make the DMZ Host IP Address enabled, the following screen will appear.

**Figure 3-28** DMZ Host IP Address enabled

**Home**

- Setup Wizard
- Setup
- Status
- Tools
- Advanced
  - LAN IP Setting
  - DHCP Setting
  - Firewall Setting
  - Privilege
  - Virtual Servers
  - Routing
  - WAN MAC Clone
  - DDNS Setting
  - MAC Control
- Help

### Firewall Setting

This feature let your router act as a "firewall".

**Web Management Port** makes you be able to change default port number of the Remote Management UI.

**Remote Management** makes you be able to manage the router from Internet.

**NAT** allows all of the computers on your network to use one IP address.

**Hacker Attack Protect** keeps your network away from hacker attacking.

**Block Hacker Scan** is to hide the router to be found by the hackers.

**DMZ Host IP Address** can allow one local user to be exposed to the Internet. As local user wish to use some special-purpose service such as internet game or Video-conferencing. If you had set many WAN Alias IP's, you can set Multiple DMZ (DeMilitarized Zone) hosts for different IP.

Web Management Port :

Remote Management :  Enabled  Disabled

NAT :  Enabled  Disabled

Hacker Attack Protect :  Enabled  Disabled

Block Hacker Scan :  Enabled  Disabled

DMZ Host IP Address :  Enabled  Disabled

**WAN IP**  **LAN IP**

You can choose the WAN IP set up previously in 3.2.4 *Alias IP Setup* as your IP address. You can enter the desired IP address number in the blank of the LAN IP.

### 3.5.4 Privilege

Privilege setting allows you to keep certain PCs on your network from accessing to the Internet. You can set up a filter through an IP address or network port number. Users who have their IP address or Port number listed on the "Blocked Private Address" field or "Block Private Ports" field will no longer be able to access the Internet. Figure 3-29 shows the screen of Privilege setting.

**Figure 3-29** Privilege Menu Screen

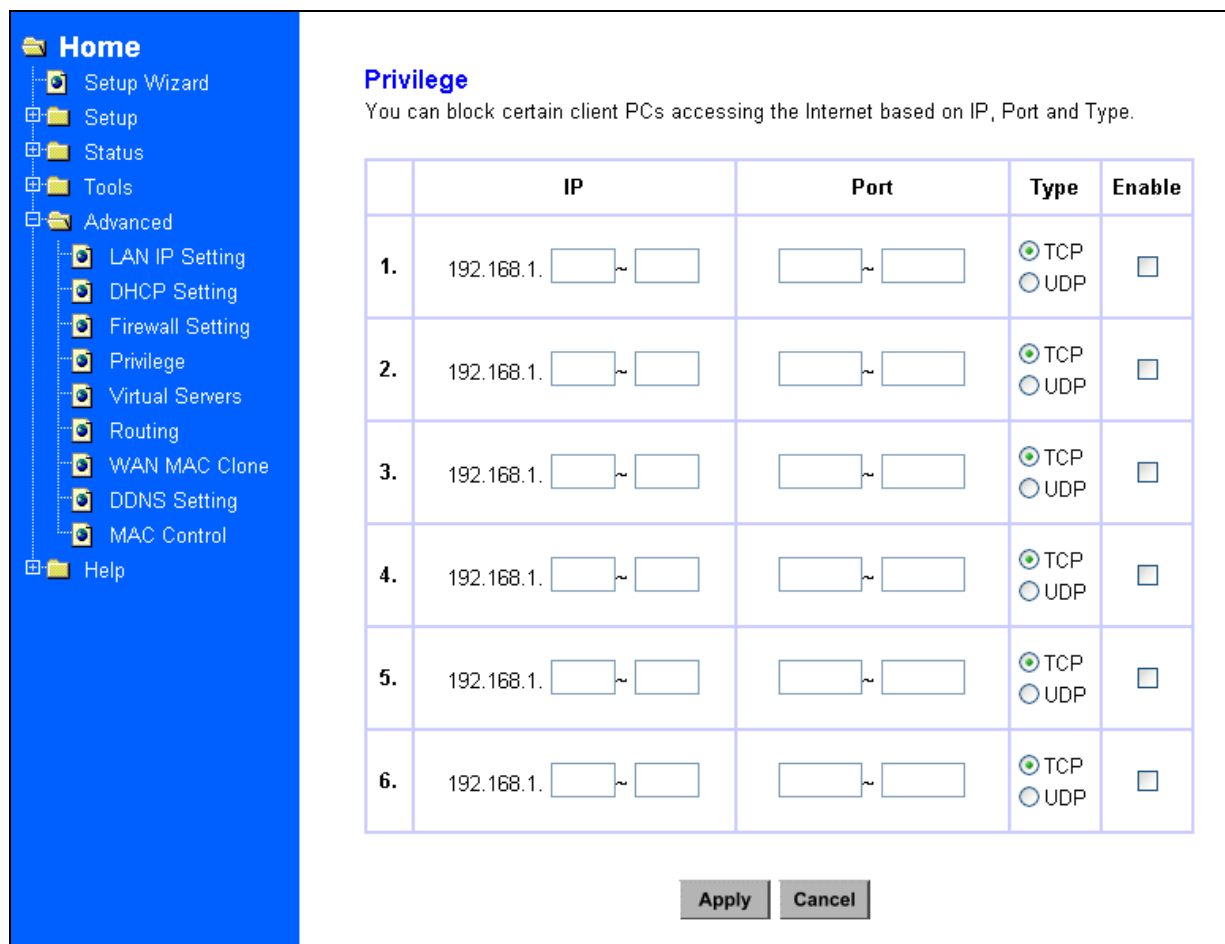

### 3.5.5 Virtual Servers

You can set up public services on your network by configuring the values in the Virtual Servers Setting menu. You may assign certain IP addresses as the destination of the network information. When users from the Internet make certain requests of your network, the Router will forward those requests to the appropriate computer. The DHCP function must be disabled to use this function.

This function is generally used to set up a web server, ftp server, or e-mail server on your network. Figure 3-30 shows the screen of Virtual Servers Menu. If you had set Alias IP for WAN, Figure 3-31 shows the screen of Virtual Servers Menu.

To add a Virtual Server:

1. Select the profile number used by the server.
2. Click on the “Name” column and enter the application name.
3. Select Enabled or Disabled to enable or disable the profile.

4. Enter the IP Address of the server that you want the Internet users to be able to access.
5. Configure as many entries as you would like until all the link entries are filled.
6. Click the “Apply” button to save the settings.

**Figure 3-30** Virtual Server Setting Menu Screen

**Virtual Servers and Special Application**

If you configure the gateway as a virtual server, remote users accessing services such as Web or FTP at your local site via public IP addresses can be automatically redirected to local servers configured with private IP address. In other words, depending on the requested service (TCP/UDP port number), the gateway redirects the external service request to the appropriate server.

You can define up to 10 application profiles and If you had set many WAN Alias IP's, select one of the public IP's as the Virtual Server. Some applications require multiple connections, such as Internet gaming, video conferencing, Internet telephony and others. These applications cannot work when Network Address Translation (NAT) is enabled. If you need to run applications that require multiple connections, enter the service ports associated with an application.

Application to Configure :

Name :

Status :

IP Address :

Service Port(0-65535)	
1.	<input type="text" value="0"/> ~ <input type="text" value="0"/>
2.	<input type="text" value="0"/> ~ <input type="text" value="0"/>
3.	<input type="text" value="0"/> ~ <input type="text" value="0"/>
4.	<input type="text" value="0"/> ~ <input type="text" value="0"/>
5.	<input type="text" value="0"/> ~ <input type="text" value="0"/>
6.	<input type="text" value="0"/> ~ <input type="text" value="0"/>
7.	<input type="text" value="0"/> ~ <input type="text" value="0"/>
8.	<input type="text" value="0"/> ~ <input type="text" value="0"/>
9.	<input type="text" value="0"/> ~ <input type="text" value="0"/>
10.	<input type="text" value="0"/> ~ <input type="text" value="0"/>

**Well-known Ports (Commonly Used Ports)**

7	(Echo)
21	(FTP)
23	(TELNET)
25	(SMTP)
53	(DNS)
79	(finger)
80	(HTTP)
110	(POP3)
119	(NNTP)
161	(SNMP)
162	(SNMP Trap)

**Application to Configure:** You can choose one of 10 applications to configure.

**Name:** Enter the desired name in the column.

**Status:** Choose *Enabled* to enable it or *Disabled* to ignore.

**IP Address:** Set IP addresses to be detected by users.

**WAN Address:** If more than one Alias Address is set in section 3.2.5 the Alias IP Setup, you can get multiple WAN IP addresses to choose. The following screen will appear with a pull-down column in WAN Address.



**Figure 3-31 Virtual Server Setting Menu Screen (With WAN Address)**

**Virtual Servers and Special Application**

If you configure the gateway as a virtual server, remote users accessing services such as Web or FTP at your local site via public IP addresses can be automatically redirected to local servers configured with private IP address. In other words, depending on the requested service (TCP/UDP port number), the gateway redirects the external service request to the appropriate server.

You can define up to 10 application profiles and If you had set many WAN Alias IP's, select one of the public IP's as the Virtual Server. Some applications require multiple connections, such as Internet gaming, video conferencing, Internet telephony and others. These applications cannot work when Network Address Translation (NAT) is enabled. If you need to run applications that require multiple connections, enter the service ports associated with an application.

Application to Configure :

Name :

Status :

WAN Address :

IP Address :

**Well-known Ports (Commonly Used Ports)**

7	(Echo)
21	(FTP)
23	(TELNET)
25	(SMTP)
53	(DNS)
79	(finger)
80	(HTTP)
110	(POP3)
119	(NNTP)
161	(SNMP)
162	(SNMP Trap)

**Service Port(0~65535)**

1.  ~

2.  ~

3.  ~

4.  ~

5.  ~

6.  ~

7.  ~

8.  ~

9.  ~

10.  ~

### 3.5.6 Routing

#### Static Routing:

You may set up a static route if you want to connect your router to more than one network. A static route is a pre-determined pathway that network information must travel to reach a specific host or network.

Figure 3-32 shows the screen of *Static Routing and Dynamic Routing menu*.

Create a Static route entry as follows:

1. Select "Static Routing" from the drop down list.
2. Enter the following data to set the Static Routing:

### **Destination LAN IP**

You can create a static route by entering the IP address of the remote host or network. If you wish to build a route to the entire network, be sure to set the network portion of the IP address to zero (0).

### **Subnet Mask**

The Network Mask determines which portion of an IP address is the network portion, and which portion is the host portion.

### **Gateway IP**

This is the address of the gateway device that allows for a contact between the Router and the remote network or host.

### **Dynamic Routing:**

Dynamic Routing can be used to cache routes learned by routing protocols, thus allowing the automation of static routing maintenance. The router, using the RIP protocol, determines the network packet's route based on the fewest number of hops between the source and the destination. In this case, you could automatically adjust to physical changes in the network's layout. Complete the following steps to set up dynamic Routing:

**Step 1** Choose the Working Mode.

**Gateway Mode** means the router is served as a gateway that hosts your network's connection to the Internet.

**Router Mode** means there is more than one router that exists on your network.

**Step 2** Select **Dynamic Routing** from the drop down list and choose the protocol you wish to use on your network.

**Step 3** Click the "**Apply**" button.

**Figure 3-32** Static Routing and Dynamic Routing Menu Screen

**Home**

- Setup Wizard
- Setup
  - Password
  - Configure
  - Alias IP
  - DNS
  - Wireless
  - Time
- Status
- Tools
- Advanced
  - LAN IP Setting
  - DHCP Setting
  - Firewall Setting
  - Privilege
  - Virtual Servers
  - Routing**
  - WAN MAC Clone
  - DDNS Setting
  - MAC Control
- Help

**Static Routing**

This feature sets a fixed path for data to follow on the network. The router will continue to function properly if you choose not to enable this feature.

Static Routing :

Destination LAN IP :  .  .  .

Subnet Mask :  .  .  .

Gateway :  .  .  .

**Dynamic Routing**

The dynamic routing setup allows your network to dynamically adjust to layout changes. Gateway mode should be used if your router is hosting your network's connection to the Internet. Router mode should be selected if the router exists on a network with other routers.

Working Mode :  Gateway  Router

Dynamic Routing :

### 3.5.7 WAN MAC Clone

Enter the MAC Address if your ISP can be accessed by one specific PC's Ethernet MAC address. (See **Figure 3-33** WAN MAC Address Clone)

Click **Restore MAC Address** to return to the default set.

**Figure 3-33** WAN MAC Address Clone

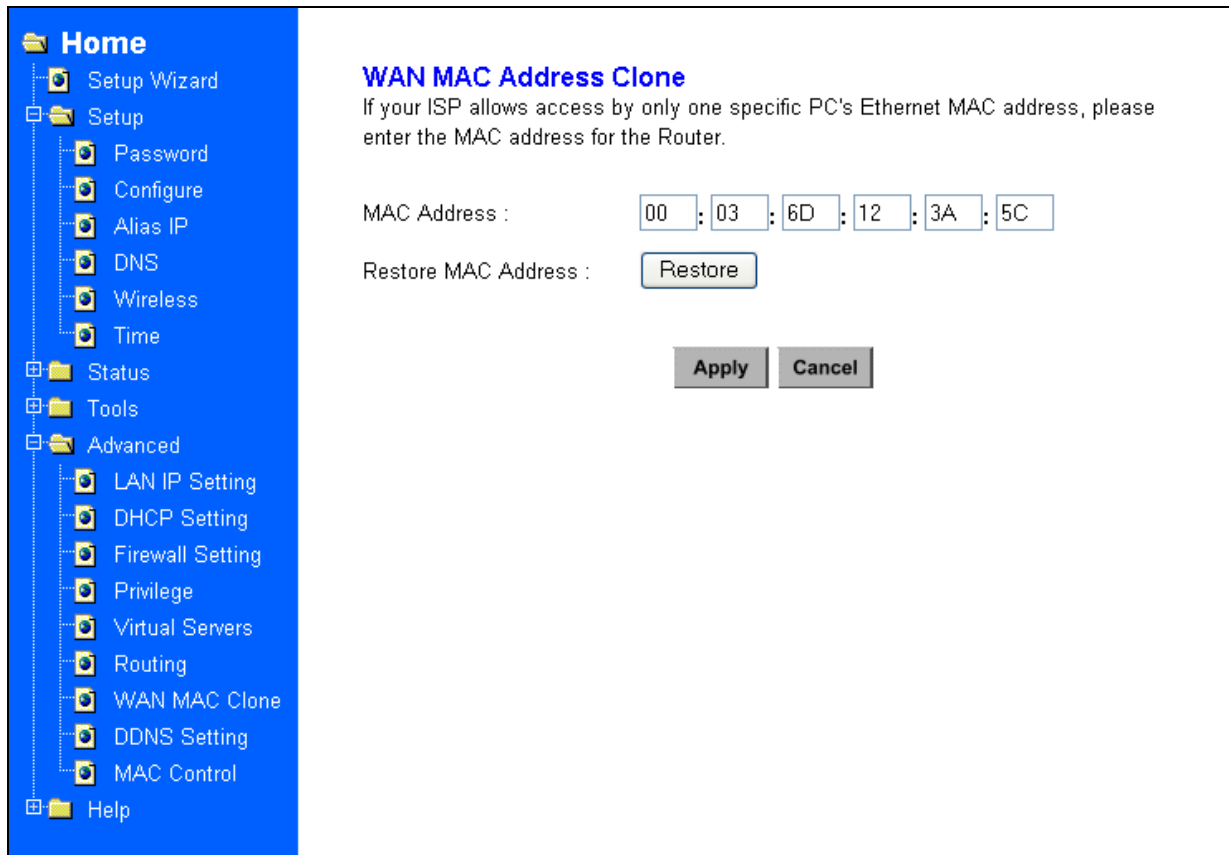

### 3.5.8 DDNS Setting

Setting the Dynamic DNS allows others to access your FTP or Web service on your computer using DNS-like address.

**DDNS Status:** Choose *Enabled* to enable it or *Disabled* to ignore.

**Retry Time:** It allows the router to make the connection again in the period you set.

**DDNS Server:** Choose the desired server from the drop down list. Click the **Website** to make the link to the server.

**Host name:** It is the DNS-like address used to access your FTP or web service.

**User Name:** This is the user name for your account at DNS server.

**Password:** This is the password for your account at DNS server.

**Figure 3-34** DDNS Setting Screen

**Home**

- Setup Wizard
- Setup
  - Password
  - Configure
  - Alias IP
  - DNS
  - Wireless
  - Time
- Status
- Tools
- Advanced
  - LAN IP Setting
  - DHCP Setting
  - Firewall Setting
  - Privilege
  - Virtual Servers
  - Routing
  - WAN MAC Clone
  - DDNS Setting
  - MAC Control
- Help

**DDNS Setting**

Dynamic DNS allows you to update your dynamic IP address with one or many dynamic DNS services. So anyone can access your FTP or Web service on your computer using DNS-like address.

DDNS Status :  Enable  Disable

Retry Time :  minutes

DDNS Server :  Website

Host Name :

User Name :

Password :

### 3.5.9 MAC Control

This feature allows you to block certain specific PCs accessing your ISP.

**Figure 3-35** MAC Control Screen

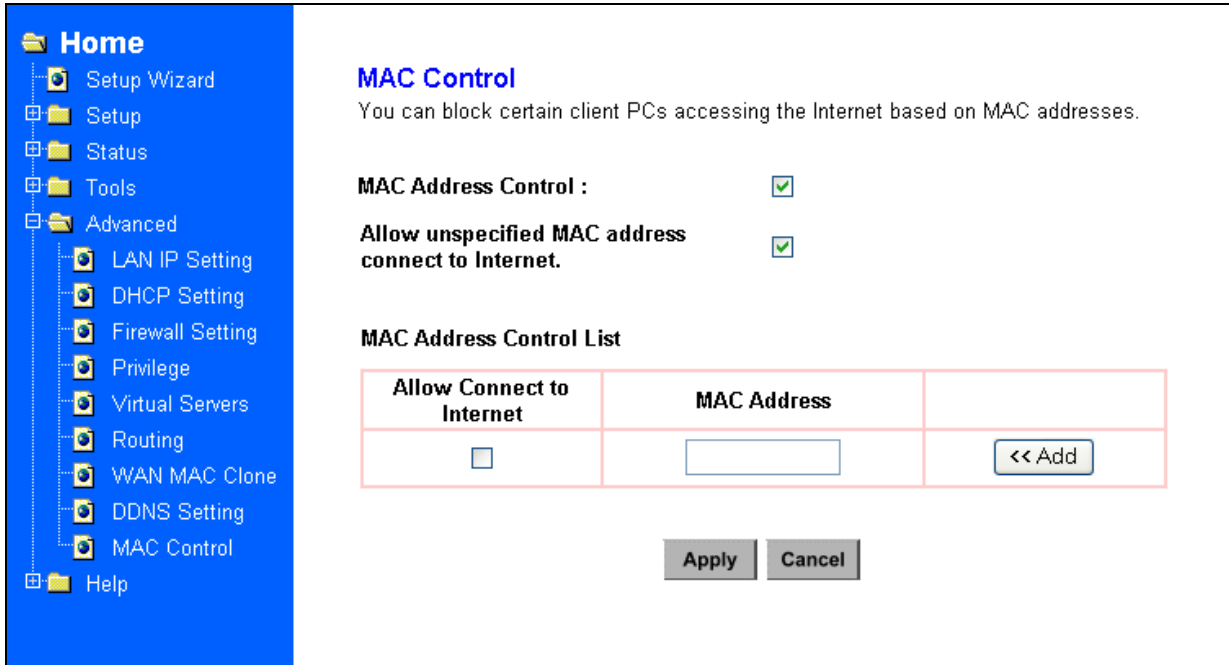

### 3.6 Configuring your PCs to Connect to the Router

Before you start to configure other PCs to accept the IP address that your Router will provide, make sure the network card or adapter has been successfully installed into each PC you planed to connect to the Router. Complete the following steps to configure your PC:

**Step 1** Click the **Start** button, select **Setting**, then **Control Panel**.

**Step 2** Double Click the **Network and Dial-up** icon.

**Step 3** Highlight the Local Area Connection and click the button of Properties.

**Step 4** In the Configuration window, select the **TCP/IP protocol** line that has been associated with your network card or adapter. (See Figure 3-36)

**Figure 3-36** Network Box Screen

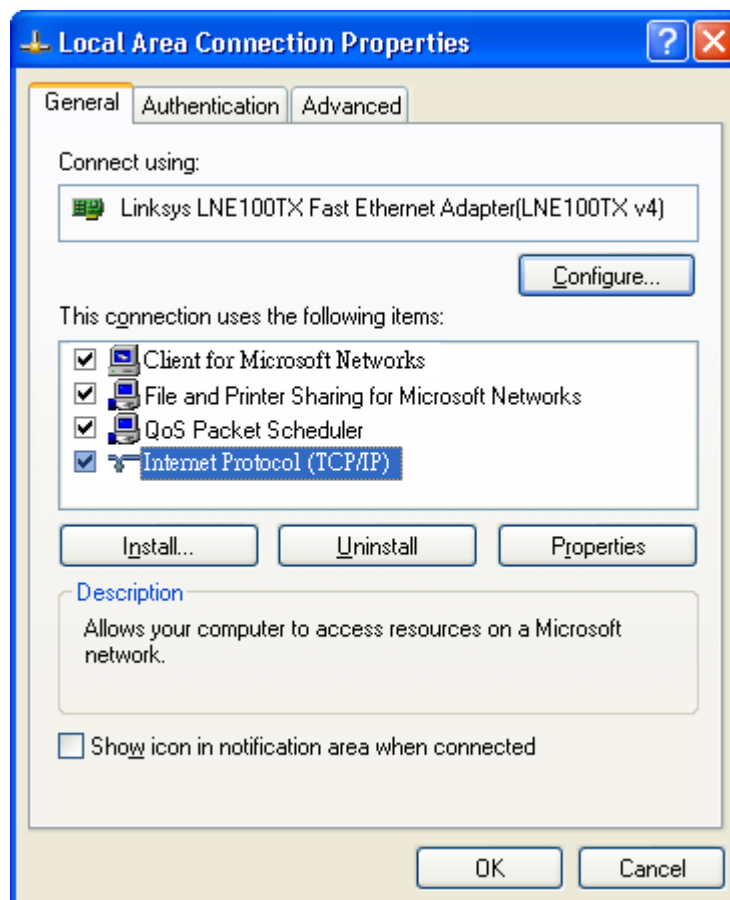

**Step 5** Click **Properties** button, then choose **IP Address** tab. Select **Obtain an IP address** automatically. Press **OK**. You have completed the client settings. (See Figure 3-37)

**Note:** Windows may ask you for original Windows installation files, supply them as needed.

**Figure 3-37 TCP/IP Properties**

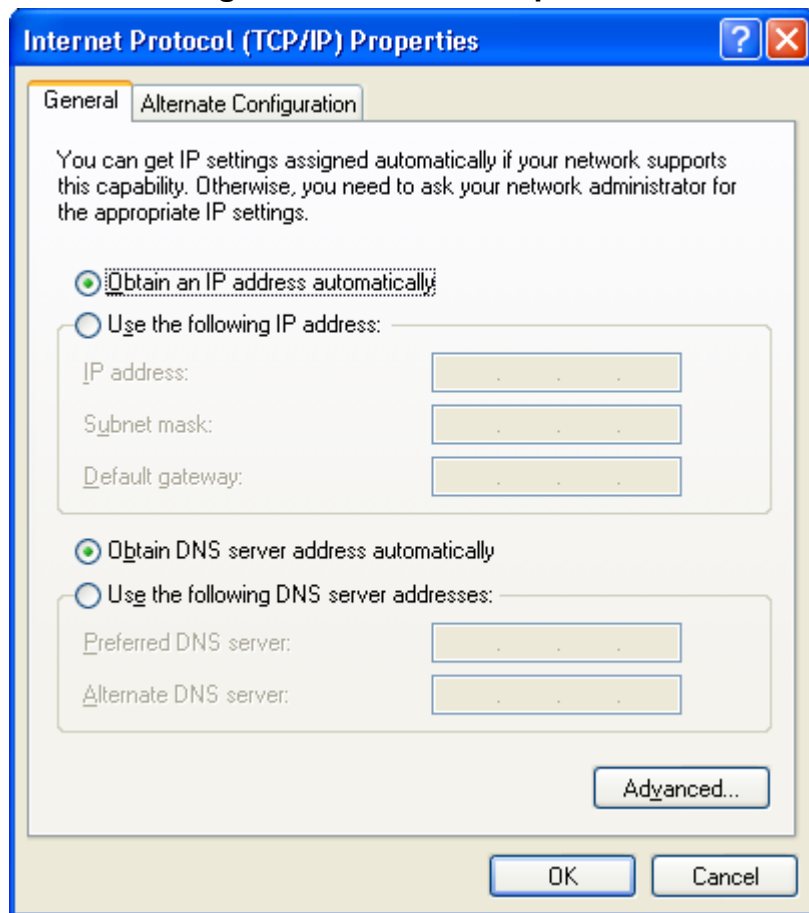



## 4: Specifications

### 4.1 Technical Specifications

<b>Standards</b>	IEEE 802.3, IEEE 802.3u, IEEE 802.11b
<b>Protocol</b>	CSMA/CD, PPPoE, PPP, PPTP Client, ARP, DHCP Client and Server, TCP/IP, UDP, ICMP, RIP1/RIP2, DNS Proxy, Dynamic DNS, SNTP
<b>Ports</b>	Four 10/100 Mbps LAN ports One 10/100 Mbps WAN ports
<b>Connector</b>	RJ-45 connector
<b>Antenna</b>	Fixed Type
<b>Speed</b>	WAN Router: 10/100 Mbps (Half Duplex), 20/200 Mbps (Full Duplex) LAN Switch: 10/100 Mbps (Half Duplex), 20/200 Mbps (Full Duplex) Wireless: 1, 2, 5.5, 11 Mbps
<b>Cabling Type</b>	10Base-T: UTP/STP Category 3 or 5 100Base-TX: UTP/STP Category 5
<b>Topology</b>	Star
<b>LED</b>	Power, Diag, WAN & Wireless per unit, Link/ACT, FULL /Col, 10/100 per port
<b>NAT</b>	Translate private IP to public IP
<b>Multiple DMZ</b>	Support multiple public IP translate to multiple private IP
<b>Virtual Server</b>	Provide public services on the network
<b>Firewall</b>	PSec, PPTP, L2TP pass through, Hacker Attack Prevention
<b>Access Control</b>	IP/MAC filter
<b>Management</b>	Web-based Configuration

## 4.2 Environmental Information

<b>Dimensions</b>	170 x 185 x 27 mm
<b>Unit Weight</b>	637g
<b>Power</b>	DC 5V/2A
<b>Operating Temperature</b>	0°C to 50°C (32°F to 122°F)
<b>Storage Temperature</b>	-40°C to 70°C (-40°F to 158°F)
<b>Operating Humidity</b>	20% to 95% relative humidity, non-condensing
<b>Storage Humidity</b>	20% to 95% relative humidity, non-condensing

## 4.3 Standard Conformance

<b>EMC Certification</b>	FCC Class B, CE
--------------------------	-----------------

## 4.4 Cable Specifications

<b>Ethernet Type</b>	<b>Cable Requirements</b>	<b>Maximum Length</b>
<b>10BASE-T</b>	Category 3 or better, UTP or STP	328 ft (100M)
<b>100BASE-TX</b>	Category 5 or better, UTP or STP	328 ft (100M)
<b>1000BASE-T</b>	Category 5e or better, UTP or STP	328 ft (100M)

**Caution:** Please do not use telephone cables. Telephone cables do not support Ethernet or Fast Ethernet

There are two types of cables: Straight Through Cables and Crossover Cables. Category 5 UTP/STP cable has eight wires inside the sheath. The wires form four pairs. Straight Through Cables has same pin-outs at both ends while Crossover Cables has a different pin arrangement at each end.

Figure 4-1 shows the diagram of Straight Through Cables. Figure 4-2 shows the diagram of Crossover Cables.

**Figure4-1: Diagram of Straight Through Cables**

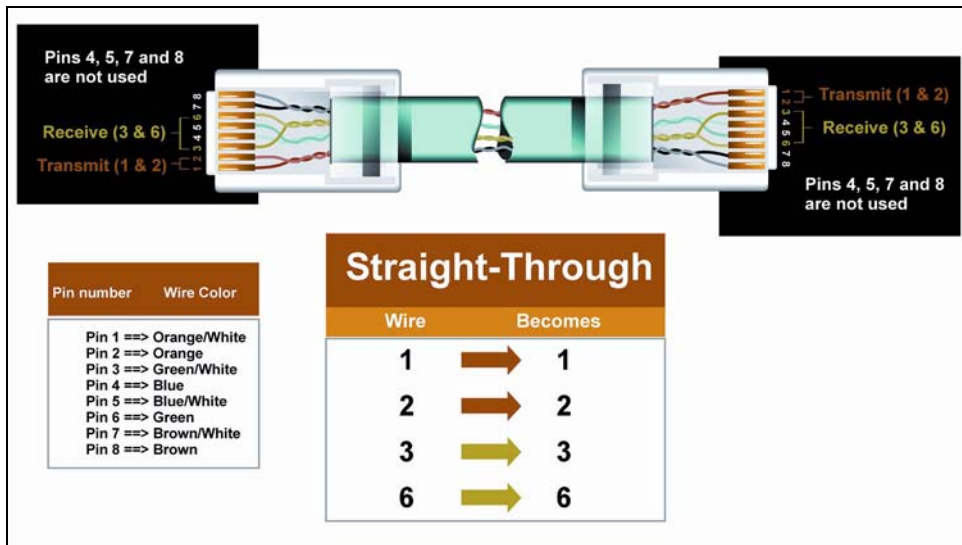

**Figure4-2: Diagram of Crossover Cables Diagram**

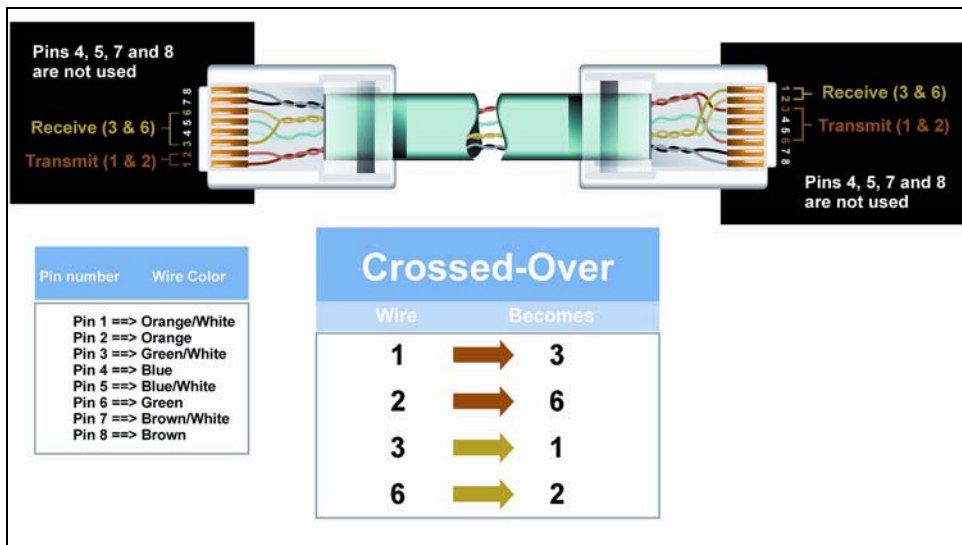

## **Appendix A: About Static and Dynamic IP**

### **Address**

A *static IP address* is an IP address that is assigned to a computer by an Internet service provider to be its permanent address on the Internet. It is normally used in the computer networks, where computers are connected all the times. As the Internet gets more crowded, there are not enough IP numbers to go around. For this reason, more and more ISPs are offering dynamic IP address instead. Check with your ISP if they provide you a Static IP address. A *dynamic IP address* is a temporarily IP address assigned by a DHCP (Dynamic Host Configuration Protocol) server from a pool of IP addresses. A dynamic IP address may change every time when you log in the network.

## **Appendix B: Warranty Statement**

We provide this limited warranty for its product only to the person or entity who originally purchased the product from us or its authorized reseller or distributor. We guarantee that equipment is free from physical defects in workmanship and material under normal use from the date of original retail purchase of the Hardware. If the product proves defective during this warranty period, call our Customer Service in order to obtain a Return Authorization number. Be sure to have a proof of purchase on hand when calling. Return requests cannot be processed without proof of purchase. When returning a product, mark the Return Authorization Number clearly on the package pack and include your original proof of purchase. All customers outside the R.O.C shall be held responsible for shipping and handling charges.

In no event shall our liability exceed the price paid for the product from direct, incidental or consequential damage resulting from the use of the product, its accompanying software, or its documentation. We make no warranty or representation, expressed, implied, or statutory, with respect to its products or the contents or use of this documentation and all accompanying software, and specifically disclaims its quality, performance, merchantability, or fitness for any particular purpose. We reserve the right to revise or update its products, software, or documentation without obligation to notify any individual or entity.

## Free Manuals Download Website

<http://myh66.com>

<http://usermanuals.us>

<http://www.somanuals.com>

<http://www.4manuals.cc>

<http://www.manual-lib.com>

<http://www.404manual.com>

<http://www.luxmanual.com>

<http://aubethermostatmanual.com>

Golf course search by state

<http://golfingnear.com>

Email search by domain

<http://emailbydomain.com>

Auto manuals search

<http://auto.somanuals.com>

TV manuals search

<http://tv.somanuals.com>