

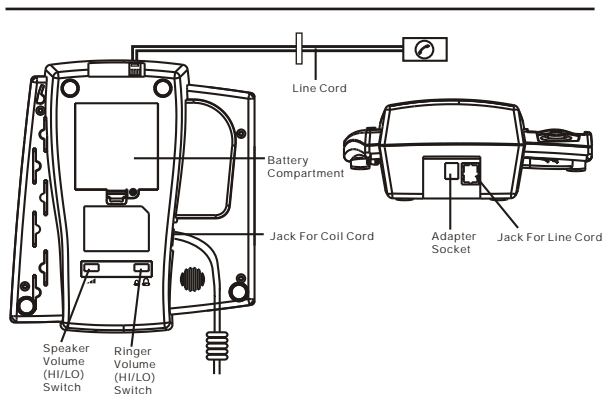

XL-2031IDW USER'S MANUAL

MAIN DIAGRAM

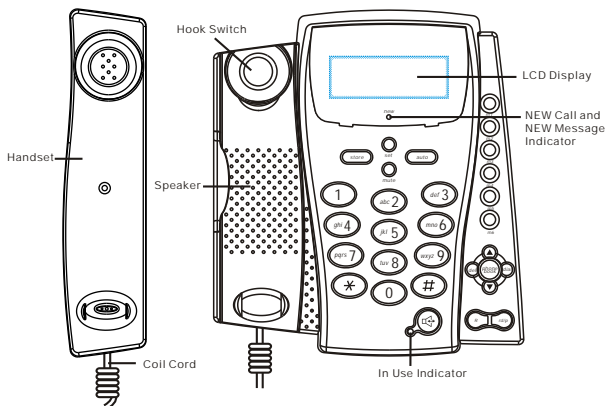

TROUBLESHOOTING

If you have problems with your phone, please check below for helpful hints:

- BLANK OR FAINT SCREEN**
- Check the line cord. Connect Telephone Cord. Check batteries, Check adaptor.
- CALLER ID WILL NOT WORK PROPERLY**
- You may have too many communication devices hooked to a single line. A communication device can be a phone, modem or facsimile (FAX) machine. Contact your telephone company for help in calculating the limit for your residence or business line.
- PHONE WILL NOT RING**
- Verify that the LINE CORD is plugged in correctly.
 - Verify that the Line Cord connection is correct and tightly secured.
- NO DIAL TONE**
- Call your telephone company to verify that your caller ID services are active.
 - If you have an answering machine connected to this Phone, ensure that your answering machine is set to answer after at least two rings.
 - You answer the call before two rings.
 - Contact your telephone company if the problem continues for more than 24 hours. The telephone company maybe experiencetemporary line.
- NO DATA SENT**
- If you have experienced a power failure when using optional AC adaptor, the batteries for memory back up could become weak or dead. If the power is restored and the display screen does not respond then you must replace the batteries with new.
- NO RESPONSE ON LCD DISPLAY**

Or

1. Select the caller that you want to call back by pressing ▲ or ▼ button in the on-hook state.
2. Pick up the handset or press  button, then the number will be dialled out automatically.

4. Save the Caller ID records

Your phone stores minimum 76 call records before the memory becomes full. When the next call comes in, the oldest record automatically drops off to make room for the new call records.

5. Delete single or all Caller ID or dialled number(s)

In the state of on-hook, find out the Caller ID or dialled number you want to remove, press del button, the LCD will show DEL? and then press del button again to remove this number, press other button to exit. If press and hold del button for about 6 seconds, the LCD will show ALL DEL?, press del button to confirm and exit.

TABLE OF CONTENTS

FEATURE LIST	1
SAFETY INSTRUCTIONS	2
INTRODUCTION	3
FUNCTION BUTTONS	4
FUNCTION OPERATIONS	6
OPERATION ABOUT THE STORED NUMBERS	13
RECEIVING CALL RECORDS	15
REVIEWING DISPLAY MESSAGES	15
MESSAGE WAITING	
NO CALLS	
TOTAL & NEW CALLS	
PRIVATE	
REPEAT CALLS	
END OF LIST	
OUT OF AREA	
BATTERY LOW INDICATOR	
CALLER ID ON CALL WAITING	17
CALLER ID SYSTEM OPERATIONS	18
TROUBLESHOOTING	20

FEATURE LIST

1. FSK + DTMF dual system caller ID
2. Stores minimum 76 incoming calls name & number, date & time
3. Stores up to 10 outgoing calls number
4. Stores up to 70 names & numbers in phone book
5. Caller ID with matching ringer melody and back light
6. LCD displays calling name & number
7. Call back function
8. Delete individual or all records
9. Real time clock(Set time)
10. New call indicator
11. Area & long distance code setting
12. Languages select
13. Message waiting function
14. Caller ID on call waiting
15. Last number redial
16. Speakerphone
17. 10 two-touch memories
18. 6 one-touch memories
19. R, Mute, Pause
20. Timer

CALLER ID SYSTEM OPERATIONS

Subscription to Caller ID service from your local phone company is required before the first use.

1. New call indicator

The red indicator light of your phone will flash to indicate that you have new calls and it will flash until all the new calls have been reviewed.

2. Review your call records

Press ▲ or ▼ button to browse through the caller list. If the call is more than 13 digits, the arrow will show on the bottom right of LCD, press ▲ or ▼ button once to review the other digits, press ▲ or ▼ button again to review next call. At the end of the call record list, you will see the END OF LIST message. Press ▲ or ▼ button to continue.

3. Using the call back feature

(NOTE: If the number is blocked or is not available, it can not be call backed.)

A. Call back the dialled number: The unit can store up to 10 dialled numbers.

1. In the state of on-hook, press dial button once, the last dialled number will show on the LCD, then use ▲ or ▼ button to select the number that you want to dial out.
2. Pick up the handset or press  button, the phone number can be dialled out automatically.

B. Call back the called number: The unit can store minimum 76 called numbers.

1. Lift the handset or press  button, listen for a dial tone.
2. Select the caller that you want to call back by pressing ▲ or ▼ button.
3. Press dial button to automatically dial the phone number shows on the LCD.

CALLER ID ON CALL WAITING

When you subscribe to Call Waiting service from your local telephone company, this telephone will display the name and number of the second caller while you are having a conversation.

Caller ID info displayed

436-1234
Caller 1

Caller two's information
is displayed

436-1234
291-5678
Caller 2

1. When you are having a conversation, this telephone will automatically display the name and number of the second caller.
2. Press the R button to answer the second caller.
3. When you have finished, press the R button to continue your conversation with the first caller.

SAFETY INSTRUCTIONS

To reduce the risk of fire, electrical shock, and injury, please follow these basic safety precautions before you use this equipment.

1. Carefully read the instructions in this manual.
2. Follow all warnings and instructions marked on the unit.
3. When cleaning, unplug the telephone jack from the wall outlet. Use a damp cloth. DO NOT use liquid or aerosol cleaners.
4. Do not use this equipment near water eg, near a kitchen sink, bath-Tub, washbowl, laundry tub, swimming pool or in a wet basement.
5. Install in a protected location. Ensure all lines and cords are away from foot traffic. DO NOT place objects on the line cord that may cause damage or abrasion.
6. Avoid spilling any liquid on the unit. This may cause internal shorting, fire or shock and is not covered under your warranty.
7. Do not overload wall outlets and extension cords as this can result in the risk of fire or electrical shock.
8. Never push objects of any kind into this telephone as they can touch dangerous voltage points or short out parts that could result in a risk of fire or electrical shock.
9. Take the phone to a qualified technician when it requires repair work or service. To reduce the risk of electrical shock, do not disassemble the telephone. Opening or removing covers can expose you to dangerous voltages or other risks. Incorrect re-assembly can cause electrical shock during subsequent use.
10. Avoid using the telephone during an electrical storm. There can be a slight risk of electrical shock from lightning.
11. DO NOT use the telephone to report a gas leak, if in the vicinity of the leak.
12. Unplug this telephone from the wall outlet and refer servicing to qualified service personnel under the following conditions:
 - If liquid is spilled into the unit.
 - If the unit is exposed to rain or water.
 - If the unit does not operate normally by following the operating Instructions.
 - If the unit is dropped or the casing is damaged.
 - If the unit exhibits a distinct change in performance.

FOLLOW THESE INSTRUCTIONS

INTRODUCTION

CHECK THE CONTENTS OF THE BOX

Box should contain:

- Handset with handset cord and phone base
- Telephone line cord
- 4 AA size 1.5V batteries
- User's manual
- Adapter

BATTERY INSTALLATION

The Caller ID phone requires four 1.5V AA size batteries for LCD display.

1. Remove the battery cover from the back of your Caller ID phone
2. Insert four 1.5V AA size batteries by observing the +/- polarity marked in the compartment.
3. Replace battery compartment cover.

Note: You can also insert adaptor for LCD display (optional).

CONNECTING LINE CORDS

Plug one end of the supplied modular cord into the line jack. Then plug the other end into telephone line jack.

TOTAL & NEW CALLS - This shows you the total and new calls to be reviewed. In this example, you have a total of 4 calls which include 2 new calls and it is MONDAY.

9:52 9/12 --02
TOTAL 04 MON

PRIVATE - If the caller has exercised the option to prevent his name and number from being sent, PRIVATE will be shown on the screen.

9:52 9/12 CALL 03
PRIVATE

REPEAT CALLS - If a call comes repeatedly, the display will show REPEAT icon in the upper right corner of the LCD.

9:52 9/12 CALL REPEAT 03
JOHNSMITH

END OF LIST - This message is displayed when reaching the top (end) of the call history list by using the ▲ or ▼ button. If there is no call, then LCD shows NO CALL.

9:52 9/12
END OF LIST

OUT OF AREA - This message will display when some one calls from an area where the telephone company is not offering the caller identification services or is not yet providing name and number delivery to your area via the long distance net work.

9:52 9/12 CALL 04
OUT OF AREA

BATTERY LOW INDICATOR: If there is low battery, the battery low icon will turn on and flash.

9:52 9/12 BATT 02
TOTAL 10 MON

RECEIVING CALL RECORDS

A caller ID record consists of the following information:

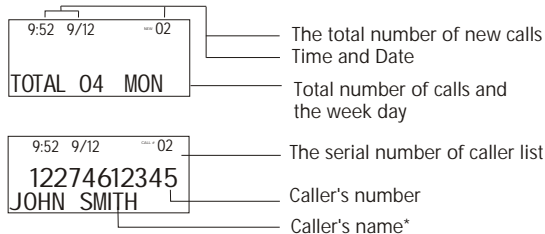

* This function should be supported by your local telephone company.

REVIEWING DISPLAY MESSAGES

MESSAGE WAITING - If you have voice mail service from your telephone company and a recorded message is left, the screen will display "MESSAGE WAITING". "MSG" will then appear in the upper left corner. The icon will remain until you have reviewed your voice mail and the MESSAGE WAITING will be saved as a call.

NOTE: This function should be supported by your local telephone company.

NO CALLS - When all calls have been deleted. The display will show NO CALL.

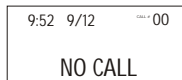
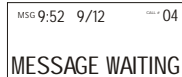

FUNCTION BUTTONS

- **Ringer Volume Switch** - Set the ringer volume switch to the desired level(HI/LO).To have the maximum ringer volume, move the switch to the position. If you would prefer a gentle ringer volume, move the switch to the position.
- **Speaker Volume Switch** - Set the speaker volume switch to the desired level(HI/LO).To have the maximum speaker volume, move the switch to position. If you would prefer a gentle speaker volume, move the switch to the position.
- **Redial function** - Lift the handset or press the button, then press the rd/p button to redial the last dialled number.
- **Speaker function** - To switch your call to speaker phone, press the button and hang up the handset. To switch back, simply pick up the handset and speak as normal. In the speaker state, you can dial the number and receive the call, also you can answer the call.
- **R button** - Press the R button to terminate a call and institute a dialling tone for another call or to get another call from "call waiting" (a special telephone service).
NOTE: If you do not have any special telephone service, such as call waiting, pressing the R button during a call may disconnect your current conversation.
- **Pause function** - Allows you to insert a temporary pause during dialling sequence. For example, dialling an international number (eg: 011-886-22-795-1234), some telephone company systems will not register the entire number entry without a pause between the prefix numbers. You may have to dial 011- rd/p, dial 886 - rd/p. This allows adequate timing for the phone number to register with the telephone company's system and complete the call.

- Dial button - Refer to "CALLER ID SYSTEM OPERATIONS", section "Using the call back feature".

- Del button - When the number you want to remove displayed on the LCD, press the del button, the LCD will show DEL? Press del button again to remove this number.

When you Caller ID phone is in use mode, you can press the del button once to stop the timer, press it once more to restart it. And the timer can start after dialling out the call about 10 seconds and stop when hang up.

- Phone book button - Press the phone book button to enter the phone book directly. Refer to "FUNCTION OPERATIONS", section "PHONE BOOK".

- Mute function - If you wish to speak privately to someone else in the room without your caller overhearing, press the mute button once then the LCD will display MUTE. To resume normal conversation, just press the mute button again.

- Set button - Press and hold the set button to enter the time setting, if you wish, after time setting, press the set button once again to enter the LCD contrast setting. For the setting details, please refer to "FUNCTION OPERATIONS", section "TIME SETTING" and "LCD CONTRAST SETTING".

- Store and Auto button - They are used to store number and dial the recorded number. Refer to "OPERATION ABOUT THE STORED NUMBERS".

b. To dial a number from the memory
Lift the handset or press the  button then press the location button(m1~m6).The matching number will be dialled out.

c. To review the number in one-touch memory
In the state of on-hook, press the location button(m1~m6), then the matching number will show on the LCD.

OPERATION ABOUT THE STORED NUMBERS

● Two -touch memory

a. To store number

You can store number to the two-touch memory in either on-hook or off-hook state. Press the store button and the LCD shows -->. Then enter the telephone number you want to store. Press the store button once again and the LCD shows -->?. Enter desired location number (0-9) and the LCD shows SAVE OK .

b. To dial a number from the memory

Lift the handset or press the  button. Press the auto button followed by a corresponding location number button(0-9), the matching stored number will be dialled out.

c. To review the number in two-touch memory

In the state of on-hook, press and hold the location number(0-9) or press the auto button + the location button, the matching stored number will show on the LCD.

● One -touch memory

a. To store number (You can store number to the one-touch memory in the following 3 ways):

1. In the on-hook or off-hook state, press the store button and the LCD shows -->. Then enter the telephone number you want to store. Press the store button once again and the LCD shows -->?. Press the desired location button (m1~m6) and the LCD shows SAVE OK .

2. First enter the number you want to store then press and hold the (m1~m6) button until the LCD shows SAVE OK.

3. You can copy the CID or Last 10 dialled or phone book number to m1~m6.

When the number shows on the LCD, press and hold the location button(m1~m6) until the LCD shows SAVE OK, now the number has been stored at the right location in the one-touch memory.

FUNCTION OPERATIONS

This unit contains the following special function, press del button twice to enter the setting mode and press ▲ or ▼ button to select one. The setting sequence is *PHONE BOOK - SET RING - BACK LIGHT - LCD CONTRAST - SET TIME- SET LANGUAGE- SET AREA& LDS - SET FLASH- HOUR FORMAT- DATE FORMAT* Press the dial button to confirm and press del to exit.

1. PHONE BOOK

a. To add number and name to the phone books

Key	Characters	Key	Characters
1	1 . , ? ! - " ' ()	6	M N O m n o 6 Ö Ø Ñ
2	A B C a b c 2 Ä Å Æ	7	P Q R S p q r s 7
3	D E F d e f 3	8	T U V t u v 8 Ü
4	G H I g h i 4	9	W X Y Z w x y z 9
5	J K L j k l 5	0	0 + & @ / \$ %

- Press dial button to select the phonebook menu and the LCD will show: REVIEW. Press ▲ or ▼ to select the ADD menu. Press dial button to enter the function of adding name and number. (You can enter it directly by pressing and holding the phone book button.)
- Enter the telephone number by keypad. Press del button for deleting the previous digit. The maximum number of digits to be entered is 20, if the number exceeds 20, the LCD will show TOO LONG and the exceeding digits will not be stored.
- After finishing the number setting, press and hold dial button (or press phone book button once) to enter the name setting, press the appropriate keypad to get the following characters, If the next character is on the same button as the previous one, you will first need to press dial button before the entering, press del button to delete the previous digit.

4. When the setting is completed, press and hold dial button (or press phone book button once) to store the records and meanwhile enter the next number presetting.

b. To review the number and name in phone book

1. Press dial button to select the phonebook menu and the LCD will show: REVIEW. Press dial button to enter the function of reviewing the names and numbers. (or press phone book button once to enter, the last record in the phone book will show on the LCD.)

Use ▲ or ▼ button to review. You can also quickly review the call by the first letter of name, when press the first letter of name, the LCD will display the matching name(s), then use ▲ or ▼ button to get the right one.

2. In the state of on-hook, press sequence of the number+# to review.

Eg: If you want to review the seventh number, just press 7#, the LCD will show the seventh number and name. In this state, you can continue to review the other numbers by pressing ▲ or ▼ button.

NOTE: If the number is more than 13 digits, a arrow will show on the bottom right of LCD, press ▲ or ▼ button to review the other digits, press ▲ or ▼ button again to review the next call.

c. To speed dial the number from the phone book

During the reviewing process, use ▲ or ▼ button to select the number you want, when it shows on the LCD, pick up the handset or press  button to dial it out.

d. To modify phone book name:

During the reviewing process, use ▲ or ▼ button to select the number you want, When it shows on the LCD, press and hold phone book button for 3 seconds more, then the first character of the name will flash to indicate you enter the function of name modification. You can modify it with the method the same as point a.3.

10. DATE FORMAT SELECTION

Press the dial button to enter this setting when the LCD shows DATE FORMAT and then the current value will be displayed.

Use the ▲ or ▼ button to select the date format (DD-MM or MM-DD). Press the dial button to confirm and exit.

In the DD-MM mode, the time display sequence is day-month and in the MM-DD mode, the sequence is month-day.

7. AREA & LONG DISTANCE CODE SETTING

(Only under "English1", "English2", "Greek", "Austral", "Czech", "Slovak" and "Turkish" language and in on-hook state, the setting can be done.)

When you use this phone for the first time, or move to an area that has different area code, you must enter your area code. This is necessary because the phone must distinguish local or long distance calls to properly dial calls from the Caller ID list.

1. Press dial button when the LCD show SET AREA & LDS to enter the setting.
2. Press ▲ or ▼ button to select the correct digit.
3. Press dial button to confirm and enter the next digit setting.
4. When the area code setting has been completed, press dial button to confirm and the LCD displays SET LDS CODE. The unit enters the long distance code setting.
5. Repeat the step 2-3 to finish the setting for LDS code and press del button to exit.

8. FLASHING TIME SETTING

Press the dial button to enter this setting when the LCD show "SET FLASH" and then the current value will be displayed.

Use the ▲ or ▼ button to select the flash time (100ms/120ms/300ms/600ms). Press the dial button to confirm and exit.

9. HOUR FORMAT SELECTION

Press the dial button to enter this setting when the LCD shows HOUR FORMAT and then the current value will be displayed.

Use the ▲ or ▼ button to select the hour format (12H/24H). Press the dial button to confirm and exit.

e. To select the matching melody and back light:

*To distinguish the incoming calls easily, you can set a special melody and back light for the number, so that when it comes, the matching melody will ring and the back light will flash.

During the reviewing process, use ▲ or ▼ button to select the number you want. When it shows on the LCD, press and hold the dial button for 3 seconds more, then the current *melody type* will show on, press ▲ or ▼ button to select (11 kinds are provided), press the dial button to confirm and the LCD will show the current *back light* value (7 kinds are provided), press ▲ or ▼ button to select and press the dial button to confirm.

After the setting, the VIP will show on the LCD, you can cancel this function by pressing and holding the dial button for 3 seconds.

f. To delete a single number in the phone book:

During the reviewing process, use ▲ or ▼ button to select the number you want to delete, press del button once, the LCD shows DEL? Press del button again to delete it.

g. To Copy the Caller ID numbers and last 10 dialled numbers to phonebook

When the LCD shows the CID or last 10 dialled number, press and hold phone book button about 3 seconds to add the number to phonebook. The first character of the name will flash to indicate you can modify it, you can do it then press the phone book button to confirm and enter the next new number adding, press the del button to exit.

2. SET THE RING

Press dial button when the LCD show SET RING to enter the setting, use ▲ or ▼ button to select the sub-menu.

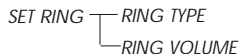

1. Select the RING TYPE and press dial button to confirm.
2. Use ▲ or ▼ button to select the desired ringer melody(up to 11 kinds) or standard ring.
3. Press dial button to confirm.

or

1. Select the RING VOLUME and press dial button to confirm
2. Use ▲ or ▼ button to select the desired ringer volume(up to 4 kinds), if you would not like the ringer to disturb you, you can select the RING OFF to deactivate the function.
3. Press dial button to confirm.

3. SET THE BACK LIGHT

This telephone has special back light function in on-hook and off-hook state. Whenever you press any button or pick up the handset, the back light will be bright. Press dial button when the LCD shows BACK LIGHT to enter the setting, use ▲ or ▼ button to select the sub-menu.

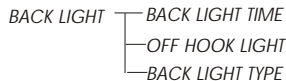

a. Set the back light time

1. Select the BACK LIGHT TIME and press dial button to confirm.
Use ▲ or ▼ button to select the desired bright time (10s/20s/30s),
2. You can also select the OFF to deactivate the function.
3. Press dial button to confirm.

If you want the light to keep bright in the off-hook state, you can enter the OFF HOOK LIGHT setting a  select the ALL THE TIME.

or

1. Select the BACK LIGHT TYPE and press dial button to confirm.
2. Use ▲ or ▼ button to select the desired back light type(up to 7 kinds.)
3. Press dial button to confirm.

4. LCD CONTRAST SETTING

Press dial button to enter the LCD contrast setting when the LCD shows LCD CONTRAST, then the current contrast level (HI/LO) will show on the LCD. Press ▲ or ▼ button to make a selection, press dial button to confirm and exit.

5. TIME SETTING

Press dial button when the LCD shows SET TIME , use▲ or ▼ button to select the correct number. Press dial button to confirm and move to the next digit, press del button to exit.

NOTE:

1. When you receive a first call to this unit, time and date will be set automatically if you have Caller ID service (FSK standard).
2. The setting sequence is *hour - minute - month - day - year - week*. After the *year* setting, the cursor for *week* will flash, you can use ▲ or ▼ button to activate/deactivate this setting. If it is activated, the *week* will set automatically, or in stead of showing the week day, the LCD will only show the "TOTAL CALLS XX" in the standby state.
3. You need to select the *year* to ensure the week displays correctly.

6. LANGUAGE SETTING

The unit support multi languages, including *English1, Greek, Australian, Czech, Slovak, Turkish, English2, Spanish, Nederland, French, German, Polish, Swedish, Danish, Finnish and Norwegian.*

Press dial button when the LCD shows SET LANGUAGE to enter the language setting. Use ▲ or ▼ button to select the language. Press dial button to confirm and exit.

Free Manuals Download Website

<http://myh66.com>

<http://usermanuals.us>

<http://www.somanuals.com>

<http://www.4manuals.cc>

<http://www.manual-lib.com>

<http://www.404manual.com>

<http://www.luxmanual.com>

<http://aubethermostatmanual.com>

Golf course search by state

<http://golfingnear.com>

Email search by domain

<http://emailbydomain.com>

Auto manuals search

<http://auto.somanuals.com>

TV manuals search

<http://tv.somanuals.com>