



# *CD-S300*



---

*Compact Disc Player*  
*Lecteur Compact Disc*



OWNER'S MANUAL  
MODE D'EMPLOI

# IMPORTANT SAFETY INSTRUCTIONS

|   |   |   |
|---|---|---|
|  | <b>CAUTION</b><br><b>RISK OF ELECTRIC SHOCK</b><br><b>DO NOT OPEN</b> |  |
|---|---|---|

**CAUTION: TO REDUCE THE RISK OF ELECTRIC SHOCK, DO NOT REMOVE COVER (OR BACK). NO USER-SERVICEABLE PARTS INSIDE. REFER SERVICING TO QUALIFIED SERVICE PERSONNEL.**

## • Explanation of Graphical Symbols

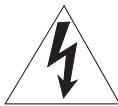

The lightning flash with arrowhead symbol, within an equilateral triangle, is intended to alert you to the presence of uninsulated "dangerous voltage" within the product's enclosure that may be of sufficient magnitude to constitute a risk of electric shock to persons.



The exclamation point within an equilateral triangle is intended to alert you to the presence of important operating and maintenance (servicing) instructions in the literature accompanying the appliance.

## IMPORTANT

Please record the serial number of this unit in the space below.

MODEL:

Serial No.:

The serial number is located on the rear of the unit.

Retain this Owner's Manual in a safe place for future reference.

## FOR CANADIAN CUSTOMERS

To prevent electric shock, match wide blade of plug to wide slot and fully insert.

This Class B digital apparatus complies with Canadian ICES-003.

- 1 Read these instructions.
- 2 Keep these instructions.
- 3 Heed all warnings.
- 4 Follow all instructions.
- 5 Do not use this apparatus near water.
- 6 Clean only with dry cloth.
- 7 Do not block any ventilation openings. Install in accordance with the manufacturer's instructions.
- 8 Do not install near any heat sources such as radiators, heat registers, stoves, or other apparatus (including amplifiers) that produce heat.
- 9 Do not defeat the safety purpose of the polarized or grounding-type plug. A polarized plug has two blades with one wider than the other. A grounding type plug has two blades and a third grounding prong. The wide blade or the third prong are provided for your safety. If the provided plug does not fit into your outlet, consult an electrician for replacement of the obsolete outlet.
- 10 Protect the power cord from being walked on or pinched particularly at plugs, convenience receptacles, and the point where they exit from the apparatus.
- 11 Only use attachments/accessories specified by the manufacturer.
- 12 Use only with the cart, stand, tripod, bracket, or table specified by the manufacturer, or sold with the apparatus. When a cart is used, use caution when moving the cart/apparatus combination to avoid injury from tip-over.
- 13 Unplug this apparatus during lightning storms or when unused for long periods of time.
- 14 Refer all servicing to qualified service personnel. Servicing is required when the apparatus has been damaged in any way, such as power-supply cord or plug is damaged, liquid has been spilled or objects have fallen into the apparatus, the apparatus has been exposed to rain or moisture, does not operate normally, or has been dropped.



## We Want You Listening For A Lifetime

Yamaha and the Electronic Industries Association's Consumer Electronics Group want you to get the most out of your equipment by playing it at a safe level. One that lets the sound come through loud and clear without annoying blaring or distortion – and, most importantly, without affecting your sensitive hearing. Since hearing damage from loud sounds is often undetectable until it is too late, Yamaha and the Electronic Industries Association's Consumer Electronics Group recommend you to avoid prolonged exposure from excessive volume levels.



## FCC INFORMATION (for US customers)

**1 IMPORTANT NOTICE: DO NOT MODIFY THIS UNIT!**

This product, when installed as indicated in the instructions contained in this manual, meets FCC requirements. Modifications not expressly approved by Yamaha may void your authority, granted by the FCC, to use the product.

**2 IMPORTANT:** When connecting this product to accessories and/or another product use only high quality shielded cables. Cable/s supplied with this product MUST be used. Follow all installation instructions. Failure to follow instructions could void your FCC authorization to use this product in the USA.

**3 NOTE:** This product has been tested and found to comply with the requirements listed in FCC Regulations, Part 15 for Class "B" digital devices. Compliance with these requirements provides a reasonable level of assurance that your use of this product in a residential environment will not result in harmful interference with other electronic devices.

This equipment generates/uses radio frequencies and, if not installed and used according to the instructions found in the users manual, may cause interference harmful to the operation of other electronic devices.

Compliance with FCC regulations does not guarantee that interference will not occur in all installations. If this product is found to be the source of interference, which can be determined by turning the unit "OFF" and "ON", please try to eliminate the problem by using one of the following measures:

Relocate either this product or the device that is being affected by the interference.

Utilize power outlets that are on different branch (circuit breaker or fuse) circuits or install AC line filter/s.

In the case of radio or TV interference, relocate/reorient the antenna. If the antenna lead-in is 300 ohm ribbon lead, change the lead-in to coaxial type cable.

If these corrective measures do not produce satisfactory results, please contact the local retailer authorized to distribute this type of product. If you can not locate the appropriate retailer, please contact Yamaha Electronics Corp., U.S.A. 6660 Orangethorpe Ave., Buena Park, CA 90620.

The above statements apply ONLY to those products distributed by Yamaha Corporation of America or its subsidiaries.

**CAUTION**

Use of controls or adjustments or performance of procedures other than those specified herein may result in hazardous radiation exposure.

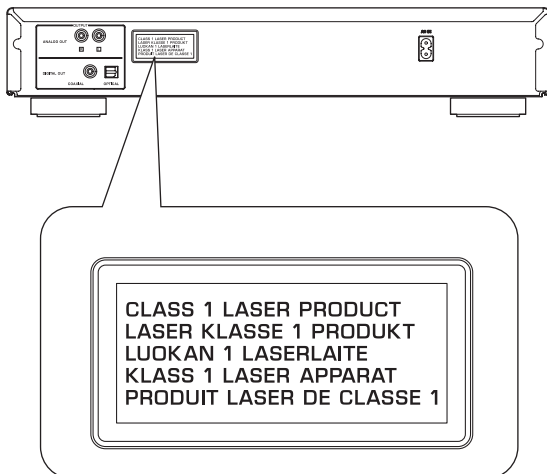

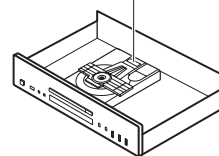

**DANGER:** AVOID DIRECT EXPOSURE TO THE BEAM  
 INVISIBLE LASER RADIATION WHEN OPEN

**CAUTION:** DO NOT STARE INTO BEAM  
 INVISIBLE LASER RADIATION WHEN OPEN



# CAUTION: READ THIS BEFORE OPERATING YOUR UNIT.

- 1 To assure the finest performance, please read this manual carefully. Keep it in a safe place for future reference.
- 2 Install this sound system in a well ventilated, cool, dry, clean place – away from direct sunlight, heat sources, vibration, dust, moisture, and/or cold. For proper ventilation, allow the following minimum clearances.  
Top : 2.5 cm (1 inch)  
Rear: 2.5 cm (1 inch)  
Sides: 2.5 cm (1 inch)
- 3 Locate this unit away from other electrical appliances, motors, or transformers to avoid humming sounds.
- 4 Do not expose this unit to sudden temperature changes from cold to hot, and do not locate this unit in an environment with high humidity (i.e. a room with a humidifier) to prevent condensation inside this unit, which may cause an electrical shock, fire, damage to this unit, and/or personal injury.
- 5 Avoid installing this unit where foreign objects may fall onto this unit and/or this unit may be exposed to liquid dripping or splashing. On the top of this unit, do not place:
  - Other components, as they may cause damage and/or discoloration on the surface of this unit.
  - Burning objects (i.e. candles), as they may cause fire, damage to this unit, and/or personal injury.
  - Containers with liquid in them, as they may fall and liquid may cause electrical shock to the user and/or damage to this unit.
- 6 Do not cover this unit with a newspaper, tablecloth, curtain, etc. in order not to obstruct heat radiation. If the temperature inside this unit rises, it may cause fire, damage to this unit, and/or personal injury.
- 7 Do not plug in this unit to a wall outlet until all connections are complete.
- 8 Do not operate this unit upside-down. It may overheat, possibly causing damage.
- 9 Do not use force on switches, knobs and/or cords.
- 10 When disconnecting the power cable from the wall outlet, grasp the plug; do not pull the cable.
- 11 Do not clean this unit with chemical solvents; this might damage the finish. Use a clean, dry cloth.
- 12 Only voltage specified on this unit must be used. Using this unit with a higher voltage than specified is dangerous and may cause fire, damage to this unit, and/or personal injury. Yamaha will not be held responsible for any damage resulting from use of this unit with a voltage other than specified.
- 13 To prevent damage by lightning, keep the power cord disconnected from a wall outlet or the unit during a lightning storm.
- 14 Do not attempt to modify or fix this unit. Contact qualified Yamaha service personnel when any service is needed. The cabinet should never be opened for any reasons.
- 15 When not planning to use this unit for long periods of time (i.e. vacation), disconnect the power cable from the wall outlet.
- 16 Install this unit near the wall outlet and where the power cable can be reached easily.
- 17 Be sure to read the “TROUBLESHOOTING” section in this manual on common operating errors before concluding that this unit is faulty.
- 18 Before moving this unit, press  to turn off this unit and then disconnect the power cable from the wall outlet.
- 19 The batteries shall not be exposed to excessive heat such as sunshine, fire or like.
- 20 **VOLTAGE SELECTOR** (Asia and General models only)  
The **VOLTAGE SELECTOR** on the rear panel of this unit must be set for your local main voltage **BEFORE** plugging into the wall outlet. Voltages are:  
.....AC 110/120/220/230-240 V, 50/60 Hz

As long as this unit is connected to the wall outlet, it is not disconnected from the AC power source even if you turn off this unit by .

## WARNING

TO REDUCE THE RISK OF FIRE OR ELECTRIC SHOCK, DO NOT EXPOSE THIS UNIT TO RAIN OR MOISTURE.

## LASER SAFETY

This unit employs a laser. Due to possible eye injury, only a qualified service person should remove the cover or attempt to service this device.

## DANGER

This unit emits visible laser radiation when open. Avoid direct eye exposure to beam. When this unit is plugged into the wall outlet, do not place your eyes close to the opening of the disc tray and other openings to look into inside.

The laser component in this product is capable of emitting radiation exceeding the limit for Class 1.

# CONTENTS

## INTRODUCTION

|  |          |
|--|----------|
| <b>CONTROLS AND FUNCTIONS .....</b>    | <b>2</b> |
| Front panel.....                       | 2        |
| Rear panel connections.....            | 3        |
| Remote control.....                    | 4        |
| Program playback <b>Audio CD</b> ..... | 5        |

## OPERATION

|  |          |
|--|----------|
| <b>PLAYING BACK iPod/USB DEVICE.....</b> | <b>6</b> |
| Connecting iPod/USB devices.....         | 6        |
| Playing back iPod.....                   | 6        |
| Playing back USB devices.....            | 6        |
| Disconnecting iPod/USB devices.....      | 7        |
| Supported iPod/USB devices.....          | 7        |

### ■ Features

- Optical Digital Output
- Coaxial Digital Output
- CD-R, CD-RW Disc Playability  
(For details, refer to page 8.)
- MP3, WMA Disc Playability
- MP3, WMA File Playability Stored on USB Device  
(For details, refer to page 8.)
- iPod Playability
- Program Play (Audio CD only)
- Random-Sequence Play
- Single Track/File, Entire Disc/Folder/Whole device Repeat Play
- Repeat A-B Play (Audio CD only)
- Adjustable Display Information and Brightness
- PURE DIRECT Function

### ■ Supplied accessories

Please check that you have received all of the following parts.

- Power cable
- Remote control
- Batteries (AA, R6, UM-3) (×2)
- RCA stereo cable

### ■ Notes on batteries

- Change all of the batteries if you notice that the operation range of the remote control decreases.
- Use AA, R6, UM-3 batteries.
- Make sure that the polarities are correct. See the illustration inside the battery compartment.
- Remove the batteries if the remote control is not used for an extended period of time.
- Do not use old batteries together with new ones.
- Do not use different types of batteries (such as alkaline and manganese batteries) together. Read the packaging carefully as these different types of batteries may have the same shape and color.

## ADDITIONAL INFORMATION

|   |           |
|---|-----------|
| <b>PLAYABLE DISC AND FILE FORMAT.....</b> | <b>8</b>  |
| <b>USING THE ADVANCED SETUP.....</b>      | <b>9</b>  |
| <b>TROUBLESHOOTING .....</b>              | <b>10</b> |
| <b>SPECIFICATIONS.....</b>                | <b>11</b> |

- If the batteries have leaked, dispose of them immediately. Avoid touching the leaked material or letting it come into contact with clothing, etc. Clean the battery compartment thoroughly before installing new batteries.
- Do not throw away batteries with general house waste; dispose of them correctly in accordance with your local regulations.

### ■ Handling the remote control

- The area between the remote control and this unit must be clear of large obstacles.
- Do not spill water or other liquids on the remote control.
- Do not drop the remote control.
- Do not leave or store the remote control in the following types of conditions:
  - places of high humidity, such as near a bath
  - places of high temperature, such as near a heater or a stove
  - places of extremely low temperatures
  - dusty places
- Do not expose the remote control sensor to strong lighting, in particular, an inverter type fluorescent lamp; otherwise, the remote control may not work properly. If necessary, position this unit away from direct lighting.

### ■ About this manual

-  indicates a tip for your operation.
- In this manual, audio CDs are referred to as “Audio CD”, MP3/WMA discs as “Data Disc”, and MP3/WMA files stored on the USB device as “USB”.
- The **Audio CD**, **Data Disc** and **USB** icons indicate music data formats that can be used in the operation.
- This manual is printed prior to production. Design and specifications are subject to change in part as a result of improvements, etc. In case of differences between the manual and the product, the product has priority.

# CONTROLS AND FUNCTIONS

## Front panel

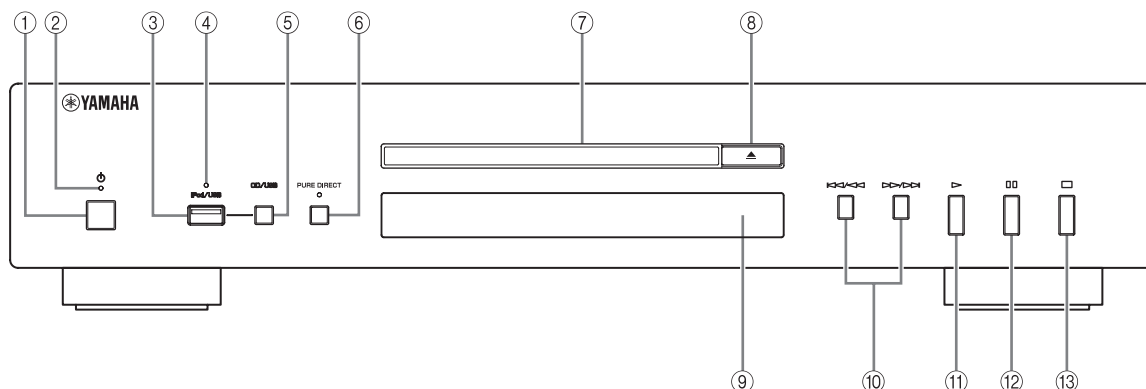

### ① (Power)

Press to turn the power on/off.



- The power indicator above lights up when this unit is turned on.
- Playback starts automatically if the power is turned on while a disc is set in the disc tray.

### ② **Power indicator**

Lights up as follows:

ON: Bright

OFF: Off

### ③ **iPod/USB port**

Connect your iPod or USB device. See page 6 for details.

### ④ **iPod/USB indicator**

Off: CD mode is selected.

Orange: Connection ready.

Green: iPod/USB is connected and playable files have been detected (playback ready).

### ⑤ **CD/USB**

Switches between CD mode and iPod/USB mode (see page 6).



When the iPod/USB indicator is not lit, this unit is in the CD mode.

### ⑥ **PURE DIRECT**

Turns on or off the PURE DIRECT mode to improve audio quality.



- The PURE DIRECT indicator lights up.
- The digital output is turned off.
- The front panel display is turned off during playback and only the minimum required indicators and messages are displayed during in the operation.

### **Note**

Connect using the ANALOG OUT terminals when you use PURE DIRECT mode (refer to page 3).

### ⑦ **Disc tray**

Loads a disc.



### ⑧ (Open/Close)



Opens or closes the disc tray.



### ⑨ **Remote control sensor**





Receives signals from the remote control.

### ⑩ / (**Skip/Search backward**), / (**Skip/Search forward**)

 / : Skips to the next track.

 / : Skips back to the beginning of the current track.



 /  (twice): Skips to the previous track.

Press and hold  /  or  /  to search backward/forward.

### ⑪ (**Play**)

Starts playback.

### ⑫ (**Pause**)

Pauses playback. Press  or  to resume playback.

### ⑬ (**Stop**)

Stops playback.

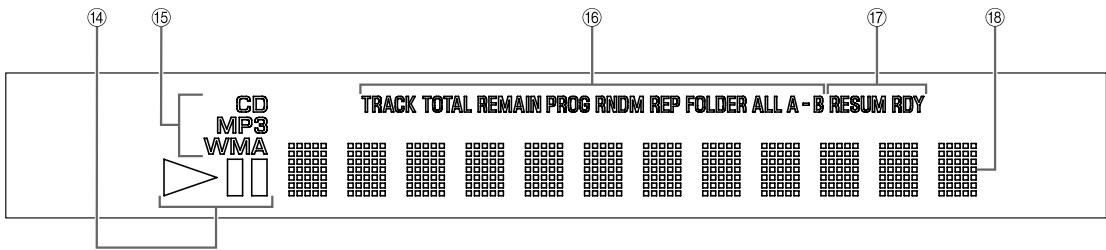

**14 Playback Status Indicator**

Lights when this unit is in the play or pause mode.

**15 Source type indicator**

Indicates the type of content being played back.

**16 Time and playback mode indicator**

Indicates the current playback mode and the status of the time display (see pages 5 and 5 for playback modes, and page 5 for time display).

**17 Advanced setup indicator**

Indicates the enabled special modes. See “USING THE ADVANCED SETUP” (page 9) for details.

**18 Multi-information display**

**Rear panel connections**

**CAUTION**

Before making any connection, switch OFF the power to the unit, the amplifier and any other component.

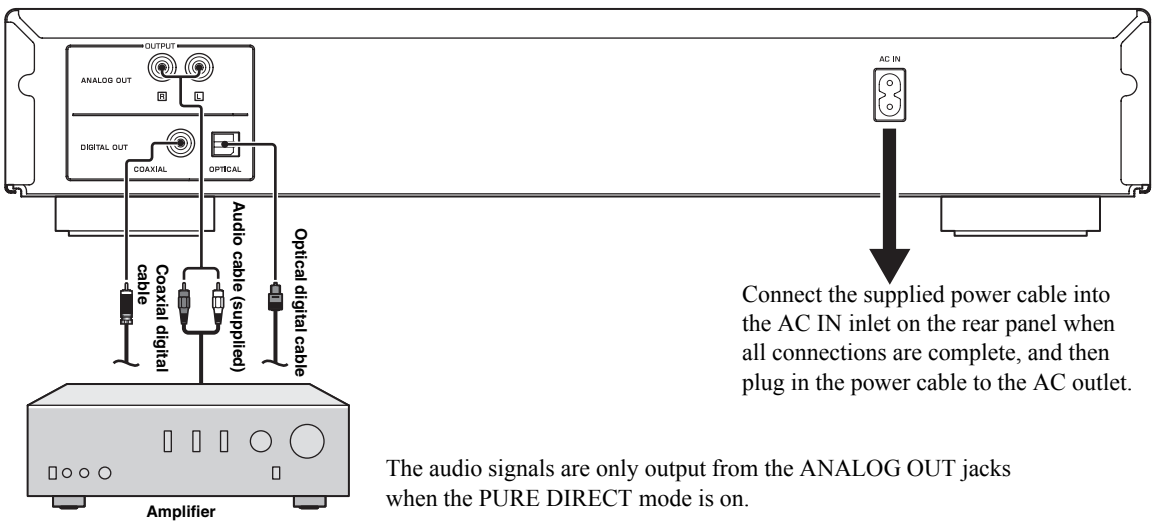

**VOLTAGE SELECTOR (Asia and General models only)**

Voltages are as follows:  
 .....AC 110/120/220/230-240 V, 50/60 Hz

**CAUTION**

The VOLTAGE SELECTOR on the rear panel of this unit must be set for your local voltage BEFORE plugging the power cable into the AC wall outlet. Improper setting of the VOLTAGE SELECTOR may cause damage to this unit and create a potential fire hazard. Rotate the VOLTAGE SELECTOR clockwise or counterclockwise to the correct position using a straight slot screwdriver.

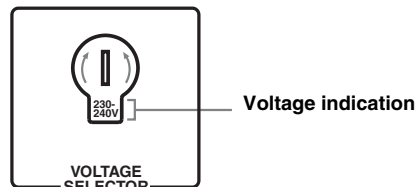

## Remote control

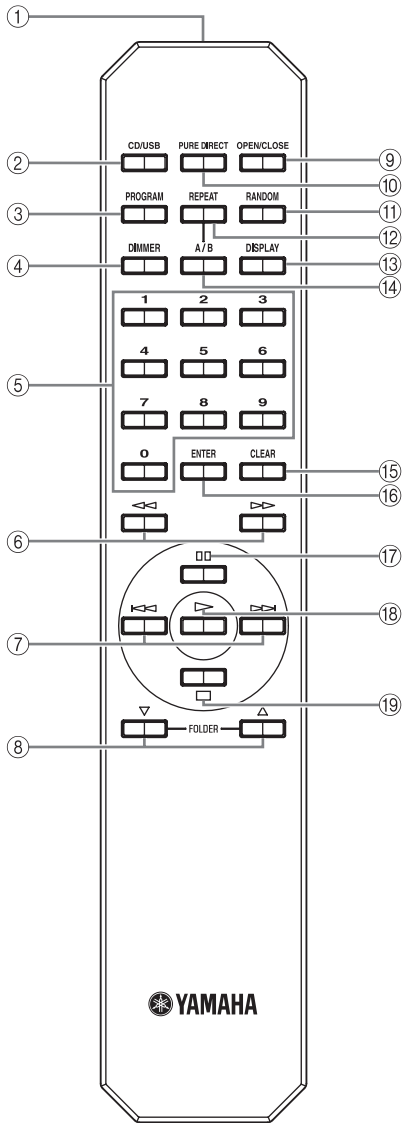

### ■ Installing batteries in the remote control

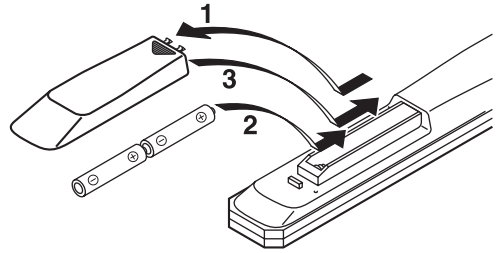

**1** Press the ▼ part and slide the battery compartment cover off.

**2** Insert the two supplied batteries (AA, R6, UM-3) according to the polarity markings (+ and -) on the inside of the battery compartment.

**3** Slide the cover back until it snaps into place.

### ■ Using the remote control

The remote control transmits a directional infrared beam. Be sure to aim the remote control directly at the remote control sensor on the front panel of this unit during operation.

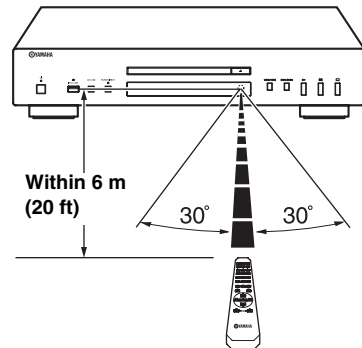

#### ① Infrared signal transmitter

Sends infrared signals to this unit.

#### ② CD/USB

Switches between CD mode and iPod/USB mode (see page 6).



This setting is retained even if you turn off this unit.

#### ③ PROGRAM

Turns on or off the program playback mode. See “Program playback” on the next page.

#### ④ DIMMER

Each time you press DIMMER, the brightness level changes by 4 levels.



This setting is retained even if you turn off this unit.

#### ⑤ Numeric buttons

Use to select directly a track on the disc or a file in the current folder.

#### ⑥ ◀◀ (Search backward), ▶▶ (Search forward)

Searches tracks backward/forward while the key is pressed.

#### ⑦ ◀◀ (Skip backward), ▶▶ (Skip forward)

▶▶: Skips to the next track.

◀◀: Skips back to the beginning of the current track.

◀◀ (twice): Skips to the previous track.



⑧ **FOLDER** ▾ (Folder down), △ (Folder up)

**Data Disc** **USB**

▾: Skips to the previous folder.  
 △: Skips to the next folder.  
 Refer to page 6 for details.

⑨ **OPEN/CLOSE**

Opens or closes the disc tray.

⑩ **PURE DIRECT**

Turns on or off the PURE DIRECT mode to improve audio quality. See page 2 for details.



This setting is retained even if you turn off this unit.

⑪ **RANDOM**

Turns on or off the random sequence playback mode.

**Note**

The random playback mode is canceled when the disc is ejected.

⑫ **REPEAT**

Repeats playback of a single track or all tracks. Each time you press REPEAT during playback, the repeat playback mode changes as follows:

- REP TRACK (single repeat playback): A single track is played back repeatedly.
- REP ALL (all repeat playback): All tracks (the entire disc) are played back repeatedly.

**Data Disc** **USB**

- REP FOLDER (folder repeat playback): All files (the entire folder) are played back repeatedly.



Repeat play also works with program play and random-sequence play.

⑬ **DISPLAY**

Switches the time display. Each time you press DISPLAY during playback, the time display changes as follows:

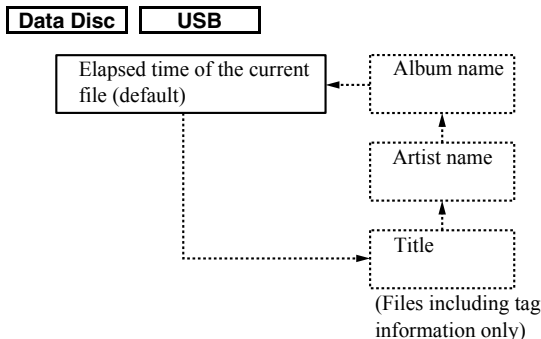
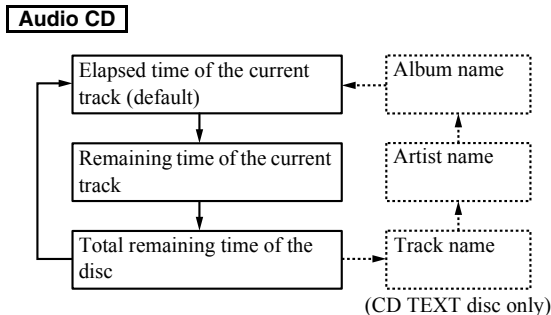

⑭ **A/B** **Audio CD**

Repeats playback of a specified section of a track. To set the starting and end points (A and B), press A/B twice during playback.  
 To cancel repeat A-B, press A/B again.

**Notes**

- You cannot set repeat A-B from one track to another track.
- You cannot set repeat A-B for Data Disc and USB.
- If you stop playback by pressing □ (Stop), repeat A-B is canceled.
- You cannot use repeat A-B when this unit is in the PURE DIRECT mode.

⑮ **CLEAR**

Erases the programmed track.

⑯ **ENTER**

Confirms a track number entered when you are programming tracks.

⑰ **⏸ (Pause)**

Pauses playback. Press ▷ or ⏸ to resume playback.

⑱ **▶ (Play)**

Starts playback.

See pages 8 for more information on MP3/WMA playback.

⑲ **□ (Stop)**

Stops playback.

**Program playback** **Audio CD**

In the program playback mode, you can play back tracks in a programmed sequence.

**1 Press PROGRAM while playback is stopped.**  
 This unit is set to the program editing mode.

**2 Select a track by using the numeric buttons and ENTER.**

**3 Repeat step 2 to program the next track.**  
 You can program up to 24 tracks.



To cancel the programmed track, press CLEAR.

**4 Press ▷.**  
 Playback starts from the beginning of the programmed sequence.



To erase all programmed tracks, press CLEAR when the playback is stopped.

**Note**

The programmed tracks are erased when the disc is ejected or this unit is turned off.

# PLAYING BACK iPod/USB DEVICE

## Connecting iPod/USB devices

### Notes iPod

- Use the USB cable supplied with your iPod. If no USB cable is supplied, purchase one from Apple Inc.
- Turn off your iPod.
- Do not use a USB hub.

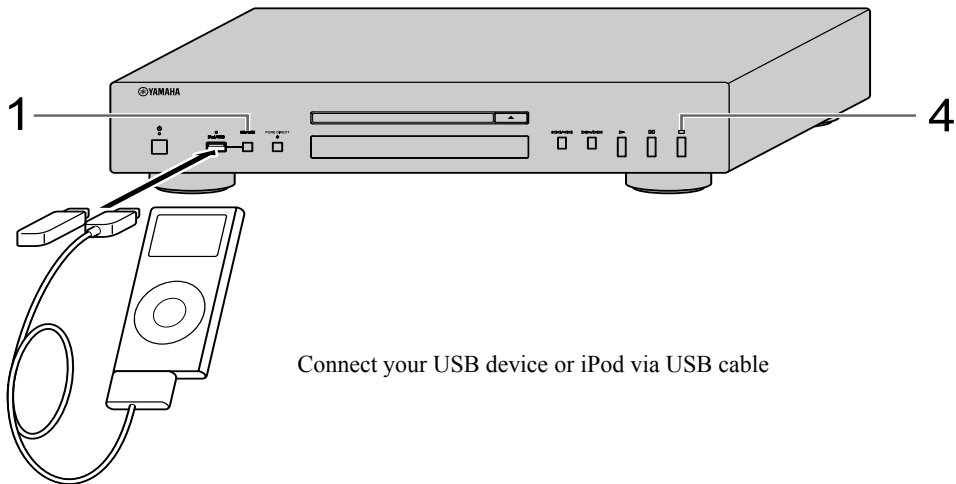

## Playing back iPod

- 1 Press CD/USB to select the iPod/USB mode.**  
The iPod/USB indicator on the front panel lights up in orange, then changes to green when playback is ready.
- 2 Start playback.**  
Operate your iPod to start playback, select a track, pause, and stop playback.



You can also use the following buttons: ▷ (Playback), ⏸ (Pause), □ (Stop), ⏮ (Skip backward), ⏭ (Skip forward), ⏪ (Search backward), and ⏩ (Search forward) on this unit or Remote Control.

### Note

iPod may not function properly with this unit if software on iPod is not updated. Be sure to use the latest version of iPod software.

## Playing back USB devices

- 1 Press CD/USB to select the iPod/USB mode.**  
The iPod/USB indicator on the front panel lights up.
- 2 Start playback.**  
Filename is displayed in the front panel display and playback starts automatically in order by date and time of creation if playable files are in the USB device.
- 3 Select a track.**  
Press FOLDER ▽/△ on the remote control to select a folder, and then press ⏮/⏭ or numeric buttons to select a track.
- 4 Stop playback.**  
Press □ (Stop).

See pages 8 for more information on MP3/WMA playback.

## Disconnecting iPod/USB devices

Stop playback, and then disconnect your iPod or USB device. It is recommended that you press CD/USB to switch to the CD mode, confirm that the CD/USB indicator goes off, and then disconnect your iPod/USB device.

### CAUTION

Do not disconnect your iPod or USB device while playing back from the connected device, or while “USB READING” appears in the front panel display.

## Supported iPod/USB devices

### ■ Supported iPod models

- iPod classic (including 120GB model)
- iPod nano (2nd, 3rd and 4th generations)
- iPod touch (1st and 2nd generations)

(as of April 2009)

### Notes

- iPod is licensed on the condition that individuals perform privately duplication and playback of uncopyrighted material or material legally approved of duplication and playback. Infringement of copyright is prohibited by law.
- Yamaha and suppliers accepts no liability for the loss of data saved on iPod connected to this unit. As a precaution, it is recommended that the files are made backup copies.

### ■ Supported USB devices

This unit supports USB mass storage class devices (e.g., flash memories, card readers or portable audio players) that use FAT16 or FAT32 format.

### Notes

- Some devices may not work properly even if they meet the requirements.
- This unit does not support encrypted USB memory devices.
- Do not connect devices other than USB mass storage class devices: USB chargers, USB hubs, PCs, external HDD, etc.
- When you insert two or more memory cards at the same time into a card reader connected to the iPod/USB port on this unit, only one of the memory cards is recognized.
- Yamaha and suppliers accepts no liability for the loss of data saved on the USB devices connected to this unit. As a precaution, it is recommended that the files are made backup copies.
- Playability of and power supply to all kinds of USB devices are not guaranteed.

# PLAYABLE DISC AND FILE FORMAT

## ■ Playable MP3 and WMA files (USB device and Data Disc)

### MP3

| Format                  | Bitrate (kbps) | Sampling frequency (kHz) |
|-------------------------|----------------|--------------------------|
| MPEG 1 Audio Layer-3    | 32-320 *       | 32/44.1/48               |
| MPEG 2 Audio Layer-3, 2 | 8-160 *        | 16/22.05/24              |
| MPEG-2.5 Audio Layer-2  | 8-160 *        | 8/11.025/12              |

\* Variable bitrate is also supported.

### WMA

- Version 8
- Version 9 (Standard and variable bitrates are supported. Professional and Lossless are not supported.)

| Profile      | Bitrate (kbps) | Sampling frequency (kHz) |
|--------------|----------------|--------------------------|
| High Profile | 32-320 *       | 32/44.1/48               |
| Mid Profile  | 16-32          | 16/22.05                 |

\* Variable bitrate is also supported.

### Notes

- Playback for Data Disc starts in alphanumeric order.
- Playback for USB starts in order by date and time of creation.
- Copyright-protected WMA (DRM) files cannot be played back by this unit.
- The disc must be ISO 9660 compatible.
- Elapsed time may not be displayed correctly while playing back variable bitrate contents.

|                                | Data Disc | USB   |
|--------------------------------|-----------|-------|
| Maximum file number            | 999       | 32767 |
| Maximum folder number          | 256       | 256   |
| Maximum file number per folder | 512       | 512   |

## ■ Playable discs

Use compact discs bearing the marks below.



.... Compact discs (digital audio)



.... CD-R, CD-RW digital audio discs

- CD-R or CD-RW discs bearing one of the following phrases.  
FOR CONSUMER USE  
FOR MUSIC USE ONLY
- Finalized CD-R or CD-RW discs.



### Note

This compact disc player may not be able to play some CD-R/CD-RW discs or discs on which recording was not made correctly.



.... CD-TEXT discs

- The disc title, artist name, and track name are also displayed in addition to the time displays when playing back a CD with CD TEXT.

## To play back an 8-cm (3-inch) CD

Place it in the inner recessed area of the disc tray. Do not put a normal (12-cm) CD on top of an 8-cm (3-inch) CD.

### To prevent a malfunction of this unit:

- Do not use any nonstandard shaped disc (heart, etc.) available on the market because it might damage the unit.
- Do not use a disc with tape, stickers, or paste on it. If you use such a disc, the disc may get stuck in the unit, or damage to the unit may result.

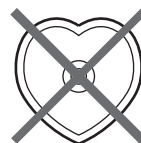

## ■ Handling compact discs

- Always handle with care so that the playing surface is not scratched. Do not warp discs.

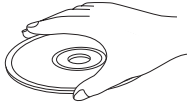

- To keep clean the playing surface, wipe with a clean, dry cloth. Do not use any type of disc cleaner, spray, or any other chemical-based liquid.
- Do not wipe with a circular motion; wipe straight outward from the center.

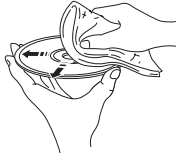

- Use a soft-tipped pen when writing on the label side of the disc.
- When a disc is not being used, remove it from this unit and store in an appropriate case.
- Do not expose discs to direct sunlight, high temperature or high humidity for a long time.

**Note:** Do not use any lens cleaners as they may be a cause of malfunction.

## USING THE ADVANCED SETUP

This unit is equipped with the following two special modes, which may be useful for special purposes at stores or offices.

### Note

The special mode functions are incompatible with iPod.

### Play mode memory

Retains the current playback mode (REPEAT and RANDOM) after turning off the power, saving the time of setting the playback mode again each time you turn on the power.

The RESUM indicator in the front panel display lights up when enabled.

### Ready mode

Pauses playback after each track, allowing you to start the next track at any desired timing.

The RDY indicator in the front panel display lights up when enabled.

To activate and configure Advanced setup, follow the steps below. Use the buttons on the front panel.

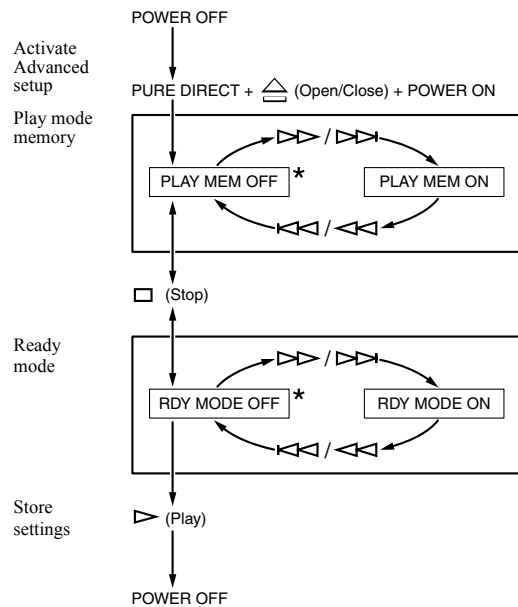

\*: Default Setting

Next time you turn on the power, the unit turns on with the settings that you specified above.

# TROUBLESHOOTING

If the unit fails to operate normally, check the following points to determine whether the problem can be corrected by the simple measures suggested. If it cannot be corrected, or if the problem is not listed in the Problems column, disconnect the power cable and contact your authorized Yamaha dealer or service center for help.

| Problems  | Possible Causes  | Solutions  | Refer to page |
|---|--|--|---------------|
| <b>This unit fails to turn on.</b>  | The power cable is not connected to the AC IN inlet on the rear panel or not plugged in the wall outlet. | Connect the power cable firmly.  | 3             |
| <b>The disc tray does not close completely.</b>                               | A foreign object is obstructing the tray.  | Carefully check the disc tray and remove the foreign object.   | —             |
| <b>Disc playback does not start.</b>  | The disc is damaged.   | Check the disc carefully; replace it if necessary.   | —             |
|   | There is moisture on the laser pickup.   | Wait 20 to 30 minutes after turn on this unit ON before trying to play back a disc.  | —             |
|   | The disc is loaded upside down.  | Reload the disc with the label side up.  | —             |
|   | The disc is dirty.   | Clean the disc.  | 9             |
|   | The format of the MP3 or WMA file is not compatible with this unit.                                      | Replace the disc with a correctly recorded disc playable with this unit.   | 9             |
|   | The CD-RW (ReWritable) disc is not recorded correctly.   | Replace the disc with a correctly recorded disc playable with this unit.   | 9             |
|   | The disc is a non-standard disc not playable with this unit.   | Replace the disc with a correctly recorded disc playable with this unit.   | 9             |
| <b>iPod playback does not start though iPod is connected.</b>                 | This unit is in iPod/USB mode.   | Switch to disc mode by pressing CD/USB.  | 2             |
|   | The connected iPod is not compatible with this unit.   | Connect an iPod compatible with this unit. The compatible iPod are as follows: <ul style="list-style-type: none"> <li>• iPod classic (including 120GB model)</li> <li>• iPod nano (2nd, 3rd and 4th generations)</li> <li>• iPod touch (1st and 2nd generations)</li> </ul> (As of April 2009) | 7             |
| <b>USB playback does not start.</b>   | This unit is in disc mode.   | Switch to iPod/USB mode by pressing CD/USB.  | 6             |
|   | Improper USB device connections.   | Connect the USB device again.  | 6             |
|   | The format of the MP3 or WMA file is not compatible with this unit.                                      | Replace the file with a correctly recorded file playable with this unit.   | 8             |
| <b>Playback is delayed, or begins at the wrong place.</b>                     | This unit is in disc mode.   | Switch to iPod/USB mode by pressing CD/USB.  | 6             |
|   | The disc may be scratched or damaged.  | Check the disc carefully; replace it if necessary.   | 8             |
| <b>No sound.</b>  | Improper output cable connections.   | Connect the cables properly. If the problem persists, the cables may be defective.   | 3             |
|   | Improper amplifier operation.  | Set the amplifier controls to the correct input selection.   | —             |
| <b>Sound of a component connected to the DIGITAL OUT jacks is not played.</b> | PURE DIRECT is turned on.  | Turn PURE DIRECT off. Or make an analog connection.  | 2, 3          |

| Problems   | Possible Causes   | Solutions   | Refer to page |
|--|---|---|---------------|
| Sound "skips".   | This unit is being subjected to vibrations or impacts.  | Relocate this unit.   | —             |
|  | The disc is dirty.  | Clean the disc.   | 8             |
| Sound "hums".  | Improper cable connections.   | Securely connect the audio cables. If the problem persists, the cables may be defective.                                      | 3             |
| Noise from a nearby tuner.                             | The tuner is too close to this unit.  | Move the tuner and this unit farther apart or turn off this unit.   | —             |
| Noise from inside of the disc tray.                    | The disc may be warped.   | Replace the disc.   | —             |
| The remote control does not work or function properly. | Wrong distance or angle.  | The remote control functions within a maximum range of 6 m (20 ft) and no more than 30 degrees off-axis from the front panel. | 4             |
|  | Direct sunlight or lighting (from an inverter type of fluorescent lamp, etc.) is striking the remote control sensor of this unit. | Reposition this unit.   | —             |
|  | The batteries are weak.   | Replace all batteries.  | 4             |

## SPECIFICATIONS

### Audio Section

- Frequency response ..... 2 Hz - 20 kHz,  $\pm 0.5$  dB
- Harmonic distortion + noise (1 kHz) ..... 0.003 % or less
- S/N ratio ..... 105 dB or more
- Dynamic range ..... 96 dB or more
- Output voltage (1 kHz, 0 dB) .....  $2.0 \pm 0.3$  V

### Laser Diode Properties

- Material ..... GaAlAs
- Wavelength ..... 790 nm
- Laser Output ..... max. 1.23  $\mu$ W\*

\* This output is the value measured at a distance of about 200 mm from the objective lens surface on the Optical Pick-up Block.

### iPod™

"iPod" is a trademark of Apple Inc., registered in U.S. and other countries.

"Made for iPod" means that an electronic accessory has been designed to connect specifically to iPod and has been certified by the developer to meet Apple performance standards.

Apple is not responsible for the operation of this device or its compliance with safety and regulatory standards.

### General

- Power requirements
  - U.S.A. and Canada models ..... AC 120 V, 60 Hz
  - Australia model ..... AC 240 V, 50 Hz
  - Europe and U.K. models ..... AC 230 V, 50 Hz
  - Asia and General models ..... AC 110-120/220-240 V, 50/60 Hz
  - China model ..... AC 220 V, 50 Hz
- Operating temperature ..... +5 °C to +35 °C (+41 °F to +95 °F)
- Power consumption ..... 13 W
- Dimensions (W × H × D) ..... 435 × 86 × 260 mm  
(17 1/8 × 3 3/8 × 10 1/4 in)
- Weight ..... 3.5 kg (7.7 lbs)

Please note that all specifications are subject to change without notice.





## Free Manuals Download Website

<http://myh66.com>

<http://usermanuals.us>

<http://www.somanuals.com>

<http://www.4manuals.cc>

<http://www.manual-lib.com>

<http://www.404manual.com>

<http://www.luxmanual.com>

<http://aubethermostatmanual.com>

Golf course search by state

<http://golfingnear.com>

Email search by domain

<http://emailbydomain.com>

Auto manuals search

<http://auto.somanuals.com>

TV manuals search

<http://tv.somanuals.com>