



CRX-E500

RX-E400
CDC-E500

Receiver/CD Player



OWNER'S MANUAL

SAFETY INSTRUCTIONS

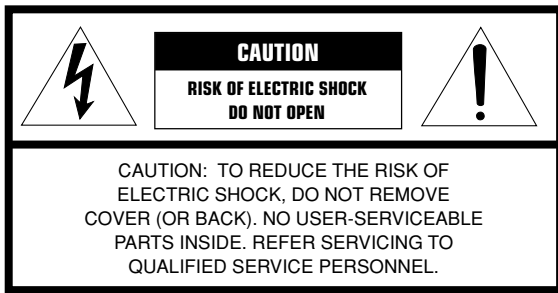

• Explanation of Graphical Symbols

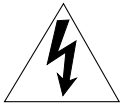

The lightning flash with arrowhead symbol, within an equilateral triangle, is intended to alert you to the presence of uninsulated “dangerous voltage” within the product’s enclosure that may be of sufficient magnitude to constitute a risk of electric shock to persons.



The exclamation point within an equilateral triangle is intended to alert you to the presence of important operating and maintenance (servicing) instructions in the literature accompanying the appliance.

WARNING

TO REDUCE THE RISK OF FIRE OR ELECTRIC SHOCK, DO NOT EXPOSE THIS UNIT TO RAIN OR MOISTURE.

- 1 Read Instructions – All the safety and operating instructions should be read before the product is operated.
- 2 Retain Instructions – The safety and operating instructions should be retained for future reference.
- 3 Heed Warnings – All warnings on the product and in the operating instructions should be adhered to.
- 4 Follow Instructions – All operating and use instructions should be followed.
- 5 Cleaning – Unplug this product from the wall outlet before cleaning. Do not use liquid cleaners or aerosol cleaners. Use a damp cloth for cleaning.
- 6 Attachments – Do not use attachments not recommended by the product manufacturer as they may cause hazards.
- 7 Water and Moisture – Do not use this product near water – for example, near a bath tub, wash bowl, kitchen sink, or laundry tub; in a wet basement; or near a swimming pool; and the like.
- 8 Accessories – Do not place this product on an unstable cart, stand, tripod, bracket, or table. The product may fall, causing serious injury to a child or adult, and serious damage to the product. Use only with a cart, stand, tripod, bracket, or table recommended by the manufacturer, or sold with the product. Any mounting of the product should follow the manufacturer’s instructions, and should use a mounting accessory recommended by the manufacturer.
- 9 A product and cart combination should be moved with care. Quick stops, excessive force, and uneven surfaces may cause the product and cart combination to overturn. 
- 10 Ventilation – Slots and openings in the cabinet are provided for ventilation and to ensure reliable operation of the product and to protect it from overheating, and these openings must not be blocked or covered. The openings should never be blocked by placing the product on a bed, sofa, rug, or other similar surface. This product should not be placed in a built-in installation such as a bookcase or rack unless proper ventilation is provided or the manufacturer’s instructions have been adhered to.
- 11 Power Sources – This product should be operated only from the type of power source indicated on the marking label. If you are not sure of the type of power supply to your home, consult your product dealer or local power company. For products intended to operate from battery power, or other sources, refer to the operating instructions.
- 12 Grounding or Polarization – This product may be equipped with a polarized alternating current line plug (a plug having one blade wider than the other). This plug will fit into the power outlet only one way. This is a safety feature. If you are unable to insert the plug fully into the outlet, try reversing the plug. If the plug should still fail to fit, contact your electrician to replace your obsolete outlet. Do not defeat the safety purpose of the polarized plug.
- 13 Power-Cord Protection – Power-supply cords should be routed so that they are not likely to be walked on or pinched by items placed upon or against them, paying particular attention to cords at plugs, convenience receptacles, and the point where they exit from the product.
- 14 Lightning – For added protection for this product during a lightning storm, or when it is left unattended and unused for long periods of time, unplug it from the wall outlet and disconnect the antenna or cable system. This will prevent damage to the product due to lightning and power-line surges.
- 15 Power Lines – An outside antenna system should not be located in the vicinity of overhead power lines or other electric light or power circuits, or where it can fall into such power lines or circuits. When installing an outside antenna system, extreme care should be taken to keep from touching such power lines or circuits as contact with them might be fatal.
- 16 Overloading – Do not overload wall outlets, extension cords, or integral convenience receptacles as this can result in a risk of fire or electric shock.
- 17 Object and Liquid Entry – Never push objects of any kind into this product through openings as they may touch dangerous voltage points or short-out parts that could result in a fire or electric shock. Never spill liquid of any kind on the product.
- 18 Servicing – Do not attempt to service this product yourself as opening or removing covers may expose you to dangerous voltage or other hazards. Refer all servicing to qualified service personnel.
- 19 Damage Requiring Service – Unplug this product from the wall outlet and refer servicing to qualified service personnel under the following conditions:
 - a) When the power-supply cord or plug is damaged,
 - b) If liquid has been spilled, or objects have fallen into the product,
 - c) If the product has been exposed to rain or water,

- d) If the product does not operate normally by following the operating instructions. Adjust only those controls that are covered by the operating instructions as an improper adjustment of other controls may result in damage and will often require extensive work by a qualified technician to restore the product to its normal operation,
 - e) If the product has been dropped or damaged in any way, and
 - f) When the product exhibits a distinct change in performance - this indicates a need for service.
- 20 Replacement Parts – When replacement parts are required, be sure the service technician has used replacement parts specified by the manufacturer or have the same characteristics as the original part. Unauthorized substitutions may result in fire, electric shock, or other hazards.
 - 21 Safety Check – Upon completion of any service or repairs to this product, ask the service technician to perform safety checks to determine that the product is in proper operating condition.
 - 22 Wall or Ceiling Mounting – The unit should be mounted to a wall or ceiling only as recommended by the manufacturer.
 - 23 Heat – The product should be situated away from heat sources such as radiators, heat registers, stoves, or other products (including amplifiers) that produce heat.

- 24 Outdoor Antenna Grounding – If an outside antenna or cable system is connected to the product, be sure the antenna or cable system is grounded so as to provide some protection against voltage surges and built-up static charges. Article 810 of the National Electrical Code, ANSI/NFPA 70, provides information with regard to proper grounding of the mast and supporting structure, grounding of the lead-in wire to an antenna discharge unit, size of grounding conductors, location of antenna discharge unit, connection to grounding electrodes, and requirements for the grounding electrode.

EXAMPLE OF ANTENNA GROUNDING

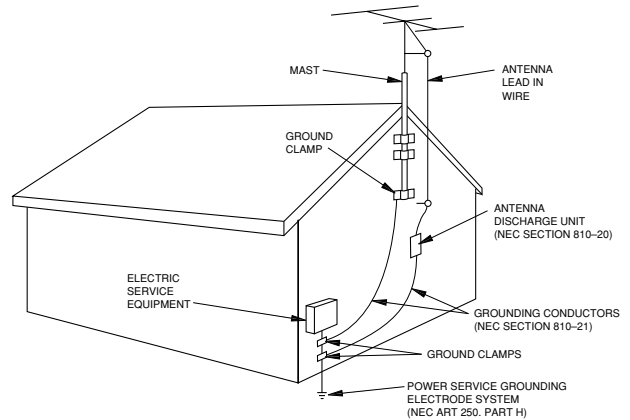

Note to CATV system installer:

This reminder is provided to call the CATV system installer's attention to Article 820-40 of the NEC that provides guidelines for proper grounding and, in particular, specifies that the cable ground shall be connected to the grounding system of the building, as close to the point of cable entry as practical.

FCC INFORMATION (for US customers)

1. IMPORTANT NOTICE : DO NOT MODIFY THIS UNIT!

This product, when installed as indicated in the instructions contained in this manual, meets FCC requirements. Modifications not expressly approved by Yamaha may void your authority, granted by the FCC, to use the product.

2. IMPORTANT : When connecting this product to accessories and/or another product use only high quality shielded cables. Cable/s supplied with this product MUST be used. Follow all installation instructions. Failure to follow instructions could void your FCC authorization to use this product in the USA.

3. NOTE : This product has been tested and found to comply with the requirements listed in FCC Regulations, Part 15 for Class "B" digital devices. Compliance with these requirements provides a reasonable level of assurance that your use of this product in a residential environment will not result in harmful interference with other electronic devices.

This equipment generates/uses radio frequencies and, if not installed and used according to the instructions found in the users manual, may cause interference harmful to the operation of other electronic devices.

Compliance with FCC regulations does not guarantee that interference will not occur in all installations. If this product is found to be the source of interference, which can be determined by turning the unit "OFF" and "ON", please try to eliminate the problem by using one of the following measures:

Relocate either this product or the device that is being affected by the interference.

Utilize power outlets that are on different branch (circuit breaker or fuse) circuits or install AC line filter/s.

In the case of radio or TV interference, relocate/reorient the antenna. If the antenna lead-in is 300 ohm ribbon lead, change the lead-in to coaxial type cable.

If these corrective measures do not produce satisfactory results, please contact the local retailer authorized to distribute this type of product. If you can not locate the appropriate retailer, please contact Yamaha Electronics Corp., U.S.A. 6660 Orangethorpe Ave, Buena Park, CA 90620.

The above statements apply ONLY to those products distributed by Yamaha Corporation of America or its subsidiaries.

CAUTION: READ THIS BEFORE OPERATING THIS UNIT

- 1 To assure the finest performance, please read this manual carefully. Keep it in a safe place for future reference.
- 2 Install this unit in a well ventilated, cool, dry, clean place away from direct sunlight, heat sources, vibration, dust, moisture or cold. In a cabinet, allow about 10 cm (4 in.) of free space all around RX-E400 for adequate ventilation.
- 3 Locate this unit away from other electrical appliances, motors, or transformers to avoid humming sounds.
- 4 Do not expose this unit to sudden temperature changes from cold to hot, nor locate this unit in an environment with high humidity (i.e., a room with a humidifier) to prevent condensation inside this unit, which may cause an electrical shock, fire, damage to this unit, and/or personal injury.
- 5 Avoid installing this unit in a location where foreign objects may fall onto this unit or where this unit may be exposed to liquid dripping or splashing. On the top of this unit, do not place:
 - Other components, as they may cause damage and/or discoloration on the surface of this unit.
 - Burning objects (i.e., candles), as they may cause fire, damage to this unit, and/or personal injury.
 - Containers with liquid in them, as they may fall, spilling the liquid and causing an electrical shock to the user and/or damage to this unit.
- 6 Do not cover this unit with a newspaper, tablecloth, curtain, etc. in order not to obstruct heat radiation. If the temperature inside this unit rises, it may cause fire, damage to this unit, and/or personal injury.
- 7 Do not plug in this unit to a wall outlet until all connections are complete.
- 8 Do not operate this unit upside-down. It may overheat, possibly causing damage.
- 9 Do not use excessive force on switches, knobs and/or cords.
- 10 When disconnecting the power cord from the wall outlet, grasp the plug; do not pull the cord.
- 11 Do not clean this unit with chemical solvents; this might damage the finish. Use a clean, dry cloth.
- 12 Use only the voltage specified on this unit. Using this unit with a higher voltage than specified is dangerous and may cause fire, damage to this unit, and/or personal injury. YAMAHA will not be held responsible for any damage resulting from use of this unit with a voltage other than as specified.
- 13 To prevent damage by lightning, disconnect the power cord from the wall outlet during an electrical storm.
- 14 Do not attempt to modify or fix this unit. Contact qualified YAMAHA service personnel when any service is needed. The cabinet should never be opened for any reason.
- 15 When not planning to use this unit for long periods of time (i.e., vacation), disconnect the AC power plug from the wall outlet.
- 16 Be sure to read the "Troubleshooting" section on common operating errors before concluding that this unit is faulty.
- 17 Before moving this unit, press **STANDBY/ON** to set the unit in standby mode, then disconnect the AC power plug from the wall outlet.
- 18 **VOLTAGE SELECTOR** (General model only)

The **VOLTAGE SELECTOR** on the rear panel of this unit must be set for your local main voltage **BEFORE** plugging into the AC main supply. Voltages are 110/120/220/240 V AC, 50/60 Hz.

To reduce the risk of fire or electric shock, do not expose this appliance to rain or moisture.

The unit is not disconnected from the AC power source as long as it is connected to the wall outlet, even if this unit itself is turned off. This state is called the standby mode. In this state, this unit is designed to consume a very small quantity of power.

CAUTION FOR CARRYING THE UNIT

Before carrying the unit, first remove the disc from the unit, press **STANDBY/ON** to turn the unit off, then disconnect the AC power plug from the wall outlet.

FOR CANADIAN CUSTOMERS

To prevent electric shock, match wide blade of plug to wide slot and fully insert.
This Class B digital apparatus complies with Canadian ICES-003.

CAUTION

Use of controls or adjustments or performance of procedures other than those specified herein may result in hazardous radiation exposure.

Laser component in this product is capable of emitting radiation exceeding the limit for Class 1.

RX-E400 (U.S.A., Canada and General models)
The nameplate is located on the bottom of the unit.

IMPORTANT

Please record the serial number of this unit in the space below.

MODEL:

Serial No.:

The serial number is located on the bottom of the unit. Retain this Owner's Manual in a safe place for future reference.

We Want You Listening For A Lifetime

YAMAHA and the Electronic Industries Association's Consumer Electronics Group want you to get the most out of your equipment by playing it at a safe level. One that lets the sound come through loud and clear without annoying blaring or distortion – and, most importantly, without affecting your sensitive hearing.

III CAUTION

Since hearing damage from loud sounds is often undetectable until it is too late, YAMAHA and the Electronic Industries Association's Consumer Electronics Group recommend you to avoid prolonged exposure from excessive volume levels.



FEATURES

<RX-E400>

- Minimum RMS output power per channel 40 W + 40 W (6Ω, 20 Hz to 20 kHz, 0.1% THD)
- Full operation system remote control
- 40-Station FM/AM preset tuning
- SUBWOOFER output terminal

<CDC-E500>

- 3-Disc CD changer
- **PLAY**×**CHANGE**
Disc changing while playing
- 5-bit DAC and 8fs digital filter
- Optical digital output
- Random, repeat, and program play
- **CD TEXT** display
- CD-RW compatible

The receiver (RX-E400) and CD player (CDC-E500) are the main units of the YAMAHA Piano Craft Series.

You can upgrade the system by adding the cassette deck (KX-E300) and MD recorder (MDX-E300)*.

* MD recorder (MDX-E300) may not be available for some areas.

CONTENTS

SUPPLIED ACCESSORIES 2

CD PREVENTIVE CARE 2

GETTING STARTED

Notes on the transportation pad	3
Remote control	4
Connecting the speakers and antennas	5
Connecting the system	6
Setting the clock	7
Adjusting the brightness of the display	7

<RX-E400>

NAMES OF BUTTONS AND CONTROLS

Front panel	8
Display	8
Remote control	9

BASIC OPERATIONS

Listening to a source	10
-----------------------------	----

TUNING

Listening to the radio	11
Presetting stations	12

USING THE BUILT-IN TIMER

Before using the timer	13
Timer play and recording	13
Sleep timer	14

<CDC-E500>

NAMES OF BUTTONS AND CONTROLS

Front panel	15
Display	15
Remote control	16

CD OPERATIONS

Playing a disc	17
Selecting the time display and CD TEXT	18
Random-sequence play	19
Repeat play	19
Program play	20

SYSTEM CONTROL

Controlling other components	21
Before recording	22
CD synchronized recording	22
Dubbing setting	22

ADDITIONAL INFORMATION

Troubleshooting	24
Specifications	26

SUPPLIED ACCESSORIES

After unpacking, check that the following parts are contained.

<RX-E400>

- Remote control

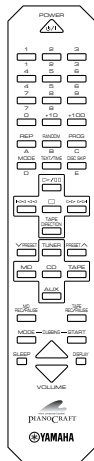

- Batteries (AA, R6, UM-3)

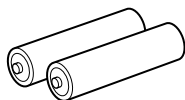

- AM loop antenna

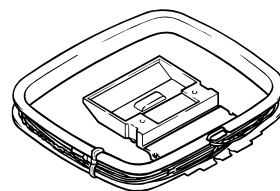

- Indoor FM antenna

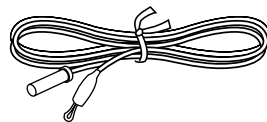

<CDC-E500>

- Audio pin cable

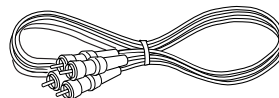

- System control cable

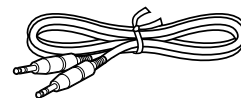

CD PREVENTIVE CARE

- This compact disc player is designed for use with following types of disc only. Never attempt to load any other type of disc into the unit. The unit will also play 8-cm (3-inch) compact discs.



(Playback only)

- Be sure to use only CD-R and CD-RW discs made by reliable manufacturers.
- Some discs cannot be played depending on the disc characteristics or recording conditions (copyright-protected in a particular way, etc.).
- Compact discs are not subjected to wear during play, but damage to the disc surface when the disc is being handled can adversely affect the disc's play.
- Do not use cleaning discs or warped discs. All of these could damage the unit.

To prevent a malfunction of this unit

- Do not use any non standard shaped CD (heart, etc.) available on the market, because it may damage the unit.

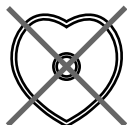

- Do not use a CD with tape, seals, or paste on it, because damage to the unit may result.
- Do not use any disc that has had its surface printed by a commercially-available label printer.
- Compact discs are not affected by small particles of dust or fingerprints on their playing surface, but even so they should be kept clean. Wipe by using a clean, dry cloth. Do not wipe with a circular motion; wipe straight outward from the center.

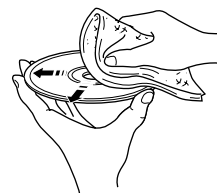

- Do not try to clean the disc's surface by using any type of disc cleaner, record spray, antistatic spray or liquid, or any other chemical-based liquid, because such substances might irreparably damage the disc's surface.
- Do not expose discs to direct sunlight, high temperature or high humidity for a long period of time, because these might warp or otherwise damage the disc.

No!



Notes on the transportation pad

CDC-E500 is shipped with a transportation pad to prevent impact to the internal mechanism that could occur during transportation. Before turning CDC-E500 on, make sure to remove the pad.

Before using the unit

- 1 Take off the caution label.

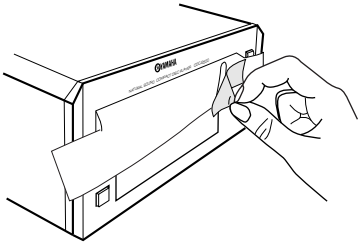

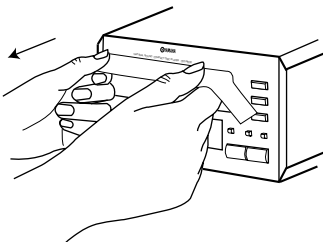

- 2 Draw the pad out.



Installing the transportation pad

Keep the pad and the caution label, and reattach it as described below whenever the unit is moved. Before attaching it, remove all discs from the disc tray.

- 1 Press **DISC 1** , **DISC 2**  or **DISC 3**  to open the tray.
 - When just one disc holder comes out, press **DISC SKIP** so that two holders come out.
- 2 Pass the strip of the pad through the hole to bind two disc holders together.

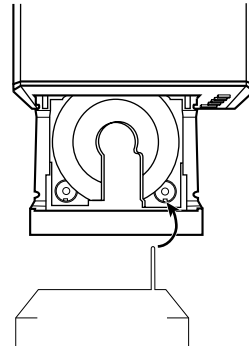

- 3 Fix the strip on the pad with the caution label.

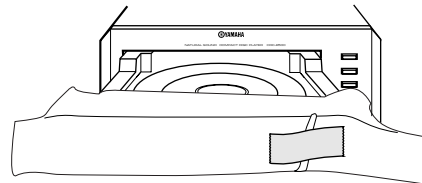

- 4 Press **STANDBY/ON** on CDC-E500 to close the disc tray.

Remote control

This remote control controls a whole system: not only RX-E400 but also CDC-E500. Moreover, a cassette deck (KX-E300) and MD recorder (MDX-E300) that level up your system can be operated by it. Operating buttons for each unit are explained on the pages below:

Receiver, RX-E400:	p.8
CD player, CDC-E500:	p.15
Cassette deck, KX-E300:	p.21
MD recorder, MDX-E300:	p.21

Battery installation

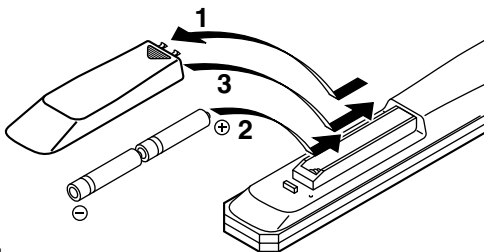

- 1 Remove the battery compartment cover.
- 2 Insert batteries into the battery compartment.
- 3 Replace the battery compartment cover.

Battery replacement

If you find that the remote control must be used closer to the main unit than usual, the batteries are weak. Replace batteries with new ones.

Notes

- Use only AA, R6, UM-3 batteries for replacement.
- Be sure the polarities are correct. (See the illustration inside the battery compartment.)
- Remove the batteries if the remote control will not be used for an extended period of time.
- If batteries leak, dispose of them immediately. Avoid touching the leaked material or letting it come in contact with clothing, etc. Clean the battery compartment thoroughly before installing new batteries.

Remote control operation range

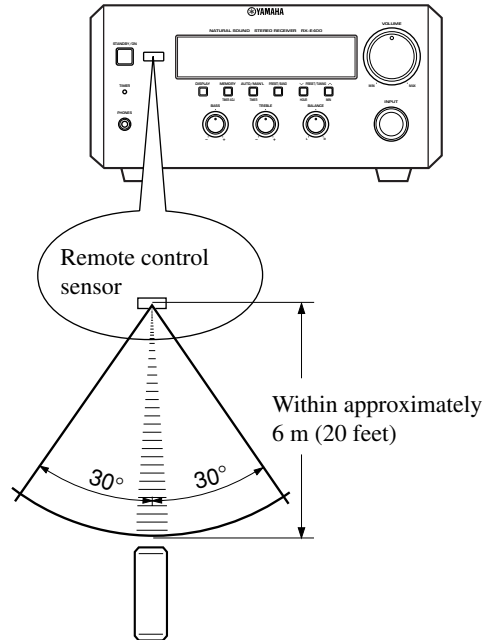

Notes

- There should be no large obstacles between the remote control and the main unit.
- If the remote control sensor is directly illuminated by strong lighting (especially an inverter type of fluorescent lamp, etc.), it might cause the remote control not to work correctly. In this case, reposition the main unit to avoid direct lighting.

Removing the protection sheet

The remote control is shipped with a protection sheet to prevent the surface from being scratched during transportation.

When removing the sheet, first put adhesive tape on an edge of the remote control so that the tape sticks to the sheet. Then peel the sheet off with the tape.

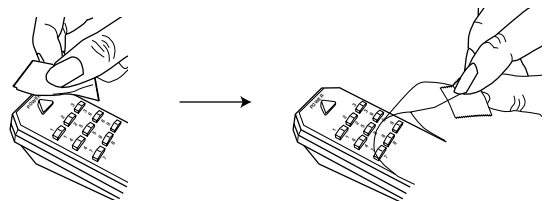

Note

- Do not scratch the remote control surface when peeling the sheet off.

Connecting the speakers and antennas

Never plug the AC power cord to the wall outlet until all connections are completed.

Follow the steps as shown below to connect the system using the supplied cords and accessories. Be sure all connections are made correctly, that is to say L (left) to L, R (right) to R, “+” to “+” and “-” to “-”.

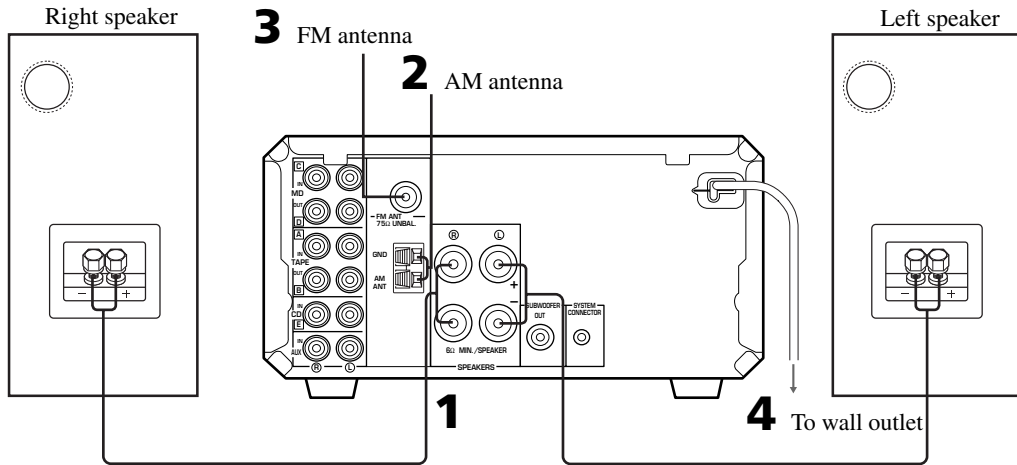

- 1** Connect the Speakers.
- ① Unscrew the knob.
 - ② Remove approx. 10 mm (4") of insulation from each of the speaker wires and insert the bare wire into the terminal.
 - ③ Tighten the knob to secure the wire.

Red: positive(+)
Black: negative(-)

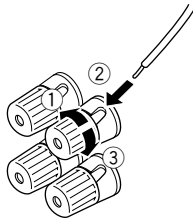

- 3** Connect the indoor FM antenna.

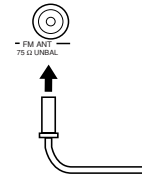

- 4** Connect the AC power cord to a wall outlet.

- 2** Connect the AM loop antenna.
Set up the AM loop antenna, then connect it.

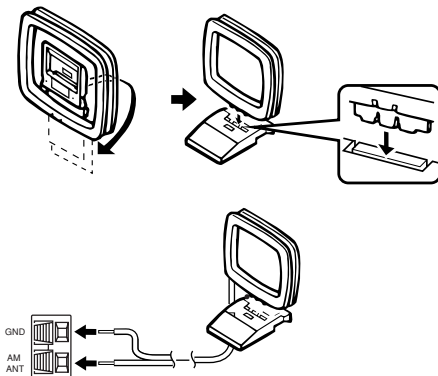

Notes

- Use external FM/AM antennas if you need better reception. Consult your dealer.
- The AM loop antenna should be placed apart from the main unit. The antenna may be hung on a wall.

To connect the subwoofer (optional)

You can reinforce the bass frequencies by adding a subwoofer (optional). Connect the **SUBWOOFER OUT** terminal of the unit to the **INPUT** terminal of the subwoofer.

Connecting the system

Connecting RX-E400 and CDC-E500

- 1** Connect **[E]** to **[E]** using the Audio pin cable.
Insert the plugs into the jacks of the same color.
- 2** Connect RX-E400 and CDC-E500 with the system control cable.
The other **SYSTEM CONNECTOR** of CDC-E500 is for connecting MDX-E300 or KX-E300.
- 3** Connect the AC power plug of CDC-E500 to **AC OUTLET** of RX-E400.
This connection reduces the standby power consumption of CDC-E500.

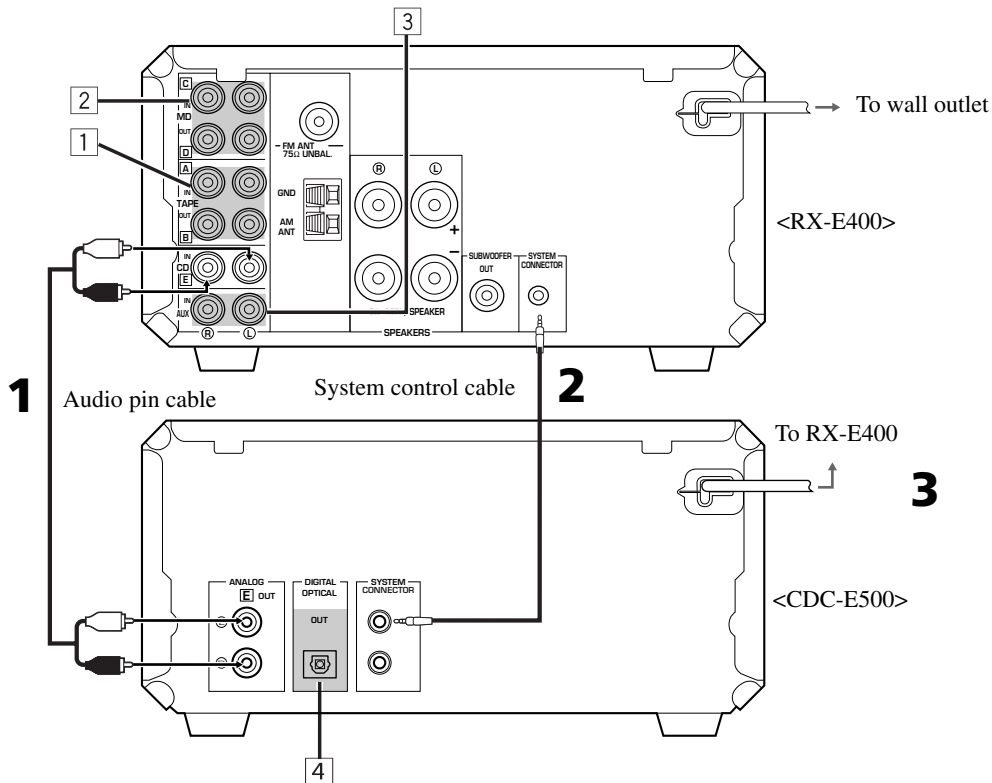

Adding KX-E300 and MDX-E300 to the above system

(For details, refer to the owner's manual supplied with the respective component.)

- 1** Connect **[A]** and **[B]** of RX-E400 to **[A]** and **[B]** of KX-E300.
- 2** Connect **[C]** and **[D]** of RX-E400 to **[C]** and **[D]** of MDX-E300.
- 3** Connect an external component to the **AUX** terminal of RX-E400.
- 4** Connect **DIGITAL OPTICAL OUT** of CDC-E500 to **DIGITAL OPTICAL IN** of MDX-E300.

Take off the covers of the optical fiber cable plug, the **DIGITAL OPTICAL OUT** jack, and the **DIGITAL OPTICAL IN** jack before making digital connections. Be sure to replace the terminal's cover when the terminal on the rear panel is not being used, in order to protect from dust.

Caution

- Never turn RX-E400 on until all connections between components have been completed.
- Never connect or disconnect the system control cable and/or power cord while the system components are turned on.

Setting the clock

You must set the clock before you use the timer functions. The clock is based on a 12-hour system for U.S. and Canada models, and 24-hour system for Australia model.

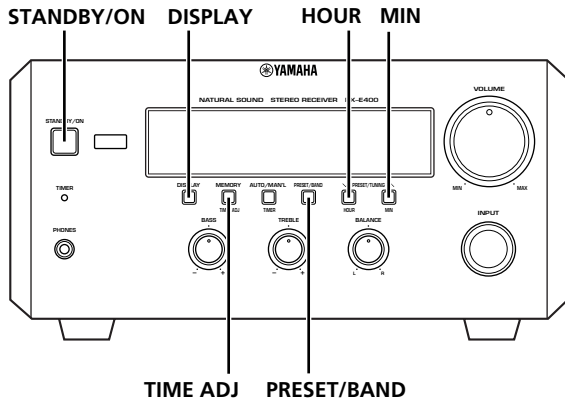

- 1** Turn on the power by pressing **STANDBY/ON** on the front panel, or **POWER** on the remote control.
- 2** While the power is on, press **DISPLAY** to display the time.
- 3** While holding **TIME ADJ**, press **HOUR** to set the hour.
 - If you want to move the time in the reverse direction, press **HOUR** while holding **TIME ADJ** and **PRESET/BAND**.
- 4** While holding **TIME ADJ**, press **MIN** to set the minutes.
 - If you want to move the time in the reverse direction, press **MIN** while holding **TIME ADJ** and **PRESET/BAND**.

To display the clock

Press **DISPLAY**.

The current time appears for about 8 seconds, then the normal display returns. Some buttons and controls may not work while the current time is displayed.

Note

- In the event of a power failure or when the AC power cord is disconnected for more than five minutes, you must reset the clock.

Adjusting the brightness of the display

You can adjust the brightness of the display. If you have connected the CD player (CDC-E500), cassette deck (KX-E300), and/or MD recorder (MDX-E300) to this unit, the brightness of the displays is automatically adjusted to that of this unit.

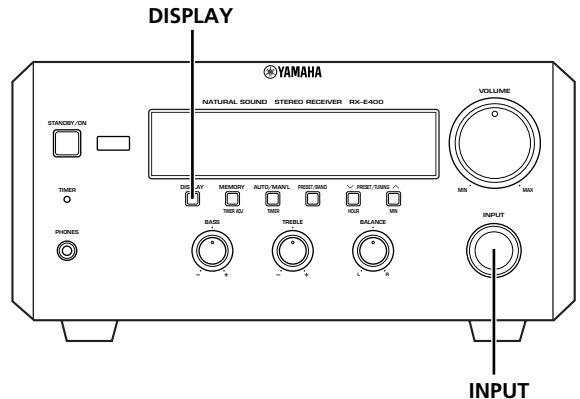

Press and hold **DISPLAY** for about two seconds so that "Dimmer ±0" appears on the display. While holding **DISPLAY**, turn **INPUT** clockwise to increase or counterclockwise to decrease brightness.



Control Range: ±0 to -6 (Preset value: ±0)

Front panel

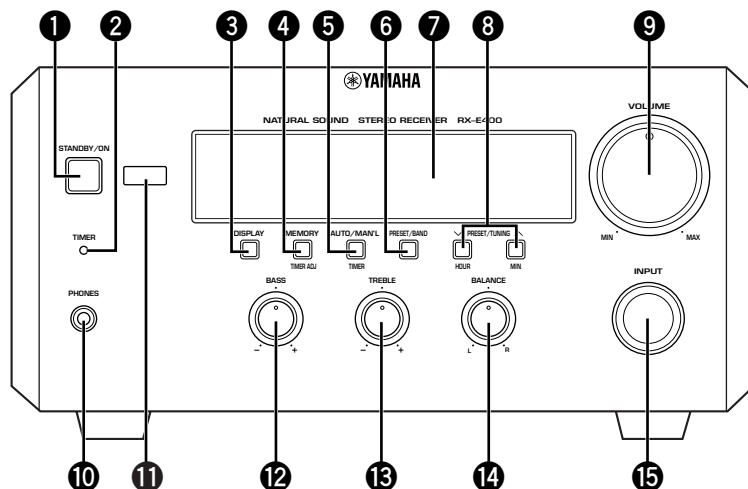

- | | |
|--------------------------------------------------------------------|---------------------------------------|
| 1 STANDBY/ON (P.10) | 9 VOLUME (P.10) |
| 2 TIMER indicator (P.13) | 10 PHONES (P.10) |
| 3 DISPLAY (P.13) | 11 Remote control sensor (P.4) |
| 4 TIME ADJ (P.7) / MEMORY (P.12) | 12 BASS (P.10) |
| 5 AUTO/MAN'L (P.11) / TIMER (P.13) | 13 TREBLE (P.10) |
| 6 PRESET/BAND (P.11) | 14 BALANCE (P.10) |
| 7 Display (This page) | 15 INPUT (P.10) |
| 8 PRESET/TUNING \wedge/\vee (P.11)
HOUR/MIN (P.7/P.13) | |

Display

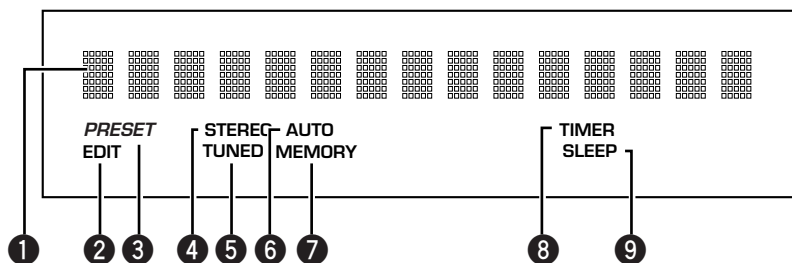

- | | |
|------------------------------------|----------------------------------|
| 1 Multi-information display | 6 AUTO indicator (P.11) |
| 2 EDIT indicator | 7 MEMORY indicator (P.12) |
| 3 PRESET indicator (P.12) | 8 TIMER indicator (P.13) |
| 4 STEREO indicator (P.11) | 9 SLEEP indicator (P.14) |
| 5 TUNED indicator (P.11) | |

Remote control

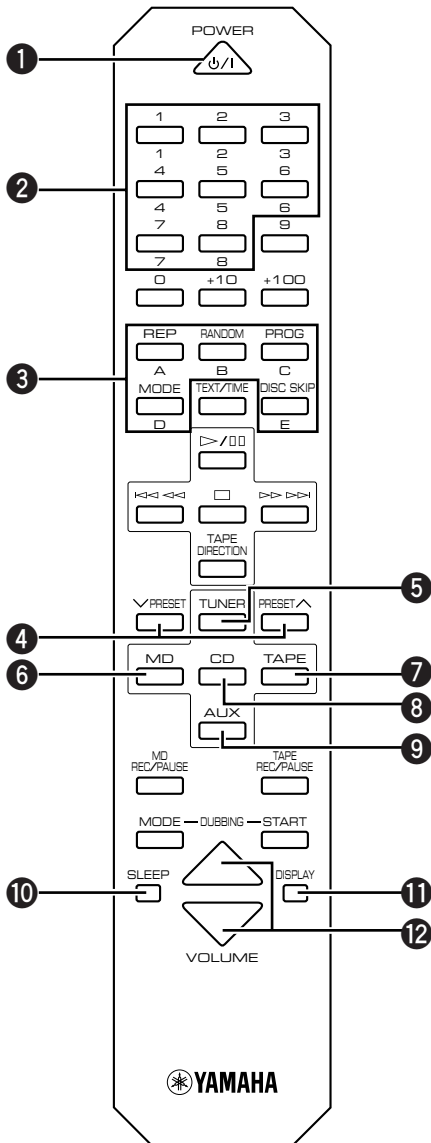

- 1** POWER (P.10)
- 2** Preset numbers (P.12)
- 3** A/B/C/D/E (P.12)
- 4** PRESET \wedge/\vee (P.12)
- 5** TUNER (RX-E400) (P.12)
- 6** MD (MDX-E300) (P.21)
- 7** TAPE (KX-E300) (P.21)
- 8** CD (CDC-E500) (P.16)
- 9** AUX (The equipment connected to the AUX terminal) (P.6)
- 10** SLEEP (P.14)
- 11** DISPLAY (P.13)
- 12** VOLUME Δ/∇ (P.10)

Note

- **5-9** are operation buttons and input selectors for each component.

Listening to a source

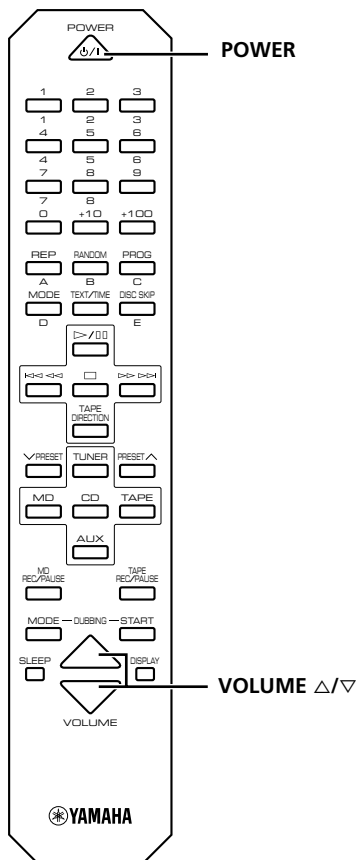
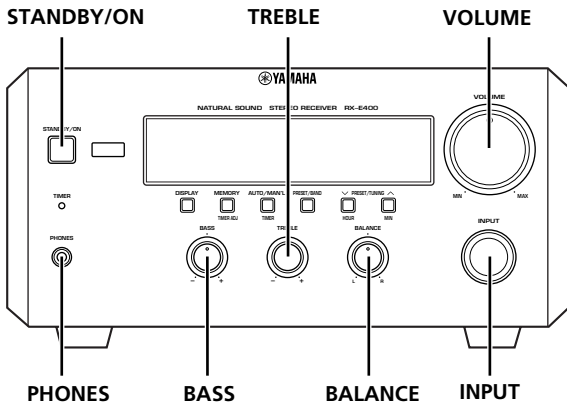

- 1** Set the volume to “**MIN**” by turning **VOLUME**.
- 2** Turn on the power by pressing **STANDBY/ON** on the front panel, or **POWER** on the remote control.
 - Piano Craft series components that have correct system connections made to RX-E400 can be controlled to turn to the on or standby mode by RX-E400. However, once the connected components are turned to the standby mode with their respective **STANDBY/ON**, they cannot be controlled by RX-E400 **STANDBY/ON**.
- 3** Select the desired input source by turning **INPUT** so that the source appears on the display.
 - When you operate the component connected to the **AUX** terminal, turn **INPUT** to select **AUX**.
- 4** Play the source. (Refer to the owner’s manual supplied with each selected component.)
- 5** Adjust the volume level by turning **VOLUME** on the front panel or pressing **VOLUME** Δ/▽ on the remote control.
- 6** If desired, adjust **BASS**, **TREBLE**, and **BALANCE**.

BASS: Turn this control clockwise to increase (or counterclockwise to decrease) the low frequency response.

TREBLE: Turn this control clockwise to increase (or counterclockwise to decrease) the high frequency response.

BALANCE: Adjust the balance of the output volume from the left and right speakers to compensate for sound imbalance caused by the speaker location or listening room conditions.

When you use headphones

Connect the headphones to the **PHONES** jack. You can listen to the sound to be output from the main speakers through the headphones.

When you have finished using this unit

Press **STANDBY/ON** on the front panel again or **POWER** on the remote control to set this unit to the standby mode.

Auto standby function

This unit will be put automatically into the standby mode under the following conditions:

- A component connected with a system control cable is selected as an input source.
- The component connected to this unit is in stop mode and not operated for 30 minutes.

Listening to the radio

You can find radio stations automatically and manually.

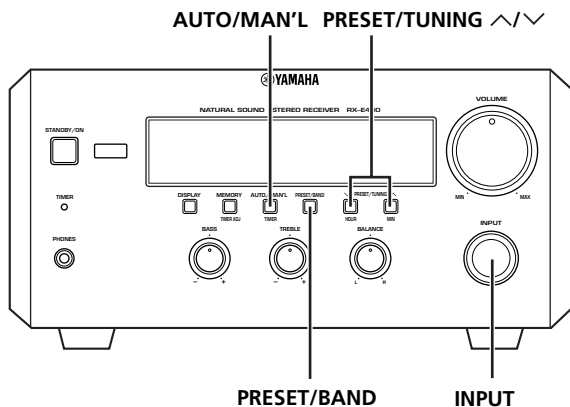

Manual tuning

- 1** Follow steps 1 and 2 described in “Automatic tuning.”
- 2** Press **AUTO/MAN'L** so that “AUTO” disappears from the display.
- 3** Press **PRESET/TUNING** \wedge (For a higher frequency) or \vee (For a lower frequency) to select your desired station.
 - Each time you press **PRESET/TUNING** \wedge or \vee , the frequency changes step by step.

Automatic tuning

- 1** Select **TUNER** by turning **INPUT** so that the frequency of a radio station appears in the display.
- 2** Press **PRESET/BAND** to select the reception band. Do not select the preset tuning mode (in which “PRESET” appears on the display).
- 3** Press **AUTO/MAN'L** so that “AUTO” appears in the display.
- 4** Press **PRESET/TUNING** \wedge (For a higher frequency) or \vee (For a lower frequency).
- 5** The unit starts searching for a station.



When the unit finds a station, the unit stops searching and “TUNED” appears on the display.

- 6** If the located station is not the one you want, repeat steps 4 and 5 until a station you want is tuned.

Notes

- If automatic tuning search does not find the desired station, try manual tuning as described next.
- When an FM stereo broadcast with sufficient signal strength is received, “STEREO” appears on the display and you can listen to stereo sound.

Presetting stations

The unit can preset station frequencies selected by Automatic tuning or Manual tuning. Up to 40 stations can be stored. With this function, you can select any desired station by pressing the corresponding preset station number.

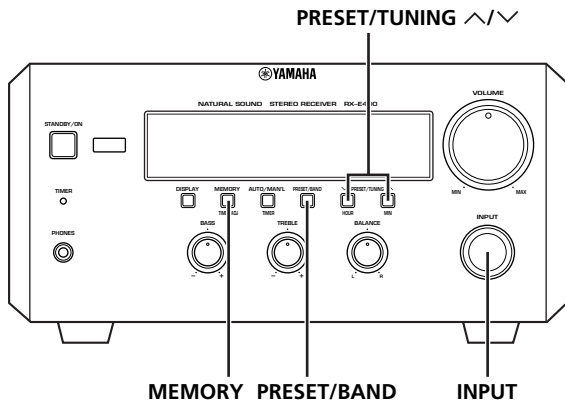

To preset stations manually

- 1 Tune in a desired station.
(Refer to the previous page for the tuning procedure.)
- 2 Press **MEMORY**.
- 3 Within about 5 seconds, use **PRESET/TUNING** $\swarrow\searrow$ to select a desired preset number. Continue pressing **PRESET/TUNING** $\swarrow\searrow$ to select the group of the preset stations (A, B, C, D, and E).



- 4 Press **MEMORY**.
 - “MEMORY”, “PRESET”, and preset number will appear on the display.

The arrow will appear for a second when it is preset.



- 5 Repeat steps 1 to 4 until all desired stations are preset.

Notes

- A new setting can be preset in place of a previous one.
- The preset stations are retained for a week after you disconnect the AC power cord or a power failure occurs.

To preset stations automatically

- 1 Select TUNER as input source by turning **INPUT**.
- 2 Press **MEMORY** for about 2 seconds.
 - The unit starts presetting stations, “AUTO” and “MEMORY” will flash on the display.

Received stations are stored to A1, A2...A8 sequentially. After 40 stations or all FM and AM stations are stored, the display will show the preset station A1.

To recall a preset station

Press **TUNER** and select the desired number by pressing **PRESET/BAND** and **PRESET/TUNING** $\swarrow\searrow$ on the front panel or **PRESET** $\swarrow\searrow$, **A/B/C/D/E** and **1-8** on the remote control.

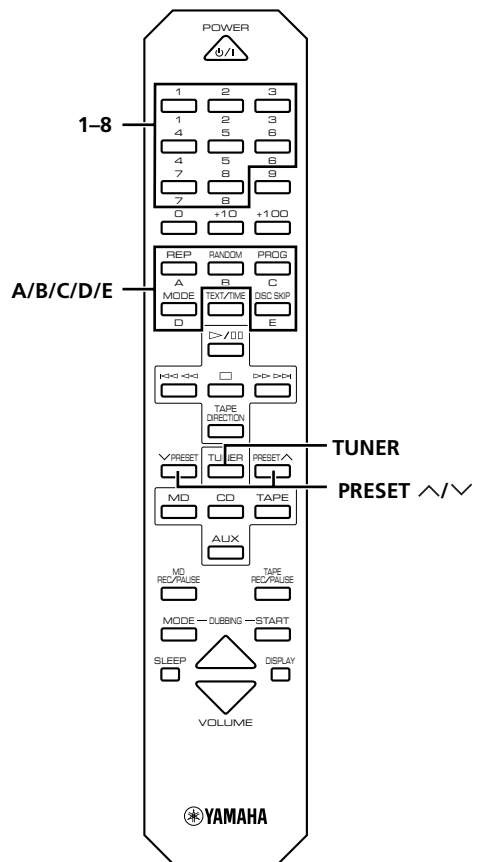

Before using the timer

If you want to use the cassette deck, KX-E300 or the MD Recorder, MDX-E300 for timer play or recording, you must first make the connections as shown in "Connecting the system" on page 6. For details, refer to the instructions supplied with the MDX-E300 or KX-E300.

Timer play and recording

By using the built-in timer, you can have the unit turn on at a specified time and begin playing or recording automatically. You can also specify the turn off time.

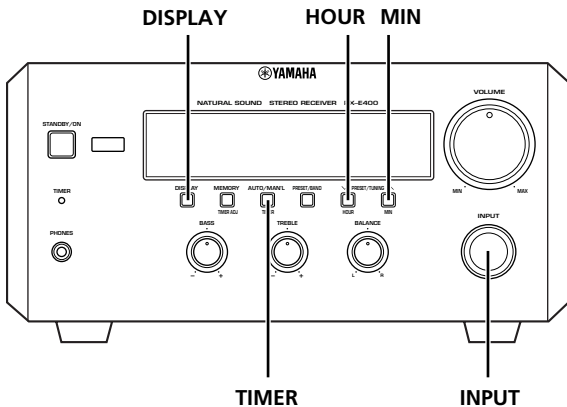

1 Press **DISPLAY**.
Whenever **DISPLAY** is pressed, the display mode changes as follows:

1. Clock Time (TIMER on/off mode)
If you have not set the clock yet "Set Clock" appears. You need to set the current time as described on page 7.

2. Timer Input
Select the source to be played by turning **INPUT**.
 - Timer recording is possible only when you select TUNER or AUX.

3. Timer REC
Select the recording component by turning **INPUT**. If you like to enjoy timer play with TUNER or AUX, select "REC Mode OFF".

(Example)



4. ON Time
"ON Time" appears on the display for a second, and changed to the time setting mode.
Press **HOUR** to set the hour.
Press **MIN** to set the minute.
5. OFF Time
Set the time the same way as above.
If you set the ON time but not OFF time, the timer play or recording will finish automatically after an hour.

Notes

- The display mode will change in about 8 seconds. If the mode is changed before the setting is completed, call the mode again by pressing **DISPLAY** once or more.
- If you select the input other than TUNER and AUX on "2. Timer Input", "3. Timer REC" is skipped.

2 Press **TIMER** to complete the timer setting.
The system is put in the standby mode.

- **TIMER** indicator lights up.

If you continue using the system, press **STANDBY/ON** to turn on this unit.

To cancel the timer play setting

Press **DISPLAY** to show the current time, then press **TIMER** so that "TIMER" goes off from the display. You can also cancel by pressing **TIMER** in standby mode.

Note

- In the event of a power failure or when the AC power cord is disconnected for more than five minutes, you must reset the clock.

Sleep timer

The unit can be turned off automatically at a selected SLEEP time.

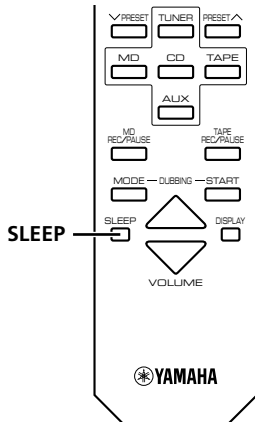

- 1 Play the desired sound source.
- 2 Press **SLEEP** repeatedly until the desired sleep time appears in the display. Each time you press **SLEEP**, the sleep time changes as follows:

SLEEP 2h00m



SLEEP 1h30m



SLEEP 1h00m



SLEEP 0h30m



SLEEP OFF

About 4 seconds after setting, the normal display will resume.

- “SLEEP” will appear in the display.

- 3 The unit will turn off automatically when the selected sleep time is reached.

Front panel

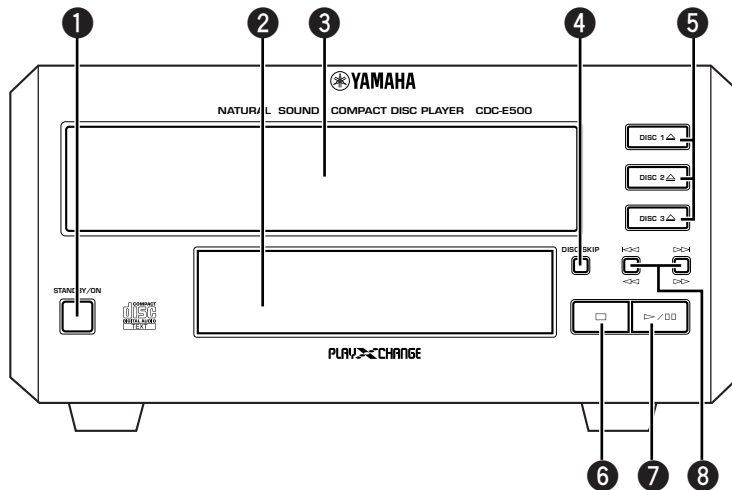

- ❶ **STANDBY/ON**
- ❷ **Display** (this page)
- ❸ **Disc tray** (P.17)
- ❹ **DISC SKIP** (P.18)
- ❺ **DISC 1/2/3** \triangle (Open/Close) (P.17)
- ❻ \square (Stop) (P.17)
- ❼ \triangleright/\square (Play/Pause) (P.17)
- ❽ \llcorner/\llcorner (Skip/Search Backward)
- $\triangleright/\triangleright$ (Skip/Search Forward) (P.17)

Display

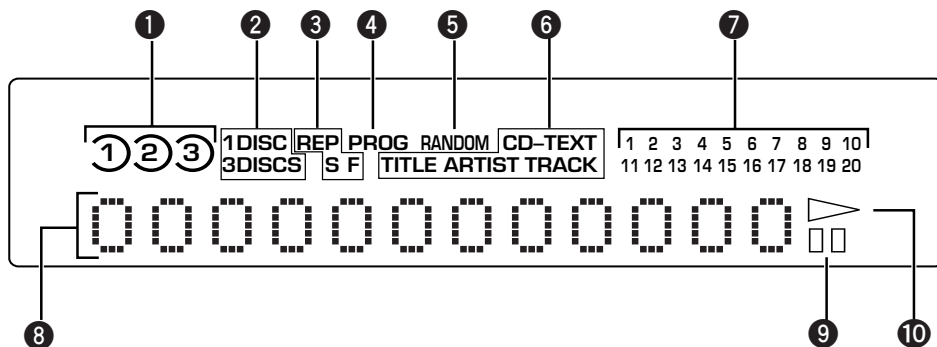

- ❶ **Disc indicator**
- ❷ **1 DISC/3 DISCS** (Disc play mode) indicator
- ❸ **REP S/F** (Single or Full) indicator (P.19)
- ❹ **PROG** indicator (P.20)
- ❺ **RANDOM** indicator (P.19)
- ❻ **CD-TEXT** indicator (P.18)
- ❼ **Music calendar**
- ❽ **Multi-information display**
- ❹ \square (Pause) indicator
- ❽ \triangleright (Play) indicator

Remote control

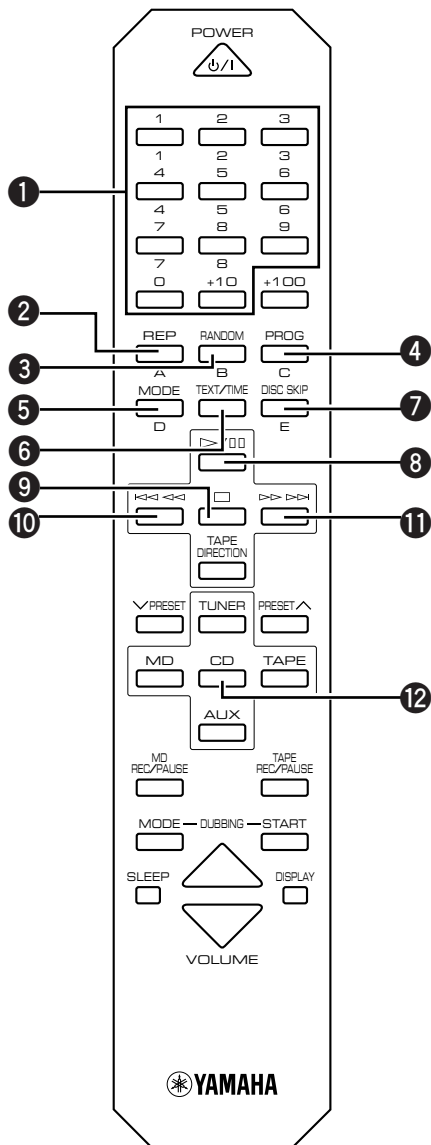

- 1** Numeric buttons (P.17)
 - +100 button is used when operating MDX-E300.
- 2** **REP** (Repeat) (P.19)
- 3** **RANDOM** (Random) (P.19)
- 4** **PROG** (Program) (P.20)
- 5** **MODE** (P.19)
- 6** **TEXT/TIME** (P.18)
- 7** **DISC SKIP** (P.18)
- 8** ▷/⏸ (Play/Pause) (P.17)
- 9** ◻ (Stop) (P.17)
- 10** ◀◀ ◀ (Skip/Search Backward) (P.17)
- 11** ▶ ▶▶ ▶ (Skip/Search Forward) (P.17)
- 12** **CD** input (P.17)

Playing a disc

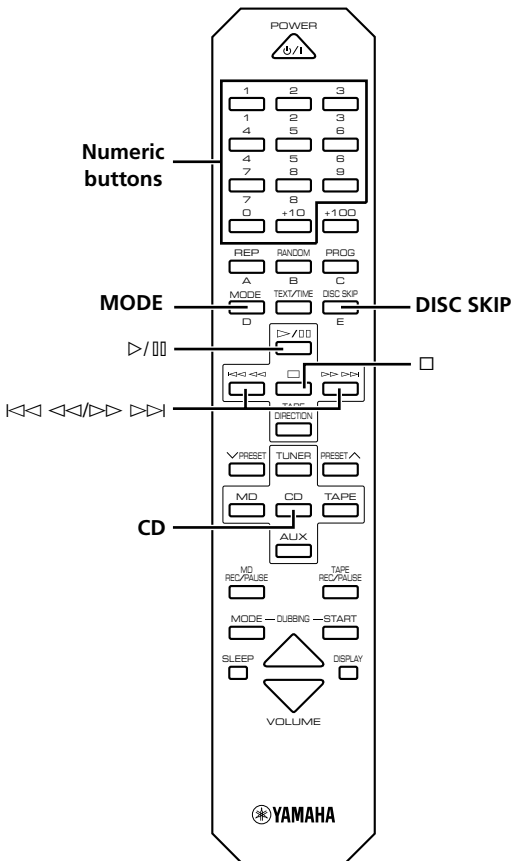
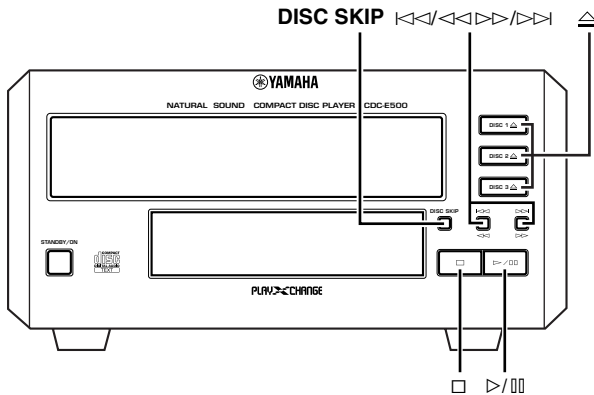

- 1 Turn on the power of RX-E400 and CDC-E500. (Refer to page 10.)
- 2 Press **CD** on the remote control in order to operate the CD player by the remote control.

- 3 Press **DISC 1**, **DISC 2** or **DISC 3** to open the disc tray, and place a CD on the tray.

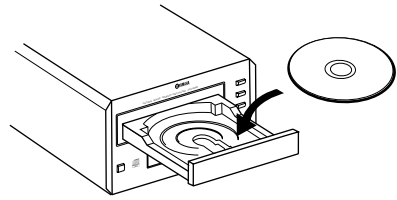

- 4 Press the selected disc's **DISC** button to close the disc tray. To insert other CDs, follow the same procedure.
- 5 Press **▷/||** to start play. This unit starts play.

To pause play

Press **▷/||**.
To resume play, press **▷/||** again.

To stop play

Press **□**.

To eject the CD

Press **△** to open the disc tray, and remove the CD from the tray.

To play a specific track on the disc (Skip)

Direct play

Select a desired track using the numeric button. (Example: To select 35, press +10 three times so that "3 -" appears in the display, then press 5.)

Skip play

Press **▷▷/▷▷** to skip forward or **◀◀/◀◀** to skip backward. Press once for each track to be skipped.

Notes

- You cannot enter a number that is higher than the last track number on the selected disc.
- These operations can also be performed when the unit is in the pause or stop mode.
- During stop mode, if **▷▷/▷▷** or **◀◀/◀◀** is pressed, the track number successively changes to higher numbers (or lower numbers).

To advance or reverse playback rapidly (Search)

Press and hold **▷▷/▷▷** to advance playback rapidly, and **◀◀/◀◀** to reverse playback rapidly.

Note

- This unit cannot play a CD-R or CD-RW disc unless the disc is finalized. Please make sure to finalize the disc on the CD recorder before playing on this unit.

To change the disc play mode

If necessary, change the disc play mode by pressing **MODE** on the remote control.

All disc play mode: All disc on the disc tray are played sequentially.



Single disc play mode: Only the designated disc is played.



To select another disc

Press **DISC SKIP** once or more. The circle around the selected disc number lights up.

(Example) When the disc 2 is selected.



To exchange a disc (or discs) while playing (PLAY X CHANGE)

You can open the disc tray without interrupting play by pressing one of **DISC 1/2/3** (not the currently playing one).

Selecting the time display and CD TEXT

You can select any of four time displays by pressing **TEXT/TIME**. When you play a CD with CD TEXT, the disc title, artist name, and track name are also displayed.

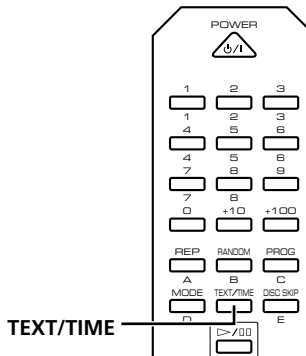

Each time you press **TEXT/TIME** the display changes as follows:

The current track number

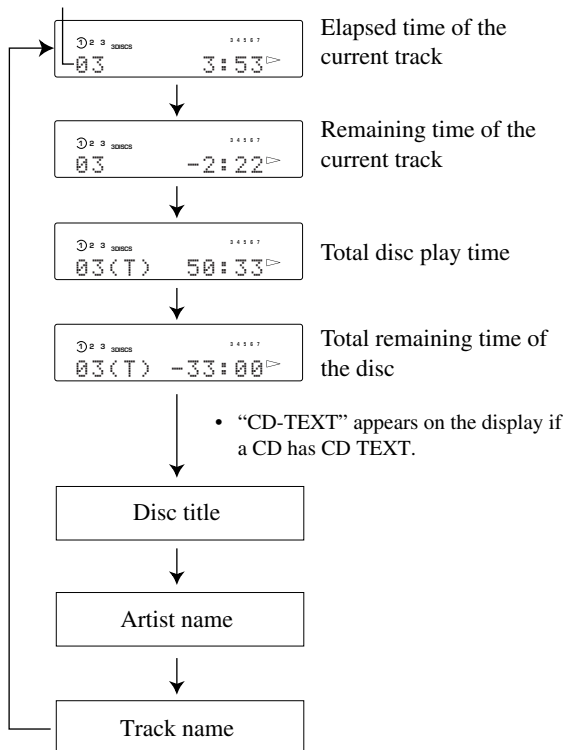

Note

- The disc title, artist names, or track names may not be displayed with some CD TEXT discs. In this case, "(NO ENTRY)" appears on the display for about two seconds and then go back to the time display.

Random-sequence play

The unit can play all the tracks in a random sequence.

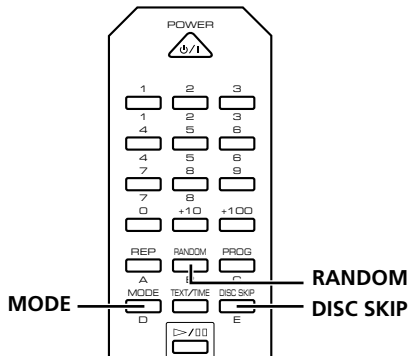

- 1** If necessary, switch the disc play mode by pressing **MODE**.
 - If the single disc play mode is selected, select the desired disc by pressing **DISC SKIP**.
- 2** Press **RANDOM**.
 - “RANDOM” appears on the display.
 - The unit starts random sequence play.

To cancel random-sequence play mode

- Press **□** or **RANDOM**.
- “RANDOM” disappears from the display.

Notes

- This feature will not function during programming, or during programmed play.
- If **▷▷/▷▷** is pressed during random-sequence play, the next randomly programmed track will be played.
If **◀◀/◀◀** is pressed, play will return to the beginning of the current track.
- Total remaining time on the disc will not be displayed during random-sequence play.

Repeat play

You can play any desired track or disc repeatedly.
Press **REP** to select the repeat mode.

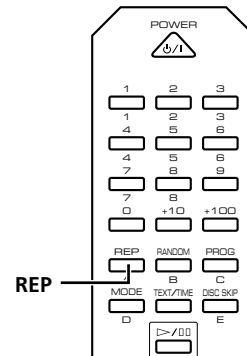

SINGLE REPEAT

The current track is played repeatedly.



FULL REPEAT

When the CD player is in the single disc play mode:

The designated disc is played repeatedly.

When the CD player is in the all disc play mode:

All discs on the disc tray are played repeatedly.



- In random-sequence play mode, all randomly sequenced tracks are played repeatedly in the same order.

To cancel repeat play mode

Press **REP** successively until “REP S” and “REP F” disappear from the display.

Program play

By creating a program, you can enjoy listening to your favourite tracks in any desired order. As many as 30 tracks can be programmed in sequence.

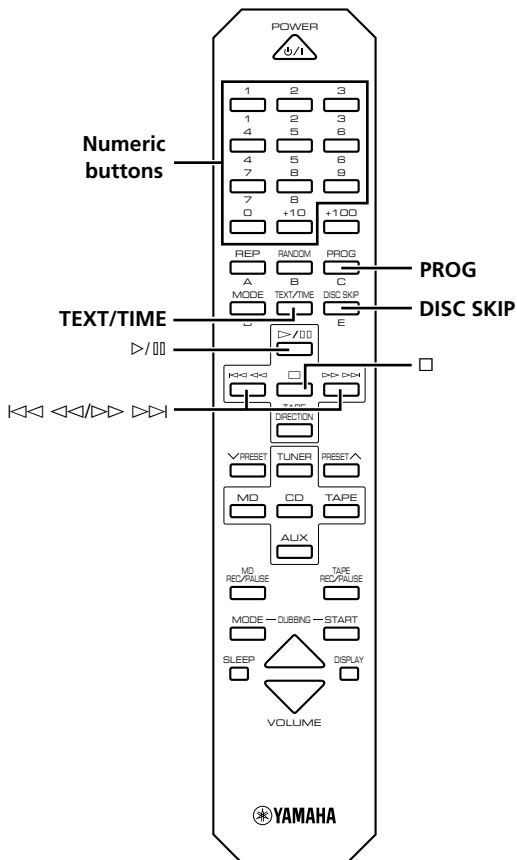

- 1 Press \square to stop the unit.
- 2 Press **PROG**.
 - “PROG” and “P-01” light up on the display, and all track numbers on the selected disc start flashing.

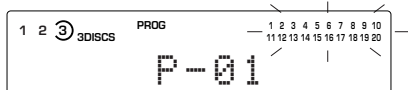

- 3 If necessary, select the desired disc by pressing **DISC SKIP**.
 - Just after you change the disc, the CD player reads the contents of the newly selected disc for a few seconds. If you go on to the next step during this internal operation, “WAIT” appears on the display and your operation is canceled.

- 4 Use the numeric buttons to select a track number.
 - The selected track number and the total play time of the programmed tracks appear on the display, and it will soon be replaced by the display of the next play order. Programmed track numbers on the selected disc will stop flashing and light up on the music calendar.
 - Pressing **TEXT/TIME** displays the total play time of the programmed tracks for about one second, and then it is replaced by the display of the next play order. When you program tracks of different discs, total play time does not include the time that takes to change discs.
- 5 Repeat steps 3 and 4 to program more tracks. You can select the same track again.
- 6 Press \triangleright/\square to start program play.

To stop program play mode

Press \square .

Note

- $\triangleright\triangleright/\triangleright\triangleright$ or $\ll\ll/\ll\ll$ can be used during program play to skip to tracks within the program.

To check program data

1. Press \square while the disc is playing to stop program play.
2. Press **PROG**. Then each time you press $\triangleright\triangleright/\triangleright\triangleright$ / $\ll\ll/\ll\ll$, the track number and the program number are displayed in the order of the program.

To change program data

1. Follow the preceding procedure described in “To check program data.”
2. Display the track number to be changed by pressing $\triangleright\triangleright/\triangleright\triangleright$ / $\ll\ll/\ll\ll$.
3. Press the numeric button of the desired track. The previously programmed track will be cleared from memory and the new one will be programmed.

To delete all program data

When program play is stopped, press \square .

Note

- Turning the unit to the standby mode or opening the disc tray also deletes the program data.

Controlling other components

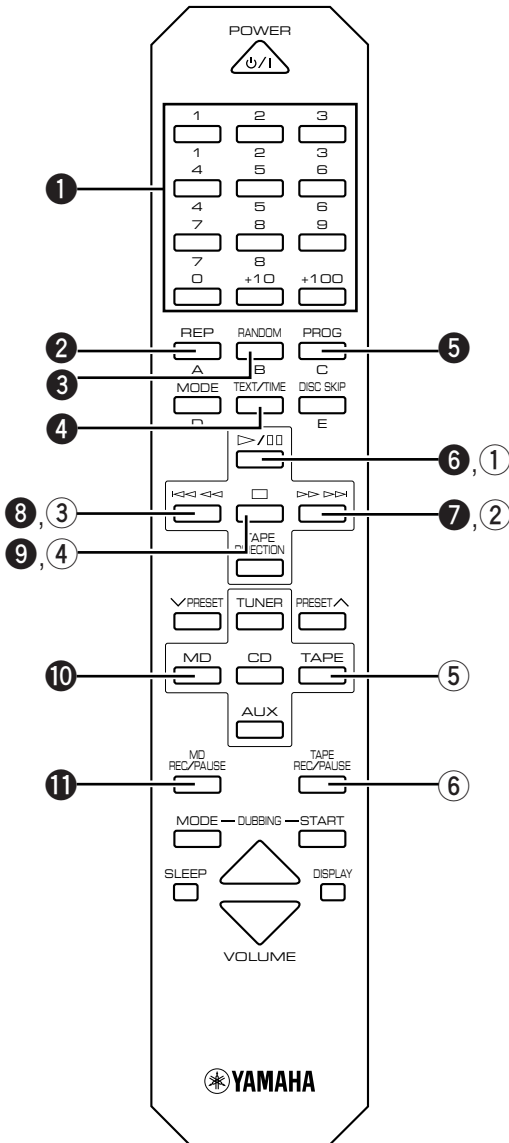

MDX-E300

- ❶ Numeric buttons
- ❷ REP (Repeat)
- ❸ RANDOM
- ❹ TEXT/TIME
- ❺ PROG (Program)
- ❻ ▷/⏸ (Play/Pause)
- ❼ ▷▷ ▷▷ (Skip/Search Forward)
- ❽ ⏪ ⏩ (Skip/Search Backward)
- ❾ □ (Stop)
- ❿ MD input
- ⓫ MD REC/PAUSE

KX-E300

- ❶ ▷/⏸ (Play)
- ❷ ▷▷ ▷▷ (Fast-forward)
- ❸ ⏪ ⏩ (Rewind)
- ❹ □ (Stop)
- ❺ TAPE input
- ❻ TAPE REC/PAUSE

Before recording

When you record by using MDX-E300 or KX-E300, you must first make the connections as shown in "Connecting the system" on page 6. For details, refer to the instructions supplied with the MDX-E300 or KX-E300. A source from the component which is connected to the **AUX** terminal component can be recorded on a tape or MD.

CD synchronized recording

You can start and stop recording a CD on a MD or a tape by pressing just one button.

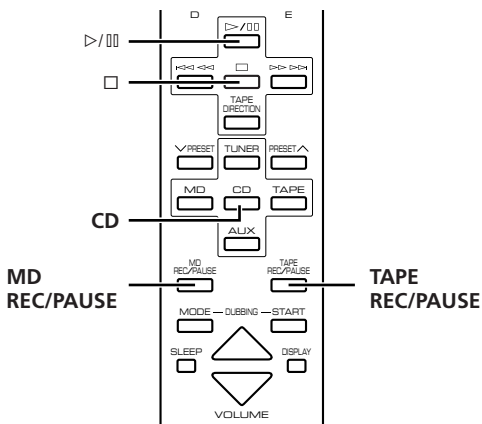

- 1 Press **CD**.
- 2 Press **MD REC/PAUSE** to record on a MD or **TAPE REC/PAUSE** to record on a tape.
- 3 Press **>/|||**.
Recording starts automatically on MDX-E300 or KX-E300.

To stop recording

- Press **□**.
- Pressing **□** on CDC-E500 stops CD play and turn the recording component into "REC standby" mode.
 - Pressing **□** on MDX-E300 or KX-E300 stops recording, while the CD player keeps on playing.

Note

- Recording does not pause while CDC-E500 changes discs. When recording the tracks of different discs, it is recommended to set the CD player to single disc play mode and record the discs individually. When recording the programmed sequence of the tracks of different discs, make sure that the length of the MD or the tape is longer than the total play time of the programmed tracks, so that it is enough to cover the time for changing discs.

Dubbing setting

There are six different combinations of components. Once you choose a certain mode, recording starts and ends automatically in a certain way for each mode.

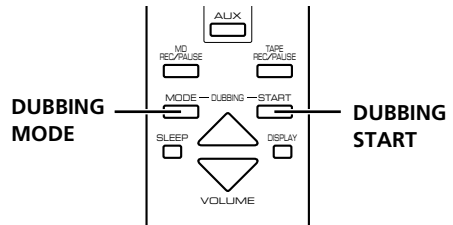

- 1 Decide the combination of the components. Each time you press **DUBBING MODE**, the mode will change in the below order.



- Recording automatically starts from the beginning of the tape. (By pressing **DUBBING START**, the tape automatically rewinds to the beginning if it is in the middle.)
- When the recording on side A finishes while a track is being played back, the recording on side B starts from the beginning of the same track.
- The sound is automatically faded out when it gets close to the end of side B.

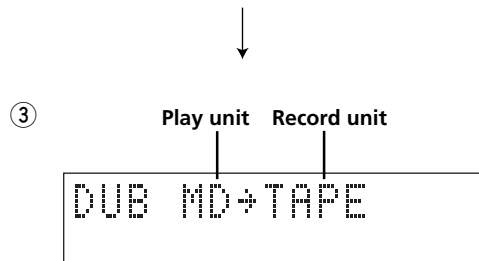
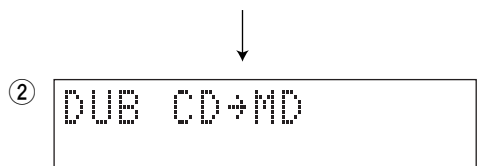

- Same as CD → TAPE

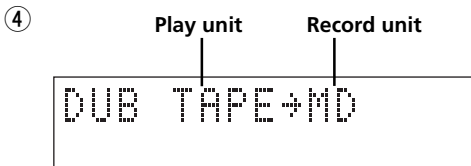

- Recording automatically starts at the beginning of the tape. (By pressing **DUBBING START**, the tape automatically rewinds to the beginning if it is in the middle.)

2 Press **DUBBING START** to start recording.

Note

- The displays ①~④ which include the component you have not connected to your receiver (RX-E400) will be skipped.
- Recording does not pause while CDC-E500 changes discs. When recording the tracks of different discs, it is recommended to set the CD player to single disc play mode and record the discs individually. When recording the programmed sequence of the tracks of different discs, make sure that the length of the MD or the tape is longer than the total play time of the programmed tracks, so that it is enough to cover the time for changing discs.

To stop dubbing

Press □.

Troubleshooting

If the unit fails to operate normally, check the following points to determine whether the fault can be corrected by the simple measures suggested. If it cannot be corrected, or if the fault is not listed in the SYMPTOM column, disconnect the power cord and contact your authorized YAMAHA dealer or service center for help. When taking the service, the MDX-E300 or KX-E300 may be needed. For details, contact your authorized YAMAHA dealer or service center.

	SYMPTOM	CAUSE	REMEDY
RX-E400 RECEIVER	The unit does not switch ON when the STANDBY/ON is pressed.	The AC power cord is not connected or not completely connected.	Securely connect the power cord.
	No sound from one speaker.	Loose speaker connections.	Connect properly.
	The sound suddenly goes off.	The protection circuit has been activated because of a short circuit, etc.	Check the speaker wires are not touching each other and then turn the unit back on.
	No sound from an external unit connected with this unit or play does not begin.	Incorrect cord connections.	Connect the cords properly. If the problem persists, the cords may be defective.
		Input source selection is not proper.	Make a proper input source selection.
	Sound distorted.	The component connected to this unit is disconnected from AC outlet.	Connect the AC power cord of the component to an AC outlet.
	Excessive static in FM broadcasts.	Interference from starting motor of a nearby car.	Position the FM antenna as high and as far away from nearby roads as possible. Connect using a coaxial cable.
		Interference from the thermostat of a nearby electrical appliance.	
	Noise increases during stereo broadcasts.	Antenna input is too weak due to obstructions or excessive distance from the broadcasting station.	Check the antenna connection.
			Install a multi-element type FM antenna if possible.
	Stereo broadcasts are noisy and STEREO indicator blinks on and off.	Insufficient antenna input.	Install an antenna appropriate for the electric field strength of your area.
	Cannot select preset stations.	Preset memory has been erased.	Reprogram memory presets.
	Buzzing or static during AM broadcasts.	Interference from sources such as lightning, fluorescent lights, electric motors or thermostat of nearby electrical appliance.	The problem is difficult to eliminate, but can be lessened by grounding AM loop antenna.
		TV or microprocessor is being used nearby.	Move away from TV or microprocessor.
	AM broadcast sensitivity is poor.	Radio signal is weak or the antenna is not properly connected.	Properly connect the AM loop antenna.
Change orientation of the AM loop antenna.			
Install an external AM loop antenna.			
Cannot set timer.	Current time is not set.	Set current time.	
The unit does not work normally.	The internal microcomputer has been frozen by an external electric shock (lightning, excessive static electricity, etc.) or the power supply with low voltage.	Unplug the AC power cord from the wall outlet, and then plug in again after about one minute.	

	SYMPTOM	CAUSE	REMEDY
CDC-E500 CD PLAYER	Play does not begin.	The disc is damaged.	Check the disc carefully; replace it if necessary.
		There is moisture on the laser pick-up.	Wait 20 to 30 minutes after switching the unit ON before trying to play a disc.
		The disc has been loaded upside down.	Reload the disc with the label side facing up.
		The disc is dirty.	Clean the disc.
	Play is delayed, or begins at the wrong place.	The disc may be scratched or damaged.	Check the disc carefully; replace it if necessary.
	CD synchronized recording or Automatic recording function does not work.	The system cable is not connected securely.	Connect the system cable properly.
	Sound "skips."	The unit is being subjected to vibrations or impacts.	Relocate the unit.
		The disc is dirty.	Clean the disc.
Sound "hums."	Improper cable connections.	Securely connect the audio cables. If the problem persists, the cables may be defective.	
Noise from inside of the unit.	The disc may be warped.	Replace the disc.	
REMOTE CONTROL	The remote control does not work.	The batteries of the remote control are too weak.	Replace the batteries with new ones.
		Remote control is too far away or is being used at an incorrect angle.	Use within 6 meters and 60 degree radius.
		Direct sunlight or lighting (of an inverter type of fluorescent lamp, etc.) is striking the remote control sensor of the unit.	Change the position of the unit.
	TV functions strangely when the remote control is being used.	Remote control is being used near TV set with a remote control sensor.	Relocate this unit away from the TV or cover the TV's remote control sensor.

Specifications

<RX-E400>

Amplifier section

Minimum RMS output power per channel	
..... 55 W + 55 W (6Ω 1kHz 0.1% THD)	
..... 40 W + 40 W (6Ω 20 Hz to 20 kHz 0.1% THD)	
DIN Standard output power per channel (Europe model)	
..... 60 W + 60 W (4Ω 1kHz 0.7% THD)	
Input sensitivity/Impedance	
CD/TAPE/MD/AUX	150 mV/47 kΩ
Frequency response	
CD etc.	20 Hz to 20 kHz, ±0.5 dB
Total Harmonic Distortion (20 Hz to 20 kHz)	
CD etc. 20 W, 6 Ω	0.04%
Signal-to-Noise ratio (HF-A Network)	
CD etc. (250 mV, Input shorted)	98 dB
Output level/Impedance	
PHONES	0.43 V/330 Ω

Tuner section

Tuning range	
FM	
[U.S.A. and Canada models]	87.5 – 107.9 MHz
[U.K., Europe, Australia and General models]	
.....	87.50 – 108.00 MHz
AM	
[U.S.A. and Canada models]	530 – 1710 kHz
[U.K., Europe and Australia models]	531 – 1611 kHz
[General model]	530/531 – 1710/1611 kHz
Sensitivity	
FM (S/N 30dB)	1.0 μV
AM	300 μV/m

General

Power supply	
[U.S.A. and Canada models]	AC 120 V, 60 Hz
[Australia model]	AC 240 V, 50 Hz
[U.K. and Europe models]	AC 230 V, 50 Hz
[General model]	AC 110/120/220/240 V, 50/60 Hz
Power consumption	
[U.S.A. and Canada models]	110 W
[U.K., Europe, Australia and General models]	125 W
Power consumption (standby mode)	
[U.S.A. and Canada models]	0.7 W
[U.K., Europe and Australia models]	0.8 W
Dimensions (W x H x D)	217 x 108 x 372 mm
Weight	5.4 kg

<CDC-E500>

CD player section

D/A converter	S-bit DAC
Frequency response	2 Hz to 20 kHz, ±0.5 dB
S/N ratio	102 dB

Laser diode properties

- Material: GaAlAs
- Wavelength: 780 nm
- Emission duration: continuous
- Laser output: max. 44.6 μW*

* This output is the value measured at a distance of about 200 mm from the objective lens surface on the Optical Pick-up Block.

General

Power supply	
[U.S.A. and Canada models]	AC 120 V, 60 Hz
[Australia model]	AC 240 V, 50 Hz
Power consumption	13 W
Power consumption (standby mode)	3.8 W
Dimensions (W x H x D)	217 x 108 x 347 mm
Weight	3.5 kg

Specifications are subject to change without notice.



YAMAHA ELECTRONICS CORPORATION, USA 6660 ORANGETHORPE AVE., BUENA PARK, CALIF. 90620, U.S.A.
YAMAHA CANADA MUSIC LTD. 135 MILNER AVE., SCARBOROUGH, ONTARIO M1S 3R1, CANADA
YAMAHA ELECTRONIK EUROPA G.m.b.H. SIEMENSSTR. 22-34, 25462 RELINGEN BEI HAMBURG, F.R. OF GERMANY
YAMAHA ELECTRONIQUE FRANCE S.A. RUE AMBROISE CROIZAT BP70 CROISSY-BEAUBOURG 77312 MARNE-LA-VALLEE CEDEX02, FRANCE
YAMAHA ELECTRONICS (UK) LTD. YAMAHA HOUSE, 200 RICKMANSWORTH ROAD WATFORD, HERTS WD1 7JS, ENGLAND
YAMAHA SCANDINAVIA A.B. J A WETTERGRENS GATA 1, BOX 30053, 400 43 VÄSTRA FRÖLUNDA, SWEDEN
YAMAHA MUSIC AUSTRALIA PTY, LTD. 17-33 MARKET ST., SOUTH MELBOURNE, 3205 VIC., AUSTRALIA

YAMAHA CORPORATION

Printed in Malaysia © V963100

Free Manuals Download Website

<http://myh66.com>

<http://usermanuals.us>

<http://www.somanuals.com>

<http://www.4manuals.cc>

<http://www.manual-lib.com>

<http://www.404manual.com>

<http://www.luxmanual.com>

<http://aubethermostatmanual.com>

Golf course search by state

<http://golfingnear.com>

Email search by domain

<http://emailbydomain.com>

Auto manuals search

<http://auto.somanuals.com>

TV manuals search

<http://tv.somanuals.com>