



YAMAHA CRX-M5

CD Changer Receiver

Ampli-Tuner/CD



**OWNER'S MANUAL
MODE D'EMPLOI**

SAFETY INSTRUCTIONS

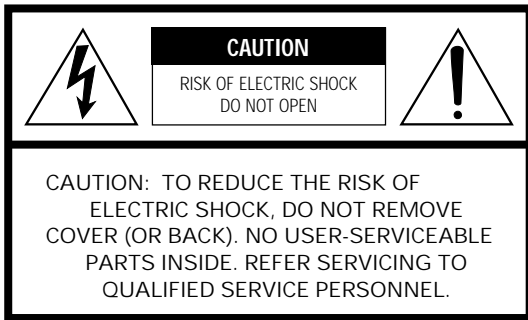

• Explanation of Graphical Symbols

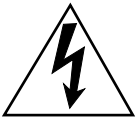

The lightning flash with arrowhead symbol, within an equilateral triangle, is intended to alert you to the presence of uninsulated "dangerous voltage" within the product's enclosure that may be of sufficient magnitude to constitute a risk of electric shock to persons.



The exclamation point within an equilateral triangle is intended to alert you to the presence of important operating and maintenance (servicing) instructions in the literature accompanying the appliance.

WARNING

TO REDUCE THE RISK OF FIRE OR ELECTRIC SHOCK, DO NOT EXPOSE THIS UNIT TO RAIN OR MOISTURE.

IMPORTANT!

Please record the serial number of this unit in the space below.

Model:
Serial No.:

The serial number is located on the rear of the unit. Retain this Owner's Manual in a safe place for future reference.

- 1** Read Instructions – All the safety and operating instructions should be read before the unit is operated.
- 2** Retain Instructions – The safety and operating instructions should be retained for future reference.
- 3** Heed Warnings – All warnings on the unit and in the operating instructions should be adhered to.
- 4** Follow Instructions – All operating and other instructions should be followed.
- 5** Water and Moisture – The unit should not be used near water – for example, near a bathtub, washbowl, kitchen sink, laundry tub, in a wet basement, or near a swimming pool, etc.
- 6** Carts and Stands – The unit should be used only with a cart or stand that is recommended by the manufacturer.
- 6A** A unit and cart combination should be moved with care. Quick stops, excessive force, and uneven surfaces may cause the unit and cart combination to overturn.
- 7** Wall or Ceiling Mounting – The unit should be mounted to a wall or ceiling only as recommended by the manufacturer.
- 8** Ventilation – The unit should be situated so that its location or position does not interfere with its proper ventilation. For example, the unit should not be situated on a bed, sofa, rug, or similar surface, that may block the ventilation openings; or placed in a built-in installation, such as a bookcase or cabinet that may impede the flow of air through the ventilation openings.
- 9** Heat – The unit should be situated away from heat sources such as radiators, stoves, or other appliances that produce heat.
- 10** Power Sources – The unit should be connected to a power supply only of the type described in the operating instructions or as marked on the unit.
- 11** Power-Cord Protection – Power-supply cords should be routed so that they are not likely to be walked on or pinched by items placed upon or against them, paying particular attention to cords at plugs, convenience receptacles, and the point where they exit from the unit.
- 12** Cleaning – The unit should be cleaned only as recommended by the manufacturer.
- 13** Nonuse Periods – The power cord of the unit should be unplugged from the outlet when left unused for a long period of time.
- 14** Object and Liquid Entry – Care should be taken so that objects do not fall into and liquids are not spilled into the inside of the unit.
- 15** Damage Requiring Service – The unit should be serviced by qualified service personnel when:
 - A.** The power-supply cord or the plug has been damaged; or
 - B.** Objects have fallen, or liquid has been spilled into the unit; or
 - C.** The unit has been exposed to rain; or
 - D.** The unit does not appear to operate normally or exhibits a marked change in performance; or
 - E.** The unit has been dropped, or the cabinet damaged.
- 16** Servicing – The user should not attempt to service the unit beyond those means described in the operating instructions. All other servicing should be referred to qualified service personnel.
- 17** Power Lines – An outdoor antenna should be located away from power lines.
- 18** Grounding or Polarization – Precautions should be taken so that the grounding or polarization is not defeated.



19 For U.S. customers only:

Outdoor Antenna Grounding – If an outside antenna is connected to this unit, be sure the antenna system is grounded so as to provide some protection against voltage surges and built-up static charges. Article 810 of the National Electrical Code, ANSI/NFPA 70, provides information with regard to proper grounding of the mast and supporting structure, grounding of the lead-in wire to an antenna discharge unit, connection to grounding electrodes, and requirements for the grounding electrode.

Note to CATV system installer:

This reminder is provided to call the CATV system installer's attention to Article 820-40 of the NEC that provides guidelines for proper grounding and, in particular, specifies that the cable ground shall be connected to the grounding system of the building, as close to the point of cable entry as practical.

EXAMPLE OF ANTENNA GROUNDING

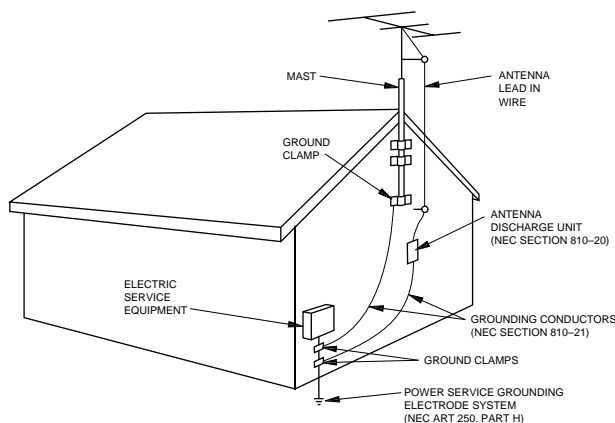

NEC – NATIONAL ELECTRICAL CODE

FCC INFORMATION (for US customers only)**1. IMPORTANT NOTICE: DO NOT MODIFY THIS UNIT!**

This product, when installed as indicated in the instructions contained in this manual, meets FCC requirements. Modifications not expressly approved by Yamaha may void your authority, granted by the FCC, to use the product.

2. IMPORTANT: When connecting this product to accessories and/or another product use only high quality shielded cables. Cable/s supplied with this product **MUST** be used. Follow all installation instructions. Failure to follow instructions could void your FCC authorization to use this product in the USA.**3. NOTE:** This product has been tested and found to comply with the requirements listed in FCC Regulations, Part 15 for Class "B" digital devices. Compliance with these requirements provides a reasonable level of assurance that your use of this product in a residential environment will not result in harmful interference with other electronic devices.

This equipment generates/uses radio frequencies and, if not installed and used according to the instructions found in the users manual, may cause interference harmful to the operation of other electronic devices.

Compliance with FCC regulations does not guarantee that interference will not occur in all installations. If this product is found to be the source of interference, which can be determined by turning the unit "OFF" and "ON", please try to eliminate the problem by using one of the following measures:

Relocate either this product or the device that is being affected by the interference.

Utilize power outlets that are on different branch (circuit breaker or fuse) circuits or install AC line filter/s.

In the case of radio or TV interference, relocate/reorient the antenna. If the antenna lead-in is 300 ohm ribbon lead, change the lead-in to coaxial type cable.

If these corrective measures do not produce satisfactory results, please contact the local retailer authorized to distribute this type of product. If you can not locate the appropriate retailer, please contact Yamaha Electronics Corp., U.S.A. 6660 Orangethorpe Ave, Buena Park, CA 90620.

The above statements apply **ONLY** to those products distributed by Yamaha Corporation of America or its subsidiaries.

We Want You Listening For A Lifetime

YAMAHA and the Electronic Industries Association's Consumer Electronics Group want you to get the most out of your equipment by playing it at a safe level. One that lets the sound come through loud and clear without annoying blaring or distortion – and, most importantly, without affecting your sensitive hearing. Since hearing damage from loud sounds is often undetectable until it is too late, YAMAHA and the Electronic Industries Association's Consumer Electronics Group recommend you to avoid prolonged exposure from excessive volume levels.



SUPPLIED ACCESSORIES
ACCESSOIRES FOURNIS

- After unpacking, check that the following parts are contained.
- Après le déballage, vérifier que les pièces suivantes sont incluses.

- Remote control transmitter
- Télécommande

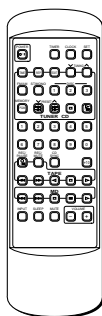

- AM loop antenna
- Cadre-antenne AM

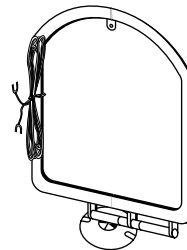

- Batteries (size AAA, UM/SEM-4, R7, HP-8)
- Piles (format AAA, UM/SEM-4, R7, HP-8)

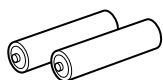

- Indoor FM antenna
- Antenne intérieure FM



**FRONT PANEL
PANNEAU AVANT**

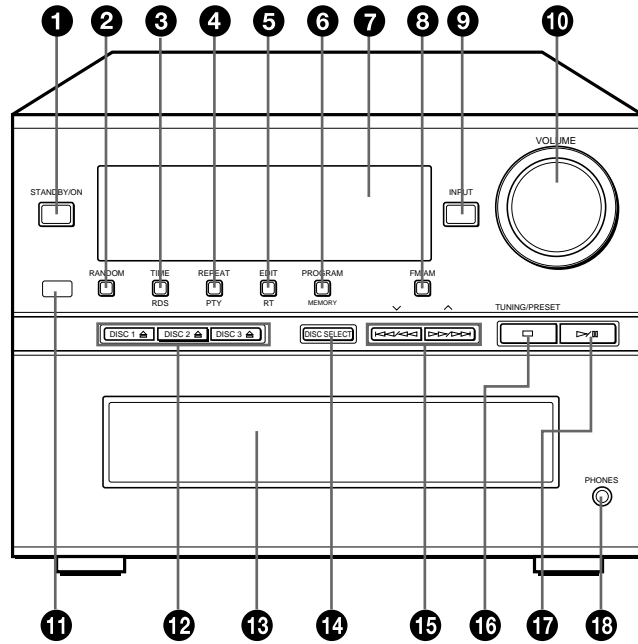

**REAR PANEL
PANNEAU ARRIERE**

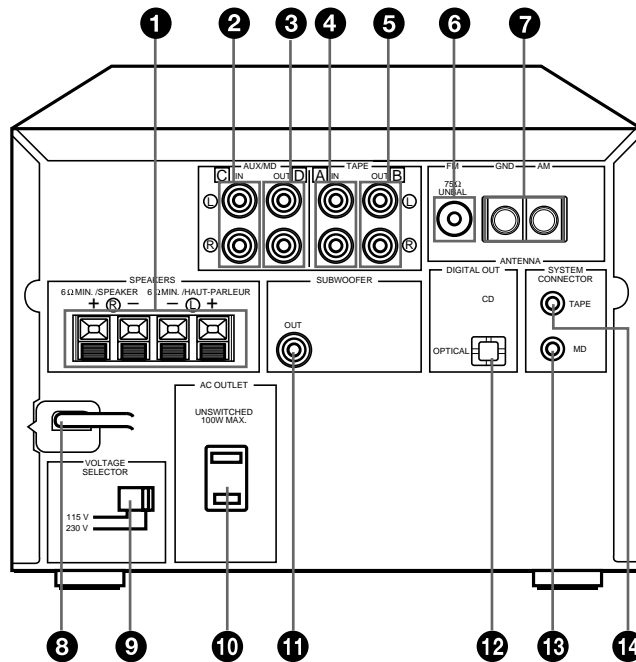

(General model)
(Modèle général)

DISPLAY PANNEAU D'AFFICHAGE

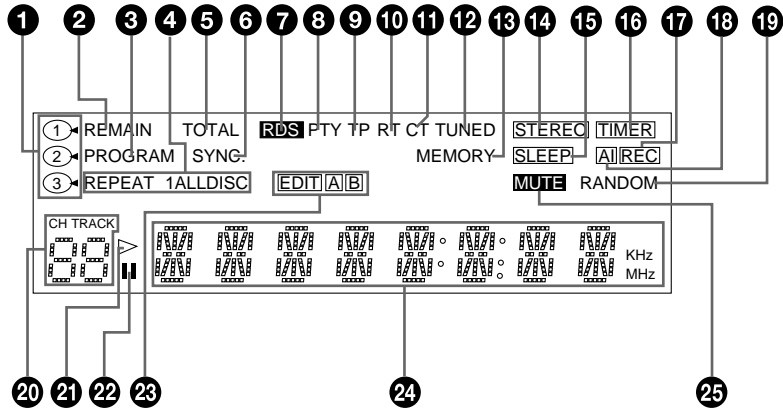

REMOTE CONTROL TRANSMITTER TELECOMMANDE

For U.K. and Europe models
Modèles pour l'Europe et le R.-U.

For U.S.A., Canada, Australia, Singapore, and General models
Modèles pour les Etats-Unis, le Canada, l'Australie, Singapour et modèles général

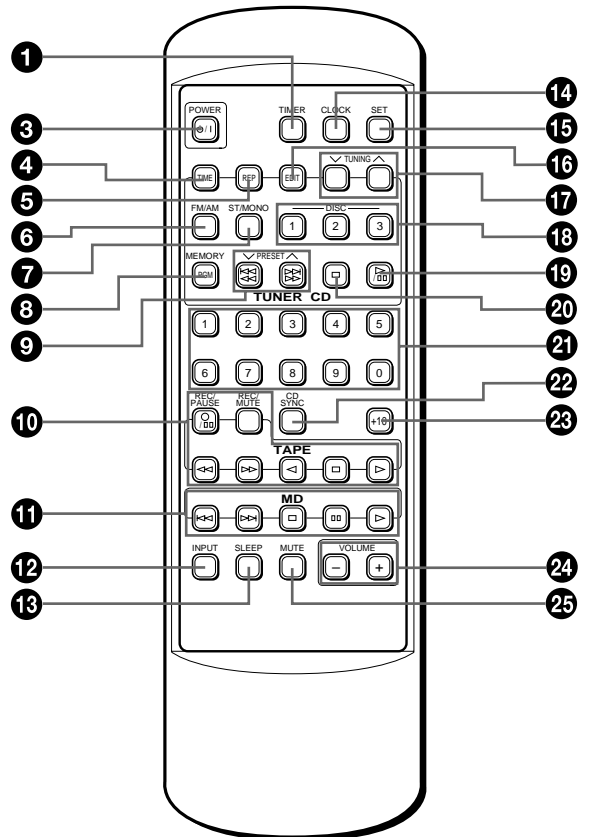
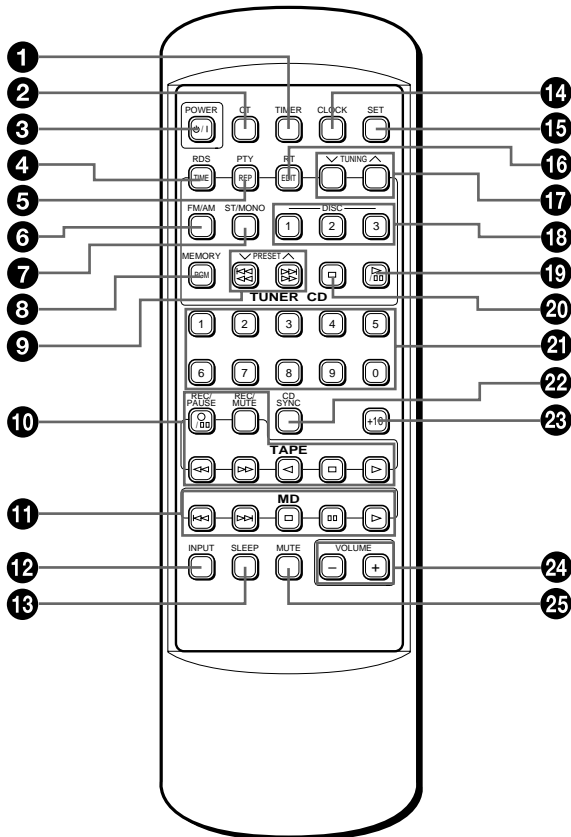

INTRODUCTION

Thank you for purchasing this YAMAHA product. We hope it will give you many years of trouble-free enjoyment. For the best performance, read this manual carefully. It will guide you in operating your YAMAHA product.

FEATURES

The System

- **Minimum RMS Output power per channel**
15 W + 15 W (6Ω 1KHz 0.1% THD)
- **Maximum POWER**
20 W + 20 W (6Ω 1KHz 10% THD)
- **Full Operation Remote control**
- **Multi-Use Timer/Sleep Timer**
- **2 External Audio Component Connecting capability**
- **SUBWOOFER Output Terminal Which Passes Low Frequencies Only**
- **Optical Digital Output**

Tuner

- **30 station Random Access Preset Tuning**
- **Multi-Functions for RDS Broadcast Reception (U.K. and Europe models only)**

Compact Disc Player

- **3-Disc CD changer**
- **Random Access Programmable Play**
- **Random-Sequence Play**
- **Single Disc/All Discs Repeat Play**
- **Automatic Synchronized Recording Using the MDX-M5 or KX-M5**
- **Automatic CD Editing Function for Recording to the KX-M5**

CONTENTS

PRECAUTIONS	2	USING THE BUILT-IN TIMER	
NAMES OF BUTTONS, CONTROLS, AND INDICATORS	3	Before using the timer	18
GETTING STARTED		Timer play	18
Connecting the system	4	Timer recording radio programs using the MDX-M5 or KX-M5	19
Connecting other components	5	Checking the timer setting	20
Preparing the remote control transmitter	6	Sleep timer operation	21
Setting the clock	7	OPERATING THE MDX-M5 OR KX-M5	
Turning on/off the unit	8	Listening to the MDX-M5 or KX-M5	22
Selecting the input source	8	RECORDING USING THE MDX-M5 OR KX-M5	
Adjusting the volume	8	Before recording	23
COMPACT DISC PLAYER OPERATIONS		CD synchronized recording	23
CD playback	9	Automatic CD edit recording for the KX-M5 ..	24
Selecting the time display	10	Manual recording	25
Random-sequence play	11	ADDITIONAL INFORMATION	
Repeat play	11	CD preventive care	26
Program play	12	Troubleshooting	26
TUNER OPERATIONS		Specifications	28
Listening to the radio	13		
Presetting stations	14		
RECEIVING RDS STATIONS (U.K. and Europe models only)			
What is RDS?	15		
Receiving RDS data	15		
Locating a station by PTY (Program Type)	17		

PRECAUTIONS: READ THIS BEFORE OPERATING THE UNIT

CAUTIONS

- To assure the finest performance, please read this manual carefully. Keep it in a safe place for future reference.
- Install your unit in good ventilation, a cool, dry, clean place – away from windows, heat sources, vibration, dust, moisture, or cold. To avoid humming sounds, locate the unit away from other electrical appliances, motors, and transformers. To prevent fire or electrical shock, do not expose to rain and water.
- (U.K., Europe, and Singapore models only)
Be sure to allow at least 30 cm combined ventilation space at the top, both of left and right, and back side of the unit.
- Do not operate the unit upside-down. It may overheat, possibly causing damage.
- Never open the cabinet. If something drops into the set, contact your dealer.
- Do not use force on switches, knobs or cords.
- Always set the VOLUME control to minimum before starting an audio source play: increase the volume gradually to an appropriate level after play has started.
- When not planning to use this unit for long periods of time (i.e., vacation, etc.), disconnect the AC power plug from the wall outlet.
- Grounding or polarization – Precautions should be taken so that the grounding or polarization of the unit is not defeated.
- Do not clean the unit with chemical solvents; this might damage the finish. Use a clean, dry cloth.
- Be sure to read the "TROUBLESHOOTING" section on common operating errors before concluding that your unit is faulty.
- Do not place another component on top of this unit, as damage or discoloration on the surface of the unit may result.
- To prevent damage by lightning, disconnect the power cord from the wall outlet during an electrical storm.
- When disconnecting the power cord from the wall outlet, grasp the plug; do not pull the cord.
- Do not plug the AC power plug to the wall outlet before you finish all connections.
- The voltage to be used must be the same as that specified on this unit. Using this unit with a higher voltage than that which is specified is dangerous and may result in a fire or other type of accident causing damage. YAMAHA will not be held responsible for any damage resulting from use of this unit with a voltage other than that which is specified.
- The sound level at a given volume setting depends on speaker location and other factors. Care should be taken to avoid exposure to sudden high levels of sound, which may occur when turning on the unit with the volume control setting at high, and to continuous high levels of sound.
- Sudden temperature changes and storage or operation in an extremely humid environment may cause condensation inside the cabinet.
- Keep this manual in a safe place for future reference.

This unit is not disconnected from the AC power source as long as it is connected to the wall outlet, even if this unit itself is turned off. This state is called the standby mode. In this state, this unit is designed to consume a very small quantity of power.

CAUTION FOR CARRYING THE UNIT

Before carrying the unit, first remove all discs from the unit, press STANDBY/ON to turn the unit off, then disconnect the AC power plug from the wall outlet.

FOR CANADIAN CUSTOMERS
TO PREVENT ELECTRIC SHOCK, MATCH WIDE
BLADE OF PLUG TO WIDE SLOT AND FULLY
INSERT.

THIS CLASS B DIGITAL APPARATUS COMPLIES
WITH CANADIAN ICES-003.

WARNING

To reduce the risk of fire or electric shock, do not expose this appliance to rain or moisture.

To avoid electrical shock, do not open the cabinet. Refer servicing to qualified personnel only.

DANGER

Invisible laser radiation when open and interlock failed or defeated.
Avoid direct exposure to beam.

CAUTION

Use of controls or adjustments or performance of procedures other than those specified herein may result in hazardous radiation exposure.

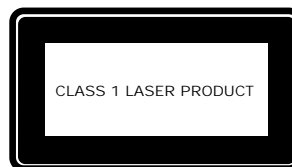

This compact disc player is classified as a CLASS 1 LASER product. The CLASS 1 LASER PRODUCT label is located on the rear exterior. (U.K., Europe, Singapore, Australia, and General models only.)

Laser component in this product is capable of emitting radiation exceeding the limit for Class 1.

FRONT PANEL (see the illustration on page 5)

- ❶ STANDBY/ON switch (8)
 - ❷ RANDOM button (11)
 - ❸ TIME/RDS button (10, 15)
 - ❹ REPEAT/PTY button (11, 17)
 - ❺ EDIT/RT button (24,16)
 - ❻ PROGRAM/MEMORY button (12, 14)
 - ❼ Display
 - ❽ FM/AM button (13)
 - ❾ INPUT button (8)
 - ❿ VOLUME control (8)
 - ⓫ Remote control sensor (7)
 - ⓬ DISC 1 – 3 \triangle (open/close) buttons (9)
 - ⓭ Disc tray (9)
 - ⓮ DISC SELECT button (9)
 - ⓯ $\blacktriangleleft/\blacktriangleright$ (skip)/ $\blacktriangleleft/\blacktriangleright$ (search)/PRESET \wedge/\vee buttons (10, 14)
 - ⓰ \blacksquare (stop)/TUNING/PRESET button (9, 13)
 - ⓱ $\blacktriangleright/\parallel$ (play/pause) button (9)
 - ⓲ PHONES jack (8)
- (RDS, PTY, and RT functions work on U.K. and Europe models only.)

REAR PANEL (see the illustration on page 5)

- ❶ SPEAKERS terminals (4)
- ❷ AUX/MD IN jacks (5)
- ❸ AUX/MD OUT jacks (5)
- ❹ TAPE IN jacks (5)
- ❺ TAPE OUT jacks (5)
- ❻ FM antenna terminal (4)
- ❼ AM antenna terminals (4)
- ❽ AC power cord (4)
- ❾ VOLTAGE SELECTOR switch (2) (General model only)
- ⓫ AC OUTLET (4) (U.S.A., Canada, Europe, General, and Singapore models only)
- ⓬ SUBWOOFER OUT jack (4)
- ⓭ DIGITAL OUT (OPTICAL) jack (5)
- ⓮ SYSTEM CONNECTOR MD jack (5)
- ⓯ SYSTEM CONNECTOR TAPE jack (5)

DISPLAY (see the illustration on page 6)

- ❶ DISC indicator (9)
- ❷ REMAIN indicator (10)
- ❸ PROGRAM indicator (12)
- ❹ REPEAT 1/DISC/ALL DISC indicator (11)
- ❺ TOTAL indicator (10)
- ❻ SYNC. indicator (23)
- ⓫ RDS indicator (15)
- ⓬ PTY indicator (15)
- ⓭ TP indicator (16)
- ⓮ RT indicator (16)
- ⓯ CT indicator (16)
- ⓰ TUNED indicator (13)
- ⓱ MEMORY indicator (14)
- ⓲ STEREO indicator (13)
- ⓳ SLEEP indicator (21)
- ⓴ TIMER indicator (18)
- ⓵ REC indicator (19)
- ⓶ AI indicator (19)
- ⓷ RANDOM indicator (11)
- ⓸ TRACK/CH indicator (10,14)
- ⓹ \triangleright (play) indicator (9)
- ⓺ \parallel (pause) indicator (9)
- ⓻ EDIT A/B indicator (24)
- ⓼ Multi information display
- ⓽ MUTE indicator (8)

U.K. and Europe models only

REMOTE CONTROL TRANSMITTER (see the illustration on page 6)

- ❶ TIMER button (18)
 - ❷ CT button (16) (U.K. and Europe models only)
 - ❸ POWER ϕ /I button (8)
 - ❹ TIME/RDS button (10, 15)
 - ❺ REP(repeat)/PTY button (11, 17)
 - ❻ FM/AM button (13)
 - ❼ ST/MONO button (13)
 - ❽ PGM/MEMORY button (12, 14)
 - ❾ $\blacktriangleleft/\blacktriangleright$ (skip)/ $\blacktriangleleft/\blacktriangleright$ (search)/PRESET \wedge/\vee buttons (10, 14)
 - ❿ Operation buttons for cassette deck
 - ⓫ Operation buttons for MD deck
 - ⓬ INPUT button (8)
 - ⓭ SLEEP button (21)
 - ⓮ CLOCK button (7)
 - ⓯ SET button (7)
 - ⓰ EDIT/RT button (24, 16)
 - ⓱ TUNING \wedge/\vee buttons (13)
 - ⓲ DISC 1– 3 buttons (9)
 - ⓳ $\blacktriangleright/\parallel$ (play/pause) button (9)
 - ⓴ \blacksquare (stop) button (9)
 - ⓵ Number buttons (10)
 - ⓶ CD SYNC button (23)
 - ⓷ + 10 button (10)
 - ⓸ VOLUME +/- buttons (8)
 - ⓹ MUTE button (8)
- (RDS, PTY, and RT functions work on U.K. and Europe models only.)

Connecting the system

Never plug the AC power cord to the wall outlet until all connections are completed. Follow the steps as shown below to connect the system using the supplied cords and accessories.

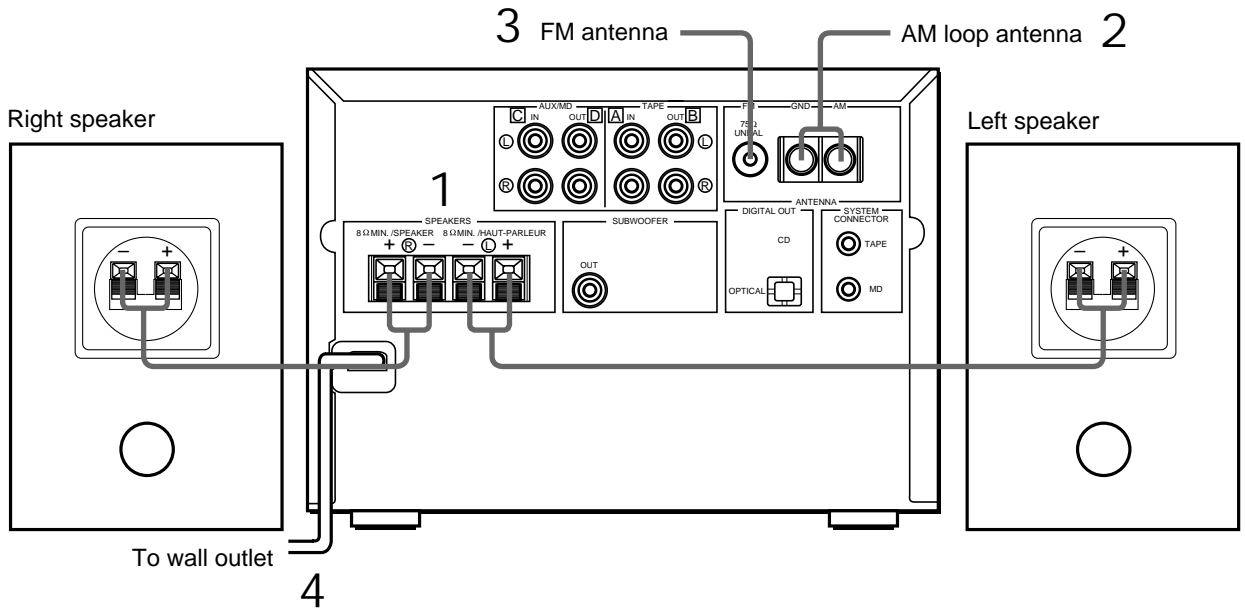

- 1** Connect the speakers.
Connect the speaker cords to the **SPEAKERS** terminals so that the polarity of the speaker cables is correct.
Keep the speaker cords away from the antennas to prevent noise.

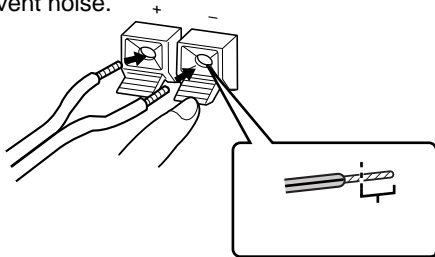

- 2** Connect the AM antenna.
Set up the AM loop antenna, then connect it.

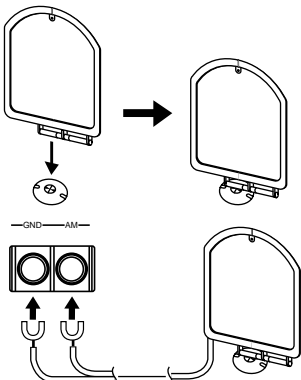

- 3** Connect the FM antenna.

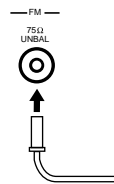

- 4** Connect the AC power cord to a wall outlet.

To connect the subwoofer (optional)
You can reinforce the bass frequencies by adding a subwoofer (optional).
Connect the **SUBWOOFER OUT** terminal of the unit to the **INPUT** terminal of the subwoofer amplifier, and connect the speaker terminals of the subwoofer amplifier to the subwoofer.
With some subwoofers, the amplifier and subwoofer are in the same unit.

AC outlet (U.S.A., Canada, Europe, General, Singapore models only)

You can connect the AC power plug of the other component up to 100W power. It is convenient to connect the MDX-M5 or KX-M5.

Connecting other components

To enhance your system, you can connect other components. Refer to the instructions of each component.

Connecting the KX-M5 (cassette deck) or MDX-M5 (MD deck)

- 1 Connect **A** to **A**, and **B** to **B** (for connecting the KX-M5), **C** to **C**, and **D** to **D** (for connecting the MDX-M5) using the audio connecting cords.
Insert the plugs into the jacks of the same color.
 - The audio connecting cords are the same, so you can connect **A**, **B**, **C**, or **D** using either cord.
- 2 Connect the unit and the KX-M5 or MDX-M5 with the system cable.
- 3 (MDX-M5 only)
Connect the OPTICAL DIGITAL OUT jack of the unit and the DIGITAL IN jack on the MDX-M5 with the optical fiber cable.

Note for digital connection

- Take off the covers of the optical fiber cable plug, the OPTICAL DIGITAL OUT jack, and the DIGITAL IN jack before digital connection.
- Be sure to replace the terminal's cover when the terminal on the rear panel is not being used, in order to protect from dust.

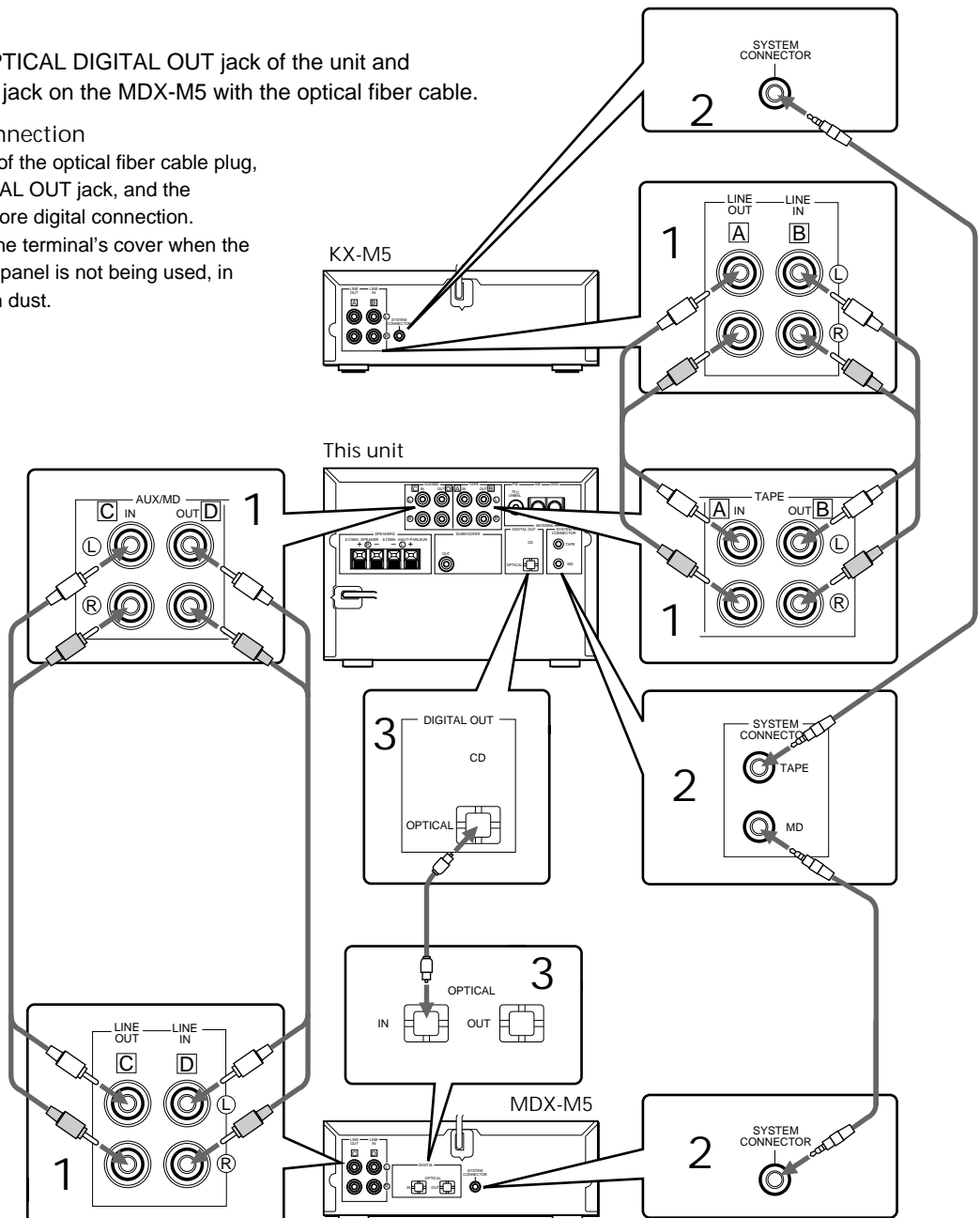

Connecting the external antennas

To improve the reception, connect the external antennas instead of the supplied antennas.

AM antenna

Use a 6 to 15 meter (20 to 50 feet) insulated wire to connect to the AM antenna terminal and leave the supplied AM loop antenna connected.

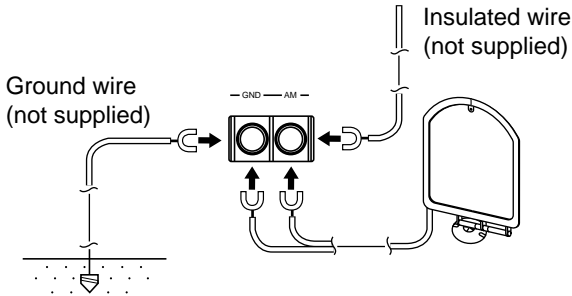

Important

When connecting an outdoor antenna, be sure to connect a ground wire also to protect against lightning. Be careful not to connect the ground wire to a gas pipe to prevent a gas explosion.

FM antenna

Connect the external antenna.

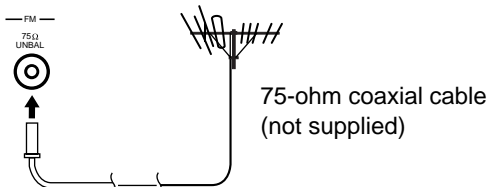

To enjoy synchro play or timer play

You can enjoy synchro recording (see page 23) or the timer function (see page 18) by connecting the MDX-M5 or KX-M5 to the system with the system cable. For details, refer to the instructions supplied with the MDX-M5 or KX-M5.

Preparing the remote control transmitter

Loading the batteries for the remote control transmitter

- 1 Remove the battery compartment cover.

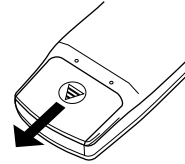

- 2 Insert 2 AAA size batteries into the battery compartment.

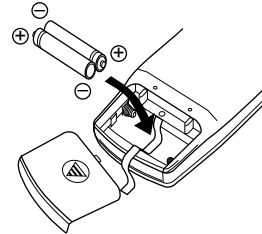

- 3 Replace the battery compartment cover.

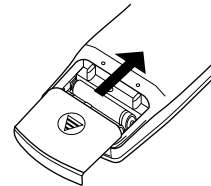

Battery replacement

If you find that the remote control transmitter must be used closer to the main unit than usual, the batteries are weak. Replace both batteries with new ones.

Notes

- Use only AAA batteries for replacement.
- Be sure the polarities are correct. (See the illustration inside the battery compartment.)
- Remove the batteries if the remote control transmitter will not be used for an extended period of time.
- If batteries leak, dispose of them immediately. Avoid touching the leaked material or letting it come in contact with clothing, etc. Clean the battery compartment thoroughly before installing new batteries.

Remote control transmitter operation range

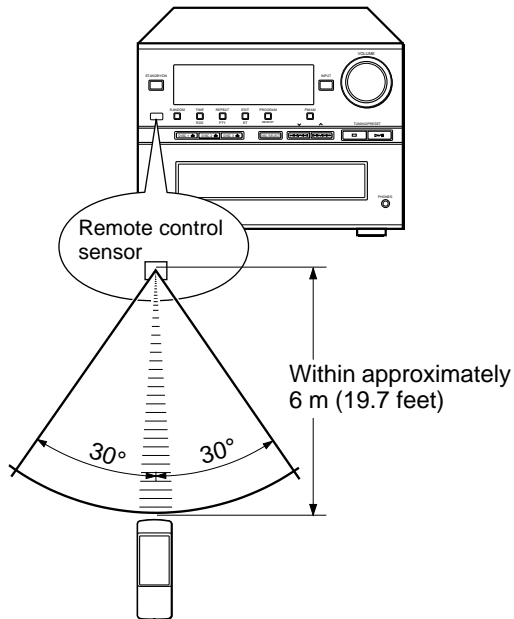

Notes

- There should be no large obstacles between the remote control transmitter and the main unit.
- If the remote control sensor is directly illuminated by strong lighting (especially an inverter type of fluorescent lamp etc.), it might cause the remote control transmitter not to work correctly. In this case, reposition the main unit to avoid direct lighting.

Note

- This manual describes how to operate this unit by using the remote control transmitter mainly. To operate the unit from the front panel, use the corresponding buttons on the front panel (see page 3).

Setting the clock

You must set the clock before you can use the timer functions. The clock is based on a 24-hour system for the U.K., Europe, Australia, Singapore, and General models, and a 12-hour system for U.S.A and Canada models.

You can set the clock while in standby mode.

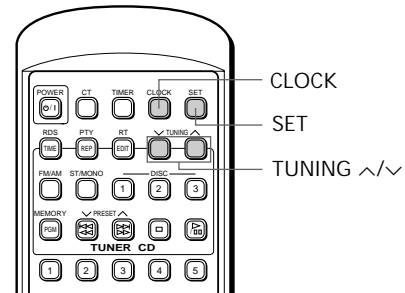

- 1 Press **CLOCK** for more than two seconds.

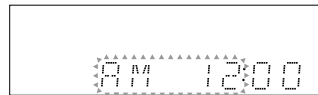

- 2 Press **TUNING ^/v** to set the hour, then press **SET**.

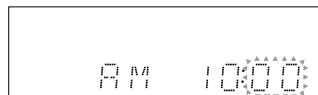

- 3 Press **TUNING ^/v** to set the minute, then press **SET**.

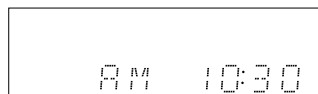

The clock starts.

To display the clock

Press **CLOCK**.

The current time appears for three seconds, then the normal display returns.

Note

- In the event of a power failure or when the AC power cord is disconnected for more than three seconds, you must reset the clock.

Turning on/off the unit

STANDBY/ON

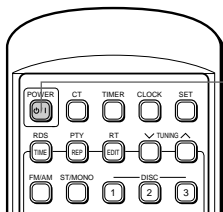
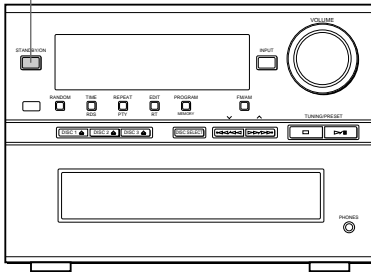

POWER

After connecting the AC power cord to the wall outlet, press the STANDBY/ON switch on the front panel or POWER on the remote to turn on/off the unit.

Selecting the input source

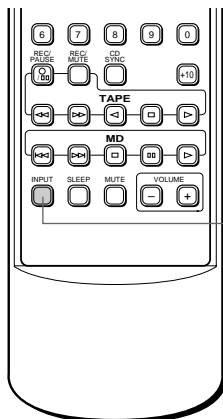

INPUT

To listen to the MDX-M5
Press INPUT on the remote repeatedly until "AUX/MD" appears in the display.

To listen to the KX-M5
Press INPUT on the remote repeatedly until "TAPE" appears in the display.

Adjusting the volume

VOLUME

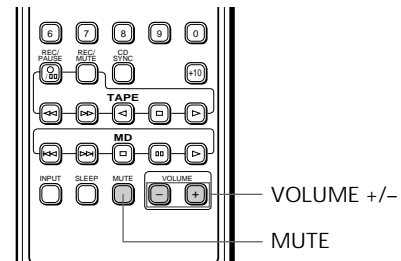
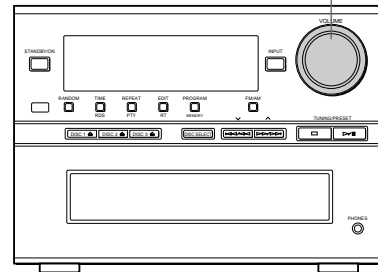

VOLUME +/-

MUTE

Front panel operation

Turn the VOLUME control to the right to increase, and to the left to decrease the volume.

Remote control operation

Press VOLUME + to increase, and VOLUME - to decrease the volume.

To mute the sound

Press MUTE.

The MUTE indicator appears in the display and the unit set the volume level to minimum.

To return to the previous volume level, press MUTE again.

Connecting the headphones

Connect the headphones to the PHONES jack. When you connect the headphones to the PHONES jack, there is no sound from the speakers. You can adjust the volume level by using the VOLUME control on the front panel or VOLUME +/- on the remote.

CD playback

You can play a CD and also play up to three CDs continuously.

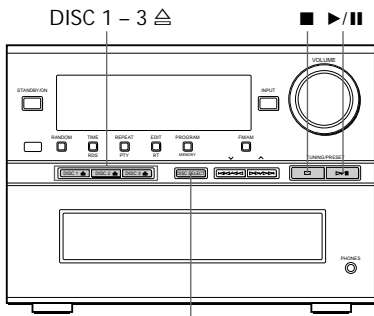

DISC SELECT

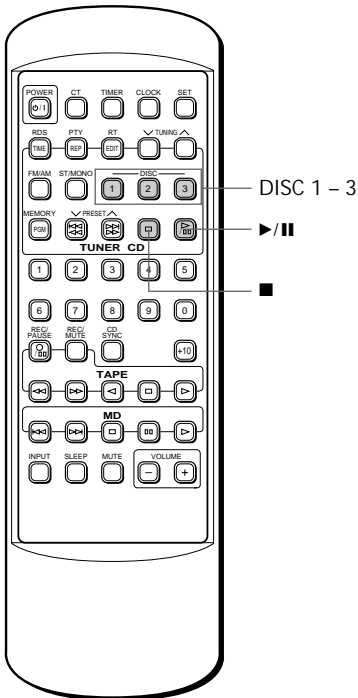

To play CDs

- 1 Press DISC 1 \triangle , DISC 2 \triangle , or DISC 3 \triangle to open the disc tray, and place a CD on the tray.

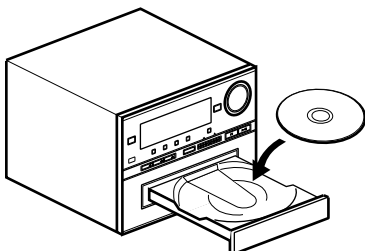

- 2 Press the selected disc's DISC \triangle button to close the disc tray.
To insert other CDs, follow the same procedure.
- 3 Press DISC SELECT to select the CD you want to play.

Light up in red when the tray contains a disc



Selected CD number

You can select the CD directly by pressing DISC 1 - 3. In this case, the unit starts play from the selected CD automatically.

- 4 Press ▶/|| to start playback.
The unit starts playback from the selected CD. The empty trays are skipped.

To stop playback completely
Press ■.

To stop playback temporarily
Press ▶/||.

To resume play, press ▶/|| again.

To eject CDs

Press DISC 1 \triangle , DISC 2 \triangle , or DISC 3 \triangle to open the disc tray, and remove the CD from the tray.

Notes

- You can change the CD by pressing the DISC \triangle you want to change during playback another disc.
- If you select another source by pressing INPUT, the unit stops playback automatically.

One Touch play

You can switch to the CD from another source by pressing ▶/|| or RANDOM.

In this case, the unit plays the disc which is played last.

To play a specific track on the disc

Direct play

Select a desired track using the number button.
(Example: To select 35, press +10 three times so that "3 -" appears in the display, then press 5.)

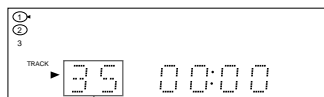

Selected track number

The unit starts playback.

Skip play

- To skip to a succeeding track, press ►► once or repeatedly until the desired track number appears.
- To skip to the beginning of the current track, press ◀◀ once.
- To skip to a preceding track, press ◀◀ once or repeatedly until the desired track number appears.

Notes

- You cannot enter a number that is higher than the last track number on the disc.
- These operations can also be performed when the unit is in the pause or stop mode.
- During stop mode, if ►► or ◀◀ is pressed and held, the track number successively changes to higher numbers (or lower numbers).
- When you change the disc, before you use the ►► or ◀◀ button, press ►/|| to make the unit read the information of the disc.

To advance or reverse playback rapidly (Manual Search)

During playback, press and hold ►► to advance playback rapidly, and ◀◀ to reverse playback rapidly. The sound can be heard (although slightly garbled) during manual search in either direction. This is convenient for locating a precise position within a track, or for reviewing the contents quickly.

Note

- Manual search can also be performed during pause, though no sound will be heard.

Selecting the time display

You can select any of the three time displays by pressing TIME.

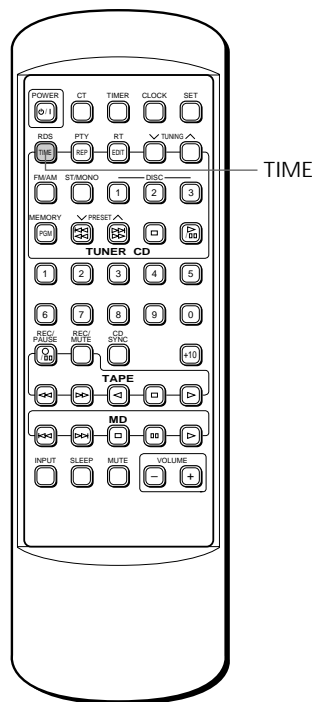

Each time you press TIME during play or pause, the display changes as follows:

The CD tray which contains a CD

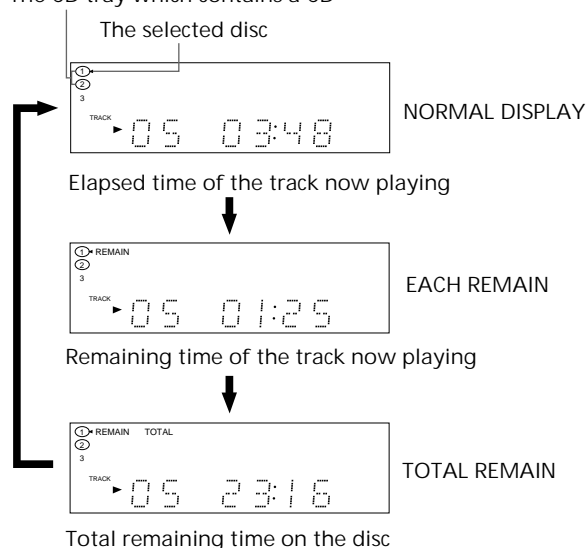

Random-sequence play

The unit can play all the tracks on a selected disc in a random sequence selected by the unit's microcomputer.

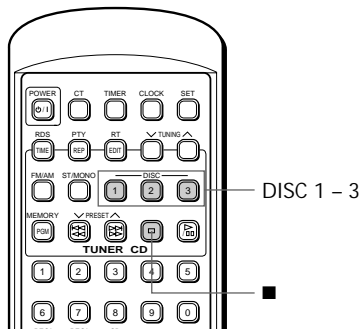
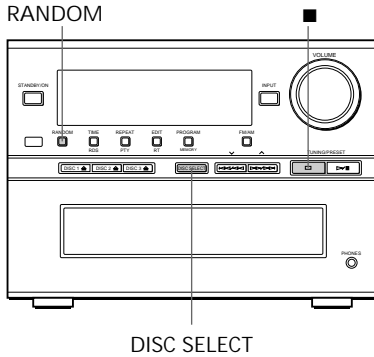

- 1 Press DISC 1 – 3 or DISC SELECT to select the CD you want to play.
- 2 Press RANDOM.
“RANDOM” appears in the display.
The unit starts random sequence play.

To cancel random-sequence play mode
Press ■ or RANDOM.
“RANDOM” disappears from the display.

Notes

- This feature will not function during programming, or during programmed play.
- If ►► is pressed during random-sequence play, the next randomly programmed track will be played.
If ◀◀ is pressed, play will return to the beginning of the current track.
- Total remaining time on the disc will not be displayed during random-sequence play.

Repeat play

You can play any desired track or disc, or all discs repeatedly.

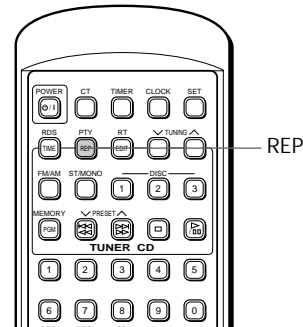

Press REP to select the repeat mode.
Each time you press REP, the display changes as follows:

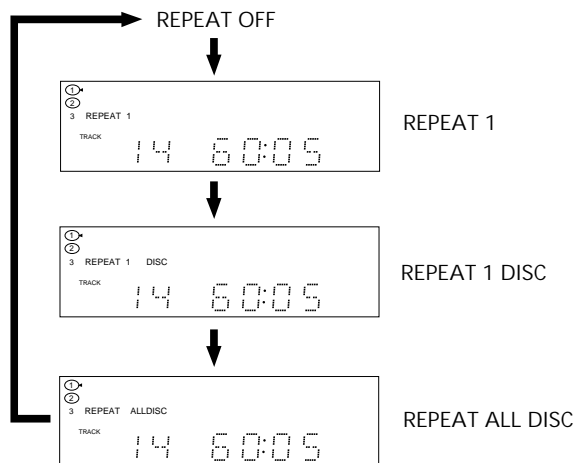

REPEAT 1

The current track is played repeatedly.

REPEAT 1 DISC

The current disc is played repeatedly.

* In random-sequence play mode, all randomly sequenced tracks are played repeatedly in the different order.

REPEAT ALL DISC

All tracks on all discs are played repeatedly.

To cancel repeat play mode

Press REP successively until “REPEAT” disappears from the display.

Program play

By creating a program, you can enjoy listening to your favorite discs or tracks in any desired order. As many as 20 tracks can be programmed in sequence.

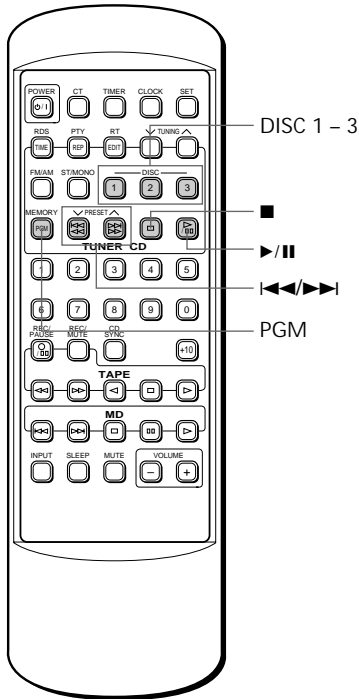

- 1 Press ■ to stop the unit.
- 2 Press PGM.
"PROGRAM" appears in the display.
- 3 Press DISC 1 – 3 to select the disc you want to program.

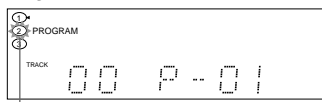

Selected disc

- 4 Press the number button of the desired track, then press PGM.



Program number for the track
Programmed track number

You can select the track by pressing >>> or <<< repeatedly until the desired track number appears in the display, then press PGM.

- 5 Repeat steps 3 and 4 to program more discs and tracks. You can select the same track again.
- 6 Press >/|| to start program play.

To stop program play mode

Press ■.

Notes

- When you change to program play mode from another play mode, press ■ and PGM ("PROGRAM" appears in the display), then press >/|| to start program play.
- You cannot program a track that is not included in a disc.
- >>> or <<< can be used during program play to skip to tracks within the program.

To check program data

1. Press ■ to stop program play.
2. Press PGM. Each time you press this button, the disc and track number and the program number are displayed in the order of the program.

To change program data

1. Follow the preceding procedure described in "To check program data."
2. Display the track number to be corrected by pressing PGM.
3. Press DISC 1 – 3 to select the desired disc, and press the number button of the desired track. The previously programmed track will be cleared from memory and the new one will be programmed.
4. When you are finished, press PGM.

To delete all program data

- Press ■ during stop in program play mode
- press POWER to turn the unit off
- Press INPUT to select other source
- Press DISC 1 – 3 \triangle to open the disc tray.

Listening to the radio

You can find radio stations automatically, if station signals are strong and there is no interference. However, if signals of the desired station signal is weak, you must tune to it manually.

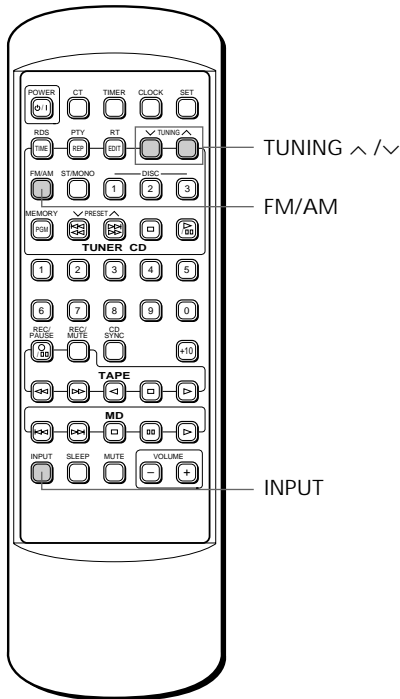

Automatic tuning

1 Press INPUT so that the frequency of the radio station appears in the display.

2 Press FM/AM to select the reception band.

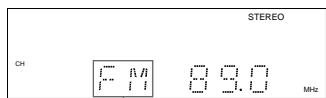

Selected band

3 Press and hold TUNING ^ (for a higher frequency) or ∨ (for a lower frequency) for more than 2 seconds, then release the button.

4 The unit starts searching for a station.

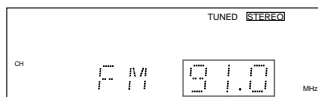

Station frequency

When the unit finds a station, the unit stops searching and "TUNED" appears in the display.

5 If the located station is not the desired one, repeat steps 3 and 4 until your desired station is heard.

Notes

- If automatic tuning search does not find the desired station, try manual tuning as described below.
- When an FM stereo broadcast with sufficient signal strength is received, "STEREO" appears in the display and you can listen to stereo sound.

Manual tuning

1 Follow steps 1 and 2 described in "Automatic tuning."

2 Press TUNING ^ (for a higher frequency) or ∨ (for a lower frequency) to select your desired station.

- Each time you press TUNING ^ or ∨, the frequency changes step by step.

Note

- If an FM program is noisy, press ST/MONO so that "STEREO" disappears from the display. There will be no stereo effect, but the reception will improve. Press this button again to restore the stereo effect.

One touch play

You can switch from another source to the radio just by pressing FM/AM. In this case, the unit tunes to the last received station.

Using the ^/∨ buttons on the front panel

The ^/∨ buttons on the front panel work as the TUNING ^/∨ buttons or PRESET ^/∨ buttons. To change a part, press TUNING/PRESET on the front panel. Each time you press TUNING/PRESET, the item changes.

Presetting stations

The unit can preset station frequencies selected by Automatic tuning or Manual tuning. With this function, you can select any desired station by pressing the corresponding preset station number. Up to 30 stations can be stored.

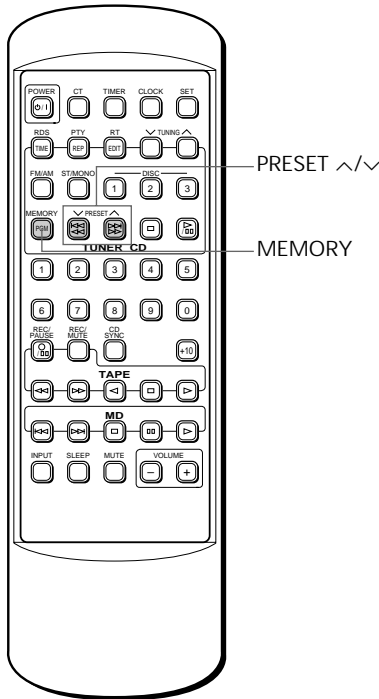

To preset stations

- 1** Tune in a desired station.
(Refer to the previous page for the tuning procedure.)
- 2** Press MEMORY.

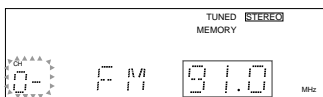

The frequency to preset
Preset number flashes.

- 3** Within 5 seconds, use the number buttons to select a desired preset number.
(Example: To select 25, press +10 twice so that "2 -" appears in the display, then press 5.)

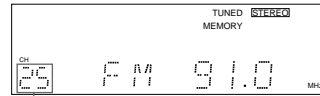

Selected preset number

You can also select a preset number by using PRESET ^/∨.

- 4** Press MEMORY.
- 5** Repeat steps 1 to 4 until all desired stations are preset.

Notes

- A new setting can be preset in place of the previous one.
- The preset stations are retained when you disconnect the AC power cord or a power failure occurs.

To recall a preset station

- 1** Press FM/AM to select the desired band.
- 2** Press the number button to select a desired preset number.

You can also select a preset number by using PRESET ^/∨.

What is RDS?

RDS (Radio Data System) is a data transmission system gradually being introduced by FM stations in many countries. Stations using this system transmit an inaudible stream of data in addition to the normal radio signal.

RDS data contains various information, such as Program Identification (PI), Program Service name (PS), Program Type (PTY), Traffic Program (TP), Radio Text (RT), Clock Time (CT), etc. The unit is compatible with the RDS system for PS, PTY, TP, RT, and CT.

Note

- RDS may not work properly if the station you are tuned to is not transmitting the RDS signal properly or if the signal strength is weak.
- Some FM stations do not offer RDS service. Of those that do, not all provide the same types of services. Check with your local radio stations for details on RDS services in your area.

Receiving RDS data

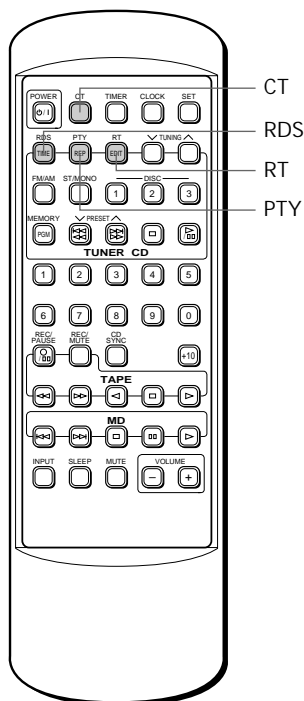

To search the station with RDS data

- 1 Press FM/AM so that "FM" appears in the display.
- 2 Press RDS.
- 3 Within 5 seconds (during flashing "RDS" in the display), press \wedge (for higher frequency) or \vee (for lower frequency).
The unit starts searching.
- 4 The unit stops searching when the unit find the station with RDS data, and Program Service Name appears and RDS lights up in the display.

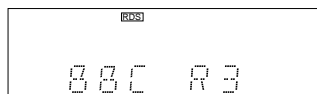

PS (Program Service name) mode

If the unit cannot find the station with RDS data, the unit stops searching and "NO PROG" appears in the display.

PTY (Program Type) mode

The type of program on the station being received is displayed.

In this mode, you can locate a station which is broadcasting your selected program type. For details, see page 17.

- 1 Search the desired FM station with PS data (see "To search the station with RDS data" on this page).
- 2 Press RDS repeatedly so that "RDS" and "PTY" flash in the display.



PTY (Program Type)

↓ after 5 seconds

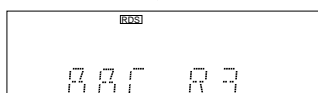

If the station does not have PTY data, the Program Service name appears in the display.

TP (Traffic Program) mode

You can search the station which broadcasts the traffic information.

- 1 Press FM/AM so that "FM" appears in the display.
- 2 Press RDS repeatedly so that "RDS" and "TP" flash in the display.

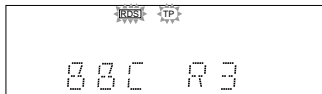

3. Within 5 seconds, press TUNING \wedge or \vee to start searching for a station which has TP data.
4. When the unit finds a station which has TP data, it stops searching and the Program Service name appears and "RDS" and "TP" lights up in the display.
When the unit cannot find a station which has TP data, "NO PROG" appears in the display, then the frequency or Program Service name appears in the display.

RT (Radio Text) mode

Information about the program (such as title of the song, name of the singer, etc.) on the RDS station being received is displayed.

- 1 Search the desired FM station with PS data (see "To search the station with RDS data" on page 15).
- 2 When the station broadcasts RT data, "RDS" and "RT" appears in the display.

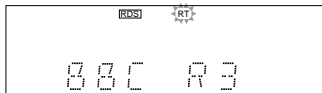

- 3 Press RT.
RT data appears in the display.
If the station does not have RT data, "NO TEXT" appears in the display, then the Program Service name appears in the display.

CT (Clock Time) mode

The current time is displayed. The CT data from the station being received changes every minute. In this mode, the unit can correct the time of the built-in clock automatically by synchronizing it with CT data.

- 1 Search the desired FM station with PS data (see "To search the station with RDS data" on page 15).
- 2 Press CT.
"CT" and the current time appear in the display.

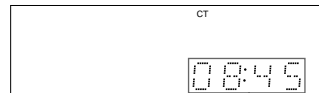

Current time

Note

- The CT data from the station is transferred every minute. Therefore it takes up to 1 minute until the current time appears, then press CT again to display the current time.

If the station does not have CT data, "NO CT" appears in the display, then the Program Service name or frequency appears in the display.

Locating a station by PTY (Program Type)

You can locate a desired station by selecting a program type. The unit tunes into the type of programs currently being broadcast from the RDS stations.

List of PTY (Program Type)

NEWS

Short accounts of facts, events, and publicly expressed views.

AFFAIRS

Topical programs expanding or enlarging upon the news, generally in a different presentation style or concept, including documentary debate, or analysis.

INFO

Programs whose purpose is to impart advice in the widest sense, including meteorological reports and forecasts, consumer affairs, medical help, etc.

SPORT

Programs concerned with any aspect of sport.

EDUCATE

Programs intended primarily to educate, such as "How to" programs, college credit programs, etc.

DRAMA

All radio plays and serials.

CULTURE

Programs concerned with any aspect of national or regional culture, including religious affairs, philosophy, social science, language, theatre, etc.

SCIENCE

Programs about the natural sciences and technology.

VARIED

Used mainly for speech-based programs usually of light-entertainment nature, not covered by the above categories. Examples are quizzes, panel games, personality interviews, comedy, and satire.

POP M

Commercial music of current popular appeal, often featured in current or recent record sales charts.

ROCK M

Contemporary modern music, usually written and performed by young musicians.

M O R M

(Middle of the Road Music) "Easy-listening," as opposed to Pop, Rock, or Classical. Music in this category is often vocal, and usually of short duration (less than 5 min).

LIGHT M

Classical Music for general, rather than specialist appreciation. Examples of music in this category are instrumental music, and vocal or choral works.

CLASSICS

Performances of major orchestral works, symphonies, Opera, chamber music, etc.

OTHER M

Musical styles not fitting into any of the above categories for example: Jazz, Rhythm & Blues, Folk, Country, and Reggae.

To locate a station

- 1 Search the desired FM station with PS data (see "To search the station with RDS data" on page 15).
- 2 Press RDS repeatedly so that "RDS" and "PTY" flash in the display.



- 3 Within 5 seconds, press PTY repeatedly until the desired program type appears in the display.

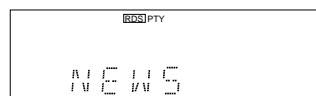

Program type

- 4 Within 5 seconds, press TUNING ^ (for a higher frequency) or v (for a lower frequency) to start searching for the station which is broadcasting the selected program type.
- 5 If a station broadcasting the selected program type is found, the unit stops searching and the Program Service name appears in the display.
- 6 Repeat steps 2, 3, and 4 until the desired station is located.

If there is no station broadcasting the program type you select, "NO PROG" appears in the display, then the Program Service name or frequency appears in the display.

Before using the timer

- 1 Make sure the clock of the unit is correct (for setting the clock, see page 7).
- 2 If you want to use the MDX-M5 or KX-M5 for timer play, you must first make the connections as shown in "Connecting other components" on page 5. For details, refer to the instructions supplied with the MDX-M5 or KX-M5.

Timer play

By using the built-in timer, you can have the unit turn on at a specified time and begin play of a tape, CD, or radio automatically. You can also specify the turn off time.

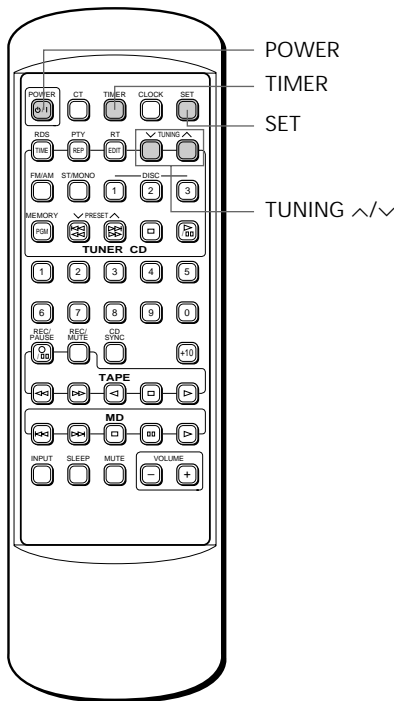

- 1 Prepare the source to be played.

For tuner

Tune in to the station you will listen to.

For CD player

Insert the desired disc into the unit. If more than one disc is inserted into the unit, select the disc by pressing DISC SELECT.

For the MDX-M5 or KX-M5

Insert the desired MD or tape into the selected unit. For details, refer to the instructions supplied with the MDX-M5 or KX-M5.

- 2 Press and hold TIMER for more than 2 seconds.

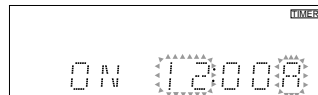

- 3 Set the time to start play.
Press TUNING ^/∨ repeatedly to select the hour, then press SET.

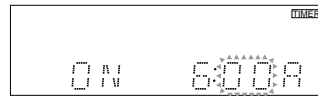

- 4 Press TUNING ^/∨ repeatedly to select the minute, then press SET.

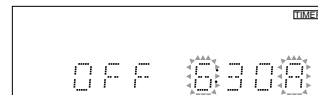

- 5 Set the hour and minute to stop play in the same way as shown above if needed.

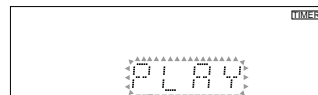

Timer recording radio programs using the MDX-M5 or KX-M5

6 Press TUNING \wedge/\vee repeatedly to select the timer play mode.
Each time you press TUNING \wedge/\vee , the timer play mode changes as follows:

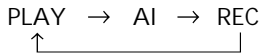

- **When you select “PLAY” mode**
Normal timer play mode is set.
In this mode, set the volume level for timer play manually.
- **When you select “AI” mode**
The AI timer mode is set.
In this mode, the volume level for timer play is set to VOL 18 automatically. When the unit turns on, the volume level increases gradually from VOL 18 to VOL 41.
If you press another button while the volume level is gradually increasing, the volume stops increasing .
- **When you select “REC” mode**
This mode is for timer recording. See “Timer recording radio programs using the MDX-M5 or KX-M5” on this page.

7 Press SET.

8 Press TUNING \wedge/\vee repeatedly so that the desired source appears in the display.
Each time you press TUNING \wedge/\vee , the source changes as follows:

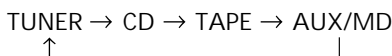

- 9**
- **When you select CD, TAPE, or AUX/MD in step 8 above**
Press SET.
 - **When you select TUNER in step 8 above**
Press SET twice.

If you select “PLAY” mode in step 6, set the level of volume by pressing TUNING \wedge/\vee , then press SET.

10 Press POWER to turn off the unit.
The unit is in standby mode for timer play.

To cancel timer play
Press TIMER so that “TIMER” disappears from the display.

By using the built-in timer, you can record radio programs automatically on the MDX-M5 or KX-M5. For details on recordings, refer to the instructions supplied with the MDX-M5 or KX-M5.

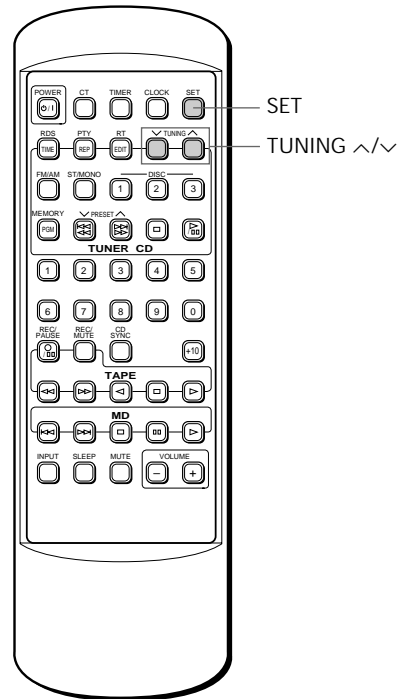

- 1** Load a blank tape into the KX-M5 or a blank MD into the MDX-M5.
- 2** Follow steps 1 to 5 on “Timer play” of the previous page.
- 3** Press TUNING \wedge/\vee repeatedly so that “REC” appears in the display, then press SET.

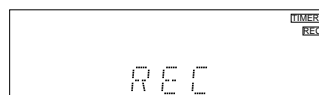

- 4** Press SET again after checking the frequency. If you want to record from another station, before pressing SET, press TUNING \wedge/\vee to select the desired radio station (see page 13), then press SET.

(Continued)

- 5** Press TUNING \wedge/\vee repeatedly to select the source to be recorded, then press SET.

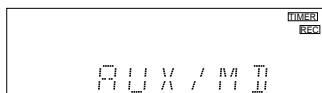

or

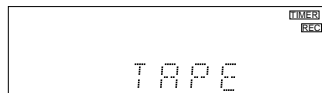

- 6** Press TUNING \wedge/\vee repeatedly to set the volume level to VOL MIN, then press SET.

- 7** Press POWER to turn off the unit .
The unit is in standby mode for timer recording.

To cancel timer recording

Press TIMER so that "TIMER" disappears from the display.

Note

- When you record a radio program on an MD, analog sound is recorded. In this case, set the input mode of the MDX-M5 to the analog input mode.

Checking timer setting

When the timer settings are complete, you can check them.

- 1** Press TIMER so that "TIMER" appears in the display.
- 2** The timer settings appear in the display in the following order:

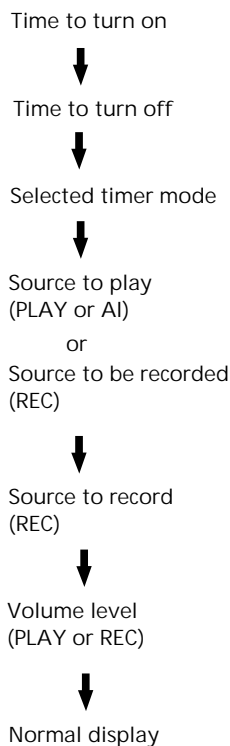

To change the timer setting

Press TIMER more than 2 seconds, and reset the timer (see page 18 and 19).

Sleep timer operation

The unit can be turned off automatically.

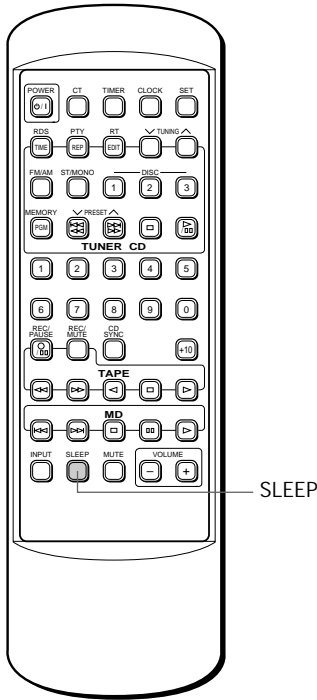

To cancel sleep timer

Press SLEEP repeatedly so that "SLEEP" disappears from the display.

To change the sleep time

While "SLEEP" appears in the display, press SLEEP repeatedly until the desired time appears in the display.

Using the timer operation and the sleep timer at the same time

- 1 Prepare the timer operation (see pages 18 and 19).
 - Do not turn off the unit after setting the time.
- 2 Set the sleep timer by pressing SLEEP.

Note

- Do not prepare the timer setting so that the timer will start during sleep timer operation. Since sleep timer operation has priority, the timer will not work.

- 1 Play the desired sound source.
- 2 Press SLEEP.

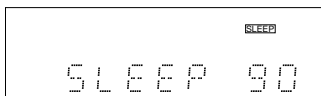

"SLEEP" and "90" (remaining time before the unit turns off – sleep time) appear in the display.

- 3 Press SLEEP repeatedly until the desired sleep time appears in the display. Each time you press SLEEP, the sleep time changes as follows:

90 → 80 → 70 10 → SLEEP OFF

About 3 seconds after setting, the normal display will resume.

- 4 The unit will turn off automatically when the selected sleep time passes.

Listening to the MDX-M5 or KX-M5

When you listen to the MDX-M5 or KX-M5, you must first make the connections as shown in "Connecting other components" on page 5. For details, refer to the instructions supplied with the MDX-M5 or KX-M5.

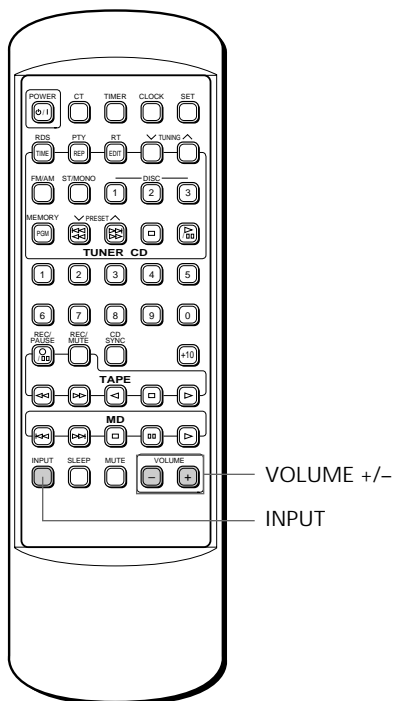

To operate the MDX-M5 or KX-M5 with the remote control transmitter of the unit

You can operate the MDX-M5 or KX-M5 using the remote control transmitter of the unit. The buttons that can be used are:

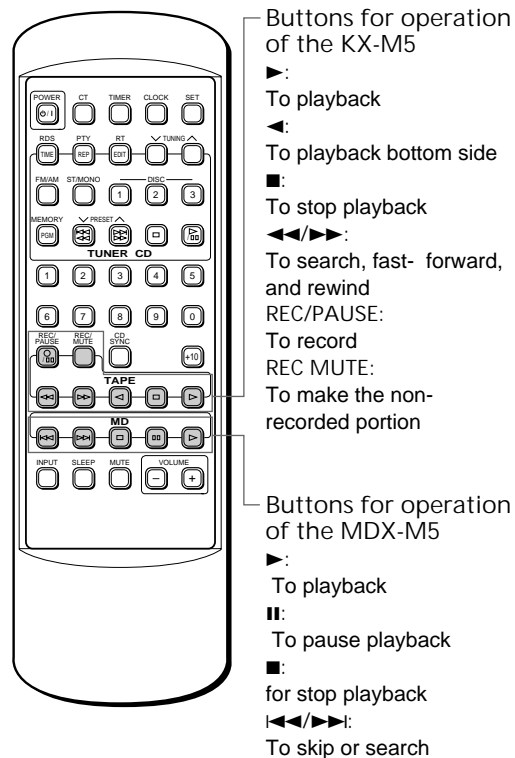

- 1 Press INPUT repeatedly to select the desired source.

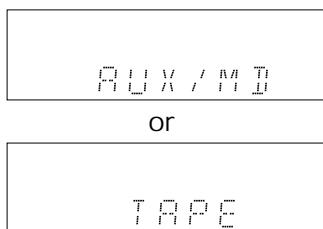

- 2 Play the source.
- 3 Press VOLUME +/- to adjust the volume to the desired level.

Note

- You can switch to the desired source directly from another source by pressing MD ▶ or TAPE ◀▶.

Before recording

When you record by using the MDX-M5 or KX-M5, you must first make the connections as shown in "Connecting other components" on page 5. For details, refer to the instructions supplied with the MDX-M5 or KX-M5.

CD synchronized recording

You can record a CD on a MD or tape by pressing just one button when you connect the MDX-M5 or KX-M5.

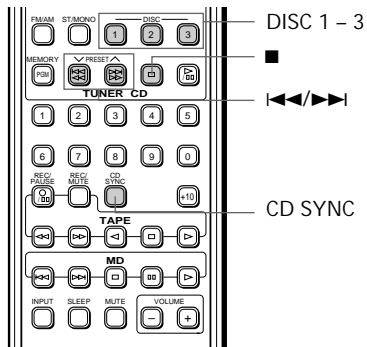
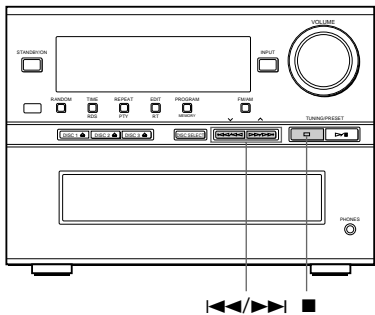

- 1 Insert the desired CD into the unit, and load the blank MD into the MDX-M5 or blank tape into the KX-M5.
 - When you use the cassette deck, set the cassette deck to forward direct and reverse mode (see the instructions of the cassette deck).
- 2 Press DISC 1 – 3 to select the desired CD, then press ■ after playing for several seconds.
- 3 Press CD SYNC while both units are in stop mode. The recording source appears in the display.

- 4 Press ◀◀/▶▶ repeatedly to select the recording source (TAPE or MD).
- 5 Press CD SYNC.
The unit starts CD play from the beginning of a disc and the MDX-M5 or KX-M5 starts recording automatically.
- 6 Each unit stops automatically when recording is finished.

Notes

- If you select MD in step 4, the digital signal is recorded automatically. For details, refer to the instructions of the MDX-M5.
- When you press INPUT to set the unit MD mode, if you press CD SYNC, the KX-M5 starts recording the MD source. Be careful.

To stop CD synchronized recording
Press ■ (TUNER CD).

To record from the desired track using CD synchronized recording

Press DISC 1 – 3 to select the disc which contains the desired track and press ■ after playing for several seconds, then press ◀◀/▶▶ repeatedly to select the desired track before pressing CD SYNC in step 3 above.

To record a program of tracks using CD synchronized recording

Before pressing CD SYNC in step 3 above:

1. Program the CD tracks you want to record (see page 12).
2. Press PGM so that "PROGRAM" appears in the display.
3. Press CD SYNC.

To record tracks programmed by Automatic CD edit using CD synchronized recording

Program the tracks by using the Automatic CD edit function (see the next page) before pressing CD SYNC in step 3 above.

Notes

- When the MD or tape becomes full before the end of recording, each unit stops.
- Adjusting the VOLUME control has no effect on the recording level.

To cancel Automatic CD edit recording
Press ■ (CRX-M5) while setting Automatic CD edit recording.

To stop Automatic CD edit recording
Press ■ (CRX-M5).

Notes

- When the MD or tape becomes full before end of the recording, each unit stops.
- Adjusting the VOLUME control has no effect on the recording level.

Manual recording

You can record from the built-in tuner, CD, MDX-M5, or KX-M5. You can use the MDX-M5 or KX-M5 for recording manually. For recording operations, see the instructions of each.

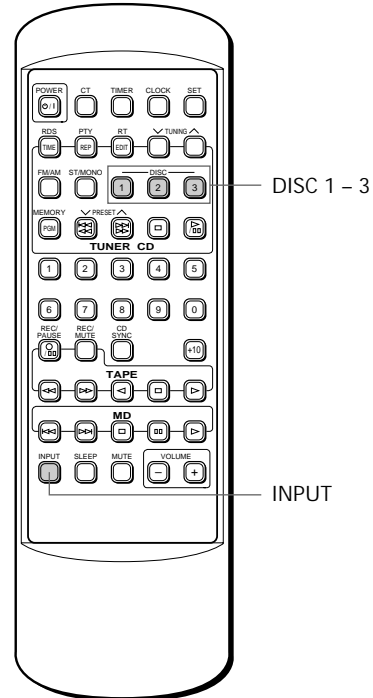

- 1 Prepare the source to be recorded.

For tuner

Tune in to the station you will record.

For CD player

Insert the desired disc into the unit. If more than one disc are inserted into the unit, select the disc by pressing DISC 1 – 3.

For the MDX-M5 or KX-M5

Insert the desired MD or cassette tape into the corresponding unit.

- 2 Press INPUT to select the source to be recorded from.
- 3 Begin recording using the appropriate recording operation of the selected unit.

CD preventive care

- This compact disc player is designed for playing compact discs bearing the  mark only. Never attempt to load any other type of disc into the unit. The unit will also play 8-cm (3-inch) compact discs.
- Compact discs are not subjected to wear during play, but damage to the disc surface when the disc is being handled can adversely affect the disc's play.
- Do not use cleaning discs or warped discs. All of these could damage the unit.

To prevent a malfunction of this unit

- Do not use any non standard shaped CD (heart etc.) available on the market, because it may damage the unit.

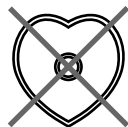

- Do not use a CD with tape, seals, or paste on it, because damage to the unit may result.

- Compact discs are not affected by small particles of dust or fingerprints on their playing surface, but even so they should be kept clean. Wipe by using a clean, dry cloth. Do not wipe with a circular motion; wipe straight outward from the center.

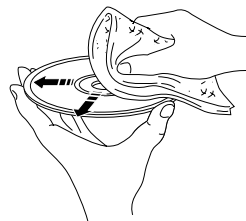

- Do not try to clean the disc's surface by using any type of disc cleaner, record spray, anti-static spray or liquid, or any other chemical-based liquid, because such substances might irreparably damage the disc's surface.
- Do not expose discs to direct sunlight, high temperature or high humidity for a long period of time, because these might warp or otherwise damage the disc.

No!



Troubleshooting

If the unit fails to operate normally, check the following points to determine whether the fault can be corrected by the simple measures suggested. If it cannot be corrected, or if the fault is not listed in the SYMPTOM column, disconnect the power cord and contact your authorized YAMAHA dealer or service center for help. When taking the service, the MDX-M5 or KX-M5 may be needed. For details, contact your authorized YAMAHA dealer or service center.

	SYMPTOM	CAUSE	REMEDY
SYSTEM/TUNER	The player does not switch ON when the STANDBY/ON switch is pressed.	The AC power cord is not connected or not completely connected.	Securely connect the power cord.
	No sound from one speaker.	Loose speaker connections.	Connect properly.
	No sound from speakers.	Internal protection circuit is functioning.	Unplug the AC power cord from the wall outlet, and then plug in again.
	No sound from an external unit connected with this unit or play does not begin.	Incorrect cord connections.	Connect the cords properly. If the problem persists, the cords may be defective.
Input source selection is not proper.		Make a proper input source selection.	

	SYMPTOM	CAUSE	REMEDY
SYSTEM/TUNER	Excessive static in FM broadcasts.	Interference from starting motor of a nearby car.	Position the FM antenna as high and as far away from nearby roads as possible. Connect using a coaxial cable.
		Interference from the thermostat of a nearby electrical appliance.	
	Noise increases during stereo broadcasts.	Antenna input is too weak due to obstructions or excessive distance from the broadcasting station.	Check the antenna connection. Install a multi-element type FM antenna if possible.
	Stereo broadcasts are noisy and STEREO indicator blinks on and off.	Insufficient antenna input.	Install an antenna appropriate for the electric field strength of your area.
	Cannot select preset stations.	Preset memory has been erased.	Reprogram memory presettings.
	Buzzing or static during AM broadcasts.	Interference from source such as lightning, fluorescent lights, electric motors or thermostat of nearby electrical appliance.	The problem is difficult to eliminate, but can be lessened by grounding AM loop antenna.
		TV or microprocessor is being used nearby.	Move away from TV or microprocessor.
	AM broadcast sensitivity is poor.	Radio signal is weak or the antenna is not properly connected.	Properly connect the AM loop antenna.
			Change orientation of the AM loop antenna.
			Install an external AM loop antenna.
Cannot set timer	Current time is not set.	Set current time.	
The unit does not work normally.	The internal microcomputer has been frozen by an external electric shock (lightning, excessive static electricity, etc.) or the power supply with low voltage.	Unplug the AC power cord from the wall outlet, and then plug in again after about one minute.	
CD PLAYER	Play does not begin.	The disc is damaged.	Check the disc carefully; replace it if necessary.
		There is moisture on the laser pickup.	Wait 20 to 30 minutes after switching the unit ON before trying to play a disc.
		The disc has been loaded upside down.	Reload the disc with the label side facing up.
		The disc is dirty.	Clean the disc.
	Play is delayed, or begins at the wrong place.	The disc may be scratched or damaged.	Check the disc carefully; replace it if necessary.
	CD synchronized recording or Automatic recording function does not work.	The system cable is not connected securely.	Connect the system cable properly.
	Sound "skips."	The unit is being subjected to vibrations or impacts.	Relocate the unit.
		The disc is dirty.	Clean the disc.
	Sound "hums."	Improper cable connections.	Securely connect the audio cables. If the problem persists, the cables may be defective.
Noise from inside of the unit.	The disc may be warped.	Replace the disc.	
REMOTE CONTROL	The remote control transmitter does not work.	The batteries of the remote control transmitter are too weak.	Replace the batteries with new ones.
		Remote control is too far away or is being used at an incorrect angle.	Use within 6 meters and 60 degree radius.
		Direct sunlight or lighting (of an inverter type of fluorescent lamp, etc.) is striking the remote control sensor of the unit.	Change the position of the unit.
	TV functions strangely when the remote control is being used.	Remote control is being used near, TV set with a remote control sensor.	Relocate this unit away from the TV or cover the TV's remote control sensor.

Specifications

As a part of policy of continuous improvement, YAMAHA reserves the right to make design and specification changes for product improvement without prior notice. The performance specification figures indicated are nominal values of production.

Amplifier section

Minimum RMS Output power per channel	15 W + 15 W (6Ω 1KHz 0.1% THD)
Maximum POWER (Singapore and General Models)	20 W + 20 W (6Ω 1KHz 10% THD)
DIN Standard Output power per channel (U.K. and Europe Models)	15 W + 15 W (6Ω 1KHz 0.7% THD)
Input sensitivity/Impedance	
MD/AUX	400 mV/47 k-ohms
TAPE	400 mV/47 k-ohms

Tuner section

Tuning range	
FM	
[U.S.A. and Canada models]	87.5 – 108.0 MHz
[U.K., Europe, Australia, Singapore, and General models]	87.5 – 108.00 MHz
AM	
[U.S.A. and Canada models]	530 – 1720 kHz
[U.K., Europe, Australia, Singapore, and General models]	522 – 1611 kHz
Sensitivity	
FM (S/N 30dB)	10 dB
AM (S/N 20dB)	50 dB

CD player section

Type	3 Discs automatic changer
D/A converter	1-bit DAC
Frequency response (20 – 2000 Hz)	±1 dB
Wow and flutter	Below measurable limits

Laser Diode Properties

- Material: GaAs
 - Wavelength: 760 nm – 800 nm
 - Emission Duration: continuous
 - Laser Output: max. 40 μW*
- * This output is the value measured at a distance of about 200 mm from the objective lens surface on the Optical Pick-up Block.

General

Power supply	
[U.S.A. and Canada models]	AC 120 V, 60 Hz
[Australia model]	AC 240 V, 50 Hz
[U.K., Europe, and Singapore models]	AC 230 V, 50 Hz
[General model]	AC 115/230 V, 50/60 Hz
Power consumption	
[U.S.A. and Canada models]	100 W
[Australia, U.K., Europe, Singapore, and General models]	90 W
Dimensions (W x H x D)	200 x 150 x 329
Weight	5.0 kg

For U.K. customers

If the socket outlets in the home are not suitable for the plug supplied with this appliance, it should be cut off and an appropriate 3 pin plug fitted. For details, refer to the instructions described below.

Note: The plug severed from the mains lead must be destroyed, as a plug with bared flexible cord is hazardous if engaged in a live socket outlet.

SPECIAL INSTRUCTIONS FOR U.K. MODEL

IMPORTANT:

The wire in the mains lead are coloured in accordance with the following code:

Blue: NEUTRAL
Brown: LIVE

As the colours of the wires in the mains lead of this apparatus may not correspond with the coloured markings identifying the terminals in your plug, proceed as follows: The wire which is coloured BLUE must be connected to the terminal which is marked with the letter N or coloured BLACK. The wire which is coloured BROWN must be connected to the terminal which is marked with the letter L or coloured RED. Making sure that neither core is connected to the earth terminal of the three pin plug.



Free Manuals Download Website

<http://myh66.com>

<http://usermanuals.us>

<http://www.somanuals.com>

<http://www.4manuals.cc>

<http://www.manual-lib.com>

<http://www.404manual.com>

<http://www.luxmanual.com>

<http://aubethermostatmanual.com>

Golf course search by state

<http://golfingnear.com>

Email search by domain

<http://emailbydomain.com>

Auto manuals search

<http://auto.somanuals.com>

TV manuals search

<http://tv.somanuals.com>