



MDX-9

MINIDISC RECORDER
LECTEUR ENREGISTREUR DE MINIDISC



OWNER'S MANUAL

MODE D'EMPLOI

BEDIENUNGSANLEITUNG

BRUKSANVISNING

MANUALE DELL'UTENTE

MANUAL DE INSTRUCCIONES

GEBRUIKSAANWIJZING

CAUTION: READ THIS BEFORE OPERATING YOUR UNIT.

1. This unit is a sophisticated mini disc recorder. To ensure proper operation for the best possible performance, please read this manual carefully.
2. Choose the installation location of your unit carefully. Avoid placing it in direct sunlight or close to source of heat. Also avoid locations subject to vibration and excessive dust, heat, cold or moisture. Keep it away from sources of hum such as transformers or motors.
3. Do not place another component on top of this unit, to do so may discolor or damage the surface of the unit.
4. Do not open the cabinet of this unit, to do so may result in damage to the unit or electrical shock. If any foreign object or substance gets into the unit, contact your dealer for assistance.
5. When removing the power plug from the wall outlet, always pull directly on the plug; never pull the cord itself.
6. Do not apply excessive force when operating switches and knobs.
7. When moving the unit, be sure to first disconnect the power cord from the AC outlet and disconnect all cords connecting the unit to other equipment.
8. Do not attempt to clean this unit with chemical solvents as this may damage the finish. Use a clean, dry cloth.
9. Be sure to read the "TROUBLESHOOTING" section for advice on common operating errors before concluding that your unit is faulty.
10. Keep this manual in a safe place for future reference.

Note

Please check the copyright laws in your country to record from records, compact discs, radio, etc. Recording of copyright material may infringe copyright laws.

WARNING

TO REDUCE THE RISK OF FIRE OR ELECTRIC SHOCK, DO NOT EXPOSE THIS APPLIANCE TO RAIN OR MOISTURE.

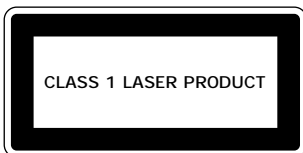

This mini disc recorder is classified as a CLASS 1 LASER product. The CLASS 1 LASER PRODUCT label is located on the rear exterior.

For U.K. customers

If the socket outlets in the home are not suitable for the plug supplied with this appliance, it should be cut off and an appropriate 3 pin plug fitted. For details, refer to the instructions described below.

Note: The plug severed from the mains lead must be destroyed, as a plug with bared flexible cord is hazardous if engaged in a live socket outlet.

IMPORTANT

THE WIRES IN MAINS LEAD ARE COLOURED IN ACCORDANCE WITH THE FOLLOWING CODE:

Blue: NEUTRAL

Brown: LIVE

As the colours of the wires in the mains lead of this apparatus may not correspond with the coloured markings identifying the terminals in your plug, proceed as follows: The wire which is coloured BLUE must be connected to the terminal which is marked with the letter N or coloured BLACK. The wire which is coloured BROWN must be connected to the terminal which is marked with the letter L or coloured RED. Making sure that neither core is connected to the earth terminal of the three pin plug.

DANGER

Invisible laser radiation when open and interlock failed or defeated. Avoid direct exposure to beam.

CAUTION

Use of controls or adjustments or performance of procedures other than those specified herein may result in hazardous radiation exposure.

FEATURES

- A sampling rate converter that lets you make digital recordings from 32 kHz (DAT, etc.) , 44.1 kHz (CD, DAT, MD, etc.) and 48 kHz (DAT, etc.) program sources.
- Editing features (MOVE, ERASE, DIVIDE, COMBINE, TITLE, and UNDO) that let you take full advantage of the MD recording system.
- Multiple digital INPUT terminals (2 optical inputs and 1 coaxial input) let you connect up to three different digital program sources.
- The digital optical OUTPUT terminal lets you output digital audio from an MD.*
- In addition to the standard disc and track repeat modes, this unit also has a part (A-B) repeat mode that lets you repeat a specific part of a track.
- Synchro Record lets you make synchronized recordings from any type of source component.
- Time Rescue Record monitors the sound being input and allows you to recover sound input from a point approximately four seconds before you start the recording operation. (So you will not miss the beginning of a song when recording directly from the radio, etc.)
- The Monaural Record mode lets you record up to 148 minutes of audio onto one MD.
- Timer playback and recording modes that let you start playback or recording at a preset time using an optional audio timer.

* This is not possible if MD is a direct copy of another digital signal (see page 24 for details regarding SCMS copy protection).

US and foreign patents licensed from Dolby Laboratories Licensing Corporation.

CONTENTS

| | |
|---|-----------|
| PART DESCRIPTIONS | 4 |
| FRONT PANEL | 5 |
| REMOTE CONTROL | 6 |
| CONNECTIONS | 7 |
| ANALOG CONNECTIONS | 7 |
| DIGITAL CONNECTIONS | 7 |
| PLAYBACK | 8 |
| Skipping Tracks | 8 |
| Searching | 9 |
| Switching the Display | 9 |
| RANDOM PLAY | 10 |
| REPEAT PLAY | 10 |
| Single Track Repeat | 10 |
| Full Disc Repeat | 10 |
| Part (A-B) Repeat | 11 |
| PROGRAM PLAY | 11 |
| RECORDING | 13 |
| Recording Level | 14 |
| Auto Marking | 14 |
| TIME RESCUE RECORDING | 15 |
| SYNCHRO RECORDING | 15 |
| MONAURAL RECORDING | 16 |
| MONITOR OUT | 16 |
| EDITING | 17 |
| MOVE | 17 |
| ERASE | 18 |
| Disc Erase | 18 |
| Track Erase | 18 |
| Part Erase | 19 |
| COMBINE | 19 |
| DIVIDE | 20 |
| TITLING | 21 |
| TIMER OPERATIONS | 22 |
| Timer recording | 22 |
| Timer playback | 22 |
| MD SYSTEM LIMITATIONS | 23 |
| COPY PROTECTION (SCMS) | 24 |
| NOTES REGARDING THE REMOTE CONTROL | 24 |
| Remote control operation range | 24 |
| Battery installation | 24 |
| TROUBLESHOOTING | 25 |
| DISPLAY MESSAGES | 26 |
| SPECIFICATIONS | 27 |

PART DESCRIPTIONS



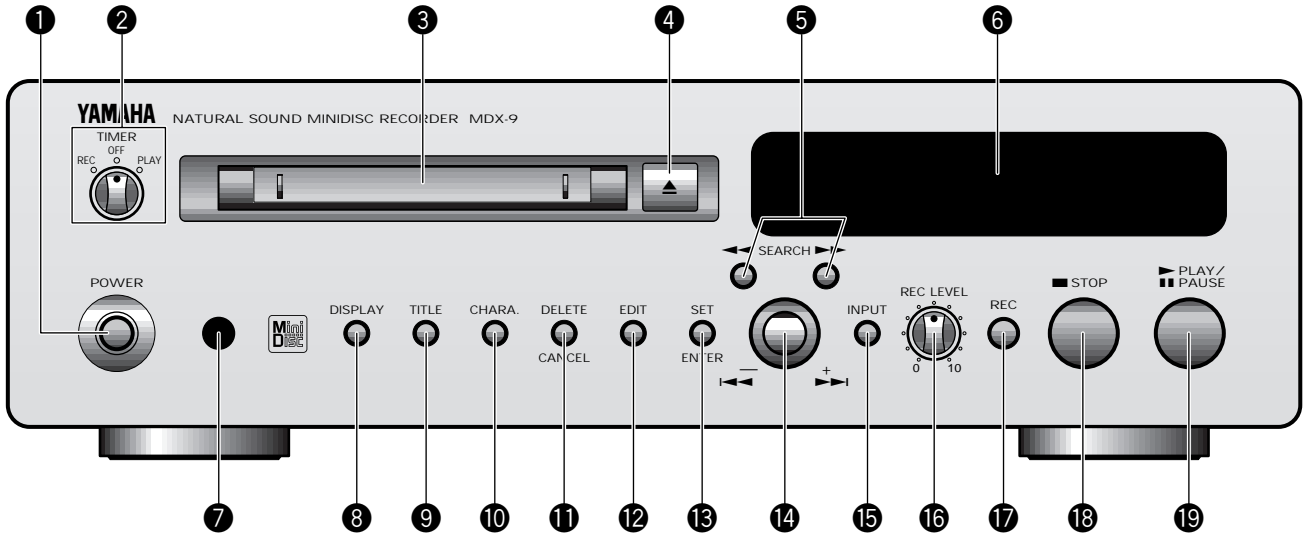



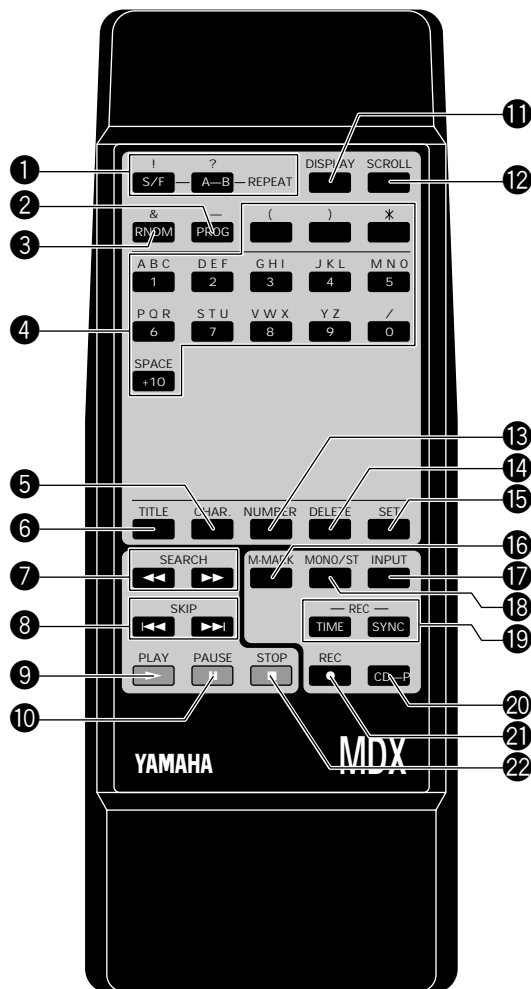



Front Panel



Remote Control



See the pages in parenthesis for details regarding operation.

- ① **POWER (8)**
Press to turn the unit on or off.
- ② **TIMER (22)**
Use to set the unit to play or record when activated by an external timer.
- ③ **Disc insertion slot**
Insert the disc into this slot.
- ④ **Eject **
Press to remove the disc.
If the TOC* data has not yet been written, it is written automatically before the disc is ejected.
- ⑤ **SEARCH   (9, 21)**
Press and hold to search quickly during play or pause.
Use to move the cursor when inputting a disc (track) title.
- ⑥ **Display panel (9)**
Displays various information.
- ⑦ **Remote control sensor (24)**
Receives the signals emitted from the remote control.
- ⑧ **DISPLAY (9)**
Press repeatedly to switch between the title and time displays.
- ⑨ **TITLE (21)**
Press to activate or deactivate the title mode.
- ⑩ **CHARA. (21)**
Press repeatedly to select different types of characters when titling a disc (track).
- ⑪ **DELETE/CANCEL (17, 21)**
Press to cancel an edit function or to delete the selected character when titling a disc (track).
- ⑫ **EDIT (17)**
Press repeatedly to accesses the different edit modes.
- ⑬ **SET/ENTER (17, 21)**
Press to confirm the current operation or select an edit mode (etc.).
- ⑭ **Jog dial [ / ] [ ] (8, 21)**
Use to skip to the beginning of the previous or next tracks.
Use to select characters when inputting a disc (track) title.
- ⑮ **INPUT (13)**
Press repeatedly to select the input jacks you want to record from: ANALOG or DIGITAL (OPTICAL 1, OPTICAL 2, or COAXIAL).
- ⑯ **REC LEVEL (14)**
Use to adjust the recording level when recording from the analog inputs.
- ⑰ **REC (14)**
Press during stop or pause to activate the record pause mode.
Press while recording to manually add a track division.
- ⑱ ** STOP (8, 13, 17, 21)**
Press to stop recording or playback.
Press to cancel an edit or title input operation.
- ⑲ ** PLAY/ PAUSE (8, 13)**
Press during stop (or pause) to start playback. Press while playing to pause.
Press during record pause to start recording. Press while recording to pause.

* TOC (Table of Contents): This is the non-audio data contained on all mini discs (track numbers, playback time, title data, etc.).

UTOOC (User's Table of Contents): This is non-audio data that you can edit (like track numbers, playback time, and title data).

REMOTE CONTROL

See the pages in parenthesis for details regarding operation.

1 REPEAT (10-11)

S/F (!)

Press to select single track (S) or full disc (F) repeat.
Press to select "!" when creating a disc (track) title.

A-B (?)

Press to specify the A and B points for A-B repeat.
Press to select "?" when creating a disc (track) title.

2 PROG (-) (11)

Press to activate or deactivate the program play mode.
Press to select "-" when creating a disc (track) title.

3 RNDM (&) (10)

Press to activate or deactivate the random play mode.
Press to select "&" when creating a disc (track) title.

4 Numbers/Characters (8, 21)

Use to specify a track.
Press repeatedly to select a character when creating a disc (track) title.

5 CHAR. (21)

Press repeatedly to select uppercase or lowercase letters during title mode.

6 TITLE (21)

Press to activate or deactivate the title mode.

7 SEARCH << >> (9, 21)

Press and hold to search quickly during play or pause.
Use to move the cursor when inputting a disc (track) title.

8 SKIP <<< >>> (8, 21)

Press to skip to the beginning of the previous or next tracks during play, pause or stop.
Use to select characters when inputting a disc (track) title.

9 ▷ PLAY (8, 14)

Press during stop (or pause) to start playback.
Press during record pause to start recording.

10 ⏸ PAUSE (8, 14)

Press to pause playback or recording.

11 DISPLAY (9)

Press repeatedly to switch between the title and time displays.

12 SCROLL (9)

Press to scroll the disc (track) title across the display.
Press while scrolling to pause the scroll.

13 NUMBER (21)

Press before pressing a number button to input a number during title mode.

14 DELETE (21)

Press to delete the selected character when titling a disc (track).

15 SET (21)

Press to confirm selected character when titling a disc (track).

16 M-MARK (14)

Press to select automatic or manual marking of tracks during recording.

17 INPUT (13)

Press repeatedly to select the input jacks you want to record from: ANALOG or DIGITAL (OPTICAL 1, OPTICAL 2, or COAXIAL).

18 MONO/ST (16)

Press during stop or pause to select either monaural or stereo recording.

19 Special Record buttons

TIME (15)

Press during record pause mode to activate Time Rescue Recording and set the unit to the record pause mode.

SYNC (15)

Press during stop to activate Synchronized Recording and set the unit to the record pause mode.

20 CD-P (15)

Press to start playback from a YAMAHA CD player.

21 ○ REC (14)

Press during stop or pause to activate the record pause mode.
Press while recording to manually add a track mark.

22 □ STOP (8, 14, 17, 21)

Press to stop recording or playback.
Press to cancel an edit or title input operation.

CONNECTIONS

Do not plug in this unit (or other components) until all other connections are complete.

- Connections should be made to the correct input/output terminals on the other component.
- Also refer to the owner's manual supplied with the component you are connecting.
- If the placement of this unit causes noise in other equipment, such as a tuner, move them farther apart.

ANALOG CONNECTIONS

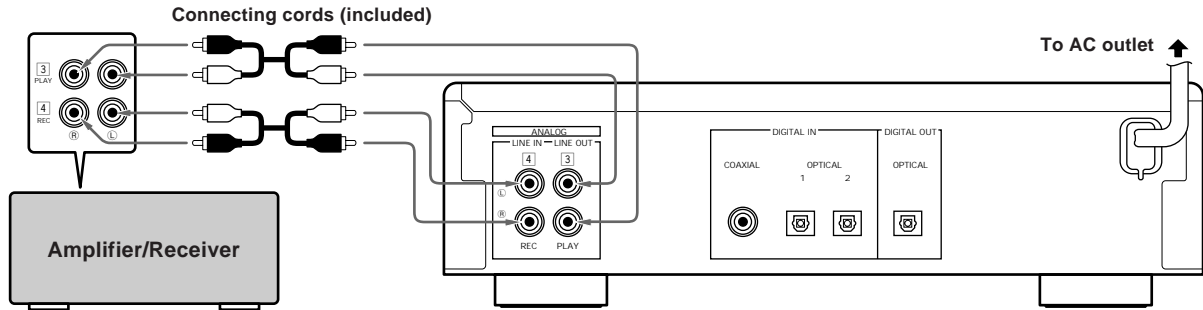

Notes for analog connections

- The white plug on the connecting cables corresponds to the L (left) channel and the red plug corresponds to the R (right) channel. Be sure to connect L (left) to L and R (right) to R. Also make sure that the plugs are fully inserted and that the connection is firm.
- The LINE OUT jacks on the MD recorder should be connected to the MD PLAY jacks on your amplifier.
- The LINE IN jacks on the MD recorder should be connected to the MD REC jacks on your amplifier.
- The LINE OUT terminals on this unit are numbered [3] and the LINE IN jacks are numbered [4]. When connecting this unit to a YAMAHA amplifier or receiver whose terminals are numbered [1], [2], [3], [4] ... (etc.), connect this unit's LINE OUT terminals to the input terminals numbered [3] and connect this unit's LINE IN terminals to the output terminals numbered [4] on the rear panel of the amplifier or receiver.

DIGITAL CONNECTIONS

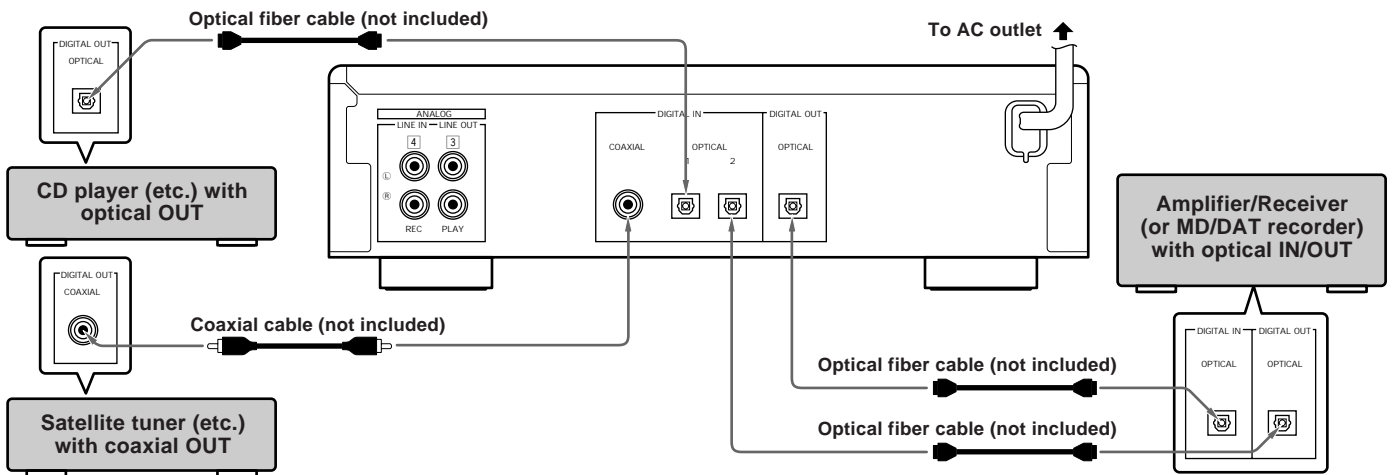

Notes for digital connections

- The DIGITAL IN terminals can be connected to any component with an optical or coaxial output so you can make direct digital recordings.
- The DIGITAL OUT terminal can be connected to a any component with an optical input so you can output digital audio from an MD.
- Before making OPTICAL connections, remove the terminal cover(s).
- In order to protect the terminals from dust, be sure to attach the terminal covers when the optical terminals are not being used.

PLAYBACK

Preparations

- Be sure to set the **TIMER** switch to OFF, then press **POWER** to turn this unit on.
- Set your amplifier or receiver to MD.

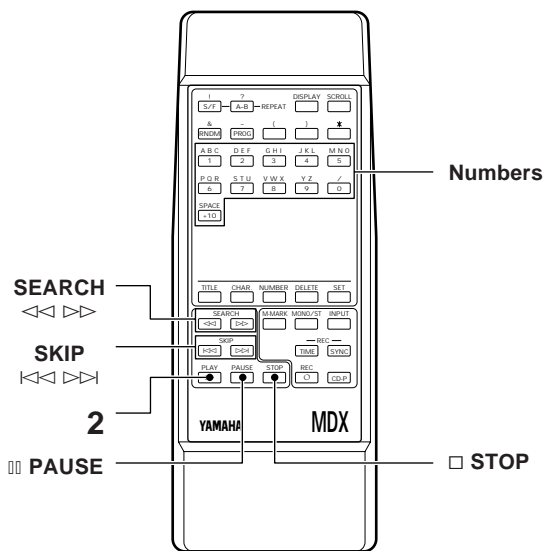
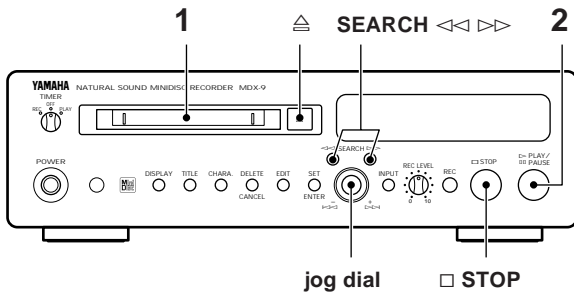

- 1 Insert an MD.

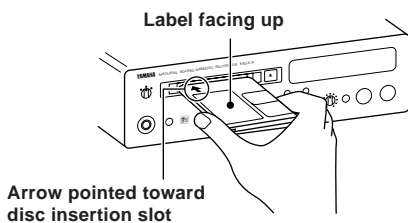

- 2 Press **▷ PLAY/⏸ PAUSE** (or **▷ PLAY** on the remote) to start playback.
- 3 Adjust the volume using the volume control on your amplifier or receiver.

To stop

Press **□ STOP**.

To pause

Press **▷ PLAY/⏸ PAUSE** (or **⏸ PAUSE** on the remote). Press again to resume playback (or press **▷ PLAY** on the remote).

To eject the MD

Press **△**.

Note

The MONO indicator lights when playing monaural MDs.

Skipping Tracks

To skip to the next track

Turn the jog dial to the right (or press **SKIP ▷▷** on the remote).

To skip to a previous track

Turn the jog dial to the left (or press **SKIP ◀◀** on the remote). Turn one click to skip to the beginning of the current track. Turn an additional click to skip to the beginning of each previous track.

To skip to a specific track number

Press the number buttons on the remote corresponding to the track you desire.

Example:

To select track 3, press **3**.

To select track 13, press **+10**, then press **3**.

To select track 23, press **+10** twice, then press **3**.

To skip to the last track on the disc

Turn the jog dial to the left when the display is showing the total tracks and total playing time.

Searching

To search forward during play or pause

Press and hold **SEARCH** ▷▷.

To search in reverse during play or pause

Press and hold **SEARCH** ◀◀.

Notes

- Sound can be heard when searching in play mode to help you locate the desired position within the track. No sound is heard when searching in pause mode, but the search is conducted at a higher speed.
- When searching in play mode, playback stops when you reach the end of the last track.
- Search may not function correctly when there are several consecutive tracks consisting of only a few seconds apiece.

Switching the Display

When you insert an MD the disc title is displayed automatically ("No Title" appears if there is no disc title). Pressing **DISPLAY** during stop or playback lets you display other information, such as the remaining time and track titles.

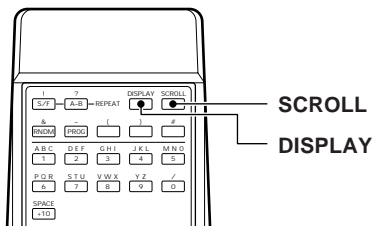
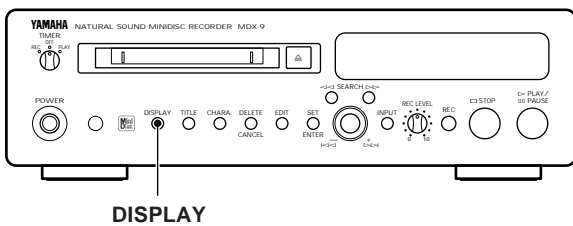

During stop

Press **DISPLAY** to repeatedly to display the following information.

① Number of tracks and total playing time

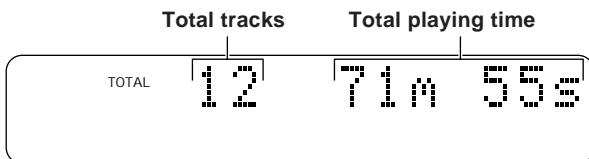

② Time remaining on the MD (only for recordable MDs)

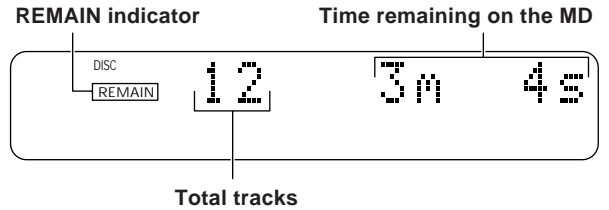

③ Disc title

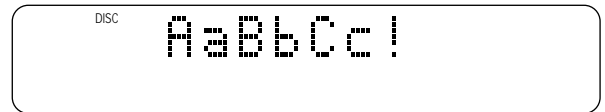

During playback

Press **DISPLAY** to repeatedly to display the following information.

① Current track number and elapsed time

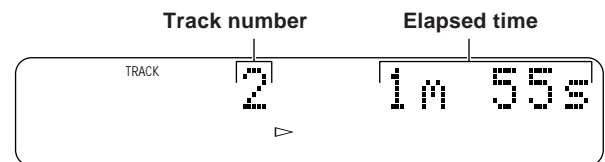

② Time remaining on the current track

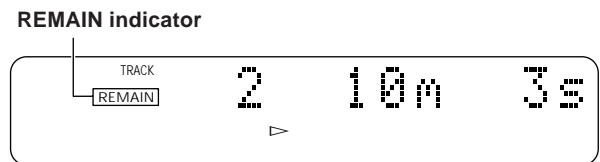

③ Track title

If the track has not been given a name, "No Title" is displayed and the display switches back to the elapsed time (①).



To view the entire disc (track) title

If the disc (track) title is too long to fit in the display, press **SCROLL**. Press **SCROLL** while the title is scrolling to stop the scrolling. Press again to continue scrolling through the title.

RANDOM PLAY

You can have the unit play all the tracks on a disc in a random sequence

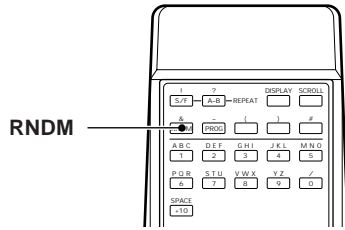

To start random playback

Press **RNDM**.

The RANDOM indicator lights up and "RandomSearch" appears in the display while the unit selects a track. Playback starts automatically.

To cancel

Press **RNDM** again to turn off the RANDOM indicator.

Notes

- Pressing **SKIP** ▷▷ during random play skips to another track at random. Pressing **SKIP** ◀◀ returns to the beginning of the current track (you cannot return to previously played tracks).
- If you turn the unit off during random playback, it will be ready for random play the next time you turn the power back on.

REPEAT PLAY

You can have the unit play a single track, the full disc, or just part of a track repeatedly.

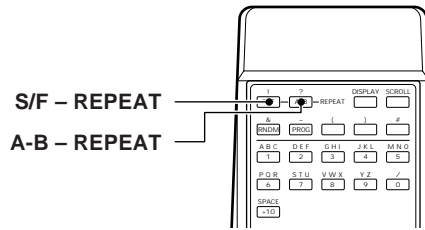

Single Track Repeat

- Select the track you want to repeat.
- Press **S/F - REPEAT** repeatedly to light the REPEAT S indicators.



To cancel

Press **S/F - REPEAT** repeatedly to turn off the REPEAT S indicators.

Note

Single track repeat is not available during random or program playback.

Full Disc Repeat

Press **S/F - REPEAT** repeatedly to light the REPEAT F indicators.



To cancel

Press **S/F - REPEAT** repeatedly to turn off the REPEAT F indicators.

Notes

- In program play mode, the entire program is played repeatedly.
- In random play mode, the unit reshuffles the tracks and plays them again after each track plays once.

Part (A-B) Repeat

This function lets you repeat a specific part of a track. It's a convenient way to study a language, or learn the lyrics to your favorite song (etc.).

- 1 Press **A-B – REPEAT** during playback to specify the beginning (A point) of the part you want to repeat.
The REPEAT A indicators light up.



- 2 Press **A-B – REPEAT** again to specify the end (B point) of the part you want to repeat.
The REPEAT A-B indicators light up and the part you specified starts to repeat.



To cancel

Press \square **STOP** or **A-B – REPEAT**.

PROGRAM PLAY

This function lets you enjoy listening to your favorite tracks in any order you desire.

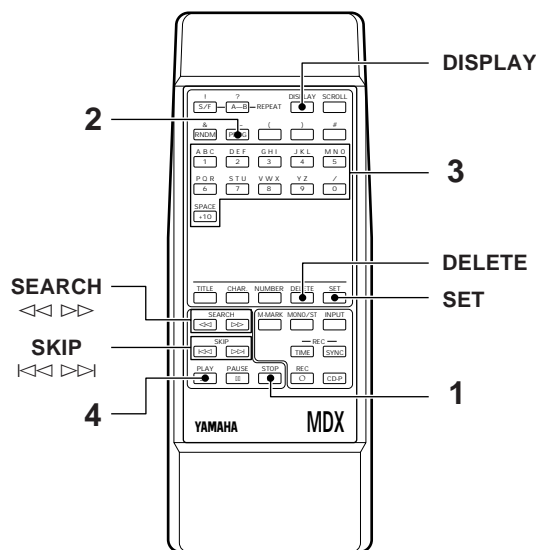

- 1 Press \square **STOP** to stop playback.
- 2 Press **PROG** to light up the PROGRAM indicator.
- 3 Program the desired track by pressing the corresponding numeric buttons.

Example:

To select track 3, press **3**.

To select track 13, press **+10**, then press **3**.

To select track 23, press **+10** twice, then press **3**.

The following display appears momentarily to show the step information:

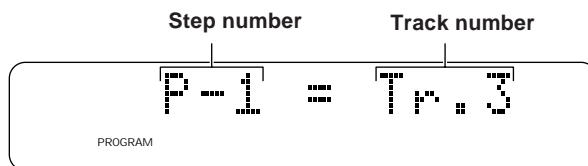

The display then switches to the program status:

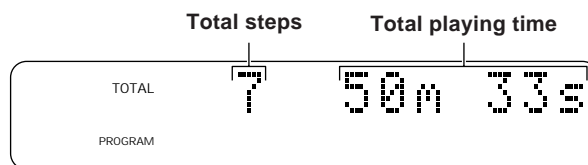

Repeat this operation to program of up to 30 steps.

- 4 Press \triangleright **PLAY** to start program playback.

Continued on next page

To check the programmed data

- 1 Stop or pause program playback.
- 2 Press **SKIP** ◀◀ or ▶▶ to skip through the step information (or use the jog dial on the front panel).

To delete a specific step

- 1 Stop program playback.
- 2 Press **SKIP** ◀◀ or ▶▶ to skip through the step information (or use the jog dial on the front panel).
- 3 Press **DELETE** (or **DELETE/CANCEL** on the front panel) to delete the step. The higher steps are renumbered automatically.

To change a step

- 1 Stop program playback.
- 2 Press **SKIP** ◀◀ or ▶▶ to skip through the step information (or use the jog dial on the front panel).
- 3 Use the numeric buttons to program a new track number for that step. The original track is cleared from memory and the new track is programmed.

To cancel

Press **PROG** To turn off the "PROGRAM" indicator, eject the disc, or set **POWER** to off.

Notes

- If the total time exceeds 255 minutes "255mOver" is displayed instead of the total time.
- **SKIP** ◀◀ or ▶▶ can be used during playback to skip between programmed tracks.
- **SEARCH** ▶▶ can be used during playback to search through all tracks in the current program.
- **SEARCH** ◀◀ can be used during playback return to the beginning of the current track.

RECORDING

This unit allows you to make recordings from a wide variety of program sources (both analog and digital). When recording an analog source (such as an LP or cassette) this unit converts the analog signals to 44.1 kHz digital signal before recording them onto the MD. When recording a digital source, this unit converts the digital signals to 44.1 kHz for recording onto the MD. However, If you are recording a 44.1 kHz source signal (such as a CD) there is no conversion. This unit can record 32, 44.1 and 48 kHz digital signals.

Preparations

- Be sure to set the **TIMER** switch to OFF, then press **POWER** to turn this unit on.
- Set your amplifier or receiver to the program source to be recorded.

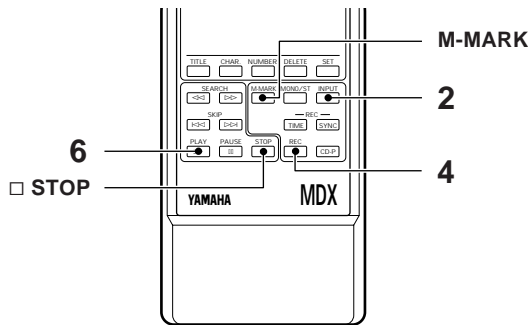
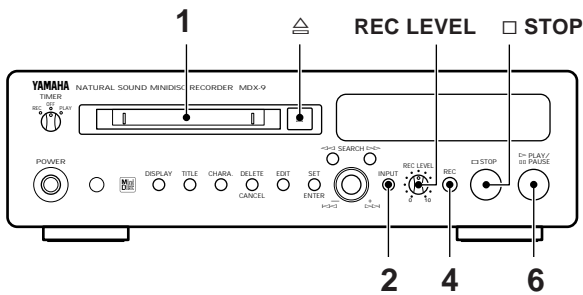

1 Insert an MD.

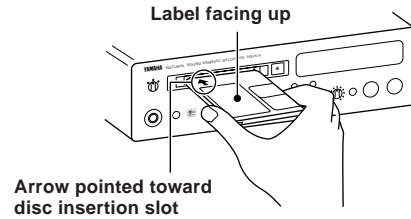

2 Press **INPUT** repeatedly to select the input connected to the sound source you want to record.

| For | Select |
|----------------------|----------------|
| LINE IN [4] | ANALOG |
| DIGITAL IN COAXIAL | DIGITAL COAX. |
| DIGITAL IN OPTICAL 1 | DIGITAL OPT. 1 |
| DIGITAL IN OPTICAL 2 | DIGITAL OPT. 2 |

Input indicator

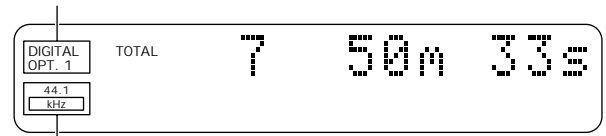

(Source) sampling frequency indicators*

* Appears when digital signal is input.

3 Locate the point where you want to start recording.

- **When recording from a blank MD**
Skip this step.
- **To start recording from the end of a previous recording.**
Press **STOP** to set this unit to stop mode.
- **To record over a previous recording.**
Turn the jog dial (or press **SKIP** **⏮** or **⏭** on the remote) to select a track (recording starts from the beginning of the deleted track), or press **PAUSE** during playback to pause at the point where you want to start recording.

Continued on next page

- 4** Press **REC** to set the this unit to record pause mode.
The REC  indicators light up.
"REC Standby" and the amount of time available for recording flash alternately in the display.



If you selected a track number or paused playback (in step 3) to record over a previous recording
"OverWriteOK?" appears in the display.
To confirm, press **ENTER**. This operation will erase the selected track number (or point) and all subsequent material.
To cancel, press **CANCEL** (or  **STOP**).

If you selected ANALOG in step 2, adjust the recording level as described in "Recording Level".

Note

When recording from a digital source that has a digital output (volume) control, set the output level (volume) to "MAX".
Recording may not be possible at low output levels (when the digital volume is turned down).

- 5** Start playing the program source to be recorded.

- 6** Press  **PLAY**/ **PAUSE** (or  **PLAY** on the remote) to start recording.
The TOC indicator lights up.
When the TOC indicator is lit, this means that the TOC information has not yet been written to the disc. After recording, eject the disc, or turn this unit's power off to write the TOC information and finalize the recording.

To stop

Press  **STOP**.

To pause

Press  **PLAY**/ **PAUSE** ( **PAUSE** on the remote).
Press again to resume recording.

To eject the MD

Press .

TOC writing may be impossible (or track number marking may not perform as expected) when recording a damaged CD or a broadcast source under interference.

Recording Level

To set the recording level, first set this unit to the record pause mode (press **REC**). Then play the loudest passage of the source to be recorded and watch the meter readings. Adjust the **REC LEVEL** control so that the highest peak causes the 0 dB level indicators to flicker. The OVER indicators should not light.

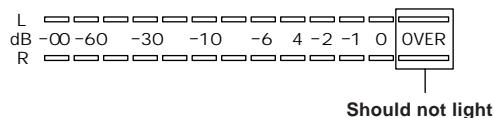

Note

Although some sources can be recorded with lower peak levels, setting the peak levels too low may degrade the quality of the recording.

Auto Marking

When making a recording, you can choose either automatic or manual marking. This feature operates somewhat differently for analog and digital signals. See below for details.

Press **M-MARK** on the remote repeatedly to select automatic (MANUAL indicator out) or manual (MANUAL indicator lit) marking.



When recording analog signals

Auto : Track numbers are written in synchronization with the input level of the signal being recorded. In other words, if the source signal falls below a certain level for more than 1.5 seconds a track number is written automatically the next time the source signal rises above that level.

Manual : One track number is written automatically when you start recording, but none are written during recording. To mark a track number, press **REC** at the desired position while recording.

Note

When using manual marking, the marks must be set at least 4 seconds apart.

When recording digital signals

Track numbers are written in the same positions as the original source (CD, etc.) with either automatic or manual marking.

To add additional track numbers, set **M-MARK** to MANUAL and press **REC** at the desired position while recording.

Note

When recording is paused, the portion recorded up to the pause is counted as an individual track. When recording is resumed, a new track number is created. On the other hand, if one track is recorded in continuous repetition, that track(s) is recorded as one continuous track with a single track number.

TIME RESCUE RECORDING

The Time Rescue (**TIME**) recording function allows you to start recording four seconds before you press record. During record pause mode, the MD recorder monitors the input signal and continuously maintains a four second memory "cache". Therefore, you can record a song that just started without cutting off the beginning. You may find this function useful when recording live broadcasts, or when you want to start recording from the beginning of a song without recording lots commercials (etc.).

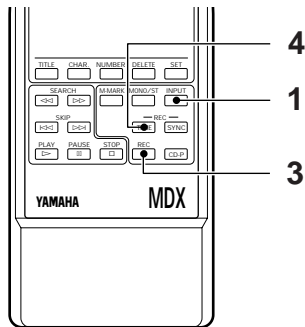

- 1 Press **INPUT** repeatedly to select the input connected to the sound source you want to record.
- 2 Locate the point where you want to start recording.
- 3 Press **REC** to set this unit to record pause mode. The REC  indicators light up. "REC Standby" and the amount of time available for recording flash alternately in the display. If you selected ANALOG in step 1, adjust the recording level as described in "Recording Level".
- 4 Press **TIME** to start recording when you hear the beginning of a song you want to record. Recording starts from the memory cache, allowing you to record from a point approximately four seconds before you pressed **TIME**.



Note

To take full advantage of the Time Rescue Recording function, be sure to wait at least four seconds between steps 3 and 4.

SYNCHRO RECORDING

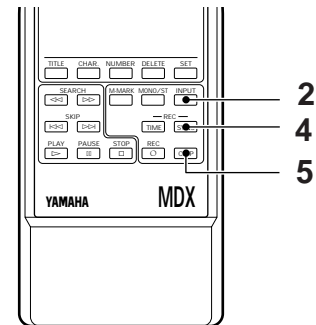
The synchronized recording function lets you set this unit to start recording automatically when a sound signal is input. When operating this unit in combination with a remote controllable Yamaha CD player, you can use the CD-PLAY button on this unit's remote control to start playback from the CD player.



- 1 Load the sound source into the source component. If necessary, program, or select the track you want to start recording from before proceeding to the next step. (Refer to the operation manual supplied with your source component for instructions regarding its use.)
- 2 Press **INPUT** repeatedly to select the input connected to the sound source you want to record.
- 3 Locate the point where you want to start recording.
- 4 Press **SYNC** to set this unit to record pause mode. The REC  indicators light up. "Synchro REC" and the amount of time available for recording flash alternately in the display. If you selected ANALOG in step 2, adjust the recording level as described in "Recording Level".
- 5 Start playing the sound source. (Press **CD-P** if recording from a Yamaha CD player.) The MD starts recording automatically when a sound signal is input. When the sound signal stops, the unit switches back to record pause mode and "Synchro REC" blinks in the display.
- 6 To continue recording, repeat step 5. When you have finished recording, press  **STOP** on this unit to cancel the record pause mode.

MONAURAL RECORDING

Recording in monaural (mono) allows you to record up to 148 minutes of sound on one 74 minute MD. (When recording in stereo you can record up to 74 minutes of sound.) This may be useful when recording an interview, debate, or other whenever you want to record a long time on one disc.

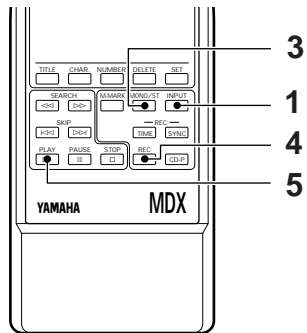

- 1 Press **INPUT** repeatedly to select the input connected to the sound source you want to record.
- 2 Locate the point where you want to start recording.
- 3 Press **MONO/ST** to light the MONO indicator.
- 4 Press **REC**.
The REC indicators light up.
"REC Standby" and the amount of time available for recording flash alternately in the display.
If you selected ANALOG in step 1, adjust the recording level as described in "Recording Level".
- 5 Press **▷ PLAY** to start recording.

MONITOR OUT

When a disc is not loaded, you can use the monitor out function to monitor the sound of the input source. This allows you to enjoy better sound from your other digital source components, such as CD, by using this unit as a digital to analog converter.

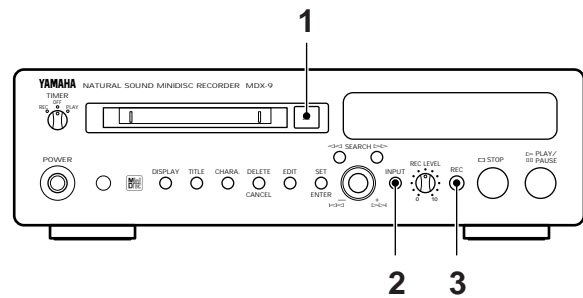

- 1 Press to remove the disc.
- 2 Press **INPUT** repeatedly to select the input connected to the sound source you want to monitor.
- 3 Press **REC**.
"MONITOR OUT" appears in the display.
Sound from the selected input will be output from this unit's analog and digital output terminals.
- 4 Start playing the sound source selected in step 2.
The sound is output from the MD recorder's analog and digital output terminals.

To cancel

Press **REC** again, press **STOP**, or insert a disc.

One of the main advantages of the MD is its editing capabilities, you can remove the commercials from a radio broadcast, reorder songs into the order you want to listen, remove songs, combine songs, even remove part of a song.

Edit functions

This unit offers the following editing operations. (Please note that track numbers are updated automatically when you perform a MOVE, ERASE, COMBINE or DIVIDE operation.)

- **MOVE**
Lets you move a track to a different track number.
- **ERASE**
Lets you erase a track, the entire disc, or part of a track.
- **COMBINE**
Lets you combine two adjacent tracks.
- **DIVIDE**
Lets you split a single track into two different tracks.
- **UNDO**
Lets you undo the previous edit operation if you make a mistake (you cannot, however, undo the undo).

Note

After performing an edit operation, the TOC indicator lights up to show that the TOC information has not yet been written to the disc. Undo is possible only when the TOC indicator is lit. However, if you perform a recording operation (by pressing **REC. TIME**, or **SYNC**), undo is not possible even if the TOC indicator is lit.

MOVE

This function lets you change the position of any track. First, you select the track you want to move, then you specify the track number you want to move it to. After the move, the tracks located between the old and new positions are renumbered automatically. You can perform this operation repeatedly to completely reorder the disc.

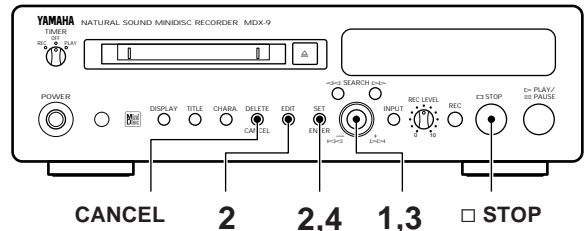

- 1 Turn the jog dial to select the track you want to move.
- 2 Press **EDIT** repeatedly to display "Move ?", then press **ENTER**.
- 3 Turn the jog dial to select the track's destination.

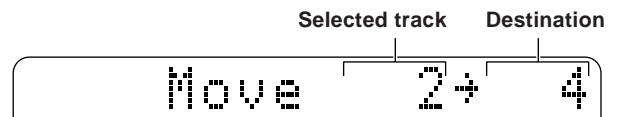

- 4 Press **ENTER**.

To cancel before moving the track

Press **CANCEL** (or **STOP**).

To undo MOVE

- 1 Press **STOP** to set this unit to stop mode.
- 2 Press **EDIT** repeatedly to display "Undo Move", then press **ENTER**.
"Undo OK ?" appears in the display.
- 3 Press **ENTER** again to undo.
To cancel, press **CANCEL** (or **STOP**).

ERASE

The ability to erase sound without having to re-record is another convenient function. You can erase the entire disc, a single track, or just part of a track.

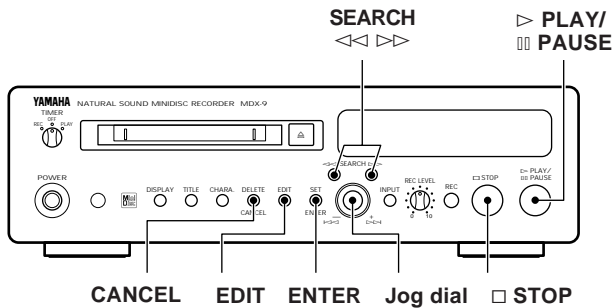

Disc Erase

This operation lets you erase all audio and title (character) data to create a blank MD. Please note that once erased, this data cannot be recovered.

- 1 Press **STOP** to set this unit to stop mode.
- 2 Press **EDIT** repeatedly to display "Disc Erase?", then press **ENTER**.
"DiscEraseOK?" appears in the display.
- 3 Press **ENTER** again.
When all audio, name and title data has been erased "Complete" appears momentarily.

To cancel before erasing the entire disc

Press **CANCEL** (or **STOP**).

To undo ERASE

- 1 Press **STOP** to set this unit to stop mode.
- 2 Press **EDIT** repeatedly to display "Undo Erase", then press **ENTER**.
"Undo OK ?" appears in the display.
- 3 Press **ENTER** again to undo.
To cancel, press **CANCEL** (or **STOP**).

Track Erase

This operation lets you erase a single track. After you erase the track, the total number of tracks decreases by one and all tracks following that track are renumbered.

If you plan to erase two or more tracks

To avoid confusion you should always erase from higher track numbers to lower track numbers. This prevents accidental renumbering of tracks you plan to erase.

- 1 Turn the jog dial to select the track you want to erase.
- 2 Press **EDIT** repeatedly to display "Erase ?", then press **ENTER**.
"(track number) EraseOK?" appears in the display.
- 3 Press **ENTER** again.
The track is erased and "Complete" appears momentarily.

To cancel before erasing the track

Press **CANCEL** (or **STOP**).

To undo ERASE

- 1 Press **STOP** to set this unit to stop mode.
- 2 Press **EDIT** repeatedly to display "Undo Erase", then press **ENTER**.
"Undo OK ?" appears in the display.
- 3 Press **ENTER** again to undo.
To cancel, press **CANCEL** (or **STOP**).

Part Erase

This operation lets you erase part of a track.

- 1 Press **▷ PLAY/⏸ PAUSE** to play the track containing the part you want to erase.
- 2 Use **SEARCH <<<** or **>>>** to locate the beginning of the part you want to erase (point A), then press **▷ PLAY/⏸ PAUSE** to pause at that point.
- 3 Press **EDIT** repeatedly to display "A-B Erase?", then press **ENTER**.
Point A (from step 2) is registered and "Erase A-_" appears in the display.
- 4 Use **▷ PLAY/⏸ PAUSE** and **SEARCH >>>** to locate the end of the part you want to erase (point B).
- 5 Press **ENTER** to register point B.
"Check" appears, then the part you specified plays repeatedly and "Erase A-B?" appears in the display.

To adjust point B

Turn the jog dial while the "B" of "Erase A-B?" is blinking. Point B can be adjusted up to 2 second (176 steps) in either direction.

- 6 Press **ENTER** again.
The part is erased and "Complete" appears momentarily.

To cancel before erasing the part

Press **CANCEL** (or **□ STOP**).

To undo ERASE

- 1 Press **□ STOP** to set this unit to stop mode.
- 2 Press **EDIT** repeatedly to display "Undo Erase", then press **ENTER**.
"Undo OK ?" appears in the display.
- 3 Press **ENTER** again to undo.
To cancel, press **CANCEL** (or **□ STOP**).

To erase parts spanning more than one track

Use the COMBINE function described below to combine the tracks into one track before performing this operation.

Note

After part erase, a new track number is automatically assigned to the section starting after point B.

COMBINE

This function lets you combine two consecutive tracks into one. After you combine the tracks, the total number of tracks decreases by one and the tracks following the combined tracks are renumbered.

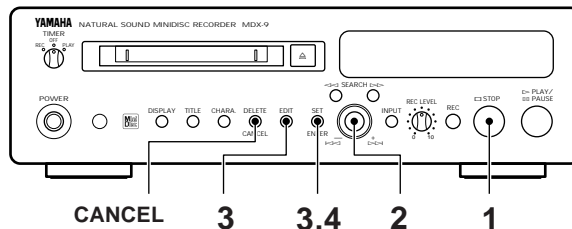

- 1 Press **□ STOP** to stop playback.
- 2 Turn the jog dial to select the second track of the two you want to combine.
- 3 Press **EDIT** repeatedly to display "Combine ?", then press **ENTER**.
"Check" appears momentarily, then the unit plays the 4 seconds before and after the point where the tracks will be connected. "(track number) + (track number) OK?" appears in the display.
- 4 Press **ENTER** again.
The tracks are combined and "Complete" appears momentarily.

To cancel before combining the tracks

Press **CANCEL** (or **□ STOP**).

To undo COMBINE

- 1 Press **□ STOP** to set this unit to stop mode.
- 2 Press **EDIT** repeatedly to display "UndoCombine", then press **ENTER**.
"Undo OK ?" appears in the display.
- 3 Press **ENTER** again to undo.
To cancel, press **CANCEL** (or **□ STOP**).

Notes

- This operation is not possible when track 1 is selected.
- You can also divide the track later using the DIVIDE function.
- If "Can't Edit" appears in the display the tracks cannot be combined. This sometimes happens when you have edited the same track many times. This is due to the technical limitations of the MD system and is not a mechanical error or malfunction.

DIVIDE

This function lets you divide one track into two separate tracks by adding a new track number to a certain point in the track. If you add a track number at the beginning of a section you want to hear, you can access it quickly by using the skip function during playback. After you divide a track, the total number of tracks increases by one and the tracks following the divided tracks are renumbered.

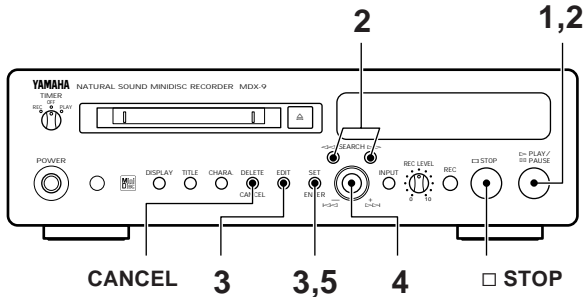

- 1 Press **▷ PLAY/⏸ PAUSE** to play the track you want to divide.
- 2 Use **SEARCH** **<<<** or **>>>** to locate the point where you want to divide the track, then press **▷ PLAY/⏸ PAUSE** to pause at that position.
- 3 Press **EDIT** repeatedly to display "Divide ?", then press **ENTER**.
"Check" appears momentarily, then "Divide OK ?" appears and the unit starts repeating the point where the track will be divided.
- 4 If necessary, use the jog dial to adjust the position of the point where the track will be divided.
The divide position can be adjusted up to 2 second (255 steps) in either direction.
- 5 Press **ENTER**.
The track is divided and "Complete" appears momentarily.

To cancel before dividing the track

Press **CANCEL** (or **□ STOP**).

To undo DIVIDE

- 1 Press **□ STOP** to set this unit to stop mode.
- 2 Press **EDIT** repeatedly to display "Undo Divide", then press **ENTER**.
"Undo OK ?" appears in the display.
- 3 Press **ENTER** again to undo.
To cancel, press **CANCEL** (or **□ STOP**).

Notes

- You can also combine the tracks later using the COMBINE function.

This function lets you title recorded MDs and the individual tracks. Titles may consist of uppercase and lowercase letters, numbers, and symbols for a maximum of up to 250 characters for each title.

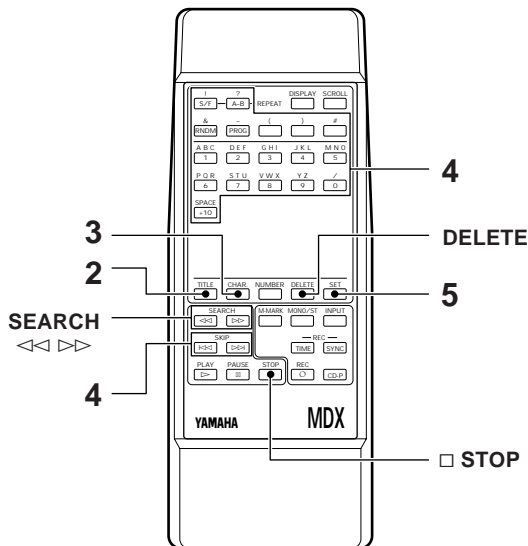
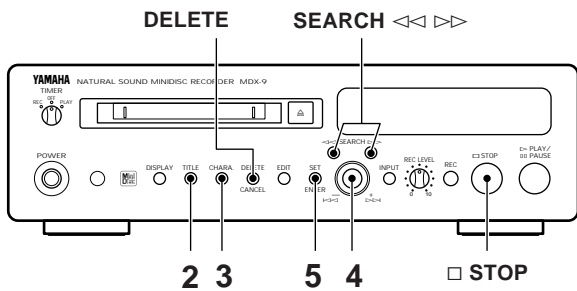

1 To title a disc

Press **STOP** to stop playback.

To title a track

• During stop mode

Use the jog dial (or **SKIP** << or >> on the remote) to select the track you want to title.

• During playback or pause

Use the jog dial (or **SKIP** << or >> on the remote) to select the track you want to title, or go directly to step 2 to title the current track.

During playback, the unit automatically repeats the selected track while you are entering the title.

• During recording

Go directly to step 2 to title the current track.

Recording continues normally while you are entering the title for the selected track.

2 Press **TITLE** to activate the title mode.

The cursor appears in the display.

3 Using the front panel

Press **CHARA.** repeatedly to select between uppercase letters (A), lowercase letters (a), and numbers (0).

Note : To access the symbols, press **CHARA.** repeatedly to select "A", then turn the jog dial to the left.

Using the remote

Press **CHAR.** repeatedly to select between uppercase letters (A) and lowercase letters (a).

4 Use the jog dial (or the character buttons (or **SKIP** << or >>) on the remote) to select a character, number, or symbol.

Example (using the remote):

To select "A", press **1 [ABC]** once.

To select "B", press **1 [ABC]** twice.

To select "C", press **1 [ABC]** three times.

To select "1", press **NUMBER**, then press **1 [ABC]**.

5 Press **SET** to move the cursor into position for the next character.

6 Repeat steps 3 through 5 to complete your title.

To delete a character (ABCD → ABD)

① Use **SEARCH** << or >> to move the cursor to the position of the character you want to delete.

② Press **DELETE**.

To insert a character (ABCD → ABTCD)

① Use **SEARCH** << or >> to move the cursor to the position where you want to insert the character.

② Use **CHARA.** and the jog dial (or **CHAR.** and the character buttons on the remote) to select the new character.

③ Press **SET** to set the character. The character previously in that position automatically moves to the right.

To insert a space (ABCD → AB_CD)

① Use **SEARCH** << or >> to move the cursor to the position where you want to insert the space.

② Press **+10 [SPACE]** on the remote.

7 Press **TITLE** to exit the title mode.

If a title consists of more than 12 characters, it will scroll across the display once and then be displayed in abbreviated form (first 12 characters only).

To undo TITLE

1 Press **STOP** to display the total tracks and total playing time on the disc.

2 Press **EDIT** repeatedly to display "Undo Title", then press **ENTER**.

"Undo OK ?" appears in the display.

3 Press **ENTER** again to undo.

To cancel, press **CANCEL** (or **STOP**).

TIMER OPERATIONS

With a commercially available audio timer it is possible to make recordings and initiate playback automatically at any time. Make sure that all power cord connections between the timer and amplifier/receiver are properly made. For details, refer to the instructions of your audio timer. No change in any of the other connections between the recorder and amplifier/receiver, etc., is necessary.

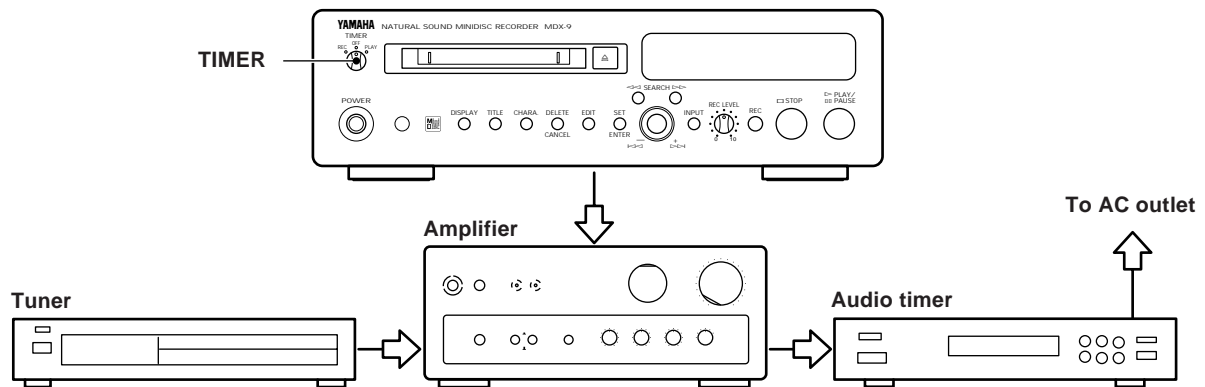

Timer Recording

- 1 Turn on the power to each component, then set your tuner to the station you want to record.
- 2 Set this unit's recording options. Select digital or analog inputs, auto or manual marking, and stereo or mono recording. When recording analog signals, be sure to set the recording level. (See pages 13, 14 and 16 for details regarding these operations.)
- 3 Turn down the volume on your amplifier/receiver. This has no effect on the recording level.
- 4 Set the timer to the times at which you want to start and stop recording. We recommend setting the timer to start a few minutes before and stop a few minutes after the actual broadcast to leave some room for later editing.
- 5 Set **TIMER** to REC.

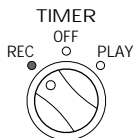

When the preset time arrives, the timer turns on the components (amplifier/receiver, tuner and MD recorder) and the MD recorder starts to record. When the stop time arrives, the timer stops the recording by turning off the components.

Notes

- When recording to a blank MD, recording starts from the beginning. When recording to a previously recorded MD, recording starts from the end of the last track.
- Set **TIMER** to OFF when not using the timer recording function. If the power is turned on (by pressing POWER, plugging in the power cord, etc.) when **TIMER** is set to REC, the MD recorder will start recording automatically.

Timer Playback

- 1 Turn on the amplifier/receiver and adjust the volume and tone controls.
- 2 Set the input mode selector of your amplifier/receiver to MD.
- 3 Set the timer to the times at which you want to start and stop playback.
- 4 Set **TIMER** to PLAY.

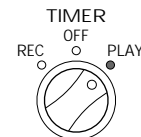

When the preset time arrives, the timer turns on the components (amplifier/receiver and MD recorder) and the MD recorder starts to play. When the stop time arrives, the timer stops the playback by turning off the components.

Notes

- Playback always starts from the beginning of the MD
- Set **TIMER** to OFF when not using the timer play function. If the power is turned on (by pressing POWER, plugging in the power cord, etc.) when **TIMER** is set to PLAY, the MD recorder will start to play and may cause a sudden output at high volume.

The recording system in your MD recorder is radically different from those used in cassette and DAT decks and is characterized by the limitations described below. Note, however, that these limitations are inherent to the MD recording system and are not a result of mechanical trouble.

“Can’t REC” is displayed before the maximum recording time (60 or 74 minutes) has been reached

Once 255 tracks have been recorded on one MD, “Can’t REC” is displayed regardless of the total recorded time. More than 255 tracks cannot be recorded on one MD. To continue recording, erase unnecessary tracks, combine tracks to reduce the total number of tracks, or use another recordable MD.

“Disc Full” is displayed before the maximum number of tracks (255) have been recorded

During Automatic Track Marking, fluctuations in emphasis within songs may be interpreted as song intervals, increasing the song count and causing “Disc Full” to be displayed.

The remaining recording time does not increase even after erasing numerous short tracks

Tracks under 12 seconds in length are not counted and so erasing them may not lead to an increase in the recording time.

“TOC Reading” is displayed continuously

The “TOC Reading” display lasts longer than normal when a brand new (blank) disc is inserted.

The total recorded time and the remaining time on the MD do not total to the maximum recording time

- Recording is done in minimum units of 2 seconds each, no matter how short the material. The contents recorded may thus be shorter than the maximum recording capacity. Disc space may also be further reduced by scratches.
- This unit displays the length of the largest continuous blank area as the remaining time. Therefore, if there are several separate blank spaces, the remaining time will only display a time equivalent to the largest continuous blank space.
If there is a 1 minute blank space and a 2 minute blank space, the remaining time display will be “2” minutes. If you then record 1 minute and 30 seconds of the 2 minute blank, the remaining time display will become “1” minute.

Tracks created through editing may exhibit sound dropout during search operations.

Track numbers are not recorded correctly

Incorrect assignment or recording of track numbers may result when CD tracks are divided into several smaller tracks during digital recording.

It is not possible to erase part of a track using the A-B ERASE function

This unit organizes the audio data in sound groups and clusters. The minimum size of these units varies according to the number of channels being recorded. For a 2 channel (stereo) recording, a single unit may not consist of less than 10 seconds of sound. For a 1 channel (mono) recording, a single unit may not consist of less than 20 seconds of sound.

Limitations when recording over an existing track

- The correct remaining recording time may not be displayed.
- You may find it impossible to record over a track if that track has been recorded over several times already. If this happens, erase the track using the Erase Function.
- The remaining recording time may be shortened out of proportion to the total recorded time.
- Recording over a track to eliminate noise is not recommended since this may shorten the duration of the track.
- You may find it impossible to label a track while recording over it.

The correct recorded/playing time may not be displayed during playback of monaural-format MDs.

COPY PROTECTION (SCMS)

As a digital audio component, this MD recorder conforms with the Serial Copy Management System (SCMS) standards. The Serial Copy Management System restricts copies made by recording digital signals to first-generation copies only. Therefore, an MD recorded through a digital input cannot be used as a source for making another digital recording.

However, subsequent recordings can be made from the first-generation copy by using the analog input/output jacks.

There are three general rules that apply to this unit.

Rule 1

You can record from digital program sources (CDs, DATs or pre-mastered MDs) onto a DAT tape or recordable MD via the digital input jack on a DAT or MD recorder. You cannot, however, record from this recorded DAT tape or MD to another DAT tape or recordable MD via a digital input jack.

Rule 2

You can record a digital signal input from a digital satellite broadcast onto a DAT tape or recordable MD via the digital input jack on the DAT or MD recorder. (This unit is equipped with a sampling rate converter that allows you to make digital recordings from 32 kHz, 44.1 kHz, or 48 kHz digital program sources).

If the broadcast does not contain a copyright protection code, you can then record the contents of this recorded DAT tape or MD (first-generation) onto another DAT tape or recordable MD via a digital input jack on the DAT or MD recorder to create a second generation digital copy (these copies may also be copied digitally). Note, however, that if the broadcast contains a copy protection code, second-generation digital copying will not be possible.

Rule 3

You can record a DAT tape or MD recorded via the DAT or MD recorder's analog input jack onto another DAT tape or MD via the DAT or MD recorder's digital output jack. You cannot, however, make a second-generation DAT tape or MD copy via the DAT or MD recorder's digital output jack.

NOTES REGARDING THE REMOTE CONTROL

Remote control operation range

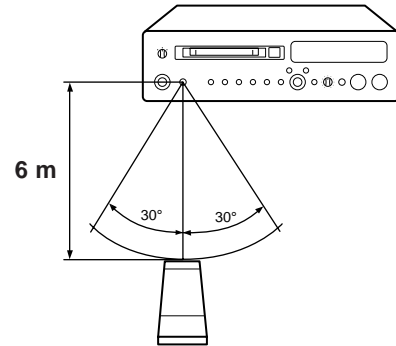

Notes

- There should be no large obstacles between the remote control and the remote sensor on the main unit.
- Strong light (especially from an inverter type fluorescent lamp) shining directly on the remote sensor may prevent proper operation. In such cases, reposition the main unit to avoid direct lighting.

Battery installation

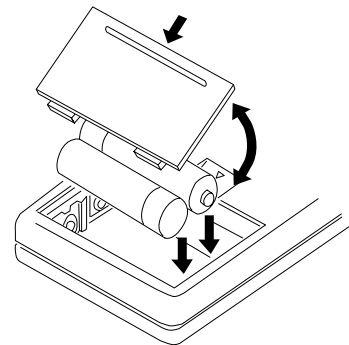

Battery replacement

When you notice a decrease in the operating range of the remote control, replace both batteries with new ones.

Notes

- Use only AA, R6, UM-3 batteries for replacement.
- Be sure to insert the batteries with correct polarity (as illustrated on the battery compartment).
- Remove the batteries if the remote control will not be used for an extended period of time.
- If batteries leak, dispose of them immediately. Avoid touching the leaking material or letting it come into contact with clothing, etc. Clean the battery compartment thoroughly before installing new batteries.

TROUBLESHOOTING

If your MD recorder fails to operate normally, check the following table. It lists common operating errors and simple measures which you can take to correct the problem. If it cannot be corrected, or the symptom is not listed, disconnect the recorder's power cord and contact your authorized YAMAHA dealer or service center for help.

| Fault | Cause | Cure |
|--|--|--|
| The unit does not respond to operations. | <ul style="list-style-type: none"> MD is dirty or damaged. MD is damaged ("UTOC ERR appears in the display). | <ul style="list-style-type: none"> Replace the current disc with a new one. |
| It happens that this unit does not work normally. | <ul style="list-style-type: none"> There is an influence of strong external noise (lightning, excessive static electricity, etc.) or a misoperation was performed while using this unit. | <ul style="list-style-type: none"> Turn this unit power off and disconnect the AC power from the AC outlet. After about 30 seconds have passed, connect the power and try again. |
| Playback is not possible. | <ul style="list-style-type: none"> Moisture on the laser pickup. The power is OFF. The disc has been loaded incorrectly. An unrecorded (blank) MD was loaded ("Blank Disc" appears in the display). | <ul style="list-style-type: none"> Leave the unit switched ON and wait 20 to 30 minutes for the moisture to evaporate before trying to play the disc. Press POWER to turn the power ON. Reload the disc with the label side facing up, and the arrow pointing toward the disc insertion slot. Insert a recorded MD. |
| Recording is not possible. | <ul style="list-style-type: none"> The disc is record protected ("Protected" appears in the display). A pre-mastered MD is loaded ("PlaybackMD" appears in the display). The source is not connected correctly. The input setting is incorrect. The recording level is too low. The digital output level of the digital source is too low. There is not enough blank space left on the MD. If the power cord was unplugged or there was a power outage during recording, that recording may be lost. | <ul style="list-style-type: none"> Slide the record-protect tab to the closed position. Load a recordable MD. Check all connections again. Press INPUT repeatedly to select the correct input jacks. Turn REC LEVEL to adjust the recording level. Set the digital output level of the digital source to "MAX". Load a recordable MD with fewer recorded tracks, or erase unnecessary tracks from the current MD. If recording was interrupted, try recording again starting from the beginning. |
| The MD cannot be removed when partially inserted. | <ul style="list-style-type: none"> The carriage lock function has activated. | <ul style="list-style-type: none"> Insert the MD completely, then press ▲ to eject it. |
| Excessive noise. | <ul style="list-style-type: none"> The unit is too close to a television or other component. | <ul style="list-style-type: none"> Place the unit farther away from the television or other component. |
| The remote control does not operate. | <ul style="list-style-type: none"> The batteries are exhausted. The remote control transmitter is operated from an incorrect distance or angle. The remote control sensor is located in strong direct light. | <ul style="list-style-type: none"> Replace batteries. Operate it from less than 6 meters (about 20 feet) and 30°. Place the unit away from the strong light. |

To clean the cabinet

Use a soft cloth slightly moistened with mild detergent solution.

Care of MDs

- Do not expose the MD to direct sunlight or heat sources such as hot air ducts, nor leave it in a car parked in direct sunlight as there can be a considerable rise in temperature inside the car.
- Periodically remove dust and debris from the cartridge surface by wiping it with a dry cloth.
- Because the MD itself is housed in a cartridge, you can handle it normally without being concerned about dirt or fingerprints. However, malfunctioning may result if the cartridge itself is dirty or warped.

Do not open the shutter on the MD cartridge

Trying to force the shutter open will damage the shutter.

DISPLAY MESSAGES

Can't Copy

You cannot make a digital recording. (See "COPY PROTECTION (SCMS)" on page 24.)

Can't Edit

Edit operations are not possible.

Can't Play!

Timer playback is not possible. The loaded disc may be blank, damaged, or it may be an incompatible format.

Can't REC!

Timer recording is not possible. The loaded disc may be protected or there may not be enough blank space remaining on the disc.

Can't REC

Recording is not possible because there is not enough blank space remaining on the disc.

DIGin Unlock

No digital signal being input to the selected digital input jack.

Disc Full

Recording is not possible because there is no blank space remaining on the disc.

Program Full

Additional steps cannot be programmed because the maximum number of steps (30) have already been programmed.

Title Full

Additional characters cannot be input for the current title because the maximum number of characters for a single title (250) have already been input.

UTOC WError

Error occurred when writing to the UTOC.

Not Audio

The inserted disc is not an audio MD.

Tr Protected

The selected track cannot be edited because it is protected.

TOC Full

The disc area allotted for TOC data has become full and further editing is not possible.

UTOC ERR L...

Problem involving UTOC data.

TMP Over!!

The temperature of the unit has exceeded the normal operating temperature. Turn off the unit and let it cool down. If the unit is installed in a place with little ventilation (such as a built in bookcase), move the unit to another location with better ventilation.

TOC Writing

The TOC data is being written to the disc. Do not move the unit or pull out the mains lead. If you do, recorded material may not be saved normally.

TOC Reading

The unit is reading the TOC data.

Protected

The record protection on the inserted MD is set to "protect".

Playback MD

The inserted MD is a designed for playback only (you cannot record on this disc).

MONITOR OUT

The monitor out function is active. The audio signal input to the selected input terminals is output from this unit's output terminals.

SPECIFICATIONS

Digital audio system

System

MiniDisc digital audio system

Disc

MiniDisc

Recording method

Magnetic field variation overwrite

Reading method

Non-contact optical pickup (using semiconductor laser)

Laser

Semiconductor laser

Laser Diode Properties

Material: GaAlAs

Wavelength: 780 nm

Pulse time:

Read mode ... 0.8 mW Continuous

Write mode ... max 10 mW 0.5S
min cycle 1.5S
Repetition

Record/playback time

Max. 74 minutes (using MDW-74 disc)

74 minutes (stereo)

148 minutes (mono)

Revolutions

Approx. 400-900 rpm (CLV)

Error Correction

ACIRC (Advanced Cross Interleave Reed-solomon Code)

Sampling frequency

44.1 kHz (32 kHz and 48 kHz signals converted to 44.1 kHz for recording)

Coding

ATRAC (Adaptive TRansform Acoustic Coding)

Modulation system

EFM (Eight-to-Fourteen Modulation)

Number of channels

2 (stereo) or 1 (mono, for extended recording)

Frequency Response

5 ~ 20,000 Hz \pm 0.5 dB

Signal-to-Noise Ratio

More than 98 dB during playback

Wow and Flutter

Below measurable limit

Inputs

LINE IN (REC)

Type: pin jack

Input impedance: greater than 27 k-ohms

Standard input level: 120 mV

DIGITAL IN (COAXIAL)

Type: pin jack

Input impedance: 75 ohms

Standard input level: 0.5 Vp-p

DIGITAL IN (OPTICAL) 1/2

Type: square optical connector jack

Outputs

LINE OUT (REC)

Type: pin jack

Standard output level: 2.0 \pm 0.5 Vrms

DIGITAL OUT (OPTICAL)

Type: square optical connector jack

GENERAL

Power Supplies

230 V, 50 Hz

Power Consumption

20 W

Dimensions (W x H x D)

280 x 82.5 x 362 mm (11" x 3-1/4" x 14-1/4")

Weight

4 kg (8 lbs. 13 oz.)

Accessories

Remote Control

1

Audio cord

2

Batteries (size AA, R6, UM-3)

2

Specifications subject to change without notice.

• **CAUTION**

Use the minidisc recorder only in accordance with the instructions given in this manual and do not attempt to interfere with the interlock switch or make any other adjustments as this may result in exposure to hazardous radiation.

• **VORSICHT**

Verwenden Sie den Mini-Disc Recorder nur entsprechend den in dieser Anleitung angegebenen Anweisungen, und versuchen Sie nicht, den Verriegelungsschalter zu beeinträchtigen, oder machen Sie keine andere Einstellung, da dies dazu führen kann, gefährlicher Ausstrahlung ausgesetzt zu werden.

• **ATTENTION**

Utiliser le lecteur-enregistreur minidisc en respectant les indications données dans ce manuel et éviter l'intervention sur le commutateur de verrouillage ou tout autre réglage. En cas de non-respect, on s'exposera à une radiation dangereuse.

• **PRECAUCIÓN**

Utilice el grabador/reproductor minidisc sólo de acuerdo con las instrucciones dadas en este manual y no intente interferir el interruptor de bloqueo ni realizar ningún otro ajuste porque podría ocasionar la exposición a radiación peligrosa.

• **OBSERVERA**

Använd den miniskivspelaren endast i enlighet med anvisningarna i denna bruksanvisning och försök inte påverka låsningsströmbrytaren eller göra andra inställningar som kan leda till risk för farlig strålning.

• **ATTENZIONE**

Quando si usa il registratore de minidisc, seguire le istruzioni di questo. Non cercare di interferire con l'interruttore interbloccato e non effettuare altre regolazioni, poiché ciò potrebbe provocare un'esposizione a pericolose radiazioni.

• **LET OP**

Gebruik deze MiniDisc-recorder alleen zoals in de aanwijzingen in deze gebruiksaanwijzing staat vermeld. Maak geen veranderingen in de interlockschakelaar of andere onderdelen, daar dit mogelijk blootstelling aan gevaarlijke stralingen veroorzaakt.

Klassmärkning för Finland

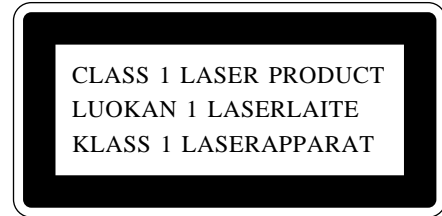

VÝSTRAHA: VÝROBEK JE VYBAVEN LASEREM. PŘI NESPRÁVNÉ MANIPULACI S PŘÍSTROJEM V ROZPORU S TÍMTO NÁVODEM MŮŽE DOJÍT K NEBEZPEČNÉMU OZÁŘENÍ. NEOTVÍREJTE A NESNÍMEJTE PRŮTO ŽÁDNÉ KRYTY A PŘÍSTROJ NEOPRAVUJTE. OPRÁVU A SERVIS SVĚŘTE ODBORNÉMU SERVISU.

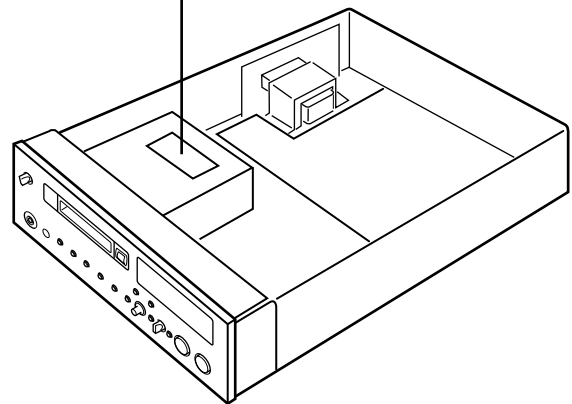
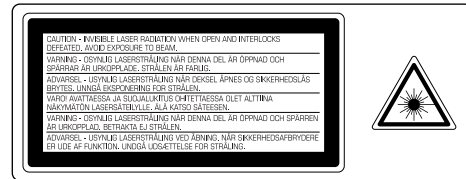

VAROITUS! LAITTEEN KÄYTTÄMINEN MUULLA KUIN TÄSSÄ KÄYTTÖOHJEESSA MAINITULLA TAVALLA SAATTAA ALTISTAA KÄYTTÄJÄN TURVALLISUUSLUOKAN 1 YLITTÄVÄLLE NÄKYMÄTTÖMÄLLE LASERSÄTEILYLLE.

VARNING - OM APPARATEN ANVÄNDS PÅ ANNAT SÄTT ÄN I DENNA BRUKSANVISNING SPECIFICERAS. KAN ANVÄNDAREN UTSÄTTAS FÖR OSYNLIG LASERSTRÅLNING, SOM ÖVERSKRIDER GRÄNSEN FÖR LASERKLASS 1.

YAMAHA ELECTRONICS CORPORATION, USA 6660 ORANGETHORPE AVE., BUENA PARK, CALIF. 90620, U.S.A.
YAMAHA CANADA MUSIC LTD. 135 MILNER AVE., SCARBOROUGH, ONTARIO M1S 3R1, CANADA
YAMAHA ELECTRONIK EUROPA G.m.b.H. SIEMENSSTR. 22-34, 25462 RELLINGEN, BEI HAMBURG, F.R. OF GERMANY
YAMAHA ELECTRONIQUE FRANCE S.A. RUE AMBROISE CROIZAT BP70 CROISSY-BEAUBOURG 77312 MARNE-LA-VALLÉE CEDEX02, FRANCE
YAMAHA ELECTRONICS (UK) LTD. YAMAHA HOUSE, 200 RICKMANSWORTH ROAD WATFORD, HERTS WD1 7JS, ENGLAND
YAMAHA SCANDINAVIA A.B. J A WETTERGRENS GATA 1, BOX 30053, 400 43 VÄSTRA FRÖLUNDA, SWEDEN
YAMAHA MUSIC AUSTRALIA PTY, LTD. 17-33 MARKET ST., SOUTH MELBOURNE, 3205 VIC., AUSTRALIA

YAMAHA CORPORATION

Printed in Japan

Ⓢ VZ 66730

Free Manuals Download Website

<http://myh66.com>

<http://usermanuals.us>

<http://www.somanuals.com>

<http://www.4manuals.cc>

<http://www.manual-lib.com>

<http://www.404manual.com>

<http://www.luxmanual.com>

<http://aubethermostatmanual.com>

Golf course search by state

<http://golfingnear.com>

Email search by domain

<http://emailbydomain.com>

Auto manuals search

<http://auto.somanuals.com>

TV manuals search

<http://tv.somanuals.com>