

DVD / SA-CD CHANGER  
LECTEUR DE DVD / SA-CD CHANGEUR

# DV-C6760

**OWNER'S MANUAL**  
**MODE D'EMPLOI**

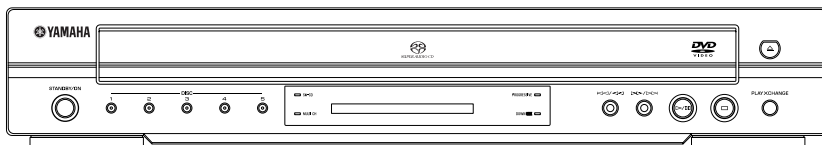

# IMPORTANT SAFETY INSTRUCTIONS

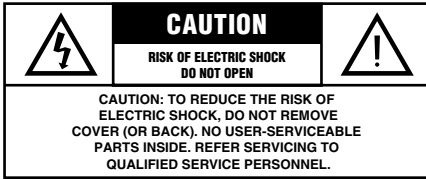

• Explanation of Graphical Symbols



The lightning flash with arrowhead symbol, within an equilateral triangle, is intended to alert you to the presence of uninsulated "dangerous voltage" within the product's enclosure that may be of sufficient magnitude to constitute a risk of electric shock to persons.



The exclamation point within an equilateral triangle is intended to alert you to the presence of important operating and maintenance (servicing) instructions in the literature accompanying the appliance.

- 1 Read Instructions — All the safety and operating instructions should be read before the product is operated.
- 2 Retain Instructions — The safety and operating instructions should be retained for future reference.
- 3 Heed Warnings — All warnings on the product and in the operating instructions should be adhered to.
- 4 Follow Instructions — All operating and use instructions should be followed.
- 5 Cleaning — Unplug this product from the wall outlet before cleaning. Do not use liquid cleaners or aerosol cleaners. Use a damp cloth for cleaning.
- 6 Attachments — Do not use attachments not recommended by the product manufacturer as they may cause hazards.
- 7 Water and Moisture — Do not use this product near water — for example, near a bath tub, wash bowl, kitchen sink, or laundry tub; in a wet basement; or near a swimming pool; and the like.
- 8 Accessories — Do not place this product on an unstable cart, stand, tripod, bracket, or table. The product may fall, causing serious injury to a child or adult, and serious damage to the product. Use only with a cart, stand, tripod, bracket, or table recommended by the manufacturer, or sold with the product.  
Any mounting of the product should follow the manufacturer's instructions, and should use a mounting accessory recommended by the manufacturer.
- 9 A product and cart combination should be moved with care. Quick stops, excessive force, and uneven surfaces may cause the product and cart combination to overturn.
- 10 Ventilation — Slots and openings in the cabinet are provided for ventilation and to ensure reliable operation of the product and to protect it from overheating, and these openings must not be blocked or covered. The openings should never be blocked by placing the product on a bed, sofa, rug, or other similar surface.  
This product should not be placed in a built-in installation such as a bookcase or rack unless proper ventilation is provided or the manufacturer's instructions have been adhered to.
- 11 Power Sources — This product should be operated only from the type of power source indicated on the marking label. If you are not sure of the type of power supply to your home, consult your product dealer or local power company. For products intended to operate from battery power, or other sources, refer to the operating instructions.



- 12 Grounding or Polarization — This product may be equipped with a polarized alternating current line plug (a plug having one blade wider than the other). This plug will fit into the power outlet only one way. This is a safety feature. If you are unable to insert the plug fully into the outlet, try reversing the plug. If the plug should still fail to fit, contact your electrician to replace your obsolete outlet. Do not defeat the safety purpose of the polarized plug.
- 13 Power-Cord Protection — Power-supply cords should be routed so that they are not likely to be walked on or pinched by items placed upon or against them, paying particular attention to cords at plugs, convenience receptacles, and the point where they exit from the product.
- 14 Lightning — For added protection for this product during a lightning storm, or when it is left unattended and unused for long periods of time, unplug it from the wall outlet and disconnect the antenna or cable system. This will prevent damage to the product due to lightning and power-line surges.
- 15 Power Lines — An outside antenna system should not be located in the vicinity of overhead power lines or other electric light or power circuits, or where it can fall into such power lines or circuits. When installing an outside antenna system, extreme care should be taken to keep from touching such power lines or circuits as contact with them might be fatal.
- 16 Overloading — Do not overload wall outlets, extension cords, or integral convenience receptacles as this can result in a risk of fire or electric shock.
- 17 Object and Liquid Entry — Never push objects of any kind into this product through openings as they may touch dangerous voltage points or short-out parts that could result in a fire or electric shock. Never spill liquid of any kind on the product.
- 18 Servicing — Do not attempt to service this product yourself as opening or removing covers may expose you to dangerous voltage or other hazards. Refer all servicing to qualified service personnel.
- 19 Damage Requiring Service — Unplug this product from the wall outlet and refer servicing to qualified service personnel under the following conditions:
  - a) When the power-supply cord or plug is damaged,
  - b) If liquid has been spilled, or objects have fallen into the product,
  - c) If the product has been exposed to rain or water,
  - d) If the product does not operate normally by following the operating instructions. Adjust only those controls that are covered by the operating instructions as an improper adjustment of other controls may result in damage and will often require extensive work by a qualified technician to restore the product to its normal operation,
  - e) If the product has been dropped or damaged in any way, and
  - f) When the product exhibits a distinct change in performance - this indicates a need for service.
- 20 Replacement Parts — When replacement parts are required, be sure the service technician has used replacement parts specified by the manufacturer or have the same characteristics as the original part. Unauthorized substitutions may result in fire, electric shock, or other hazards.
- 21 Safety Check — Upon completion of any service or repairs to this product, ask the service technician to perform safety checks to determine that the product is in proper operating condition.
- 22 Wall or Ceiling Mounting — The unit should be mounted to a wall or ceiling only as recommended by the manufacturer.
- 23 Heat — The product should be situated away from heat sources such as radiators, heat registers, stoves, or other products (including amplifiers) that produce heat.

## FCC INFORMATION (for US customers)

### 1. IMPORTANT NOTICE: DO NOT MODIFY THIS UNIT!

This product, when installed as indicated in the instructions contained in this manual, meets FCC requirements. Modifications not expressly approved by Yamaha may void your authority, granted by the FCC, to use the product.

### 2. IMPORTANT: When connecting this product to accessories and/or another product use only high quality shielded cables. Cable/s supplied with this product MUST be used. Follow all installation instructions. Failure to follow instructions could void your FCC authorization to use this product in the USA.

### 3. NOTE: This product has been tested and found to comply with the requirements listed in FCC Regulations, Part 15 for Class "B" digital devices.

Compliance with these requirements provides a reasonable level of assurance that your use of this product in a residential environment will not result in harmful interference with other electronic devices. This equipment generates/uses radio frequencies and, if not installed and used according to the instructions found in the users manual, may cause interference harmful to the operation of other electronic devices. Compliance with FCC regulations does not guarantee that interference will not occur in all installations. If this product is found to be the source of interference, which can be determined by turning the product "OFF" and "ON", please try to eliminate the problem by using one of the following measures:

Relocate either this product or the device that is being affected by the interference.

Utilize power outlets that are on different branch (circuit breaker or fuse) circuits or install AC line filter/s.

In the case of radio or TV interference, relocate/reorient the antenna. If the antenna lead-in is 300 ohm ribbon lead, change the lead-in to coaxial type cable.

If these corrective measures do not produce satisfactory results, please contact the local retailer authorized to distribute this type of product. If you can not locate the appropriate retailer, please contact Yamaha Electronics Corp., 6660 Orangethorpe Ave. Buena Park, CA90622.

The above statements apply ONLY to those products distributed by Yamaha Corporation of America or its subsidiaries.

## We Want You Listening For A Lifetime

YAMAHA and the Electronic Industries Association's Consumer Electronics Group want you to get the most out of your equipment by playing it at a safe level. One that lets the sound come through loud and clear without annoying blaring or distortion - and, most importantly, without affecting your sensitive hearing.

Since hearing damage from loud sounds is often undetectable until it is too late, YAMAHA and the Electronic Industries Association's Consumer Electronics Group recommend you to avoid prolonged exposure from excessive volume levels.



**CAUTION** VISIBLE AND INVISIBLE LASER RADIATION WHEN OPEN. AVOID EXPOSURE TO BEAM

**ADVARSEL** SYNLIG OG USYNLIG LASERSTRÅLING VED ÅBNING  
UNDGÅ UDSÆTTELSE FOR STRÅLING

**ADVARSEL** SYNLIG OG USYNLIG LASERSTRÅLING NÅR DEKSEL  
ÅPNEK UNNGÅ EKSPONERING FOR STRÅLEN

**VARNING** SYNLIG OCH OSYNLIG LASERSTRÅLNING NÅR  
DENNA DEL ÄR ÖPPNAD BETRakta EJ STRÅLEN

**VARO!** AVATTAESSA OLET ALTTIINA NÄKYVÄLLE JA  
NÄKYMÄTTÖMÄLLE LASER SÄTEILYLLE, ÄLÄ KATSO SÄTEESEEN

**VORSICHT** SICHTBARE UND UNSICHTBARE LASERSTRAHLUNG  
WENN ABDECKUNG GEÖFFNET NICHT DEM STRAHLE AUSSETZEN

**DANGER** VISIBLE AND INVISIBLE LASER RADIATION WHEN  
OPEN AVOID DIRECT EXPOSURE TO BEAM

**ATTENTION** RAYONNEMENT LASER VISIBLE ET INVISIBLE EN  
CAS D'OUVERTURE EXPOSITION DANGEREUSE AU FAISCEAU

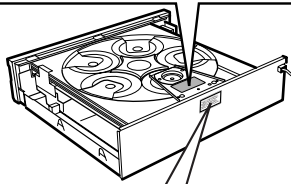

**CLASS 1 LASER PRODUCT  
LASER KLASSE 1 PRODUKT  
LUOKAN 1 LASERLAITE  
KLASS 1 LASER APPARAT  
PRODUIT LASER DE CLASSE 1**

### For Customer Use:

Read carefully the information located at the rear panel of the player and enter below the Serial No. Retain this information for future reference.

Model No. \_\_\_\_\_

Serial No. \_\_\_\_\_

### FOR CANADIAN CUSTOMERS

To prevent electric shock, match wide blade of plug to wide slot and fully insert.

This Class B digital apparatus complies with Canadian ICES-003.

This digital apparatus does not exceed the Class B limits for radio noise emissions from digital apparatus as set out in the Radio Interference Regulations of the Canadian Department of Communications.

### CAUTION

Use of controls or adjustments or performance of procedures other than those specified herein may result in hazardous radiation exposure.

# CAUTION: READ THIS BEFORE OPERATING YOUR UNIT.

- 1 To assure the finest performance, please read this manual carefully. Keep it in a safe place for future reference.
- 2 Install this sound system in a well ventilated, cool, dry, clean place — away from direct sunlight, heat sources, vibration, dust, moisture, or cold. In a cabinet, allow about 2.5cm (1 inch) of free space all around this unit for adequate ventilation.
- 3 Locate this unit away from other electrical appliances, motors, or transformers to avoid humming sounds.
- 4 Do not expose this unit to sudden temperature changes from cold to hot, nor locate this unit in an environment with high humidity (i.e., a room with a humidifier) to prevent condensation inside this unit, which may cause an electrical shock, fire, damage to this unit, and/or personal injury.
- 5 Avoid installing this unit in a location where foreign objects may fall onto this unit or where this unit may be exposed to liquid dripping or splashing. On the top of this unit, do not place:
  - Other components, as they may cause damage and/or discoloration on the surface of this unit.
  - Burning objects (i.e., candles), as they may cause fire, damage to this unit, and/or personal injury.
  - Containers with liquid in them, as they may fall, spilling the liquid and causing an electrical shock to the user and/or damage to this unit.
- 6 Do not cover this unit with a newspaper, tablecloth, curtain, etc. in order not to obstruct heat radiation. If the temperature inside this unit rises, it may cause fire, damage to this unit, and/or personal injury.
- 7 Do not plug in this unit to a wall outlet until all connections are complete.
- 8 Do not operate this unit upside-down. It may overheat, possibly causing damage.
- 9 Do not use excessive force on switches, knobs and/or cords.
- 10 When disconnecting the power cord from the wall outlet, grasp the plug; do not pull the cord.
- 11 Do not clean this unit with chemical solvents; this might damage the finish. Use a clean, dry cloth.
- 12 Use only the voltage specified on this unit. Using this unit with a higher voltage than specified is dangerous and may cause fire, damage to this unit, and/or personal injury. YAMAHA will not be held responsible for any damage resulting from use of this unit with a voltage other than as specified.
- 13 To prevent damage by lightning, disconnect the power cord from the wall outlet during an electrical storm.
- 14 Do not attempt to modify or fix this unit. Contact qualified YAMAHA service personnel when any service is needed. The cabinet should never be opened for any reason.
- 15 When not planning to use this unit for long periods of time (i.e., vacation), disconnect the AC power plug from the wall outlet.
- 16 Be sure to read the "TROUBLESHOOTING" section on common operating errors before concluding that this unit is faulty.
- 17 Before moving this unit, press STANDBY/ON to set the unit in standby mode, then disconnect the AC power plug from the wall outlet.

## WARNING

TO REDUCE THE RISK OF FIRE OR ELECTRIC SHOCK, DO NOT EXPOSE THIS UNIT TO RAIN OR MOISTURE.

When playing DTS encoded CDs, excessive noise will be heard from the analog stereo outputs. To avoid possible damage to the audio system, the consumer should take proper precautions when the analog stereo outputs of the player are connected to an amplification system. To enjoy DTS Digital Surround™ playback, an external 5.1-channel DTS Digital Surround™ decoder system must be connected to the digital output of the player.

## LASER SAFETY

This unit employs a laser. Due to possible eye injury, only a qualified service person should remove the cover or attempt to service this device.

## DANGER

This unit emits visible laser radiation when open. Avoid direct eye exposure to beam.

When this unit is plugged into a wall outlet, do not place your eyes close to the opening of the disc tray and other openings or look inside.

## Be sure to place this unit on a level surface.

If not so, this unit will fail to work normally at the PLAYXCHANGE operation and cause damage to the disc(s) and this unit itself.

## LASER

Type	Semiconductor laser GaAlAs
Wave length	650 nm (DVD) 780 nm (VCD/CD)
Output Power	7 mW (DVD/VCD/CD)
Beam divergence	60 degree

## Introduction

Region Codes .....	2
Supplied accessories.....	2
Notes about discs.....	2
Cleaning discs .....	2
Patent information.....	2

## Functional Overview

Front Panel.....	3
Rear Panel .....	4
Remote Control .....	5

## Preparation

General Notes on connections.....	6
Digital Connections .....	6
Analog Connections.....	6
6CH DISCRETE jacks.....	6
MIXED 2CH jacks.....	7
Video Connections.....	7
S-Video terminal <A>.....	7
Composite Video terminal <B>.....	7
Component Video terminal <C>.....	7

## Getting Started

Inserting batteries into the Remote Control.....	8
Using the remote control.....	8
Turning on the power.....	8
Selecting the color system that corresponds to your TV .....	8
Setting language preference .....	9
Setting the OSD Language.....	9
Setting the Audio, Subtitle and Disc menu language.....	10
Setting the speaker's channels.....	10

## Disc Operations

Basic Playback.....	12
General Operation.....	12
Pausing playback.....	12
Selecting track/chapter.....	12
Searching backward/forward.....	12
Stopping playback.....	12
Selecting various repeat/shuffle functions.....	13
Repeat.....	13
Repeating a section within a chapter/track.....	13
Shuffle (not for DVD/VCD/SVCD).....	13
Operations for video playback (DVD/VCD/SVCD).....	14
Using the Disc Menu.....	14
Zooming in.....	14
Resuming playback from the last stopped point.....	14
On-Screen Display (OSD).....	14
Special DVD Features.....	15
Playing a Title.....	15
Camera Angle.....	15
Audio.....	15
Subtitles.....	15

Special VCD & SVCD Features .....	16
Playback Control (PBC).....	16
Preview Function.....	16
SA-CD (Super Audio CD) .....	17
Playing a disc.....	17
Changing SA-CD playback area and layer.....	17
Audio CD.....	18
Playing a disc.....	18
Playing MP3/DivX/JPEG/Kodak Picture CD.....	18
General Operation.....	18
Selecting a folder and track/file.....	18
Special picture disc features .....	18
Preview Function (JPEG).....	18
Zoom picture.....	19
Playback with multi-angles.....	19
Scan Effect.....	19
Playing MP3 music and JPEG picture simultaneously.....	19

## Setup Menu

General Setup menu.....	20
Locking/Unlocking the disc for viewing.....	20
Programming disc tracks and discs .....	20
OSD Language.....	21
Screen Saver.....	21
Sleep Timer.....	21
DivX® VOD registration code.....	22
Audio Setup Menu .....	22
Setting the analog output.....	22
Setting the Digital output.....	23
Speaker Setup.....	23
CD Upsampling .....	23
Night Mode.....	24
Video Setup Menu.....	24
TV Type .....	24
Setting the TV Display.....	24
Progressive.....	25
Picture Setting.....	25
Selecting the black level (U.S.A. model only).....	26
Closed Caption (U.S.A. model only).....	26
Preference Setup Menu .....	26
Audio, Subtitle, Disc Menu.....	26
Restricting playback by Parental Control .....	27
PBC (Playback Control).....	27
MP3/JPEG Menu.....	27
Changing the Password.....	28
Restoring to original settings.....	28

## Language Code ..... 29

## Troubleshooting ..... 31

## Glossary ..... 33

## Specifications ..... 34

# Introduction

Thank you for purchasing this unit. This Owner's Manual explains the basic operation of this unit.

## Region Codes

DVD discs must be labeled for ALL regions, Region 1 (U.S.A model) or Region 4 (Australia model) in order to play on this Player. You cannot play Discs that are labeled for other regions.



## Supplied accessories

- Remote control
- Batteries (two AA size) for remote control
- Audio/Video cable
- Owner's Manual

## Notes about discs

- *This unit is designed for use with Super Audio CD (SA-CD), DVD-Video, Video CD, Super Video CD, Audio CD, CD-R, CD-RW, DVD+RW, DVD+R, DVD-R and DVD-RW.*

*This unit can play:*

- MP3, picture (Kodak, JPEG) files on CD-R(W).
  - JPEG/ISO 9660 format
  - Maximum 30 characters display.
- DivX<sup>®</sup> disc on CD-R[W]/DVD+R[W]/DVD-R[W] (3.11, 4.x and 5.x)
- CD-R and CD-RW cannot be played unless finalized.
- Some discs cannot be played depending on the recording conditions such as PC environment and application software. The characteristics and condition of the discs; materials, scratches, curvature, and etc., may result in failure.
- Be sure to use only CD-R and CD-RW discs made by reliable manufacturers.
- Do not use any non standard shaped discs (heart, etc.)
- Do not use disc with tape, scals, or paste on it, damage to the unit may result.

- *Do not use a disc printed on its surface by a commercially available label printer.*

## Cleaning discs

- When a disc becomes dirty, clean it with a cleaning cloth. Wipe the disc from the centre out. Do not wipe in a circular motion.
- Do not use solvents such as benzene, thinner, commercially available cleaners, or antistatic spray intended for analog records.

## Patent information



Manufactured under license from Dolby Laboratories. "Dolby", "Pro Logic" and the double-D symbol are trademarks of Dolby Laboratories.



"DTS" and "DTS Digital Surround" are registered trademarks of Digital Theater Systems, Inc.



DivX, DivX Certified, and associated logos are trademarks of DivXNetworks, Inc and are used under license.

This product incorporates copyright protection technology that is protected by method claims of certain U.S. patents and other intellectual property rights owned by Macrovision Corporation and other rights owners. Use of this copyright protection technology must be authorized by Macrovision Corporation, and is intended for home and other limited viewing uses only unless otherwise authorized by Macrovision Corporation. Reverse engineering or disassembly is prohibited.

## Front Panel

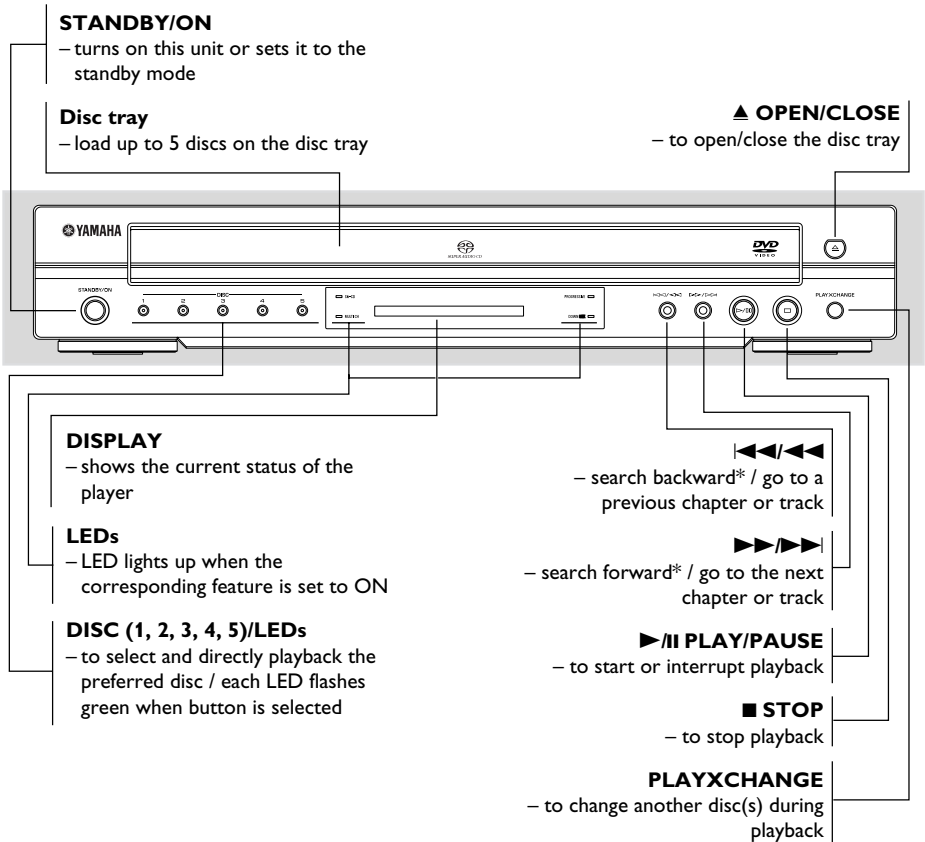

\* Press button for about two seconds.

# Functional Overview

## Rear Panel

### COMPONENT video outputs

- connect to an AV receiver with Y Pb/Cb Pr/Cr inputs

### AUDIO OUT - 6CH DISCRETE

- connect to 6CH INPUT inputs of your AV receiver

### AUDIO OUT - MIXED 2CH

- connect to AUDIO inputs of your AV receiver or stereo system

### AC Power Cord

- connect to a standard AC outlet

### DIGITAL OUT - OPTICAL

- connect to OPTICAL input of your AV receiver

### DIGITAL OUT - COAXIAL

- connect to COAXIAL input of your AV receiver

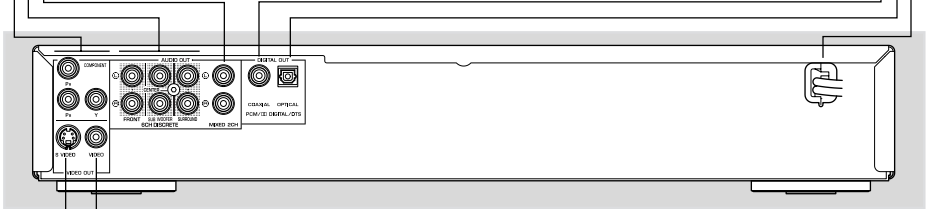

### VIDEO OUT - VIDEO

- connect to VIDEO (composite) input of your AV receiver

### VIDEO OUT - S VIDEO

- connect to S VIDEO input of your AV receiver

**Caution: Do not touch the inner pins of the jacks on the rear panel. Electrostatic discharge may cause permanent damage to the unit.**



## Remote Control

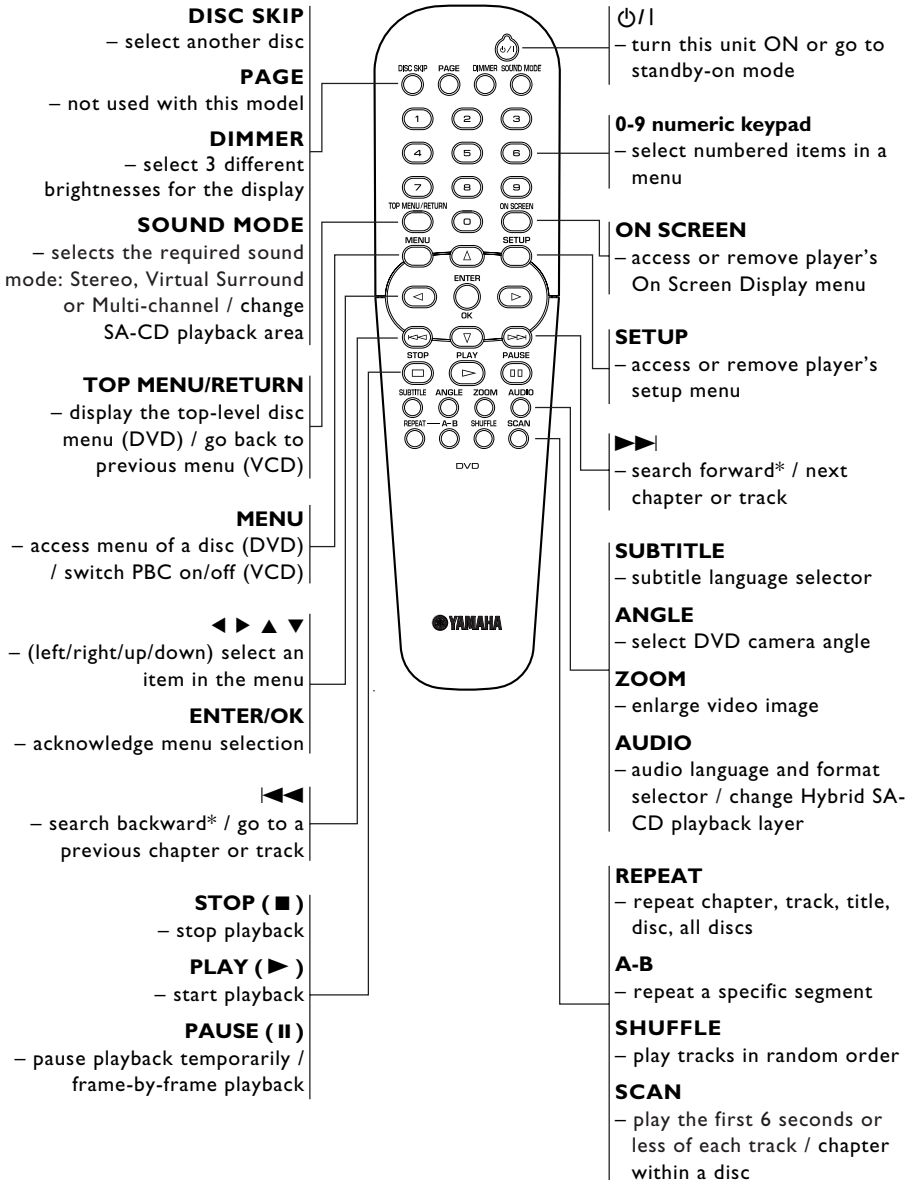

\* Press and hold button for about two seconds.

# Preparation

## General Notes on connections

Never make or change connections with the power switched on.

- Depending on the equipment you wish to connect, there are various ways you could connect this unit. Possible connections are shown in the following drawings.
- Please refer to the manuals of other equipment as necessary to make the best connections.
- Do not connect this unit via your VCR. The video quality could be distorted by the copy protection system.
- Do not connect this unit's audio out jack to the phono in jack of your audio system.

## Digital Connections

This unit has COAXIAL and OPTICAL digital out jacks. Connect one or both of them to your AV receiver equipped with Dolby Digital, DTS, or MPEG decoder using each specific cable (separate purchase).

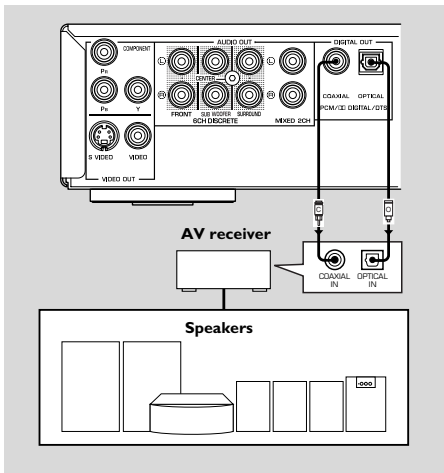

**You will need to set this unit's digital output to ALL (see page 23 "DIGITAL OUTPUT").**

Notes:

- If the audio format of the digital output does not match the capabilities of your receiver, the receiver will produce a strong, distorted sound or no sound at all. Make sure to select the appropriate audio format at menu screen included on the disc. Pressing **AUDIO** once or more may change not only audio languages but also audio formats, and the selected format appears for several seconds on the status window.
- SA-CD audio signal is not output from DIGITAL OUT jacks.
- If you wish to enjoy Dolby Digital, DTS, and MPEG you must connect this unit to the AV receiver that support those.

## Analog Connections

This player has two types of analog output jacks.

## 6CH DISCRETE jacks

To reproduce multi-channel Super audio CD, connect these jacks to your AV receiver's multi channel input jacks using commercially available audio pin cables.

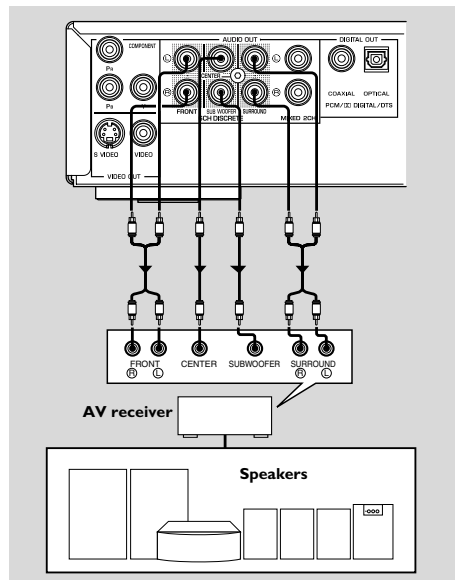

## MIXED 2CH jacks

Use audio/video cable supplied with this player to connect the L (left) and R (right) jacks to corresponding input jacks of your audio equipment such as Stereo amplifier. You can connect a subwoofer to the SUBWOOFER jack.

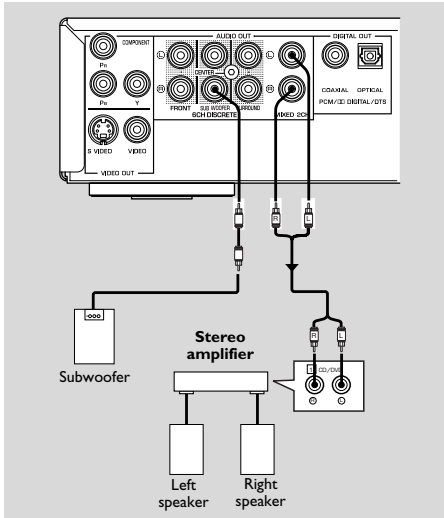

## Video Connections

If your AV receiver has video output jacks, connect your receiver (and then to your TV) so that you can use one TV for several different video sources (LD, VCR etc.) by simply switching the input source selector of your receiver.

The player has three types of video output jacks. Use one of them in accordance with the input jacks of the equipment to be connected.

### S-Video terminal <A>

S (separate) video connection achieves a clearer picture than composite video connection by separating color and luminance when transmitting signals. Use

commercially available S-video cable. Receiver (and TV) with S-video input is required.

### Composite Video terminal <B>

Use audio/video cable supplied with this unit when connecting the player to a TV.

### Component Video terminal <C>

Component video connection achieves high fidelity in reproducing colors (better performance than S-video connection), separating video signal into luminance (Y, terminal color-coded as green), and color difference (Pb, blue/Pr, red). Use commercially available coaxial cables. Receiver (and TV) with component input is required. Observe the color of each jack when connecting. If your receiver does not have component output jacks, connecting the player's component output directly to your TV's component input can reproduce better video image.

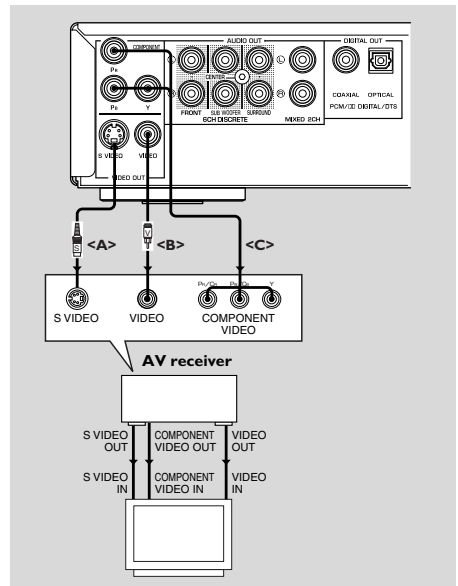

# Getting Started

## Step1: Inserting batteries into the Remote Control

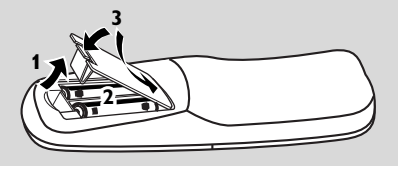

- 1 Open the battery compartment.
- 2 Insert two batteries type R06 or AA, following the indications (+ -) inside the compartment.
- 3 Close the cover.

## Using the remote control

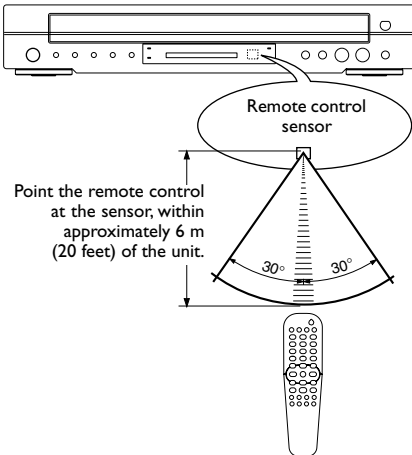

## Handling the remote control

- Do not spill water or other liquids on the remote control.
- Do not drop the remote control.
- Do not leave or store the remote control in the following types of conditions:
  - high humidity such as near a bath
  - high temperature such as near a heater or stove
  - extremely low temperature
  - dusty places

## Step2: Turning on the power

- 1 Connect the AC power cord to the power outlet.
- 2 Turn on the TV and your AV receiver.
- 3 Select the appropriate input source at the AV receiver that was used to connect to this unit. Refer to the equipment owner's manual for detail.
- 4 Turn this unit on.
- 5 Set the TV to the correct Video IN channel. (e.g. EXT1, EXT2, AV1, AV2, AUDIO/VIDEO, etc. Refer to your TV owner's manual for detail)  
→ The front display lights up and the default screen appears on the TV.

## Step3: Selecting the color system that corresponds to your TV

This DVD Player is compatible with both NTSC and PAL. Select the color system that matches your TV.

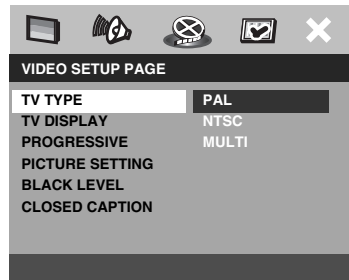

- 1 Press **SETUP**.
- 2 Press **▶** repeatedly to select {VIDEO SETUP PAGE}.
- 3 Press **▲▼** to highlight {TV TYPE}, then press **▶**.

- 4 Press ▲▼ to highlight one of the options below:

## PAL

Select this if the connected TV is PAL system. It will change the video signal of a NTSC disc and output in PAL format.

## NTSC

Select this if the connected TV is NTSC system. It will change the video signal of a PAL disc and output in NTSC format.

## MULTI

Select this if the connected TV is compatible with both NTSC and PAL (multi-system). The output format will be in accordance with the video signal of the disc.

- 5 Select an item and press **ENTER/OK**.

### *Helpful Hint:*

- **Before changing the current TV Standard setting, ensure that your TV supports the 'selected TV Type' system.**
- **If there is not proper picture on your TV, wait for 15 seconds for auto recover.**

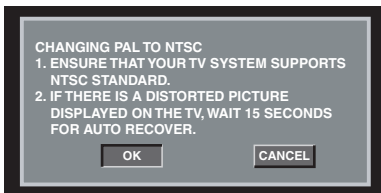

## Step4: Setting language preference

You can select your own preferred language settings. This DVD Player will automatically switch to the language for you whenever you load a disc. If the language selected is not available on the disc, the disc's default language will be used instead. The OSD language in the system menu, will remain once selected.

### Setting the OSD Language

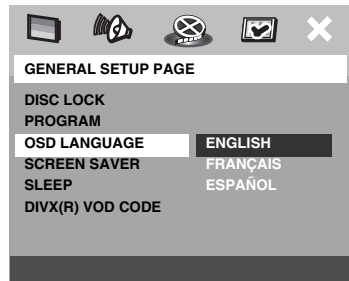

(U.S.A. model)

- 1 Press **SETUP**.
- 2 Press ◀▶ to select {GENERAL SETUP PAGE}.
- 3 Press ▲▼ to highlight {OSD LANGUAGE}, then press ▶.
- 4 Press ▲▼ to select a language and press **ENTER/OK**.

**TIPS:** To return to the previous menu, press ◀.  
To remove the menu, press **SETUP**.

# Getting Started

## Setting the Audio, Subtitle and Disc menu language

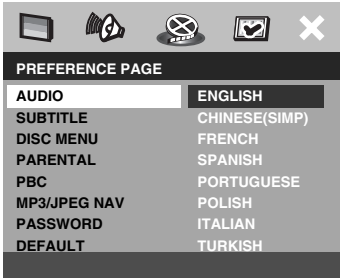

- 1 Press **STOP** ■ twice, then press **SETUP**.
- 2 Press ► repeatedly to select {PREFERENCE PAGE}.
- 3 Press ▲▼ to highlight one of the options below at a time, then press ►.
  - 'AUDIO' (disc's soundtrack)
  - 'SUBTITLE' (disc's subtitles)
  - 'DISC MENU' (disc's menu)
- 4 Press ▲▼ to select a language and press **ENTER/OK**.

If the language you want is not in the list, then select {OTHERS}, then use the **numeric keypad (0-9)** on the remote to enter the 4-digit language code (see page 29 "Language Code") and press **ENTER/OK**.

- 5 Repeat steps 3–4 for other language settings.

## Step5: Setting the speaker's channels

You can adjust the delay times (center and surround only) and volume level for individual speakers. These adjustments let you optimize the sound according to your surroundings and setup.

### IMPORTANT!

The speaker settings only available on Multi-channel audio outputs.

- 1 Press **SETUP**.
- 2 Press ► repeatedly to select {AUDIO SETUP PAGE}.
- 3 Press ▲▼ to highlight {SPEAKER SETUP}, then press ►.

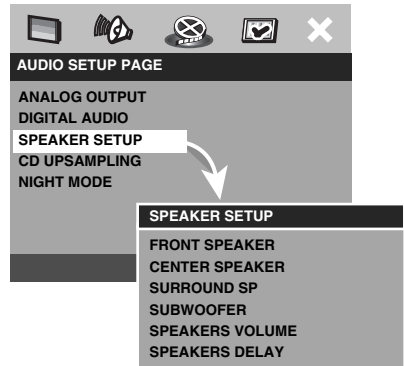

- 4 Enter its submenu by pressing ►.
- 5 Press ▲▼ to highlight one of the options below at a time, then press ►.

**TIPS:** To return to the previous menu, press ◀.  
To remove the menu, press **SETUP**.

## {FRONT SPEAKER, CENTER SPEAKER, SURROUND SP}

### OFF (only for CENTER and SURROUND)

When no speaker is connected.

### LARGE

When connected speakers can produce low frequency signals below 120 Hz.

### SMALL

When connected speakers cannot produce low frequency signals below 120 Hz.

## {SUBWOOFER}

### ON

When a subwoofer is connected.

### OFF

When no subwoofer is connected.

## {SPEAKERS VOLUME}

Volume level setting for individual speakers (-6 dB ~ +6 dB).

SPEAKERS VOLUME SETUP		
FRONT LEFT	<input type="range"/>	0dB
FRONT RIGHT	<input type="range"/>	0dB
CENTER	<input type="range"/>	0dB
SUBWOOFER	<input type="range"/>	0dB
SURROUND L	<input type="range"/>	0dB
SURROUND R	<input type="range"/>	0dB

## {SPEAKERS DELAY}

Delay times setting in relation to the listening position/distance for center and surround speakers (0 MS~15 MS).

SPEAKERS DELAY SETUP		
CENTER	<input type="range"/>	0 MS
SURROUND L	<input type="range"/>	0 MS
SURROUND R	<input type="range"/>	0 MS

- Press ◀▶ to adjust the setting that best suit your surround sound needs.
- Press **ENTER/OK** to confirm.

### Helpful Hints:

- Use the longer delay time settings when the surround speakers are closer to the listener than the front speakers.
- The test tone will be automatically generated to help you judge the sound level of each speaker.

**TIPS:** To return to the previous menu, press ◀.  
To remove the menu, press **SETUP**.

# Disc Operations

## IMPORTANT!

- If the inhibit icon (⊘ or X) appears on the TV screen when a button is pressed, it means the function is not available on the current disc or at the current time.
- Depending on the DVD or VIDEO CD, some operations may be different or restricted.
- Do not push on the disc tray or put any objects other than disc on the disc tray. Doing so may cause the disc player malfunction.

## Basic Playback

- 1 Press **STANDBY/ON** on the front panel.
- 2 Press **OPEN/CLOSE ▲** on the front panel to open disc loading tray.
- 3 Place the chosen discs in the tray, with the label facing up.
- 4 Press **PLAY ►**.  
→ The disc tray closes and playback starts automatically with all the loaded discs on the tray in sequence.
- 5 To stop playback, press **STOP ■**.

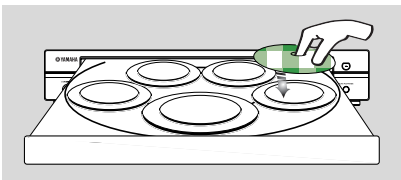

- To playback a specific disc directly, press **DISC SKIP** repeatedly on the remote control or one of the **DISC (1, 2, 3, 4, 5)** on the front panel.
- Press **PLAYXCHANGE** on the front panel to open the disc tray and reload or unload any discs without interrupting current disc playback.
- Playback will stop after all discs have been played.

- When the disc tray is open, pressing **PLAY ►**, **OPEN/CLOSE ▲**, **PLAYXCHANGE**, **DISC (1, 2, 3, 4, 5)** will close the disc tray automatically.

## General Operation

Unless otherwise stated, all operations described are based on Remote Control use.

## Pausing playback

- 1 During playback, press **PAUSE II**.  
→ Playback will pause and sound will be muted.
- 2 Press **PAUSE II** again to select the next picture frame.
- 3 To resume normal playback, press **PLAY ►**.

## Selecting track/chapter

- Press **|◀◀ / ▶▶|** or use the **numeric keypad (0-9)** to key in a track/chapter number.  
→ If repeat mode is active, pressing **|◀◀ / ▶▶|** will replay the same track/chapter.

## Searching backward/forward

- Press and hold **|◀◀ / ▶▶|**, then press **PLAY ►** to resume normal playback.  
→ While searching, pressing **|◀◀ / ▶▶|** again will increase the search speed.

Note:

- For MP3, WMA, DivX<sup>®</sup>, the search function allows you to search within the currently playing track.

## Stopping playback

- Press **STOP ■**.

**TIPS:** The operating features described here might not be possible for certain discs. Always refer to the instructions supplied with the discs.



## Selecting various repeat/shuffle functions

### Repeat

#### Repeat chapter/title/disc (DVD)

Each time you press **REPEAT**, the front display changes as follows;

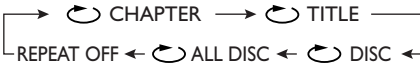

- ↻ CHAPTER\*: repeat the current chapter
  - ↻ TITLE: repeat the current title
  - ↻ DISC\*: repeat the entire disc
  - ↻ ALL DISC: repeat all discs loaded on the tray
  - REPEAT OFF: exit repeat mode
- \* This feature may not be available with some discs.

#### Repeat track/disc (except DVD)

Each time you press **REPEAT**, the front display changes as follows;



- ↻ TRACK: repeat the current track
- ↻ DISC: repeat the entire disc
- ↻ ALL DISC: repeat all discs loaded on the tray
- REPEAT OFF: exit repeat mode

#### Note:

- When only one disc is available on the disc tray, continuous playback will apply when ↻ ALL DISC is selected.

#### Helpful Hint:

- For VCD, repeat playback is not possible if the PBC mode is switched on.

### Repeating a section within a chapter/track

- 1 While playing a disc, press **A-B** at your chosen starting point.
- 2 Press **A-B** again at your chosen end point.
  - The section A and B can be set only within the same chapter/track.
  - The section will now repeat continuously.
- 3 To exit the sequence, press **A-B**.

### Shuffle (not for DVD/VCD/SVCD)

With the Shuffle function, you can play tracks in random order.

- 1 During playback, press **SHUFFLE** repeatedly to select SHUFFLE DISC, SHUFFLE ALL DISC, or SHUFFLE OFF.
    - The selected mode appears on the display for several seconds.
- In SHUFFLE DISC mode, all tracks on the disc currently playing are played in random order. For Hybrid SA-CDs, tracks on the SA-CD layer are played by default (see page 17).
  - In SHUFFLE ALL DISC, tracks from all discs are played in random order:
    - If the disc currently playing is a CD, only tracks from CDs and the CD layer of SA-CDs will be played.
    - If the disc currently playing is in SA-CD (SA-CD layer), MP3, WMA, DivX<sup>®</sup>, tracks on the disc currently playing are played in random order. When all the tracks on that disc have been played, shuffle playback continues with the next disc.

**TIPS:** The operating features described here might not be possible for certain discs. Always refer to the instructions supplied with the discs.

# Disc Operations

## Operations for video playback (DVD/VCD/SVCD)

### Using the Disc Menu

Depending on the disc, a menu may appear on the TV screen once you load in the disc.

#### To select a playback feature or item

- Use ◀▶▲▼ or **numeric keypad (0-9)** on the remote, then press **ENTER/OK** to start playback.

#### To access or remove the menu

- Press **MENU** on the remote.

### Zooming in

This function allows you to enlarge the picture on the TV screen and to pan through the enlarged picture.

- 1 During playback, press **ZOOM** repeatedly to display the picture with different scales.  
→ Use ◀▶▲▼ to pan through the enlarged picture.  
→ Playback will continue.
- 2 Press **ZOOM** repeatedly to return to the original size.

### Resuming playback from the last stopped point

Resume playback of the last 10 discs is possible, even if the disc was ejected or the power switched off.

- Load one of the last 10 discs.  
→ "LOADING" appears.
- Press **PLAY** ▶ and the disc will be played back from the last point.

#### To cancel resume mode

- In stop mode, press **STOP** ■ again.

### On-Screen Display (OSD)

OSD menu shows the disc playback information (for example, title or chapter number, elapsed playing time, audio/subtitle language), a number of operations can be done without interrupting disc playback.

- 1 During playback, press **ON SCREEN**.  
→ A list of available disc information appears on the TV screen.

#### DVD



A screenshot of the DVD OSD menu. The menu is titled "MENU" and has a play button icon. The items listed are: TITLE (02/14), CHAPTER (02/14), AUDIO (5.1CH), and SUBTITLE (ENG). At the bottom, there is a BITRATE indicator with a bar graph.

MENU	
TITLE	02/14
CHAPTER	02/14
AUDIO	5.1CH
SUBTITLE	ENG
BITRATE	

#### VCD/SVCD

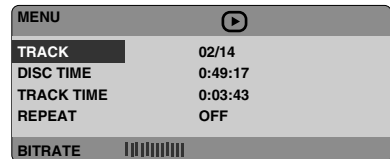

A screenshot of the VCD/SVCD OSD menu. The menu is titled "MENU" and has a play button icon. The items listed are: TRACK (02/14), DISC TIME (0:49:17), TRACK TIME (0:03:43), and REPEAT (OFF). At the bottom, there is a BITRATE indicator with a bar graph.

MENU	
TRACK	02/14
DISC TIME	0:49:17
TRACK TIME	0:03:43
REPEAT	OFF
BITRATE	

- 2 Press ▲▼ to view the information and press **ENTER/OK** to access.
- 3 Use the **numeric keypad (0-9)** to input the number/time or press ▲▼ to make the selection, then press **ENTER/OK** to confirm.  
→ Playback will change to the chosen time or to the selected title/chapter/track.

#### Title/Chapter/Track selection (DVD/VCD)

- 1 Press ▲▼ to select {TITLE} or {CHAPTER} (DVD) or {TRACK} (VCD).
- 2 Press **ENTER/OK**.
- 3 Select a title, chapter or track number using the numeric buttons.

**TIPS:** The operating features described here might not be possible for certain discs. Always refer to the instructions supplied with the discs.

## Time Search (DVD/VCD)

- 1 Press **▲▼** to select {TT TIME} or {CH TIME} (DVD) or {TRACK TIME} or {DISC TIME} (VCD).  
→ {TT TIME} refers to the total time of the current title, and the {CH TIME} refers to the total time of the current chapter.
- 2 Press **ENTER/OK**.
- 3 Enter hours, minutes and seconds from left to right using the numeric buttons. (e.g. 0:34:27)

## Audio/Subtitle/Angle (DVD)

You can change {AUDIO}, {SUBTITLE} or {ANGLE} if available on the disc you are playing.

- 1 Press **▲▼** to select {AUDIO}, {SUBTITLE} or {ANGLE}.
- 2 Press **ENTER/OK**.
- 3 For Audio and Subtitle,  
Press **▲▼** to highlight your selection and press **ENTER/OK**.

or

For Angle,  
Select an angle using the numeric buttons.

## Repeat/Time Display (DVD/VCD)

- 1 Press **▲▼** to select {REPEAT} or {TIME DISP.}.
- 2 Press **ENTER/OK**.
- 3 Press **▲▼** to highlight your selection and press **ENTER/OK**.

## Time display (CD)

Each time you press **ON SCREEN**, the time display changes as follows;

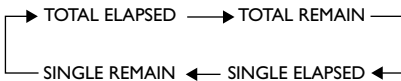

## Special DVD Features

### Playing a Title

- 1 Press **MENU**.  
→ The disc title menu appears on the TV screen.
- 2 Use **◀▶▲▼** or **numeric keypad (0-9)** to select a play option.
- 3 Press **ENTER/OK** to confirm.

### Camera Angle

- Press **ANGLE** repeatedly to select different desired angle.

### Audio

#### Changing the Audio Language and/or format

- Press **AUDIO** repeatedly to select different audio languages.

### Subtitles

- Press **SUBTITLE** repeatedly to select different subtitle languages.

**TIPS:** The operating features described here might not be possible for certain discs. Always refer to the instructions supplied with the discs.

# Disc Operations

## Special VCD & SVCD Features

### Playback Control (PBC)

#### For VCD with Playback Control (PBC) feature (version 2.0 only)

- Press **MENU** to toggle between 'PBC ON' and 'PBC OFF'.  
→ If you select 'PBC ON', the disc menu (if available) will appear on the TV.
- Use the **◀◀ / ▶▶** or the **numeric keypad (0-9)** to select a play option.
- During playback, pressing **TOP MENU/RETURN** will return to the menu screen (if PBC is on).

#### If you want to skip the index menu and playback directly from the beginning,

- Press **MENU** on the remote control to switch to PBC off.

### Preview Function

- 1 Press **SCAN**.
- 2 Press **▲▼** to highlight {TRACK DIGEST}, {DISC INTERVAL} or {TRACK INTERVAL}.
- 3 Press **ENTER/OK** to open one option.

```
SELECT DIGEST TYPE:
TRACK DIGEST
DISC INTERVAL
TRACK INTERVAL
```

### TRACK DIGEST

This function will minimize the picture of every track in order to display every six of these tracks on the screen to help you know the content of every track on the disc.

### DISC INTERVAL

This function is used to divide a disc into six parts by regular intervals and display them on one page to preview the whole disc.

### TRACK INTERVAL

This function is used to divide a single track into six parts by regular intervals and display them on one page to help you preview the selected track.



(example for 6 thumbnail pictures display)

- 4 Use **◀▶▲▼** to select a track or use **numeric keypad (0-9)** to input the selected track number next to {SELECT}.
- 5 Press **◀◀ / ▶▶** to open the previous or next page.
- 6 Press **ENTER/OK** to confirm.

#### To quit preview function

- Use **◀▶▲▼** to highlight {EXIT} and press **ENTER/OK** to confirm.

#### To return to preview menu

- Use **◀▶▲▼** to highlight {MENU} and press **ENTER/OK** to confirm.

### For CD

- At stop mode, press **SCAN** on the remote control.  
→ Each track will be played for a few seconds.

**TIPS:** The operating features described here might not be possible for certain discs. Always refer to the instructions supplied with the discs.

## SA-CD (Super Audio CD)

The SA-CD standard is based on Direct Stream Digital (DSD) technology. This new direct-stream digital format comprises a 1-bit system that has a digital sampling frequency that is 64 times higher than that of conventional audio CD.

There are three types of SA-CD discs: single-layer, dual-layer and hybrid discs. Each type may contain two areas of recorded information: a High Quality Stereo area and a High Quality Multi-channel area.

- A single layer disc can contain both information areas.
- A dual layer disc can contain both information areas. Double the information can be stored on the disc, thanks to the second layer.
- A hybrid disc can contain both information areas, and also a second, standard CD layer, making it playable on standard CD players.

### SA-CD Disc Types

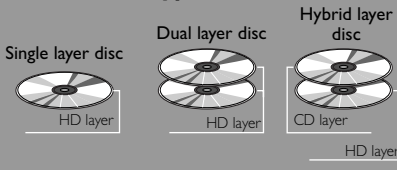

### Hybrid SA-CD-Disc

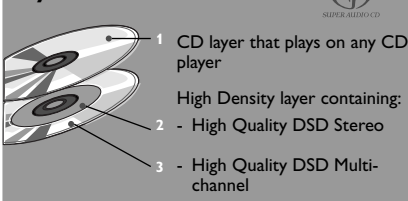

## Playing a disc

- 1 Load a disc.  
Playback starts automatically.  
→ The TV screen will display the current playing status and current playing track list in the area.
- 2 Playback will stop at the end of the disc.
- 3 To stop playback, press **STOP** ■.

## Changing SA-CD playback area and layer

You can change the SA-CD playback area by pressing the **SOUND MODE** button, and change the playback layer by pressing the **AUDIO** button.

- On hybrid discs (with SA-CD and CD layers), the player will always start playing the SA-CD layer (multi channel area).
- You can change between SA-CD multi channel and SA-CD stereo area by pressing **SOUND MODE** (depending on availability of the mode on the disc).

or

- 1 Press ◀ and select the folder using ▲▼, then Press **ENTER/OK**.
- 2 Press ▲▼ to select a track.
- 3 Press **ENTER/OK** to confirm.

- To switch between the SA-CD layer and the CD layer, press the **AUDIO** button while playback is stopped.
- The SA-CD indicator lights only when the SA-CD layer is selected.

Notes:

- SA-CD Text is not supported.
- You can not change the Analog output setting during SA-CD playback (see page 22 "Audio Setup Menu").

**TIPS:** The operating features described here might not be possible for certain discs. Always refer to the instructions supplied with the discs.

# Disc Operations

## Audio CD

### Playing a disc

- 1 Load a disc.
  - Playback starts automatically.
  - The TV screen will display the number of tracks for selection and current playing status.
- 2 Playback will stop at the end of the disc.
- 3 To stop playback, press **STOP ■**.

## Playing MP3/DivX/JPEG/Kodak Picture CD

### General Operation

- 1 Load a disc.
  - The disc reading time may exceed 30 seconds due to the complexity of the directory/file configuration.
  - The data disc menu appears on the TV screen.
- 2 Playback will start automatically. If not press **PLAY ►**.



### During playback, you can;

- Press **|◀◀ / ▶▶|** to select another track/file in the current folder.
- Press **PAUSE II** to pause playback.

### Helpful Hint:

- It may not be possible to play certain MP3/JPEG/DivX disc due to the configuration and characteristics of the disc or condition of the recording.

### Selecting a folder and track/file

- 1 Press **▲▼** to select the folder and press **ENTER/OK** to open the folder.
- 2 Press **▲▼** to select a track/file.
- 3 Press **ENTER/OK** to confirm.
  - Playback will start from the selected file to the end of the folder.

### Special picture disc features

- 1 Load a Picture disc (Kodak Picture CD, JPEG).
  - For Kodak disc, the slide show will begin.
  - For JPEG disc, the picture menu appears on the TV screen.
- 2 Press **PLAY ►** to start the slide-show playback.

### Preview Function (JPEG)

This function shows the content of the current folder or the whole disc.

- 1 Press **STOP ■** during playback.
  - 12 thumbnail pictures will appear on the TV screen.



- 2 Press **|◀◀ / ▶▶|** to display the other pictures on the previous/next page.

**TIPS:** The operating features described here might not be possible for certain discs. Always refer to the instructions supplied with the discs.

- 3 Use ◀▶▲▼ to highlight one of the picture and press **ENTER/OK** to start playback  
OR  
Move the cursor to highlight  on the bottom of the page to start playback from the first picture on the current page.
- 4 Press **MENU** to return to Picture CD menu.

---

## Zoom picture

- 1 During playback, press **ZOOM** repeatedly to display the picture with different scales.
- 2 Use ◀▶▲▼ to view the zoomed picture.

---

## Playback with multi-angles

- During playback, press ◀▶▲▼ to rotate the picture on the TV screen.
  - ◀: rotate the picture anti-clockwise
  - ▶: rotate the picture clockwise
  - ▲: flip the picture vertically
  - ▼: flip the picture horizontally

---

## Scan Effect

- Press **ANGLE** repeatedly to choose different scan effect.
- Various of scan effect appears on the top left hand corner on the TV screen.

---

## Playing MP3 music and JPEG picture simultaneously

- 1 Load a disc that contains music and picture.  
→ The disc menu appears on the TV screen.
- 2 Select an MP3 track.
- 3 During MP3 music playback, select a picture from the TV screen and press **PLAY ▶**.  
→ The picture files will be played back one after another until end of the folder.
- 4 To quit simultaneous playback, press **MENU** followed by **STOP ■**.

### Helpful Hint:

- Some files on Kodak or JPEG disc may be distorted during playback due to the configuration and characteristics of the disc.

**TIPS:** The operating features described here might not be possible for certain discs. Always refer to the instructions supplied with the discs.

# Setup Menu

The setup is carried out via the TV, enabling you to customize the DVD Player to suit your particular requirements.

## General Setup menu

- 1 Press **SETUP**.
- 2 Press **◀▶** to select 'General Setup' icon.
- 3 Press **ENTER/OK** to confirm.

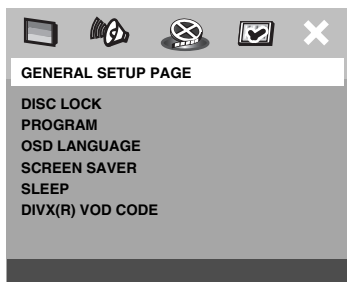

## Locking/Unlocking the disc for viewing

Not all discs are rated or coded by the disc maker. You can prevent a specific disc from playing by locking the disc. Up to 40 discs can be locked.

- 1 In 'GENERAL SETUP PAGE', press **▲▼** to highlight {DISC LOCK}, then press **▶**.

### LOCK

Select this to block the playback of the current disc. Subsequent access to a locked disc requires six-digit password. The default password is '000 000' (see page 28 "Changing the Password").

### UNLOCK

Select this to unlock the disc and allow future playback.

- 2 Press **▲▼** to select a setting, then press **ENTER/OK** to confirm your selection.

## Programming disc tracks and discs

### Program: Track (not for Picture CD/MP3/SA-CD/WMA/DivX®)

You can play the contents of the disc in the order you want by programming the tracks to be played. Up to 20 tracks can be stored.

- 1 In 'GENERAL SETUP PAGE', press **▲▼** to highlight {PROGRAM}, then press **▶** to select {FTS}.
- 2 Press **ENTER/OK** to confirm.

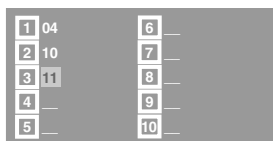

### To input your favorite tracks/chapter

- 3 Use the **numeric keypad (0-9)** to enter a valid track/chapter number.
- 4 Use **◀▶▲▼** to move the cursor to the next position.
  - If the track number is more than ten, press **▶▶|** to open the next page and proceed with programming or,
  - Use **◀▶▲▼** to highlight {NEXT} on the program menu, then press **ENTER/OK**.
- 5 Repeat steps 3–4 to input another track/chapter number.

### If you want to remove a track

- 6 Use **◀▶▲▼** to move the cursor to the track you want to remove.
- 7 Press **ENTER/OK** to remove this track from the program menu.

Note:

- On SA-CD discs, you can program tracks on the CD layer.

**TIPS:** To return to the previous menu, press **◀**.  
To remove the menu, press **SETUP**.



## Program: Disc

You can play the disc in the order you want by programming the discs to be played. Up to 5 discs can be stored.

- 1 In 'GENERAL SETUP PAGE', press ▲▼ to highlight {PROGRAM}, then press ► to select {FDS}.
- 2 Press **ENTER/OK** to confirm.



```
(1) Disc : _
(2) Disc : _
(3) Disc : _
(4) Disc : _
(5) Disc : _
```

### To input your favorite discs

- 3 Use the **numeric keypad (0-9)** to enter a valid disc number.
- 4 Use ◀▶▲▼ to move the cursor to the next position.
- 5 Repeat steps 3–4 to input another disc number.

### If you want to remove a disc

- 6 Use ◀▶▲▼ to move the cursor to the disc you want to remove.
- 7 Use the **numeric keypad (0-9)**, press 0 to remove this disc from the program menu.

### To start program playback

- Use ◀▶▲▼ to highlight {START} on the program menu, then press **ENTER/OK**.
- Playback will start with the selected tracks or discs under the programmed sequence.

### To exit program playback

- Use ◀▶▲▼ to highlight {EXIT} on the program menu, then press **ENTER/OK**.

## OSD Language

This menu contains various language options for display language on the screen. For details, see page 9.

## Screen Saver

This function is used to turn the screen saver on or off.

- 1 In 'GENERAL SETUP PAGE', press ▲▼ to highlight {SCREEN SAVER}, then press ►.

### **ON**

Select this if you wish to turn off the TV screen when disc playback is stopped or paused for more than 15 minutes.

### **OFF**

Select this to disable the screen saver function.

- 2 Press ▲▼ to select a setting, then press **ENTER/OK** to confirm your selection.

## Sleep Timer

This feature automatically sets the DVD player in standby mode after the amount of time you have set.

- 1 In 'GENERAL SETUP PAGE', press ▲▼ to highlight {SLEEP}, then press ►.
- 2 Press ▲▼ to select a setting.  
→ You can select from 15, 30, 45 and 60 minutes. Select {OFF} to cancel the sleep timer function.
- 3 Press **ENTER/OK** to confirm your selection.

**TIPS:** To return to the previous menu, press ◀.  
To remove the menu, press **SETUP**.

# Setup Menu

## DivX® VOD registration code

Yamaha provide you with the DivX® VOD (Video On Demand) registration code that allows you to rent and purchase videos using the DivX® VOD service.

For more information, visit at [www.divx.com/vod](http://www.divx.com/vod).

- 1 In 'GENERAL SETUP PAGE', press ▲▼ to highlight {DIVX(R) VOD CODE}, then press ►.  
→ The registration code will appear.
- 2 Press **ENTER/OK** to exit.
- 3 Use the registration code to purchase or rent the videos from DivX® VOD service at [www.divx.com/vod](http://www.divx.com/vod). Follow the instructions and download the video onto a CD-R for playback on this DVD player.

### Helpful Hints:

- All the downloaded videos from DivX® VOD can only be played back on this DVD player.
- Time search feature is not available during DivX movie playback.

## Audio Setup Menu

- 1 Press **SETUP**.
- 2 Press ◀▶ to select 'Audio Setup' icon.
- 3 Press **ENTER/OK** to confirm.

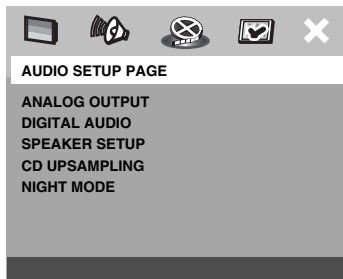

## Setting the analog output

Set Analog Output to match your DVD Player's playback capability.

- 1 In 'AUDIO SETUP PAGE', press ▲▼ to highlight {ANALOG OUTPUT}, then press ►.

### STEREO

Select this to change channel output to stereo which delivers sound from only the two front speakers and subwoofer.

### VIRTUAL SURROUND

Select this to reproduce the surround channels virtually.

### MULTI-CHANNEL

Select this setting when using a multi-channel audio/(video) receiver with 6 channel inputs. In this mode, the player will perform DTS decoding or Dolby Digital 5.1-channel decoding when applicable, and Dolby Pro Logic decoding on DVD-Video and Video-CD discs with 2-channel sound tracks. No Dolby Pro Logic decoding is done with (Super) Audio CD discs.

- 2 Press ▲▼ to select a setting, then press **ENTER/OK** to confirm your selection.

**TIPS:** To return to the previous menu, press ◀.  
To remove the menu, press **SETUP**.

## Setting the Digital output

The options included in Digital Audio are: 'Digital Output' and 'LPCM Output'.

- 1 In 'AUDIO SETUP PAGE', press ▲▼ to highlight {DIGITAL AUDIO}, then press ►.
- 2 Press the ▲▼ to highlight an option.
- 3 Enter its submenu by pressing ►.
- 4 Move the cursor by pressing the ▲▼ to highlight the selected item.

## DIGITAL OUTPUT

Set the Digital output according to your optional audio equipment connection.

### OFF

Turn off the digital output.

### ALL

If you have connected your DIGITAL AUDIO OUT to a multi-channel decoder/receiver.

### PCM ONLY

Only if your receiver is not capable of decoding multi-channel audio.

## LPCM OUTPUT

If you connect the DVD Player to a PCM compatible receiver via the digital terminals, such as coaxial or optical etc., you may need to adjust 'LPCM Output'. Discs are recorded at a certain sampling rate. The higher the sampling rate, the better the sound quality.

### 48kHz

Playback a disc recorded at the sampling rate of 48kHz. 96kHz (if available on disc) PCM data stream will be converted to 48kHz.

### 96kHz

Playback a disc recorded at the sampling rate of 96kHz. If the 96kHz disc is copy protected, the digital output will be muted to comply with the standards.

## Speaker Setup

This menu contains setup options for your audio output which makes the speaker setup system reproduce high quality surround sound. For details, see page 10.

## CD Upsampling

This feature allows you to convert your music CD to a higher sampling rate using sophisticated digital signal processing for better sound quality. If you have activated the upsampling, the player will automatically switch to stereo mode.

- 1 In 'AUDIO SETUP PAGE', press ▲▼ to highlight {CD UPSAMPLING}, then press ►.

### OFF

Select this to disable CD-upsampling.

### 88.2 kHz (X2)

Select this to convert the sampling rate of the CDs twice higher than the original.

### 176.4 kHz (X4)

Select this to convert the sampling rate of the CDs four times higher than the original.

- 2 Press ▲▼ to select a setting, then press **ENTER/OK** to confirm your selection.

Note:

- This setting is only applicable for the signals output from the analog jacks.

**TIPS:** To return to the previous menu, press ◀.  
To remove the menu, press **SETUP**.

# Setup Menu

## Night Mode

In this mode, the high volume outputs are softened and low volume outputs are brought upward to an audible level. It is useful for watching your favorite action movie without disturbing others at night.

- 1 In 'AUDIO SETUP PAGE', press ▲▼ to highlight {NIGHT MODE}, then press ►.

### ON

Select this to level out the volume. This feature is only available for movies with Dolby Digital mode.

### OFF

Select this when you want to enjoy the surround sound with its full dynamic range.

- 2 Press ▲▼ to select a setting, then press **ENTER/OK** to confirm your selection.

## Video Setup Menu

- 1 Press **SETUP**.
- 2 Press ◀▶ to select 'Video Setup' icon.
- 3 Press **ENTER/OK** to confirm.

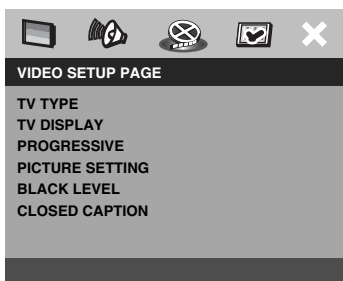

## TV Type

This menu contains the options for selecting the color system that matches the connected TV. For details, see page 8.

## Setting the TV Display

Set the aspect ratio of the DVD Player according to the TV you have connected. The format you select must be available on the disc. If it is not, the setting for TV display will not affect the picture during playback.

- 1 In 'VIDEO SETUP PAGE', press ▲▼ to highlight {TV DISPLAY}, then press ►.
- 2 Press ▲▼ to highlight one of the options below:

### 4:3 PAN SCAN

Select this if you have a normal TV and want both sides of the picture to be trimmed or formatted to fit your TV screen.

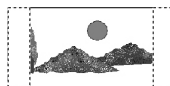

### 4:3 LETTER BOX

Select this if you have a normal TV. In this case, a wide picture with black bands on the upper and lower portions of the TV screen will be displayed.



### 16:9

Select this if you have a widescreen TV.

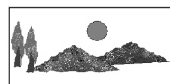

- 3 Select an item and press **ENTER/OK**.

**TIPS:** To return to the previous menu, press ◀.  
To remove the menu, press **SETUP**.

## Progressive

This feature is only applicable if you have connected this DVD Player to a Progressive Scan TV through the Y Pb Pr jacks (see page 7).

- In 'VIDEO SETUP PAGE', press ▲▼ to highlight {PROGRESSIVE}, then press ►.

### ON

To enable Progressive Scan function.

### OFF

To disable Progressive Scan function.

- Press ▲▼ to select a setting, then press **ENTER/OK** to confirm your selection.

### Notes on activating Progressive:

- Ensure that your TV has progressive scan.
- Connect with YPbPr video cable.
- If there is no picture, wait 15 seconds for auto recover or deactivate Progressive manually.

- Open the disc tray by pressing **OPEN/CLOSE ▲** on the front panel.
- Press ◀.
- Press **ANGLE**.

CONSUMERS SHOULD NOTE THAT NOT ALL HIGH DEFINITION TELEVISION SETS ARE FULLY COMPATIBLE WITH THIS PRODUCT AND MAY CAUSE ARTIFACTS TO BE DISPLAYED IN THE PICTURE. IN CASE OF 525 OR 625 PROGRESSIVE SCAN PICTURE PROBLEMS, IT IS RECOMMENDED THAT THE USER SWITCH THE CONNECTION TO THE "STANDARD DEFINITION" OUTPUT. IF THERE ARE QUESTIONS REGARDING OUR VIDEO MONITOR COMPATIBILITY WITH THIS MODEL 525P AND 625P DVD PLAYER, PLEASE CONTACT OUR CUSTOMER SERVICE CENTER.

This unit is compatible with the complete line of YAMAHA products, including the projectors DPX-1100, LPX-510 and the plasma monitor PDM-4210.

## Picture Setting

This DVD Player provides three predefined sets of picture color settings and one personal setting which you can define yourself.

- In 'VIDEO SETUP PAGE', press ▲▼ to highlight {PICTURE SETTING}, then press ►.

### STANDARD

Select this for standard picture setting.

### BRIGHT

Select this will make the TV picture brighter.

### SOFT

Select this will make the TV picture softer.

### PERSONAL

Select this to personalize your picture color by adjusting the brightness, contrast, tint and color (saturation).

- Press ▲▼ to select a setting, then press **ENTER/OK** to confirm your selection.
- If you select {PERSONAL}, then proceed to steps 4–7.  
→ The 'PERSONAL PICTURE SETUP' menu appears.

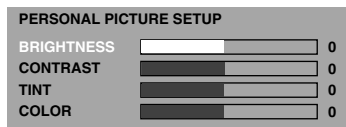

- Press ▲▼ to highlight one of the following options.

### BRIGHTNESS

Increase the value will brighten the picture or vice versa. Choose zero (0) for average setting.

### CONTRAST

Increase the value will sharpen the picture or vice versa. Choose zero (0) to balance the contrast.

**TIPS:** To return to the previous menu, press ◀.  
To remove the menu, press **SETUP**.

# Setup Menu

## TINT

Increase the value will darken the picture or vice versa. Choose zero (0) for average setting.

## COLOR

Increase the value will enhance the color in your picture or vice versa. Choose zero (0) to balance the color.

- 5 Press ◀▶ to adjust the setting that best suit your personal preference.
- 6 Repeat steps 4–5 for adjusting other color features.
- 7 Press **ENTER/OK** to confirm.

## Selecting the black level (U.S.A. model only)

If you set the TV type to NTSC, set Black level shift to ON. This will improve the color contrast during playback. The black level setting has no effect if the TV type is set to PAL.

### ON

Select this for enhanced black level.

### OFF

Select this for standard black level.

## Closed Caption (U.S.A. model only)

Closed Captions are data that are hidden in the video signal on specific discs, invisible without a special decoder. The difference between subtitles and captions is that subtitles are intended for hearing persons and captions are for the hearing impaired. Subtitles rarely show all of the audio. For example, captions show sound effects (e.g., “phone ringing” and “footsteps”), while subtitles don’t.

Before you select this function, please ensure that the disc contains closed captions information and your TV set also has this function.

- 1 In ‘VIDEO SETUP PAGE’, press ▲▼ to highlight {CLOSED CAPTION}, then press ▶.

### ON

To enable Closed Caption function.

### OFF

To disable Closed Caption function.

- 2 Press ▲▼ to select a setting, then press **ENTER/OK** to confirm your selection.

## Preference Setup Menu

- 1 Press **STOP** ■ twice to stop playback (if any), then press **SETUP**.
- 2 Press ◀▶ to select the ‘Preference Setup’ icon.
- 3 Press **ENTER/OK** to confirm.

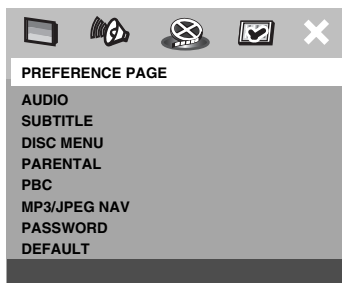

## Audio, Subtitle, Disc Menu

These menus contain various language options for audio, subtitle and disc menu which may be recorded on the DVD. For details, see page 10.

**TIPS:** To return to the previous menu, press ◀.  
To remove the menu, press **SETUP**.

## Restricting playback by Parental Control

Some DVDs may have a parental level assigned to the complete disc or to certain scenes on the disc. This feature lets you set a playback limitation level.

The rating levels are from 1 to 8 and are country dependent. You can prohibit the playing of certain discs that are not suitable for your children or have certain discs played with alternative scenes.

- 1 In 'PREFERENCE PAGE', press ▲▼ to highlight {PARENTAL}, then press ►.

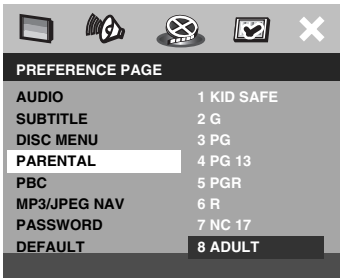

- 2 Press ▲▼ to highlight a rating level for the disc inserted and press **ENTER/OK**.  
→ To disable Parental controls and have all Discs play, select {8 ADULT}.
- 3 Use the **numeric keypad (0-9)** to enter the six-digit password (see page 28 "Changing the Password").  
→ DVDs that are rated above the level you selected will not play unless you enter your six-digit password.

### Helpful Hints:

- VCD, SVCD, CD, SA-CD have no level indication, so parental control function has no effect on these type of discs. This applies to most illegal DVD discs.
- Some DVDs are not encoded with a rating though the movie rating may be printed on the Disc cover. The rating level feature does not work for such Discs.

## PBC (Playback Control)

You can set the PBC to ON or OFF. This feature is available only on Video CD 2.0 with playback control (PBC) feature. For details, see page 16.

## MP3/JPEG Menu

MP3/JPEG Navigator can be set only if the disc is recorded with menu. It allows you to select different display menus for easy navigation.

- 1 In 'PREFERENCE PAGE', press ▲▼ to highlight {MP3/JPEG NAV}, then press ►.

### WITHOUT MENU

Select this to display all the files contained in the MP3/Picture CD.

### WITH MENU

Select this to display only the folder menu of the MP3/Picture CD.

- 2 Press ▲▼ to select a setting, then press **ENTER/OK** to confirm your selection.

**TIPS:** To return to the previous menu, press ◀.  
To remove the menu, press **SETUP**.

# Setup Menu

## Changing the Password

The same password is used for both Parental Control and Disc Lock. Enter your six-digit password when prompted on the screen. The default password is 000 000.

- 1 In 'PREFERENCE PAGE', press ▲▼ to highlight {PASSWORD}, then press ► to select {CHANGE}.

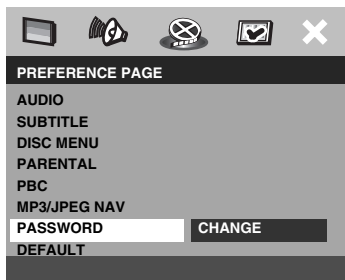

- 2 Press **ENTER/OK** to enter the 'Password Change Page'.

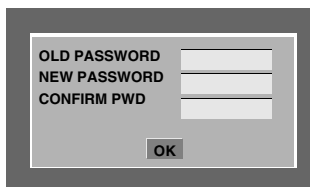

- 3 Use the **numeric keypad (0-9)** to enter your old six-digit password.
  - When doing this for the first time, key in '000 000'.
  - If you forget your old six-digit password, key in '000 000'.
- 4 Enter the new six-digit password.
- 5 Enter the new six-digit password a second time to confirm.
  - The new six-digit password will now take effect.
- 6 Press **ENTER/OK** to confirm.

## Restoring to original settings

Setting the DEFAULT function will reset all options and your personal settings to the factory defaults, except your password for Parental Control and Disc Lock.

- 1 In 'PREFERENCE PAGE', press ▲▼ to highlight {DEFAULT}, then press ► to select {RESET}.
- 2 Press **ENTER/OK** to confirm.
  - All settings will now reset to factory defaults.

**TIPS:** To return to the previous menu, press ◀.  
To remove the menu, press **SETUP**.



These pages can be used to select other languages. This does not affect the options in "AUDIO", "SUBTITLE" or "DISC MENU".

Abkhazian	6566	German	6869
Afar	6565	Gikuyu; Kikuyu	7573
Afrikaans	6570	Greek,	6976
Albanian	8381	Guarani	7178
Amharic	6577	Gujarati	7185
Arabic	6582	Hausa	7265
Armenian	7289	Hebrew	7269
Assamese	6583	Herero	7290
Avestan	6569	Hindi	7273
Aymara	6589	Hiri Motu	7279
Azerbaijani	6590	Hungarian	7285
Bashkir	6665	Icelandic	7383
Basque	6985	Ido	7379
Belarusian	6669	Indonesian	7368
Bengali	6678	Interlingua (International)	7365
Bihari	6672	Interlingue	7369
Bislama	6673	Inuktitut	7385
Bokmål, Norwegian	7866	Inupiaq	7375
Bosnian	6683	Irish	7165
Breton	6682	Italian	7384
Bulgarian	6671	Japanese	7465
Burmese	7789	Javanese	7486
Castilian, Spanish	6983	Kalaallisut	7576
Catalan	6765	Kannada	7578
Chamorro	6772	Kashmiri	7583
Chechen	6769	Kazakh	7575
Chewa; Chichewa; Nyanja	7889	Khmer	7577
Chichewa; Chewa; Nyanja	7889	Kikuyu; Gikuyu	7573
Chinese	9072	Kinyarwanda	8287
Chuang; Zhuang	9065	Kirghiz	7589
Church Slav; Slavonic;	6785	Komi	7586
Church Slavonic; Church	6785	Korean	7579
Chuvash	6786	Kwanyama; Kwanyama	7574
Cornish	7587	Kurdish	7585
Corsican	6779	Kwanyama; Kwanyama	7574
Croatian	7282	Lao	7679
Czech	6783	Latin	7665
Danish	6865	Latvian	7686
Dutch	7876	Letzeburgesch;	7666
Dzongkha	6890	Limburgan; Limburger;	7673
English	6978	Limburger; Limburgan;	7673
Esperanto	6979	Limburgish; Limburger;	7673
Estonian	6984	Lingala	7678
Faroese	7079	Lithuanian	7684
Fijian	7074	Luxembourgish;	7666
Finnish	7073	Macedonian	7775
French	7082	Malagasy	7771
Frisian	7089	Malay	7783
Gaelic; Scottish Gaelic	7168	Malayalam	7776
Gallegan	7176	Maltese	7784
Georgian	7565	Manx	7186

# Language Code

These pages can be used to select other languages. This does not affect the options in "AUDIO", "SUBTITLE" or "DISC MENU".

Maori	7773	Sotho, Southern	8384
Marathi	7782	South Ndebele	7882
Marshallese	7772	Spanish; Castilian	6983
Moldavian	7779	Sundanese	8385
Mongolian	7778	Swahili	8387
Nauru	7865	Swati	8383
Navaho, Navajo	7886	Swedish	8386
Navajo; Navaho	7886	Tagalog	8476
Ndebele, North	7868	Tahitian	8489
Ndebele, South	7882	Tajik	8471
Ndonga	7871	Tamil	8465
Nepali	7869	Tatar	8484
Northern Sami	8369	Telugu	8469
North Ndebele	7868	Thai	8472
Norwegian	7879	Tibetan	6679
Norwegian Bokmål; Bokmål,	7866	Tigrinya	8473
Norwegian Nynorsk;	7878	Tonga (Tonga Islands)	8479
Nyanja; Chichewa; Chewa	7889	Tsonga	8483
Nynorsk, Norwegian;	7878	Tswana	8478
Occitan (post 1500); Proven	7967	Turkish	8482
Old Bulgarian; Old Slavonic;	6785	Turkmen	8475
Old Church Slavonic; Old	6785	Twi	8487
Old Slavonic; Church	6785	Uighur	8571
Oriya	7982	Ukrainian	8575
Oromo	7977	Urdu	8582
Ossetian; Ossetic	7983	Uzbek	8590
Ossetic; Ossetian	7983	Vietnamese	8673
Pali	8073	Volapük	8679
Panjabi	8065	Walloon	8765
Persian	7065	Welsh	6789
Polish	8076	Wolof	8779
Portuguese	8084	Xhosa	8872
Provençal; Occitan (post)	7967	Yiddish	8973
Pushto	8083	Yoruba	8979
Quechua	8185	Zhuang; Chuang	9065
Raeto-Romance	8277	Zulu	9085
Romanian	8279		
Rundi	8278		
Russian	8285		
Samoan	8377		
Sango	8371		
Sanskrit	8365		
Sardinian	8367		
Scottish Gaelic; Gaelic	7168		
Serbian	8382		
Shona	8378		
Sindhi	8368		
Sinhalese	8373		
Slovak	8375		
Slovenian	8376		
Somali	8379		

**Refer to the chart below when this unit does not function properly. If the problem you are experiencing is not listed below or if the instruction below does not help, set this unit to the standby mode, disconnect the power cord, and contact the nearest authorized YAMAHA dealer or service center.**

Problem	Solution
<b>No power</b>	<ul style="list-style-type: none"> <li>– Check if the AC power cord is properly connected.</li> <li>– Press the STANDBY/ON on the front of the DVD system to turn on the power.</li> </ul>
<b>No picture</b>	<ul style="list-style-type: none"> <li>– Refer to your TV's manual for correct Video In channel selection. Change the TV channel until you see the DVD screen.</li> <li>– Check if the TV is switched on.</li> <li>– If you did not use Progressive Scan connections (using the Y P<sub>B</sub> P<sub>R</sub> jacks on the DVD Player) and you do not have a picture at the TV, please follow the steps below to turn off Progressive Scan:               <ol style="list-style-type: none"> <li>1. Press ▲ (OPEN/CLOSE) to open the disc tray.</li> <li>2. Press ◀.</li> <li>3. Then press ANGLE to deactivate the Progressive. The DVD Player will reset itself to Component/Interlaced video.</li> </ol> </li> </ul>
<b>Distorted picture</b>	<ul style="list-style-type: none"> <li>– Sometimes a small amount of picture distortion may appear depending on the disc being played back. This is not a malfunction.</li> </ul>
<b>Completely distorted picture or black/white picture with DVD</b>	<ul style="list-style-type: none"> <li>– Make sure the disc is compatible with the DVD Player.</li> <li>– Ensure that the DVD Player's TV Type is set to match that of the Disc and your TV.</li> </ul>
<b>No sound or distorted sound</b>	<ul style="list-style-type: none"> <li>– Adjust the volume.</li> <li>– Check that the speakers are connected correctly.</li> </ul>
<b>No audio at digital output</b>	<ul style="list-style-type: none"> <li>– Check the digital connections.</li> <li>– Check if your receiver can decode MPEG-2 or DTS and if not, please make sure the digital output is set to PCM ONLY.</li> <li>– Check if the audio format of the selected audio language matches your receiver capabilities.</li> </ul>
<b>No output from subwoofer during stereo</b>	<ul style="list-style-type: none"> <li>– Check that all speaker settings in the setup menu have been changed to small instead of large.</li> </ul>
<b>Disc can't be played</b>	<ul style="list-style-type: none"> <li>– The DVD+R/RW, DVD-R/RW, CD-R/RW must be finalized.</li> <li>– Ensure the disc label is facing up.</li> <li>– Check if the disc is defective by trying another disc.</li> <li>– If you have recorded a Picture CD or MP3 CD yourself, ensure that your disc contains at least 10 pictures or 5 MP3 tracks.</li> <li>– Region code incorrect.</li> </ul>
<b>Picture freezes momentarily during playback</b>	<ul style="list-style-type: none"> <li>– Check the disc for fingerprints/scratches and clean with a soft cloth wiping from centre to edge.</li> </ul>

# Troubleshooting

Problem	Solution
<b>The player does not respond to the Remote Control</b>	<ul style="list-style-type: none"><li>- Aim the Remote Control directly at the sensor on the front of the player.</li><li>- Reduce the distance to the player.</li><li>- Replace the batteries in the Remote Control.</li><li>- Re-insert the batteries with their polarities (+/- signs) as indicated.</li></ul>
<b>Buttons do not work</b>	<ul style="list-style-type: none"><li>- To completely reset the player, unplug the AC cord from the AC outlet for 5-10 seconds.</li></ul>
<b>Player does not respond to some operating commands during playback.</b>	<ul style="list-style-type: none"><li>- Operations may not be permitted by the disc. Refer to the instructions of the disc jacket.</li></ul>
<b>DVD Player cannot read CDs/ DVDs</b>	<ul style="list-style-type: none"><li>- Use a commonly available cleaning CD/DVD to clean the lens before sending the DVD Player for repair.</li></ul>
<b>Menu items cannot be selected</b>	<ul style="list-style-type: none"><li>- Press STOP twice before selecting Setup Menu.</li><li>- Depending on the disc availability, some menu items cannot be selected.</li></ul>
<b>Unable to play DivX movies</b>	<ul style="list-style-type: none"><li>- Check that the DivX file is encoded in 'Home Theater' mode with DivX 5.x encoder.</li></ul>
<b>No sound during DivX movies playback</b>	<ul style="list-style-type: none"><li>- The audio code may not be supported by the DVD player.</li></ul>

**Analog:** Sound that has not been turned into numbers. Analog sound varies, while digital sound has specific numerical values. These jacks send audio through two channels, the left and right.

**Aspect ratio:** The ratio of vertical and horizontal sizes of a displayed image. The horizontal vs. vertical ratio of conventional TVs. is 4:3, and that of widescreens is 16:9.

**AUDIO OUT Jacks:** Jacks on the back of the DVD System that send audio to another system (TV, Stereo, etc.).

**Bit Rate:** The amount of data used to hold a given length of music; measured in kilobits per seconds, or kbps. Or, the speed at which you record. Generally, the higher the bit rate, or the higher the recording speed, the better the sound quality. However, higher bit rates use more space on a Disc.

**Chapter:** Sections of a picture or a music piece on a DVD that are smaller than titles. A title is composed of several chapters. Each chapter is assigned a chapter number enabling you to locate the chapter you want.

**Component Video Out Jacks:** Jacks on the back of the DVD System that send high-quality video to a TV that has Component Video In jacks (R/G/B, Y/Pb/Pr, etc.).

**Disc menu:** A screen display prepared for allowing selection of images, sounds, subtitles, multi-angles, etc. recorded on a DVD.

**Digital:** Sound that has been converted into numerical values. Digital sound is available when you use the DIGITAL AUDIO OUT COAXIAL or OPTICAL jacks. These jacks send audio through multiple channels, instead of just two channels as analog does.

**DivX 3.11/4x/5x:** The DivX code is a patent pending, MPEG-4 based video compression technology, developed by DivXNetworks, Inc., that can shrink digital video to sizes small enough to be transported over the internet, while maintaining high visual quality.

**Dolby Digital:** A surround sound system developed by Dolby Laboratories containing up to six channels of digital audio (front left and right, surround left and right, center and subwoofer).

**DTS:** Digital Theatre Systems. This is a surround sound system, but it is different from Dolby Digital. The formats were developed by different companies.

**JPEG:** A very common digital still picture format. A still-picture data compression system proposed by the Joint Photographic Expert Group, which features small decrease in image quality in spite of its high compression ratio.

**MP3:** A file format with a sound data compression system. "MP3" is the abbreviation of Motion Picture Experts Group 1 (or MPEG-1) Audio Layer 3. By using MP3 format, one CD-R or CD-RW can contain about 10 times as much data volume as a regular CD can.

**Multichannel** DVD is specified to have each sound track constitute one sound field. Multichannel refers to a structure of sound tracks having three or more channels.

**Parental Control:** A function of the DVD to limit playback of the disc by the age of the users according to the limitation level in each country. The limitation varies from disc to disc; when it is activated, playback will be prohibited if the software's level is higher than the user-set level.

**PCM (Pulse Code Modulation):** A system for converting analog sound signal to digital signal for later processing, with no data compression used in conversion.

**Playback control (PBC):** Refers to the signal recorded on video CDs or SVCDs for controlling reproduction. By using menu screens recorded on a Video CD or SVCD that supports PBC, you can enjoy interactive-type software as well as software having a search function.

**Progressive Scan:** It displays all the horizontal lines of a picture at one time, as a signal frame. This system can convert the interlaced video from DVD into progressive format for connection to a progressive display. It dramatically increases the vertical resolution.

**Region code:** A system for allowing discs to be played back only in the region designated beforehand. This unit will only play discs that have compatible region codes. You can find the region code of your unit by looking on the product label. Some discs are compatible with more than one region (or ALL regions).

**S-Video:** Produces a clear picture by sending separate signals for the luminance and the color. You can use S-Video only if your TV has S- video In Jack.

**Super Audio CD (SA-CD):** This audio format is based upon the current CD standards but includes a greater amount of information that provides higher quality sound. There are three types of discs: single layer, double layer and hybrid discs. The hybrid disc contains both standard audio CD and Super Audio CD information.

**Surround:** A system for creating realistic three dimensional sound fields full of realism by arranging multiple speakers around the listener.

**Title:** The longest section of a picture or music feature on DVD, music, etc., in video software, or the entire album in audio software. Each title is assigned a title number enabling you to locate the title you want.

**VIDEO OUT jack:** Jack on the back of the DVD System that sends video to a TV.

# Specifications

## PLAYBACK SYSTEM

DVD-Video  
SA-CD multichannel and SA-CD stereo  
Video CD & SVCD  
CD  
PICTURE CD  
CD-R, CD-RW  
DVD+R, DVD+RW  
DVD-R, DVD-RW

## VIDEO PERFORMANCE

Video (CVBS) Output 1 Vpp into 75 ohm  
S-Video output Y: 1 Vpp into 75 ohm  
C: 0.3 Vpp into 75 ohm  
Component video output Y: 1 Vpp into 75 ohm  
Pb/Cb Pr/Cr: 0.7 Vpp into 75 ohm  
Black Level Shift On/Off

## AUDIO FORMAT

Digital Mpeg/ Dolby Digital/ Compressed Digital  
DTS  
PCM 16, 20, 24 bits  
fs, 44.1, 48, 96 kHz  
MP3(ISO 9660) 24, 32, 56, 64, 96, 128,  
256 kbps  
fs, 16, 22.05, 24, 32,  
44.1, 48 kHz  
WMA 32–192 kbps, mono, stereo  
Full decoding of Dolby Digital and DTS multi-channel sound  
Analog Sound Stereo  
Dolby Surround compatible downmix from Dolby Digital  
multi-channel sound  
Dolby Pro Logic II  
3D sound for virtual 5.1 channel sound on 2 speakers

## AUDIO PERFORMANCE

DA Converter 24bit, 192kHz  
Signal-Noise (1 kHz) 105dB  
Dynamic range (1 kHz) 95dB  
DVD fs 96 kHz 2Hz- 44kHz  
fs 48 kHz 2Hz- 22kHz  
SVCD fs 48 kHz 2Hz- 22kHz  
fs 44.1kHz 2Hz- 20kHz  
CD/VCD fs 44.1kHz 2Hz- 20kHz  
Distortion and Noise (1 kHz) 0.0035%

## TV STANDARD (PAL/50Hz) (NTSC/60Hz)

Number of lines 625 525  
Playback Multistandard (PAL/NTSC)

## CONNECTIONS

Y Output Cinch (green)  
Pb/Cb Output Cinch (blue)  
Pr/Cr Output Cinch (red)  
S-Video Output Mini DIN, 4 pins  
Video Output Cinch  
Audio Output (L+R) Cinch  
Digital Output 1 coaxial, 1 optical  
IEC60958 for CDDA / LPCM  
IEC61937 for MPEG 1/2, Dolby  
Digital and DTS

### 6 channel analog output

Audio Front L/R Cinch (white/red)  
Audio Surround L/R Cinch (white/red)  
Audio Center Cinch (blue)  
Audio Subwoofer Cinch (black)

## CABINET

Dimensions (w x d x h) 435 x 425 x 75 mm  
Weight Approx. 5.5 Kg

## POWER SUPPLY

Power inlet U.S.A model 120V, 60Hz  
Australia model 240V, 50Hz  
Power usage Approx. 15W  
Power usage standby < 1W

**Specifications subject to change without prior notice**



©2004 YAMAHA CORPORATION All rights reserved.

YAMAHA ELECTRONICS CORPORATION, USA 6660 ORANGETHORPE AVE., BUENA PARK, CALIF. 90620, U.S.A.  
YAMAHA CANADA MUSIC LTD. 135 MILNER AVE., SCARBOROUGH, ONTARIO M1S 3R1, CANADA  
YAMAHA ELECTRONIK EUROPA G.m.b.H. SIEMENSSTR. 22-34, 25462 RELINGEN BEI HAMBURG, F.R. OF GERMANY  
YAMAHA ELECTRONIQUE FRANCE S.A. RUE AMBROISE CROIZAT BP70 CROISSY-BEAUBOURG 77312 MARNE-LA-VALLÉE CEDEX02, FRANCE  
YAMAHA ELECTRONICS (UK) LTD. YAMAHA HOUSE, 200 RICKMANSWORTH ROAD WATFORD, HERTS WD18 7GQ, ENGLAND  
YAMAHA SCANDINAVIA A.B. J A WETTERGRENS GATA 1, BOX 30053, 400 43 VÄSTRA FRÖLUNDA, SWEDEN  
YAMAHA MUSIC AUSTRALIA PTY, LTD. 17-33 MARKET ST., SOUTH MELBOURNE, 3205 VIC., AUSTRALIA

YAMAHA CORPORATION

Printed in China (IF) 3139 246 13703

Download from [Www.Somanuals.com](http://www.Somanuals.com). All Manuals Search And Download.

## Free Manuals Download Website

<http://myh66.com>

<http://usermanuals.us>

<http://www.somanuals.com>

<http://www.4manuals.cc>

<http://www.manual-lib.com>

<http://www.404manual.com>

<http://www.luxmanual.com>

<http://aubethermostatmanual.com>

Golf course search by state

<http://golfingnear.com>

Email search by domain

<http://emailbydomain.com>

Auto manuals search

<http://auto.somanuals.com>

TV manuals search

<http://tv.somanuals.com>