

DVD AUDIO/VIDEO SA-CD PLAYER  
LECTEUR DE DVD AUDIO/VIDEO SA-CD

# DVD-S2700

*OWNER'S MANUAL  
MODE D'EMPLOI  
BEDIENUNGSANLEITUNG  
BRUKSANVISNING  
MANUALE DI ISTRUZIONI  
MANUAL DE INSTRUCCIONES  
GEBRUIKSAANWIJZING  
ИНСТРУКЦИЯ ПО ЭКСПЛУАТАЦИИ*

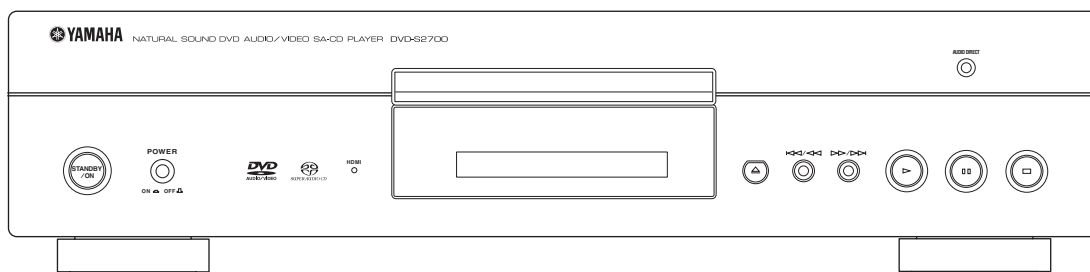

# CAUTION: READ THIS BEFORE OPERATING THIS UNIT.

- 1 To assure the finest performance, please read this manual carefully. Keep it in a safe place for future reference.
- 2 Install this unit in a well ventilated, cool, dry, clean place — away from direct sunlight, heat sources, vibration, dust, moisture, or cold. In a cabinet, allow about 2.5 cm (1 inch) of free space all around this unit for adequate ventilation.
- 3 Locate this unit away from other electrical appliances, motors, or transformers to avoid humming sounds.
- 4 Do not expose this unit to sudden temperature changes from cold to hot, nor locate this unit in an environment with high humidity (i.e., a room with a humidifier) to prevent condensation inside this unit, which may cause an electrical shock, fire, damage to this unit, and/or personal injury.
- 5 Avoid installing this unit in a location where foreign objects may fall onto this unit or where this unit may be exposed to liquid dripping or splashing. On the top of this unit, do not place:
  - Other components, as they may cause damage and/or discoloration on the surface of this unit.
  - Burning objects (i.e., candles), as they may cause fire, damage to this unit, and/or personal injury.
  - Containers with liquid in them, as they may fall, spilling the liquid and causing an electrical shock to the user and/or damage to this unit.
- 6 Do not cover this unit with a newspaper, tablecloth, curtain, etc. in order not to obstruct heat radiation. If the temperature inside this unit rises, it may cause fire, damage to this unit, and/or personal injury.
- 7 Do not plug in this unit to a wall outlet until all connections are complete.
- 8 Do not operate this unit upside-down. It may overheat, possibly causing damage.
- 9 Do not use excessive force on switches, knobs and/or cords.
- 10 When disconnecting the power cord from the wall outlet, grasp the plug; do not pull the cord.
- 11 Do not clean this unit with chemical solvents; this might damage the finish. Use a clean, dry cloth.
- 12 Use only the voltage specified on this unit. Using this unit with a higher voltage than specified is dangerous and may cause fire, damage to this unit, and/or personal injury. YAMAHA will not be held responsible for any damage resulting from use of this unit with a voltage other than as specified.
- 13 Do not attempt to modify or fix this unit. Contact qualified YAMAHA service personnel when any service is needed. The cabinet should never be opened for any reason.
- 14 When not planning to use this unit for long periods of time (i.e., vacation), disconnect the AC power plug from the wall outlet.
- 15 Be sure to read the “TROUBLESHOOTING” section on common operating errors before concluding that this unit is faulty.
- 16 Before moving this unit, press STANDBY/ON to set the unit in standby mode, then disconnect the AC power plug from the wall outlet.
- 17 Install this unit near the AC outlet and where the AC power plug can be reached easily.
- 18 The batteries shall not be exposed to excessive heat such as sunshine, fire or the like.

The unit is not disconnected from the AC power source as long as it is connected to the wall outlet, even if you turn off this unit by STANDBY/ON on the front panel or STANDBY (⏻) on the remote control. This state is called the standby mode. In this state, this unit is designed to consume a very small quantity of power.

## WARNING

TO REDUCE THE RISK OF FIRE OR ELECTRIC SHOCK, DO NOT EXPOSE THIS UNIT TO RAIN OR MOISTURE.

## LASER SAFETY

This unit employs a laser. Due to possible eye injury, only a qualified service person should remove the cover or attempt to service this device.

## DANGER

This unit emits visible laser radiation when open. Avoid direct eye exposure to beam.

When this unit is plugged into a wall outlet, do not place your eyes close to the opening of the disc tray and other openings or look inside.



This symbol mark is according to the EU directive 2002/96/EC.

This symbol mark means that electrical and electronic equipment, at their end-of-life, should be disposed of separately from your household waste.

Please act according to your local rules and do not dispose of your old products with your normal household waste.

# CONTENTS

## INTRODUCTION 3

<b>Playable disc formats</b> .....	3
DVD region codes .....	3
<b>Patent information</b> .....	4
<b>Cleaning discs</b> .....	4
<b>Supplied accessories</b> .....	4

## FUNCTIONAL OVERVIEW 5

<b>Front panel</b> .....	5
<b>Front panel display</b> .....	6
<b>Rear panel</b> .....	7
<b>Remote control</b> .....	8

## CONNECTIONS 10

<b>General notes on connections</b> .....	10
<b>Audio connections</b> .....	10
Connecting a stereo amplifier.....	10
Connecting an AV receiver with 5.1ch/ digital input jacks .....	10
<b>Video connections</b> .....	11
<b>Connecting the power cable</b> .....	12

## GETTING STARTED 13

<b>Step 1: Inserting batteries into the remote control</b> .....	13
Using the remote control .....	13
<b>Step 2: Turning on the power</b> .....	13
<b>Step 3: Setting a TV type</b> .....	14
<b>Step 4: Setting a language preference</b> .....	15
Setting the OSD (On-Screen Display) language.....	15
Setting the audio, subtitle and disc menu languages .....	15

## DISC OPERATION 16

<b>Basic operation</b> .....	16
Pausing playback.....	16
Selecting a track/chapter .....	16
Searching backward/forward .....	17
<b>Repeat playback</b> .....	17
Repeating playback .....	17
Repeating a section (except DVD-Audio/ MP3/WMA/JPEG) .....	17
<b>Random playback (except DVD/DivX/SA-CD)</b> .....	17
<b>Program playback (CD)</b> .....	18
<b>Disc menu operation (DVD/VCD/SVCD)</b> .....	18
Using the DVD menu .....	18
Using the Video CD playback control (PBC) menu (VCD/SVCD) .....	19
<b>On-screen display (OSD) menu (DVD/VCD/SVCD/SA-CD)</b> .....	19
Using the OSD menu (DVD/VCD/SVCD/CD) ....	19
Displaying text information (SA-CD).....	20
<b>Zooming pictures (DVD-Video/VCD/ SVCD/DivX/JPEG)</b> .....	20
<b>Viewing angles (DVD-Video)</b> .....	21
<b>Audio and Subtitle languages (DVD-Video)</b> ...	21
Selecting an audio language.....	21
Selecting a subtitle language .....	21
<b>DivX external subtitle files</b> .....	21
<b>Changing pages (DVD-Audio)</b> .....	21
<b>Group/File selection (DVD-Audio/DivX/ MP3/WMA/Kodak picture CD)</b> .....	22
Selecting a group (DVD-Audio) .....	22
Selecting a file in a folder (DivX/MP3/WMA/ Kodak picture CD) .....	22
<b>Bonus group playback (DVD-Audio)</b> .....	22
<b>Changing the playback area and layer (SA-CD)</b> .....	22
<b>Multimedia file playback (MP3/WMA/DivX/JPEG)</b> .....	23
Displaying the thumbnail screen (JPEG) .....	23
Rotating pictures (JPEG).....	23

<b>SETUP MENU</b> .....	<b>24</b>
<b>Menu overview</b> .....	<b>24</b>
<b>Setup menu operation</b> .....	<b>25</b>
<b>General setup menu</b> .....	<b>26</b>
Selecting DVD-Audio mode .....	26
Selecting SA-CD mode .....	26
Setting the OSD language .....	26
Restricting playback with parental control .....	26
Changing the parental password .....	26
Setting the screen saver .....	27
Setting the auto power function .....	27
Setting the sleep timer .....	27
Resetting the system .....	27
Displaying the DivX® VOD registration code ...	27
<b>Audio setup menu</b> .....	<b>28</b>
Setting the analog output .....	28
Setting the digital output .....	28
Setting the LPCM output .....	28
Setting the night listening mode .....	28
<b>Speaker setup menu</b> .....	<b>29</b>
Setting speaker sizes .....	29
Setting speaker distances .....	29
Setting speaker levels .....	30
Setting the SA-CD configuration .....	30
Setting the cut-off frequency (SA-CD only) .....	30
<b>Video setup menu</b> .....	<b>31</b>
Setting the TV display .....	31
Setting the TV type .....	31
Selecting the black level	
(U.S.A. and Canada models only) .....	31
Selecting the closed caption	
(U.S.A. and Canada models only) .....	32
Setting the still mode .....	32
Selecting the progressive scan function .....	32
Switching the SCART video out	
(U.K. and Europe models only) .....	33
Adjusting picture settings .....	33
<b>HDMI setup menu</b> .....	<b>33</b>
Setting the HDMI video .....	33
Selecting the wide screen format .....	34
Selecting the DVI output range .....	34
Setting the HDMI audio .....	35
<b>DISC setup menu</b> .....	<b>35</b>
Selecting the default audio/subtitle/	
DVD menu language .....	35
Selecting an angle mark display .....	35
Selecting the PBC (playback control) function ....	35
Setting the duration for a slide show .....	35

<b>LANGUAGE CODE LIST</b>	<b>36</b>
---------------------------	-----------

<b>TROUBLESHOOTING</b>	<b>37</b>
------------------------	-----------

<b>GLOSSARY</b>	<b>39</b>
-----------------	-----------

<b>SPECIFICATIONS</b>	<b>42</b>
-----------------------	-----------

# INTRODUCTION

Thank you for purchasing this unit. This Owner's Manual explains the basic operation of this unit.

- Illustrations in this manual are based on the U.K. and Europe models unless otherwise specified.
- Notes contain important information about safety and operating instructions.
- ✨ indicates a tip for your operation.
- This manual is printed prior to production. Design and specifications are subject to change in part as a result of improvements, etc. In case of differences between the manual and the product, the product has priority.

## Playable disc formats

- This unit is designed for use with the following discs: DVD-Video, DVD-Audio, DVD-R, DVD-RW, DVD+R, DVD+RW, DVD+R DL, Video CD, Super Video CD, Super Audio CD (SA-CD), Audio CD, CD-R and CD-RW.



- This unit can play:
  - MP3, WMA (except copyright-protected WMA) and picture (Kodak, JPEG) files recorded on CD-R(W)/DVD-R(W)/DVD+R(W)
  - JPEG/ISO 9660 format
  - Maximum 14 character display
  - DivX® disc on CD-R(W)/DVD-R(W)/DVD+R(W)
    - Official DivX® Certified product
    - Plays all versions of DivX® video (including DivX® 6) with standard playback of DivX® media files

## Notes

- CD-R(W), DVD-R(W) and DVD+R(W) cannot be played unless finalized.
- Copyright-protected WMA files cannot be played with this unit.
- Some discs cannot be played depending on the recording conditions, such as the PC environment and application software. The characteristics and condition of some discs; materials, scratches, curvature, etc., may result in playback failure.
- Be sure to use only CD-R(W), DVD-R(W) and DVD+R(W) discs made by reliable manufacturers.
- Do not use any non-standard shaped discs (heart-shaped, etc.).
- Do not use discs with tape, seals, or paste on their surface. Doing so may damage this unit.
- Do not use discs affixed with labels printed by a commercially available label printer.

## DVD region codes

This unit is designed to support the region management system. Check the regional code number on the DVD disc package. If the number does not match the region code of this unit (see the table below or the back of this unit), this unit may be unable to play the disc.

Destination	Region code of this unit	Playable discs
U.S.A. Canada		
U.K. Europe		
Australia		
China		

## Patent information



Manufactured under license from Dolby Laboratories. "Dolby" and the double-D symbol are trademarks of Dolby Laboratories.



"DTS" and "DTS Digital Surround" are registered trademarks of Digital Theater Systems, Inc.



DivX, DivX Certified, and associated logos are trademarks of DivX, Inc. and are used under license.



"DCDi" is a trademark of Faroudja, a division of Genesis Microchip, Inc.



"HDMI", the "HDMI" logo and "High Definition Multimedia Interface" are trademarks or registered trademark of HDMI Licensing LLC.

This product incorporates copyright protection technology that is protected by method claims of certain U.S. patents and other intellectual property rights owned by Macrovision Corporation and other rights owners. Use of this copyright protection technology must be authorized by Macrovision Corporation, and is intended for home and other limited viewing uses only unless otherwise authorized by Macrovision Corporation. Reverse engineering or disassembly is prohibited.

## Cleaning discs

- When a disc becomes dirty, clean it with a cleaning cloth. Wipe the disc from the center out. Do not wipe in a circular motion.
- Do not use solvents such as benzine, thinner, commercially available cleaners, or antistatic spray intended for analog records.



## Supplied accessories

Check your package to make sure it contains the following items:

Remote control

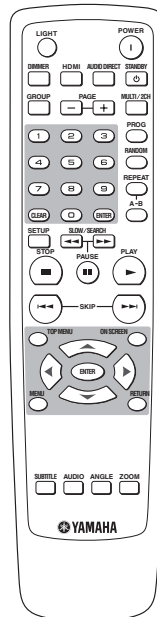

Batteries (x2)  
(AAA, R03, UM-4)

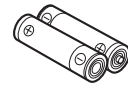

Audio pin cable

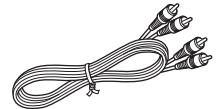

Video pin cable

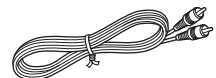

Power cable

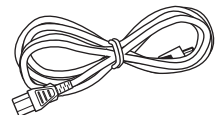

# FUNCTIONAL OVERVIEW

## Front panel

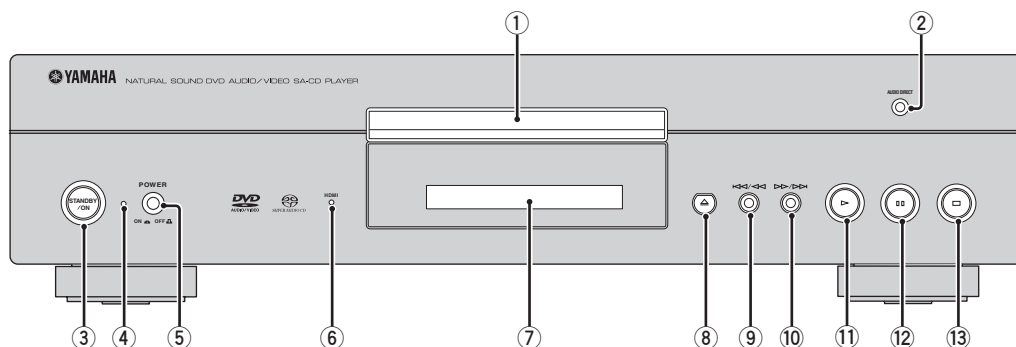

- ① **Disc tray**  
Load a disc in the disc tray.
- ② **AUDIO DIRECT indicator**  
Lights up when you select the AUDIO DIRECT mode by pressing AUDIO DIRECT on the remote control.
- ③ **STANDBY/ON**  
Turns on this unit or sets it to the standby mode.
- ④ **POWER indicator**  
Lights up when this unit is on.
- ⑤ **POWER switch**  
Press inward to the ON position to turn on the power of this unit. Press again to release it outward to the OFF position to turn off this unit.
- ⑥ **HDMI indicator**  
Lights up green when an HDMI component is recognized by this unit and the HDMI mode is set to on.  
Lights up orange when no HDMI component is recognized by this unit while the HDMI mode is set to on.
- ⑦ **Front panel display**  
Displays playback information or settings.
- ⑧ **▲**  
Opens or closes the disc tray.
- ⑨ **⏮/⏪**  
Searches backward.\*  
Moves to the previous chapter or track.
- ⑩ **⏩/⏭**  
Searches forward.\*  
Moves to the next chapter or track.
- ⑪ **▶**  
Starts playback.
- ⑫ **⏸**  
Pauses playback.
- ⑬ **⏹**  
Stops playback.

\* Press and hold the button for about three seconds.

### Notes

- This switch is operational only when **POWER** switch (⑤) is pressed inward to the ON position.
- In the standby mode, this unit consumes a small amount of power to receive infrared signals from the remote control.

# Front panel display

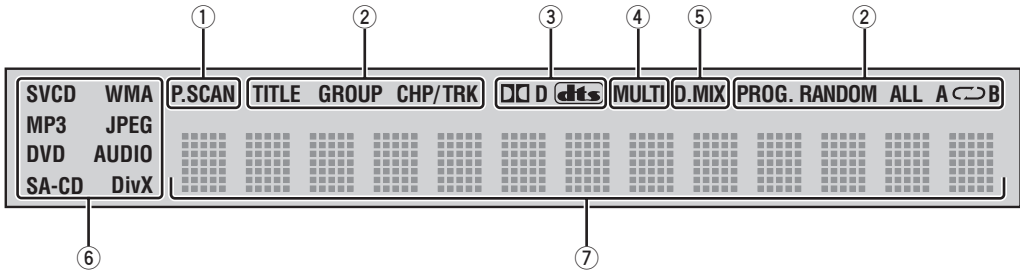

① **P.SCAN indicator**

Lights up when the progressive scan function is activated.

② **Playback mode indicators**

Display the icon for the selected playback mode.

③ **Decoder indicators**

Display the icon for the selected internal decoder.

④ **MULTI indicator**

Lights up when playing the multi-channel audio source.

⑤ **D.MIX indicator (DVD-Audio only)**

Lights up when playing the disc that allows down mixing of the multi-channel audio source.

⑥ **Disc indicators**

Display the icon for the disc type.

⑦ **Information display**

Displays various information such as a title/chapter/track number or elapsed playing time.



You can adjust the brightness of the front panel display using DIMMER on the remote control.



## Rear panel

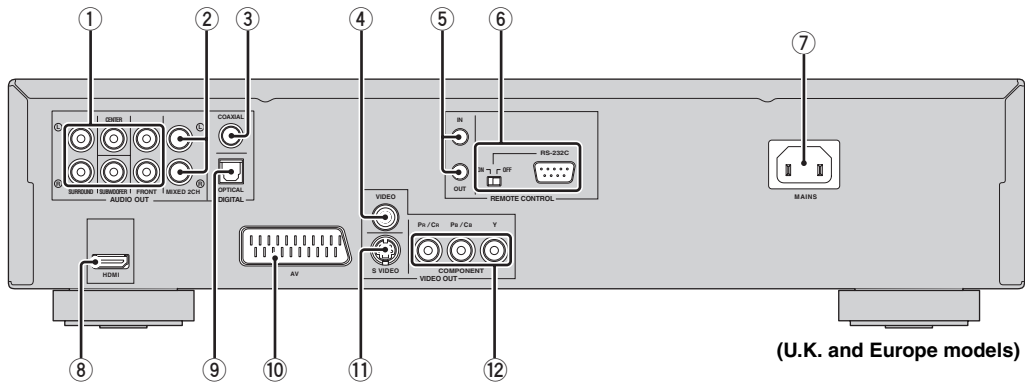

- |   |  |
|---|--|
| <p>① <b>AUDIO OUT (6ch discrete) jacks</b><br/>Connect to the 6ch input jacks of your AV receiver.</p> <p>② <b>AUDIO OUT (MIXED 2CH) jacks</b><br/>Connect to the audio input jacks of your AV receiver or stereo system.</p> <p>③ <b>DIGITAL (COAXIAL) jack</b><br/>Connect to the coaxial input jack of your AV receiver.</p> <p>④ <b>VIDEO OUT (VIDEO) jack</b><br/>Connect to the composite video input jack of your AV receiver.</p> <p>⑤ <b>REMOTE CONTROL (IN/OUT) connectors</b><br/>Use in custom installations to transmit remote control signals via cable connections.</p> <p>⑥ <b>REMOTE CONTROL (RS-232C) terminal (U.S.A., Canada, Australia, U.K. and Europe models only)</b><br/>Use as an expansion terminal for commercial use. Consult your dealer for details.</p> | <p>⑦ <b>MAINS</b><br/>Connect the supplied power cable.</p> <p>⑧ <b>HDMI jack</b><br/>Connect to the HDMI input jack of your HDMI component.</p> <p>⑨ <b>DIGITAL (OPTICAL) jack</b><br/>Connect to the optical input jack of your AV receiver.</p> <p>⑩ <b>AV terminal (U.K. and Europe models only)</b><br/>Connect to SCART input terminal of your TV.</p> <p>⑪ <b>VIDEO OUT (S VIDEO) jack</b><br/>Connect to the S-video input jack of your AV receiver.</p> <p>⑫ <b>VIDEO OUT (COMPONENT) jacks</b><br/>Connect to the component input jacks of your AV receiver.</p> |
|---|--|

### ■ Remote control connectors and RS-232C terminal

The **REMOTE CONTROL (IN/OUT)** connectors and the **REMOTE CONTROL (RS-232C)** terminal are used in custom installation. Do not connect any cables to these connectors during normal use. (For U.S.A., Canada, Australia, U.K. and Europe models, keep the RS-232C switch set to **OFF**.)

**Caution: Do not touch the inner pins of the jacks on the rear panel of this unit. Electrostatic discharge may cause permanent damage to this unit.**

## Remote control

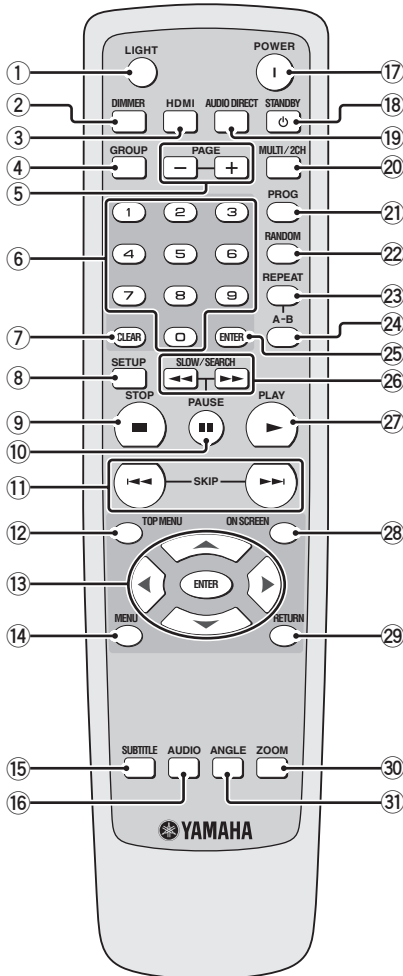

- ① **LIGHT**  
Lights up the remote control buttons.
- ② **DIMMER**  
Selects from three different levels of brightness for the front panel display: medium, low and auto. For auto setting, brightness is automatically set to low only during playback.
- ③ **HDMI**  
Switches the HDMI mode on or off.
- ④ **GROUP**  
Selects the DVD-Audio group.
- ⑤ **PAGE (+/-)**  
Selects the DVD-Audio still picture.
- ⑥ **Numeric buttons (0-9)**  
Select numbered items in the currently displayed menu.
- ⑦ **CLEAR**  
Clear the mode or setting.
- ⑧ **SETUP**  
Accesses or exits from the setup menu of this unit.
- ⑨ **STOP (■)**  
Stops playback.
- ⑩ **PAUSE (||)**  
Pauses playback temporarily. Frame-by-frame playback.
- ⑪ **SKIP (◀◀ / ▶▶)**  
Moves to the previous/next chapter or track.
- ⑫ **TOP MENU**  
Displays the top-level disc menu.

- ⑬ **Cursors** (▲ / ▼ / ◀ / ▶)  
Selects an item in the currently displayed menu.
- ENTER**  
Confirms the menu selection.
- ⑭ **MENU**  
Accesses the menu of a disc.
- ⑮ **SUBTITLE**  
Selects the subtitle language.
- ⑯ **AUDIO**  
Selects the audio language or format.
- ⑰ **POWER ( I )**  
Turns on this unit.
- ⑱ **STANDBY ( ⏻ )**  
Sets this unit to the standby mode.
- ⑲ **AUDIO DIRECT**  
Switches the video output on or off during playback.  
This function is not available for HDMI output.  
During the playback in the AUDIO DIRECT mode, the front panel display goes out.
- ⑳ **MULTI/2CH**  
Selects a sound mode: Stereo or Multi-channel.  
Changes the SA-CD playback area.
- ㉑ **PROG**  
Accesses the program setup menu to program disc tracks or exit from its menu.
- ㉒ **RANDOM**  
Plays tracks in random order.
- ㉓ **REPEAT**  
Repeats the chapter, track, title, group or disc.
- ㉔ **A-B**  
Repeats a specific segment.
- ㉕ **ENTER**  
Confirms the menu selection.
- ㉖ **SLOW/SEARCH ( ◀◀ / ▶▶ )**  
Searches backward or forward.
- ㉗ **PLAY ( ▶ )**  
Starts playback.
- ㉘ **ON SCREEN**  
Accesses or exit from the on-screen display (OSD) menu of this unit.
- ㉙ **RETURN**  
Returns to the previous setup menu.
- ㉚ **ZOOM**  
Enlarges the video image.
- ㉛ **ANGLE**  
Selects the DVD camera angle.
-   
Two ENTER buttons (⑬ and ㉕) act in the same way.

# CONNECTIONS

## General notes on connections

Be sure to turn off this unit and unplug the power supply cable, before you make or change connections.

- Depending on the component you want to connect, there are various ways to make connections. Possible connections are described below.
- Refer to the manuals supplied with your other components as necessary to make the best connections.
- Do not connect this unit via your VCR. The video quality could be distorted by the copy protection system.
- Do not connect the audio out jack of this unit to the phono in jack of your audio system.

## Audio connections

This unit has digital coaxial, digital optical, analog 6ch discrete, analog mixed 2ch and HDMI output jacks. Connection depends on the availability of audio jacks on your component.

### Connecting a stereo amplifier

Connect **AUDIO OUT (MIXED 2CH)** jacks of this unit to the corresponding input jacks of your audio component (such as a stereo amplifier) using the supplied audio pin cable. You can connect a subwoofer to the **SUBWOOFER** jack.

This unit (U.K. and Europe models)

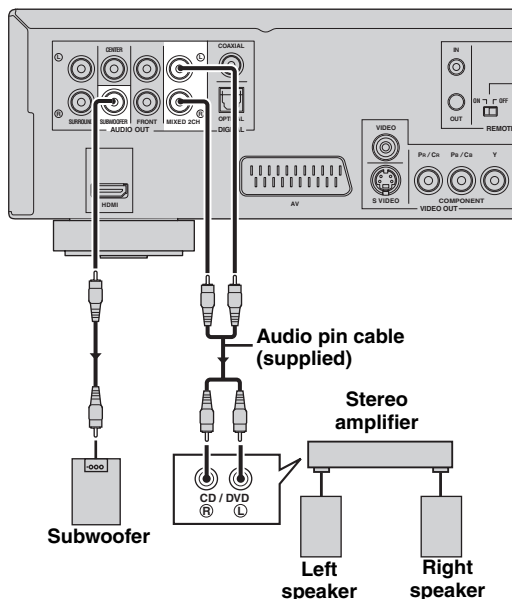

### Connecting an AV receiver with 5.1ch/ digital input jacks

#### ■ Analog connections

If you want to reproduce multi-channel Super Audio CD (SA-CD) and DVD-Audio, connect **AUDIO OUT (6ch discrete)** jacks of this unit to the corresponding input jacks of your AV receiver using commercially available audio pin cables.

This unit (U.K. and Europe models)

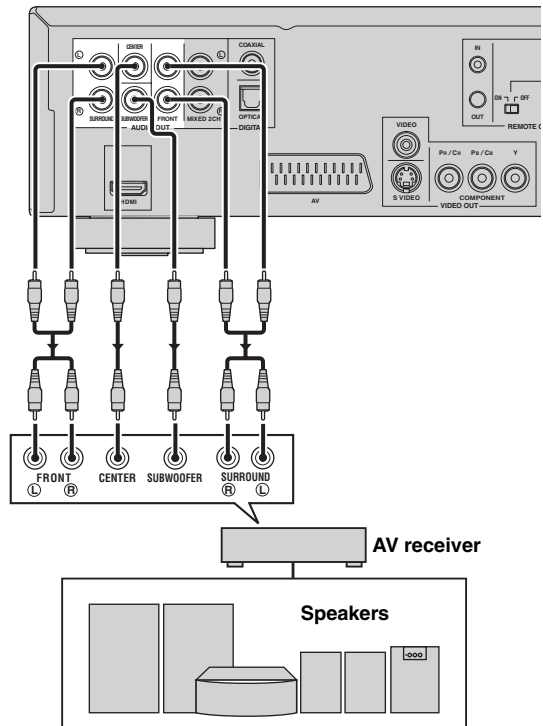

### Digital connections

If you want to use the Dolby Digital, DTS or MPEG function on your AV receiver, connect **HDMI <A>** or **DIGITAL (COAXIAL) <B>** or **DIGITAL (OPTICAL) <C>** jack of this unit to the corresponding input jacks of your AV receiver using a commercially available HDMI, digital coaxial or digital optical cable.

See “HDMI jack <A>” on page 12 about HDMI connection.

This unit (U.K. and Europe models)

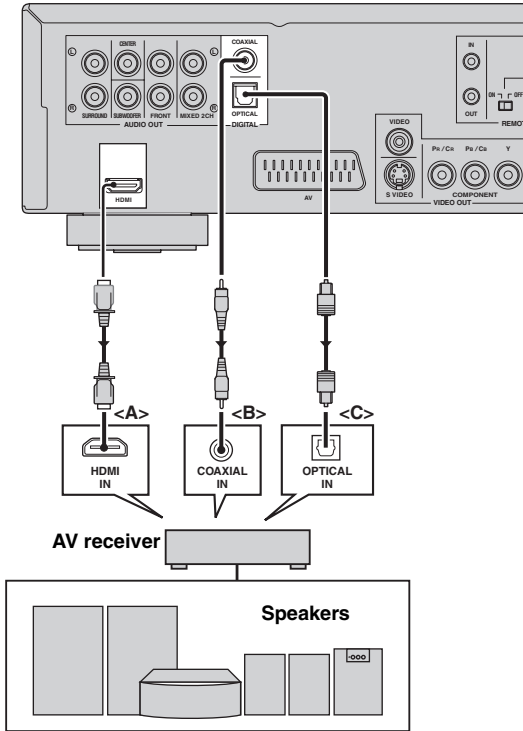

### Notes

- If you make a connection with DIGITAL (COAXIAL) <B> or DIGITAL (OPTICAL) <C>, set [Digital Out] to [All] (see “Setting the digital output” on page 28).
- If the audio format of the digital output does not match the capabilities of your receiver, the receiver produces a distorted sound or no sound at all. Make sure to select the appropriate audio format from the menu screen on the disc. Pressing AUDIO on the remote control once or more may change not only the audio languages but also the audio format.
- SA-CD audio signals are not output from DIGITAL (COAXIAL/OPTICAL) jacks.
- If you want to enjoy Dolby Digital, DTS, and MPEG formats, you must connect this unit to an AV receiver that supports these formats.

### Video connections

This unit has HDMI, composite video, S-video, component video and SCART output jacks. If your AV receiver has video output jacks, connect your receiver and then your TV so that you can use one TV for several different video sources (LD, VCR etc.) by simply switching the input source selector on your receiver. Use the one that corresponds to the input jacks on the component to be connected.

This unit (U.K. and Europe models)

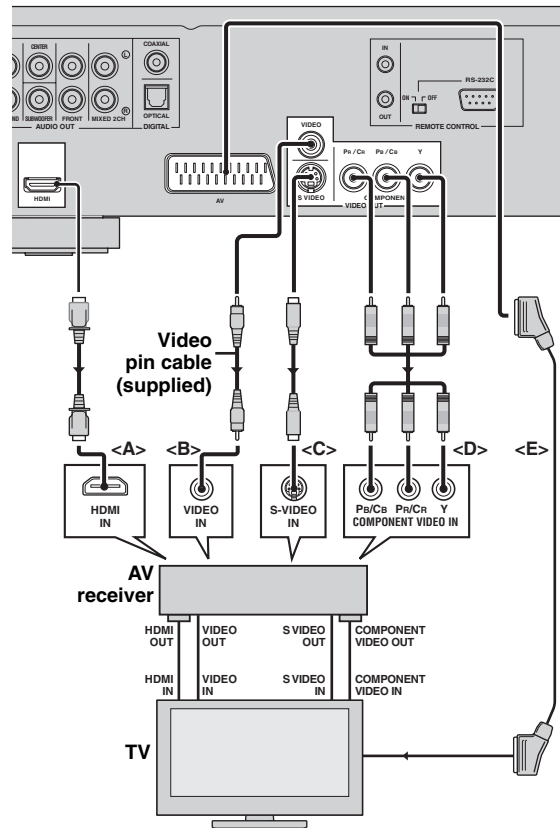

### ■ HDMI jack <A>

HDMI (High-Definition Multimedia Interface) provides high quality digital audio and video on a single connection. Connect **HDMI** jack of this unit to the HDMI input jack of your AV receiver, and then to that of your TV using a commercially available HDMI cable.

If your receiver does not have HDMI output jack, you can achieve a better video image by connecting **HDMI** jack of this unit directly to the HDMI input jack of your TV.

#### Notes

- To output HDMI signals, set the HDMI mode to “on” by pressing HDMI button on the remote control.
- You can use an HDMI-DVI converter cable in order to connect this unit to HDCP-compatible DVI-D components. In this case, you need to use another audio connection in addition to this connection because no audio signals are output.

### ■ Composite video jack <B>

Connect **VIDEO OUT (VIDEO)** jack of this unit to the video input jack of your AV receiver, and then to that of your TV using the supplied video pin cable.

### ■ S-video jack <C>

S-video connections achieve a clearer picture than composite video connections by transmitting video signals on separate wires for luminance (Y) and chrominance (C). Connect **VIDEO OUT (S VIDEO)** jack of this unit to S-video input jack of your AV receiver, and then to that of your TV using a commercially available S-video cable.

### ■ Component video jacks <D>

Component video connections achieve higher fidelity color reproduction than S-video connections by transmitting video signals on separate wires for luminance (Y: green) and chrominance (PB: blue, PR: red). Connect **VIDEO OUT (COMPONENT)** jacks of this unit to the component input jacks of your AV receiver, and then to those of your TV using a commercially available component cable. Observe the color of each jack when you make connections.

If your receiver does not have component output jacks, you can achieve a better video image by connecting the component output jacks of this unit directly to the component input jacks of your TV.

### ■ SCART terminal <E> (U.K. and Europe models only)

If your TV has only a terminal for video input, you can connect the TV directly to this unit.

Connect **AV** terminal of this unit to SCART input terminal of your TV using a commercially available SCART cable.

#### Note

- Ensure that the “TV” indication on SCART cable is connected to the TV set and “DVD” indication on SCART cable is connected to this unit.

## Connecting the power cable

After all other connections are complete, plug the supplied power cable into **MAINS** of this unit and then plug the power cable to an AC outlet.

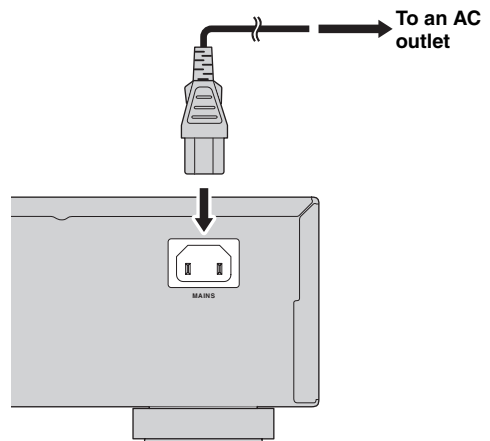

# GETTING STARTED

## Step 1: Inserting batteries into the remote control

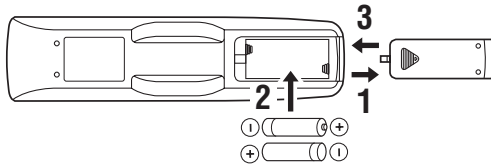

- 1 Press the ▼ part and slide the battery compartment cover off.
- 2 Insert the two supplied batteries (AAA, R03, UM-4), following the indications (+/-) on the inside of the compartment.
- 3 Slide the cover back until it snaps into place.

### Notes

- Insert batteries correctly according to the polarity markings (+/-). The batteries inserted in the opposite direction may leak.
- Replace the exhausted batteries immediately with new ones to prevent a leakage.
- Remove the batteries from the compartment if the remote control is not used for more than a month.
- If the batteries have leaked, dispose of them immediately. Avoid touching the leaked material or letting it come into contact with clothing, etc. Clean the battery compartment thoroughly before installing new batteries.
- Do not use old batteries together with new ones.
- Do not use different types of batteries (such as alkaline and manganese batteries) together. Read the packaging carefully as these different types of batteries may have the same shape and color.
- Dispose of the batteries correctly in accordance with your local regulations.

## Using the remote control

Use the remote control within 6 m (20 ft approx.) of this unit and point it toward the remote control sensor.

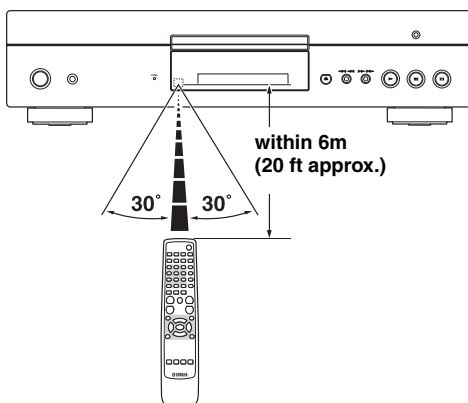

### Notes

- Do not spill water or other liquids on the remote control.
- Do not drop the remote control.
- Do not leave or store the remote control in the following types of conditions:
  - places of high humidity, such as near a bath
  - places of high temperature, such as near a heater or stove
  - places of extremely low temperature
  - dusty places

## Step 2: Turning on the power

- 1 Make sure that the power cable is connected to an AC outlet.
- 2 Turn on your TV and AV receiver.
- 3 Select the appropriate input source of the AV receiver connected to this unit. Refer to the manual supplied with your AV receiver for details.
- 4 Press **POWER** switch on the front panel.  
→ The **POWER** indicator lights up orange.
- 5 Press **STANDBY/ON** on the front panel or **POWER ( I )** on the remote control to turn on this unit.  
→ The **POWER** indicator lights up green and the front panel display lights up.
- 6 Set the TV to the correct Video IN channel (e.g., EXT1/2, AV1/2, AUDIO/VIDEO, etc. Refer to the manual supplied with your TV for details).  
→ The default screen appears on the TV.

## Step 3: Setting a TV type

This unit is compatible with both NTSC and PAL video formats. Select the color system that matches your TV.

### Notes

- Before changing the current TV Standard setting, ensure that your TV supports the selected TV type system.
- If you play an NTSC-formatted disc with the [PAL] setting or a PAL-formatted disc with the [NTSC] setting, the video quality may deteriorate.

### 1 Press **SETUP**.

→ The setup menu appears.

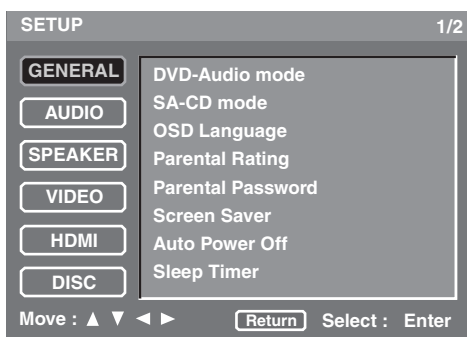

### 2 Press $\blacktriangle$ / $\blacktriangledown$ repeatedly to select [VIDEO], and then press **ENTER**.

→ [VIDEO] menu appears.

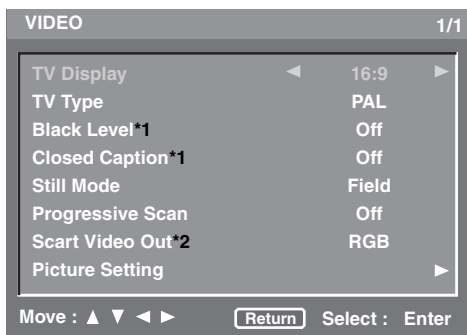

\*1: [Black Level] and [Closed Caption] are only for U.S.A. and Canada models.

\*2: [Scart Video Out] is only for U.K. and Europe models.

### 3 Press $\blacktriangle$ / $\blacktriangledown$ repeatedly to highlight [TV Type].

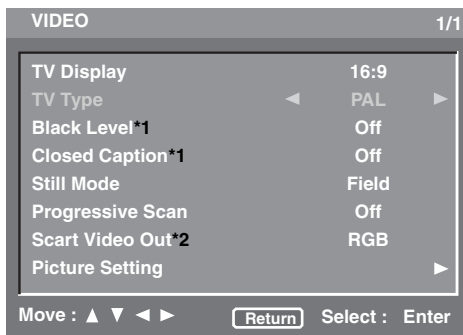

### 4 Press $\blacktriangle$ / $\blacktriangledown$ to select one of the options below.

#### PAL

Select this if the connected TV is a PAL system TV. It will change video signals of NTSC discs and output them in PAL format.

#### NTSC

Select this if the connected TV is an NTSC system TV. It will change video signals of PAL discs and output them in NTSC format.



## Step 4: Setting a language preference

You can select your own preferred language settings. This unit will automatically switch to your preferred language for you whenever you load a disc. If the language selected is not available on the disc, the default language of the disc will be used instead. The OSD (On-Screen Display) language in the system menu will remain once selected.

### Setting the OSD (On-Screen Display) language

- 1 Press **SETUP**.  
→ The setup menu appears.
- 2 Press  $\blacktriangle$  /  $\blacktriangledown$  repeatedly to highlight [GENERAL], and then press **ENTER**.  
→ [GENERAL] menu appears.

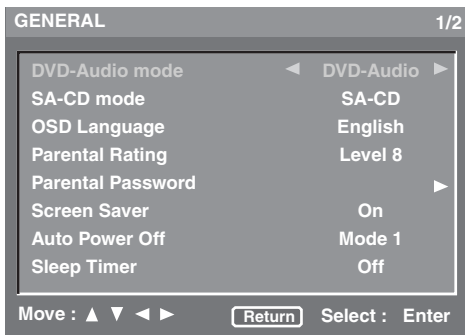

- 3 Press  $\blacktriangle$  /  $\blacktriangledown$  repeatedly to highlight [OSD Language].
- 4 Press  $\blacktriangleleft$  /  $\blacktriangleright$  to select a language.

### Setting the audio, subtitle and disc menu languages

- 1 Press **SETUP**.  
→ The setup menu appears.
- 2 Press  $\blacktriangle$  /  $\blacktriangledown$  repeatedly to highlight [DISC], and then press **ENTER**.  
→ [DISC] menu appears.

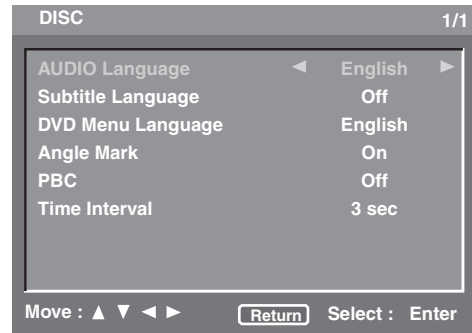

- 3 Press  $\blacktriangle$  /  $\blacktriangledown$  repeatedly to highlight [AUDIO Language] or [Subtitle Language] or [DVD Menu Language].
- 4 Press  $\blacktriangleleft$  /  $\blacktriangleright$  to select a language.

#### ■ To select the language not in the list:

- 1 Select [Others] under [AUDIO Language] or [Subtitle Language] or [DVD Menu Language].
- 2 Press **ENTER**.
- 3 Use the **numeric buttons (0-9)** to enter the 4-digit language code (see “LANGUAGE CODE LIST” on page 36).
- 4 Press **ENTER**.

# DISC OPERATION

## Notes

- Unless otherwise specified, all operations described here are carried out using the supplied remote control.
- If the inhibition icon (⊘ or “Prohibit”) appears on the TV screen when you press a button, the function for that button is not available on the current disc or at the current time.
- Depending on the DVD or Video CD disc, some operations may operate differently or be restricted.
- Do not push on the disc tray or put any objects other than discs on the disc tray. Doing so may cause the disc unit to malfunction.

## Basic operation

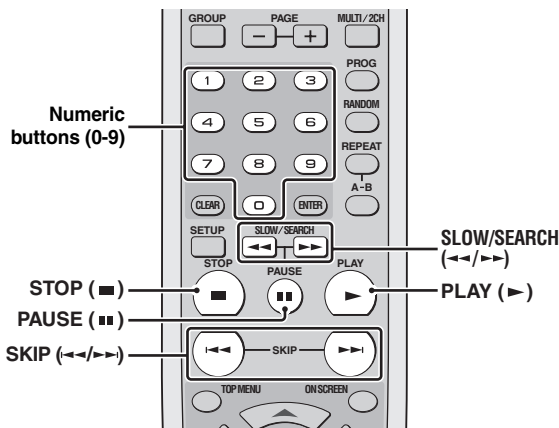

- 1 Press  $\triangle$  on the front panel to open the disc tray.
- 2 Place a disc in the disc tray with the printed side up.

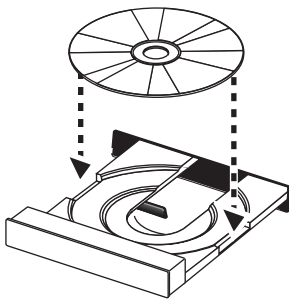

- 3 Press  $\triangle$  again to close the disc tray.
  - After recognizing the disc, this unit starts to play back automatically.
  - If you press **PLAY (▶)** when the disc tray is opened, the disc tray closes and playback starts automatically.
  - Depending on the disc, the disc reading time may exceed 30 seconds due to the complexity of the directory/file configuration.
- 4 To stop playback, press **STOP (■)**.
  - “RESUME” appears in the front panel display.
- 5 To resume playback, press **PLAY (▶)**.
  - The disc is played back from the last stopping point.



As long as you do not eject a disc, you can resume playback even if you turn off this unit.

- 6 To cancel resume mode, press **STOP (■)** twice.

## Notes

- It may not be possible to play certain MP3/JPEG/DivX discs due to the configuration and characteristics of the disc or the recording conditions.
- When you play a down mix prohibited disc, “NO DOWN MIX” lights in the front panel display.

## Pausing playback

- 1 During playback, press **PAUSE (▬▬)**.
  - Playback is paused and the sound is muted.
- 2 Press **PAUSE (▬▬)** again to select the next picture frame.
- 3 To resume normal playback, press **PLAY (▶)**.

## Selecting a track/chapter

Press **SKIP (←←/▶▶)** or use the **numeric buttons (0-9)** to select a track/chapter number.

- You can move to the top of the currently playing track/chapter by pressing **SKIP (←←)** once, and move to the previous track/chapter by pressing **SKIP (←←)** twice.
- During repeat playback of a track/chapter, press **SKIP (←←/▶▶)** to replay the same track/chapter.

## Searching backward/forward

- 1 Press **SLOW/SEARCH** (◀◀/▶▶).
  - For slow search, press **PAUSE** (||) to pause playback before pressing **SLOW/SEARCH** (◀◀/▶▶).
- 2 While searching, press **SLOW/SEARCH** (◀◀/▶▶) repeatedly to select the desired speed.
- 3 To resume normal playback, press **PLAY** (▶).

### Notes

- For WMA and JPEG, the search function (backward, forward and slow playback) is not available.
- For MP3, slow playback is not available.
- For VCD, SVCD and DivX, the slow backward function is not available.

## Repeat playback

You can repeat single chapter/track, single title/group or entire disc. Also, you can set two points (start and end points) to repeat the specified section.

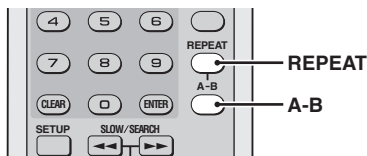

## Repeating playback

Press **REPEAT** to select the repeat play mode.

→ Each time you press the button, the display on the TV screen changes as follows:

### DVD-Video

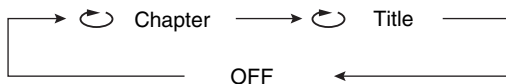

### DVD-Audio



### CD, SA-CD, VCD, SVCD

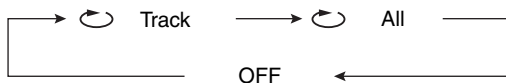

### MP3, WMA, JPEG, DivX

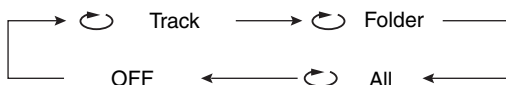

- ◌ Chapter: repeats the current chapter
- ◌ Title: repeats the current title
- ◌ Track: repeats the current track
- ◌ Group: repeats the current group
- ◌ Folder: repeats the current folder
- ◌ All\*: repeats the entire disc
- OFF: exits from repeat mode
- \*: This feature may not be available with some discs.

### Note

For VCD and SVCD, repeat playback is not available when the PBC mode is selected.

## Repeating a section (except DVD-Audio/MP3/WMA/JPEG)

- 1 During playback, press **A-B** at the desired starting point.
- 2 Press **A-B** again at the desired end point.
  - The selected section repeats continuously.
- 3 To exit from the sequence, press **A-B**.

## Random playback (except DVD/DivX/SA-CD)

You can play tracks in random order.

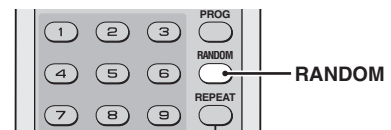

- 1 During playback, press **RANDOM**.
  - "RANDOM" appears in the front panel display and all tracks are played in random order.
- 2 To resume normal playback, press **RANDOM** again.

## Program playback (CD)

You can customize the playback order for tracks stored in the disc. This unit supports a maximum of 20 programmed tracks.

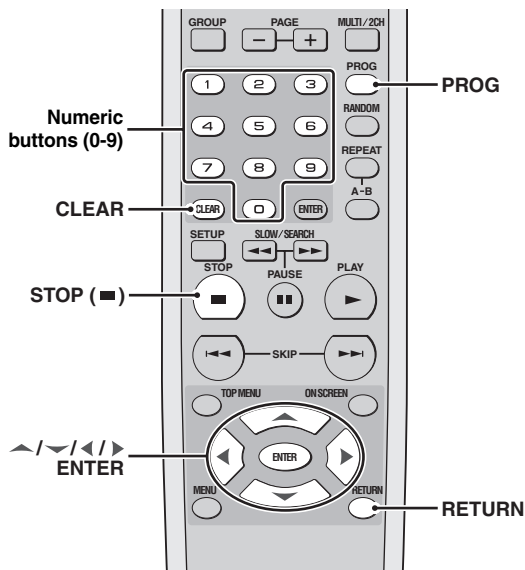

- 1 Press **STOP (■)** to stop playback if necessary.
- 2 Press **PROG.**  
→ The program setup menu appears on the TV screen.
- 3 Use the **numeric buttons (0-9)** to enter a track number you want to store as a program play.
- 4 Press **▼** to move the cursor to the next field.
- 5 Repeat step 3-4 until you store all desired tracks.
- 6 Use **▲ / ▼ / ◀ / ▶** to select [Play Program] and then, press **ENTER** to start program playback.

### ■ To clear the selected track number

Press **CLEAR**.

### ■ To clear the list

Use **▲ / ▼ / ◀ / ▶** to select [Clear All], and then press **ENTER**.

### Note

Once you take out the disc from the disc tray or turn off this unit, the stored program play content is cleared.

## Disc menu operation (DVD/VCD/SVCD)

Many DVD and Video CD (version 2.0 only) discs include original navigational menus called "DVD menus" and "Video CD playback control menus". These menus provide a convenient way to operate the disc.

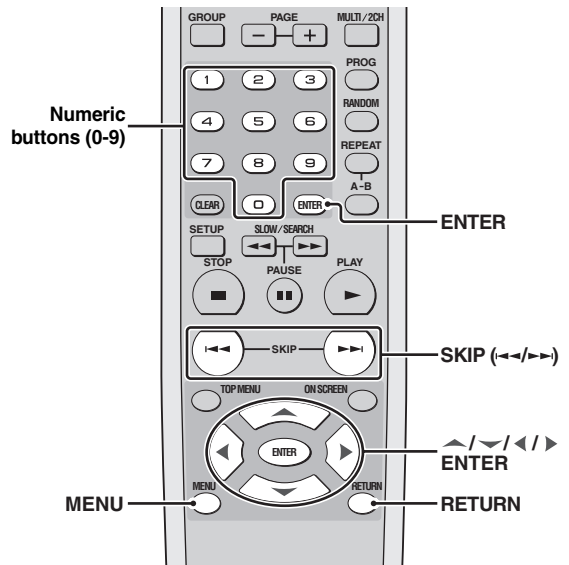

### Using the DVD menu

- 1 Press **MENU**.  
→ The DVD menu appears on the TV screen.  
• Depending on the disc, the DVD menu may appear once you load the disc.
- 2 Use **▲ / ▼ / ◀ / ▶** or the **numeric buttons (0-9)** to select a playback feature or item.
- 3 Press **ENTER** to start playback.

### ■ To exit from the menu

Press **MENU**.

## Using the Video CD playback control (PBC) menu (VCD/SVCD)

- 1 Press **MENU** to turn on the PBC function.
    - The disc menu appears on the TV screen.
    - Depending on the disc, the disc menu may appear once you load the disc.
  - 2 Use **SKIP** (◀◀/▶▶) or the **numeric buttons (0-9)** to select a playback option.
  - 3 During playback, press **RETURN** to return to the menu screen.
- **To skip the index menu and play back a disc directly from the beginning**

Press **MENU** to turn off the PBC function.



You can also use the setup menu to turn on or off the playback control (PBC) function (see “Selecting the PBC (playback control) function” on page 35).

## On-screen display (OSD) menu (DVD/VCD/SVCD/SA-CD)

The OSD menu shows disc playback information (e.g., the title or chapter number, elapsed playing time or audio/subtitle language). A number of operations are possible without interrupting disc playback.

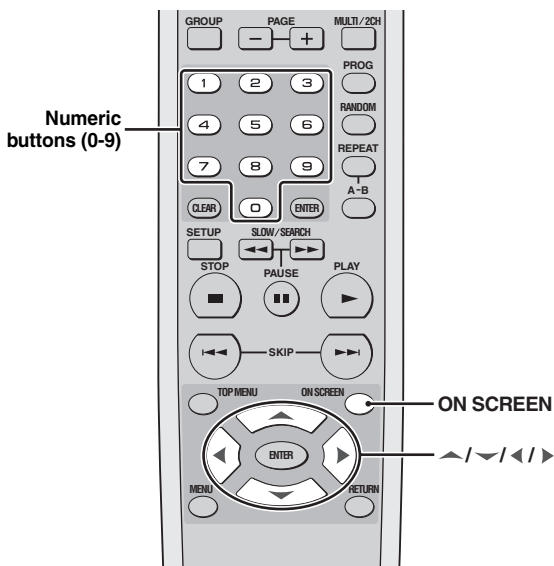

## Using the OSD menu (DVD/VCD/SVCD/CD)

During playback, press **ON SCREEN**.

→ A list of available disc information appears on the TV screen.

### DVD-Video

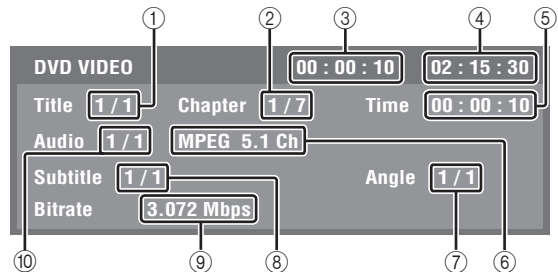

### DVD-Audio

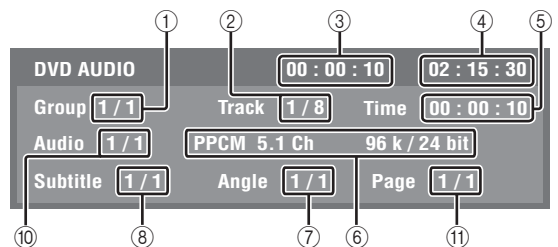

### VCD/SVCD/CD

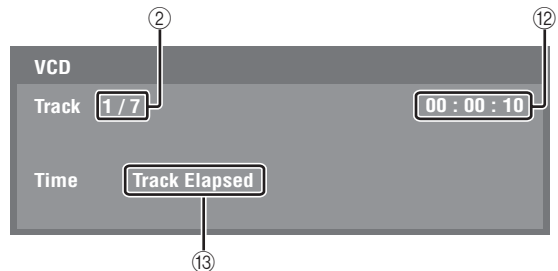

- ①: Current title or group number/Total number of titles or groups
- ②: Current chapter or track number/Total number of chapters or tracks
- ③: Elapsed time
- ④: Time remaining
- ⑤: Elapsed time (You can input numbers for time search.)
- ⑥: Audio information
- ⑦: Current angle number/Total number of available angles
- ⑧: Current subtitle number/Total number of available subtitle languages
- ⑨: Data transmission speeds
- ⑩: Current audio number/Total number of available audio languages
- ⑪: Current page number/Total number of pages
- ⑫: Time (You can select a category of time.)
- ⑬: Category of time being displayed on ⑫

### ■ To select a title (DVD-Video)/group (DVD-Audio)

- 1 Press  $\blacktriangle$  /  $\blacktriangledown$  /  $\blacktriangleleft$  /  $\blacktriangleright$  repeatedly to highlight ①, and then enter a title/group number using the **numeric buttons (0-9)**.
- 2 Press **ENTER**.

### ■ To select a chapter (DVD-Video)/track (VCD/SVCD/DVD-Audio)

- 1 Press  $\blacktriangle$  /  $\blacktriangledown$  /  $\blacktriangleleft$  /  $\blacktriangleright$  repeatedly to highlight ②, and then enter a chapter or track number using the **numeric buttons (0-9)**.
- 2 Press **ENTER**.

### ■ To search for a time

- 1 Press  $\blacktriangle$  /  $\blacktriangledown$  /  $\blacktriangleleft$  /  $\blacktriangleright$  repeatedly to highlight ⑤, and then enter hours, minutes and seconds from left to right using the **numeric buttons (0-9)**.
- 2 Press **ENTER**.

#### Note

When searching for a time, if you enter a time outside the total time for the group/track currently being played back, the inhibition icon (⊘) is displayed.

### ■ To select an angle/subtitle/audio

- 1 Press  $\blacktriangle$  /  $\blacktriangledown$  /  $\blacktriangleleft$  /  $\blacktriangleright$  repeatedly to highlight ⑦, ⑧ or ⑩, and then enter a audio, subtitle or angle number using the **numeric buttons (0-9)**.
- 2 Press **ENTER**.

#### Note

You cannot change the [Angle]/[Subtitle]/[Audio] setting if the function is not available on the disc you are playing.

### ■ To select a page (DVD-Audio)

- 1 Press  $\blacktriangle$  /  $\blacktriangledown$  /  $\blacktriangleleft$  /  $\blacktriangleright$  repeatedly to highlight ⑪, and then enter a page number using the **numeric buttons (0-9)**.
- 2 Press **ENTER**.

### ■ To select a category of time (VCD/SVCD/CD)

Press  $\blacktriangle$  /  $\blacktriangledown$  /  $\blacktriangleleft$  /  $\blacktriangleright$  repeatedly to highlight ⑫, and then press **ENTER** to toggle between the category of time.

### ■ To exit from the OSD menu

Press **ON SCREEN**.

## Displaying text information (SA-CD)

Some SA-CD discs contain text information (e.g., track name, album name, artist name etc.). If SA-CD text is available on the disc, the track name is automatically displayed on the TV screen once you load the disc.

### ■ To display the album/artist name

During playback, press **ON SCREEN**.

## Zooming pictures (DVD-Video/VCD/SVCD/DivX/JPEG)

You can enlarge the picture on the TV screen and to pan through the enlarged picture.

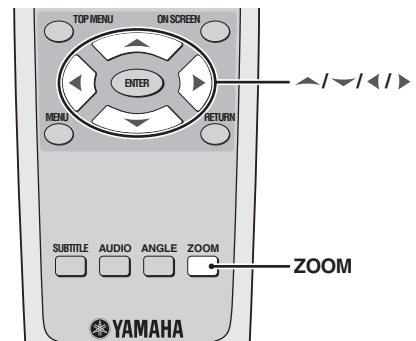

- 1 During playback, press **ZOOM** repeatedly to display the picture at different scales.
- 2 To pan through the enlarged picture, press  $\blacktriangle$  /  $\blacktriangledown$  /  $\blacktriangleleft$  /  $\blacktriangleright$  to pan through the enlarged picture.
- 3 Press **ZOOM** repeatedly to return to the original size.

## Viewing angles (DVD-Video)

If the disc contains sequences recorded from different camera angles, you can view the picture from a number of different angles.

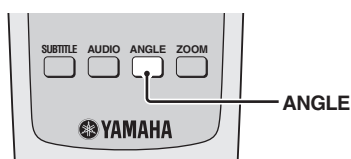

### Note

Viewing angles available for each disc may vary. Refer to the operating instructions in the DVD menu or on its jacket.

Press **ANGLE** repeatedly to select the desired angle.

## Audio and Subtitle languages (DVD-Video)

If the disc contains multi-language options, you can select audio/subtitle languages.

### Note

Languages available for each disc may vary. Refer to the operating instructions in the disc menu or on its jacket.



You can set default audio/subtitle languages in the setup menu (see “Setting the audio, subtitle and disc menu languages” on page 15).

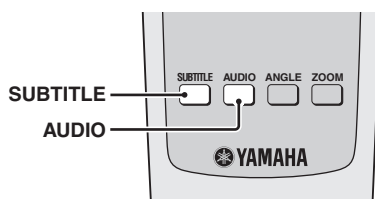

## Selecting an audio language

Press **AUDIO** repeatedly to select an audio language.

## Selecting a subtitle language

Press **SUBTITLE** repeatedly to select a subtitle language.

## DivX external subtitle files

The font sets listed below are available for DivX external subtitle files. To watch DivX discs with the desired font set, set the default subtitle language setting in the setup menu to the desired language (see “Setting the audio, subtitle and disc menu languages” on page 15).

### This unit supports the following languages:

Albanian, Breton, Bulgarian, Byelorussian, Catalan, Croatian, Czech, Danish, Dutch, English, Faroese, Finnish, French, German, Hungarian, Icelandic, Irish, Italian, Kurdish (Latin), Macedonian, Greek, Hebrew, Moldavian, Norwegian, Polish, Portuguese, Romanian, Russian, Serbian, Slovak, Slovenian, Spanish, Swedish, Turkish, Ukrainian

### Notes

- Some discs cannot be played depending on disc characteristics or recording conditions.
- Some external subtitle files may be displayed incorrectly or not at all.
- For external subtitle files, the following filename extensions of subtitle format are supported (note that these files are not shown within the disc navigation menu):  
.srt, .sub, .ssa, .smi, .ass, .txt, .psb, .sami
- The filename of the movie file has to be repeated at the beginning of the filename for the external subtitle file.
- For a movie file, only one external subtitle file can be loaded.

## Changing pages (DVD-Audio)

Many DVD-Audio discs include slide show and page turn functions. You can display information pages for photo galleries, artist biographies, lyrics, etc. if these functions are available on the disc.

Press **PAGE (+/-)** repeatedly to move to the next/previous page.

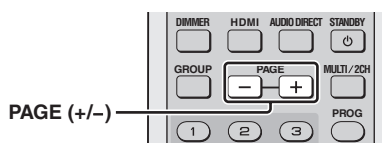

## Group/File selection (DVD-Audio/DivX/MP3/WMA/Kodak picture CD)

You can select a track in a specific group for DVD-Audio discs and a track/file in a folder for data disc.

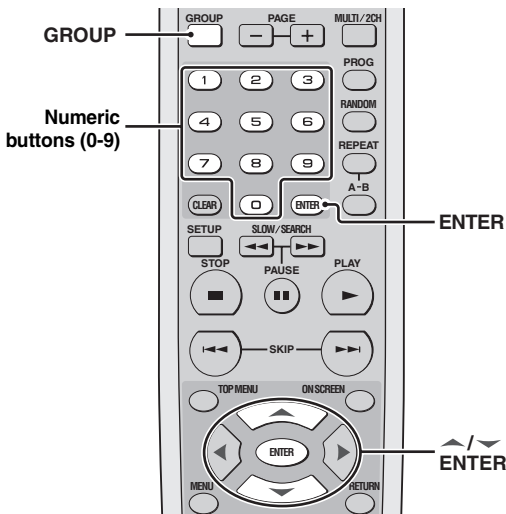

## Bonus group playback (DVD-Audio)

Some DVD-Audio discs contain bonus groups that require a four-digit password to gain access. In this case, refer to the disc jacket and other packaging for information.

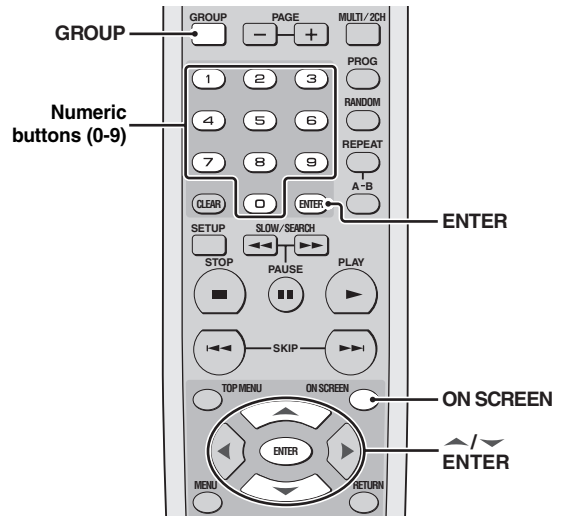

### Selecting a group (DVD-Audio)

- 1 Press **GROUP**.  
→ A group icon appears on the TV screen.



- 2 Use  $\blacktriangle$  /  $\blacktriangledown$  or the **numeric buttons (0-9)** to select a group number.
- 3 Press **ENTER**.

### Selecting a file in a folder (DivX/MP3/WMA/Kodak picture CD)

- 1 Press  $\blacktriangle$  /  $\blacktriangledown$  to select a folder, and then press **ENTER** to open the folder.
- 2 Press  $\blacktriangle$  /  $\blacktriangledown$  to select a file, and then press **ENTER**.  
→ Playback starts from the selected file.
  - If you use the **numeric buttons (0-9)** to select a file, playback starts from the selected file automatically.

- 1 Press **GROUP**.  
→ A group icon appears on the TV screen.



- 2 Use  $\blacktriangle$  /  $\blacktriangledown$  or the **numeric buttons (0-9)** to select a bonus group number, and then press **ENTER**.
- 3 Enter a four-digit password using the **numeric buttons (0-9)**, and then press **ENTER**.
- 4 Press  $\blacktriangle$  /  $\blacktriangledown$  to select a track, and then press **ENTER**.

## Changing the playback area and layer (SA-CD)

There are three types of SA-CD discs: single-layer, dual-layer and hybrid. Each type may contain up to two areas of recorded information: a High Quality Stereo area and a High Quality Multi-channel area. You can switch between the SA-CD multi-channel and SA-CD stereo areas.

### Note

You cannot change the analog output setting during SA-CD playback (see "Setting the analog output" on page 28).



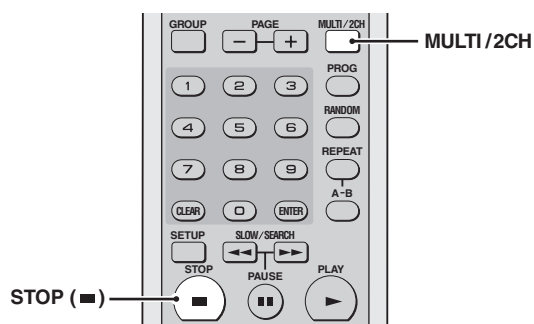

- 1 Press **STOP** (■) to stop playback.
- 2 Press **MULTI/2CH**.  
→ MULTI indicator lights up when the multi-channel area is selected.

## Multimedia file playback (MP3/WMA/DivX/JPEG)

You can play MP3, WMA, DivX and JPEG files on a personally recorded CD-R/RW disc or commercial CD.

### Note

Some files cannot be played correctly depending on disc characteristics or recording conditions.



You can set the duration for each image of a slide show (see "Setting the duration for a slide show" on page 35).

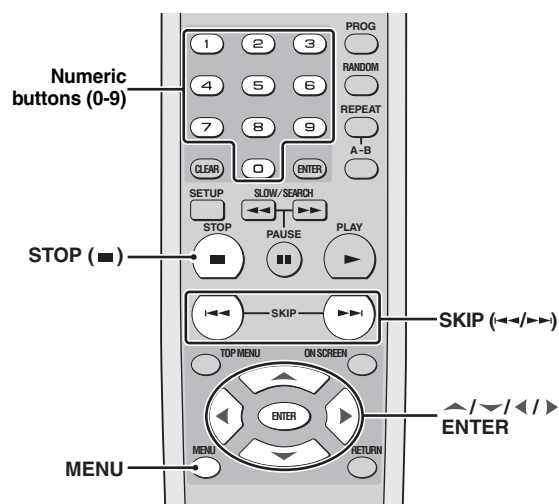

- 1 Load a disc in the disc tray.  
→ Playback starts automatically.  
→ For MP3 and WMA, the data disc menu appears on the TV screen.  
→ For DivX and JPEG, press **STOP** (■) during playback to display the data disc menu.



- 2 Press **▲** / **▼** to select a folder, and then press **ENTER** to open the folder.
  - To move to the upper folder, select the folder icon with two dots when disc playback is stopped.
- 3 Press **▲** / **▼** to select a file, and then press **ENTER**.  
→ Playback starts from the selected file.
  - If you use the **numeric buttons (0-9)** to select a file, playback starts from the selected file automatically.

## Displaying the thumbnail screen (JPEG)

- 1 Press **MENU** during playback.  
→ The thumbnail pictures appear on the TV screen.

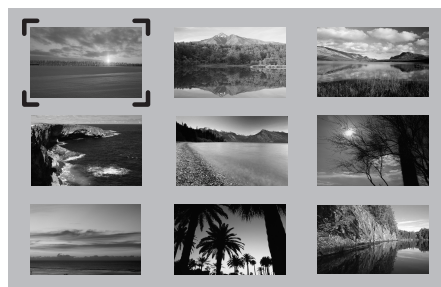

- 2 Press **SKIP** (◀◀ / ▶▶) to display the other pictures on the previous/next page.
- 3 Press **▲** / **▼** / **◀** / **▶** to highlight one of the pictures, and press **ENTER** to start playback.
- 4 Press **STOP** (■) to return to the data disc menu.

## Rotating pictures (JPEG)

During playback, press **▲** / **▼** / **◀** / **▶** to rotate the picture on the TV screen.

- ◀: rotates the picture counter-clockwise by 90 degrees
- ▶: rotates the picture clockwise by 90 degrees
- ▲, ▼: rotates the picture by 180 degrees

# SETUP MENU

## Menu overview

Main Menu	Menu item	Setting Item/Submenu	Setting item/Parameter
GENERAL	DVD-Audio mode	DVD-Audio, DVD-Video	
	SA-CD mode	SA-CD, CD	
	OSD Language	English, Deutsch, Français, Español, Italiano, Русский	
	Parental Rating	____ (Enter your password)	Level 1 to Level 8
	Parental Password	____ (Enter your password)	New Password, Confirm Password
	Screen Saver	On, Off	
	Auto Power Off	Mode 1, Mode 2, Off	
	Sleep Timer	Off, 30 min, 60 min, 90 min, 120 min, 150 min	
	Factory Default	____ (Enter your password)	Yes, No
DivX Registration	(DivX registration code is displayed)	Enter	
AUDIO	Analog Output	Stereo, Multi-Channel	
	Digital Out	All, PCM, Off	
	LPCM Output	48KHz, 96KHz	
	Night Listening Mode	On, Off	
SPEAKER	Size	Front L/R	Large, Small
		Center, Surround L/R	Large, Small, Off
		Subwoofer, Initialize	On, Off
	Distance	Unit	Feet, Meter
		Front L/R, Center, Surround L/R	1ft to 40ft (0.3m to 12.0m)
		Initialize	On, Off
	Level	Front L, Center, Front R, Surround L, Surround R, Subwoofer	0dB to -12dB
		Test Tone	Off, Manual, Auto
		Initialize	On, Off
	SA-CD Config	Config 1, Config 2, Config 3	
CUT-OFF Frequency	60, 80, 100, 120		
VIDEO	TV Display	16:9, 4:3 Pan Scan, 4:3 Letter Box	
	TV Type	NTSC, PAL	
	Black Level (U.S.A. and Canada models only)	On, Off	
	Closed Caption (U.S.A. and Canada models only)	On, Off	
	Still Mode	Frame, Field	
	Progressive Scan	On, Off	
	Scart Video Out (U.K. and Europe models only)	CVBS, RGB	
	Picture Setting	Brightness	0 to +6
		Contrast, Hue, Sharpness Mid, Sharpness High	-6 to +6
		DNR	0 to +6
		Gamma, Chroma level	-6 to +6
Chroma delay		-2 to +2	
True Life	0 to +6		
HDMI	HDMI Video	480P/576P, 720P, 1080I, 1080P, Auto	
	Wide Screen Format	NL Stretch, Pillar Box, Off	
	DVI Output Range	Standard, Enhanced	
	HDMI Audio	Auto, PCM, Off	
DISC	AUDIO Language	Off ([Subtitle Language] only), English, French, Spanish, Japanese, German, Italian, Russian, Others	
	Subtitle Language		
	DVD Menu Language		
	Angle Mark	On, Off	
	PBC	On, Off	
Time Interval	2 sec to 10 sec		

## Setup menu operation

Setup is carried out on the TV screen, enabling you to customize this unit to suit your own particular requirements. Follow the procedures below to start the setup menu operations.

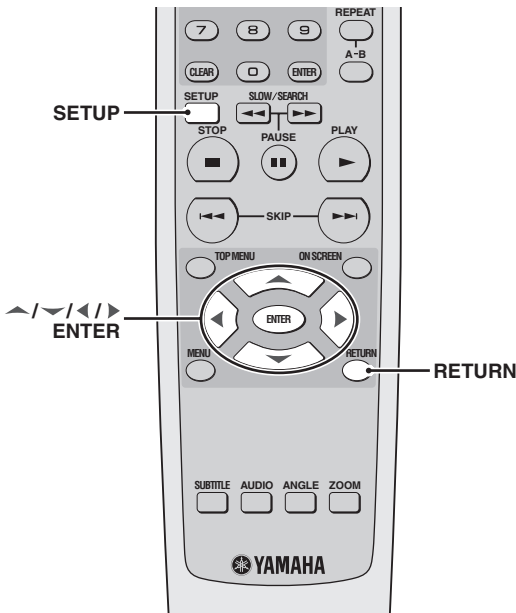

- Press **RETURN** to display the previous menu.
- Press **SETUP** to exit from the setup menu.
- Refer to the following pages for details of the menu that requires a particular operation.

### 1 Press **SETUP**.

→ Main menus and menu items appear on your TV.

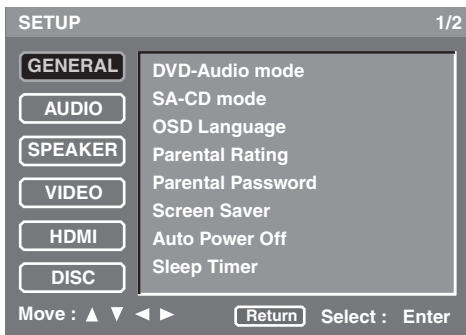

### 2 Press ▲ / ▼ to select the desired main menu, and then press **ENTER**.

→ Menu items and setting items appear.

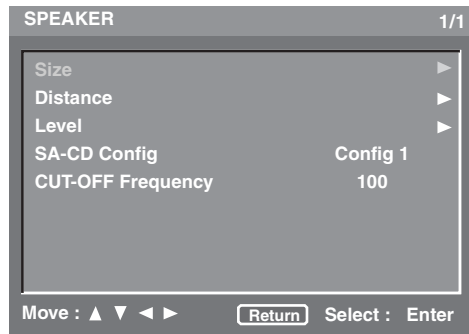

### 3 Press ▲ / ▼ to highlight the desired menu item.

→ If the selected menu item has only setting items, left and right arrows appear on both sides of the setting item.

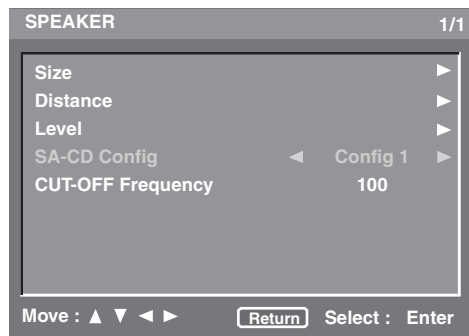

→ If the selected menu item has submenus, only a right arrow is displayed on the side of the setting item.

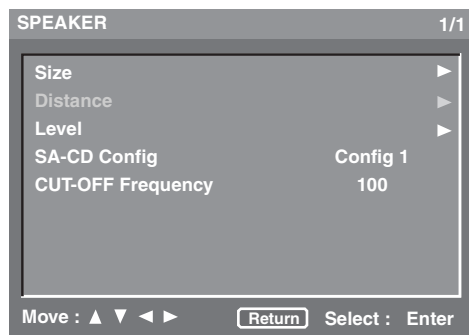

In this case, press ▶, and then repeat step 3.

### 4 Press ◀ / ▶ to toggle the setting items or to adjust the parameter.

## General setup menu

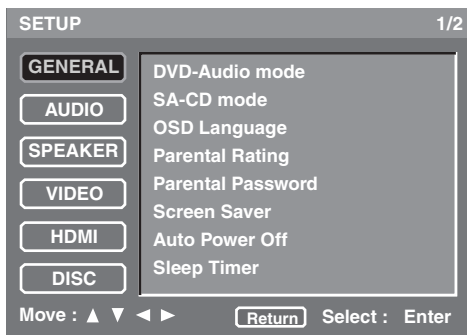

### Selecting DVD-Audio mode

Some DVD-Audio discs contain the DVD-Video content in addition to the DVD-Audio content. You can select DVD-Audio or DVD-Video mode.

- Select [DVD-Audio mode] in [GENERAL] menu.

#### DVD-Audio

Select this to play back both DVD-Audio and DVD-Video contents. Only the DVD-Audio content may be played back depending on the disc.

#### DVD-Video

Select this to play back only the DVD-Video content.

#### Notes

- This setting is only available when no disc is loaded in the disc tray.
- Selected mode becomes effective after you close the setup menu.



- When a DVD-Audio disc is played back, the DVD AUDIO indicator lights up.
- When you select [DVD-Video], the DVD AUDIO indicator goes out.

### Selecting SA-CD mode

Some SA-CD discs contain both SA-CD layer and the standard CD layer. You can select SA-CD or CD mode.

- Select [SA-CD mode] in [GENERAL] menu.

#### SA-CD

Select this to play back SA-CD layer.

#### CD

Select this to play back CD layer.

#### Notes

- This setting is only available when no disc is loaded in the disc tray.
- Selected mode becomes effective after you close the setup menu.

## Setting the OSD language

This menu contains various options for the on-screen display (OSD) language. For details, see “Setting the OSD (On-Screen Display) language” on page 15.

### Restricting playback with parental control

Some DVD discs have a parental level assigned to the complete disc or to certain scenes on the disc. This feature lets you set a playback limitation level.

The rating levels are from 1 to 8 and are country dependent. You can prohibit playback of certain discs that are not suitable for your children or play certain discs in alternative scenes.

- 1 Select [Parental Rating] in [GENERAL] menu.
- 2 Enter your four-digit password using the **numeric buttons (0-9)**. (For details about the password, see “Changing the parental password” below.)
  - If the password is correct, [Parental Rating] is enabled to select.
- 3 Press ◀/▶ to select the rating level.
  - To disable parental controls and have all discs play, select [Level 8].

#### Notes

- VCD, SVCD, CD and SA-CD have no level indication, so the parental control function has no effect with these types of discs.
- Some DVD discs are not encoded with a rating though the movie rating may be printed on the disc cover. The rating level feature does not work for such discs.

### Changing the parental password

You can change the password for parental control. Enter your four-digit password when prompted on the screen. The default password is “2580”.

- 1 Select [Parental Password] in [GENERAL] menu.
- 2 Enter your old four-digit password using the **numeric buttons (0-9)**.
  - When doing this for the first time, enter “2580”.
  - If the password is correct, the submenu appears.
- 3 Enter the new four-digit password using the **numeric buttons (0-9)**.
  - [Confirm Password] is highlighted.
- 4 Enter the new four-digit password again.
  - The previous menu screen appears and the new four-digit password is now valid.

## Setting the screen saver

You can turn on or off the screen saver.

- Select [Screen Saver] in [GENERAL] menu.

### On

Select this to turn on the screen saver when disc playback is stopped for more than 15 minutes.

### Off

Select this to disable the screen saver function.

## Setting the auto power function

You can set the auto standby mode.

- Select [Auto Power Off] in [GENERAL] menu.

### Mode 1

Select this to set this unit to the standby mode automatically when disc playback is stopped for more than 30 minutes or disc playback is continued for more than six hours without operation.

### Mode 2

Select this to set this unit to the standby mode automatically when disc playback is stopped for more than 30 minutes.

### Off

Select this to disable the auto power off function.

## Setting the sleep timer

You can set this unit to the standby mode automatically after a certain elapsed period.

- Select [Sleep Timer] in [GENERAL] menu.

### 30 min, 60 min, 90 min, 120 min, 150 min

Select one to set the sleep timer function.

### Off

Select this to cancel the sleep timer function.

## Resetting the system

You can reset all options and your personal settings to the initial factory settings, except [Parental Rating] and [Parental Password].

- 1 Select [Factory Default] in [GENERAL] menu.
- 2 Enter your four-digit password using the **numeric buttons (0-9)**. (For details about the password, see “Changing the parental password” on page 26.)  
→ The confirmation screen appears.

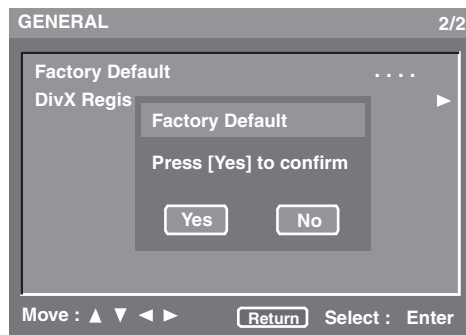

- 3 Press ◀/▶ to select [Yes] to reset the system, and then press **ENTER**.  
→ All settings are reset to the initial factory settings.

## Displaying the DivX® VOD registration code

Yamaha provides you with the DivX® VOD (Video On Demand) registration code that allows you to rent and purchase videos using the DivX® VOD service. For more information, visit at [www.divx.com/vod](http://www.divx.com/vod).

- 1 Select [DivX Registration] in [GENERAL] menu.
- 2 Press ▶.  
→ The registration code appears.
- 3 Press **ENTER** to return to the previous menu.



To purchase or rent the videos from DivX® VOD service at [www.divx.com/vod](http://www.divx.com/vod), use the registration code and download the video onto a CD-R for playback on this unit.

### Notes

- All videos downloaded from DivX® VOD can only be played back on this unit.
- The time search function is not available during DivX movie playback.

## Audio setup menu

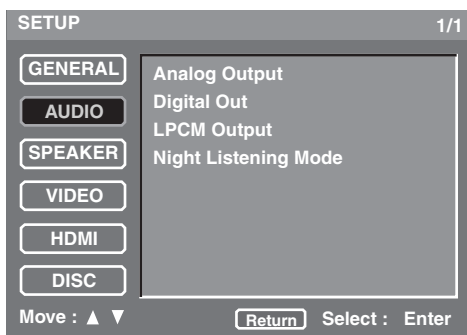

### Setting the analog output

Set the analog output to match the playback capability of this unit.

- Select [Analog Output] in [AUDIO] menu.

#### Stereo

Select this to change channel output to stereo, which only delivers sound from the two front speakers.

#### Multi-Channel

Select this when using a multi-channel audio/(video) receiver with 6 channel inputs. In this mode, this unit performs DTS decoding or Dolby Digital 5.1-channel decoding when applicable.

### Setting the digital output

Set the digital output according to your optional audio component connections.

- Select [Digital Out] in [AUDIO] menu.

#### All

Select this if you have connected the digital audio output jack to a multi-channel decoder/receiver.

#### PCM

Select this only if your receiver is not capable of decoding multi-channel audio signals.

#### Off

Select this to turn off the digital output.

### Setting the LPCM output

Set the LPCM output if you have connected this unit to a PCM-compatible receiver via a digital terminal, such as the coaxial or optical terminals.

Discs are recorded at a certain sampling rate. The higher the sampling rate, the better the sound quality.

- Select [LPCM Output] in [AUDIO] menu.

#### 48KHz

Select this to play back discs recorded at the sampling rate of 48 kHz. All 96 kHz PCM data streams (if available) are converted to the sampling rate of 48 kHz.

#### 96KHz

Select this to play back discs recorded at the sampling rate of 96 kHz. If the 96 kHz disc is copy protected, the digital output is automatically converted to a sampling rate of 48 kHz.

### Setting the night listening mode

In this mode, high volume output is softened and low volume output is brought upward to an audible level. It is useful when you watch your favorite action movie without disturbing others at night.

- Select [Night Listening Mode] in [AUDIO] menu.

#### On

Select this to level out the volume. This feature is only available for movies with Dolby Digital mode.

#### Off

Select this when you want to enjoy the full dynamic range of surround sound.

## Speaker setup menu

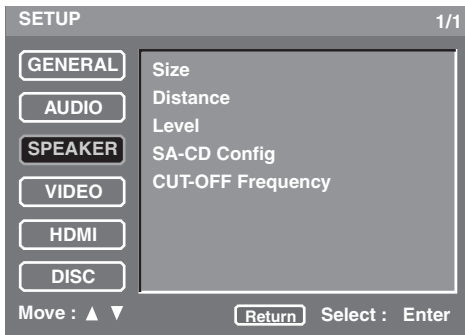

### Setting speaker sizes

You can set the sizes for individual speakers.

- Select [Size] in [SPEAKER] menu.

#### Front L/R

Set the sizes for front L/R speakers.

##### Large

Select this if the connected speakers are large.

##### Small

Select this if the connected speakers are small.

#### Center, Surround L/R

Set the sizes for center/surround L/R speakers.

##### Large

Select this if the connected speakers are large.

##### Small

Select this if the connected speakers are small.

##### Off

Select this if no center/surround L/R speakers are connected.

#### Subwoofer

Select on or off for the subwoofer.

##### On

Select this if a subwoofer is connected.

##### Off

Select this if no subwoofer is connected.

#### Notes

- These settings are not available for SA-CD discs. See “Setting the SA-CD configuration” on page 30 for the SA-CD setting.
- [Center], [Surround L/R] and [Subwoofer] settings are not available when the [Analog Output] setting is set to [Stereo] (See “Setting the analog output” on page 28).

### Initialize

You can reset [Size] settings to the initial factory settings.

- 1 Select [Initialize] under [Size] in [SPEAKER] menu.
- 2 Press **▶**.  
→ The confirmation screen appears.
- 3 Select [Yes] to reset the setting, and then press **ENTER**.  
→ [Size] settings are reset to the initial factory settings.

### Setting speaker distances

You can set the distances for individual speakers.

Placing all speakers except for the subwoofer at equal distances from the listener is the most ideal way of the speaker positioning in 5.1 channel system.

- Select [Distance] in [SPEAKER] menu.

#### Unit

You can select the display unit of measurement.

##### Feet

Select this to input speaker distances in feet.

##### Meter

Select this to input speaker distances in meters.

#### Front L/R

Set the distance from your listening position to the front speakers. We recommend to place the front left speaker and right speaker at the same distance from the listening position.

Control range: **1ft to 40ft (0.3m to 12.0m)**

Control step: **1ft (0.3m)**

#### Center

Set the distance from your listening position to the center speaker.

Control range: **1ft to 40ft (0.3m to 12.0m)**

Control step: **1ft (0.3m)**

#### Note

For the [Center] setting, you cannot specify the distance beyond the [Front L/R] setting or below the [Front L/R] setting minus 5ft (1.5m).

### Surround L/R

Set the distance from your listening position to the surround speakers. We recommend to place the surround left speaker and right speaker at the same distance from the listening position.

Control range: **1ft to 40ft (0.3m to 12.0m)**

Control step: **1ft (0.3m)**

#### Note

For the [Surround L/R] setting, you cannot specify the distance beyond the [Front L/R] setting or below the [Front L/R] setting minus 15ft (4.5m).

### Initialize

You can reset [Distance] settings to the initial factory settings.

- 1 Select [Initialize] under [Distance] in [SPEAKER] menu.
- 2 Press **▶**.  
→ The confirmation screen appears.
- 3 Select [Yes] to reset the setting, and then press **ENTER**.  
→ [Distance] settings are reset to the initial factory settings.

### Setting speaker levels

You can set the volume levels for individual speakers.

- Select [Level] in [SPEAKER] menu.

#### Front L, Center, Front R, Surround L, Surround R, Subwoofer

Set the volume levels for front L/R speakers, center speaker, surround L/R speakers or subwoofer.

Control range: **0dB to -12dB**

Control step: **1dB**

#### Test Tone

A test tone can be output to help you judge the volume level of each speaker.

- 1 Select [Test Tone] under [Level] in [SPEAKER] menu.
- 2 Press **◀/▶** to select [Off], [Manual] or [Auto].
  - Off**  
Select this to output no test tone.
  - Manual**  
Select this to output the test tone manually.
  - Auto**  
Select this to output the test tone from each speaker automatically.

- 3 For [Auto], press **ENTER** to output the test tone. For [Manual], press **▲/▼** to select each speaker, and then press **ENTER** to output the test tone.

### Initialize

You can reset [Level] settings to the initial factory settings.

- 1 Select [Initialize] under [Level] in [SPEAKER] menu.
- 2 Press **▶**.  
→ The confirmation screen appears.
- 3 Select [Yes] to reset the setting, and then press **ENTER**.  
→ [Level] settings are reset to the initial factory settings.

### Setting the SA-CD configuration

You can select speaker sizes and on/off statuses for SA-CD discs.

- Select [SA-CD Config] in [SPEAKER] menu.

#### Config 1, Config 2, Config 3

Select speaker sizes and on/off statuses from the following three settings.

Speaker	Size or on/off		
	Config 1	Config 2	Config 3
Front L/R	Large	Small	Large
Center	Large	Small	Small
Surround L/R	Large	Small	Small
Subwoofer	On	On	Off

### Setting the cut-off frequency (SA-CD only)

You can select a cut-off (cross-over) frequency for all low-frequency signals. All frequencies below the selected frequency are sent to the subwoofer.

- Select [CUT-OFF Frequency] in [SPEAKER] menu.

#### 60, 80, 100, 120 (Hz)

Select the cut-off frequency.



## Video setup menu

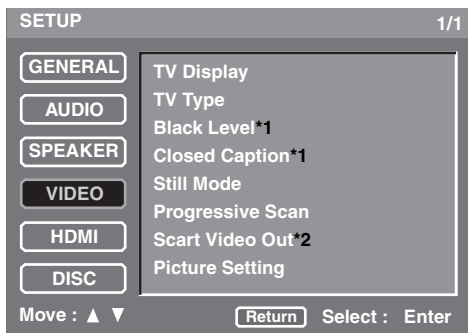

\*1: [Black Level] and [Closed Caption] are only for U.S.A. and Canada models.

\*2: [Scart Video Out] is only for U.K. and Europe models.

### Setting the TV display

Set the aspect ratio of this unit to match your TV. The format you select must be available on the disc.

- Select [TV Display] in [VIDEO] menu.

#### 4:3 Pan Scan

Select this if the aspect ratio of your TV is 4:3. In this setting, both sides of the picture to be trimmed or formatted to fit your TV screen.

#### 4:3 Letter Box

Select this if the aspect ratio of your TV is 4:3. In this setting, a wide picture with black bands on the upper and lower portions of the TV screen are displayed.

#### 16:9

Select this if you have a widescreen TV.

#### ■ The relationship between the setting of this unit and the TV display

When the aspect ratio of your TV is 16:9 (widescreen):

Setting	Playback disc	TV display	
16:9	16:9		
	4:3		*1

When the aspect ratio of your TV is 4:3:

Setting	Playback disc	TV display	
4:3 Pan Scan	16:9		*2
	4:3		
4:3 Letter Box	16:9		
	4:3		

\*1: The side of the picture may be stretched depending on the TV. In this case, check the screen size and aspect ratio of your TV.

\*2: If the disc is not assigned to play back with panscan, it is played with letterbox.

### Setting the TV type

This menu contains the options for selecting the color system that matches your TV. For details, see “Step 3: Setting a TV type” on page 14.

### Selecting the black level (U.S.A. and Canada models only)

If you set the [TV Type] to [NTSC] (see “Step 3: Setting a TV type” on page 14), set this setting shift to [On] to improve the color contrast during playback.

- Select [Black Level] in [VIDEO] menu.

#### On

Select this to enhance the black level.

#### Off

Select this for the standard black level setting.

#### Notes

- This function is only available for interlace output.
- This setting has no effect if the [TV Type] is set to [PAL] (see “Step 3: Setting a TV type” on page 14).

## Selecting the closed caption (U.S.A. and Canada models only)

Closed captions are data hidden in the video signals of specific discs, and are invisible without the use of a special decoder. The difference between subtitles and captions is that subtitles are intended for hearing persons and captions are for the hearing impaired. Subtitles rarely show all of the audio. For example, captions show sound effects (e.g., “phone ringing” and “footsteps”), while subtitles do not. Before you select this setting, please ensure that the disc contains closed caption information and your TV set also supports this function.

- Select [Closed Caption] in [VIDEO] menu.

### **On**

Select this to enable the closed caption function.

### **Off**

Select this to disable the closed caption function.

### **Notes**

- This function is only available for CVBS output.
- Even if this setting is set to [On], the closed caption function is not available when this unit is connected via the HDMI jack and the HDMI mode is set to on.

## Setting the still mode

You can select the still picture quality.

- Select [Still Mode] in [VIDEO] menu.

### **Field**

Select this for the standard still mode setting. This setting is suitable for playback of quick motion scenes.

### **Frame**

Select this if the picture is unstable when you select [Field].

## Selecting the progressive scan function

This function is only available if you have connected this unit to a progressive scan TV through the component video jacks (see “Component video jacks <D>” on page 12). This function is enable you to enjoy accurate color reproduction and high quality images. This unit features DCDi circuit.

- Select [Progressive Scan] in [VIDEO] menu.

### **On**

Select this to enable the progressive scan function.

The confirmation screen appears if you select this.

In this case, select [Yes] to set to [On], and then press

**ENTER**.

### **Off**

Select this to disable the progressive scan function.



The P.SCAN indicator on the front panel display lights up during progressive playback.

### **Notes on activating progressive scan:**

- In progressive mode, 4:3 aspect images are stretched horizontally on the widescreen TV. Change the aspect ratio settings of your TV if you want to watch the original aspect ratio images without distortion. You can also change the aspect ratio settings in [Wide Screen Format] menu (see “Selecting the wide screen format” on page 34).
- Ensure that your TV is equipped with progressive scan.
- Connect using a component video cable.

CONSUMERS SHOULD NOTE THAT NOT ALL HIGH DEFINITION TELEVISION SETS ARE FULLY COMPATIBLE WITH THIS PRODUCT AND MAY CAUSE ARTIFACTS TO BE DISPLAYED IN THE PICTURE. IN CASE OF 525 OR 625 PROGRESSIVE SCAN PICTURE PROBLEMS, IT IS RECOMMENDED THAT THE USER SWITCH THE CONNECTION TO THE “STANDARD DEFINITION” OUTPUT. IF THERE ARE QUESTIONS REGARDING OUR VIDEO MONITOR COMPATIBILITY WITH THIS MODEL 525P AND 625P DVD PLAYER, PLEASE CONTACT OUR CUSTOMER SERVICE CENTER.

This unit is compatible with the complete line of YAMAHA products, including the projectors DPX-1300, DPX-830 and the plasma monitor PDM-4220.

## Switching the SCART video out (U.K. and Europe models only)

Select this setting to toggle the video signal output from the AV terminal between CVBS (composite video) and RGB.

- Select [Scart Video Out] in [VIDEO] menu.

### CVBS

Select this to output composite video signals.

### RGB

Select this to output RGB video signals.

## Adjusting picture settings

This unit comes with 10 sets of picture color settings that you can define yourself.

- Select [Picture Setting] in [VIDEO] menu.

### Brightness

Set this to adjust the overall brightness of the image.

Control range: **0 to +6**

### Contrast

Set this to adjust the bright areas (white level) in the image.

Control range: **-6 to +6**

### Hue

Set this to adjust the hue or phase of the image.

Control range: **-6 to +6**

### Sharpness Mid

Set this to adjust the sharpness of the image for the intermediate frequencies.

Control range: **-6 to +6**

### Sharpness High

Set this to adjust the sharpness of the image for the high frequencies.

Control range: **-6 to +6**

### DNR

Set this to reduce video noise.

Control range: **0 to +6**

### Gamma

Set this to adjust the intensity of the picture non-linearly.

Control range: **-6 to +6**

### Chroma level

Set this to adjust the density of the color.

Control range: **-6 to +6**

### Chroma delay

Set this to adjust the advance delay of the chroma signal for a perfectly clear picture.

Control range: **-2 to +2**

### True Life

Set this to produce more dynamic picture by increasing the picture contrast and the color intensity.

Control range: **0 to +6**

### Notes

- For U.S.A. and Canada models, all picture settings are not available for CVBS output.
- The [Hue] setting is not available for the interlace output at the VIDEO OUT (COMPONENT) jacks.
- [Sharpness Mid], [Sharpness High], [Gamma] and [Chroma delay] settings are not available for HDMI output.
- The [True Life] settings is only available for progressive scan and HDMI output.

## HDMI setup menu

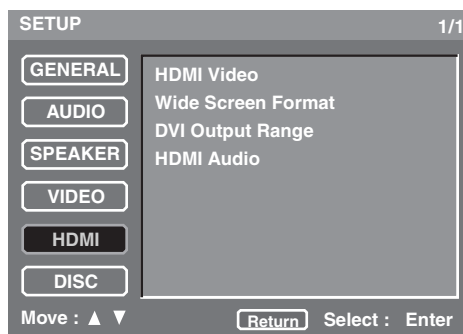

## Setting the HDMI video

You can adjust the resolution depending on the monitor you are using. This function is only available when this unit is connected to an HDMI-compatible component via the HDMI jack.

- Select [HDMI Video] in [HDMI] menu.

**480P/576P**

Select this for 480/576 progressive-scan video.

**720P**

Select this for 720 progressive-scan video.

**1080I**

Select this for 1080 interlace video.

**1080P**

Select this for 1080 progressive-scan video.

**Auto**

Select this to set this unit to the best resolution setting automatically based on your monitor.

**Notes**

- When [TV Type] is set to [NTSC] or [PAL], video signals with 480P or 576P are output accordingly.
- While HDMI video signals are being output, component video is muted.
- For settings other than [Auto], be sure that the selected resolution is supported by the HDMI compatible monitor you are using.  
If the selected resolution is not supported, this setting is automatically switched to the most appropriate resolution.
- When you select [1080P] and use an HDMI cable longer than 5m, the picture quality may decrease.



Refer to the manual supplied with your monitor to select the appropriate aspect ratio.

---

**Selecting the wide screen format**

Set the aspect ratio of the projected images on the screen. This function is only available for progressive scan and HDMI output.

- Select [Wide Screen Format] in [HDMI] menu.

**NL Stretch**

Select this to display of 4:3 image on the 16:9 screen with non-linear stretching. (The center position of the screen is stretched less than the side.)

**Pillar Box**

Select this to display 4:3 image on the 16:9 screen without stretching.

**Off**

Select this to make no aspect ratio adjustment.

---

**Selecting the DVI output range**

You can select the DVI output range to match the connected component. This function is only available when this unit is connected to an DVI-D-compatible component via the HDMI jack.

- Select [DVI Output Range] in [HDMI] menu.

**Standard**

Select this if you cannot see the correct image when you select [Enhanced].

**Enhanced**

Select this if black and white in the image is not distinct.

## Setting the HDMI audio

Set the HDMI audio output to match the connected component. This function is only available when this unit is connected to an HDMI-compatible component via the HDMI jack.

For details about the relationship between the audio format and the setting, see “HDMI Audio output table” on page 41.

- Select [HDMI Audio] in [HDMI] menu.

### Auto

Select this to set this unit to the best setting automatically based on the component you have connected via the HDMI jack.

### PCM

Select this to output the decoded multi-channel or 2ch linear PCM audio signals via the HDMI jack.

### Off

Select this to turn off the HDMI audio output.

### Notes

- SA-CD signals cannot be output using HDMI.
- When [HDMI Audio] is set to [Auto] or [PCM], digital output signals are muted.

## DISC setup menu

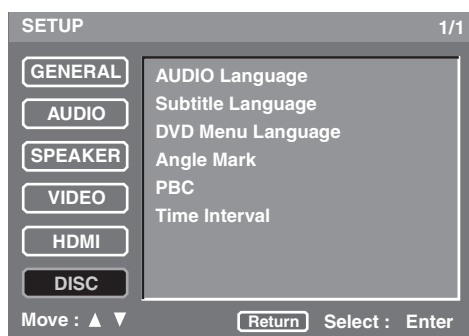

## Selecting the default audio/subtitle/DVD menu language

These menus contain various language options for the audio, subtitles and disc menus recorded on the DVD. For details, see “Setting the audio, subtitle and disc menu languages” on page 15.

## Selecting an angle mark display

You can switch an angle mark display on or off when sequences recorded from different camera angles are played back.

- Select [Angle Mark] in [DISC] menu.

### On

Select this if you want to display an angle mark. An angle mark is displayed continuously.

### Off

Select this if you do not want to display an angle mark. An angle mark appears for five seconds, and then disappears.

## Selecting the PBC (playback control) function

You can set playback control (PBC) to on or off. This function is available only on Video CD 2.0 with the playback control (PBC) feature.

- Select [PBC] in [DISC] menu.

### On

Select this to display a disc menu.

### Off

Select this not to display a disc menu.



You can also use the MENU button on the remote control to turn on or off the playback control (PBC) function (see “Using the Video CD playback control (PBC) menu (VCD/SVCD)” on page 19).

## Setting the duration for a slide show

You can set the duration that the slides for JPEG files are displayed.

- Select [Time Interval] in [DISC] menu.

### 2 sec to 10 sec

(Control step: 1 second)

### Note

This setting may not work correctly depending on file sizes.

# LANGUAGE CODE LIST

Abkhazian	1112	Fiji	1620	Lingala	2224	Singhalese	2919
Afar	1111	Finnish	1619	Lithuanian	2230	Slovak	2921
Afrikaans	1116	French	1628	Macedonian	2321	Slovenian	2922
Albanian	2927	Frisian	1635	Malagasy	2317	Somali	2925
Amharic	1123	Galician	1722	Malay	2329	Spanish	1529
Arabic	1128	Georgian	2111	Malayalam	2322	Sundanese	2931
Armenian	1835	German	1415	Maltese	2330	Swahili	2933
Assamese	1129	Greek	1522	Maori	2319	Swedish	2932
Aymara	1135	Greenlandic	2122	Marathi	2328	Tagalog	3022
Azerbaijani	1136	Guarani	1724	Moldavian	2325	Tajik	3017
Bashkir	1211	Gujarati	1731	Mongolian	2324	Tamil	3011
Basque	1531	Hausa	1811	Nauru	2411	Tatar	3030
Bengali; Bangla	1224	Hebrew	1933	Nepali	2415	Telugu	3015
Bhutani	1436	Hindi	1819	Norwegian	2425	Thai	3018
Bihari	1218	Hungarian	1831	Oriya	2528	Tibetan	1225
Breton	1228	Icelandic	1929	Panjabi	2611	Tigrinya	3019
Bulgarian	1217	Indonesian	1924	Pashto, Pushto	2629	Tonga	3025
Burmese	2335	Interlingua	1911	Persian	1611	Turkish	3028
Byelorussian	1215	Irish	1711	Polish	2622	Turkmen	3021
Cambodian	2123	Italian	1930	Portuguese	2630	Twi	3033
Catalan	6765	Japanese	2011	Quechua	2731	Ukrainian	3121
Chinese	3618	Javanese	2033	Raeto-Romance	2823	Urdu	3128
Corsican	1325	Kannada	2124	Romanian	2825	Uzbek	3136
Croatian	1828	Kashmiri	2129	Russian	2831	Vietnamese	3219
Czech	1329	Kazakh	2121	Samoan	2923	Volapük	3225
Danish	1411	Kirghiz	2135	Sanskrit	2911	Welsh	1335
Dutch	2422	Korean	2125	Scots Gaelic	1714	Wolof	3325
English	1524	Kurdish	2131	Serbian	2928	Xhosa	3418
Esperanto	1525	Laothian	2225	Serbo-Croatian	2918	Yiddish	2019
Estonian	1530	Latin	2211	Shona	2924	Yoruba	3525
Faroese	1625	Latvian, Lettish	2232	Sindhi	2914	Zulu	3631

# TROUBLESHOOTING

Refer to the table below when this unit does not function properly. If the problem you are experiencing is not listed below or if the instruction below does not help, turn off this unit, disconnect the power cable, and contact the nearest authorized YAMAHA dealer or service center.

Problem	Solution	See page
<b>No power</b>	Connect the AC power cable properly.	12
	Press POWER switch on the front panel to the ON position to turn on the power of this unit, and then press STANDBY/ON on the front panel or POWER ( I ) on the remote control to turn on this unit.	13
<b>No picture</b>	Refer to the manual supplied with your TV for correct Video In channel selection. Change the TV channel until you see the DVD screen.	–
	Turn on your TV.	–
	If [Progressive Scan] is set to [On], check that you have connected this unit to a progressive scan TV through the component video jacks. Otherwise, follow the steps below to turn off the progressive scan; 1. Press $\triangle$ on the front panel to open the disc tray. 2. Press CLEAR on the remote control. 3. Press “2580” using the numeric buttons (0-9) on the remote control. 4. Press AUDIO on the remote control.	32
	If [HDMI Video] is set to other than [Auto], check that the resolution is supported by the HDMI-compatible monitor you have connected. Otherwise, follow the steps below to change the setting to [Auto]; 1. Press $\square$ twice on the front panel or STOP ( ■ ) twice on the remote control to stop playback. 2. Press and hold $\square$ and $\triangleright$ on the front panel at the same time for three seconds.	33
	If the HDMI indicator flashes orange, check that you have connected this unit to an HDCP-compatible component.	12
	Check that the video signal output setting matches the video connection.	33
<b>Completely distorted picture or black/white picture</b>	Check that the disc is compatible with this unit.	3
	Check that the TV type of this unit is set to match that of the disc and your TV. If you set the TV type improperly, follow the steps below to return to the default setting; 1. Press $\triangle$ on the front panel to open the disc tray. 2. Press CLEAR on the remote control. 3. Press “2580” using the numeric buttons (0-9) on the remote control. 4. Press AUDIO on the remote control.	14
	Check the video connection.	11
<b>The screen size looks unnatural, or the caption is displayed only partially on the TV monitor or is not displayed at all</b>	Check that the TV setting of this unit matches the screen size of your TV.	31
	Change the screen size and the aspect ratio of your TV.	–

Problem	Solution	See page
<b>No sound or distorted sound</b>	Adjust the volume.	–
	Check that the speakers are connected properly.	–
	Adjust the volume level in the setup menu.	30
<b>No audio at digital output</b>	Check the digital connections.	11
	If you are playing a DTS source, check that your receiver can decode DTS and [Digital Out] is set to [All].	28
	If you are playing an MPEG-2 source, check that your receiver can decode MPEG-2. Otherwise, make sure that [Digital Out] is set to [PCM].	28
	Check that the audio format of the selected audio language matches your receiver capabilities.	–
<b>No audio at HDMI output</b>	Make sure that [HDMI Audio] is set to [Auto] or [PCM].	35
	No audio signals via the HDMI jack are output if the DVI-D component is connected to this unit using the HDMI-DVI converter cable. To output audio signals via the HDMI jack, connect an HDMI component to this unit.	12
<b>Disc does not play</b>	The CD-R/RW, DVD+R/RW and DVD-R/RW must be finalized.	–
	Check that the disc label is facing up.	16
	Check that the disc is defective by trying another disc.	–
	If you have recorded a JPEG, MP3 or WMA disc yourself, check that your disc contains at least ten JPEG picture files or five MP3/WMA music tracks.	–
	Check the region code.	3
<b>Picture freezes momentarily during playback</b>	Check the disc for fingerprints/scratches and clean it with a soft cloth wiping from the center to the edge.	4
<b>This unit does not respond to the remote control</b>	Aim the remote control directly at the remote control sensor on the front panel.	13
	Reduce the distance of the remote control from this unit.	13
	Replace the batteries in the remote control.	13
	Reinsert the batteries with their polarities (+/- signs) as indicated.	13
<b>Buttons do not work</b>	Disconnect the power cable from the AC outlet for a few minutes. Reconnect the power cable and try to operate again as usual.	–
<b>This unit does not respond to some operating commands during playback</b>	Operations may not be permitted by the disc. Refer to the instructions of the disc jacket.	–
<b>Menu items cannot be selected</b>	Depending on the connection status or disc availability, some menu items cannot be selected.	–
<b>No sound during DivX movies playback</b>	The audio code may not be supported by this unit.	–



## ■ Aspect ratio

Horizontal and vertical ratio of a displayed image. The horizontal vs. vertical ratio of conventional TV is 4:3, and that of wide-screens is 16:9.

## ■ Bit

Short for binary digit. Represents the smallest unit of information manipulated on a computer. In audio systems, the bit size determines resolution to digitize analog signals.

The larger the bit size, the larger the dynamic range (the ratio of maximum and minimum frequency level) and the finer the sounds. Generally, an audio CD is 16 bit and DVD audio is 24 bit.

## ■ Bit rate

The amount of data used to hold a given length of music; measured in kilobits per second, or kbps. Also, the speed at which you record. Generally, the higher the bit rate, or recording speed, the better the sound quality. However, higher bit rates use more space on a disc.

## ■ Component video jacks

Jacks for inputting or outputting a component video signal. Component video signal consists of three lines, the luminance signal (Y) and two color difference signals (PB/CB, PR/CR), which enable to provide high-quality video.

## ■ DivX

DivX is a popular media technology created by DivX, inc. DivX media files contain highly compressed video with high visual quality that maintains a relatively small file size. DivX files can also include advanced media features like menus, subtitles, and alternate audio tracks. Many DivX media files are available for download online, and you can create your own using your personal content and easy-to-use tools from DivX.com.

## ■ Dolby Digital

Digital surround sound system which is developed by Dolby Laboratories provides completely independent multi-channel audio. With 3 front channels (left, center, and right) and 2 surround stereo channels, Dolby Digital provides five full-range audio channels. With an additional channel especially for bass effects (called LFE, or low frequency effect), the system has a total of 5.1-channels (LFE is counted as 0.1 channel). By using 2-channel stereo for the surround speakers, more accurate moving sound effects and surround sound environment are possible than with Dolby Surround.

## ■ DTS (Digital Theater Systems)

Digital surround sound system developed by Digital Theater Systems, Inc., which provides 5.1 channel audio (max). With an abundance of audio data, it is able to provide authentic-sounding effects.

## ■ DVD-Audio

It has developed for the sole purpose of creating high quality pure sound with Linear PCM and Packed PCM (lossless coding) in up to six audio-channels. Sampling frequencies of 192 kHz/24 bits are supported.

## ■ HDMI

HDMI (High-Definition Multimedia Interface) is the first industry-supported, uncompressed, all-digital A/V (audio/video) interface. Providing an interface between any A/V source (such as a set-top box or A/V receiver) and an audio/video monitor (such as a digital television – DTV), HDMI supports standard, enhanced or high-definition video as well as multi-channel digital audio using a single cable.

HDMI transmits all ATSC HDTV standards and supports 8-channel digital audio, with bandwidth to spare to accommodate future enhancements and requirements.

### ■ Interlace

The most common type of scanning used in televisions. It divides a screen into even and odd numbered fields for scanning, and then builds an image by combining them into one image (frame).

### ■ JPEG (Joint Photographic Expert Group)

A standardized image compression system proposed by the Joint Photographic Expert Group. It can reduce image data sizes to 1 to 10% of their original sizes, and works on digital photographs effectively.

### ■ MP3 (MPEG Audio Layer-3)

An audio file compression technology. It can reduce audio data sizes to about 10% of their original sizes while maintaining CD-level audio quality.

### ■ MPEG (Moving Pictures Experts Group)

International standard for digital video and audio compression generated by ISO (International Organization for Standardization) and IEC (International Electrotechnical Commission).

Includes MPEG-1, MPEG-2, and MPEG-3. MPEG-1 offers VHS level video quality and is often used on video CDs. MPEG-2 offers S-VHS level video quality and is often used on DVDs.

### ■ Parental control

Limits Disc play according to the age of the users or the limitation level in each country. The limitation varies from disc to disc; when it is activated, playback will be prohibited if the software's level is higher than the user-set level.

### ■ Playback control (PBC)

An on-screen menu recorded on a Video CD or SVCD that enables interactive playback and searching.

### ■ Progressive Scan

A method of displaying all scanning lines in a frame at once, reducing flicker noticeable on a larger screen and creating a sharp and smooth image.

### ■ Region code

Many DVD discs include a region code so that the copyright owner can control DVD software distribution only to regions where they are ready to distribute. There are six regions codes, which restrict a DVD player to playing a DVD disc with the same region code.

### ■ S-video jack

A jack for inputting or outputting an S-video signal. S-video signal consists of two lines, the luminance signal (Y) and color signal (C), which enable to provide high-quality video during playback or recording.

### ■ Super Audio CD

Audio format based upon the current CD standards but includes a greater amount of information that provides higher quality sound. There are three types of discs: single layer, dual layer and hybrid discs. The hybrid disc can be played on existing CD players as well as Super Audio CD players since it contains both standard audio CD and Super Audio CD information.

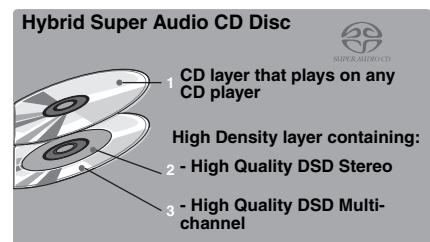
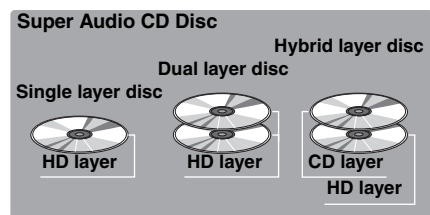

## ■ HDMI Audio output table

Audio format		Analog output setting	HDMI Audio		
			Auto*1	PCM	Off
DVD-Video	Dolby Digital	Multi channel	Dolby Digital	PCM multi*2	Off
		Stereo		PCM 2ch	
	DTS	Multi channel	DTS	PCM multi*2	
		Stereo		PCM 2ch	
	MPEG	Multi channel	MPEG	PCM multi*2	
		Stereo		PCM 2ch	
	PCM 2ch*4	Multi channel/Stereo	PCM 2ch	PCM 2ch	
	DVD-Audio	Multi	Multi channel	PCM (PPCM) multi*2,3	
Stereo			PCM (PPCM) 2ch*3	PCM (PPCM) 2ch*3	
2ch*4		Multi channel/Stereo	PCM (PPCM) 2ch	PCM (PPCM) 2ch	
CD/MP3/WMA/DivX	2ch	Multi channel/Stereo	PCM 2ch	PCM 2ch	
DTS-CD	Multi	Multi channel	DTS	PCM multi*2	
		Stereo		PCM 2ch	
	2ch	Multi channel/Stereo		PCM 2ch	
VCD	2ch	Multi channel/Stereo	PCM 2ch	PCM 2ch	
SVCD	Multi	Multi channel	MPEG	PCM multi*2	
		Stereo		PCM 2ch	
	2ch	Multi channel/Stereo		PCM 2ch	
SA-CD	Multi/2ch	Multi channel/Stereo	–	–	

\*1: If the connected HDMI component does not support bitstream signals (Dolby Digital, DTS, and MPEG), the audio output is automatically changed from bitstream signals to PCM signals.

\*2: If the HDMI component does not support multi-channel audio signals, the audio output is automatically changed from PCM multi-channel signals to PCM stereo signals and 48 kHz/16 bits signals or less.

\*3: If the audio source is prohibited downmixing, the front L/R channel audio and 48 kHz/16 bits signals or less are output instead of downmixed stereo.

\*4: If the connected component does not support more than 48 kHz, the audio output is automatically changed to 48 kHz/16 bits signals or less.

# SPECIFICATIONS

## PLAYBACK SYSTEM

- DVD-Video
- DVD-Audio
- DVD-R, DVD-RW
- DVD+R, DVD+RW, DVD+R DL
- Video CD, SVCD
- SA-CD multi-channel and SA-CD stereo
- CD
- PICTURE CD
- CD-R, CD-RW

## VIDEO PERFORMANCE

- Video (CVBS) output ..... 1 Vpp into 75 ohm
- S-video output ..... Y: 1 Vpp into 75 ohm  
C: 0.3 Vpp into 75 ohm
- Component video output ..... Y: 1 Vpp into 75 ohm  
Pb/Cb, Pr/Cr: 0.7 Vpp into 75 ohm
- RGB (SCART) output  
(U.K. and Europe models only) ..... 0.7 Vpp into 75 ohm
- Black level shift  
(U.S.A. models only) ..... On/Off

## AUDIO FORMAT

- Digital
  - Dolby Digital / DTS / MPEG ..... Compressed Digital
  - PCM ..... 16, 20, 24 bits / fs 44.1, 48, 88.2, 96 kHz
  - MP3 (ISO 9660)  
..... 32–320 kbps / fs 16, 22.05, 24, 32, 44.1, 48 kHz
  - WMA ..... 64–320 kbps, mono, stereo
- Full decoding of Dolby Digital and DTS multi-channel sound
- Analog stereo sound
- Dolby surround compatible downmix from Dolby Digital multi-channel sound

## AUDIO PERFORMANCE

- DA Converter ..... 24 bit, 192 kHz
- Signal-Noise (1 kHz) ..... 120 dB
- Dynamic range (1 kHz) ..... 106 dB
- DVD ..... fs 96 kHz, 2 Hz–44 kHz  
fs 48 kHz, 2 Hz–22 kHz
- SVCD ..... fs 48 kHz, 2 Hz–22 kHz  
fs 44.1 kHz, 2 Hz–20 kHz
- CD/VCD ..... fs 44.1 kHz, 2 Hz–20 kHz
- Distortion and Noise (1 kHz) ..... 0.001%

## TV STANDARD

- Number of lines ..... PAL: 625, NTSC: 525
- Vertical frequency ..... PAL: 50 Hz, NTSC: 60 Hz
- Playback ..... Multistandard (PAL/NTSC)

## CONNECTIONS

- Video output ..... 1 (Cinch: yellow)
- S-video output ..... 1 (Mini DIN, 4 pins)
- Component video output
  - Y output ..... 1 (Cinch: green)
  - PB/CB output ..... 1 (Cinch: blue)
  - PR/CR output ..... 1 (Cinch: red)
- SCART (U.K. and Europe models) ..... 1 (Euroconnector)
- Digital output
  - Coaxial ..... 1 (Cinch: orange)
  - Optical ..... 1 (IEC 60958 for CDDA/LPCM,  
IEC 61937 for MPEG 1/2, Dolby Digital, DTS)
  - HDMI ..... 1 (Type A)
- 2 channel analog output (L+R) ..... 1 pair (Cinch: white/red)
- 6 channel analog output
  - Audio Front L/R ..... 1 pair (Cinch: white/red)
  - Audio Surround L/R ..... 1 pair (Cinch: white/red)
  - Audio Center ..... 1 (Cinch: black)
  - Audio Subwoofer ..... 1 (Cinch: black)

## CABINET

- Dimensions (W x D x H) ..... 435 x 308.5 x 107 mm
- Weight ..... Approx. 6.3 kg

## POWER SUPPLY

- Power inlet
  - U.S.A. and Canada models ..... AC 120 V, 60 Hz
  - Australia model ..... AC 240 V, 50 Hz
  - U.K. and Europe models ..... AC 220-240 V, 50/60 Hz
  - China model ..... AC 220 V, 50 Hz
- Power consumption ..... Approx. 30 W
- Power consumption (standby) ..... < 0.5 W

## LASER

Type	Semiconductor laser GaAlAs
Wave length	650 nm (DVD) 790 nm (VCD/CD)
Output Power	1.45 mW (DVD) 1.13 mW (VCD/CD)
Beam divergence	60 degrees

Specifications are subject to change without prior notice.

## Free Manuals Download Website

<http://myh66.com>

<http://usermanuals.us>

<http://www.somanuals.com>

<http://www.4manuals.cc>

<http://www.manual-lib.com>

<http://www.404manual.com>

<http://www.luxmanual.com>

<http://aubethermostatmanual.com>

Golf course search by state

<http://golfingnear.com>

Email search by domain

<http://emailbydomain.com>

Auto manuals search

<http://auto.somanuals.com>

TV manuals search

<http://tv.somanuals.com>