



DVD PLAYER

---

# DVD-S30

*CinemaStation*

OWNER'S MANUAL

# CAUTION: READ THIS BEFORE OPERATING YOUR UNIT.

- 1 To assure the finest performance, please read this manual carefully. Keep it in a safe place for future reference.
- 2 Install this sound system in a well ventilated, cool, dry, clean place with at least 10 cm on the top, 10 cm on the left and right, and 10 cm at the back of DVD-S30 — away from direct sunlight, heat sources, vibration, dust, moisture, and/or cold.
- 3 Locate this unit away from other electrical appliances, motors, or transformers to avoid humming sounds.
- 4 Do not expose this unit to sudden temperature changes from cold to hot, and do not locate this unit in an environment with high humidity (i.e. a room with a humidifier) to prevent condensation inside this unit, which may cause an electrical shock, fire, damage to this unit, and/or personal injury.
- 5 Avoid installing this unit where foreign object may fall onto this unit and/or this unit may be exposed to liquid dripping or splashing. On the top of this unit, do not place:
  - Other components, as they may cause damage and/or discoloration on the surface of this unit.
  - Burning objects (i.e. candles), as they may cause fire, damage to this unit, and/or personal injury.
  - Containers with liquid in them, as they may fall and liquid may cause electrical shock to the user and/or damage to this unit.
- 6 Do not cover this unit with a newspaper, tablecloth, curtain, etc. in order not to obstruct heat radiation. If the temperature inside this unit rises, it may cause fire, damage to this unit, and/or personal injury.
- 7 Do not plug in this unit to a wall outlet until all connections are complete.
- 8 Do not operate this unit upside-down. It may overheat, possibly causing damage.
- 9 Do not use force on switches, knobs and/or cords.
- 10 When disconnecting the power cable from the wall outlet, grasp the plug; do not pull the cable.
- 11 Do not clean this unit with chemical solvents; this might damage the finish. Use a clean, dry cloth.
- 12 Only voltage specified on this unit must be used. Using this unit with a higher voltage than specified is dangerous and may cause fire, damage to this unit, and/or personal injury. YAMAHA will not be held responsible for any damage resulting from use of this unit with a voltage other than specified.
- 13 Do not attempt to modify or fix this unit. Contact qualified YAMAHA service personnel when any service is needed. The cabinet should never be opened for any reasons.
- 14 When not planning to use this unit for long periods of time (i.e. vacation), disconnect the AC power plug from the wall outlet.
- 15 Be sure to read the “Troubleshooting” section on common operating errors before concluding that this unit is faulty.
- 16 Before moving this unit, press STANDBY/ON to set this unit in standby mode, and disconnect the AC power plug from the wall outlet.
- 17 Condensation will form when the surrounding temperature changes suddenly. Disconnect the power cable from the outlet, then leave the unit alone.
- 18 When using the unit for a long time, the unit may become warm. Turn the power off, then leave the unit alone for cooling.
- 19 Install this unit near the AC outlet and where the AC power plug can be reached easily.

This unit is not disconnected from the AC power source as long as it is connected to the wall outlet, even if this unit itself is turned off. This state is called the standby mode. In this state, this unit is designed to consume a very small quantity of power.

## DANGER

When this unit is plugged to the wall outlet, do not place your eyes close to the opening of the disc tray and other openings to look into inside.

The laser component in this product is capable of emitting radiation exceeding the limit for Class 1.

## WARNING

TO REDUCE THE RISK OF FIRE OR ELECTRIC SHOCK, DO NOT EXPOSE THIS APPLIANCE TO RAIN OR MOISTURE.

## ■ For U.K. customers

If the socket outlets in the home are not suitable for the plug supplied with this appliance, it should be cut off and an appropriate 3 pin plug fitted. For details, refer to the instructions described below.

### Note

The plug severed from the mains lead must be destroyed, as a plug with bared flexible cord is hazardous if engaged in a live socket outlet.

## ■ Special Instructions for U.K. Model

### IMPORTANT

THE WIRES IN MAINS LEAD ARE COLOURED IN ACCORDANCE WITH THE FOLLOWING CODE:

Blue: NEUTRAL

Brown: LIVE

As the colours of the wires in the mains lead of this apparatus may not correspond with the coloured markings identifying the terminals in your plug, proceed as follows: The wire which is coloured BLUE must be connected to the terminal which is marked with the letter N or coloured BLACK. The wire which is coloured BROWN must be connected to the terminal which is marked with the letter L or coloured RED.

Making sure that neither core is connected to the earth terminal of the three pin plug.

**CAUTION**

Use of controls or adjustments or performance of procedures other than those specified herein may result in hazardous radiation exposure.

- The name plate is located on the bottom of the unit.

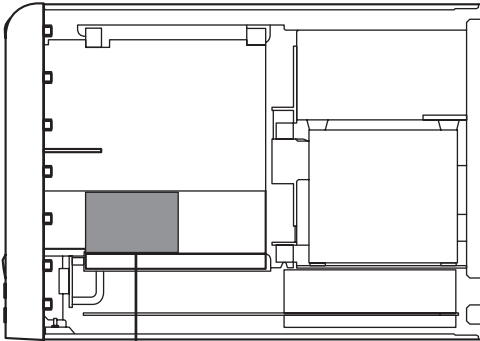

CAUTION - VISIBLE AND / OR INVISIBLE LASER RADIATION WHEN OPEN. AVOID EXPOSURE TO BEAM.
VARNING - SYNLLIG OCH / ELLER OSYNLLIG LASERSTRÅNING NÄR DENNA DEL ÄR ÖPPNAD. STRÅLEN ÄR FARLIG.
VARO! AVATTAESSA OLET ALLTINA NÄKYVÄLLE JA / TAI NÄKYMÄTÖMÄLLE LASERSÄTEILYLLE. ÄLÄ KATSO SÄTEESEEN.
VARNING - SYNLLIG OCH / ELLER OSYNLLIG LASERSTRÅLNING NÄR DENNA DEL ÄR ÖPPNAD. BETRakta EJ STRALEN.
VORSICHT! SICHTBARE UND / ODER UNSICHTBARE LASERSTRAHLUNG WENN ABDECKUNG GEÖFFNET. NICHT DEM STRAHL AUSSETZEN.

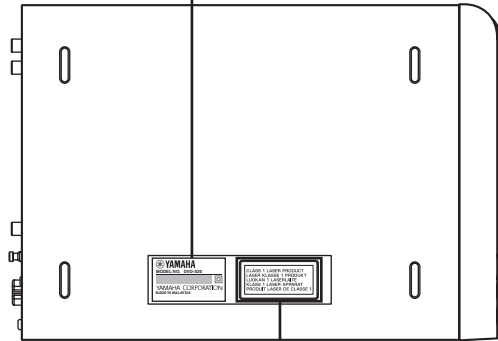









**CLASS 1 LASER PRODUCT  
 LASER KLASSE 1 PRODUKT  
 LUOKAN 1 LASERLAITE  
 KLASSE 1 LASER APPARAT  
 PRODUIT LASER DE CLASSE 1**

# NOTES ON DISCS

## About region codes

The region code (an ID number assigned to each market region) is set for normal DVD players and DVD video discs. The DVD-S30 supports the discs with the region codes shown below. For details, read the information on the disc jacket.

Destination	Region code of the DVD player	Playable discs
U.K. Europe		 
Australia		 
Korea Taiwan Asia		 

## Notes about discs

- This unit is designed for use with DVD video, Video CD, Super video CD, Audio CD, CD-R, CD-RW, DVD+RW, DVD+R, DVD-R, DVD-RW and DVD-RW (VR format).
- The DVD player cannot play a CD-R, CD-RW, DVD-R, DVD-RW, DVD+R or DVD+RW disc that has not been finalized. Finalizing is a process that prepares a disc for playback on a compatible device.
- This unit is not compatible with 8-cm discs.
- Only use discs from a reputable manufacturer. Some discs cannot be played back, depending on recording conditions and disc characteristics.
- Do not use discs with non-standard shapes or sizes.

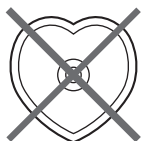

- Some DVD video or video CD discs may operate and function differently than noted in this manual. That is by manufacturer design and not a defect in this unit. For details read the information on the disc jacket.
- Some discs cannot be played depending on the recording conditions such as PC environment and application software. Failure can also result from disc characteristics and condition, like material quality, scratches or curvature.

## Handling of discs

- Do not touch the surface of the disc. Hold a disc by its edge and center hole.
- Do not leave a disc in the unit when you are not playing it.
- Do not write on the disc with a pencil or other marker.
- Do not stick tape, seals or other attachments to a disc, and do not bring into contact with glue.
- Do not use an adaptor or protective cover to prevent scratches.
- Do not use a disc whose surface can be printed with a commercially available label printer.
- Do not put a disc in a place with direct sunlight, high temperature, high humidity or a lot of dust.



- If a disc becomes dirty, wipe it with a clean, dry cloth from the center out to the edge. Do not use record cleaner or paint thinner.
- Do not use a commercially available lens cleaner.

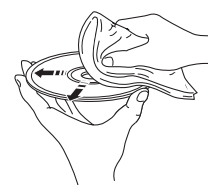

# CONTENTS

## PREPARATION

Supplied Parts .....	2
Controls and Functions .....	3
Front panel .....	3
Remote control .....	4
Connections .....	6
Using the Remote Control .....	7
Replacing the batteries .....	7

## OPERATION

Getting Started .....	8
Step 1: Turning on the power .....	8
Step 2: Setting the TV color system .....	8
Step 3: Setting the OSD language .....	9
Step 4: Setting the disc language (audio, subtitle, disc menu) .....	9
Supported Disc Types .....	10
Basic Playback Operations .....	11
Repeating Playback (Repeat Play) .....	12
To repeat between two points (A-B Repeat) .....	12
Specifying an elapsed time for playback (Time Search) .....	13
Time Search on DVD .....	13
Time Search on VCD/SVCD .....	13
Time Search on CD .....	14
Customizing Playback Order (Program Play) .....	14
Selecting Audio and Subtitle Languages .....	15
Zooming the Picture .....	15
Selecting a Viewing Angle .....	16
Operating the Disc Menu .....	16
To operate the DVD menu .....	16
To operate the Playback Control menu .....	16
Restricting Playback .....	17
Setting the Parental Control level .....	17
Locking discs .....	17
Changing the password .....	18
Playing MP3 or JPEG (Kodak) Picture Discs .....	18
Viewing JPEG (Kodak) pictures in thumbnail form .....	19
Setting the Remote Control Code .....	19
Changing Playback Settings on the TV (On-Screen Menu) .....	20
On-Screen menu items .....	20
Configuring the Various Parameters (Setup Menu) .....	21
Setup menu items .....	22

## ADDITIONAL INFORMATION

Troubleshooting .....	24
General .....	24
Remote control .....	24
Disc playback .....	25
Glossary .....	26
Copyright and Logo Marks .....	27
Language Codes .....	28
Remote Control Codes .....	29
Specifications .....	30

### ■ About this manual

- This manual provides information relevant only to the YAMAHA DVD player “DVD-S30”.
- In this manual, operations that can be performed using either the front panel buttons or remote control are explained using the remote control.
- ☞ indicates a tip for your operation. Notes contain important information about safety and operating instructions.
- This manual is printed prior to production. Design and specifications are subject to change in part as a result of improvements, etc. In case of differences between the manual and the product, the product has priority.

# PREPARATION

## Supplied Parts

This product consists of the following parts. Before connecting an amplifier or a TV to this product, make sure you received all of the following parts.

### DVD player (DVD-S30) x 1

#### Accessories

##### Remote control

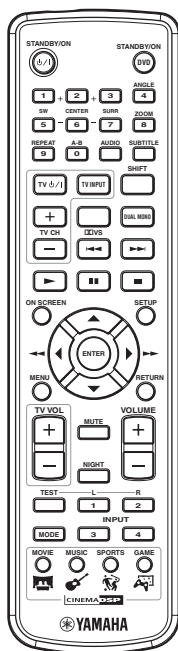

##### Battery x 2 (AA, R06, UM-3)

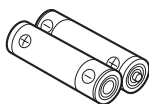

##### Optical cable (60 cm) x 1

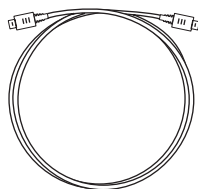

##### Video pin cable (1 m) x 1

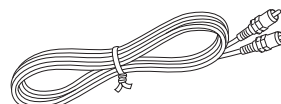

##### DVD player stand x 2



##### Owner's Manual (this manual)



You can place the DVD player vertically (STANDBY/ON becomes the top and ► becomes the bottom as the diagram below) using the supplied DVD player stands.

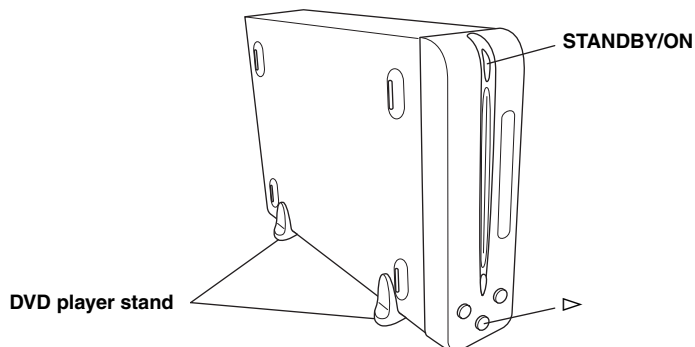

## Controls and Functions

### ■ Front panel

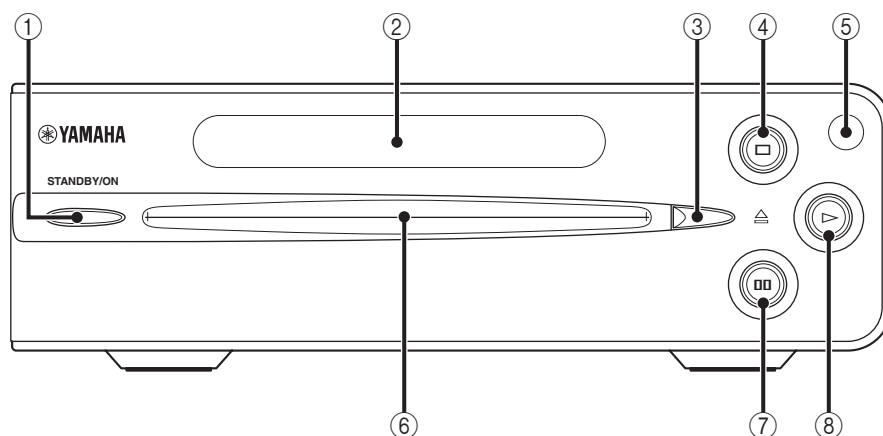

#### ① STANDBY/ON

Turn this unit on or set it to the standby mode.



When the unit is in the standby mode, the unit consumes a small amount of power.

#### ② Front panel display

Displays playback information or settings.

#### ③ △ (Eject)

Ejects a disc in the unit.

#### **Note**

Do not push the ejected disc when reloading it. To reload the ejected disc, press △ or ▷, or remove the disc from the disc loading slot fully, then insert it to the disc loading slot once again.

#### ④ □ (Stop)

Stops disc playback. (page 11)

#### ⑤ Remote control sensor

Receives signals from the remote control.

#### ⑥ Disc loading slot

Insert a disc to be played.

#### **Note**

Place the disc with the data side facing down. If the DVD player is placed vertically, place the disc with the data side facing left.

#### ⑦ ■■ (Pause)

Pauses disc playback. (page 11)

#### ⑧ ▷ (Play)

Starts disc playback. (page 11)

## Remote control

Read the following for the function of each button. The buttons shaded in the illustration below are used to control the YAMAHA AV amplifier “AVC-S30” (included if you purchase DVX-S30). For details on AVC-S30 operations, refer to the “AVX-S30 OWNER’S MANUAL”.

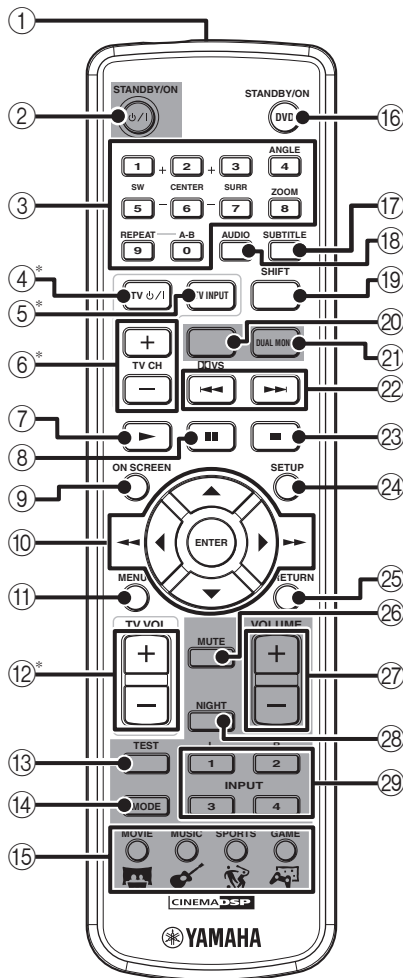

\* To control your TV with these buttons, you need to set the appropriate remote control code. (page 29)

### ① Infrared signal transmitter

Sends signals to the units.

### ② STANDBY/ON (0/1)

Turns the AVC-S30 on, or set it to the standby mode.

### ③ Number buttons (1 to 9, 0)

Input numerals to specify parameters such as track or chapter numbers.

### ④ TV 0/1 \*

Turns the TV on, or set it to the standby mode.

### ⑤ TV INPUT\*

Switches the TV inputs.

### ⑥ TV CH +/-\*

Switches the TV channels.

### ⑦ ► (Play)

Starts disc playback. (page 11)

### ⑧ ■■ (Pause)

Pauses disc playback. (page 11)

### ⑨ ON SCREEN

Displays the On-Screen Menu on the TV. (page 20)

### ⑩ ▲, ▼, ◀, ▶, ENTER

Operates the On-Screen Menu or specify various parameters.

Press ▲ to slow reverse and press ▼ to slow forward. (page 11)

### ◀◀, ▶▶ (Search)

Fast forwards/fast reverses disc playback with a specific speed. (page 11)

### ⑪ MENU

Displays the DVD menu on the TV. (page 16) While playing back a VCD, press this button to display or close the Playback Control menu. (page 16)

### ⑫ TV VOLUME +/-\*

Adjusts the TV volume level.

### ⑬ TEST

Outputs a test tone on the AVC-S30.

### ⑭ MODE

Switches between Dolby Pro Logic II modes on the AVC-S30.

### ⑮ CINEMA DSP buttons

Selects a CINEMA DSP program on the AVC-S30.

### ⑯ STANDBY/ON (DVD)

Turns the DVD-S30 on, or set it to the standby mode.



When the unit is in the standby mode, the unit consumes a small amount of power.

### ⑰ SUBTITLE

Selects the subtitle language of the DVD video. (page 15)



**18 AUDIO**

Selects the audio language of the DVD video or the audio channel setting of the video CD and super video CD. (page 15)

**19 SHIFT**

While holding down SHIFT, press a button below to enable the corresponding operation.

**SW +/-**: Adjusts the subwoofer channel volume on the AVC-S30.

**CENTER +/-**: Adjusts the center speaker channel volume on the AVC-S30.

**SURR +/-**: Adjusts the surround speaker channel volume on the AVC-S30.

**ANGLE**: Selects the disc viewing angle. (page 16)

**ZOOM**: Selects the zoom setting. (page 15)

**REPEAT**: Enables the Repeat Play mode. (page 12)

**A-B**: Enables the A-B Repeat mode. (page 12)

**20 DVS (Dolby Virtual Speaker)**

Turns on/off the DVS mode on the AVC-S30.

**21 DUAL MONO****(Taiwan model only)**

Switches audio outputs (main audio and sub audio) on the AVC-S30 when multiple audio signals are input into the AVC-S30.

**22 ◀◀, ▶▶ (Skip)**

Skips to the start of current track or next track. (page 11)  
Press and hold ◀◀ to fast reverse or ▶▶ to fast forward disc playback. (page 11)

**23 ■ (Stop)**

Stops disc playback. (page 11)

**24 SETUP**

Displays the Setup menu on the TV.

**25 RETURN**

Returns the disc menu to the previous screen. (page 16)

**26 MUTE**

Turns off the volume on the AVC-S30.

**27 VOLUME +/-**

Adjusts the overall volume level volume on the AVC-S30.

**28 NIGHT**

Turns on/off the Night Listening mode volume on the AVC-S30.

**29 INPUT buttons**

Select an input source volume on the AVC-S30.

**L/R buttons**

While a test tone is output volume on the AVC-S30, press L to set the orientation of the virtual surround speaker (L), and press R to set the orientation of the virtual surround speaker (R).

## Connections

This section explains how to connect the DVD-S30 to your TV or external AV amplifier (AVC-S30 etc.). For connections related to external AV amplifier, refer to the manual for it.

### Note

Connect the power cord of the DVD player or external components after connection of all cables are complete.

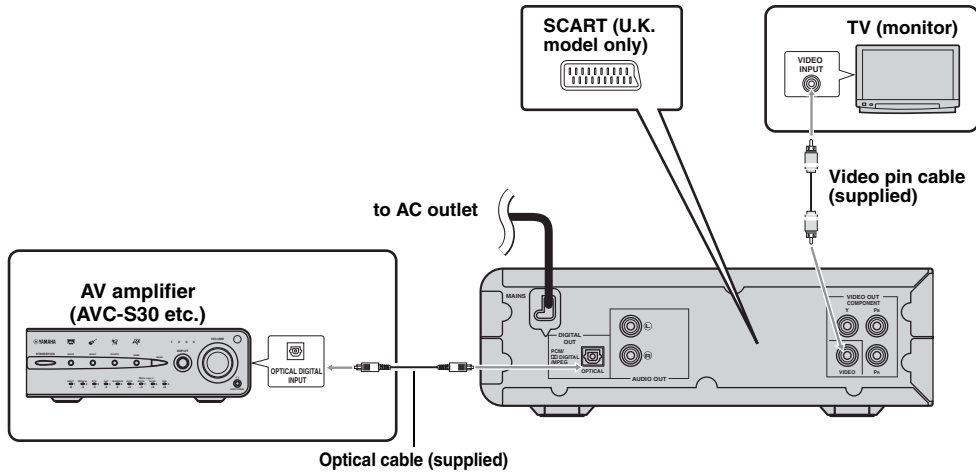

### Other video connections (to enjoy high quality pictures)

- To make component video connection instead of video connection using the supplied video pin cable, connect COMPONENT (Y, PB, PR) jacks of the DVD-S30 and component video input jacks of the TV using a commercially available component video cable.
- To make SCART connection (U.K model only) instead of video connection using the supplied video pin cable, connect SCART jack of the DVD-S30 and SCART input jack of the TV using a commercially available SCART cable.



COMPONENT jacks can output a progressive scan signal. To enjoy high quality DVD video with progressive scan mode, set "PROGRESSIVE" in the Setup menu to "ON" (page 23).

### Other audio connection

To make analog audio connection instead of digital connection using the optical cable, connect AUDIO OUT (L, R) jacks of the DVD-S30 and audio input jacks of the AV amplifier using a commercially available audio pin cable.

## Using the Remote Control

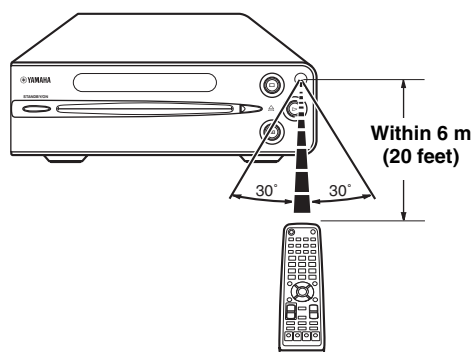

Use the remote control within 6 m (20 feet) of the DVD player and point it toward the remote control sensor.

### Notes

- Be careful not to spill liquid on the remote control.
- Be careful not to drop the remote control.
- Do not leave the remote control in the following places:
  - hot or humid places, such as near a heater or in a bathroom
  - extremely cold places
  - dusty places

## ■ Replacing the batteries

If the batteries grow old, the effective operation distance of the remote control decreases considerably. If this happens, replace the batteries with two new ones as soon as possible.

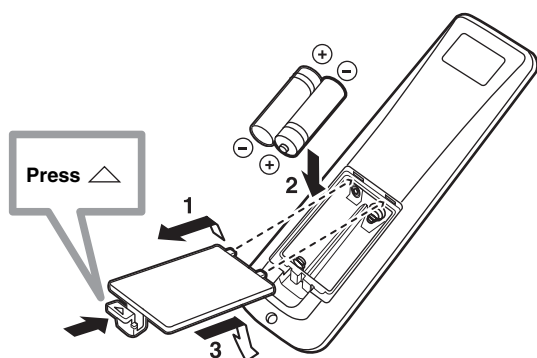

**1** Press the  $\triangle$  mark on the battery cover and slide off the cover.

**2** Insert two new batteries (AA, R06, UM-3) into the battery compartment.

Make sure you insert the batteries according to the polarity markings (+ and -).

**3** Close the battery cover.

### Notes

- Do not use an old battery together with new one.
- Do not use different types of batteries (for example, alkaline and manganese) together. Each type of battery has its own characteristics even if they are similar in shape.
- If the batteries run out, immediately remove them from the remote control to prevent an explosion or acid leak.
- Dispose of the batteries according to the regional regulations.
- If a battery starts leaking, dispose of it immediately. Be careful not to let leaking battery acid come into contact with your skin or clothing. Before inserting new batteries, wipe the compartment clean.
- Replace the batteries within two minutes to preserve the memory in the remote control.

# OPERATION

## Getting Started

Before starting playback operation, follow the procedure below to set up the DVD player settings.

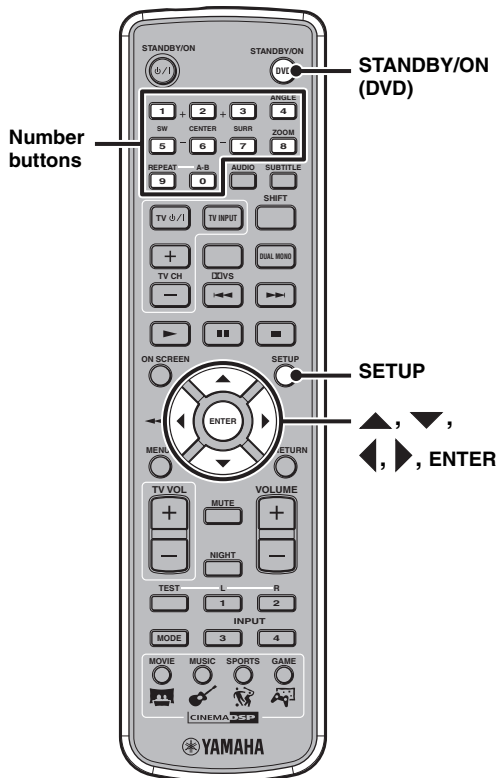

### ■ Step 2: Setting the TV color system

This unit is compatible with both NTSC and PAL. Select the color system that matches your TV. (The default setting is “PAL” for U.K. and Australia models and “MULTI” for Taiwan and Asia models)

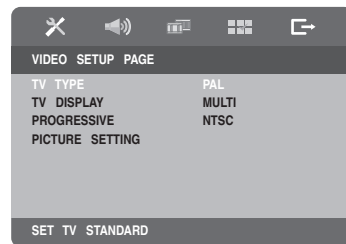

- 1 Press **SETUP** to display the Setup menu on the TV.
- 2 Press **◀** or **▶** to select “VIDEO SETUP PAGE”, press **▲** or **▼** to select “TV TYPE”, and then press **▶**.
- 3 Press **▲** or **▼** to select “PAL”, “MULTI” or “NTSC”, and then press **ENTER**.  
**PAL:**  
Select this if your TV employs PAL system.  
**MULTI:**  
Select this if your TV is compatible with both PAL and NTSC. The output format will be in accordance with the video signal of the disc.  
**NTSC:**  
Select this if your TV employs NTSC system.

### ■ Step 1: Turning on the power

- 1 Turn on the TV and AV amplifier (AVC-S30 etc.), and then press **STANDBY/ON (DVD)** to turn on the DVD player (DVD-S30).

The front panel display turns on.



This unit has the auto-sleep function which automatically switches to the standby mode if you do not operate the unit for about 30 minutes while playback is stopped.

- 2 Select the DVD input on the TV and AV amplifier (AVC-S30 etc.).

The default screen appears on the TV.

#### 4 Press ◀ or ▶ to select “OK”, and then press ENTER.

Repeat step 4 in the re-confirmation screen.



To return to the previous menu, press ◀. To close the Setup menu, press SETUP.

#### Notes

- When using a wide-screen TV, set “TV DISPLAY” in “VIDEO SETUP PAGE” to “16:9”. For details, refer to “TV DISPLAY” (page 23).
- Setting an incorrect TV color system distorts the picture on the TV and makes menu operations difficult. To switch the TV color system (NTSC and PAL) in such a case, press ▶ and then AUDIO while no disc is inserted (“NO DISC” appears on the front panel display).

### ■ Step 3: Setting the OSD language

You can select a language used for the on-screen display. (The default setting is “ENGLISH”.)



#### 1 Press SETUP to display the Setup menu on the TV.

#### 2 Press ◀ or ▶ to select “GENERAL SETUP PAGE”, press ▲ or ▼ to select “OSD LANGUAGE”, and then press ▶.

#### 3 Press ▲ or ▼ to select a language, and then press ENTER.



To return to the previous menu, press ◀. To close the Setup menu, press SETUP.

### ■ Step 4: Setting the disc language (audio, subtitle, disc menu)

If you set the disc language, this unit will automatically switch to the selected language (for audio, subtitle and disc menu) when a disc is loaded. If the selected language is not available on the disc, the disc’s default language will be used instead. (The default setting is “ENGLISH” for audio and disc menu and “OFF” for subtitle.)

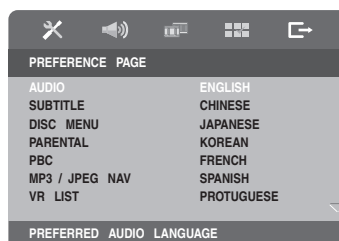

#### 1 Press SETUP to display the Setup menu on the TV.

#### 2 Press ▶ to select “PREFERENCE PAGE”, press ▲ or ▼ to select “AUDIO”, “SUBTITLE” or “DISC MENU”, and then press ▶.

#### Note

“PREFERENCE PAGE” is available only when no disc is inserted or the unit is in the Stop mode (page 11).

#### 3 Press ▲ or ▼ to select a language, and then press ENTER.

If the desired language is not listed, select “OTHERS”, use the Number buttons to enter the 4-digit language code (page 28), then press ENTER.



To return to the previous menu, press ◀. To close the Setup menu, press SETUP.

## Supported Disc Types

You can enjoy movie or music discs with this unit. Since some disc operations are limited to specific disc types, the supported disc types are indicated using the icons shown below. Each icon means that the operation is limited to the corresponding disc type. Operations with no icon indicated are available for all disc types.

DVD/DVD-VR	VIDEO CD/ SUPER VIDEO CD	Music CD
DVD	VCD	CD

### About MP3 and JPEG picture discs

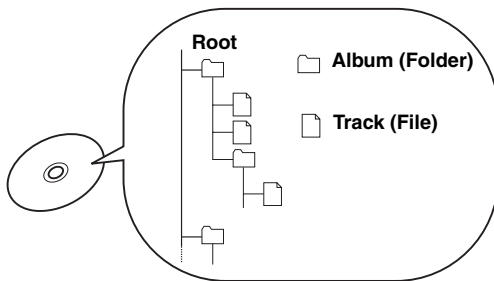

You can play MP3 files recorded on a CD-R or CD-RW with similar uses as a music CD. The DVD player regards folders in the MP3 disc as albums, and files as tracks (as shown on the left). Also you can play JPEG picture files recorded on a CD-R or CD-RW. For details about how to play JPEG picture discs, refer to “Playing MP3 or JPEG (Kodak) Picture Discs” (page 18).

#### What is MP3?

“MP3” is a standard technology and format for compressing an audio sequence into a small-sized file. However it preserves the original level of sound quality when it is played.

#### Notes

- Depending on recording conditions such as recording software settings, the DVD player may not be able to play the disc or play tracks in the order they were recorded.
- The DVD player is compatible with a bit rate range of 32, 64, 96, 128, 192, or 256 kbps and variable bit encoded MP3 files.
- The DVD player is compatible with a sampling frequency of 32, 44.1, or 48 kHz.

#### What is JPEG?

“JPEG” is a compression format for still images. With only a slight drop in image quality (part of the data is removed), still image data can be compressed to approximately 1/10 to 1/100 of its original size.

#### Note

This unit does not support the progressive JPEG format.

## Basic Playback Operations

Follow the procedures below to carry out basic disc playback operations.

### Notes

- If the inhibit icon (⊘ or ✕) appears on the TV when a button is pressed, it means the function is not available on the current disc or the current status.
- Depending on the disc, some operations may be different or restricted.

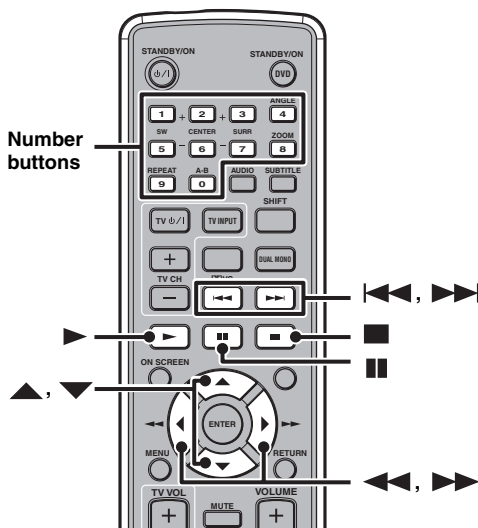

### To start playback

Insert the disc into the disc loading slot.



This unit automatically starts playback when a disc is loaded. In case that the disc has the start menu, you may need to press ▶ to start playback.

### To stop playback

Press ■.



This unit automatically memorizes the stopping position when playback is stopped. If you press ▶, playback resumes from where it left off. If you press ■ once again, the stopping position will be cleared from the memory. (This is called "Stop mode")

### To pause playback

Press ■■.

To return to normal playback, press ▶.

### To advance frame-by-frame DVD VCD

Press ■■ to pause playback, then press ■■ repeatedly. Each time you press ■■, playback advances one frame at a time. To return to normal playback, press ▶.

### To fast reverse or fast forward

To fast reverse, press ◀◀. To fast forward, press ▶▶. Each time you press the button, the speed increases (decreases).



You can also fast-reverse or fast-forward the playback by pressing and holding ◀◀ or ▶▶, and change the speed by pressing ◀◀ or ▶▶ during search.

### To slow reverse or slow forward DVD VCD

To slow reverse press ▲. To slow forward, press ▼. Each time you press the button, the speed increases (decreases).



The Slow reverse feature is not available for VCDs and SVCDs.

### To skip chapters (tracks)

To skip to the start of the current chapter (track), press ◀◀◀.

To skip to the next chapter (track), press ▶▶▶.

To skip to the previous chapter (track), quickly press ◀◀◀ twice.

### Note

The Skip feature may not work properly when playing back a VCD or SVCD using the Playback Control feature (page 16).

### To specify a chapter (track) for playback

Use the Number buttons to enter the chapter (track) number you want to play.

To specify 1-digit number, press a number key to enter the track number and then ENTER, or press 0 and then a number key to enter the track number.

## Repeating Playback (Repeat Play)

You can repeat single chapter (track), single title, or entire disc. Also, you can set two points to repeat the specified section of a title (track) with A-B Repeat.

### Notes

- Repeat Play may not work depending on DVD disc types.
- The Shuffle feature is not available for DVD-VRs.
- Repeat Play does not work while playing back a VCD or SVCD using the Playback Control feature (page 16).

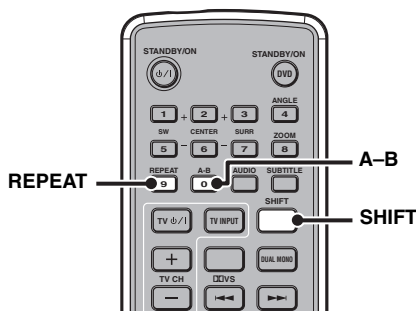

- 1 Play back the disc, title, or chapter (track) you want to repeat.**
- 2 While holding down SHIFT, press REPEAT to select the Repeat Play mode.**  
Each time you press the button, the mode changes as follows:

### DVD/DVD-VR

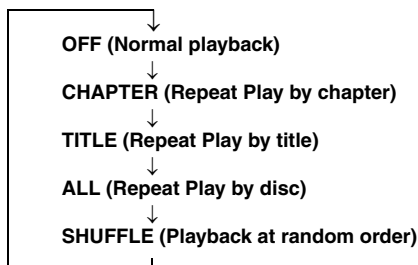

### VCD/SVCD/CD

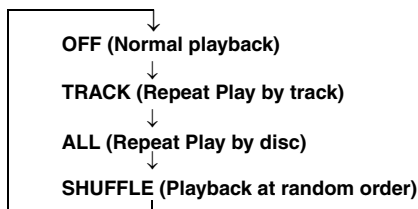

### To cancel Repeat Play

While holding down SHIFT, press REPEAT to select "OFF".

### To repeat between two points (A-B Repeat)

You can repeat the specified section of a title (track) by setting two points (start and end points).

### Note

You can use A-B Repeat only within one title (track).

- 1 Play back the title or track that includes the section you want to repeat.**
- 2 At the position where you want to set as the start point of the repeat section, hold down SHIFT and press A-B.**  
"A" appears on the TV.
- 3 At the position where you want to set as the end point of the repeat section, hold down SHIFT and press A-B again.**  
"AB" appears on the TV and A-B Repeat starts.

### To cancel A-B Repeat

While holding down SHIFT, press A-B once.



## Specifying an elapsed time for playback (Time Search)

You can specify an elapsed time where you want playback to start.

### Notes

- Using the Time Search feature for a VCD or SVCD automatically closes the Playback Control menu (page 16).
- You cannot specify an elapsed time that exceeds the total time.

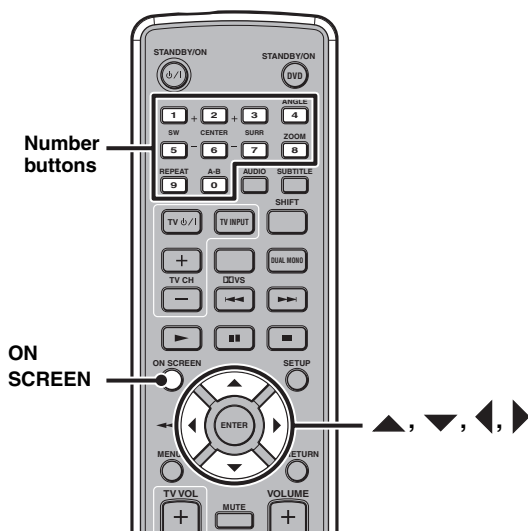

### Time Search on DVD

- 1 While playing back a disc, press ON SCREEN to display the On-Screen menu on the TV.

MENU	
TITLE	01 / 03
CHAPTER	01 / 28
AUDIO	3 / 2.1CH ENGLISH
SUBTITLE	OFF
BITRATE 44       TT ELAPSED 0:00:06	

- 2 Press ▲ or ▼ to select “TT TIME” or “CH TIME”, and then press ►.

#### TT TIME:

Select this if you want to specify an elapsed time for the current title.

#### CH TIME:

Select this if you want to specify an elapsed time for the current chapter.

- 3 Use the Number buttons to enter hours, minutes, and seconds.

Playback skips to the specified position.



To return to the previous menu, press ◀. To close the On-Screen menu, press ON SCREEN.

### Time Search on VCD/SVCD

- 1 While playing back a disc, press ON SCREEN to display the On-Screen menu on the TV.

MENU	
TRACK	01 / 01
DISC TIME	1:06:33
TRACK TIME	1:06:33
REPEAT	OFF
BITRATE 44       TOTAL ELAPSED 0:00:06	

- 2 Press ▲ or ▼ to select “DISC TIME” or “TRACK TIME”, and then press ►.

#### DISC TIME:

Select this if you want to specify an elapsed time for the entire disc.

#### TRACK TIME:

Select this if you want to specify an elapsed time for the current track.

- 3 Use the Number buttons to enter hours, minutes, and seconds.

Playback skips to the specified position.



To return to the previous menu, press ◀. To close the On-Screen menu, press ON SCREEN.

## Time Search on CD

- 1 Press ON SCREEN repeatedly to select "DISC GO TO", "TRACK GO TO" or "SELECT TRACK".

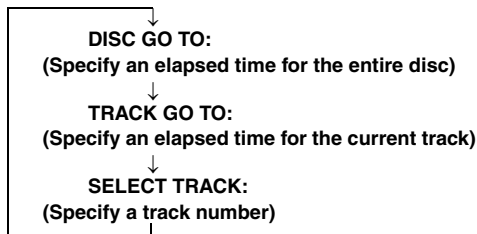

- 2 Use the Number buttons to enter hours, minutes, and seconds (or track number if you select "SELECT TRACK" in step 1). Playback skips to the specified position.

## Customizing Playback Order (Program Play)

You can customize the playback order for chapters or tracks stored in the disc. This unit can memorize playback order of 10 discs (20 chapters or 20 tracks for each disc).

### Notes

- The Playback Control feature (page 16) is not available during Program Play of a VCD or SVCD.
- The Program Play feature is not available for MP3 and JPEG (Kodak) discs.

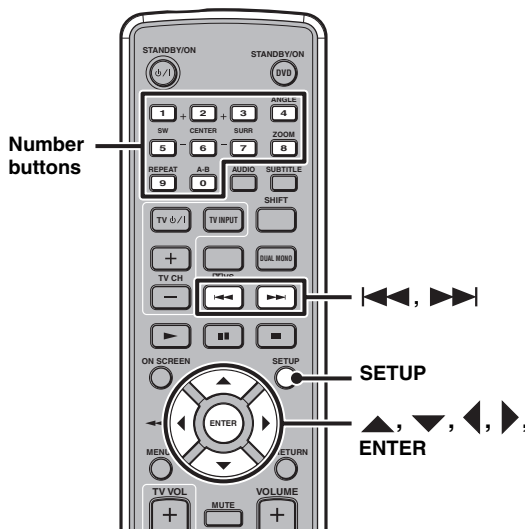

- 1 While the disc is loaded in the unit, press **SETUP** to display the Setup menu on the TV.
- 2 Press **◀** or **▶** to select "GENERAL SETUP PAGE", press **▲** or **▼** to select "PROGRAM", and then press **▶**.
- 3 Press **ENTER** to display the Input menu.
- 4 Press **▲**, **▼**, **◀** or **▶** to select a program number, and then press **ENTER**.  
Pressing **◀◀** or **▶▶** switches the program list to the previous/next page.
- 5 To program the order for a DVD disc, use the **Number** buttons and **ENTER** to enter a title number, and then enter a chapter number. To program the order for a VCD, SVCD, or CD, use **Number** button and **ENTER** to enter a track number.  
Repeat steps 4 and 5 until you select all desired chapters (tracks).

- 6** To start playback with the Program Play feature, press ▲, ▼, ◀ or ▶ to select “START”, and then press ENTER.



- To cancel the Program Play feature, press ▲, ▼, ◀ or ▶ to select “Exit” in the program list, then press ENTER.
- To remove a chapter or track from Program Play, press ▲, ▼, ◀ or ▶ to select the program number, then press ENTER.

## Selecting Audio and Subtitle Languages DVD VCD

You can select audio and subtitle languages for disc playback. If no language is selected, the default languages specified in the Setup menu (page 21) are selected.

### Notes

- This selection is available only with multi-language compatible discs. Also, languages available for each disc may vary. For information on your disc, refer to the operating instructions in the disc’s menu or on its jacket.
- For VCDs and SVCDs, you can switch the audio channel settings (stereo, monaural, etc.) by pressing AUDIO. You cannot select audio and subtitle languages for those discs.

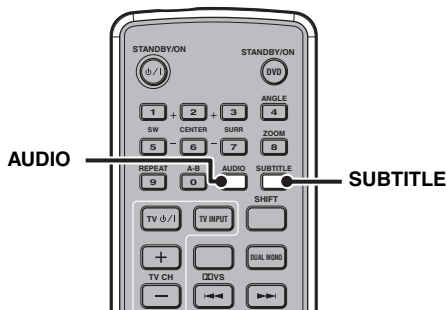

To select an audio language, while playing back a disc, press AUDIO repeatedly until the desired language appears on the TV.

To select a subtitle language, while playing back a disc, press SUBTITLE repeatedly until the desired language appears on the TV.



To turn off the subtitle, press SUBTITLE repeatedly to select “OFF”.

## Zooming the Picture DVD VCD

You can zoom in or zoom out the picture during disc playback.

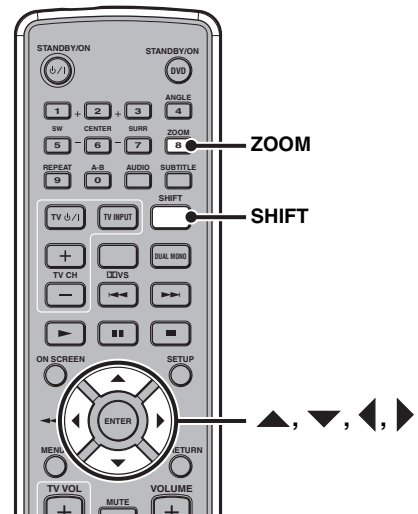

- 1** While playing back a disc, hold down SHIFT and press ZOOM repeatedly.

Each time you press the button, the picture scale changes as follows.

2X → 3X → 4X → 1/2 → 1/3 → 1/4 → original scale (1X)

- 2** If you select “2X”, “3X” or “4X” in step 1, press ▲, ▼, ◀ or ▶ to pan through the enlarged picture.



To return to the original picture scale, hold down SHIFT and press ZOOM repeatedly to select the original scale.

## Selecting a Viewing Angle DVD

You can select the desired viewing angle during DVD playback.

### Note

This selection is available only with multi-angle compatible discs. Also, viewing angles available for each disc may vary. For information on your disc, refer to the operating instructions in the disc's menu or on its jacket.

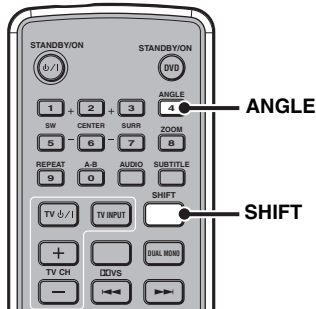

While playing back a disc, hold down **SHIFT** and press **ANGLE** repeatedly until the desired viewing angle is selected.

## Operating the Disc Menu

Many DVD and VCD (SVCD) include original navigational menus called "DVD menu" and "Playback Control menu". These menus provide a convenient way to operate the disc. Follow the procedure below to use a DVD menu or Playback Control menu with this unit.

### Note

Menu contents or operation method of each disc may vary. For information on your disc, refer to the operation instructions in the disc's menu or on its jacket.

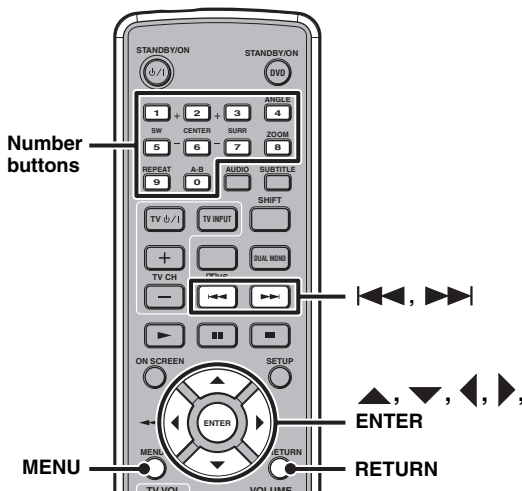

## To operate the DVD menu DVD

1 Press **MENU** to display the DVD menu on the TV.



Depending on the disc, the DVD menu may automatically appear after the disc is loaded.

2 Press **▲**, **▼**, **◀** or **▶** to select a menu item, then press **ENTER** to confirm the selection.

## To operate the Playback Control menu VCD

If you play back a VCD or SVCD that includes the Playback Control feature, the menu automatically appears on the TV. To operate the Playback Control menu with this unit's remote control, use the following buttons.

**Number buttons:** Selects an item.

**▶▶▶:** Moves to the next screen.

**◀◀◀ or RETURN:** Returns to the previous screen.

**ENTER:** Confirms the selected item.

**MENU:** Displays or closes the Playback Control menu.



If you set "PBC" in the Setup menu to "OFF" (page 23), the Playback Control menu is not displayed automatically when playing back a disc.

## Restricting Playback DVD

You can set playback restrictions for certain discs using Parental Control. Only users who know the password (page 18) can access the locked discs.

### ■ Setting the Parental Control level

You can restrict playback according to a predetermined level (Parental Control level). For information on the Parental Control level of each disc, refer to the instruction on its jacket.

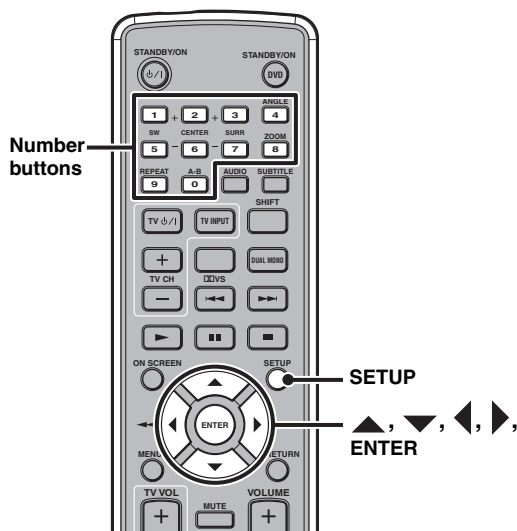

**1** Press **SETUP** to display the Setup menu on the TV.

**2** Press **◀** or **▶** to select “**PREFERENCE PAGE**”, press **▲** or **▼** to select “**PARENTAL**”, and then press **▶**.

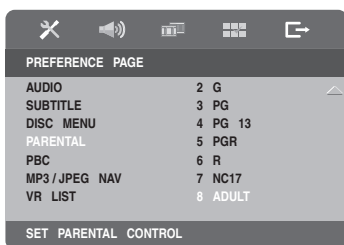

#### Note

“PREFERENCE PAGE” is available only when no disc is inserted or the unit is in the Stop mode (page 11).

**3** Press **▲** or **▼** to select a Parental Control level, and then press **ENTER**.

**1 to 7:** Users cannot play a disc that is rated above the level without entering the password. (The smaller the number, the stricter the Parental Control level.)

**8 (Default setting):** Users can play all discs without entering the password.

**4** Press the number buttons to enter the 6-digit password, then press **ENTER**.

#### Notes

- The default password is “000000”. To change the password, carry out the “Changing the password” procedure (page 18).
- If you forget your password, enter “000000” instead of entering your password.



- To return to the previous menu, press **◀**. To close the Setup menu, press **SETUP**.
- To unlock the Parental Control temporarily for playback, use the Number buttons to enter the password in the password input area (displayed when the locked disc is loaded), and then press **ENTER**.

### ■ Locking discs

You can prevent up to 40 specific discs from playback by locking the discs.

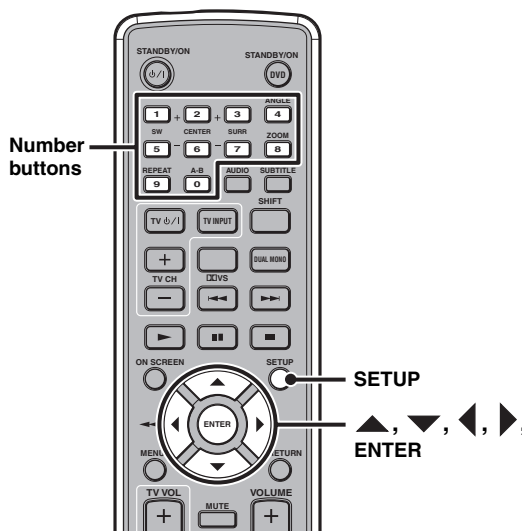

**1** While the disc to be locked is loaded into the unit, press **SETUP** to display the Setup menu on the TV.

**2** Press **◀** or **▶** to select “**GENERAL SETUP PAGE**”, press **▲** or **▼** to select “**DISC LOCK**”, and then press **▶**.

**3** Press **▲** or **▼** to select “**LOCK**”, and then press **ENTER**.

## To disable a lock applied to a disc

Select "UNLOCK" in step 3.



- To return to the previous menu, press ◀. To close the Setup menu, press SETUP.
- To unlock the Disc Lock temporarily for playback, use the Number buttons to enter the password in the password input area (displayed when the locked disc is loaded), and then press ENTER.

## ■ Changing the password

Follow the procedure below to change the password to access locked disc temporarily.

**1 Press SETUP to display the Setup menu on the TV.**

**2 Press ◀ or ▶ to select "PREFERENCE PAGE", press ▲ or ▼ to select "PASSWORD", then press ▶.**

### Note

"PREFERENCE PAGE" is available only when no disc is inserted or the unit is in the Stop mode (page 11).

**3 Press ENTER to display the Password change screen.**

**4 Use the Number buttons to enter the current 6-digit password in the "OLD PASSWORD" area, enter the new 6-digit password in the "NEW PASSWORD" and "CONFIRM PWD" areas, then press ENTER.**

### Notes

- The default password is "000000".
- If you forget your password, enter "000000" instead of your password.



To return to the previous menu, press ◀. To close the Setup menu, press SETUP.

## Playing MP3 or JPEG (Kodak) Picture Discs

You can play back MP3 data recorded on a CD-R or CD-RW disc, or view a JPEG disc or Kodak disc on the TV. For information on basic playback operations, refer to "Basic Playback Operations" (page 11).

### Notes

- This unit cannot display special characters such as double-byte characters used for folder and file names.
- Depending on the disc format, characteristics, or recording conditions, the unit may not read or play back some discs properly.
- If a disc contains a folder consisted of more than 500 files, the unit may not read or play back the disc properly.

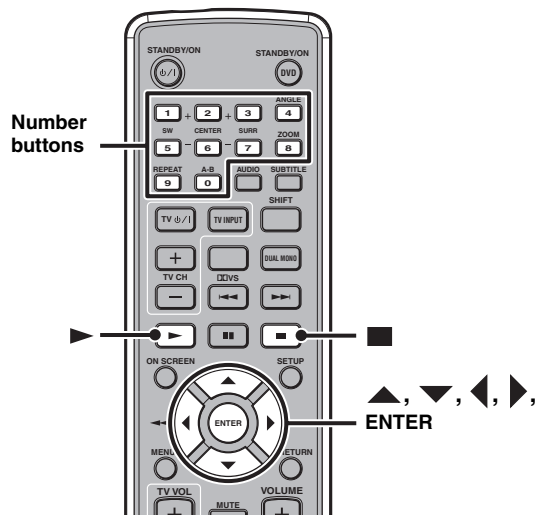

**1 Insert the disc into the disc loading slot.**

For a Kodak disc, the slide show starts automatically. If it does not start, press ▶.

For an MP3 or JPEG disc, the disc menu appears on the TV. To start the slide show for the JPEG disc, press ▶.

**2 Press ▲ or ▼ to select a folder, then press ENTER.**

The file list of the selected folder appears on the TV.

**3 Press ▲, ▼, or Number buttons to select a file, then press ENTER.**

Playback starts from the selected file to the end of the folder.



- While playing back a JPEG (Kodak) picture disc, you can zoom in or zoom out the picture by pressing ZOOM repeatedly while holding down SHIFT. Also, you can pan through the enlarged picture by pressing ▲, ▼, ◀ or ▶.
- While playing back a JPEG (Kodak) picture disc, you can flip the picture by pressing ▲ or flip the picture horizontally by pressing ▼. Also you can rotate it 90 degrees by pressing ◀ or ▶.
- While playing back a JPEG (Kodak) picture disc, you can select a scan effect by pressing ANGLE repeatedly while holding down SHIFT.
- For an MP3 or JPEG (Kodak) picture disc, you can set the playback mode by pressing REPEAT repeatedly while holding down SHIFT.

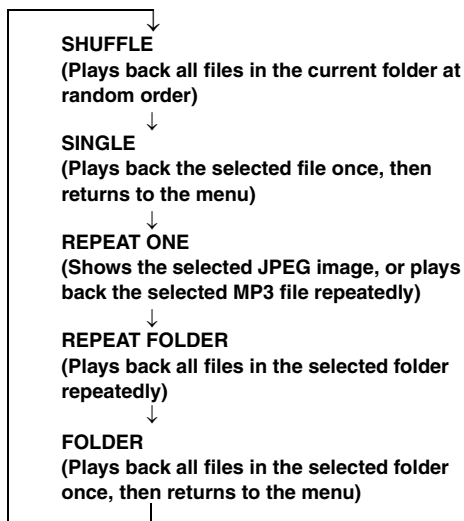

## ■ Viewing JPEG (Kodak) pictures in thumbnail form

You can view the content of the selected folder or disc as small thumbnail images.

### 1 While playing back a JPEG (Kodak) picture disc, press ■.

The JPEG pictures appear in thumbnail form.

Pressing ◀◀ or ▶▶ switches the thumbnail list to the previous/next page.



### 2 To view a specified picture in full size, press ▲, ▼, ◀ or ▶ to select a thumbnail image, then press ENTER.



- To start the slide show from the first picture of the current page, press ▲, ▼, ◀ or ▶ to select [REPEAT], then press ENTER.
- To return to the disc menu, press MENU.

## Setting the Remote Control Code

If you set the remote control code (page 29) for your TV on the remote control of this unit, you can operate the specific functions of your TV with the remote control.

### Note

Depending on the product, this unit's remote control may not be able to operate some TVs. In this case, use the remote control supplied with the TV.

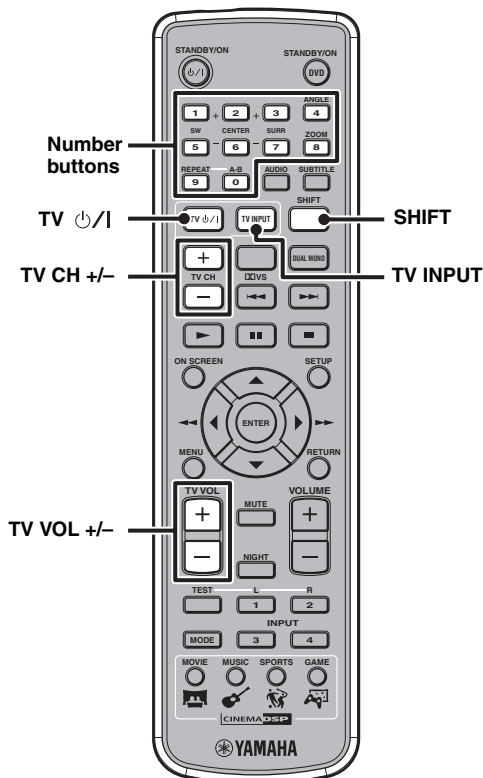

### 1 While holding down SHIFT, press TV $\phi$ /I, then while still holding down SHIFT, use the Number buttons to enter the three-digit remote control code (page 29).

The default setting is "242 (Yamaha)".

### 2 Carry out one of the following operation to check if the remote control works on the TV.

If it does not work, try another remote control code (if there is another choice).

**TV  $\phi$ /I:** Turn the TV on, or set it to the standby mode.

**TV INPUT:** Switches the TV inputs.

**TV VOL +/-:** Adjusts the TV volume level.

**TV CH +/-:** Switches the TV channels.

## Changing Playback Settings on the TV (On-Screen Menu)

You can view and change the settings for the current DVD or VCD (SVCD) playback using the TV (On-Screen menu).

### Note

Displaying the On-Screen menu for a VCD or SVCD automatically closes the Playback Control menu (page 16).



Although the On-Screen menu is shown in English in the procedure below, you can display the menu in other language by setting the OSD language (page 9).

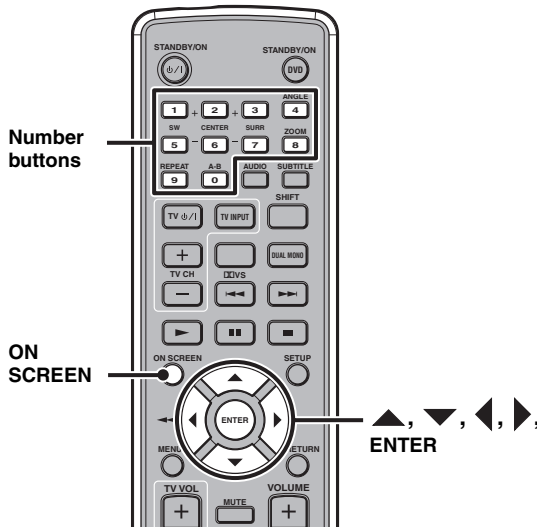

### 1 While playing back a disc, press ON SCREEN to display the On-Screen menu on the TV.

The On-Screen menu shows the settings for the current playback. Depending on the disc currently played back, items of the On-Screen menu vary.

### 2 To change the settings, press ▲ or ▼ to select an item, then press ►.

### 3 To select a parameter, press ▲ or ▼, then press ENTER. To enter numbers or time, use the number buttons.



To return to the previous menu, press ◀. To close the On-Screen menu, press ON SCREEN.

## ■ On-Screen menu items

Items for DVD	Description
TITLE	The current title and the number of titles in the disc
CHAPTER	The current chapter and the number of chapters in the disc
AUDIO	The current settings for audio channels and audio language
SUBTITLE	The current setting for subtitle language
ANGLE	The current angle and the number of angles in the disc
TT TIME	The total time of the current title
CH TIME	The total time of the current chapter
REPEAT	The current setting for the Repeat Play feature
TIME DISP.	The current setting for the time display

Items for VCD/SVCD	Description
TRACK	The current track and the number of track in the disc
DISC TIME	The total time of the disc
TRACK TIME	The total time of the current track
REPEAT	The current setting for the Repeat Play feature
TIME DISP.	The current setting for the time display



## Configuring the Various Parameters (Setup Menu)

In the Setup menu, you can configure the various parameters or operate useful functions. Follow the procedure below to operate the Setup menu. For details on each menu or available parameters, refer to “Setup menu items” (page 22).

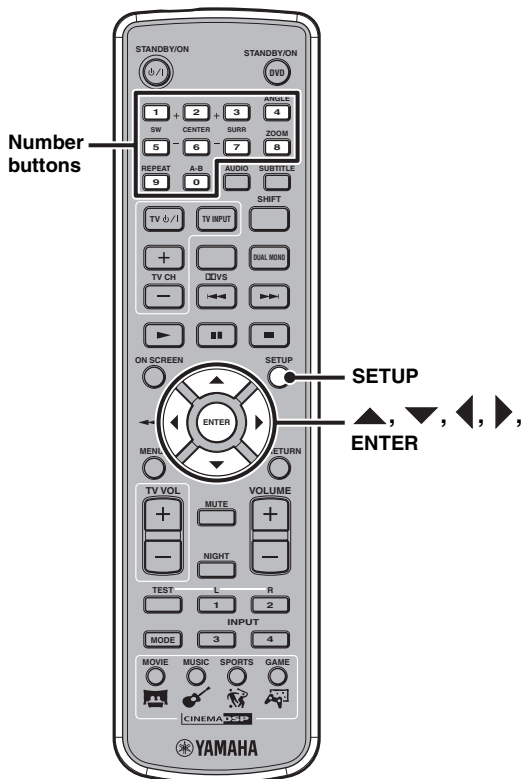

- 1 Press **SETUP** to display the Setup menu on the TV.
- 2 Press **◀** or **▶** to select “GENERAL SETUP PAGE”, “AUDIO SETUP PAGE”, “VIDEO SETUP PAGE” or “PREFERENCE PAGE”.

### Note

“PREFERENCE PAGE” is available only when no disc is inserted or the unit is in the Stop mode (page 11).

- 3 Press **▲** or **▼** to select the desired menu, then press **▶**.

If the selected menu contains one submenu, press **ENTER**.

If the selected menu contains two or more submenus, press **▲** or **▼** to select the desired submenu, then press **ENTER**.

- 4 Press **▲** or **▼** to select the desired parameter, then press **ENTER**.

For configuring some parameters, you need to enter the password by pressing the Number buttons.



To return to the previous menu, press **◀**. To close the Setup menu, press **SETUP**.

## ■ Setup menu items

Page	Menu	Submenu	Parameter
GENERAL SETUP PAGE	DISC LOCK		See page 17 for details. (Default: UNLOCK)
	DISPLAY DIM		You can set brightness for the front panel display. (Default: 100%) <b>100%</b> : Full brightness <b>70%</b> : Medium brightness <b>40%</b> : Dimming the front panel display
	PROGRAM	INPUT MENU	See page 14 for details.
	OSD LANGUAGE		See page 9 for details. (Default: ENGLISH)
	SCREEN SAVER		The screen saver function allows you to prevent the TV screen from burn-in. (Default: ON) <b>ON</b> : Turns off the TV screen when disc playback is stopped or paused for more than 15 minutes. <b>OFF</b> : Disables the screen saver function.
	SLEEP		The sleep function allows you to turn off this unit automatically after a preset time. (Default: OFF) <b>15 MINS</b> : Turns off this unit after 15 minutes. <b>30 MINS</b> : Turns off this unit after 30 minutes. <b>45 MINS</b> : Turns off this unit after 45 minutes. <b>60 MINS</b> : Turns off this unit after 60 minutes. <b>OFF</b> : Disables the sleep function.
AUDIO SETUP PAGE	ANALOG OUTPUT		You can configure the analog output setting. (Default: STEREO) <b>STEREO</b> : Delivers sounds from only the two front speaker channels. <b>LT/RT</b> : Delivers sounds from the multi speaker channels.
	DIGITAL AUDIO	DIGITAL OUTPUT	You can configure the digital output setting according to your optional audio equipment connections. (Default: ALL) <b>OFF</b> : Disables the digital output. <b>ALL</b> : Select this if you connect this unit to a multi-channel decoder/amplifier using a digital connection. <b>PCM ONLY</b> : Select this if your amplifier is not capable of decoding multi-channel audio.
		LPCM OUTPUT	If you connect this unit to a PCM compatible amplifier using a digital connection, configure the LPCM output setting. The higher the sampling rate, the better the sound quality. (Default: 48KHz) <b>48KHz</b> : Plays back a disc recorded at the sampling rate of 48 kHz. <b>96KHz</b> : Plays back a disc recorded at the sampling rate of 96 kHz.
	CD UPSAMPLING *1		You can convert your music CD to a higher sampling rate using sophisticated digital signal processing for better sound quality. If you have activated the upsampling, this unit will automatically switch to stereo mode. (Default: OFF) <b>OFF</b> : Disables the CD upsampling function. <b>88.2KHz (X2)</b> : Converts the sampling rate of the CDs twice higher than original. <b>176.4KHz (X4)</b> : Converts the sampling rate of the CDs for times higher than original.

\*1 "CD UPSAMPLING" is available only when a music CD is loaded in this unit.

Page	Menu	Submenu	Parameter
VIDEO SETUP PAGE *2	TV TYPE		See page 8 for details. (Default: PAL for U.K. and Australia models, MULTI for Taiwan and Asia models)
	TV DISPLAY		You can set the aspect ratio of this unit according to the TV. When the selected format is not available on the disc, this setting will not affect the disc playback. (Default: 4:3 PAN SCAN) <b>4:3 PAN SCAN:</b> Select this if you have a normal TV and want both sides of the picture to be trimmed or formatted to fit your TV screen. <b>4:3 LETTER BOX:</b> Select this if you have a normal TV. In this case, a wide picture with black bands on the upper and lower portions of the TV screen will be displayed. <b>16:9:</b> Select this if you have a wide-screen TV.
	PROGRESSIVE *3		When connecting this unit to a progressive scan compatible TV using a component video connection, you can enjoy high-quality DVD video with the progressive scan mode. (Default: OFF) <b>ON:</b> Enables the progressive scan. <b>OFF:</b> Disables the progressive scan.
	PICTURE SETTING		You can select the picture color setting from three predefined sets or configure in detail. (Default: STANDARD) <b>STANDARD:</b> Uses standard TV picture settings. <b>BRIGHT:</b> Makes the TV picture brighter. <b>SOFT:</b> Makes the TV picture softer. <b>PERSONAL:</b> You can adjust Brightness, Contrast, Tint and Color (saturation) individually. (Press ▲ or ▼ to select an item, press ◀ or ▶ to adjust the parameter, then press ENTER to confirm the adjustment.)
PREFERENCE PAGE *4	AUDIO		See page 9 for details. (Default: ENGLISH)
	SUBTITLE		See page 9 for details. (Default: OFF)
	DISC MENU		See page 9 for details. (Default: ENGLISH)
	PARENTAL		See page 17 for details. (Default: 8)
	PBC		You can enable or disable the auto-display function of the Playback Control menu for VCDs and SVCDs. (Default: ON) <b>ON:</b> Displays the Playback Control menu automatically when a disc is played back. <b>OFF:</b> Starts playback of a disc without displaying the Playback Control menu.
	MP3/JPEG NAV		You can enable or disable the navigator menu function when an MP3 disc or JPEG disc includes the menu. (Default: WITH MENU) <b>WITHOUT MENU:</b> Displays all the files contained in the MP3 disc or JPEG disc. <b>WITH MENU:</b> Displays only the folder menu of the MP3 disc or JPEG disc.
	VR LIST		You can select the original list or play list used for playback of VR (Video Recording) format discs. (Default: ORIGINAL LIST) <b>ORIGINAL LIST:</b> Select this to play the originally recorded titles on the disc. <b>PLAY LIST:</b> Select this to play the edited version of the disc. (This feature is available only when a play list has been created.)
	PASSWORD	CHANGE	See page 18 for details.
	DEFAULT	RESET	Resets all settings to the initial parameters (except the password).

\*2 The video settings of your TV also affect the display image. Make sure you configure the video settings of your TV as well as this unit's video setup.

\*3 The progressive scan mode is only available if you connect this unit to a progressive scan compatible TV using a component video connection.

\*4 "PREFERENCE PAGE" is available only when no disc is inserted or the unit is in the Stop mode (page 11).

### Note

CONSUMERS SHOULD NOTE THAT NOT ALL HIGH DEFINITION TELEVISION SETS ARE FULLY COMPATIBLE WITH THIS PRODUCT AND MAY CAUSE ARTIFACTS TO BE DISPLAYED IN THE PICTURE. IN CASE OF 525 PROGRESSIVE SCAN PICTURE PROBLEMS, IT IS RECOMMENDED THAT YOU SWITCH THE CONNECTION TO THE "STANDARD DEFINITION" OUTPUT. IF THERE ARE QUESTIONS REGARDING YOUR VIDEO MONITOR COMPATIBILITY WITH THIS UNIT, PLEASE CONTACT OUR CUSTOMER SERVICE CENTER.

This unit is compatible with the complete line of YAMAHA products, including the projectors DPX-1100, LPX-510 and the plasma monitor PDM-4210/4210E.

# ADDITIONAL INFORMATION

## Troubleshooting

If there is any problem with your system, check the following items. If you cannot solve your problem with the following remedies or if your problem is not listed below, turn off and unplug the unit, then consult the nearest authorized YAMAHA dealer or service center.



### ■ General

Problem	Cause	Solution
<b>Power turns on but immediately shuts off</b>	The power cable may be connected improperly.	Make sure the power cable is plugged into the outlet firmly.
	This unit may receive a strong electrical shock such as from a lightening bolt or excessive static electricity.	Set this unit to the Standby mode, then disconnect the power cable. Wait for about 30 seconds, then connect the power cable and turn on this unit.
<b>The speakers make no sound</b>	The cables may be connected improperly.	Make sure all cables are connected properly. (page 6)
	The disc loaded into this unit may be not compatible.	Make sure you use a disc supported by this unit. (page iii)
	A DTS source is played back using an analog output jack.	Use a digital connection to play back a DTS source.
	A DTS source is played back while "PCM ONLY" is selected for "DIGITAL OUTPUT" in the Setup menu.	Select "ALL" for "DIGITAL OUTPUT" in the Setup menu. (page 22)
<b>The TV shows no picture</b>	The cables may be connected improperly.	Make sure all cables are connected properly. (page 6)
<b>This unit suddenly turns off</b>	The Sleep feature (page 22) might be set.	Turn on this unit and play the source again.

### ■ Remote control

Problem	Cause	Solution
<b>The remote control does not work for operating this unit</b>	The remote control may be operated outside the remote control operation range.	For information on the remote control operation range, refer to "Using the Remote Control" (page 7).
	The remote control sensor on this unit may be exposed to direct sunlight or lighting (inverted fluorescent lamps).	Change the lighting or this unit's orientation.
	The batteries may be worn out.	Replace the batteries with new ones. (page 7)

## ■ Disc playback

Problem	Cause	Solution
<b>A disc cannot be inserted into this unit</b>	This unit is not turned on.	Turn on this unit and insert the disc after "NO DISC" appears on the front panel display.
	This unit is in the initialization process.	Wait for a while and insert the disc after "NO DISC" appears on the front panel display.
	This unit is not ready for disc loading.	Wait for a while and insert the disc after "NO DISC" appears on the front panel display.
	Another disc is already inserted into this unit.	Eject the disc from this unit, and then insert the disc you want to play back after "NO DISC" appears on the front panel display.
	You may be trying to reload the ejected disc by pushing it.	Press  or  , or remove the disc from the disc loading slot fully and then insert it once again.
<b>Some button operations do not work</b>	Some discs do not support certain functions.	
<b>Playback does not start or stops immediately when pressing </b>	The disc may be dirty.	Wipe the disc clean.
	The disc loaded into this unit may be not compatible.	Make sure you use a disc supported by this unit. (page iii)
	When moved this unit from a cold place to warm one, condensation may be form on the disc reading lens.	Wait for one to two hours, then try again.
<b>An audio or subtitle language does not switch</b>	The disc may not support the multi-language feature.	Make sure you use a disc that supports the multi-language feature.
<b>No subtitles appear</b>	The subtitle may be set to "OFF".	Select a subtitle language you want to display. (page 15)
	The disc may not contain subtitle data.	Make sure you use a disc with subtitle data.
	When using the A-B Repeat feature (page 12), the subtitle may not appear at the parts other than the selected section.	Cancel the A-B Repeat feature. (page 12)
<b>A viewing angle does not switch</b>	The disc may not support the multi-angle feature.	Make sure you use a disc that supports the multi-angle feature.
<b>DVD videos cannot be copied with the VCR</b>	You may be trying to copy a copy-protected DVD.	Most commercially available DVDs include copy protect features. You cannot make a copy of these DVDs.
<b>Picture looks poor</b>	In some cases, picture may look poor while fast forwarding or reversing, but this is not a defect.	
<b>The TV (monitor) does not show the picture properly</b>	In the Setup menu, "TV SYSTEM" does not match the specifications of your TV.	Carry out the procedure "Step 2: Setting the TV color system". (page 8)
	The progressive scan mode may be used with a TV that does not support it.	Disable the progressive scan mode. (page 23)
<b>The screen size of the TV or monitor looks strange (the image is distorted or the subtitle is missing)</b>	"TV DISPLAY" in the Setup menu or the setting of your TV does not match the size of your TV.	Change "TV DISPLAY" in the Setup menu (page 23) or the setting of your TV.
	When the progressive scan mode is activated, image with a 4:3 aspect ratio are played on a 16:9 wide television screen.	Change "TV DISPLAY" in the Setup menu. (page 23) If you cannot adjust the ratio, turn off the progressive scan mode. (page 23)
<b>The TV shows overlapped picture partly</b>	The disc content does not match the progressive scan mode due to the editing method or other conditions.	Disable the progressive scan mode. (page 23)
<b>The disc is ejected without an operation</b>	The disc loaded into this unit may be not compatible.	Make sure you use a disc supported by this unit. (page iii)

## Glossary

### ■ Channel (ch)

A channel is an audio type that has been divided based on range and other characteristics.

Ex. 5.1 channel

- Front speakers, Left (1ch), Right (1ch)
- Center speaker (1 ch)
- Surround speakers, Left (1ch), Right (1ch)
- Subwoofer (1 ch x 0.1\* = 0.1 ch)

\* In contrast to a full 1-channel band, a component designed to enhance low frequency sound for added effect.

### ■ COMPONENT VIDEO OUT

Jacks for inputting or outputting a component video signal. Component video signal consists of three lines, the luminance signal (Y) and two color difference signals (P<sub>B</sub>/C<sub>B</sub>, P<sub>R</sub>/C<sub>R</sub>), which enable to provide high-quality video.

### ■ DTS (Digital Theater Systems)

Digital surround sound system developed by Digital Theater Systems, Inc., which provides 5.1 channel audio. With an abundance of audio data, it is able to provide authentic-sounding effects.

### ■ NTSC (National Television System Committee)

NTSC is a video signal system (525 lines, 30 frames per second) used in North America, Central America, a number of South American countries, and some Asian countries, including Japan.

### ■ PAL (Phase Alternating Line)

PAL is a video signal system (625 lines, 25 frames per second) used in the United Kingdom, much of the rest of western Europe, several South American countries, some Middle East and Asian countries, several African countries, Australia, New Zealand, and other Pacific island countries.

### ■ Pan & Scan and Letterbox

In general, DVD Video is produced for viewing on a wide television screen with an aspect ratio of 16:9. This means you can now view most material with the intended aspect ratio on a wide-screen television.

This ratio will not fit on a standard television that has an aspect ratio of 4:3. Two picture styles, Pan & Scan and Letterbox, deal with this problem.

- Pan & Scan cuts off the left and right portions of the picture to fill the screen.
- Letterbox inserts black bands at the top and bottom of the picture to reproduce an aspect ratio of 16:9.

### ■ PCM (Pulse Code Modulation)

A signal that is changed to digital format without compression. A CD is recorded with 16-bit sound at 44.1 kHz, while DVD recording is anywhere from 16 bits at 48 kHz to 24 bits at 192 kHz, which makes it a higher quality sound than CD. This signal also has a type called Packed PCM (PPCM) that can be compressed without any loss of data.

### ■ Progressive scan

A method of displaying all scanning lines in a frame at once, reducing flicker noticeable on a larger screen and creating a sharp and smooth image.

### ■ Sampling frequency

The number of sampling (process for digitalizing analog signals) per second. In principle, the higher the sampling rate, the wider the frequency range that can be played back, and the higher the quantized bit rate, the finer the sound that can be reproduced.

### ■ Title, Chapter (DVD)

DVD video lets you divide a disc in a big way by titles or a small way by chapters. Each division is either called a title number or a chapter number.

### ■ Track (CD/Video CD/Super Video CD)

A CD, VCD or SVCD can be divided into a number of segments (tracks). Each division is called a title number.

## Copyright and Logo Marks

This product incorporates copyright protection technology that is protected by method claims of certain U.S. patents and other intellectual property rights owned by Macrovision Corporation and other rights owners. Use of this copyright protection technology must be authorized by Macrovision Corporation, and is intended for home and other limited viewing uses only unless otherwise authorized by Macrovision Corporation. Reverse engineering or disassembly is prohibited.



Manufactured under license from Dolby Laboratories. "Dolby" and the double-D symbol are trademarks of Dolby Laboratories.



"DTS" and "DTS Digital Out" are trademarks of Digital Theater Systems, Inc.

MPEG Layer-3 audio decoding technology licensed from Fraunhofer IIS and Thomson multimedia.

## Language Codes

If your desired language for “AUDIO” “SUBTITLE” and “DISC MENU” is not listed in the Setup menu (page 9), select “OTHER”, then enter the 4-digit language code for your desired language.

Abkhazian	6566	Kikuyu; Gikuyu	7573	South Ndebele	7882
Afar	6565	Kinyarwanda	8287	Spanish; Castilian	6983
Afrikaans	6570	Kirghiz	7589	Sundanese	8385
Albanian	8381	Komi	7586	Swahili	8387
Amharic	6577	Korean	7579	Swati	8383
Arabic	6582	Kuanyama; Kwanyama	7574	Swedish	8386
Armenian	7289	Kurdish	7585	Tagalog	8476
Assamese	6583	Kwanyama; Kuanyama	7574	Tahitian	8489
Avestan	6569	Lao	7679	Tajik	8471
Aymara	6589	Latin	7665	Tamil	8465
Azerbaijani	6590	Latvian	7686	Tatar	8484
Bashkir	6665	Letzeburgesch;	7666	Telugu	8469
Basque	6985	Limburgan; Limburger	7673	Thai	8472
Belarusian	6669	Limburger; Limburgan	7673	Tibetan	6679
Bengali	6678	Lingala	7678	Tigrinya	8473
Bihari	6672	Lithuanian	7684	Tonga (Tonga Islands)	8479
Bislama	6673	Luxembourgish	7666	Tsonga	8483
Bokmål, Norwegian	7866	Macedonian	7775	Tswana	8478
Bosnian	6683	Malagasy	7771	Turkish	8482
Breton	6682	Malay	7783	Turkmen	8475
Bulgarian	6671	Malayalam	7776	Twi	8487
Burmese	7789	Maltese	7784	Uighur	8571
Castilian, Spanish	6983	Manx	7186	Ukrainian	8575
Catalan	6765	Maori	7773	Urdu	8582
Chamorro	6772	Marathi	7782	Uzbek	8590
Chechen	6769	Marshallese	7772	Vietnamese	8673
Chewa; Chichewa; Nyanja	7889	Moldavian	7779	Volapük	8679
Chichewa; Chewa; Nyanja	7889	Mongolian	7778	Walloon	8765
Chinese	9072	Nauru	7865	Welsh	6789
Chuang; Zhuang	9065	Navaho, Navajo	7886	Wolof	8779
Church Slavic; Slavonic	6785	Navajo; Navaho	7886	Xhosa	8872
Church Slavonic; Church	6785	Ndebele, North	7868	Yiddish	8973
Chuvash	6786	Ndebele, South	7882	Yoruba	8979
Cornish	7587	Ndonga	7871	Zhuang; Chuang	9065
Corsican	6779	Nepali	7869	Zulu	9085
Czech	6783	North Ndebele	7868		
Danish	6865	Northern Sami	8369		
Dutch	7876	Norwegian	7879		
Dzongkha	6890	Norwegian Bokmål; Bokmål	7866		
English	6978	Norwegian Nynorsk	7878		
Esperanto	6979	Nyanja; Chichewa; Chewa	7889		
Estonian	6984	Nynorsk, Norwegian	7878		
Faroese	7079	Occitan; Provençal	7967		
Fijian	7074	Old Bulgarian; Old Slavonic	6785		
Finnish	7073	Old Slavonic; Old Bulgarian	6785		
French	7082	Oriya	7982		
Frisian	7089	Oromo	7977		
Gaelic; Scottish Gaelic	7168	Ossetian; Ossetic	7983		
Gallegan	7176	Ossetic; Ossetian	7983		
Georgian	7565	Pali	8073		
German	6869	Panjabi	8065		
Gikuyu; Kikuyu	7573	Persian	7065		
Greek	6976	Polish	8076		
Guarani	7178	Portuguese	8084		
Gujarati	7185	Provençal; Occitan (post)	7967		
Hausa	7265	Pushto	8083		
Hebrew	7269	Quechua	8185		
Herero	7290	Raeto-Romance	8277		
Hindi	7273	Romanian	8279		
Hiri Motu	7279	Rundi	8278		
Hungarian	7285	Russian	8285		
Icelandic	7383	Samoan	8377		
Ido	7379	Sango	8371		
Interlingua (International)	7365	Sanskrit	8365		
Inuktitut	7385	Sardinian	8367		
Inupiaq	7375	Scottish Gaelic; Gaelic	7168		
Irish	7165	Serbian	8382		
Italian	7384	Shona	8378		
Japanese	7465	Sindhi	8368		
Javanese	7486	Sinhalese	8373		
Kalaallisut	7576	Slavonic; Church Slavic	6785		
Kannada	7578	Slovak	8375		
Kashmiri	7583	Slovenian	8376		
Kazakh	7575	Somali	8379		
Khmer	7577	Sotho, Southern	8384		



## Remote Control Codes

If you set the remote control code for your TV on the remote control of this unit (page 19), you can operate the specific functions of your TV with the remote control.

### Notes

- Depending on the product, this unit's remote control may not be able to operate some TVs. In this case, use the remote control supplied with the TV.
- If there are multiple choices of remote control codes for your TV, try them in order until you find the proper code.

### TV

ADMIRAL	292, 293, 216	PANASONIC	234, 235, 236, 253, 288, 211
AIWA	294, 276, 283, 284	PHILCO	297, 225, 239, 298
AKAI	295, 296	PHILIPS	225, 205, 298
ALBA	296	PIONEER	226, 235, 254, 255, 268
AOC	297	PORTLAND	297, 256
BELL & HOWELL	292	PROSCAN	293, 221
BESTAR	298	PROSCAN	231, 241, 251
BLAUPUNKT	229, 222	PROTON	297, 250, 260, 270
BLUE SKY	298	QUASAR	234, 235
BRANDT	223	RADIO SHACK	299, 293, 297
BROC SONIC	297	RCA	293, 297, 234, 256, 257, 258, 221
BUSH	296	RUNCO	220, 230, 271
BY DESIGN	201, 202	SABA	223, 269, 265, 266
CLATRONIC	298	SAMPO	281, 297, 280
CRAIG	224	SAMSUNG	297, 239, 248, 262, 275
CROSLEX	225, 298	SANYO	295, 233, 279, 272, 273, 274, 212
CURTIS MATHIS	297, 226	SCHNEIDER	296
DAEWOO	297, 298, 224, 227, 228	SCOTT	297
DAYTRON	239	SHARP	292, 239, 232, 213
DUAL	298	SIEMENS	229
DWIN	293, 281	SIGNATURE	216
EMERSON	297, 224, 239, 232	SIGNATURE	292
FURGUSON	223, 265, 266	SONY	263, 214
FIRST LINE	298	SYLVANIA	297, 225
FISHER	295, 233	SYMPHONIC	217, 218, 219
FRABA	298	TELEFUNKUN	269, 264, 265, 266
FUJITSU	289	THOMSON	223, 266
FUNAI	277, 278	TOSHIBA	292, 226, 267, 215
GE	293, 297, 234, 235, 236	VIDECH	297, 242
GOODMANS	296, 298, 223	WARDS	297, 239, 232, 216
GRUNDIG	229, 238, 249	YAMAHA	299, 292, 242, 285, 287, 253
HITACHI	297, 239, 242, 243, 285	ZENITH	216, 261, 271
ICE	296		
IRRADIO	296		
ITT/NOKIA	244, 245		
JC PENNY	293, 297, 234, 237		
JVC	296, 246, 247, 286		
KENDO	298		
KTV	297, 239		
LG/GOLDSTAR	297, 298, 239, 237		
LOEWE	298, 248		
LXI	293, 297, 225, 226, 233, 298		
MAGNAVOX	297, 225, 239, 298		
MARANTZ	298, 210		
MATSUI	295		
MEDION	203, 204, 298		
MEMOREX	297, 216		
MITSUBISHI	299, 297, 259, 287		
NAD	226, 255		
NEC	297, 252, 282		
NOKIA	244, 245		
NOKIA OCEANIC	245		
NORDMENDE	265, 266		
ONWA	296		

## Specifications

### AUDIO SECTION

- Audio Output Level (1 kHz, 0 dB)..... 2 V
- Signal to Noise Ratio ..... 105 dB or more
- Dynamic Range ..... 100 dB or more
- Total Harmonic Distortion .....0.003% or less
- Frequency Response
  - DVD (fs 96 kHz)..... 4 to 44 kHz
  - DVD (fs 48 kHz)..... 4 to 22 kHz
  - SVCD (fs 48 kHz)..... 4 to 22 kHz
  - SVCD (fs 44.1 kHz)..... 4 to 20 kHz
  - CD/VCD..... 4 to 20 kHz

### VIDEO SECTION

- Video Signal Level
  - Composite ..... 1 Vp-p/75 Ω
  - Component ..... 1 Vp-p/75 Ω (Y)
  - 0.7 Vp-p/75 Ω (P<sub>B</sub>, P<sub>R</sub>)
  - SCART (U.K. model)..... 0.7 Vp-p/75 Ω

### GENERAL

- Power Supply
  - U.K. model ..... AC 230 V, 50 Hz
  - Australia model ..... AC 240 V, 50 Hz
  - Korea model..... AC 220 V, 60 Hz
  - Taiwan model..... AC 110–120 V, 50/60 Hz
  - Asia model..... AC 220–240 V, 50/60 Hz
- Power consumption ..... 8 W
- Standby Power Consumption ..... less than 1 W
- Laser Pickup
  - Type .....Semiconductor laser GaAlAs
  - Wave length .....650 nm (DVD), 780 nm (VCD/CD)
  - Output Power ..... 7 mW (DVD), 10 mW (VCD/CD)
- Dimensions (W x H x D) .....215 x 70 x 315 mm  
(Approx. 8 15/32" x 2 3/4" x 12 13/32")
- Weight..... 2.4 kg  
(Approx. 5 lbs 5 oz)

Specifications are subject to change without notice.



---

© 2005 YAMAHA CORPORATION All rights reserved.

**YAMAHA ELECTRONICS CORPORATION, USA** 6660 ORANGETHORPE AVE., BUENA PARK, CALIF. 90620, U.S.A.  
**YAMAHA CANADA MUSIC LTD.** 135 MILNER AVE., SCARBOROUGH, ONTARIO M1S 3R1, CANADA  
**YAMAHA ELECTRONIK EUROPA G.m.b.H.** SIEMENSSTR. 22-34, 25462 RELINGEN BEI HAMBURG, GERMANY  
**YAMAHA ELECTRONIQUE FRANCE S.A.** RUE AMBROISE CROIZAT BP70 CROISSY-BEAUBOURG 77312 MARNE-LA-VALLEE CEDEX02, FRANCE  
**YAMAHA ELECTRONICS (UK) LTD.** YAMAHA HOUSE, 200 RICKMANSWORTH ROAD WATFORD, HERTS WD18 7GQ, ENGLAND  
**YAMAHA SCANDINAVIA A.B.** J A WETTERGRENS GATA 1, BOX 30053, 400 43 VÄSTRA FRÖLUNDA, SWEDEN  
**YAMAHA MUSIC AUSTRALIA PTY, LTD.** 17-33 MARKET ST., SOUTH MELBOURNE, 3205 VIC., AUSTRALIA

**YAMAHA CORPORATION**  
Printed in Malaysia © WF75850

## Free Manuals Download Website

<http://myh66.com>

<http://usermanuals.us>

<http://www.somanuals.com>

<http://www.4manuals.cc>

<http://www.manual-lib.com>

<http://www.404manual.com>

<http://www.luxmanual.com>

<http://aubethermostatmanual.com>

Golf course search by state

<http://golfingnear.com>

Email search by domain

<http://emailbydomain.com>

Auto manuals search

<http://auto.somanuals.com>

TV manuals search

<http://tv.somanuals.com>