

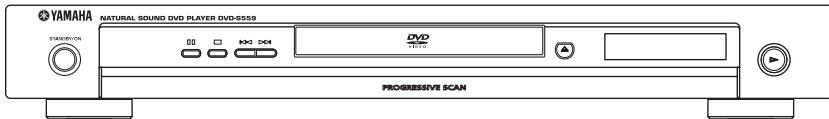

DVD PLAYER
LECTEUR DE DVD

DVD-S559

OWNER'S MANUAL
MODE D'EMPLOI



Important notes for users in the U.K.

Mains plug

This apparatus is fitted with an approved 13 Amp plug. To change a fuse in this type of plug proceed as follows:

- 1 Remove fuse cover and fuse.
- 2 Fix new fuse which should be a BS1362 5 Amp, A.S.T.A. or BSI approved type.
- 3 Refit the fuse cover.

If the fitted plug is not suitable for your jack outlets, it should be cut off and an appropriate plug fitted in its place.

If the mains plug contains a fuse, this should have a value of 5 Amp. If a plug without a fuse is used, the fuse at the distribution board should not be greater than 5 Amp.

Note: The severed plug must be disposed to avoid a possible shock hazard should it be inserted into a 13 Amp jack elsewhere.

How to connect a plug

The wires in the mains lead are coloured with the following code: blue = neutral (N), brown = live (L).

As these colours may not correspond with the colour markings identifying the terminals in your plug, proceed as follows:

- Connect the blue wire to the terminal marked N or coloured black.
- Connect the brown wire to the terminal marked L or coloured red.
- Do not connect either wire to the earth terminal in the plug, marked E (or e) or coloured green (or green and yellow).

Before replacing the plug cover, make certain that the cord grip is clamped over the sheath of the lead - not simply over the two wires.

Copyright in the U.K.

Recording and playback of material may require consent. See Copyright Act 1956 and The Performer's Protection Acts 1958 to 1972.

VAROITUS

Muiden kuin tässä esitettyjen toimintojen säädön tai asetusten muutto saattaa altistaa vaaralliselle säteilylle tai muille vaarallisille toiminnoille.

DK

Advarsel: Udsynlig laserstråling ved åbning når sikkerhedsafbrydere er ude af funktion. Undgå udsættelse for stråling.

Bemærk: Netafbryderen STANDBY/ON er sekundært indkoblet og afbryder ikke strømmen fra nettet. Den indbyggede netdel er derfor tilsluttet til lysnettet så længe netstikket sidder i stikkontakten.

N

Observer: Nettbryteren STANDBY/ON er sekundært innkoplet. Den innebygdenetdelen er derfor ikke frakoplet nettet så lenge apparatet er tilsluttet nettkontakten.

S

Klass 1 laseraparar

Varning! Om apparaten används på annat sätt än i denna bruksanvisning specificerats, kan användaren utsättas för osynlig laserstrålning, som överskrider gränsen för laserklass 1.

Observera! Strömbrytaren STANDBY/ON är sekundärt kopplad och inte bryter inte strömmen från nätet. Den inbyggda nätdelen är därför ansluten till elnätet så länge stickproppen sitter i vägguttaget.

SF

Luokan 1 laserlaite

Varoitus! Laitteen käyttäminen muulla kuin tässä käyttöohjeessa mainitulla tavalla saattaa altistaa käyttäjän turvallisuusluokan 1 ylittävälle näkymättömälle lasersäteilylle.

Oikeus muutoksiin varataan. Laite ei saa olla alttiina tippu-ja roiskevedelle.

Toiminnanvalitsin STANDBY/ON on kytketty toisiopuolelle, eikä se kytke laitetta irti sähköverkosta. Sisäänrakennettu verkko-osa on kytkettynä sähköverkkoon aina silloin, kun pistoke on pistorasiassa.

VARO!

AVATTAESSA JA SUOJALUKITUS OHITETTAESSA OLET ALTTIINA NÄKYMÄTTÖMÄLLE LASERSÄTEILYLLE. ÄLÄ KATSO SÄ TEESEEN.

WARNING!

OSYNNIG LASERSTRÅLNING NÄR DENNA DEL ÄR ÖPPNAD OCH SPÄRREN ÄR URKOPPLAD. BETRAKTA EJ STRÅLEN.

CAUTION Use of controls or adjustments or performance of procedures other than those specified herein may result in hazardous radiation exposure.
ATTENTION L'emploi de commandes, de réglages ou un choix de procédures différents des spécifications de cette brochure peut entraîner une exposition à d'éventuelles radiations pouvant être dangereuses.
ACHTUNG Die Verwendung von Bedienungselementen oder Einstellungen oder die Durchführung von Bedienungsvorgängen, die nicht in dieser Anleitung aufgeführt sind, kann zu einem Kontakt mit gefährlichen Laserstrahlen führen.
OBSERVERA Användning av kontroller och justeringar eller genomförande av procedurer andra än de som specificeras i denna bok kan resultera i att du utsätter dig för farlig strålning.
ATTENZIONE Uso di controlli o regolazioni o procedure non specificamente descritte può causare l'esposizione a radiazioni di livello pericoloso.
PRECAUCIÓN El uso de los controles o los procedimientos de ajuste o utilización diferentes de los especificados en este manual pueden causar una exposición peligrosa a la radiación.
VOORZICHTIG Gebruik van bedieningsorganen of instellingen, of uitvoeren van handelingen anders dan staan beschreven in deze handleiding kunnen leiden tot blootstelling aan gevaarlijke stralen.
ПРЕДУПРЕЖДЕНИЕ Использование органов управления или настроек или выполнение процедур, отличных от описанных в данном руководстве, могут привести к опасному облучению.

The unit is not disconnected from the AC power source as long as it is connected to the wall outlet, even if this unit itself is turned off. This state is called the standby mode. In this state, this unit is designed to consume a very small quantity of power.
L'appareil n'est pas isolé de la source d'alimentation aussi longtemps qu'il reste branché sur une prise murale, même lorsqu'il est éteint. Il est alors dit en mode «Veille». Dans ce mode, l'appareil consomme très peu de courant.
Das Gerät ist nicht vom Netz getrennt, solange der Netzstecker noch mit der Wandsteckdose verbunden ist, selbst wenn das Gerät ausgeschaltet wurde. Dieser Betriebszustand wird als Bereitschaftsmodus bezeichnet. In diesem Zustand nimmt das Gerät eine sehr geringe Menge Strom auf.
Enheten är inte urkopplad från nätet så länge som den är ansluten till vägguttaget även om enheten i sig självt är avstängd. Detta kallas för beredskapsläge och i detta tillstånd konsumerar apparaten minimalt med ström.
L'unità non è scollegata dall'impianto elettrico di casa sintanto che rimane collegata ad una presa di corrente anche se è spenta. Questo modo viene chiamato "modo di attesa". In esso, l'unità consuma una quantità molto bassa di energia per mantenere in memoria le impostazioni da voi fatte.
Aunque el propio aparato se encuentre apagado, éste no se desconectará de la fuente de CA siempre que se mantenga enchufado a la toma de corriente. Este estado recibe el nombre de "modo de espera". En este estado, este aparato ha sido diseñado para consumir una cantidad muy pequeña de energía.
De stroomtoevoer naar het toestel is niet afgesloten zolang de stekker nog in het stopcontact zit, zelfs niet als het toestel zelf uitgeschakeld is. Deze toestand wordt "standby" (waak- of paraatstand) genoemd. Het toestel is ontworpen om in deze toestand.
Данное устройство не отсоединено от источника переменного напряжения до тех пор, пока оно подключено к настенной розетке, даже если само данное устройство выключено. Это состояние называется режимом готовности. В этом состоянии данное устройство потребляет очень малое количество электроэнергии.

CAUTION	: VISIBLE AND INVISIBLE LASER RADIATION WHEN OPEN, AVOID EXPOSURE TO BEAM
VORSICHT	: SICHTBARE UND UNSICHTBARE LASERSTRAHLUNG WENN ABDECKUNG GEÖFFNET NICHT DEM STRAHL AUSSETZEN
ADVARSSEL	: SYNLIG OG USYNLIG LASERSTRÅLING VED ÅBNING UNDGA UDSÆTTELSE FOR STRÅLING
WARNING	: SYNLIG OCH OSYNLIG LASERSTRÅLNING NÄR DENNA DEL ÄR ÖPPNAD BETRÄKTA EJ STRÅLEN
VARO!	: AVATTAESSA OLET ALLTIINNA NÄKYVÄLLE JA NÄKYMÄTTÖMÄLLE LASER SÄTEILYLLÄ. ÄLÄ KATSO SÄTEESEEN
CUIDADO	: RADIACIÓN LÁSER VISIBLE E INVISIBLE AL ESTAR ABIERTO. EVITAR EXPOSICIÓN AL RAYO.

CLASS 1 LASER PRODUCT LASER KLASSE 1 PRODUKT LUOKAN 1 LASERLÄITE KLASS 1 LASER APPARAT PRODUIT LASER DE CLASSE 1
--

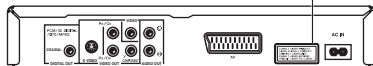
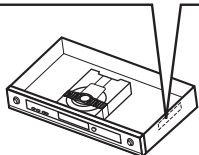

CAUTION: READ THIS BEFORE OPERATING YOUR UNIT.

- 1 To assure the finest performance, please read this manual carefully. Keep it in a safe place for future reference.
- 2 Install this sound system in a well ventilated, cool, dry, clean place — away from direct sunlight, heat sources, vibration, dust, moisture, or cold. In a cabinet, allow about 2.5 cm (1 inch) of free space all around this unit for adequate ventilation.
- 3 Locate this unit away from other electrical appliances, motors, or transformers to avoid humming sounds.
- 4 Do not expose this unit to sudden temperature changes from cold to hot, nor locate this unit in an environment with high humidity (i.e., a room with a humidifier) to prevent condensation inside this unit, which may cause an electrical shock, fire, damage to this unit, and/or personal injury.
- 5 Avoid installing this unit in a location where foreign objects may fall onto this unit or where this unit may be exposed to liquid dripping or splashing. On the top of this unit, do not place:
 - Other components, as they may cause damage and/or discoloration on the surface of this unit.
 - Burning objects (i.e., candles), as they may cause fire, damage to this unit, and/or personal injury.
 - Containers with liquid in them, as they may fall, spilling the liquid and causing an electrical shock to the user and/or damage to this unit.
- 6 Do not cover this unit with a newspaper, tablecloth, curtain, etc. in order not to obstruct heat radiation. If the temperature inside this unit rises, it may cause fire, damage to this unit, and/or personal injury.
- 7 Do not plug in this unit to a wall outlet until all connections are complete.
- 8 Do not operate this unit upside-down. It may overheat, possibly causing damage.
- 9 Do not use excessive force on switches, knobs and/or cords.
- 10 When disconnecting the power cord from the wall outlet, grasp the plug; do not pull the cord.
- 11 Do not clean this unit with chemical solvents; this might damage the finish. Use a clean, dry cloth.
- 12 Use only the voltage specified on this unit. Using this unit with a higher voltage than specified is dangerous and may cause fire, damage to this unit, and/or personal injury. YAMAHA will not be held responsible for any damage resulting from use of this unit with a voltage other than as specified.
- 13 To prevent damage by lightning, keep the power cord out and outdoor antennas disconnected from a wall outlet or the unit during a lightning storm.
- 14 Do not attempt to modify or fix this unit. Contact qualified YAMAHA service personnel when any service is needed. The cabinet should never be opened for any reason.
- 15 When not planning to use this unit for long periods of time (i.e., vacation), disconnect the AC power plug from the wall outlet.
- 16 Be sure to read the "Troubleshooting" section on common operating errors before concluding that this unit is faulty.
- 17 Before moving this unit, press STANDBY/ON to set the unit in standby mode, then disconnect the AC power plug from the wall outlet.
- 18 Install this unit near the AC outlet and where the AC power plug can be reached easily.

WARNING

TO REDUCE THE RISK OF FIRE OR ELECTRIC SHOCK, DO NOT EXPOSE THIS UNIT TO RAIN OR MOISTURE.

LASER SAFETY

This unit employs a laser. Due to possible eye injury, only a qualified service person should remove the cover or attempt to service this device.

DANGER

This unit emits visible laser radiation when open. Avoid direct eye exposure to beam. When this unit is plugged into a wall outlet, do not place your eyes close to the opening of the disc tray and other openings or look inside.

Thank you for purchasing this YAMAHA product.

Please read through this owner's manual so that you will know how to operate your model properly. After you have finished reading the instructions, put them in a safe place for future reference.

Contents

01 Before you start

Features.....	4
What's in the box.....	4
Hints on installation.....	5
Disc/content format playback compatibility	5

02 Connecting up

Easy connections.....	8
Connecting using a SCART AV cable.....	9
Connecting using the S-video output.....	9
Connecting using the component video output.....	10
Connecting to an AV receiver.....	11

03 Controls and displays

Front panel.....	12
Remote control.....	13

04 Getting started

Switching on.....	14
Using the on-screen displays.....	14
Setting up the player for your TV.....	15
Setting the language of this player's on-screen displays.....	15
Playing discs.....	16

05 Playing discs

Scanning discs.....	20
Playing in slow motion.....	20
Frame advance/frame reverse.....	21
Viewing a JPEG slideshow.....	21
Browsing DVD or Video CD/Super VCD disc with the Disc Navigator.....	21
Browsing WMA, MP3, DivX video and JPEG files with the Disc Navigator.....	22
Looping a section of a disc.....	23
Using repeat play.....	23
Using random play.....	24
Creating a program list.....	25
Searching a disc.....	26
Switching subtitles.....	26
Switching audio language/channels.....	27
Zooming the screen.....	27
Switching camera angles.....	27
Displaying disc information.....	27

06 Audio Settings and Video Adjust menus

Audio Settings menu.....	28
Video Adjust menu.....	29

07 Initial Settings menu

Using the Initial Settings menu	30
Digital Audio Out settings	30
Video Output settings	31
Language settings	31
Display settings	32
Options settings	32
Parental Lock	33

08 Additional information

Taking care of your player and discs	35
Screen sizes and disc formats	36
Setting the TV system	37
Resetting the player	37
DVD-Video regions	37
Selecting languages using the language code list	37
Language code list	38
Country/Area code list	38
Glossary	39
Specifications	40

This product incorporates copyright protection technology that is protected by method claims of certain U.S. patents and other intellectual property rights owned by Macrovision Corporation and other rights owners. Use of this copyright protection technology must be authorized by Macrovision Corporation, and is intended for home and other limited viewing uses only unless otherwise authorized by Macrovision Corporation. Reverse engineering or disassembly is prohibited.

Chapter 1

Before you start

Features

- **24-bit/192kHz compatible DAC**

The on-board 24-bit/192kHz DAC means that this player is fully compatible with high sampling-rate discs, capable of delivering exceptional sound quality in terms of dynamic range, low-level resolution and high-frequency detail.

- **Excellent audio performance surround sound entertainment with Dolby Digital*¹ and DTS*² software**

Logos:



When connected to a suitable AV amplifier or receiver, this player gives great surround sound with Dolby Digital and DTS discs.

- **PureCinema Progressive Scan video**

When connected to a progressive scan-compatible TV or monitor using the component video outputs, you can enjoy extremely stable, flicker free images, with the same frame refresh rate as the original movie.

- **New Disc Navigator with moving pictures**

The new Disc Navigator enables you play the first few seconds of each title or chapter in a thumbnail image on screen.

- **DSP effects for enhanced playback**

See *Audio Settings and Video Adjust menus* on page 28.

- **Picture zoom**

See *Zooming the screen* on page 27.

- **MP3 and WMA compatibility**

See *Compressed audio compatibility* on page 6.

- **JPEG compatibility**

See *JPEG file compatibility* on page 7.

- **DivX video compatibility**

See *DivX video compatibility* on page 7.

- **Energy saving design**

An auto power-off function switches the player into standby if not used for about 30 minutes.

*¹ Manufactured under license from Dolby Laboratories. "Dolby" and the double-D symbol are trademarks of Dolby Laboratories.

*² "DTS" and "DTS Digital Out" are registered trademarks of Digital Theater Systems Inc.

What's in the box

Please confirm that the following accessories are in the box when you open it.

- Remote control
- AA/R6 dry cell batteries x2
- Audio/video cable (red/white/yellow plugs)
- Power cable
- Owner's Manual

Putting the batteries in the remote

- **Open the battery compartment cover and insert the batteries as shown.**

Use two AA/R6 batteries and follow the indications (⊕, ⊖) inside the compartment. Close the cover when you're finished.

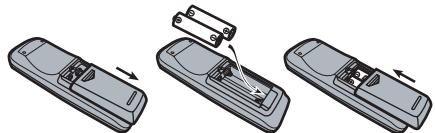



Important

Incorrect use of batteries can result in hazards such as leakage and bursting. Please observe the following:

- Don't mix new and old batteries together.
- Don't use different kinds of battery together—although they may look similar, different batteries may have different voltages.
- Make sure that the plus and minus ends of each battery match the indications in the battery compartment.
- Remove batteries from equipment that isn't going to be used for a month or more.
- When disposing of used batteries, please comply with governmental regulations or environmental public instruction's rules that apply in your country or area.

Hints on installation

We want you to enjoy using this product for years to come, so please use the following guidelines when choosing a suitable location:

Do...

- Use in a well-ventilated room.
- Place on a solid, flat, level surface, such as a table, shelf or stereo rack.

Don't...

- Use in a place exposed to high temperatures or humidity, including near radiators and other heat-generating appliances.
- Place on a window sill or a place where the player will be exposed to direct sunlight.
- Use in an excessively dusty or damp environment.
- Place directly on top of an amplifier, or other component in your stereo system that becomes hot in use.

- Use near a television or monitor as you may experience interference—especially if the television uses an indoor antenna.
- Use in a kitchen or other room where the player may be exposed to smoke or steam.
- Use on a thick rug or carpet, or cover with cloth—this may prevent proper cooling of the unit.
- Place on an unstable surface, or one that is not large enough to support all four of the unit's feet.

Disc/content format playback compatibility

This player is compatible with a wide range of disc types (media) and formats. Playable discs will generally feature one of the following logos on the disc and/or disc packaging. Note however that some disc types, such as recordable CD and DVD, may be in an unplayable format—see below for further compatibility information.

Please also note that recordable discs cannot be recorded using this player.



-  is a trademark of Fuji Photo Film Co. Ltd.
- Also compatible with KODAK Picture CD

This player supports the IEC's Super VCD standard. Compared to the Video CD standard, Super VCD offers superior picture quality, and allows two stereo soundtracks to be recorded. Super VCD also supports the widescreen size.



Super VCD

- DRM (Digital Rights Management) compatible: Yes (DRM-protected audio files will *not* play in this player—see also *DRM* in the *Glossary* on page 39)
- File extensions: .mp3, .wma (these must be used for the player to recognize MP3 and WMA files – do not use for other file types)

CD-R/RW compatibility

- Compatible formats: CD-Audio, Video CD/ Super VCD, ISO 9660 CD-ROM* containing MP3, WMA, JPEG or DivX video files
* *ISO 9660 Level 1 or 2 compliant. CD physical format: Mode1, Mode2 XA Form1. Romeo and Joliet file systems are both compatible with this player.*
- Multi-session playback: No
- Unfinalized disc playback: No
- File structure (may differ): Up to 299 folders on a disc; up to 648 folders and files (combined) within each folder

DVD+R/RW, DVD-R/RW compatibility

- Compatible formats: DVD-Video, Video Recording (VR)*
* *DVD-RW only. Edit points may not play exactly as edited; screen may go momentarily blank at edited points.*
- Unfinalized playback: No
- WMA/MP3/JPEG file playback on DVD+R/RW, DVD-R/RW: No

Compressed audio compatibility

- Compatible formats: MPEG-1 Audio Layer 3 (MP3), Windows Media Audio (WMA)
- Sampling rates: 32, 44.1 or 48kHz
- Bit-rates: Any (128Kbps or higher recommended)
- VBR (variable bit rate) MP3 playback: No
- VBR WMA playback: No
- WMA lossless encoding compatible: No

About WMA



The Windows Media[®] logo indicates that this player can playback Windows Media Audio content.

WMA is an acronym for Windows Media Audio and refers to an audio compression technology developed by Microsoft Corporation. WMA content can be encoded by using Windows Media[®] Player version 7, 7.1, Windows Media[®] Player for Windows[®] XP, or Windows Media[®] Player 9 Series.

Microsoft, Windows Media, and the Windows logo are trademarks, or registered trademarks of Microsoft Corporation in the United States and/ or other countries.

About DivX

DivX is a compressed digital video format created by the DivX[®] video codec from DivXNetworks, Inc. This player can play DivX video files burned on CD-R/RW/ROM discs. Keeping the same terminology as DVD-Video, individual DivX video files are called "Titles". When naming files/titles on a CD-R/RW disc prior to burning, keep in mind that by default they will be played in alphabetical order.

Displaying DivX subtitle files

The font sets listed below are available for DivX external subtitle files. You can see the proper font set on-screen by setting the **Subtitle Language** (in *Language settings* on page 31) to match the subtitle file.

This player supports the following language groups:

Group 1: Albanian (sq), Basque (eu), Catalan (ca), Danish (da), Dutch (nl), English (en), Faroese (fo), Finnish (fi), French (fr), German (de), Icelandic (is), Irish (ga), Italian (it), Norwegian (no), Portuguese (pt), Rhaeto-Romanic (rm), Scottish (gd), Spanish (es), Swedish (sv)

Group 2: Albanian (sq), Croatian (hr), Czech (cs), Hungarian (hu), Polish (pl), Romanian (ro), Slovak (sk), Slovenian (sl)

Group 3: Bulgarian (bg), Byelorussian (be), Macedonian (mk), Russian (ru), Serbian (sr), Ukrainian (uk)

Group 4: Hebrew (iw), Yiddish (ji)

Group 5: Turkish (tr)

DivX, DivX Certified, and associated logos are trademarks of DivXNetworks, Inc. and are used under license.

- Some external subtitle files may be displayed incorrectly or not at all.
- For external subtitle files the following subtitle format filename extensions are supported (please note that these files are not shown within the disc navigation menu): .srt, .sub, .ssa, .smi
- The filename of the movie file has to be repeated at the beginning of the filename for the external subtitle file.
- The number of external subtitle files which can be switched for the same movie file is limited to a maximum of 10.

DivX video compatibility



- Official DivX® Certified product.

- Plays DivX® 5, DivX® 4, DivX® 3 and DivX® VOD video content (in compliance with DivX® Certified technical requirements).
- File extensions: .avi and .divx (these must be used for the player to recognize DivX video files). *Note that all files with the .avi extension are recognized as MPEG4, but not all of these are necessarily DivX video files and therefore may not be playable on this player.*

DivX, DivX Certified, and associated logos are trademarks of DivXNetworks, Inc. and are used under license.

JPEG file compatibility

- Compatible formats: Baseline JPEG and EXIF 2.2* still image files up to a resolution of 3072 x 2048.
*File format used by digital still cameras
- Progressive JPEG compatible: No
- File extensions: .jpg (must be used for the player to recognize JPEG files – do not use for other file types)

PC-created disc compatibility

Discs recorded using a personal computer may not be playable in this unit due to the setting of the application software used to create the disc. In these particular instances, check with the software publisher for more detailed information.

Discs recorded in packet write mode (UDF format) are not compatible with this player.

Check the DVD+R/RW, DVD-R/RW or CD-R/RW software disc boxes for additional compatibility information.

Chapter 2

Connecting up

Easy connections

The setup described here is a basic setup that allows you to play discs using just the cables supplied with the player. In this setup, stereo audio is played through the speakers in your TV.

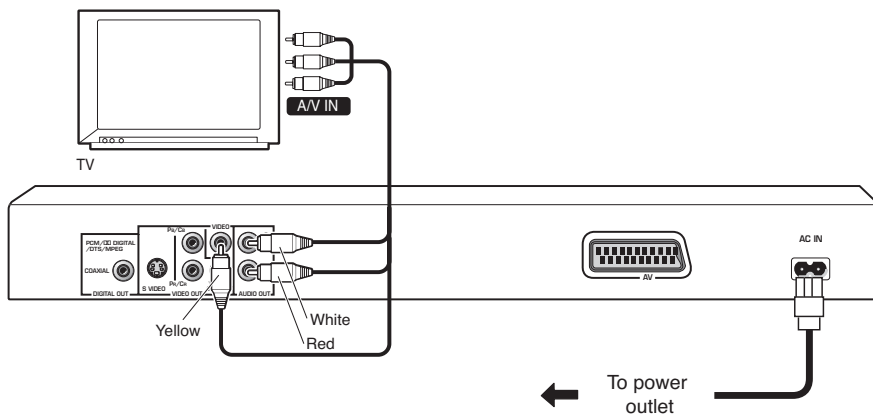

Important

- This player is equipped with copy protection technology. Do not connect this player to your TV via a VCR using audio/video or S-video cables, as the picture from this player will not appear properly on your TV. (This player may also not be compatible with some combination TV/VCRs for the same reason; refer to the manufacturer for more information.)

1 Connect the VIDEO OUT and AUDIO OUT L/R jacks to a set of A/V inputs on your TV.

Use the supplied audio/video cable, connecting the red and white plugs to the audio outputs and the yellow plug to the video output. Make sure you match up the left and right audio outputs with their corresponding inputs for correct stereo sound.

See below if you want to use a component or S-video cable for the video connection.

2 Connect the supplied AC power cable to the AC IN inlet, then plug into a power outlet.

Note

- Before unplugging the player from the power outlet, make sure you first switch it into standby using either the front panel **STANDBY/ON** button, or the remote control, and wait of the **-OFF-** message to disappear from the player's display.
- For the above reasons, do not plug this player into a switched power supply found on some amplifiers and AV receivers.

Connecting using a SCART AV cable

A SCART-type AV connector is provided for connection to a TV or AV receiver. The video output is switchable between ordinary composite and RGB. See *AV Connector Out* on page 31 for how to set it.

The SCART AV connector also outputs analog audio, so there is no need to also connect the **AUDIO OUT L/R** jacks.

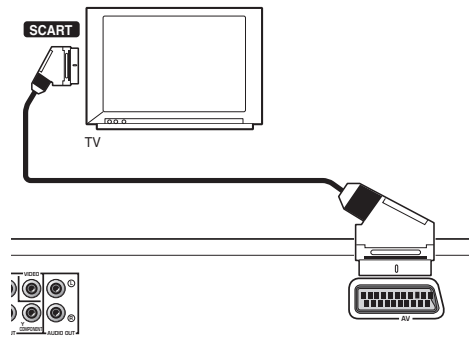

- 1 Use a SCART cable (not supplied) to connect the AV CONNECTOR (RGB) output to a SCART AV input on your TV (or AV receiver).

Connecting using the S-video output

If your TV (or other equipment) has an S-video (S1) input, you can use the S-video output on this player instead of the standard (composite) output for a better quality picture.

- Use an S-video cable (not supplied) to connect the S-VIDEO OUT to an S-video input on your TV (or monitor or AV receiver).

Line up the small triangle above the jack with the same mark on the plug before plugging in.

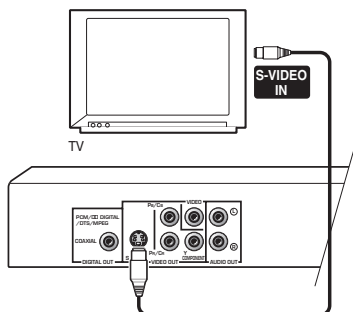

Watching progressive scan video from the component video outputs

This player can output progressive scan video from the component video output. Compared to interlace video, progressive scan video effectively doubles the scanning rate of the picture, resulting in a very stable, flicker-free image.

To set up the player for use with a progressive scan TV, see *Video Output settings* on page 31. When the player is set to output progressive scan video, the **PRGSVE** indicator lights in the front panel display.

Connecting using the component video output

You can use the component video output instead of the standard video out jack to connect this player to your TV (or other equipment). This should give you the best quality picture from the three types of video output available.

- Use a component video cable (not supplied) to connect the **COMPONENT VIDEO OUT** jacks to a component video input on your TV, monitor or AV receiver.

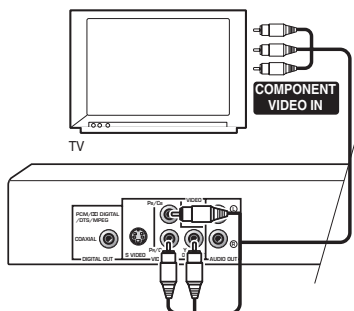

Important

- If you connect a TV that is not compatible with a progressive scan signal and switch the player to progressive, you will not be able to see any picture at all. In this case, switch everything off and reconnect using the supplied video cable (see *Easy connections* on page 8), then switch back to **Interlace** (see below).

Switching the video output to interlace using the front panel controls

Switch the player to standby then, using the front panel controls, press **STANDBY/ON** while pressing **◀◀** to switch the player back to **Interlace**.

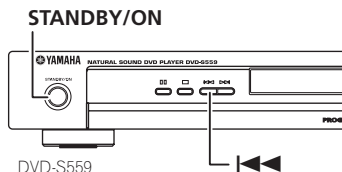

Compatibility of this player with progressive-scan and high-definition TVs

This player is compatible with progressive video Macro Vision System Copy Guard.

Consumers should note that not all high-definition television sets are fully compatible with this product and may cause artifacts to be displayed in the picture. In case of 525/625 progressive scan picture problems, it is recommended that the user switch the connection to the 'standard definition' output (Interlace). If there are questions regarding our TV set compatibility with this model, please contact our customer service center.

This player is fully compatible with the complete line of YAMAHA products, including the projectors DPX-1200, LPX-510 and the plasma monitor PDM-4220.

Connecting to an AV receiver

To enjoy multichannel surround sound you need to connect this player to an AV receiver using the digital audio output.

In addition to a digital connection, we recommend also connecting using the stereo analog connection.

You'll probably also want to connect a video output to your AV receiver. You can use any of the video outputs available on this player (the illustration shows a standard (composite) connection).

1 Connect the DIGITAL AUDIO OUT COAXIAL jack on this player to a coaxial digital input on your AV receiver.

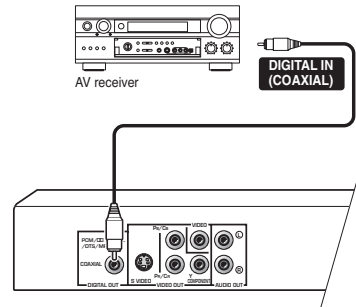

Use a coaxial cable (similar to the supplied video cable) to connect the **COAXIAL DIGITAL AUDIO OUT** jack to a coaxial input on your AV receiver.

2 Connect the analog AUDIO OUT L/R and VIDEO OUT jacks on this player to a set of analog audio and video inputs on your AV receiver.

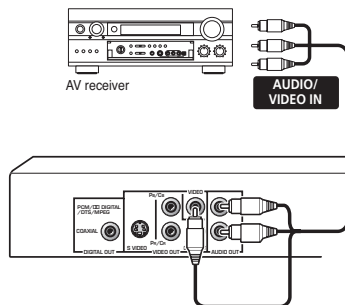

- You can use the SCART AV connector, or the S-video or component video jacks to connect to the AV receiver if you prefer.

Chapter 3

Controls and displays

Front panel

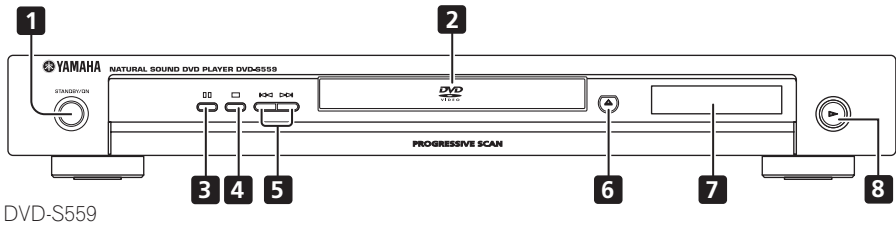

- 1 **STANDBY/ON** (page 14)
- 2 **Disc tray**
- 3 **||** (page 17)
- 4 **■** (page 17)
- 5 **◀◀ and ▶▶** (page 17)
- 6 **▶** (page 16)
- 7 **Display**
- 8 **▶** (page 17)

Remote control

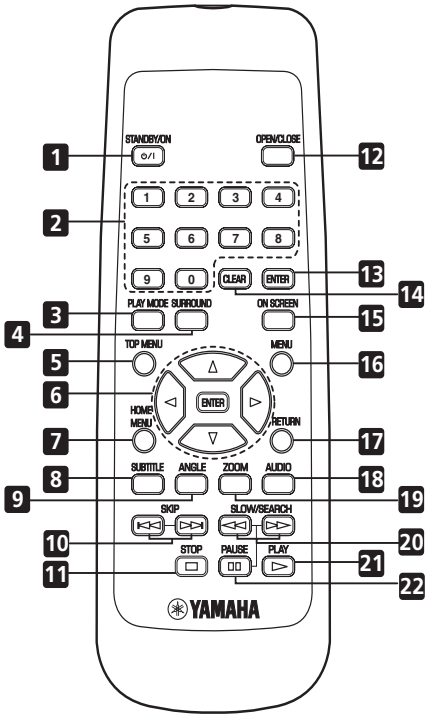

- 1 **⏻/| (STANDBY/ON)** (page 14)
- 2 **Number buttons** (page 17)
- 3 **PLAY MODE** (page 23)
- 4 **SURROUND** (page 28)
- 5 **TOP MENU** (page 18)
- 6 **ENTER & cursor buttons** (page 14)
- 7 **HOME MENU** (page 14)
- 8 **SUBTITLE** (page 26)
- 9 **ANGLE** (page 27)
- 10 **⏮ and ⏭ (SKIP)** (page 17)
- 11 **■ (STOP)** (page 17)
- 12 **OPEN/CLOSE** (page 16)

- 13 **ENTER** (page 14)
- 14 **CLEAR** (page 25)
- 15 **ON SCREEN** (page 27)
- 16 **MENU** (page 18)
- 17 **RETURN** (page 14)
- 18 **AUDIO** (page 27)
- 19 **ZOOM** (page 27)
- 20 **⏮ and ⏭ (SLOW/SEARCH)** (page 17, 20)
- 21 **▶ (PLAY)** (page 17)
- 22 **⏸ (PAUSE)** (page 17)

Using the remote control

Keep in mind the following when using the remote control:

- Make sure that there are no obstacles between the remote and the remote sensor on the unit.
- The remote has a range of about 7m.
- Remote operation may become unreliable if strong sunlight or fluorescent light is shining on the unit's remote sensor.
- Remote controllers for different devices can interfere with each other. Avoid using remotes for other equipment located close to this unit.
- Replace the batteries when you notice a fall off in the operating range of the remote.

Chapter 4

Getting started

Switching on

After making sure that everything is connected properly and that the player is plugged in, press **STANDBY/ON** on the front panel or remote control to switch the player on.

Also, switch on your TV and make sure that it is set to the input you connected the DVD player to.

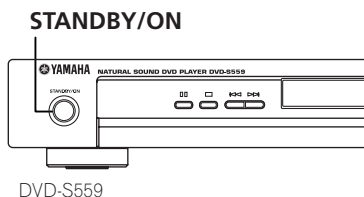

DVD-S559

FAQ

- My DVD player switches on but there is nothing displayed on my TV.

Make sure that the TV is set to the correct video input (not a TV channel). For example, if you connected this player to the **VIDEO 1** inputs on your TV, switch your TV to **VIDEO 1**.

Note

- This player features a screen saver and an auto power off function. If the player is stopped and no button is pressed for around five minutes, the screen saver starts. If the disc tray is closed but no disc is playing and no control is pressed for about 30 minutes, the player automatically goes into standby.

Using the on-screen displays

For ease of use, this player makes extensive use of graphical on-screen displays (OSDs).

All the screens are navigated in basically the same way, using the cursor buttons (Δ ∇ \triangleleft \triangleright) to change the highlighted item and pressing **ENTER** to select it.

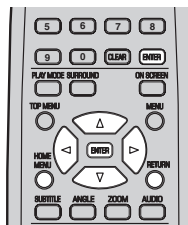

Button	What it does
HOME MENU	Display/exit the on-screen display.
Δ ∇ \triangleleft \triangleright	Changes the highlighted menu item.
ENTER	Selects the highlighted menu item (both ENTER buttons on the remote work in exactly the same way).
RETURN	Returns to the main menu without saving changes.

Note

- From here on in this manual, the word 'select' generally means use the cursor buttons to highlight an item on-screen, then press **ENTER**.

Setting up the player for your TV

If you have a widescreen (16:9) TV, you should setup the player so that the picture will be presented correctly. If you have a conventional (4:3) TV, you can leave the player on the default setting and move on to the next section.

1 Press HOME MENU and select 'Initial Settings'.



2 Select 'TV Screen' from the 'Video Output' settings.

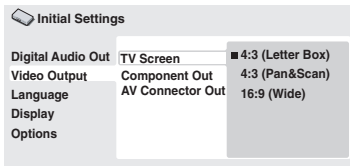

3 If you have a widescreen (16:9) TV, select '16:9 (Wide)'.

If you have a conventional (4:3) TV, you can change the setting from **4:3 (Letter Box)** to **4:3 (Pan & Scan)** if you prefer. See *Video Output settings* on page 31 for more details.

4 Press HOME MENU to exit the menu screen.

Setting the language of this player's on-screen displays

This sets the language of the player's on-screen displays.

1 Press HOME MENU and select 'Initial Settings'.

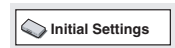

2 Select 'OSD Language' from the 'Display' settings.

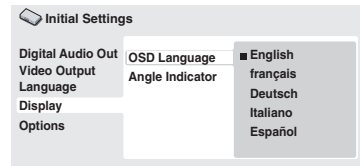

3 Select a language.

The on-screen language will change according to your selection.

4 Press HOME MENU to exit the menu screen.

Playing discs

The basic playback controls for playing DVD, CD, Video CD/Super VCD, DivX video and MP3/WMA discs are covered here. Further functions are detailed in the next chapter.

For details on playing JPEG picture discs, see *Viewing a JPEG slideshow* on page 21.

Important

- Throughout this manual, the term 'DVD' means DVD-Video, DVD+R/RW and DVD-R/RW. If a function is specific to a particular kind of DVD disc, it is specified.

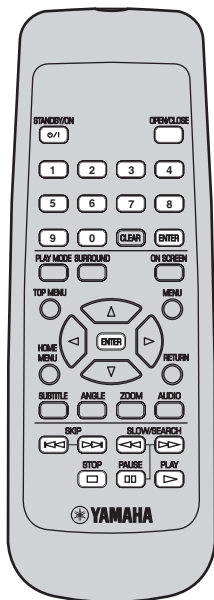

- 1 If the player isn't already on, press **STANDBY/ON** to switch it on.

If you're playing a DVD, disc containing DivX video files or Video CD/Super VCD, also turn on your TV and make sure that it is set to the correct video input.

- 2 Press **OPEN/CLOSE** to open the disc tray.

- 3 Load a disc.

Load a disc with the label side facing up, using the disc tray guide to align the disc (if you're loading a double-sided DVD disc, load it with the side you want to play face down).

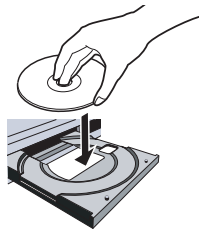

- 4 Press **▶ (play)** to start playback.

If you're playing a DVD or Video CD/Super VCD, an on-screen menu may appear. See *DVD-Video disc menus* on page 18 and *Video CD/Super VCD PBC menus* on page 18 for more on how to navigate these.

- If you're playing a containing DivX video files or MP3/WMA audio files, it may take a few seconds before playback starts, etc. This is normal.

Note

- You may find with some DVD discs that some playback controls don't work in certain parts of the disc. This is not a malfunction.
- If a disc contains a mixture of DivX video and other media file types (MP3, for example), first select whether to play the DivX video files (**DivX**) or the other media file types (**MP3 / WMA / JPEG**) from the on-screen display.

Basic playback controls

The table below shows the basic controls on the remote for playing discs. The following chapter covers other playback features in more detail.

Button	What it does
▶	Starts playback. If the display shows RESUME or LAST MEM playback starts from the resume or last memory point (see also <i>Resume and Last Memory</i> below.)
	Pauses a disc that's playing, or restarts a paused disc.
■	Stops playback. See also <i>Resume and Last Memory</i> below.
◀◀ (remote only)	Press to start fast reverse scanning. Press ▶ (play) to resume normal playback.
▶▶ (remote only)	Press to start fast forward scanning. Press ▶ (play) to resume normal playback.
◀◀	Skips to the start of the current track, title or chapter, then to previous tracks/titles/chapters.
▶▶	Skips to the next track, title or chapter.
Numbers (remote only)	Use to enter a title/chapter/track number. Press ENTER to select. <ul style="list-style-type: none"> • If the disc is stopped, playback starts from the selected title (for DVD) or track (for CD/Video CD/ Super VCD). • If the disc is playing, playback jumps to the start of the selected title (VR mode DVD-RW), chapter (DVD-Video) or track (CD/Video CD/ Super VCD).

Resume and Last Memory

When you stop playback of a DVD, CD, Video CD/Super VCD or DivX video discs, **RESUME** is shown in the display indicating that you can resume playback again from that point.

If the disc tray is not opened, the next time you start playback the display shows **RESUME** and playback resumes from the resume point. (If you want to clear the resume point, press ■ (stop) while **RESUME** is displayed.)

With DVDs and Video CD/ Super VCDs, if you take the disc out of the player after stopping playback, the last play position is stored in memory. If the next disc you load is the same one, the display shows **LAST MEM** and playback will resume. For DVD-Video discs, the player stores the play position of the last five discs. When one of these discs is next loaded, you can resume playback.

Note

- The Last Memory function doesn't work with VR format DVD-RW discs.
- If you don't need the Last Memory function when you stop a disc, you can press **OPEN/CLOSE** (▲) to stop playback and open the disc tray.

DVD-Video disc menus

Many DVD-Video discs feature menus from which you can select what you want to watch. They may also give access to additional features, such as subtitle and audio language selection, or special features such as slideshows. See the disc packaging for details. Sometimes DVD-Video menus are displayed automatically when you start playback; others only appear when you press **MENU** or **TOP MENU**.

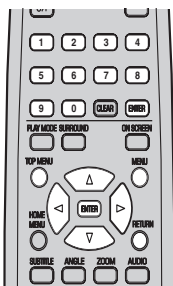

Button	What it does
TOP MENU	Displays the 'top menu' of a DVD disc—this varies with the disc.
MENU	Displays a DVD disc menu—this varies with the disc and may be the same as the 'top menu'.
△ ▽ ◀ ▶	Moves the cursor around the screen.
ENTER	Selects the current menu option.
RETURN	Returns to the previously displayed menu screen.
Numbers (remote only)	Highlights a numbered menu option (some discs only). Press ENTER to select.

Video CD/Super VCD PBC menus

Some Video CD/Super VCDs have menus from which you can choose what you want to watch. These are called PBC (Playback control) menus.

You can play a PBC Video CD/Super VCD without having to navigate the PBC menu by starting playback using a number button to select a track, rather than the ► (play) button.

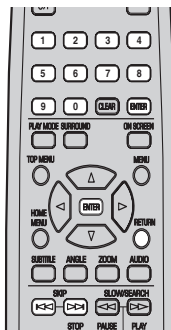

Button	What it does
RETURN	Displays the PBC menu.
Numbers (remote only)	Use to enter a numbered menu option. Press ENTER to select.
◀◀	Displays the previous menu page (if there is one).
▶▶	Displays the next menu page (if there is one).



FAQ

- *After I load a DVD disc, it ejects automatically after a few seconds!*

Most likely, the disc is the wrong region for your player. The region number should be printed on the disc; check it against the region number of the player (which you can find on the rear panel). See also *DVD-Video regions* on page 37.

If the region number is OK, it may be that the disc is damaged or dirty. Clean the disc and look for signs of damage. See also *Taking care of your player and discs* on page 35.

- *Why won't the disc I loaded play?*

First check that you loaded the disc the right way up (label side up), and that it's clean and undamaged. See *Taking care of your player and discs* on page 35 for information on cleaning discs.

If a disc loaded correctly won't play, it's probably an incompatible format or disc type, such as DVD-Audio or DVD-ROM. See *Disc/content format playback compatibility* on page 5 for more on disc compatibility.

- *I have a widescreen TV so why are there black bars at the top and bottom of the screen when I play some discs?*

Some movie formats are such that even when played on a widescreen TV, black bars are necessary at the top and bottom of the screen. This is not a malfunction.

- *I have a standard (4:3) TV and set the player to show widescreen DVDs in pan & scan format, so why do I still get black bars top and bottom with some discs?*

Some discs override the display preferences of the player, so even if you have **4:3 (Pan & Scan)** selected, those discs will still be shown in letter box format. This is not a malfunction.

Chapter 5

Playing discs

Note

- Many of the functions covered in this chapter apply to DVD discs, Video CDs/Super VCDs, CDs, DivX video and WMA/MP3 JPEG discs, although the exact operation of some varies slightly with the kind of disc loaded.
- Some DVDs restrict the use of some functions (random or repeat, for example) in some or all parts of the disc. This is not a malfunction.
- When playing Video CD/Super VCDs, some of the functions are not available during PBC playback. If you want to use them, start the disc playing using a number button to select a track.

Scanning discs

You can fast-scan discs forward or backward at four different speeds (DivX video only one speed).

1 During playback, press ◀◀ or ▶▶ to start scanning.

- There is no sound while scanning DVDs, DivX video and Video CD/Super VCDs.

2 Press repeatedly to increase the scanning speed.

- The scanning speed is shown on-screen except when playing a WMA/MP3 track using the Disc Navigator.

3 To resume normal playback, press ▶ (play).

- When scanning a Video CD/Super VCD playing in PBC mode or a WMA/MP3 track, playback automatically resumes at the end or beginning of the track.
- Depending on the disc, normal playback may automatically resume when a new chapter is reached on a DVD disc.

Playing in slow motion

You can play DVDs at four different slow motion speeds, forwards and backwards. Video CD/Super VCDs and DivX video can be played at four different forward slow motion speeds.

1 During playback, press II (pause).

2 Press and hold ◀◀ or ▶▶ until slow motion playback starts.

- The slow motion speed is shown on-screen.
- There is no sound during slow motion playback.

3 Press repeatedly to change the slow motion speed.

4 To resume normal playback, press ▶ (play).

- Depending on the disc, normal playback may automatically resume when a new chapter is reached.

Frame advance/frame reverse

You can advance or back up DVD discs frame-by-frame. With Video CD/Super VCDs and DivX video file you can only use frame advance.

- 1 During playback, press II (pause).**
- 2 Press ◀◀ or ▶▶ to reverse or advance a frame at a time.**
- 3 To resume normal playback, press ▶ (play).**
 - Depending on the disc, normal playback may automatically resume when a new chapter is reached.

Viewing a JPEG slideshow

After loading a CD/CD-R/RW containing JPEG picture files, press ▶ (play) to start a slideshow from the first folder/picture on the disc. The player displays the pictures in each folder in alphabetical order.

Pictures are automatically adjusted so that they fill as much of the screen as possible (if the aspect ratio of the picture is different to your TV screen you may notice black bars at the sides, or at the top and bottom of the screen).

While the slideshow is running:

Button	What it does
II	Pauses the slideshow; press again to restart.
◀◀	Displays the previous picture.
▶▶	Displays the next picture.
◁▷	Pauses the slideshow and rotates the displayed picture 90° (counter) clockwise. (Press ▶ (play) to restart slideshow).
△▽	Pauses the slideshow and flips the displayed picture horizontally or vertically. (Press ▶ (play) to restart slideshow).

Button	What it does
ZOOM	Pauses the slideshow and zooms the picture. Press again to toggle between 1x, 2x and 4x zoom. (Press ▶ (play) to restart slideshow).
MENU	Displays the Disc Navigator screen (see below).



Note

- The time it takes for the player to load a file increases with large file sizes.

Browsing DVD or Video CD/ Super VCD disc with the Disc Navigator

Use the Disc Navigator to browse through the contents of a DVD or Video CD/Super VCD disc to find the part you want to play.



Important

- You can't use the Disc Navigator with Video CD/Super VCDs in PBC mode.

- 1 During playback, press HOME MENU and select 'Disc Navigator' from the on-screen menu.**

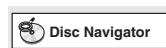

- 2 Select a view option.**

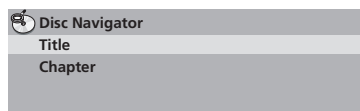

The options available depend on the kind of disc loaded and whether the disc is playing or not, but include:

- **Title** – Titles from a DVD-Video disc.
- **Chapter** – Chapters from the current title of a DVD-Video disc.
- **Track** – Tracks from a Video CD/Super VCD disc.
- **Time** – Thumbnails from a Video CD/Super VCD disc at 10 minute intervals.
- **Original: Title** – Original titles from a VR mode DVD-RW disc.
- **Playlist: Title** – Playlist titles from a VR mode DVD-RW disc.
- **Original: Time** – Thumbnails from the Original content at 10 minute intervals.
- **Playlist: Time** – Thumbnails from the Playlist at 10 minute intervals.

The screen shows up to six moving thumbnail images displayed one after another. To display the previous/next six thumbnails, press **◀◀**/**▶▶** (you don't have to wait for all the thumbnails to finish playing to display the previous/next page).

3 Select the thumbnail image for what you want to play.

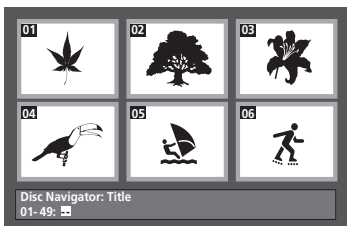

You can use either the cursor buttons (**△▽◀▶**) and **ENTER** to select a thumbnail, or the number buttons.

To select using the number buttons, enter a two-digit number then press **ENTER**.



Tip

- Another way to find a particular place on a disc is to use one of the search modes. See *Searching a disc* on page 26.

Browsing WMA, MP3, DivX video and JPEG files with the Disc Navigator

Use the Disc Navigator to find a particular file or folder by filename. Note that if there are other types of files on the same disc, these will not be displayed in the Disc Navigator.

1 Press HOME MENU and select 'Disc Navigator' from the on-screen menu.

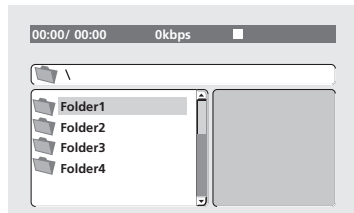

2 Use the cursor buttons (**△▽◀▶**) and **ENTER** to navigate.

Use the cursor up/down buttons (**△▽**) to move up and down the folder/file list.

Use the cursor left button (**◀**) to return to the parent folder.

Use **ENTER** or cursor right (**▶**) to open a highlighted folder.

- You can also return to the parent folder by going to the top of the list to the '..' folder, then pressing **ENTER**.

- When a JPEG file is highlighted, a thumbnail image is displayed on the right.

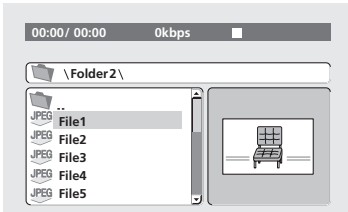

3 To play the highlighted track or DivX video file or display the highlighted JPEG file, press ENTER.

- When a WMA/MP3 or DivX video file is selected, playback begins, starting with the selected file, and continues until the end of the folder.
- When a JPEG file is selected, a slideshow begins, starting with that file, and continues to the end of the folder. When the slideshow comes to the end of the folder, it automatically continues to the beginning of the folder.



Tip

- To play the contents of the whole disc rather than just the current folder, exit the Disc Navigator and start playback using the ► (play) button.

Looping a section of a disc

The A-B Repeat function allows you to specify two points (A and B) within a track (CD, Video CD/Super VCD) or title (DVD) that form a loop which is played over and over.

- You can't use A-B Repeat with Video CD/Super VCDs in PBC mode, or WMA/MP3/DivX video files.

1 During playback, press PLAY MODE and select 'A-B Repeat' from the list of functions on the left.

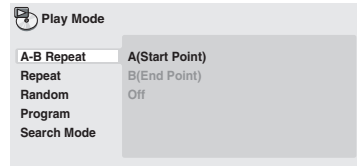

2 Press ENTER on 'A(Start Point)' to set the loop start point.

3 Press ENTER on 'B(End Point)' to set the loop end point.

After pressing **ENTER**, playback jumps back to the start point and plays the loop.

4 To resume normal playback, select 'Off' from the menu.

Using repeat play

There are various repeat play options, depending on the kind of disc loaded. It's also possible to use repeat play together with program play to repeat the tracks/chapters in the program list (see *Creating a program list* on page 25).



Important

- You can't use Repeat play with Video CD/Super VCDs in PBC mode, or with WMA/MP3 discs.
- You can't use repeat and random play at the same time.

1 During playback, press PLAY MODE and select 'Repeat' from the list of functions on the left.

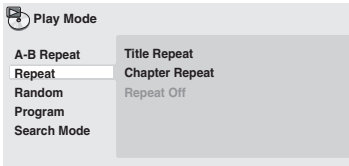

2 Select a repeat play option.
If program play is active, select **Program Repeat** to repeat the program list, or **Repeat Off** to cancel.

The repeat options available depend on the kind of disc loaded. For example, for DVD discs, you can select **Title Repeat** or **Chapter Repeat** (or **Repeat Off**).

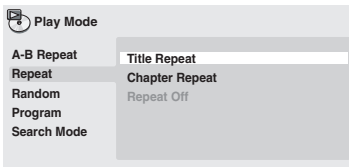

- For CDs and Video CD/Super VCDs, select **Disc Repeat** or **Track Repeat** (or **Repeat Off**).
- For DivX video discs, select **Title Repeat** (or **Repeat Off**).

Using random play

Use the random play function to play titles or chapters (DVD-Video), or tracks (CD, Video CD/Super VCD) at random. (Note that the same track/title/chapter may play more than once.)

You can set the random play option when a disc is playing or stopped.

Important

- Random play remains in effect until you select **Random Off** from the random play menu options.
- You can't use random play with VR format DVD-RW discs, Video CD/Super VCDs playing in PBC mode, WMA/MP3 discs, DivX video discs, or while a DVD disc menu is being displayed.
- You can't use random play together with program or repeat play.

1 Press PLAY MODE and select 'Random' from the list of functions on the left.

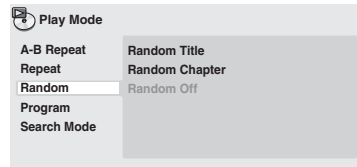

2 Select a random play option.

The random play options available depend on the kind of disc loaded. For example, for DVD discs, you can select **Random Title** or **Random Chapter** (or **Random Off**).

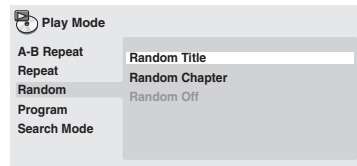

- For CDs and Video CD/Super VCDs, select **On** or **Off** to switch random play on or off.

**Tip**

- Use the following controls during random play:

Button	What it does
▶▶	Selects a new track/title/chapter at random.
◀◀	Returns to the beginning of the current track/title/chapter.

Creating a program list

This feature lets you program the play order of titles/chapters/tracks on a disc.

**Important**

- You can't use Program play with VR format DVD-RW discs, Video CD/Super VCDs playing in PBC mode, WMA/MP3 discs, DivX video discs, or while a DVD disc menu is being displayed.

1 Press **PLAY MODE** and select '**Program**' from the list of functions on the left.

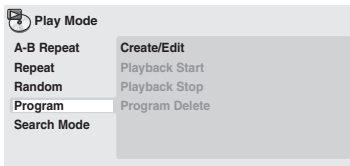

2 Select '**Create/Edit**' from the list of program options.

3 Use the cursor buttons and **ENTER** to select a title, chapter or track for the current step in the program list.

For a DVD disc, you can add a title or a chapter to the program list.

Program Step	Title 1-38	Chapter 1-004
01. 01	Title 01	Chapter 001
02.	Title 02	Chapter 002
03.	Title 03	Chapter 003
04.	Title 04	Chapter 004
05.	Title 05	
06.	Title 06	
07.	Title 07	
08.	Title 08	

- For a CD or Video CD/Super VCD, select a track to add to the program list.

After pressing **ENTER** to select the title/chapter/track, the step number automatically moves down one.

4 Repeat step 3 to build up a program list.

A program list can contain up to 24 titles/chapters/tracks.

- You can insert steps into the middle of a program list by just highlighting the position where you want the new step to appear and entering a title/chapter/track number.
- To delete a step, highlight it and press **CLEAR**.

5 To play the program list, press **▶ (play)**.

Program play remains active until you turn off program play (see below), erase the program list (see below), eject the disc or switch off the player.



Tip

- Use the following controls during program play:

Button	What it does
PLAY MODE	Save the program list and exit the program edit screen without starting playback (HOME MENU does the same).
▶▶	Skip to the next step in the program list.

Other functions available from the program menu

There are a number of other options in the program menu in addition to Create/Edit.

- **Playback Start** – Starts playback of a saved program list
- **Playback Stop** – Turns off program play, but does not erase the program list
- **Program Delete** – Erases the program list and turns off program play

Searching a disc

You can search DVD discs by title or chapter number, or by time; CDs and Video CD/Super VCDs by track number or time; DivX video discs by time.



Important

- Search functions are not available with Video CD/Super VCDs in PBC mode, or with WMA/MP3 discs.

1 Press PLAY MODE and select 'Search Mode' from the list of functions on the left.

2 Select a search mode.

The search options available depend on the kind of disc loaded.

- The disc must be playing in order to use time search.

3 Use the number buttons to enter a title, chapter or track number, or a time.

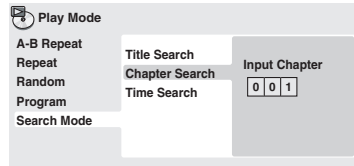

- For a time search, enter the number of minutes and seconds into the currently playing title (DVD/ DivX video) or track (CD/ Video CD/Super VCD) you want playback to resume from. For example, press **4, 5, 0, 0** to have playback start from 45 minutes into the disc. For 1 hour, 20 minutes and 30 seconds, press **8, 0, 3, 0**.

4 Press ENTER to start playback.

Switching subtitles

Some DVD and DivX video discs have subtitles in one or more languages; the disc box will usually tell you which subtitle languages are available. You can switch subtitle language during playback.

1 Press SUBTITLE repeatedly to select a subtitle option.

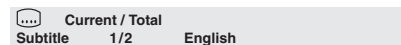

Note

- Some discs only allow you to change subtitle language from the disc menu. Press **TOP MENU** or **MENU** to access.
- To set subtitle preferences, see *Subtitle Language* on page 31.
- See *Displaying DivX subtitle files* on page 7 for more on DivX subtitles.

Switching audio language/channels

When playing a DVD and DivX video disc recorded with dialog in two or more languages, you can switch audio language during playback.

When playing a VR format DVD-RW disc recorded with dual-mono audio, you can switch between the main, sub, and mixed channels during playback.

When playing a Video CD/Super VCD, you can switch between stereo, just the left channel or just the right channel.

1 Press **AUDIO** repeatedly to select an audio language/channel option.

The language/channel information is shown on-screen.



Note

- Some DVD discs only allow you to change audio language from the disc menu. Press **TOP MENU** or **MENU** to access.
- To set DVD audio language preferences, see *Language settings* on page 31.

Zooming the screen

Using the zoom feature you can magnify a part of the screen by a factor of 2 or 4, while watching a DVD, DivX video title or Video CD/Super VCD or playing a JPEG disc.

1 During playback, use the **ZOOM** button to select the zoom factor (Normal, 2x or 4x).

- Since DVD, Video CD/Super VCD, DivX video title and JPEG pictures have a fixed resolution, picture quality will deteriorate, especially at 4x zoom. This is not a malfunction.

2 Use the cursor buttons to change the zoomed area.

You can change the zoom factor and the zoomed area freely during playback.

- If the navigation square at the top of the screen disappears, press **ZOOM** again to display it.

Switching camera angles

Some DVD discs feature scenes shot from two or more angles—check the disc box for details.

When a multi-angle scene is playing, a  icon appears on screen to let you know that other angles are available (this can be switched off if you prefer—see *Display settings* on page 32).

1 During playback (or when paused), press **ANGLE** to switch angle.

Displaying disc information

Various track, chapter and title information, such as the elapsed and remaining playing time can be displayed on-screen while a disc is playing.

1 To show/switch/hide the information displayed, press **ON SCREEN** repeatedly.

- When a disc is playing, the information appears at the top of the screen. Keep pressing **ON SCREEN** to change the displayed information.

Chapter 6

Audio Settings and Video Adjust menus

Audio Settings menu

The Audio Settings menu offers features for adjusting the way discs sound.

- 1 Press **HOME MENU** and select 'Audio Settings' from the on-screen display.



- 2 Select and change settings using the cursor buttons (Δ ∇ \triangleleft \triangleright), and **ENTER**.

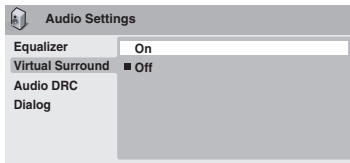

Audio DRC

- Settings: **High, Medium, Low, Off** (default)

When watching Dolby Digital DVDs at low volume, it's easy to lose the quieter sounds completely—including some of the dialog. Switching Audio DRC (Dynamic Range Control) to on can help by bringing up the quieter sounds, while controlling loud peaks.

How much of a difference you hear depends on the material you're listening to. If the material doesn't have wide variations in volume, you may not notice much change.

Note

- Audio DRC is only effective with Dolby Digital audio sources.

- Audio DRC is only effective through the digital output when **Digital Out** is set to **On**, and **Dolby Digital Out** is set to **Dolby Digital > PCM** (see *Digital Audio Out settings* on page 30).
- The effect of Audio DRC also depends on your speakers and AV receiver settings.

Virtual Surround

- Settings: **On, Off** (default)

Switch on Virtual Surround to enjoy realistic surround sound effects from just two speakers.

Tip

- You can also use the **SURROUND** button on the remote control to switch Virtual Surround on.

Note

- Virtual Surround doesn't work with DTS, through either the analog or digital outputs.
- 96kHz linear PCM audio is automatically downsampled to 48kHz if Virtual Surround is switched on.
- If the player is outputting Dolby Digital, DTS or MPEG bitstream audio (in other words, no conversion to PCM), Virtual Surround has no effect on the audio from the digital output. See *Digital Audio Out settings* on page 30 for how to set up the digital output formats.
- How good the surround effect is varies with the disc.

Dialog

- Settings: **High, Medium, Low, Off** (default)

The Dialog feature is designed to make the dialog stand out from other background sounds in the soundtrack.

Equalizer

- Settings: **Rock, Pop, Live, Dance, Techno, Classic, Soft, Off** (default)

The various preset EQ curves are designed to suit various styles of music.



Note

- 96kHz linear PCM audio is automatically downsampled to 48kHz if the Equalizer is switched on.

Video Adjust menu

From the Video Adjust screen you can adjust various settings that affect how the picture is presented.

1 Press HOME MENU and select 'Video Adjust' from the on-screen display.



2 Make settings using the cursor buttons (Δ ∇ \triangleleft \triangleright), and ENTER.

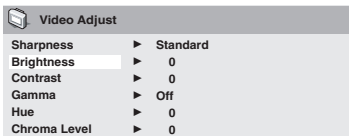

You can adjust the following picture quality settings:

- **Sharpness** – Adjusts the sharpness of edges in the picture (**Fine, Standard** (default), **Soft**).
- **Brightness** – Adjusts the overall brightness (**-20** to **+20**).

- **Contrast** – Adjusts the contrast between light and dark (**-16** to **+16**).
- **Gamma** – Adjusts the 'warmth' of the picture (**High, Medium, Low, Off** (default)).
- **Hue** – Adjusts the red/green balance (**Green 9** to **Red 9**).
- **Chroma Level** – Adjusts how saturated colors appear (**-9** to **+9**).

Adjust the Brightness, Contrast, Hue and Chroma Level settings using the cursor left/right (\triangleleft \triangleright) buttons.



3 Press ENTER to return to the Video Adjust screen, or HOME MENU to exit.

Chapter 7

Initial Settings menu

Using the Initial Settings menu

The Initial Settings menu provides audio and video output settings, parental lock settings, and display settings, among others.

If an option is grayed out it means that it cannot be changed at the current time. This is usually because a disc is playing. Stop the disc, then change the setting.

1 Press HOME MENU and select 'Initial Settings'.

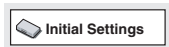

2 Use the cursor buttons and ENTER to select the setting and option you want to set.

All the settings and options are explained on the following pages.

Note

- In the table below, the default setting is shown in **bold**; other settings are shown in *italics*.
- The Digital Audio Out settings only need to be set if you have connected the digital output of this player to an AV receiver, or other equipment.
- Check the owner's manual supplied with your other equipment to see which digital audio formats it's compatible with.
- Some settings, such as **TV Screen**, **Audio Language** and **Subtitle Language** may be overridden by the DVD disc. Often these settings can also be made from the DVD disc menu.

Digital Audio Out settings

Setting	Option	What it means
Digital Out	On	Digital audio is output from the digital outputs.
	<i>Off</i>	No digital audio output.
Dolby Digital Out	Dolby Digital	Dolby Digital encoded digital audio is output when playing a Dolby Digital DVD disc.
	<i>Dolby Digital > PCM</i>	Dolby Digital audio is converted to PCM audio before being output.
DTS Out	DTS	DTS encoded digital audio is output when playing a DTS disc. (Noise will be output if your amplifier/receiver is not compatible with DTS audio.)
	<i>Off</i>	No digital audio is output when playing a DTS disc.
96 kHz PCM Out	96kHz > 48kHz	96kHz digital audio is converted to 48kHz for digital output.
	<i>96kHz</i>	96kHz digital audio is output as is at 96kHz.

Setting	Option	What it means
MPEG Out	MPEG > PCM	MPEG encoded digital audio is converted to PCM audio for digital output.
	MPEG	MPEG encoded digital audio is output as is.

Video Output settings

Setting	Option	What it means
TV Screen (See also <i>Screen sizes and disc formats</i> on page 36.)	4:3 (Letter Box)	Set if you have a conventional 4:3 TV. Widescreen movies are shown with black bars top and bottom.
	4:3 (Pan & Scan)	Set if you have a conventional 4:3 TV. Widescreen movies are shown with the sides cropped so that the image fills the screen.
	16:9 (Wide)	Set if you have a widescreen TV.
Component Out	Interlace	Set if your TV is not compatible with progressive scan video.
	Progressive	Set if your TV is compatible with progressive scan video (see your TV's instruction manual for details). See also <i>Switching the video output to interlace using the front panel controls</i> on page 10. <i>Note that progressive scan video is only output from the component video jacks.</i>
AV Connector Out	Video	Ordinary (composite) video output, compatible with all TVs.
	RGB	If your TV is compatible, this setting gives the best picture quality. <i>Note that there is no output from the component jacks when this setting is selected.</i>

Language settings

Setting	Option	What it means
Audio Language	English	If there is an English soundtrack on the disc then it will be played.
	Languages as displayed	If there is the language selected on the disc, then it will be played.
	Other Language	Select to choose a language other than the ones displayed (see page 37).
Subtitle Language (See also <i>Displaying DivX subtitle files</i> on page 7.)	English	If there are English subtitles on the disc then they will be displayed.
	Languages as displayed	If there is the subtitle language selected on the disc, then it will be displayed.
	Other Language	Select to choose a language other than the ones displayed (see page 37).

Setting	Option	What it means
DVD Menu Lang.	w/Subtitle Lang.	DVD disc menus will be displayed in the same language as your selected subtitle language, if possible.
	<i>Languages as displayed</i>	DVD disc menus will be displayed in the selected language, if possible.
	<i>Other Language</i>	Select to choose a language other than the ones displayed (see page 37).
Subtitle Display	On	Subtitles are displayed according to your selected subtitle language (see above).
	Off	Subtitles are always off by default when you play a DVD disc (note that some discs override this setting).

Display settings

Setting	Option	What it means
OSD Language	English	On-screen displays of the player are in English.
	<i>Languages as displayed</i>	On-screen displays are shown in the language selected.
Angle Indicator	On	A camera icon is displayed on-screen during multi-angle scenes on a DVD disc.
	Off	No multi-angle indication is shown.

Options settings

Setting	Option	What it means
Parental Lock	–	See <i>Parental Lock</i> on page 33.
DivX VOD	Display	See <i>About DivX® VOD content</i> on page 34.

Parental Lock

- Default level: **Off**; Default password: *none*;
Default Country/Area code: **us (2119)**

To give you some control over what your children watch on your DVD player, some DVD-Video discs feature a Parental Lock level. If your player is set to a lower level than the disc, the disc won't play.

Some discs also support the Country/Area Code feature. The player does not play certain scenes on these discs, depending on the Country/Area Code you set.



Note

- Not all discs use Parental Lock, and will play without requiring the password first.
- If you forget your password, you'll need to reset the player to register a new password. (see *Resetting the player* on page 37)

Registering a new password

You must register a password before you can change the Parental Lock level or enter a Country code.

1 Select 'Options', then 'Password'.

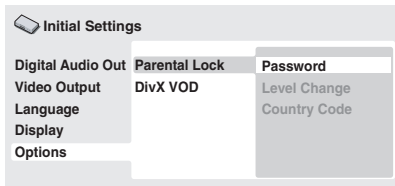

2 Use the number buttons to enter a 4-digit password.

The numbers you enter show up as asterisks (*) on-screen.

3 Press ENTER to register the password.

You will return to the Options menu screen.

Changing your password

To change your password, confirm your existing password then enter a new one.

1 Select 'Password Change'.

2 Use the number buttons to enter your existing password, then press ENTER.

3 Enter a new password and press ENTER.

This registers the new password and you will return to the Options menu screen.

Setting/changing the Parental Lock

1 Select 'Level Change'.

2 Use number buttons to enter your password, then press ENTER.

3 Select a new level and press ENTER.

- Press the cursor left (◀) repeatedly to lock more levels (more discs will require the password); press the cursor right (▶) to unlock levels. You can't lock level 1.

This sets the new level and you will return to the Options menu screen.

Setting/changing the Country/Area code

You can find the *Country/Area code list* on page 38.

1 Select 'Country Code'.

2 Use number buttons to enter your password, then press ENTER.

3 Select a Country/Area code and press ENTER.

There are two ways you can do this:

- Select by code letter: Use the cursor up/ down (△▽) to change the Country/Area code.
- Select by code number: Press the cursor right (▶) then use the number buttons to enter the 4-digit Country/Area code.

The new Country/Area code is set and you will return to the Options menu screen. Note that the new Country/Area code doesn't take effect until the next disc is loaded (or the current disc is reloaded).

About DivX® VOD content

In order to play DivX VOD (video on demand) content on this player, you first need to register the player with your DivX VOD content provider. You do this by generating a DivX VOD registration code, which you submit to your provider.



Important

- DivX VOD content is protected by a DRM (Digital Rights Management) system. This restricts playback of content to specific, registered devices.
- If you load a disc that contains DivX VOD content not authorized for your player, the message **Authorization Error** is displayed and the content will not play.
- Resetting the player (page 37) will not cause you to lose your registration code.

Displaying your DivX VOD registration code

- 1 Press HOME MENU and select 'Initial Settings'.
- 2 Select 'Options', then 'DivX VOD'.

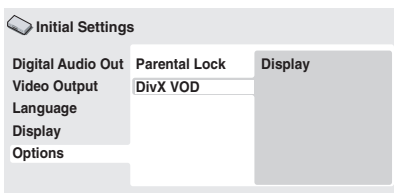

3 Select 'Display'.

Your 8-digit registration code is displayed.

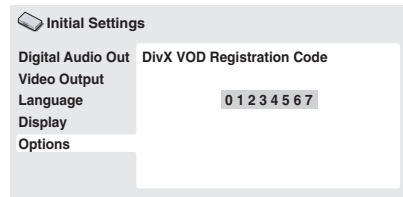

Make a note of the code as you will need it when you register with a DivX VOD provider.

Playing DivX® VOD content

Some DivX VOD content may only be playable a fixed number of times. When you load a disc containing this type of DivX VOD content, the remaining number of plays is shown on-screen and you then have the option of playing the disc (thereby using up one of the remaining plays), or stopping. If you load a disc that contains expired DivX VOD content (for example, content that has zero remaining plays), the message **Rental Expired** is displayed.

If your DivX VOD content allows an unlimited number of plays, then you may load the disc into your player and play the content as often as you like, and no message will be displayed.

Chapter 8

Additional information

Taking care of your player and discs

General

Hold discs by the edge or by the center hole and edge.

When you're not using a disc, return it to its case and store upright. Avoid leaving discs in excessively cold, humid, or hot environments (including under direct sunlight).

Don't glue paper or put stickers on to discs. Do not use a pencil, ball-point pen or other sharp-tipped writing instrument to write on the disc.



Don't use self-adhesive disc labels on discs as these can cause the disc to warp slightly during playback causing distortion in the picture and/or sound.

Damaged and shaped discs

Do not use cracked, chipped, warped, or otherwise damaged discs as they may damage the player.

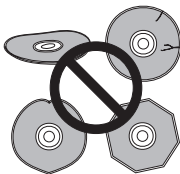

This player is designed to be used only with conventional, fully circular discs. Do not use shaped discs. YAMAHA disclaims all liability arising in connection with the use of shaped discs.

Cleaning discs

Fingerprints and dust on discs can affect playback performance. Clean using a soft, dry cloth, wiping the disc lightly from the center to the outside edge as shown below.

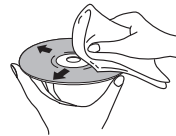

If necessary, use a cloth soaked in alcohol, or a commercially available CD/DVD cleaning kit to clean a disc more thoroughly. Never use benzene, thinner or other cleaning agents, including products designed for cleaning vinyl records.

Cleaning the unit's exterior

Unplug the unit before cleaning.

Use a dry cloth to wipe off dust and dirt. If the surfaces are very dirty, wipe with a soft cloth dipped in some neutral cleanser diluted five or six times with water and wrung out well, then wipe again with a dry cloth.

Do not use furniture wax or cleaners. Never use thinners, benzene or insecticide sprays or other chemicals on or near this unit.

If you use a chemical-impregnated cleaning cloth, read the instructions carefully before use. These cloths may leave smear marks on half-mirror finish surfaces; if this happens, finish with a dry cloth.

Cleaning the pickup lens

The DVD player's lens should not become dirty in normal use, but if for some reason it should malfunction due to dust or dirt, consult your nearest YAMAHA authorized service center. We do not recommend using commercially available lens cleaners for CD players.

Condensation

Condensation may form inside the player if it is brought into a warm room from outside, or if the temperature of the room rises quickly. Although the condensation won't damage the player, it may temporarily impair its performance. Leave it to adjust to the warmer temperature for about an hour before switching on.

Moving the player

If you need to move the player, first press **STANDBY/ON** on the front panel to turn the player off. Wait for **-OFF-** to disappear from the display, then unplug the power cable. Never lift or move the unit during playback—discs rotate at a high speed and may be damaged.

Screen sizes and disc formats

DVD-Video discs come in several different screen aspect ratios, ranging from TV programs, which are generally 4:3, to CinemaScope widescreen movies, with an aspect ratio of up to about 7:3.

Televisions, too, come in different aspect ratios; 'standard' 4:3 and widescreen 16:9.

Widescreen TV users

If you have a widescreen TV, the **TV Screen** setting (page 31) of this player should be set to **16:9 (Wide)**.

When you watch discs recorded in 4:3 format, you can use the TV controls to select how the picture is presented. Your TV may offer various zoom and stretch options; see the instructions that came with your TV for details.

Please note that some movie aspect ratios are wider than 16:9, so even though you have a widescreen TV, these discs will still play in a 'letter box' style with black bars at the top and bottom of the screen.

Standard TV users

If you have a standard TV, the **TV Screen** setting (page 31) of this player should be set to **4:3 (Letter Box)** or **4:3 (Pan&Scan)**, depending on which you prefer.

Set to **4:3 (Letter Box)**, widescreen discs are shown with black bars top and bottom.



Set to **4:3 (Pan&Scan)**, widescreen discs are shown with the left and right sides cropped. Although the picture looks larger, you don't actually see the whole picture.



Please note that many widescreen discs override the player's settings so that the disc is shown in letter box format regardless of the setting.

Note

- Using the **16:9 (Wide)** setting with a standard 4:3 TV, or either of the 4:3 settings with a widescreen TV, will result in a distorted picture.

Setting the TV system

The default setting of this player is **AUTO**, and unless you notice that the picture is distorted when playing some discs, you should leave it set to **AUTO**. If you experience picture distortion with some discs, set the TV system to match your country or region's system. Doing this, however, may restrict the kinds of disc you can watch. The table below shows what kinds of disc are compatible with each setting (**AUTO**, **PAL** and **NTSC**).

1 If the player is on, press STANDBY/ON to switch it to standby.

2 Using the front panel controls, hold down ►| then press STANDBY/ON to switch the TV system.

The TV system changes as follows:

- **AUTO** → **NTSC**
- **NTSC** → **PAL**
- **PAL** → **AUTO**



Note

- You have to switch the player into standby (press **STANDBY/ON**) before each change.

Disc Type	Format	Player setting		
		NTSC	PAL	AUTO
DVD/Super VCD/ Video CD/DivX Video	NTSC	NTSC	PAL	NTSC
	PAL	NTSC	PAL	PAL
CD/MP3/WMA/ JPEG no disc	—	NTSC	PAL	NTSC or PAL

Resetting the player

Use this procedure to reset all the player's settings to the factory default.

1 Switch the player into standby.

2 Using the front panel buttons, hold down the ■ (stop) button and press STANDBY/ON to switch the player back on. All the player's settings are now reset.

DVD-Video regions

All DVD-Video discs carry a region mark on the case somewhere that indicates which region(s) of the world the disc is compatible with. Your DVD player also has a region mark, which you can find on the rear panel. Discs from incompatible regions will not play in this player. Discs marked **ALL** will play in any player.

The diagram below shows the various DVD regions of the world.

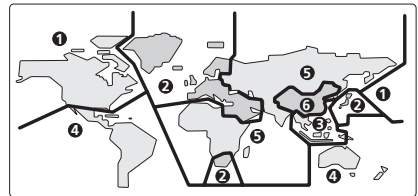

Selecting languages using the language code list

Some of the language options (such as 'DVD Language' in the Setup Navigator) allow you to set your preferred language from any of the 136 languages listed in the language code list on page 38.

1 Select 'Other Language'.

2 Use the cursor left/right (◀▶) buttons to select either a code letter or a code number.

3 Use the cursor up/down (▲▼) buttons to select a code letter or a code number.

See *Language code list* on page 38 for a complete list of languages and codes.

Language code list

Language (Language code letter), **Language code**



- Japanese (ja), **1001**
- English (en), **0514**
- French (fr), **0618**
- German (de), **0405**
- Italian (it), **0920**
- Spanish (es), **0519**
- Chinese (zh), **2608**
- Dutch (nl), **1412**
- Portuguese (pt), **1620**
- Swedish (sv), **1922**
- Russian (ru), **1821**
- Korean (ko), **1115**
- Greek (el), **0512**
- Afar (aa), **0101**
- Abkhazian (ab), **0102**
- Afrikaans (af), **0106**
- Amharic (am), **0113**
- Arabic (ar), **0118**
- Assamese (as), **0119**
- Aymara (ay), **0125**
- Azerbaijani (az), **0126**
- Bashkir (ba), **0201**
- Byelorussian (be), **0205**
- Bulgarian (bg), **0207**
- Bihari (bh), **0208**
- Bislama (bi), **0209**
- Bengali (bn), **0214**
- Tibetan (bo), **0215**
- Breton (br), **0218**
- Catalan (ca), **0301**
- Corsican (co), **0315**
- Czech (cs), **0319**
- Welsh (cy), **0325**
- Danish (da), **0401**
- Bhutani (dz), **0426**
- Esperanto (eo), **0515**
- Estonian (et), **0520**
- Basque (eu), **0521**
- Persian (fa), **0601**
- Finnish (fi), **0609**
- Fiji (fj), **0610**
- Faroese (fo), **0615**
- Frisian (fy), **0625**
- Irish (ga), **0701**
- Scots-Gaelic (gd), **0704**
- Galician (gl), **0712**
- Guarani (gn), **0714**
- Gujarati (gu), **0721**
- Hausa (ha), **0801**
- Hindi (hi), **0809**
- Croatian (hr), **0818**
- Hungarian (hu), **0821**
- Armenian (hy), **0825**
- Interlingua (ia), **0901**
- Interlingue (ie), **0905**
- Inupiak (ik), **0911**
- Indonesian (in), **0914**
- Icelandic (is), **0919**
- Hebrew (iw), **0923**
- Yiddish (ji), **1009**
- Javanese (jw), **1023**
- Georgian (ka), **1101**
- Kazakh (kk), **1111**
- Greenlandic (kl), **1112**
- Cambodian (km), **1113**
- Kannada (kn), **1114**
- Kashmiri (ks), **1119**
- Kurdish (ku), **1121**
- Kirghiz (ky), **1125**
- Latin (la), **1201**
- Lingala (ln), **1214**
- Laothian (lo), **1215**
- Lithuanian (lt), **1220**
- Latvian (lv), **1222**
- Malagasy (mg), **1307**
- Maori (mi), **1309**
- Macedonian (mk), **1311**
- Malayalam (ml), **1312**
- Mongolian (mn), **1314**
- Moldavian (mo), **1315**
- Marathi (mr), **1318**
- Malay (ms), **1319**
- Maltese (mt), **1320**
- Burmese (my), **1325**
- Nauru (na), **1401**
- Nepali (ne), **1405**
- Norwegian (no), **1415**
- Occitan (oc), **1503**
- Oromo (om), **1513**
- Oriya (or), **1518**
- Panjabi (pa), **1601**
- Polish (pl), **1612**
- Pashto, Pushto (ps), **1619**
- Quechua (qu), **1721**
- Rhaeto-Romance (rm), **1813**
- Kirundi (rn), **1814**
- Romanian (ro), **1815**
- Kinyarwanda (rw), **1823**
- Sanskrit (sa), **1901**
- Sindhi (sd), **1904**
- Sangho (sg), **1907**
- Serbo-Croatian (sh), **1908**
- Sinhalese (si), **1909**
- Slovak (sk), **1911**
- Slovenian (sl), **1912**
- Samoan (sm), **1913**
- Shona (sn), **1914**
- Somali (so), **1915**
- Albanian (sq), **1917**
- Serbian (sr), **1918**
- Siswati (ss), **1919**
- Sesotho (st), **1920**
- Sundanese (su), **1921**
- Swahili (sw), **1923**
- Tamil (ta), **2001**
- Telugu (te), **2005**
- Tajik (tg), **2007**
- Thai (th), **2008**
- Tigrinya (ti), **2009**
- Turkmen (tk), **2011**
- Tagalog (tl), **2012**
- Setswana (tn), **2014**
- Tonga (to), **2015**
- Turkish (tr), **2018**
- Tsonga (ts), **2019**
- Tatar (tt), **2020**
- Twi (tw), **2023**
- Ukrainian (uk), **2111**
- Urdu (ur), **2118**
- Uzbek (uz), **2126**
- Vietnamese (vi), **2209**
- Volapük (vo), **2215**
- Wolof (wo), **2315**
- Xhosa (xh), **2408**
- Yoruba (yo), **2515**
- Zulu (zu), **2621**

Country/Area code list

Country/Area, **Country/Area code**, **Country/Area code letter**

- Argentina, **0118, ar**
- Australia, **0121, au**
- Austria, **0120, at**
- Belgium, **0205, be**
- Brazil, **0218, br**
- Canada, **0301, ca**
- Chile, **0312, cl**
- China, **0314, cn**
- Denmark, **0411, dk**
- Finland, **0609, fi**
- France, **0618, fr**
- Germany, **0405, de**
- Hong Kong, **0811, hk**
- India, **0914, in**
- Indonesia, **0904, id**
- Italy, **0920, it**
- Japan, **1016, jp**
- Korea, Republic of, **1118, kr**
- Malaysia, **1325, my**
- Mexico, **1324, mx**
- Netherlands, **1412, nl**
- New Zealand, **1426, nz**
- Norway, **1415, no**
- Pakistan, **1611, pk**
- Philippines, **1608, ph**
- Portugal, **1620, pt**
- Russian Federation, **1821, ru**
- Singapore, **1907, sg**
- Spain, **0519, es**
- Sweden, **1905, se**
- Switzerland, **0308, ch**
- Taiwan, **2023, tw**
- Thailand, **2008, th**
- United Kingdom, **0702, gb**
- USA, **2119, us**

Glossary

Analog audio	Direct representation of sound by an electrical signal. See also <i>Digital audio</i> .
Aspect ratio	The width of a TV screen relative to its height. Conventional TVs are 4:3; widescreen models are 16:9.
Digital audio	Indirect representation of sound using numbers. See also <i>Sampling frequency</i> and <i>Analog audio</i> .
Dolby Digital ^{*1}	A multi-channel audio encoding system developed by Dolby Laboratories that enables far more audio to be stored on a disc than PCM encoding. See also <i>PCM (Pulse Code Modulation)</i> .
	
DRM (WMA)	DRM (Digital Rights Management) copy protection is a technology designed to prevent unauthorized copying by restricting playback, etc. of material on devices other than the PC (or other WMA recording equipment) used to record it. For detailed information, please see the instruction manuals or help files that came with your PC (or other WMA recording equipment) and/or software.
DTS ^{*2}	A multi-channel audio encoding system developed by Digital Theater Systems that enables far more audio to be stored on a disc than PCM encoding. See also <i>PCM (Pulse Code Modulation)</i> .
	
EXIF (Exchangeable Image File)	A file format developed by Fuji Photo Film for digital still cameras. Digital cameras from various manufacturers use this compressed file format which carries date, time and thumbnail information, as well as the picture data.
File extension	A tag added to the end of a filename to indicate the type of file. For example, ".mp3" indicates an MP3 file.
ISO 9660 format	International standard for the volume and file structure of CD-ROM discs.
JPEG	A standard file format used for still images. JPEG files are identified by the file extension ".jpg".
MP3	MP3 (MPEG1 audio layer 3) is a compressed stereo audio file format. Files are recognized by their file extension ".mp3".
MPEG audio	An audio format used on Video CD/ Super VCDs and some DVD discs.
PBC (PlayBack Control)	A system of navigating a Video CD/ Super VCD through on-screen menus recorded onto the disc.
PCM (Pulse Code Modulation)	Digital audio encoding system found on CDs. Good quality, but requires a lot of data compared to Dolby Digital, DTS and MPEG encoded audio. See also <i>Digital audio</i> .
Progressive scan video	All the lines that make up a video picture are updated in one pass (compared to interlace which takes two passes to update the whole picture).
Regions	These associate DVD-Video discs and players with particular areas of the world. See <i>DVD-Video regions</i> on page 37 for more information.
Sampling frequency	The rate at which sound is measured to be turned into digital audio data. The higher the rate, the better the sound quality. CD is 44.1 kHz; DVD can be up to 96 kHz. See also <i>Digital audio</i> .
WMA	WMA is short for Windows Media Audio and refers to an audio compression technology developed by Microsoft Corporation. Files are recognized by their file extension ".wma". Microsoft, Windows Media, and the Windows logo are trademarks, or registered trademarks of Microsoft Corporation in the United States and/or other countries.

^{*1} *Manufactured under license from Dolby Laboratories. "Dolby" and the double-D symbol are trademarks of Dolby Laboratories.*

^{*2} *"DTS" and "DTS Digital Out" are registered trademarks of Digital Theater Systems, Inc.*

Specifications

General

System	DVD player
Power requirements	AC 220–240 V, 50/60 Hz
Power consumption	7 W
Power consumption (standby)	0.7 W
Weight	1.8 kg
Dimensions	435 (W) x 61 (H) x 213 (D) mm
Operating temperature	+5°C to +35°C

RGB (SCART) output

Output level	0.7 Vp-p (75 Ω)
Connection	Euroconnector

Component video output

Y (luminance) - Output level	1 Vp-p (75 Ω)(Green)
Pb/Cb (color) - Output level	0.7 Vp-p (75 Ω)(Blue)
Pr/Cr (color) - Output level	0.7 Vp-p (75 Ω)(Red)
Connection	RCA

S-video output

Y (luminance) - Output level	1 Vp-p (75 Ω)
C (color) - Output level	286 mVp-p (75 Ω)
Connection	S-video (Mini, DIN, 4 pins)

Video output

Output level	1 Vp-p (75 Ω)
Connection	RCA

Audio output (1 stereo pair)

Output level	During audio output 200 mVrms (1 kHz, -20 dB)
Number of channels	2
Connection	RCA

Digital audio characteristics

Frequency response	4 Hz to 44 kHz (DVD fs: 96 kHz)
S/N ratio	115 dB
Dynamic range	101 dB
Total harmonic distortion	0.0023 %

Digital output

Coaxial digital output	RCA
IEC60958 for CDDA/LPCM	
IEC61937 for MPEG 1/2,	
Dolby Digital and DTS	

Accessories

Audio/video cable	1
Power cable	1
Remote control	1
AA/R6 dry cell batteries	2
Owner's manual	

The specifications and design of this product are subject to change without notice, due to improvement.



J2G53921B SH 06/03 

©2005 YAMAHA CORPORATION All rights reserved.

YAMAHA ELECTRONICS CORPORATION, USA 6660 ORANGETHORPE AVE., BUENA PARK, CALIF. 90620, U.S.A.

YAMAHA CANADA MUSIC LTD. 135 MILNER AVE., SCARBOROUGH, ONTARIO M1S 3R1, CANADA

YAMAHA ELECTRONIK EUROPA G.m.b.H. SIEMENSSTR. 22-34, 25462 RELLINGEN BEI HAMBURG, GERMANY

YAMAHA ELECTRONIQUE FRANCE S.A. RUE AMBROISE CROIZAT BP70 CROISSY-BEAUBOURG 77312 MARNE-LA-VALLÉE CEDEX02, FRANCE

YAMAHA ELECTRONICS (UK) LTD. YAMAHA HOUSE, 200 RICKMANSWORTH ROAD WATFORD, HERTS WD18 7GQ, ENGLAND

YAMAHA SCANDINAVIA A.B. J A WETTERGRENS GATA 1, BOX 30053, 400 43 VÄSTRA FRÖLUNDA, SWEDEN

YAMAHA MUSIC AUSTRALIA PTY, LTD. 17-33 MARKET ST., SOUTH MELBOURNE, 3205 VIC., AUSTRALIA

YAMAHA CORPORATION

Printed in Thailand  J2G53921B

(WG69400-1)

Download from www.Somanuals.com. All Manuals Search And Download.



NS-P110 NS-P116

(NS-P110/NS-P116: NX-E130 + NX-C130 + SW-P130)

HOME CINEMA 5.1CH SPEAKER PACKAGE
HOME CINEMA 6.1CH SPEAKER PACKAGE



OWNER'S MANUAL

IMPORTANT SAFETY INSTRUCTIONS

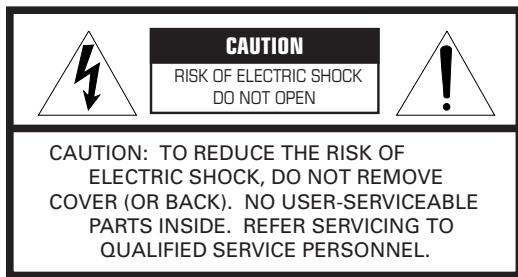

• Explanation of Graphical Symbols

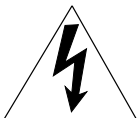

The lightning flash with arrowhead symbol, within an equilateral triangle, is intended to alert you to the presence of uninsulated "dangerous voltage" within the product's enclosure that may be of sufficient magnitude to constitute a risk of electric shock to persons.



The exclamation point within an equilateral triangle is intended to alert you to the presence of important operating and maintenance (servicing) instructions in the literature accompanying the appliance.

IMPORTANT

Please record the serial number of this system in the space below.

Model:

Serial No.:

The serial number is located on the rear of the main unit.

Retain this Owner's Manual in a safe place for future reference.

- 1 Read these instructions.
- 2 Keep these instructions.
- 3 Heed all warnings.
- 4 Follow all instructions.
- 5 Do not use this apparatus near water.
- 6 Clean only with dry cloth.
- 7 Do not block any ventilation openings. Install in accordance with the manufacturer's instructions.
- 8 Do not install near any heat sources such as radiators, heat registers, stoves, or other apparatus (including amplifiers) that produce heat.
- 9 Do not defeat the safety purpose of the polarized or grounding-type plug. A polarized plug has two blades with one wider than the other. A grounding type plug has two blades and a third grounding prong. The wide blade or the third prong are provided for your safety. If the provided plug does not fit into your outlet, consult an electrician for replacement of the obsolete outlet.
- 10 Protect the power cord from being walked on or pinched particularly at plugs, convenience receptacles, and the point where they exit from the apparatus.
- 11 Only use attachments/accessories specified by the manufacturer.
- 12 Use only with the cart, stand, tripod, bracket, or table specified by the manufacturer, or sold with the apparatus. When a cart is used, use caution when moving the cart/apparatus combination to avoid injury from tip-over. 
- 13 Unplug this apparatus during lightning storms or when unused for long periods of time.
- 14 Refer all servicing to qualified service personnel. Servicing is required when the apparatus has been damaged in any way, such as power-supply cord or plug is damaged, liquid has been spilled or objects have fallen into the apparatus, the apparatus has been exposed to rain or moisture, does not operate normally, or has been dropped.

- Be sure to allow spaces of at least 20 cm above, behind and on both sides of the subwoofer.
- Do not place the following objects on this unit:
A vessel with water in it.
If the vessel falls by vibrations and water spills, it may cause damage to the unit, and/or you may get an electric shock.

For Canadian Customers

To prevent electric shock, match wide blade of plug to wide slot and fully insert.

This Class B digital apparatus complies with Canadian ICES-003.

FCC INFORMATION (for US customers only)

1. IMPORTANT NOTICE : DO NOT MODIFY THIS UNIT!

This product, when installed as indicated in the instructions contained in this manual, meets FCC requirements. Modifications not expressly approved by Yamaha may void your authority, granted by the FCC, to use the product.

2. IMPORTANT : When connecting this product to accessories and/or another product use only high quality shielded cables. Cable/s supplied with this product MUST be used. Follow all installation instructions. Failure to follow instructions could void your FCC authorization to use this product in the USA.

3. NOTE : This product has been tested and found to comply with the requirements listed in FCC Regulations, Part 15 for Class "B" digital devices. Compliance with these requirements provides a reasonable level of assurance that your use of this product in a residential environment will not result in harmful interference with other electronic devices.

This equipment generates/uses radio frequencies and, if not installed and used according to the instructions found in the users manual, may cause interference harmful to the operation of other electronic devices.

Compliance with FCC regulations does not guarantee that interference will not occur in all installations. If this product is found to be the source of interference, which can be determined by turning the unit "OFF" and "ON", please try to eliminate the problem by using one of the following measures:

Relocate either this product or the device that is being affected by the interference.

Utilize power outlets that are on different branch (circuit breaker or fuse) circuits or install AC line filter/s.

In the case of radio or TV interference, relocate/reorient the antenna. If the antenna lead-in is 300 ohm ribbon lead, change the lead-in to coaxial type cable.

If these corrective measures do not produce satisfactory results, please contact the local retailer authorized to distribute this type of product. If you can not locate the appropriate retailer, please contact Yamaha Electronics Corp., U.S.A. 6660 Orangethorpe Ave, Buena Park, CA 90620.

The above statements apply ONLY to those products distributed by Yamaha Corporation of America or its subsidiaries.

We Want You Listening For A Lifetime



YAMAHA and the Electronic Industries Association's Consumer Electronics Group want you to get the most out of your equipment by playing it at a safe level. One that lets the sound come through loud and clear without annoying blaring or distortion – and, most importantly, without affecting your sensitive hearing.

Since hearing damage from loud sounds is often undetectable until it is too late, YAMAHA and the Electronic Industries Association's Consumer Electronics Group recommend you to avoid prolonged exposure from excessive volume levels.

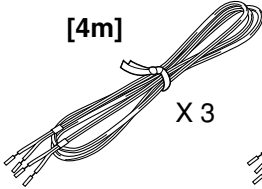
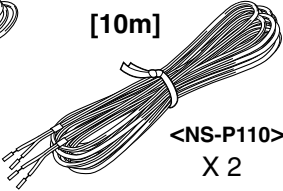

UNPACKING

Please check to make sure all listed items are included.

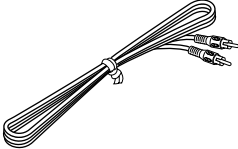
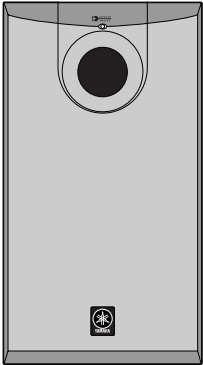
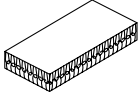
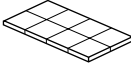
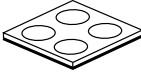
<ul style="list-style-type: none">● Front and rear speakers (and rear center speaker for NS-P116) <p>NX-E130</p>  <p><NS-P110> X 4 <NS-P116> X 5</p>	<ul style="list-style-type: none">● Speaker cables <p>[4m] X 3</p>  <p>[10m] X 2</p>  <p><NS-P110> X 2 <NS-P116> X 3</p>
<ul style="list-style-type: none">● Center speaker <p>NX-C130</p> 	<ul style="list-style-type: none">● Subwoofer cable 
<ul style="list-style-type: none">● Subwoofer <p>SW-P130</p> 	<ul style="list-style-type: none">● Fasteners (for NX-C130)  <p>X 2</p>
<ul style="list-style-type: none">● Nonskid pads (for NX-E130)  <p><NS-P110> X 2 <NS-P116> X 3</p>	<ul style="list-style-type: none">● Nonskid pads (for SW-P130) 

CAUTION: Read this before operating your unit.

- To assure the finest performance, please read this manual carefully. Keep it in a safe place for future reference.
- Install the speakers in a cool, dry, clean place – away from windows, heat sources, sources of excessive vibration, dust, moisture and cold. Avoid sources of humming (transformers, motors). To prevent fire or electric shock, do not expose the speakers to rain or water.
- To prevent the enclosure from warping or discoloring, do not place the speakers where they will be exposed to direct sunlight or excessive humidity.
- Avoid installing the speakers where foreign objects may fall onto them and/or where they may be exposed to liquid dripping or splashing.
Do not place the following objects on top of the speakers:
 - Other components, as they might cause damage and/or discoloration on the surface of the speakers.
 - Burning objects (i.e. candles), as they might cause fire, damage to the speakers and/or personal injury.
 - Containers with liquid in them, as they might cause electric shock to the user and/or damage to the speakers.
- Do not place the speakers where they are liable to be knocked over or struck by falling objects. Stable placement will also ensure better sound performance.
- Placing the speakers on the same shelf or rack as the turntable can result in feedback.
- Secure placement or installation is the owner's responsibility. YAMAHA shall not be liable for any accident caused by improper placement or installation of speakers.
- Any time you note distortion, reduce the volume control on your amplifier to a lower setting. Never allow your amplifier to be driven into "clipping". Otherwise the speakers may be damaged.
- When using an amplifier with a rated output power higher than the nominal input power of the speakers, care should be taken never to exceed the speakers' maximum input.
- Do not attempt to clean the speakers with chemical solvents as this might damage the finish. Use a clean, dry cloth.
- Do not attempt to modify or fix the speakers. Contact qualified YAMAHA service personnel when any service is needed. The cabinet should never be opened for any reason.
- Be sure to read the "TROUBLESHOOTING" section regarding common operating errors before concluding that the speakers are faulty.
- Do not plug in this unit to a wall outlet until all connections are completed.
- The voltage to be used must be the same as that specified on the rear panel. Using this unit with a higher voltage than specified is dangerous and may cause fire, damage to this unit, and/or personal injury. YAMAHA will not be held responsible for any damage resulting from use of this unit with a voltage other than specified.
- To prevent lightning damage, disconnect the AC power plug when there is an electric storm.
- Super-bass frequencies reproduced by this unit may cause a turntable to generate a howling sound. In such a case, move this unit away from the turntable.
- This unit may be damaged if certain sounds are continuously outputted at high volume level. For example, if 20 Hz–50 Hz sine waves from a test disc, bass sounds from electronic instruments, etc. are continuously outputted, or when the stylus of a turntable touches the surface of a disc, reduce the volume level to prevent this unit from being damaged.
- If you hear distorted noise (i.e. unnatural, intermittent "rapping" or "hammering" sounds) coming from this unit, reduce the volume level. Extremely loud playing of a movie soundtrack's low frequency, bass-heavy sounds or similarly loud popular music passages can damage this speaker system.
- Vibration generated by super-bass frequencies may distort images on a TV. In such a case, move this unit away from the TV set.
- When disconnecting the power cord from the wall outlet, grasp the plug; do not pull the cord.
- When not planning to use this unit for a long period (i.e. vacation, etc.), disconnect the AC power plug from the wall outlet.

VOLTAGE SELECTOR
(For China, Korean and General models)
The voltage selector switch on the rear panel of this unit must be set for your local main voltage **BEFORE** plugging this unit into the AC main supply.
Voltages are 110V-120V/220V-240 V AC, 50/60 Hz.

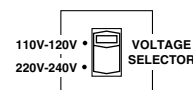

For SW-P130

- Do not operate this unit upside down. It may overheat, possibly causing damage.
- Do not use excessive force on switches, controls or connection wires. When moving this unit, first disconnect the power plug and the wires connected to other equipments. Never pull the wires themselves.
- Since this unit has a built-in power amplifier, heat will radiate from the rear panel. Place the unit apart from the walls, allowing at least 20 cm of space above, behind and on both sides of the unit to prevent fire or damage. Furthermore, do not position with the rear panel facing down on the floor or other surfaces.
- When using a humidifier, be sure to avoid condensation inside this unit by allowing enough spaces around this unit or avoiding excess humidification. Condensation might cause a fire, damage to this unit, and/or electric shock.
- Do not cover the rear panel of this unit with a newspaper, a tablecloth, a curtain, etc. in order not to obstruct heat radiation. If the temperature inside this unit rises, it may cause fire, damage to this unit and/or personal injury.

Standby mode
If the POWER switch is set to the ON position and the AUTO STANDBY switch is set to the HIGH or LOW position, this unit turns into the standby mode when no signal is received by this unit for 7 to 8 minutes.
In this state, this unit is designed to consume a very small quantity of power.

WARNING
TO REDUCE THE RISK OF FIRE OR ELECTRIC SHOCK, DO NOT EXPOSE THIS UNIT TO RAIN OR MOISTURE.

COMPONENTS OF THE PACKAGE

The speaker package “NS-P110 and NS-P116” is designed for use in a multi-channel audio system such as a home theater system.

NS-P110 includes four NX-E130 speaker systems, one NX-C130 speaker system and one SW-P130 subwoofer system.

NS-P116 includes five NX-E130 speaker systems, one NX-C130 speaker system and one SW-P130 subwoofer system.

<NX-E130>

Full range acoustic-suspension speaker system used for the front and rear speakers (and rear center speaker for NS-P116)

<NX-C130>

Full range acoustic-suspension speaker system used for the center speaker

<SW-P130>

Active Servo Processing Subwoofer System with a built-in power amplifier

- This subwoofer system employs Advanced Yamaha Active Servo Technology which YAMAHA has developed for reproducing higher quality super-bass sound. (Refer to page 12 for details on Advanced Yamaha Active Servo Technology.) This super-bass sound adds a more realistic, theater-in-the-home effect to your stereo system.
- The AUTO STANDBY switch saves you the trouble of setting the POWER switch to the ON or OFF position.

CONTENTS

IMPORTANT SAFETY INSTRUCTIONS	II
UNPACKING	IV
CAUTION	1
COMPONENTS OF THE PACKAGE	2
SETTING UP THE SPEAKERS	3
Placing the subwoofer	4
Placing the center speaker	4
Mounting the front/rear speakers (and rear center speaker for NS-P116)	5
Placing the front/rear speakers (and rear center speaker for NS-P116)	6

CONNECTIONS	7
An example of basic connections	7
How to connect speaker cables	8
USING THE SUBWOOFER (SW-P130)	9
Controls and their functions	9
Automatic-power-switching function	10
Adjusting the subwoofer before use	10
Frequency characteristics	11
ADVANCED YAMAHA ACTIVE SERVO TECHNOLOGY (for SW-P130)	12
TROUBLESHOOTING	13
SPECIFICATIONS	14

SETTING UP THE SPEAKERS

Before making connections, place all speakers in their respective positions. The positioning of the speakers is important because it controls the whole sound quality of this system.

Place the speakers depending on your listening position by following the instructions below.

Speaker configuration

<NS-P110>

This speaker package employs a 6 speaker configuration: 2 front speakers, 2 rear speakers, a center speaker and a subwoofer.

The front speakers emit main source sound. The rear speakers emit surround sounds, and the center speaker emits center sounds (dialog etc.). The subwoofer emits reinforcing low frequencies on your audio system.

<NS-P116>

This speaker package employs a 7 speaker configuration: 2 front speakers, 2 rear speakers, a center speaker, a rear center speaker and a subwoofer.

The front speakers emit main source sound. The rear and rear center speakers emit surround sounds, and the center speaker emits center sounds (dialog etc.). The subwoofer emits reinforcing low frequencies on your audio system.

Note

In this speaker package, the same speakers (NX-E130) are used for the front and rear speakers (and rear center speaker for NS-P116).

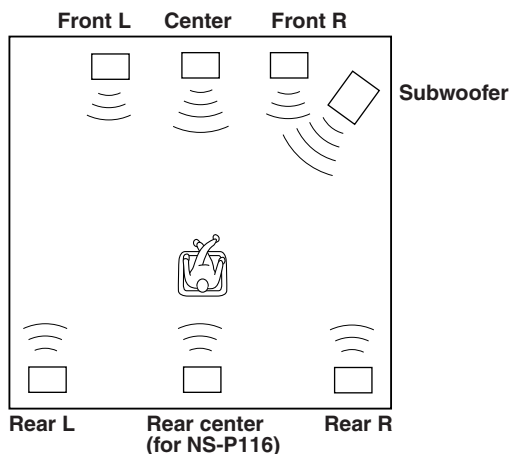

Placing speakers

Front speakers: On both sides of and at approximately the same height as the TV set.

Rear speakers: Behind your listening position, facing slightly inward. About 1.8 m (approx. 6 feet) from the floor.

Center speaker: Precisely between the front speakers.

Rear center speaker (for NS-P116): Precisely between the rear speakers.

Subwoofer: The position of the subwoofer is not so critical because low bass tones are not highly directional. Refer to "Placing the subwoofer" on page 4 for a recommended positioning of the subwoofer.

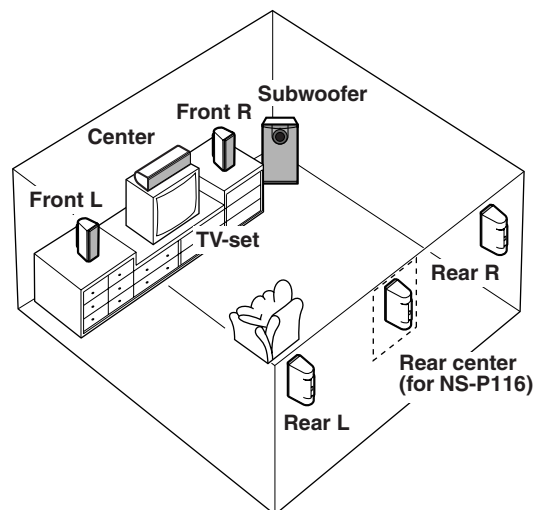

These speakers feature a magnetically shielded design, but there is still a chance that placing them too close to a TV set might impair picture color. Should this happen, move the speakers away from the TV set.

■ Placing the subwoofer

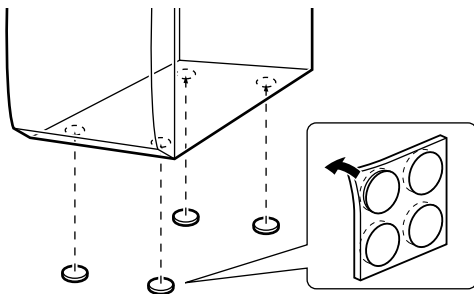
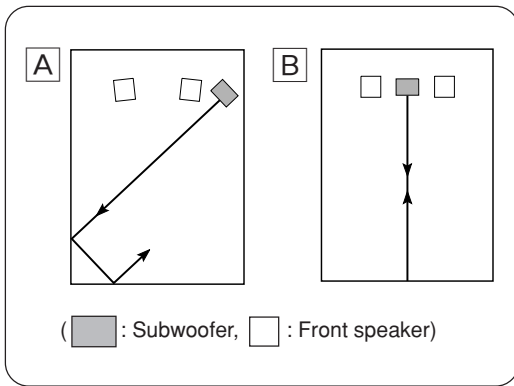

It is recommended to place the subwoofer on the outside of either the right or the left front speaker. (See fig. [A].) The placement shown in fig. [B] is also possible, however, if the subwoofer system is placed directly facing the wall, the bass effect may die because the sound from it and the sound reflected by the wall may cancel out each other. To prevent this from happening, face the subwoofer system at an angle as shown in fig. [A].

Note

There may be a case that you cannot obtain enough super-bass sounds from the subwoofer when listening in the center of the room. This is because “standing waves” have been developed between two parallel walls and they cancel the bass sounds.

In such a case, face the subwoofer obliquely to the wall. It also may be necessary to break up the parallel surfaces by placing bookshelves etc. along the walls.

Use the nonskid pads

Put the provided nonskid pads at the four corners on the bottom of the subwoofer to prevent the subwoofer from moving by vibrations etc.

■ Placing the center speaker

You can place the speaker on top of the TV if the top is flat, on the floor under the TV, or inside the TV rack. Be sure to place the speaker in a stable position.

When placing the speaker on top of the TV, to prevent the speaker from falling, attach the provided fasteners at two points on the bottom of the speaker and on the top of the TV.

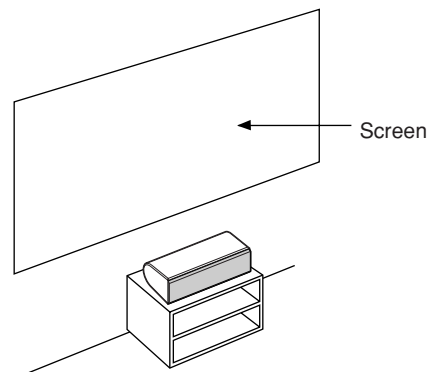
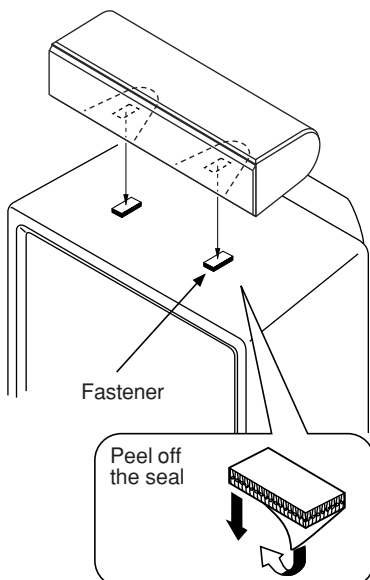

Notes

- Do not place the speaker on top of a TV whose area is smaller than the bottom of the speaker. If placed, the speaker may fall and cause injury.
- Do not place the speaker on top of a TV if the top is inclined.
- Do not touch the adhesive surface after peeling off the seal as this will weaken its adhesive strength.
- Thoroughly wipe clean the surface where the fastener is to be applied. Note that adhesive strength is weakened if the surface is dirty, oily or wet and that this may cause the center speaker to fall.

■ Mounting the front/rear speakers (and rear center speaker for NS-P116)

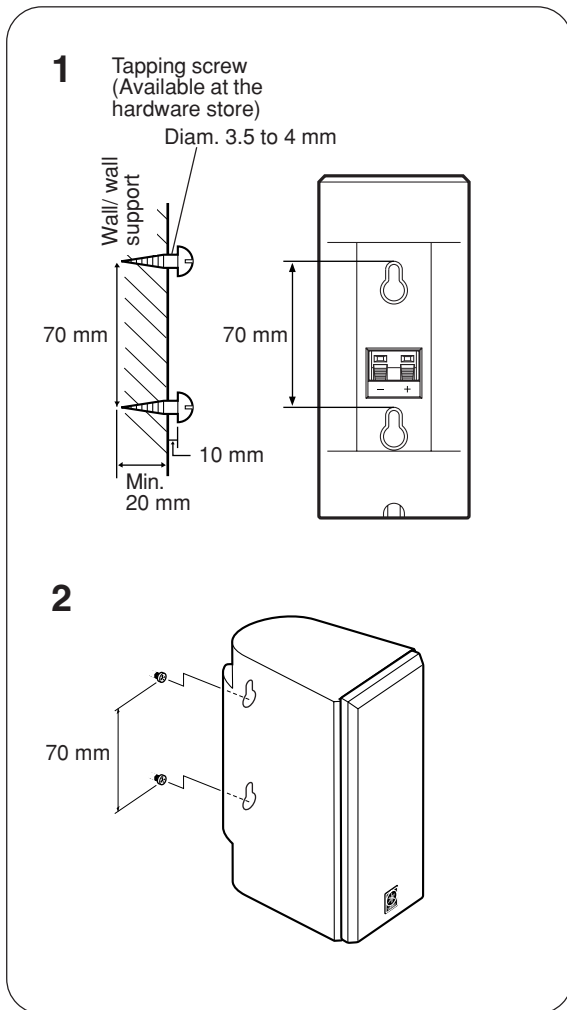

Mount the front/rear speakers (and rear center speaker for NS-P116) on a shelf, rack or directly on the floor, or hang them on the wall.

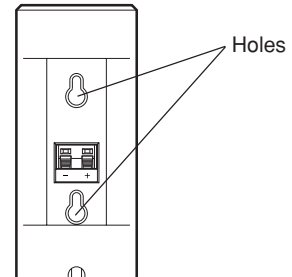

To mount the speakers on a wall by using the holes on the speakers' back panels

- 1** Fasten screws into a firm wall or wall support as shown in the figure.
- 2** Hang the speaker by mounting the holes on the protruding screws.
 - * Make sure that the screws are securely affixed by the narrow parts of the holes.

WARNING

- Each speaker weighs 0.9 kg (2 lbs.). Do not mount them on thin plywood or a wall composed of a soft surface material. If mounted, the screws may pull out of the flimsy surface and the speakers may fall. This may damage the speakers or cause personal injury.
- Do not affix the speakers to a wall using nails, adhesives, or any other unstable hardware. Long-term use and vibrations may cause the speakers to fall.
- To avoid accidents resulting from tripping over loose speaker cables, fix the cables to the wall.
- Select an appropriate position on the wall to mount the speaker so that no one will injure his/her head or face.

Using the Yamaha Speaker Stand SPS-80 (option)

By using the Yamaha Speaker Stand SPS-80, speakers can be placed on the floor.

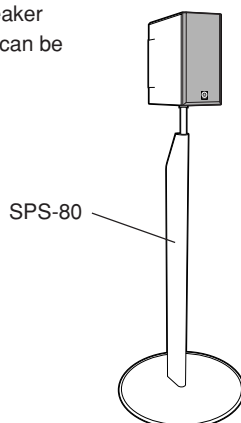

* The SPS-80 is not available in some areas.

■ Placing the the front/rear speakers (and rear center speaker for NS-P116)

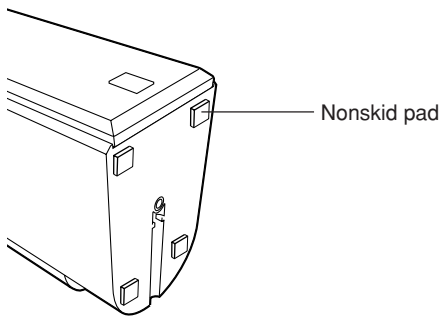

When placing the speakers on a flat surface, attach the included nonskid pads to the corners on the bottom of the speakers as shown on the left. This prevents the speakers from sliding around.

* For NS-P116, the nonskid pads include four spare ones.

If you want to mount a speaker on a commercially available speaker stand for the front/rear speakers (and rear center speaker for NS-P116)

The following optional accessories are needed for mounting the speakers on commercially available speaker stands.

* Inquire at your authorized YAMAHA dealer for the optional accessories.

Mounting bracket (AAX34790)

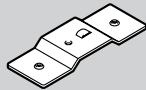

<NS-P110>
X 4
<NS-P116>
X 5

Screw (AAX12390)



<NS-P110>
X 4
<NS-P116>
X 5

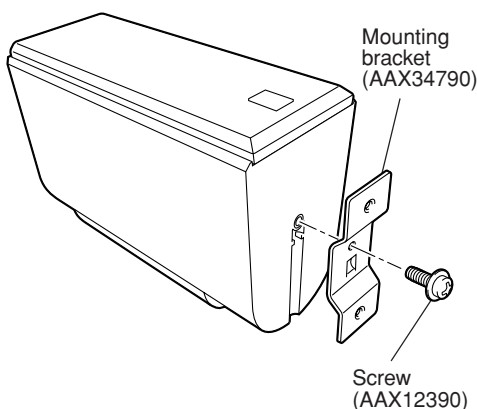

1 Attach the bracket (AAX34790) to the bottom of the speaker by using the screw (AAX12390) so that the convex part of the bracket fits in the grooved part on the bottom of the speaker as shown on the left.

2 Mount the speaker on the speaker stand by using a pair of screw holes (at an interval of 60 mm) on the bracket.

* Those screw holes can be used with M4 screws only.

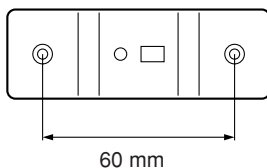

CONNECTIONS

Caution: Plug in the subwoofer and other audio/video components after all connections are completed.

■ An example of basic connections

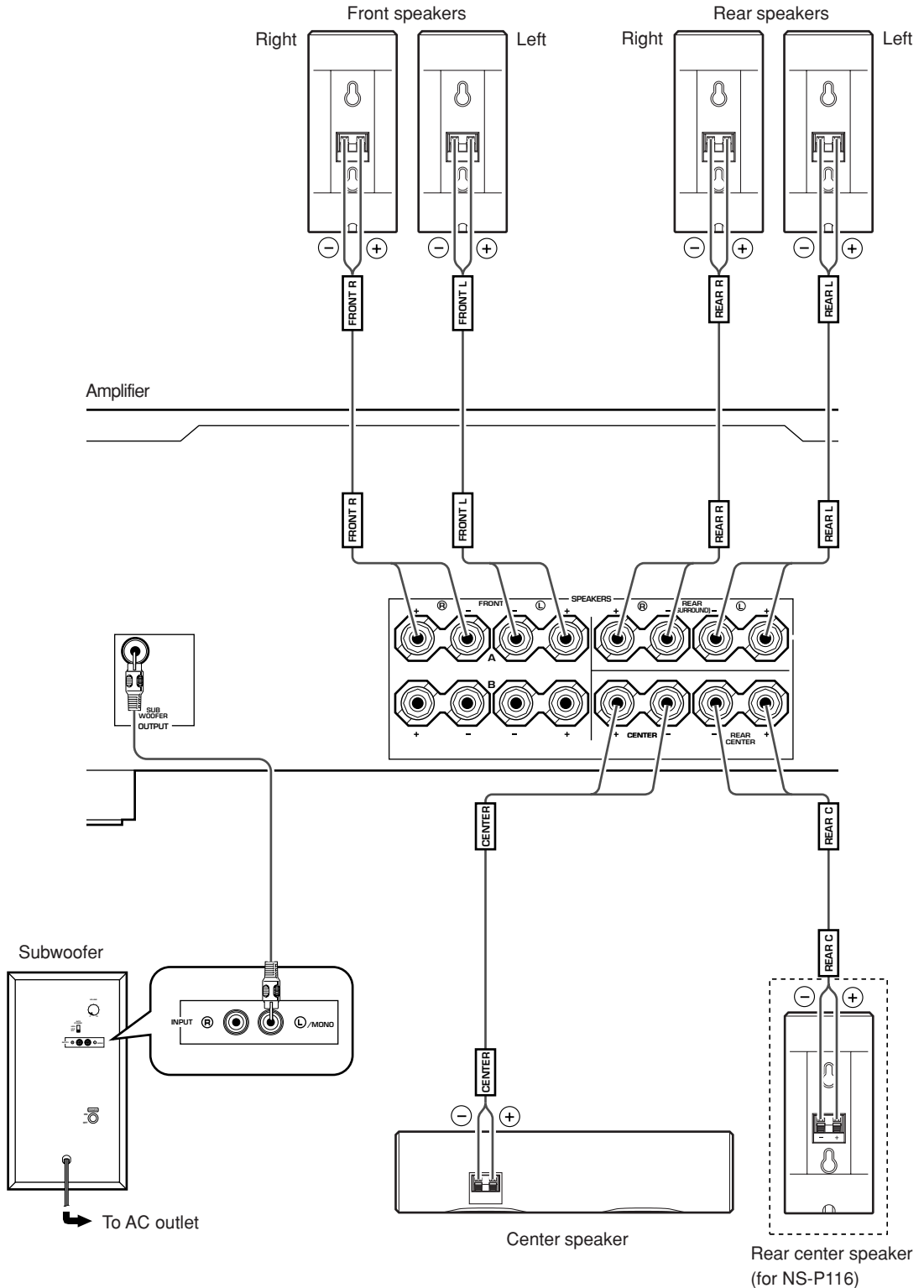

- Connect the front, center and rear speakers (and rear center speaker for NS-P116) to the speaker output terminals of your amplifier with the provided speaker cables.
 - * The provided speaker cables have labels marked FRONT L, FRONT R, CENTER, REAR L, REAR R (and REAR C for NS-P116). Connect each speaker cable to the corresponding speaker by following the figure on page 7.

(The speaker cables marked FRONT L/R are used for connecting the front speakers to the FRONT speakers' terminals on the amplifier.)
 - * Connect each speaker making sure not to reverse the polarity (+, -). If the speaker is connected with reversed polarity, the sound will be unnatural and lack bass.
 - * For the front and rear speakers only, connect one speaker to the left (marked L) terminals of your amplifier, and another speaker to the right (marked R) terminals.

- Connect the subwoofer to the line output (pin jack) terminal(s) of the amplifier.
 - * To connect with a YAMAHA DSP amplifier (or AV receiver), connect the SUBWOOFER (or LOW PASS etc.) terminal on the rear of the DSP amplifier (or AV receiver) to the L /MONO INPUT terminal of the subwoofer.
 - * To connect the subwoofer to the SPLIT SUBWOOFER terminals on the rear of the DSP amplifier, connect them to both the left L /MONO and right R INPUT terminals of the subwoofer.

Note

When connecting to a monaural line output terminal of the amplifier, connect to the L /MONO INPUT terminal.

■ How to connect speaker cables

For connections, keep the speaker cables as short as possible. Do not bundle or roll up the excess part of the cables. If the connections are faulty, no sound will be heard from the speakers.

Before connecting

Remove the insulation coating at the extremity of each speaker cable by twisting the coating off.

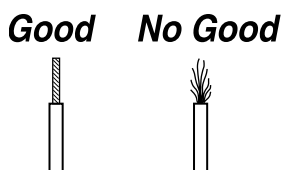

One side of the provided speaker cable has a white broken line and the other side has no line. Connect the (+) terminals on both the speaker and the amplifier using the side with a white broken line. Connect the (-) terminals on both components using the side with no line.

How to Connect:

- ① Press and hold the terminal's tab, as shown in the figure.
- ② Insert the bare wire.
- ③ Release your finger from the tab to allow it to lock securely on the cable's wire end.
- ④ Test the firmness of the connection by pulling lightly on the cable at the terminal.

Red: positive (+)
Black: negative (-)

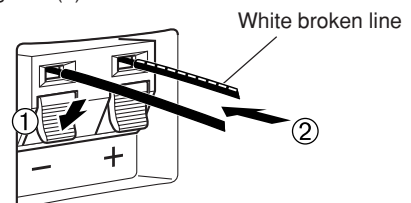

Note

Do not let the bare speaker wires touch each other as this could damage the speaker or the amplifier, or both of them.

USING THE SUBWOOFER (SW-P130)

■ Controls and their functions

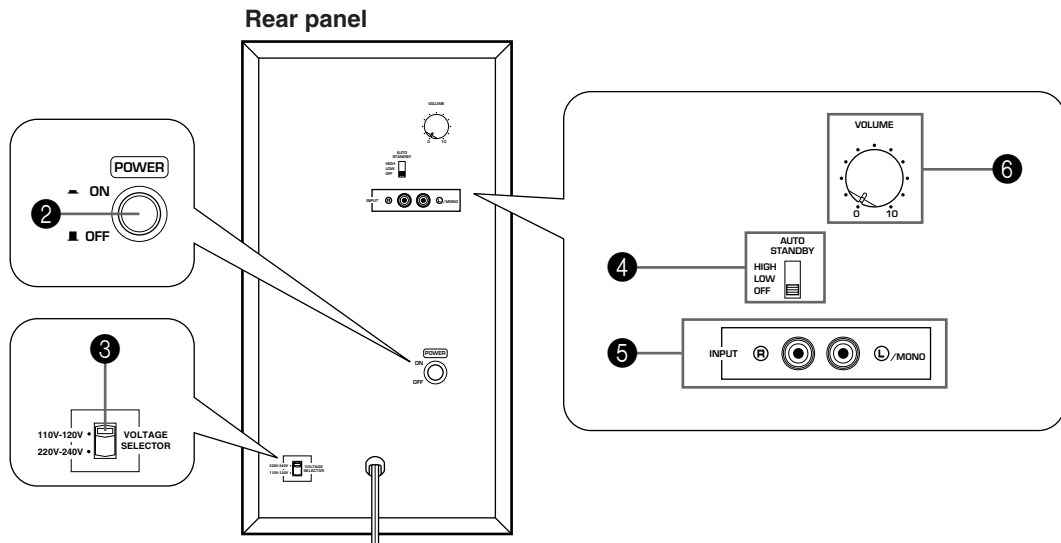
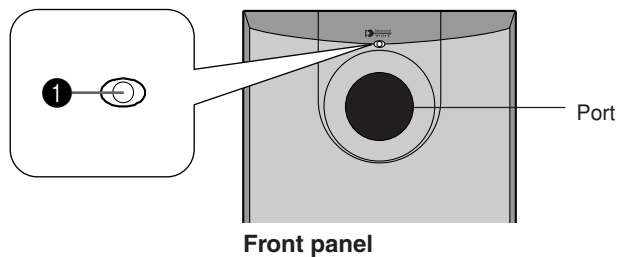

- 1 Power indicator**
Lights up GREEN when the **POWER** switch (2) is pressed in to the ON position and goes off when set to the OFF position.
* Standby mode
If the **POWER** switch (2) is pressed in to the ON position and the **AUTO STANDBY** switch (4) is set to the HIGH or LOW position, this indicator lights up RED when no signal is received by the subwoofer.
- 2 POWER** switch
Press this switch to the ON position to turn on the power of the subwoofer. When the power of the subwoofer is on, the power indicator (1) on the front panel lights up GREEN. Press this switch again to set to the OFF position to turn off the power of the subwoofer.
- 3 VOLTAGE SELECTOR** switch
(For China, Korean and General models)
If the preset setting of the switch is incorrect, set the switch to the proper voltage range (220V-240V or 110V-120V) of your area.
Consult your dealer if you are unsure of the correct setting.
WARNING
Be sure to unplug the subwoofer before setting the VOLTAGE SELECTOR switch correctly.
- 4 AUTO STANDBY (HIGH/LOW/OFF)** switch
This switch is originally set to the OFF position. By setting this switch to the HIGH or LOW position, the subwoofer's automatic power-switching function operates as explained on page 10. If you do not need this function, set to the OFF position.
* Make sure to change the setting of this switch only when the **POWER** switch (2) is in the OFF position.
- 5 INPUT** terminals
Used to input line level signals from the amplifier.
- 6 VOLUME** control
Adjusts the volume level. Turn the control clockwise to increase the volume, and counterclockwise to decrease the volume.

■ Automatic power-switching function

If the source being played is stopped and the input signal is cut off for 7 to 8 minutes, the subwoofer automatically switches to the standby mode. (When the subwoofer switches to the standby mode by the automatic power-switching function, the power indicator lights up in red.) When you play a source again, the power of the subwoofer turns on automatically by sensing audio signals input to the subwoofer.

This function will operate by sensing a certain level of low frequency input signal. Usually set the **AUTO STANDBY** switch to the LOW position. However, if the power is not switched on or to the standby mode smoothly, set the switch to the HIGH position. In the HIGH position, the power will turn on even with a low level of input signal. But please be aware that the subwoofer may not switch to the standby mode when there is an extremely low input signal.

- * The power might turn on unexpectedly by sensing noise from other appliances. If that occurs, set the **AUTO STANDBY** switch to the OFF position and use the **POWER** switch to switch the power between ON and OFF manually.
- * This function detects the low-frequency components below 200 Hz of the input signals (i.e., the explosion in the action movie, the sound of the bass guitar or the bass drum, etc.).
- * The minutes required to switch the subwoofer to the standby mode might change by sensing noise from other appliances.

This function is available only when the power of the subwoofer is on (by pressing the POWER switch).

■ Adjusting the subwoofer before use

Before using the subwoofer, adjust the subwoofer to obtain the optimum volume balance between the subwoofer and the front speakers by following the procedures described below.

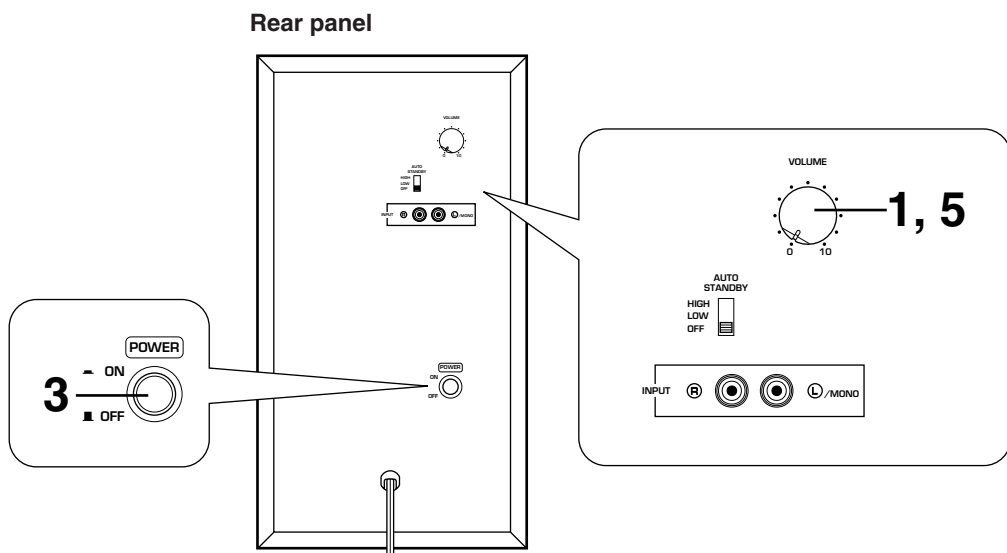

- 1 Set the **VOLUME** control to minimum (0).
- 2 Turn on the power of all the other components.
- 3 Press the **POWER** switch to the ON position.
 - * The power indicator on the front panel lights up in green.
- 4 Play a source containing low-frequency components and adjust the amplifier's volume control to the desired listening level.
- 5 Increase the volume gradually to adjust the volume balance between the subwoofer and the front speakers.

Normally, set the control to the level where you can obtain a little more bass effect than when this unit is not used.

- Once the volume balance between the subwoofer and the front speakers is adjusted, you can adjust the volume of your whole sound system by using the amplifier's volume control. However, if you change the front speakers (NX-E130) to others, you must make this adjustment again.
- For adjusting the **VOLUME** control, refer to "Frequency characteristics" below.

■ Frequency characteristics

Fig. 1 shows the frequency characteristics of the subwoofer.

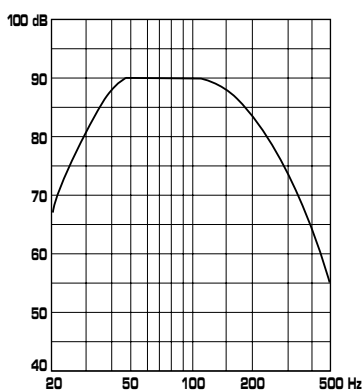

Fig. 1

Fig. 2 shows the frequency characteristics when the subwoofer is combined with NX-E130 and the subwoofer's volume level is set to the figured position.

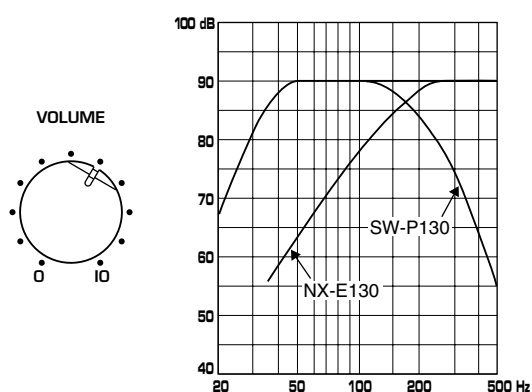

Fig. 2

ADVANCED YAMAHA ACTIVE SERVO TECHNOLOGY (for SW-P130)

The theory of Yamaha Active Servo Technology has been based upon two major factors, the Helmholtz resonator and negative-impedance drive. Active Servo Processing speakers reproduce the bass frequencies through an “air woofer”, which is a port or opening in the speaker’s cabinet. This opening is used instead of, and performs the functions of, a woofer in a conventionally designed speaker system. Thus, signals of low amplitude within the cabinet can, according to the Helmholtz resonance theory, be outputted from this opening as waves of great amplitude if the size of the opening and the volume of the cabinet are in the correct proportion to satisfy a certain ratio.

In order to accomplish this, moreover, the amplitudes within the cabinet must be both precise and of sufficient power because these amplitudes must overcome the “load” presented by the air that exists within the cabinet.

Thus it is this problem that is resolved through the employment of a new design in which the amplifier supplies special signals. If the electrical resistance of the voice coil could be reduced to zero, the movement of the speaker unit would become linear with respect to signal voltage. To accomplish this, a special negative-impedance output-drive amplifier for subtracting output impedance of the amplifier is used.

By employing negative-impedance drive circuits, the amplifier is able to generate precise, low-amplitude, low-frequency waves with superior damping characteristics. These waves are then radiated from the cabinet opening as high-amplitude signals. The system can, therefore, by employing the negative-impedance output drive amplifier and a speaker cabinet with the Helmholtz resonator, reproduce an extremely wide range of frequencies with amazing sound quality and less distortion.

The features described above, then, are combined to be the fundamental structure of the conventional Yamaha Active Servo Technology.

Our new Active Servo Technology — Advanced Yamaha Active Servo Technology — adopted Advanced Negative Impedance Converter (ANIC) circuits, which allows the conventional negative impedance converter to dynamically vary in order to select an optimum value for speaker impedance variation. With this new ANIC circuits, Advanced Yamaha Active Servo Technology can provide more stable performance and improved sound pressure compared with the conventional Yamaha Active Servo Technology, resulting in more natural and dynamic bass reproduction.

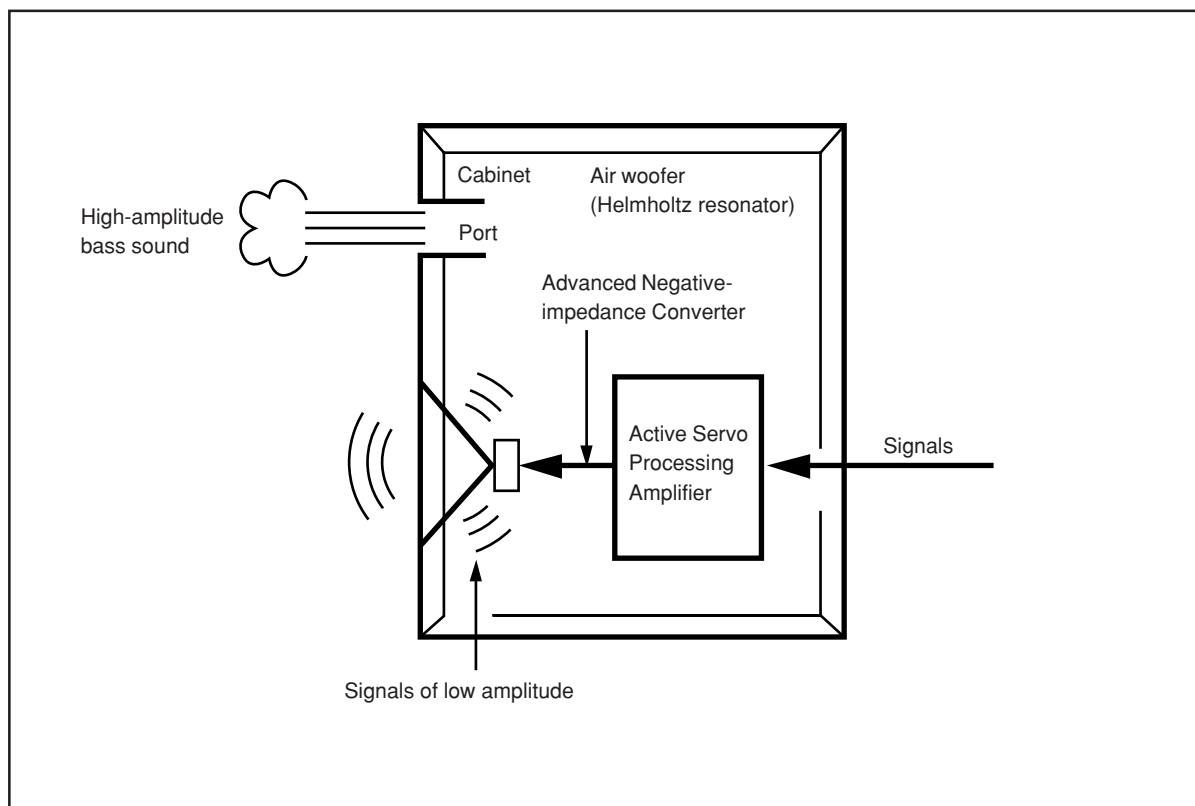

TROUBLESHOOTING

Refer to the chart below when this unit does not function properly. If the problem you are experiencing is not listed below or if the instructions given below do not help, disconnect the power cord and contact your authorized YAMAHA dealer or service center.

Problem	Cause	What to Do
No sound.	Speaker cables are not connected securely.	Connect them securely.
Sound level is too low.	Speaker cables are not connected correctly.	Connect them correctly, that is L (left) to L, R (right) to R, "+" to "+" and "-" to "-".

For SW-P130

Problem	Cause	What to Do
Power is not supplied even though the POWER switch is set to the ON position.	The power plug is not securely connected.	Connect it securely.
No sound.	The VOLUME control is set to 0.	Turn the VOLUME control to the right (clockwise).
	Speaker cables are not connected securely.	Connect them securely.
Sound level is too low.	Speaker cables are not connected correctly.	Connect them correctly, that is L (left) to L, R (right) to R, "+" to "+" and "-" to "-".
	A source sound with few bass frequencies is played.	Play a source sound with bass frequencies.
	It is influenced by standing waves.	Reposition the subwoofer or break up the parallel surface by placing bookshelves etc. along the walls.
The subwoofer does not turn on automatically.	The POWER switch is set to the OFF position.	Set the POWER switch to the ON position.
	The AUTO STANDBY switch is set to the OFF position.	Set the AUTO STANDBY switch to the "HIGH" or "LOW" position.
	The level of input signal is too low.	Set the AUTO STANDBY switch to the "HIGH" position.
The subwoofer does not turn into the standby mode automatically.	There is an influence of noise generated from external appliances etc.	Move the subwoofer farther away from such appliances and/or reposition the connected speaker cables. Otherwise, set the AUTO STANDBY switch to the "OFF" position.
	The AUTO STANDBY switch is set to the OFF position.	Set the AUTO STANDBY switch to the "HIGH" position.
The subwoofer turns into the standby mode unexpectedly.	The level of input signal is too low.	Set the AUTO STANDBY switch to the "HIGH" position.
The subwoofer turns on unexpectedly.	There is an influence of noise generated from external appliances etc.	Move the subwoofer farther away from such appliances and/or reposition the connected speaker cables. Otherwise, set the AUTO STANDBY switch to the "OFF" position.

SPECIFICATIONS

■ NX-E130, NX-C130

Type Full range acoustic-suspension speaker system
Magnetic shielding type

Driver 5 cm (2") full range cone speaker x 2

Nominal Input Power 30W

Maximum Input Power 100W

Impedance 6Ω

Frequency Response

<NX-E130> 100 Hz to 25 kHz

<NX-C130> 80 Hz to 25 kHz

Sensitivity 86 dB/2.83V/m

Dimensions (W x H x D)

<NX-E130> 72 mm x 164 mm x 111 mm
(2-13/16" x 6-7/16" x 4-3/8")

<NX-C130> 300 mm x 72 mm x 110 mm
(11-13/16" x 2-13/16" x 4-5/16")

Weight

<NX-E130> 0.9 kg (2 lbs.)

<NX-C130> 1.1 kg (2 lbs. 7 oz.)

■ SW-P130

Type Advanced Yamaha Active Servo Technology
Magnetic shielding type

Driver 16 cm (6-1/2") cone woofer

Amplifier Output

U.S.A. and Canada models 55 W/5Ω

Other models 50 W/5Ω

Dynamic Power 100 W/5Ω

Frequency Response 30 Hz to 200 Hz

Power Supply

U.S.A. and Canada models AC 120V, 60 Hz

U.K. and Europe models AC 230V, 50 Hz

Australia model AC 240V, 50 Hz

China, Korean and General models

..... AC 110-120/220-240V, 50/60 Hz

Power Consumption 60 W

(In the standby mode: 0.8 W)

Dimensions (W x H x D) 200 mm x 365 mm x 375 mm

(7-7/8" x 14-7/20" x 14-3/4")

Weight 8.5 kg (18 lbs. 11 oz.)

* Specifications are subject to change without notice due to product improvements.



© 2005 YAMAHA CORPORATION All rights reserved.

YAMAHA ELECTRONICS CORPORATION, USA 6660 ORANGETHORPE AVE., BUENA PARK, CALIF. 90620, U.S.A.
YAMAHA CANADA MUSIC LTD. 135 MILNER AVE., SCARBOROUGH, ONTARIO M1S 3R1, CANADA
YAMAHA ELECTRONIK EUROPA G.m.b.H. SIEMENSSTR. 22-34, 25462 RELLINGEN BEI HAMBURG, GERMANY
YAMAHA ELECTRONIQUE FRANCE S.A. RUE AMBROISE CROIZAT BP70 CROISSY-BEAUBOURG 77312 MARNE-LA-VALLEE CEDEX02, FRANCE
YAMAHA ELECTRONICS (UK) LTD. YAMAHA HOUSE, 200 RICKMANSWORTH ROAD WATFORD, HERTS WD1 7JS, ENGLAND
YAMAHA SCANDINAVIA A.B. J A WETTERGRENS GATA 1, BOX 30053, 400 43 VÄSTRA FRÖLUNDA, SWEDEN
YAMAHA MUSIC AUSTRALIA PTY, LTD. 17-33 MARKET ST., SOUTH MELBOURNE, 3205 VIC., AUSTRALIA

YAMAHA CORPORATION
Printed in China ◀ WF51940



RX-V459DAB

AV Receiver

OWNER'S MANUAL

CAUTION: READ THIS BEFORE OPERATING YOUR UNIT.

- 1 To assure the finest performance, please read this manual carefully. Keep it in a safe place for future reference.
- 2 Install this sound system in a well ventilated, cool, dry, clean place – away from direct sunlight, heat sources, vibration, dust, moisture, and/or cold. Allow ventilation space of at least 30 cm on the top, 20 cm on the left and right, and 20 cm on the back of this unit.
- 3 Locate this unit away from other electrical appliances, motors, or transformers to avoid humming sounds.
- 4 Do not expose this unit to sudden temperature changes from cold to hot, and do not locate this unit in a environment with high humidity (i.e. a room with a humidifier) to prevent condensation inside this unit, which may cause an electrical shock, fire, damage to this unit, and/or personal injury.
- 5 Avoid installing this unit where foreign object may fall onto this unit and/or this unit may be exposed to liquid dripping or splashing. On the top of this unit, do not place:
 - other components, as they may cause damage and/or discoloration on the surface of this unit.
 - burning objects (i.e. candles), as they may cause fire, damage to this unit, and/or personal injury.
 - containers with liquid in them, as they may fall and liquid may cause electrical shock to the user and/or damage to this unit.
- 6 Do not cover this unit with a newspaper, tablecloth, curtain, etc. in order not to obstruct heat radiation. If the temperature inside this unit rises, it may cause fire, damage to this unit, and/or personal injury.
- 7 Do not plug in this unit to a wall outlet until all connections are complete.
- 8 Do not operate this unit upside-down. It may overheat, possibly causing damage.
- 9 Do not use force on switches, knobs and/or cords.
- 10 When disconnecting the power cable from the wall outlet, grasp the plug; do not pull the cord.
- 11 Do not clean this unit with chemical solvents; this might damage the finish. Use a clean, dry cloth.
- 12 Only voltage specified on this unit must be used. Using this unit with a higher voltage than specified is dangerous and may cause fire, damage to this unit, and/or personal injury. YAMAHA will not be held responsible for any damage resulting from use of this unit with a voltage other than specified.
- 13 To prevent damage by lightning, keep the power cable and outdoor antennas disconnected from a wall outlet or this unit during a lightning storm.
- 14 Do not attempt to modify or fix this unit. Contact qualified YAMAHA service personnel when any service is needed. The cabinet should never be opened for any reasons.
- 15 When not planning to use this unit for long periods of time (i.e. vacation), disconnect the AC power plug from the wall outlet.
- 16 Install this unit near the AC wall outlet where the power cable plug can be reached easily.
- 17 Be sure to read the “TROUBLESHOOTING” section on common operating errors before concluding that this unit is faulty.
- 18 Before moving this unit, press STANDBY/ON to set this unit in the standby mode, and then disconnect the power cable from the AC wall outlet.

WARNING

TO REDUCE THE RISK OF FIRE OR ELECTRIC SHOCK, DO NOT EXPOSE THIS UNIT TO RAIN OR MOISTURE.

This unit is not disconnected from the AC power source as long as it is connected to the wall outlet, even if this unit itself is turned off. In this state, this unit is designed to consume a very small quantity of power.

■ For U.K. customers

If the socket outlets in the home are not suitable for the plug supplied with this appliance, it should be cut off and an appropriate 3 pin plug fitted. For details, refer to the instructions described below.

Note

The plug severed from the mains lead must be destroyed, as a plug with bared flexible cord is hazardous if engaged in a live socket outlet.

■ Special Instructions for U.K. Model

IMPORTANT

THE WIRES IN MAINS LEAD ARE COLOURED IN ACCORDANCE WITH THE FOLLOWING CODE:

Blue: NEUTRAL

Brown: LIVE

As the colours of the wires in the mains lead of this apparatus may not correspond with the coloured markings identifying the terminals in your plug, proceed as follows:

The wire which is coloured BLUE must be connected to the terminal which is marked with the letter N or coloured BLACK. The wire which is coloured BROWN must be connected to the terminal which is marked with the letter L or coloured RED.

Making sure that neither core is connected to the earth terminal of the three pin plug.

CONTENTS

INTRODUCTION

FEATURES	2
GETTING STARTED	3
Supplied accessories	3
Installing batteries in the remote control	3
CONTROLS AND FUNCTIONS	4
Front panel.....	4
Remote control.....	6
Front panel display	8
Rear panel	10

PREPARATION

CONNECTIONS	11
Placing speakers.....	11
Connecting speakers	12
Information on jacks and cable plugs	14
Audio and video signal flow.....	15
Connecting a TV	16
Connecting a DVD player, a DVD recorder, a VCR or an STB.....	17
Connecting a CD player, an MD player or a tape deck.....	19
Connecting a multi-format player or an external decoder	20
Connecting a game console, a video camera or a portable audio player	20
Connecting the FM and AM antennas.....	21
Connecting the DAB antenna	22
Connecting the power cable.....	23
Setting the speaker impedance.....	24
Turning on this unit and setting it to the standby mode	25
BASIC SETUP	26

BASIC OPERATION

PLAYBACK	29
USING OTHER FEATURES	31
Using SILENT CINEMA	31
Muting the audio output.....	31
Selecting the night listening mode.....	31
Selecting the input mode	32
Using the sleep timer	33
Adjusting the speaker level.....	34
Selecting the Compressed Music Enhancer mode... ..	35
Selecting the MULTI CH INPUT component.....	36
Enjoying multi-channel sources in 2-channel stereo.....	36
Enjoying unprocessed input sources.....	36
Enjoying pure hi-fi stereo sound.....	37
Displaying the input source information	37
Playing video sources in the background	38

ENJOYING SURROUND SOUND	39
Enjoying multi-channel sources in surround	39
Enjoying 2-channel sources in surround.....	40
Using Virtual CINEMA DSP	41

RECORDING	42
------------------------	----

FM/AM TUNING	43
Automatic tuning	43
Manual tuning.....	44
Automatic preset tuning.....	45
Manual preset tuning	46
Selecting preset stations.....	47
Exchanging preset stations	48

RADIO DATA SYSTEM TUNING	50
---------------------------------------	----

Selecting the Radio Data System program	50
Using the Radio Data System station network	51
Displaying the Radio Data System information	52

DAB (DIGITAL AUDIO BROADCASTING)	
---	--

TUNING	54
Preparing the DAB tuning	55
DAB tuning.....	56
DAB preset tuning	57
Selecting preset DAB services.....	58
DAB service information.....	59
Using DAB MENU	61

SOUND FIELD PROGRAMS

SOUND FIELD PROGRAMS	66
Selecting sound field programs	66
Sound field program descriptions.....	67
Changing sound field parameter settings.....	69
Sound field program speaker layouts	75

ADVANCED OPERATION

SET MENU	78
Using SET MENU	80
1 SOUND MENU.....	82
2 INPUT MENU.....	85
3 DAB MENU	86
4 OPTION MENU	87

ADVANCED SETUP	88
-----------------------------	----

REMOTE CONTROL FEATURES	90
--------------------------------------	----

Controlling this unit, a TV, or other components	90
Setting remote control codes	92

RESETTING THE SYSTEM	93
-----------------------------------	----

ADDITIONAL INFORMATION

TROUBLESHOOTING	94
------------------------------	----

GLOSSARY	99
-----------------------	----

Audio information	99
Video information.....	101
Sound field program information	101
DAB frequency information.....	102

SPECIFICATIONS	103
-----------------------------	-----

INTRODUCTION

PREPARATION

BASIC
OPERATION

SOUND FIELD
PROGRAMS

ADVANCED
OPERATION

ADDITIONAL
INFORMATION

FEATURES

Built-in 6-channel power amplifier

- ◆ Minimum RMS output power (0.06% THD, 20 Hz to 20 kHz, 8 Ω)
Front: 90 W + 90 W
Center: 90 W
Surround: 90 W + 90 W
Surround back: 90 W

Sound field features

- ◆ Proprietary YAMAHA technology for the creation of sound fields
- ◆ Dolby Digital/Dolby Digital EX decoder
- ◆ DTS/DTS-ES Matrix 6.1, Discrete 6.1, DTS Neo:6, DTS 96/24 decoder
- ◆ Dolby Pro Logic/Dolby Pro Logic II/Dolby Pro Logic IIx decoder
- ◆ Virtual CINEMA DSP
- ◆ SILENT CINEMA™

Sophisticated AM/FM tuner

- ◆ 40-station random and direct preset tuning
- ◆ Automatic preset tuning
- ◆ Preset station shifting capability (preset editing)

Radio Data System

- ◆ Radio Data System tuning capability

DAB (Digital Audio Broadcasting)

- ◆ DAB (Digital Audio Broadcasting) tuning capability
- ◆ DLS (Dynamic Label Segment) information display
- ◆ Initial scan function to locate all DAB services in your area
- ◆ Tuning aid function to optimize DAB reception

Other features

- ◆ 192-kHz/24-bit D/A converter
- ◆ 6 additional input jacks for discrete multi-channel input
- ◆ S-video signal input/output capability
- ◆ Component video input/output capability (3 COMPONENT VIDEO INs and 1 MONITOR OUT)
- ◆ Optical and coaxial digital audio signal jacks
- ◆ Sleep timer
- ◆ Cinema and music night listening modes
- ◆ Remote control with preset remote control codes
- ◆ PORTABLE mini analog input jack on the front panel for a portable audio player
- ◆ Compressed Music Enhancer mode to improve the sound quality of compression artifacts (such as the MP3 format) to that of a high-quality stereo

Notes

- ☼ indicates a tip for your operation.
- Some operations can be performed by using either the buttons on the front panel or the ones on the remote control. In case the button names differ between the front panel and the remote control, the button name on the remote control is given in parentheses.
- This manual is printed prior to production. Design and specifications are subject to change in part as a result of improvements, etc. In case of differences between the manual and product, the product has priority.



Manufactured under license from Dolby Laboratories.
“Dolby”, “Pro Logic”, and the double-D symbol are trademarks of Dolby Laboratories.



Manufactured under license from Digital Theater Systems, Inc.
“DTS”, “DTS-ES”, “NEO:6”, and “DTS 96/24” are trademarks of Digital Theater Systems, Inc. Copyright 1996, 2003 Digital Theater Systems, Inc. All right reserved.

SILENT™
CINEMA

“SILENT CINEMA” is a trademark of YAMAHA CORPORATION.



The “DAB Digital Radio” logo and the stylised “r” mark ® and © Digital One Limited.



Digital Audio Broadcasting

This receiver supports DAB tuning.

GETTING STARTED

Supplied accessories

Check that you received all of the following parts.

Remote control

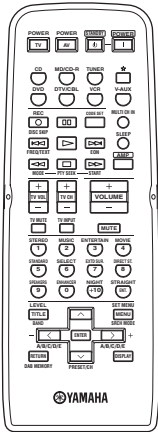

Batteries (2)
(AA, R6, UM-3)

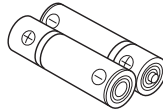

AM loop antenna



Indoor FM antenna

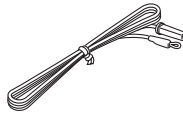

Indoor DAB antenna

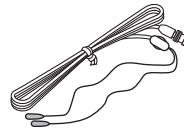

Installing batteries in the remote control

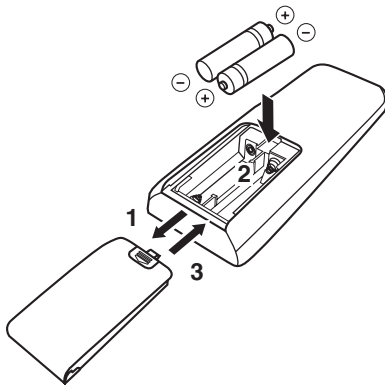

Notes

- Change all of the batteries if you notice a decrease in the operation range of the remote control.
- Do not use an old battery together with a new one.
- Do not use different types of batteries (such as alkaline and manganese batteries) together. Read the packaging carefully as these different types of batteries may have the same shape and color.
- If the batteries have leaked, dispose of them immediately. Avoid touching the leaked material or letting it come into contact with clothing, etc. Clean the battery compartment thoroughly before installing new batteries.
- Do not throw away batteries with general house waste; dispose of them correctly in accordance with your local regulations.
- If the remote control is without batteries for more than 2 minutes, or if exhausted batteries remain in the remote control, the contents of the memory may be cleared. When the memory is cleared, insert new batteries, set up the remote control code and program any acquired functions that may have been cleared.

1 Press the  part and slide the battery compartment cover off.

2 Insert the two supplied batteries (AA, R6, UM-3) according to the polarity markings (+ and -) on the inside of the battery compartment.

3 Slide the cover back until it snaps into place.

CONTROLS AND FUNCTIONS

Front panel

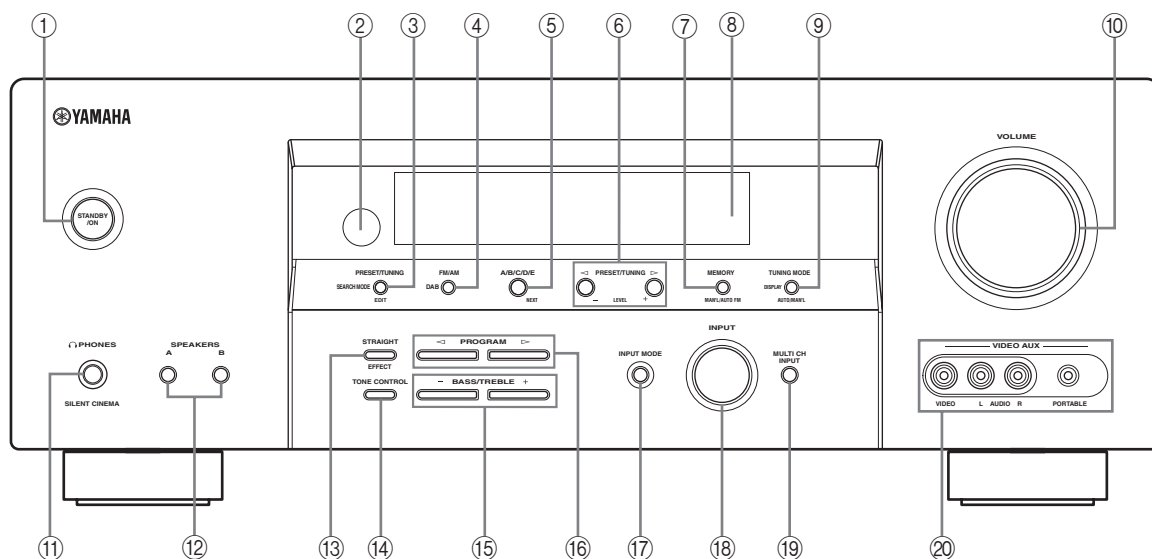

① **STANDBY/ON**

Turns on this unit or sets it to the standby mode (see page 25).

Notes

- In the standby mode, this unit consumes a small amount of power in order to receive infrared signals from the remote control.
- When you turn on this unit, there will be a 4 to 5-second delay before this unit can reproduce sound.

② **Remote control sensor**

Receives signals from the remote control (see page 7).

③ **PRESET/TUNING, EDIT, SEARCH MODE**

- Switches the function of PRESET/TUNING $\triangleleft/\triangleright$ between selecting preset station numbers and selecting the tuning frequency when this unit is in the FM/AM tuning mode.
- Edits the assignments of preset stations when this unit is in the FM/AM tuning mode (see page 47).
- Switches between the five DAB tuning methods when this unit is in the DAB tuning mode (see page 56).

④ **FM/AM, DAB**

Switches the reception band between FM, AM and DAB when “TUNER” is selected as the input source (See page 43 and 56).

⑤ **A/B/C/D/E, NEXT**

- Selects one of the 5 preset station groups (A to E) when this unit is in the FM/AM tuning mode. (see page 43).
- Selects the DAB service on top of the list when this unit is in the DAB tuning mode (see page 57).
- Selects the speaker channel whose output level you want to adjust when “TUNER” is not selected as the input source (see page 34).

⑥ **PRESET/TUNING $\triangleleft/\triangleright$, LEVEL +/-**

- Selects one of the 8 preset station numbers (1 to 8) when this unit is in the FM/AM tuning mode. The colon (:) is displayed in the front panel display (see page 47).
- Selects the tuning frequency when this unit is in the FM/AM tuning mode. The colon (:) is not displayed in the front panel display (see page 44).
- Browses through the list of stored or preset DAB services when this unit is in the DAB tuning mode (see page 57).
- Adjusts the level of the speaker channel selected using NEXT when “TUNER” is not selected as the input source (see page 34).

⑦ **MEMORY (MAN'L/AUTO FM)**

- Stores a preset station in the memory when this unit is in the FM/AM tuning mode. Hold down this button for more than 3 seconds to start automatic preset tuning (see page 45).
- Stores a preset DAB service in the memory when this unit is in the DAB tuning mode (see page 57).

⑧ Front panel display

Shows information about the operational status of this unit (see page 8).

⑨ TUNING MODE (AUTO/MAN'L), DISPLAY

- Switches between automatic tuning (the AUTO indicator is turned on) and manual tuning (the AUTO indicator is turned off) when this unit is in the FM/AM tuning mode (see page 43).
- Displays various information about the DAB service currently being broadcast when this unit is in the DAB tuning mode (see page 59).

⑩ VOLUME

Controls the output level of all audio channels.



This does not affect the AUDIO OUT (REC) level.

⑪ PHONES (SILENT CINEMA) jack

Outputs audio signals for private listening with headphones (see page 31).

Notes

- When you connect headphones, no signals are output at the SUBWOOFER OUTPUT jack or the speaker terminals.
- All Dolby Digital and DTS audio signals are mixed down to the left and right headphone channels.

⑫ SPEAKERS A/B

Turns on or off the set of front speakers connected to the A and/or B terminals on the rear panel each time the corresponding button is pressed.

⑬ STRAIGHT (EFFECT)

Turns the sound field programs off or on. When "STRAIGHT" is selected, 2-channel or multi-channel input signals are output directly from their respective speakers without effect processing (see page 36).

⑭ TONE CONTROL

Selects "BASS" or "TREBLE" to adjust the total balance of the front left and right speakers in conjunction with BASS/TREBLE +/- buttons (see page 30).

⑮ BASS/TREBLE +/-

Adjusts the bass/treble balance of the front left and right speakers in conjunction with TONE CONTROL (see page 30).

⑯ PROGRAM ◀ / ▶

Selects sound field programs (see page 66).

⑰ INPUT MODE

Selects either digital or analog input signals exclusively or sets this unit to automatically detect the type of input signals and select the corresponding input signals when one component is connected via both digital and analog connections (see page 32).

⑱ INPUT selector

Selects the desired input source.

⑲ MULTI CH INPUT

Selects the input source connected to the MULTI CH INPUT jacks (see page 36).

Note

The input source connected to the MULTI CH INPUT jacks takes priority over the source selected with the INPUT selector on the front panel (or the input selector buttons on the remote control).

⑳ VIDEO AUX jacks

Input audio and video signals from a portable external source such as a game console, a video camera or a portable audio player (see page 20).



To reproduce the source signals input at these jacks, select "V-AUX" as the input source.

Note

The audio signals input at the PORTABLE mini jack take priority over the ones input at the AUDIO L/R jacks.

Remote control

This section describes the function of each control on the remote control used to control this unit. To operate other components, see “REMOTE CONTROL FEATURES” on page 90.

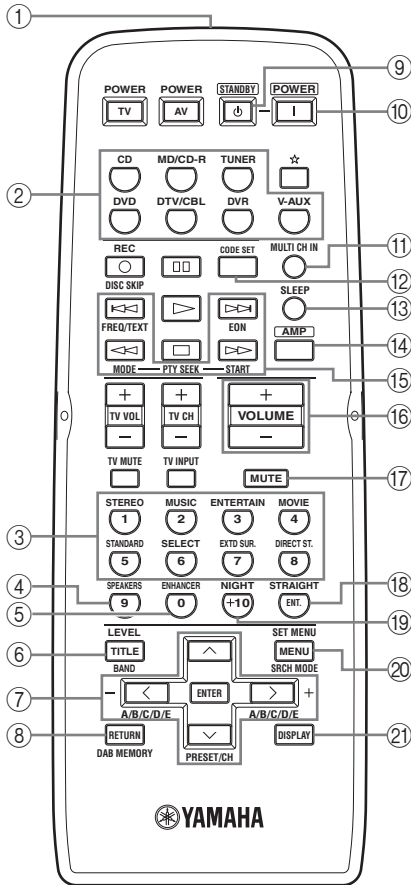

■ Controlling this unit

Press AMP to control this unit.

① Infrared signal transmitter

Outputs infrared control signals. Aim the transmitter at the component you want to operate (see page 7).

② Input selector buttons

Select the input source.

③ Sound field program selector buttons

Select sound field programs (see page 66).

- Use SELECT to play back 2-channel sources in surround (see page 40).
- Use EXT D SUR. to switch between 5.1 and 6.1-channel playback of multi-channel sources (see page 39).
- Use DIRECT ST. to play back 2-channel sources in hi-fi stereo sound (see page 37).

④ SPEAKERS

Turns on or off the set of front speakers connected to the FRONT A and/or B terminals on the rear panel. Press this button repeatedly to toggle as follows:

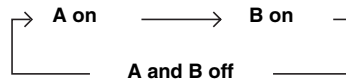

⑤ ENHANCER

Turns on or off the Compressed Music Enhancer mode (see page 35).

⑥ LEVEL

Selects the speaker channel to be adjusted (see page 34).

⑦ Cursor buttons $\wedge / \vee / \langle / \rangle$, ENTER

Select and adjust the sound field program parameters or the “SET MENU” parameters.

⑧ RETURN

Returns to the previous menu level when adjusting the “SET MENU” parameters.

⑨ STANDBY

Sets this unit to the standby mode (see page 25).

⑩ POWER

Turns on this unit (see page 25).

⑪ MULTI CH IN

Selects the component connected to the MULTI CH INPUT jacks as the input source when using an external decoder, etc. (see page 36).

⑫ CODE SET

Use to set up remote control codes (see page 92).

⑬ SLEEP

Sets the sleep timer (see page 33).

⑭ AMP

Sets the remote control to the operation mode of this unit.

⑮ VOLUME +/-

Controls the output level of all audio channels.

Note

This does not affect the AUDIO OUT (REC) level.

⑰ MUTE

Mutes the audio output. Press again to restore the audio output to the previous volume level (see page 31).

⑱ STRAIGHT

Turns the sound field programs off or on. When "STRAIGHT" is selected, 2-channel or multi-channel input signals are output directly from their respective speakers without effect processing (see page 36).

⑲ NIGHT

Turns on or off the night listening modes (see page 31).

⑳ SET MENU

Enters "SET MENU" (see page 80).

■ Controlling the TUNER (FM/AM and DAB) functions

Press TUNER to control the TUNER functions.

③④⑤ Numeric buttons

- Use numbers 1 through 8 to select preset stations when this unit is in the FM/AM tuning mode (see page 48).
- Select preset DAB services when this unit is in the DAB tuning mode (see page 58).

⑥ BAND

Switches the reception band between FM, AM and DAB (see page 43).

⑦ A/B/C/D/E </>, PRESET/CH ^ / v

- Press A/B/C/D/E </> to select a preset station group (A to E) and PRESET/CH ^ / v to select a preset station number (1 to 8) when this unit is in the FM/AM tuning mode (see page 47).
- Press PRESET/CH ^ / v to select a service number when this unit is in the DAB tuning mode (see page 58).

⑧ DAB MEMORY

Stores a preset DAB service in the memory when this unit is in the DAB tuning mode (see page 57).

⑮ Radio Data System tuning buttons**FREQ/TEXT**

Switches the Radio Data System display between the PS mode, PTY mode, RT mode, CT mode (if the station offers the corresponding data services) and the frequency display (see page 52).

PTY SEEK MODE

Sets this unit to the PTY SEEK mode (see page 50).

PTY SEEK START

Starts searching for a station once the desired program type is selected in the PTY SEEK mode (see page 51).

EON

Selects a program type (NEWS, AFFAIRS, INFO, or SPORT) for automatic tuning (see page 52).

⑳ SRCH MODE

Switches between the five DAB tuning methods when this unit is in the DAB tuning mode (see page 56).

㉑ DISPLAY

Displays various information of the service currently being broadcast when this unit is in the DAB tuning mode (see page 59).

■ Using the remote control

The remote control transmits a directional infrared ray. Be sure to aim the remote control directly at the remote control sensor on the main unit during operation.

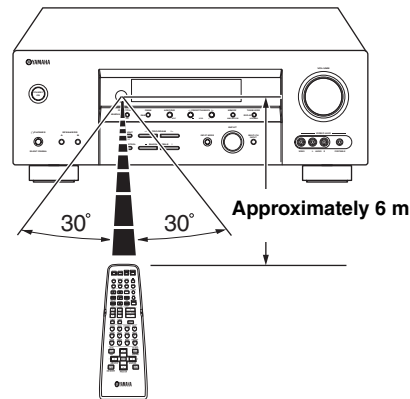
**Notes**

- Do not spill water or other liquids on the remote control.
- Do not drop the remote control.
- Do not leave or store the remote control in the following types of conditions:
 - places of high humidity, such as near a bath
 - places of high temperatures, such as near a heater or stove
 - places of extremely low temperatures
 - dusty places

Front panel display

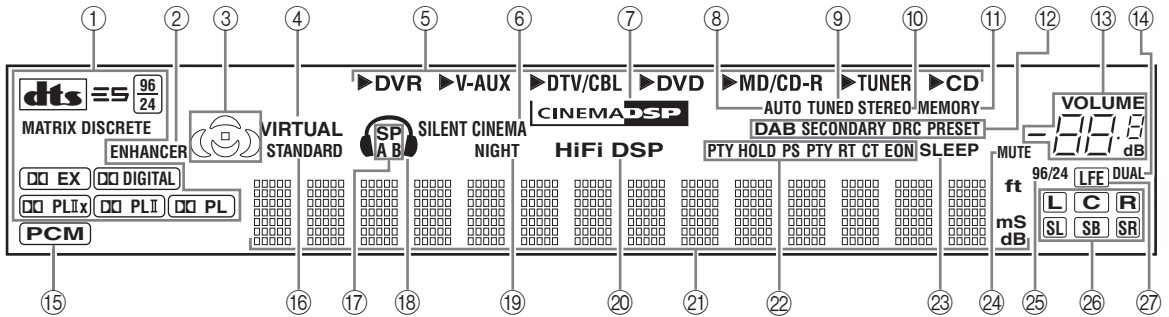

① Decoder indicators

The respective indicator lights up when any of the decoders of this unit function.

② ENHANCER indicator

Lights up when the Compressed Music Enhancer mode is turned on (see page 35).

③ Sound field indicators

Light up to indicate the active DSP sound fields.

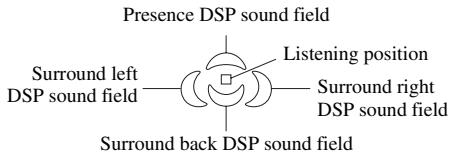

④ VIRTUAL indicator

Lights up when Virtual CINEMA DSP is active (see page 41).

⑤ Input source indicators

The corresponding cursor lights up to show the currently selected input source.

⑥ SILENT CINEMA indicator

Lights up when headphones are connected and a sound field program is selected (see page 31).

⑦ CINEMA DSP indicator

Lights up when you select a CINEMA DSP sound field program (see page 67).

⑧ AUTO indicator

Lights up when this unit is in the automatic tuning mode (see page 43).

⑨ TUNED indicator

Lights up when this unit is tuned into a station (see page 43).

⑩ STEREO indicator

- Lights up when this unit is receiving a strong signal for an FM stereo broadcast while the AUTO indicator is lit (see page 43).
- Lights up when this unit is receiving a stereo DAB service.

⑪ MEMORY indicator

Flashes to show that a station can be stored (see page 45).

⑫ DAB indicators

Indicate the current DAB tuning status when this unit is in the DAB tuning mode (see pages 56 to 65).

⑬ VOLUME level indicator

Indicates the current volume level.

⑭ DUAL indicator

Lights up when dual monaural signals are being input to this unit when this unit is in the DAB tuning mode.

⑮ PCM indicator

Lights up when this unit is reproducing PCM (Pulse Code Modulation) digital audio signals.

⑯ STANDARD indicator

Lights up when the “SUR. STANDARD” or “SUR. ENHANCED” programs are selected (see page 40).

⑰ SP A B indicators

Light up according to the set of front speakers selected.

⑱ Headphones indicator

Lights up when headphones are connected (see page 31).

⑲ NIGHT indicator

Lights up when you select a night listening mode (see page 31).

⑳ HiFi DSP indicator

Lights up when you select a HiFi DSP sound field program (see page 67).

⑳ Multi-information display

Shows the name of the current sound field program and other information when adjusting or changing settings.

㉑ Radio Data System indicators

Lights up when the Radio Data System data is being received.

EON

Lights up when the EON data service is being received.

PTY HOLD

Lights up while searching for the Radio Data System stations in the PTY SEEK mode.

㉒ SLEEP indicator

Lights up while the sleep timer is on (see page 33).

㉓ MUTE indicator

Flashes while the MUTE function is on (see page 31).

㉔ 96/24 indicator

Lights up when a DTS 96/24 signal is input to this unit.

㉕ Input channel indicators

Indicate the channel components of the current digital input signal (see page 27).

㉖ LFE indicator

Lights up when the input signal contains the LFE signal.

Rear panel

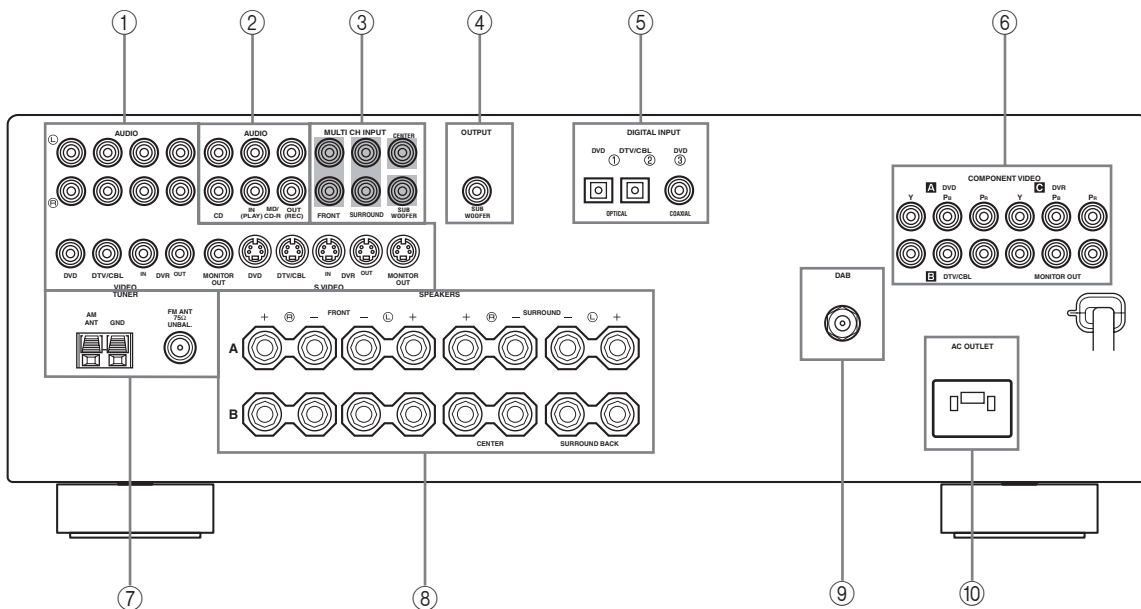

① Video component jacks

See pages 16 and 17 for connection information.

② Audio component jacks

See page 19 for connection information.

③ MULTI CH INPUT jacks

See page 20 for connection information.

④ SUBWOOFER OUTPUT jack

See page 13 for connection information.

⑤ DIGITAL INPUT jacks

See pages 17 and 18 for connection information.

⑥ COMPONENT VIDEO jacks

See pages 16 and 17 for connection information.

⑦ Antenna terminals

See page 21 for connection information.

⑧ Speaker terminals

See page 12 for connection information.

⑨ DAB antenna terminal

See page 22 for connection information.

⑩ AC OUTLET

Use to supply power to your other audiovisual components.

See page 23 for details.

CONNECTIONS

Placing speakers

The speaker layout below shows the standard ITU-R* speaker setting. You can use it to enjoy CINEMA DSP and multi-channel audio sources.

* ITU-R is the radio communication sector of the ITU (International Telecommunication Union).

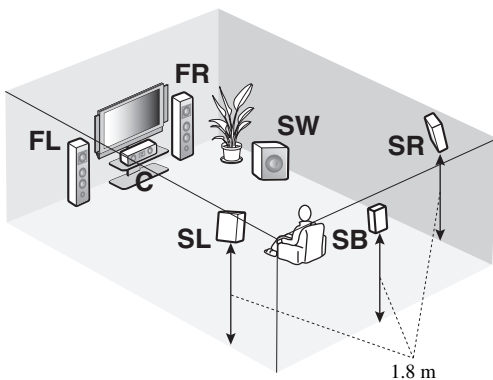
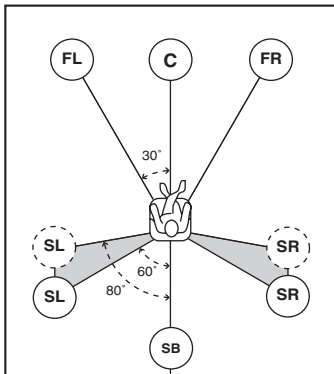

Front speakers (FL and FR)

The front speakers are used for the main source sound plus effect sounds. Place these speakers at an equal distance from the ideal listening position. The distance of each speaker from each side of the video monitor should be the same.

Center speaker (C)

The center speaker is for the center channel sounds (dialog, vocals, etc.). If for some reason it is not practical to use a center speaker, you can do without it. Best results, however, are obtained with the full system. Place the center speaker centrally between the front speakers and as close to the monitor as possible, such as directly over or under it.

Surround speakers (SL and SR)

The surround speakers are used for effect and surround sounds. Place these speakers behind your listening position, facing slightly inwards, about 1.8 m above the floor.

Surround back speaker (SB)

The surround back speaker supplements the surround speakers and provides more realistic front-to-back transitions. Place this speaker directly behind the listening position and at the same height as the surround speakers.

Subwoofer (SW)

The use of a subwoofer with a built-in amplifier, such as the YAMAHA Active Servo Processing Subwoofer System, is effective not only for reinforcing bass frequencies from any or all channels, but also for hi-fi stereo reproduction of the LFE (low-frequency effect) channel included in Dolby Digital and DTS sources. The position of the subwoofer is not so critical, because low bass sounds are not highly directional. But it is better to place the subwoofer near the front speakers. Turn it slightly toward the center of the room to reduce wall reflections.

Connecting speakers

Be sure to connect the left channel (L), right channel (R), “+” (red) and “-” (black) properly. If the connections are faulty, no sound will be heard from the speakers, and if the polarity of the speaker connections is incorrect, the sound will be unnatural and lack bass.

CAUTION

- Before connecting the speakers, make sure that this unit is in the standby mode (see page 25).
- Do not let the bare speaker wires touch each other or do not let them touch any metal part of this unit. This could damage this unit and/or speakers.
- Use magnetically shielded speakers. If this type of speakers still creates the interference with the monitor, place the speakers away from the monitor.
- If you are to use 6 ohm speakers, be sure to set “SP IMP.” to “6ΩMIN” before using this unit (see page 24). 4 ohm speakers can be also used as the front speakers (see page 89).

Notes

- A speaker cord is actually a pair of insulated cables running side by side. Cables are colored or shaped differently, perhaps with a stripe, groove or ridge. Connect the striped (grooved, etc.) cable to the “+” (red) terminals of this unit and your speaker. Connect the plain cable to the “-” (black) terminals.
- The low-frequency signals of other speakers set to “SML” (or “SMALL”) to “NONE” in “SPEAKER SET” (see page 82) are directed to the speakers selected in “BASS OUT” (see page 82).

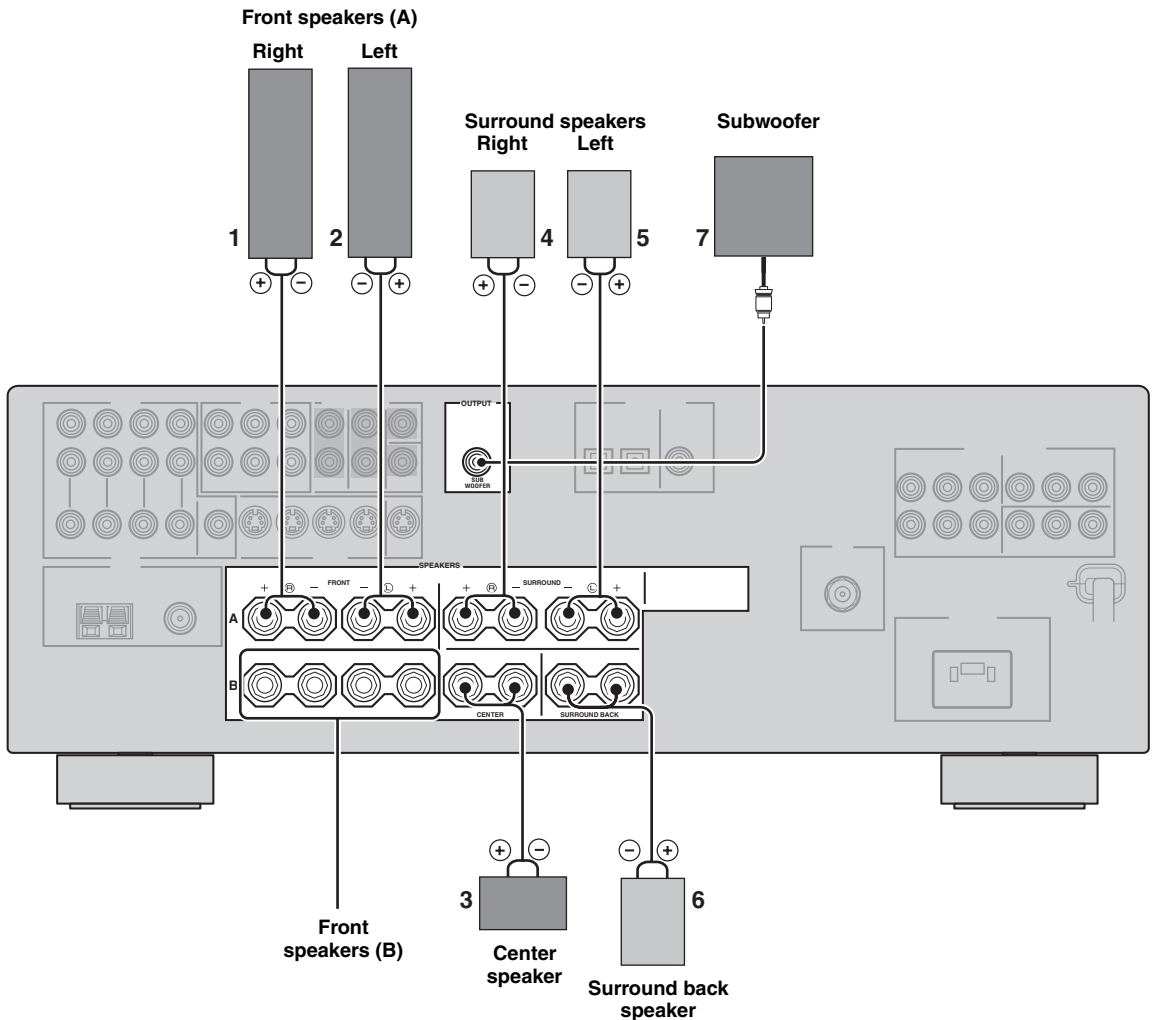

FRONT terminals

Connect one or two front speaker systems (1, 2) to these terminals. If you use only one front speaker system, connect it to the FRONT A or B terminal.

CENTER terminals

Connect a center speaker (3) to these terminals.

SURROUND terminals

Connect surround speakers (4, 5) to these terminals.

SURROUND BACK terminals

Connect a surround back speaker (6) to these terminals.

SUBWOOFER jack

Connect a subwoofer with a built-in amplifier (7) (such as the YAMAHA Active Servo Processing Subwoofer System) to this jack.

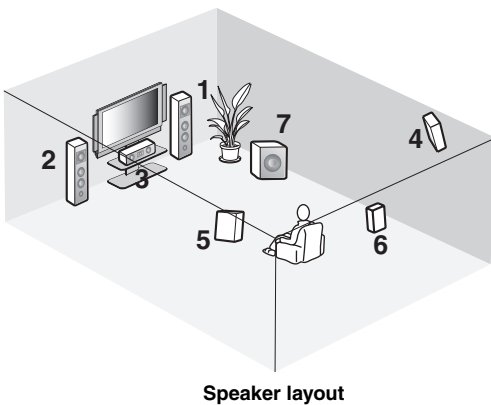

■ Connecting the speaker cable

- 1 Remove approximately 10 mm of insulation from the end of each speaker cable and then twist the exposed wires of the cable together to prevent short circuits.**

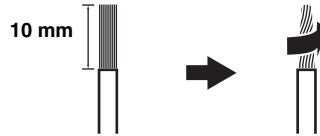

- 2 Loosen the knob.**

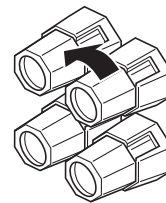

Red: positive (+)
Black: negative (-)

- 3 Insert one bare wire into the hole on the side of each terminal.**

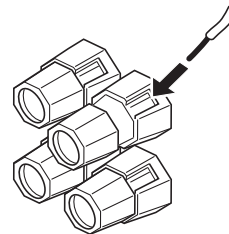

Red: positive (+)
Black: negative (-)

- 4 Tighten the knob to secure the wire.**

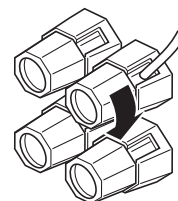

Red: positive (+)
Black: negative (-)

Information on jacks and cable plugs

Audio jacks and cables

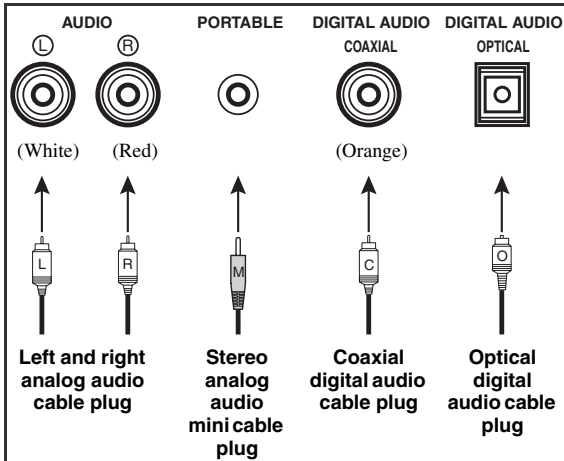

Video jacks and cables

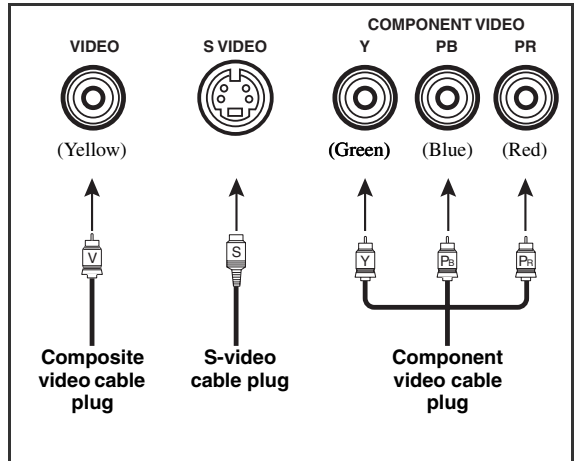

■ Audio jacks

This unit has four types of audio jacks. Connection depends on the availability of audio jacks on your other components.

AUDIO jacks

For conventional analog audio signals transmitted via left and right analog audio cables. Connect red plugs to the right jacks and white plugs to the left jacks.

PORTABLE jack

For analog audio signals transmitted via stereo analog audio mini cables.

DIGITAL AUDIO COAXIAL jacks

For digital audio signals transmitted via coaxial digital audio cables.

DIGITAL AUDIO OPTICAL jacks

For digital audio signals transmitted via optical digital audio cables.

Notes

- You can use the digital jacks to input PCM, Dolby Digital and DTS bitstreams. When you connect components to both the COAXIAL and OPTICAL jacks, priority is given to the signals input at the COAXIAL jack. All digital input jacks are compatible with 96-kHz sampling digital signals.
- Pull out the cap from the optical jack before you connect the fiber optic cable. Do not discard the cap. When you are not using the optical jack, be sure to put the cap back in place. This cap protects the jack from dust.

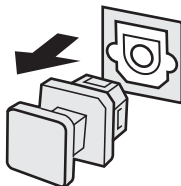

■ Video jacks

This unit has three types of video jacks. Connection depends on the availability of input jacks on your video monitor.

VIDEO jacks

For conventional composite video signals transmitted via composite video cables.

S VIDEO jacks

For S-video signals, separated into the luminance (Y) and chrominance (C) video signals transmitted on separate wires of S-video cables.

COMPONENT VIDEO jacks

For component video signals, separated into the luminance (Y) and chrominance (Pb, Pr) video signals transmitted on separate wires of component video cables.

Audio and video signal flow

■ Audio signal flow for AUDIO OUT (REC)

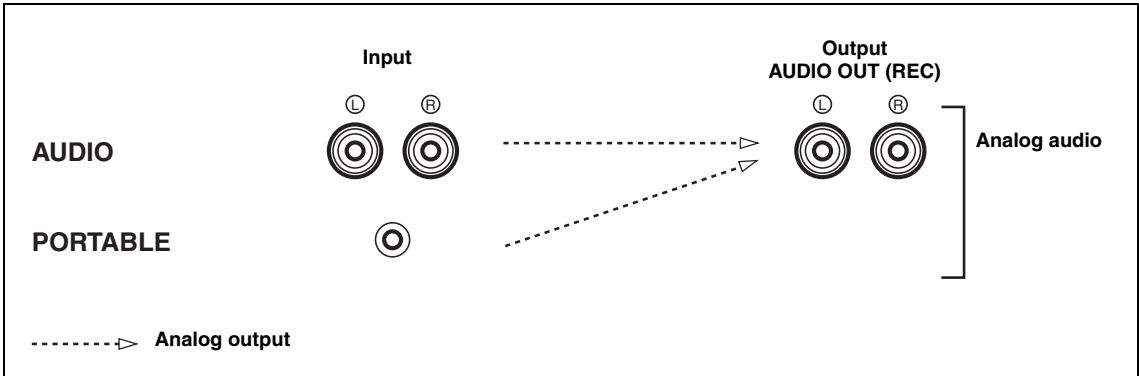

Note

This unit handles digital and analog signals independently. Thus, audio signals input at the analog jacks are output only at the analog AUDIO OUT (REC) jacks.

■ Video signal flow for MONITOR OUT

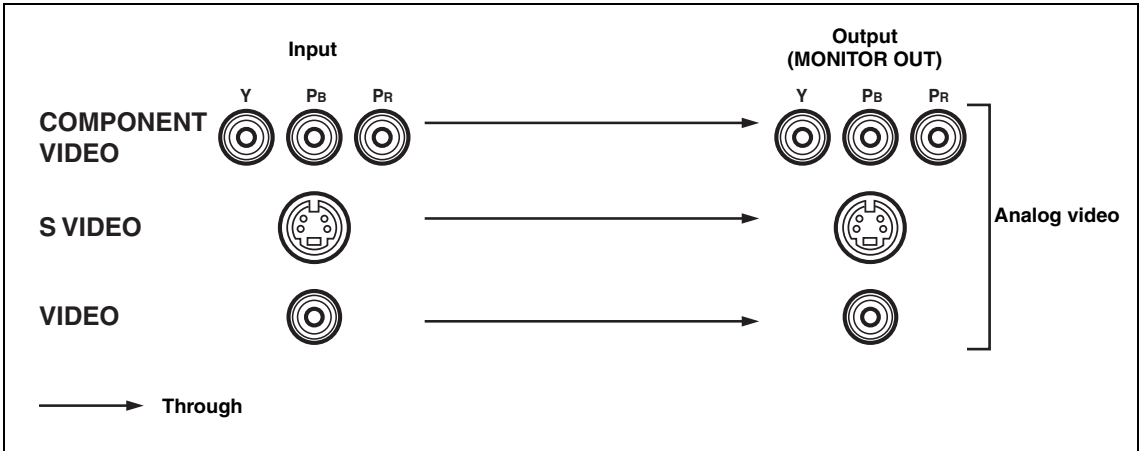

Connecting a TV

Connect your TV to the VIDEO MONITOR OUT jack, the S VIDEO MONITOR OUT jack or the COMPONENT VIDEO MONITOR OUT jacks of this unit.

CAUTION

Do not connect this unit or other components to the AC power supply until all connections between components are complete.

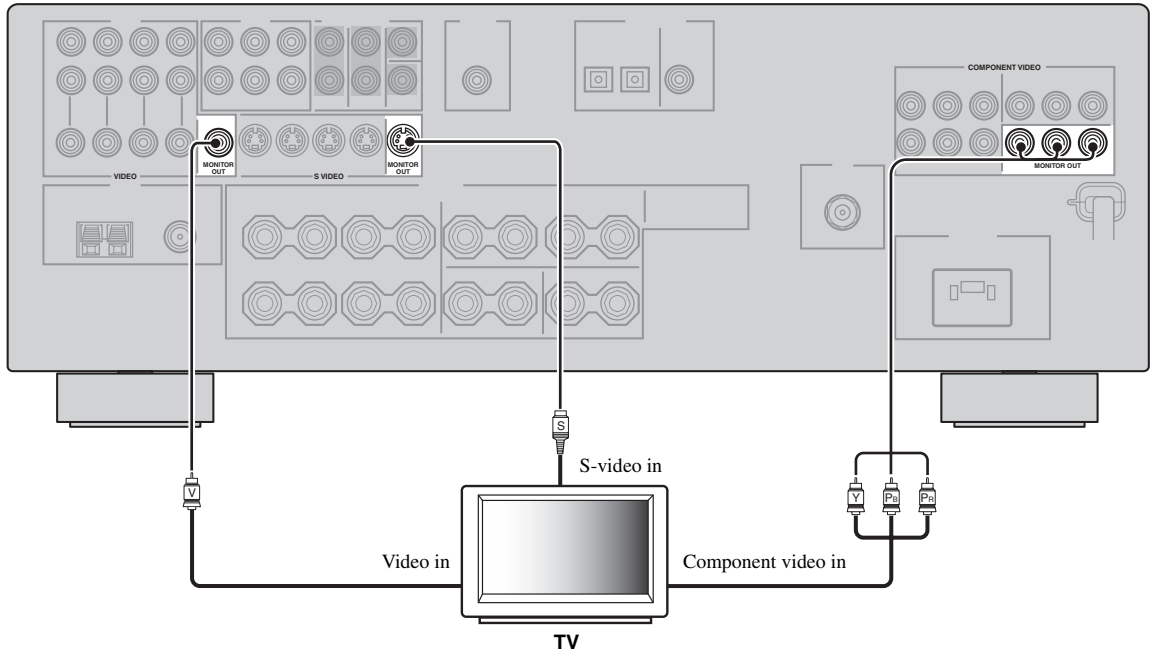

Connecting a DVD player, a DVD recorder, a VCR or an STB

Connect your DVD player, DVD recorder, VCR or STB (set-top box) using the same type of video connections as those made for your TV (see page 16). The cable TV receiver and the satellite receiver are examples of the STB.

CAUTION

Do not connect this unit or other components to the AC power supply until all connections between components are complete.

Notes

- Be sure to make the same type of video connections as those made for your TV (see page 16). For example, if you connected your TV to the VIDEO MONITOR OUT jack of this unit, connect your other components to the VIDEO jacks.
- To make a digital connection to a component other than the default component assigned to each DIGITAL INPUT jack, select the corresponding setting for "OPTICAL IN" or "COAXIAL IN" in "INPUT ASSIGN" (see page 85).
- If you connect your DVD player to both the DIGITAL INPUT (OPTICAL) and the DIGITAL INPUT (COAXIAL) jacks, priority is given to the signals input at the DIGITAL INPUT (COAXIAL) jack.

■ Connecting a DVD player

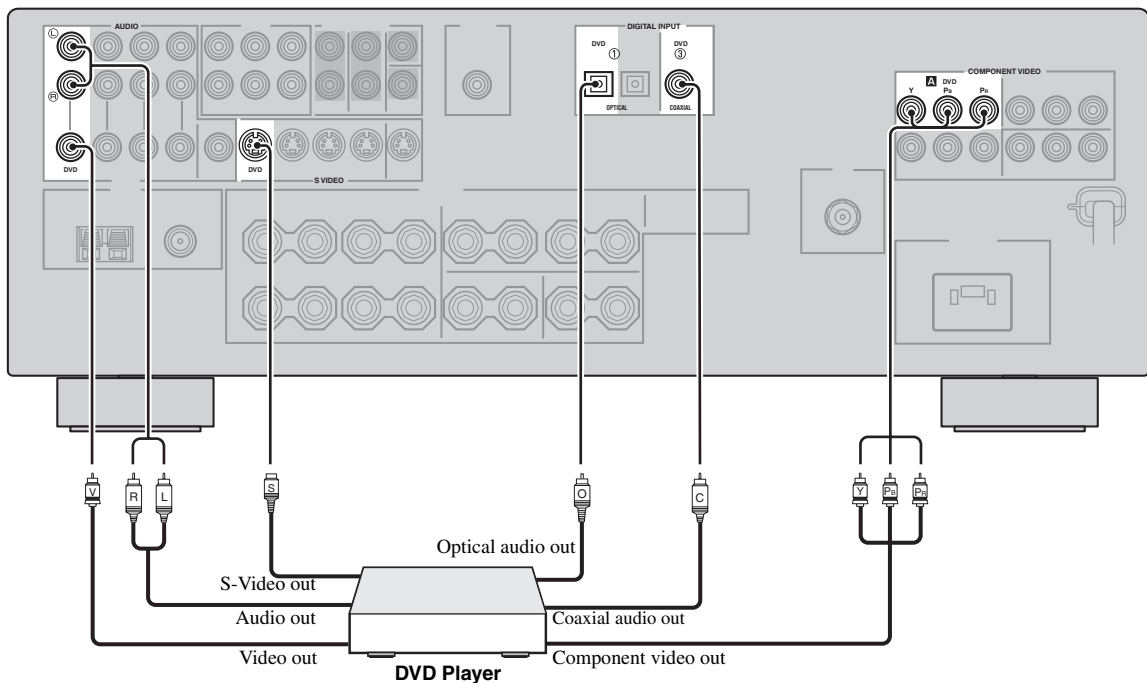

■ Connecting a DVD recorder or a VCR

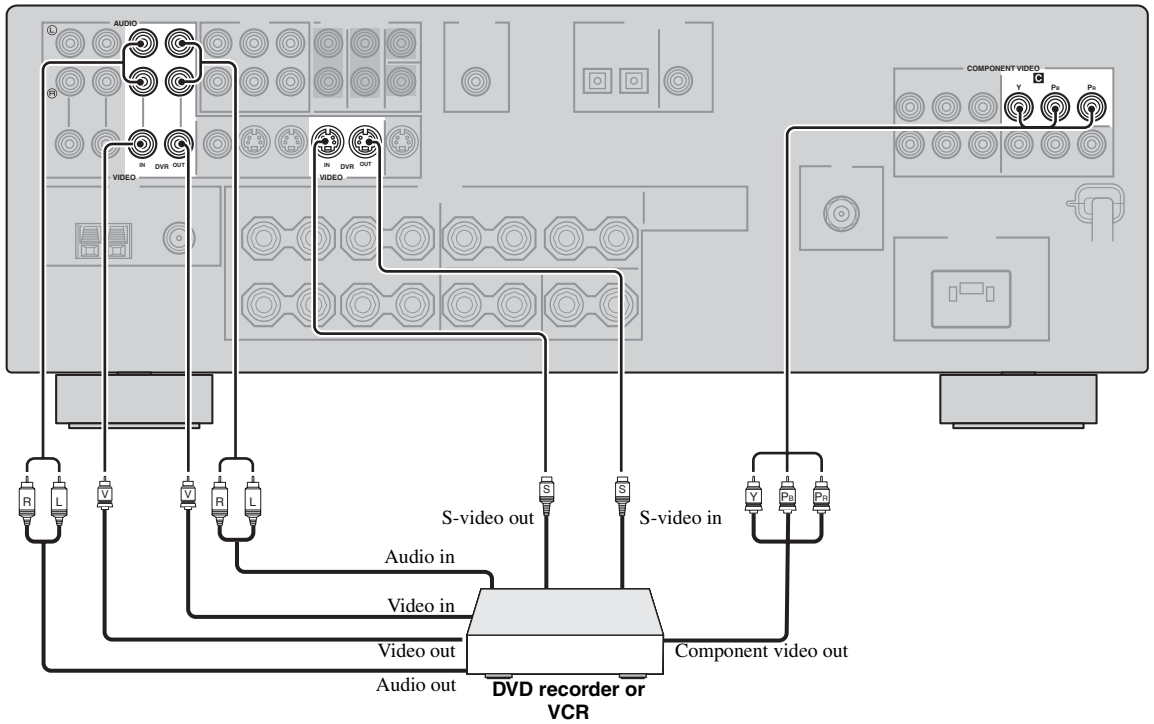

■ Connecting an STB

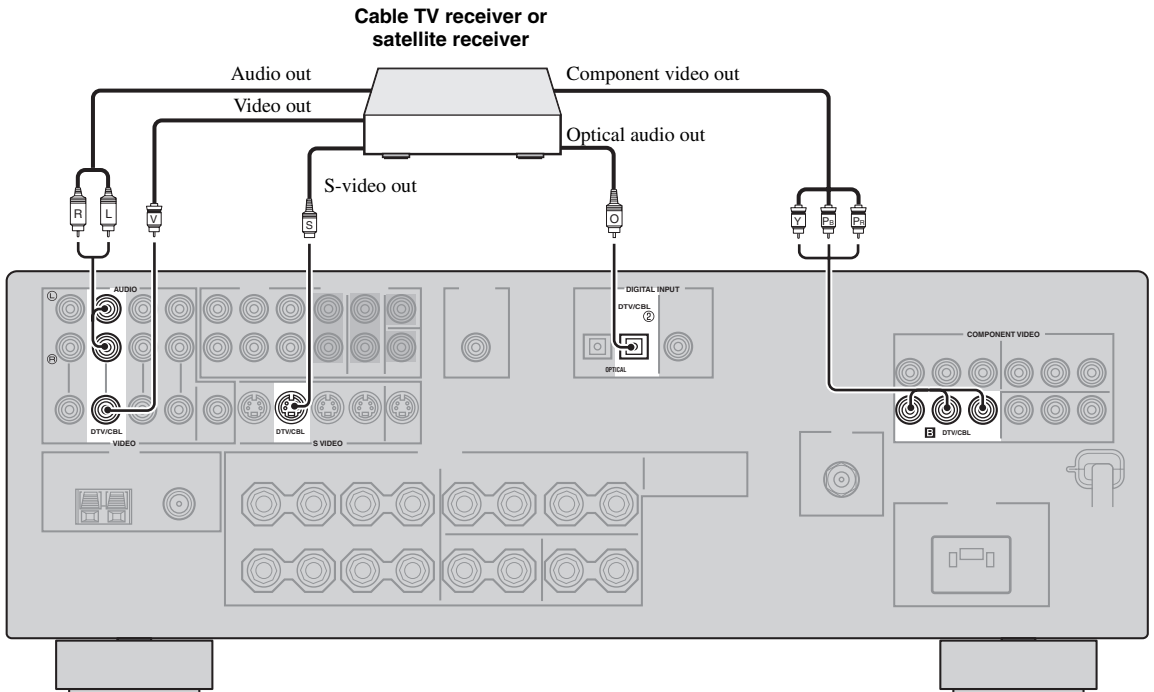

Connecting a CD player, an MD player or a tape deck

Connect your CD player, MD player or tape deck via analog connection.

CAUTION

Do not connect this unit or other components to the AC power supply until all connections between components are complete.

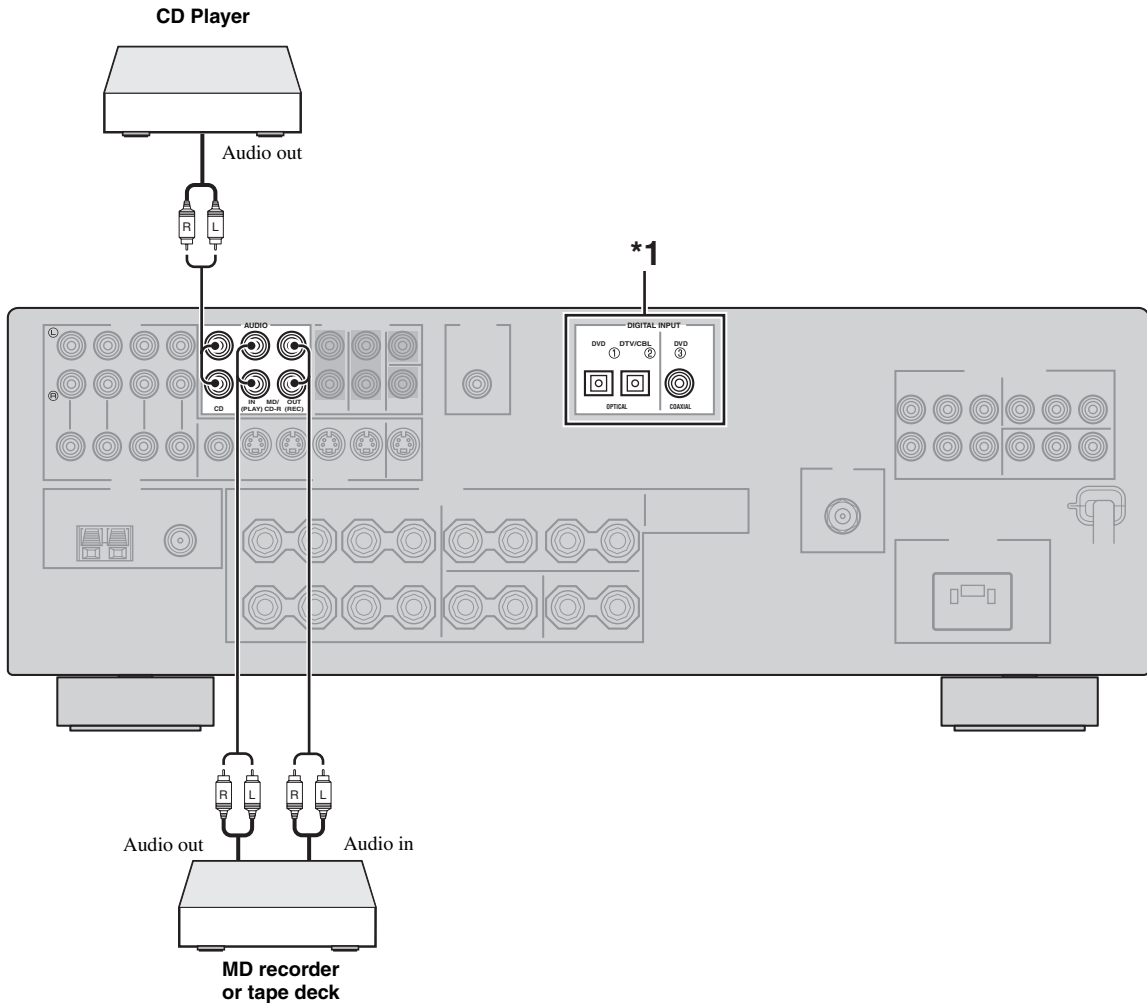

PREPARATION

Note

*1 To make a digital connection to a component other than the default component assigned to each DIGITAL INPUT jack, select the corresponding setting for "OPTICAL IN" or "COAXIAL IN" in "INPUT ASSIGN" (see page 85).

Connecting a multi-format player or an external decoder

This unit is equipped with 6 additional input jacks (FRONT L/R, CENTER, SURROUND L/R and SUBWOOFER) for discrete multi-channel input from a multi-format player, external decoder, sound processor or pre-amplifier. Connect the output jacks on your multi-format player or external decoder to the MULTI CH INPUT jacks. Be sure to match the left and right output jacks to the left and right input jacks for the front and surround channels.

CAUTION

Do not connect this unit or other components to the AC power supply until all connections between components are complete.

Notes

- When you select the component connected to the MULTI CH INPUT jacks as the input source (see page 36), this unit automatically turns off the digital sound field processor, and you cannot select sound field programs.
- This unit does not redirect signals input at the MULTI CH INPUT jacks to accommodate for missing speakers. We recommend that you connect at least a 5.1-channel speaker system before using this feature.
- When headphones are used, signals are output only from the front left and right channels.

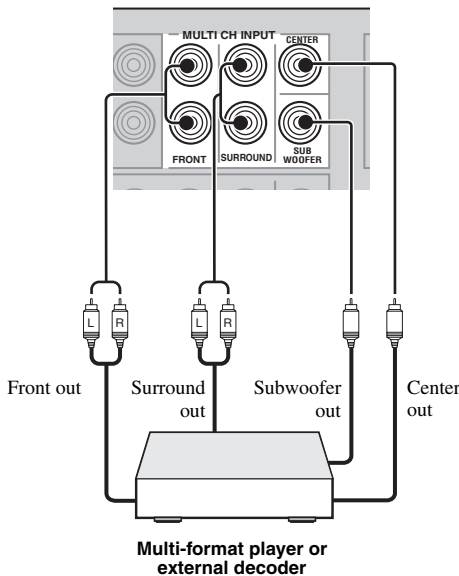

Connecting a game console, a video camera or a portable audio player

Use the VIDEO AUX jacks on the front panel to connect a game console, a video camera or a portable audio player to this unit.

CAUTION

Be sure to turn off the volume of this unit and other components before making connections.

Note

The audio signals input at the PORTABLE mini jack take priority over the ones input at the AUDIO L/R jacks.

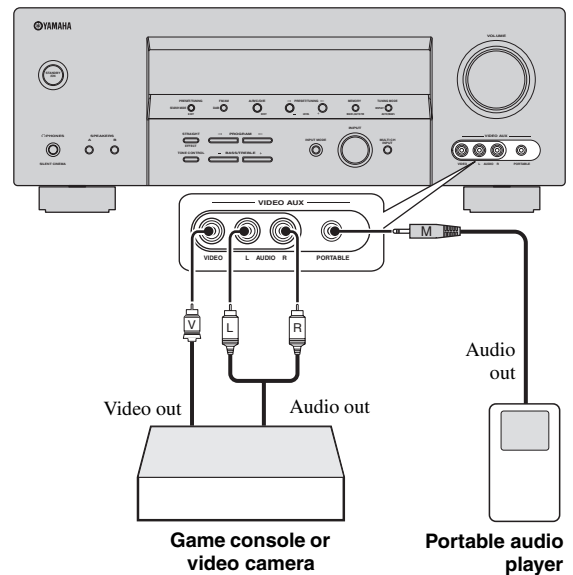

Connecting the FM and AM antennas

Both FM and AM indoor antennas are supplied with this unit. In general, these antennas should provide sufficient signal strength. Connect each antenna correctly to designated terminals.

Notes

- The AM loop antenna should be placed away from this unit.
- The AM loop antenna should always be connected, even if an outdoor AM antenna is connected to this unit.
- A properly installed outdoor antenna provides clearer reception than an indoor one. If you experience poor reception quality, install an outdoor antenna. Consult the nearest authorized YAMAHA dealer or service center about outdoor antennas.

AM loop antenna (supplied)

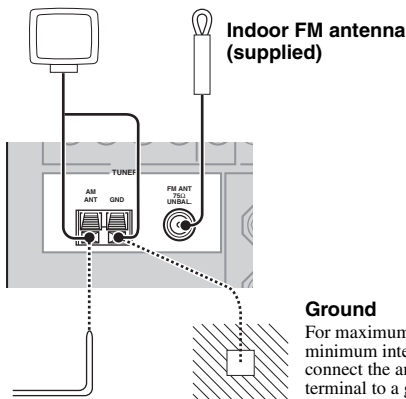

Ground

For maximum safety and minimum interference, connect the antenna GND terminal to a good earth ground. A good earth ground is a metal stake driven into moist earth.

■ Connecting the AM loop antenna

1 Set up the AM loop antenna.

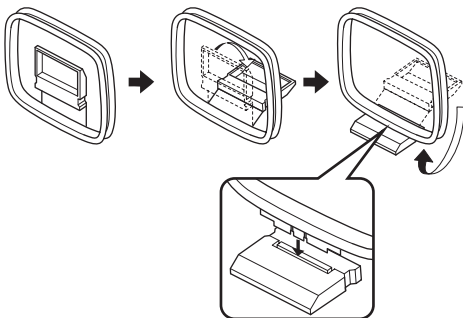

2 Press and hold the tab of the AM ANT terminal.



3 Insert one of the AM loop antenna lead wires into the AM ANT terminal.

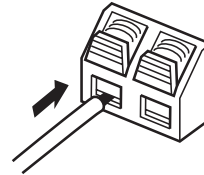

4 Release the tab of the AM ANT terminal back into place.



5 Repeat steps 2 through 4 to connect the other lead wire to the GND terminal.



Once you have properly connected the AM loop antenna to this unit, orient the AM loop antenna for the best reception when you tune into AM stations (see page 43).

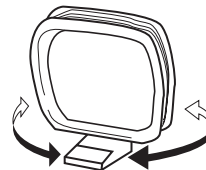

Connecting the DAB antenna

Connect the supplied indoor DAB antenna to the DAB antenna terminal on the rear panel and attach the indoor DAB antenna vertically on the wall.

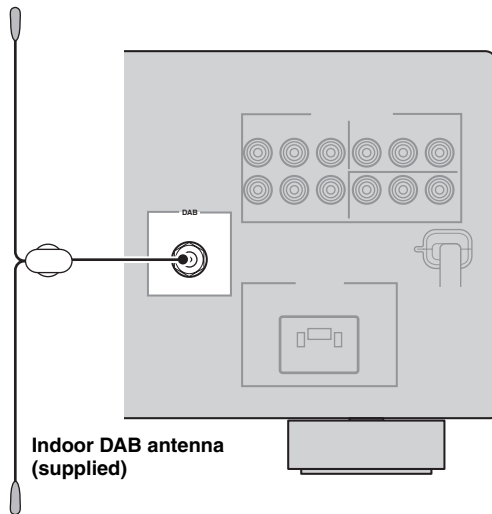

It is recommended that you use the tuning aid function (see page 63) when you set up the indoor DAB antenna in order to maximize DAB reception capability.

Notes

- Be sure to check the DAB coverage in your area in that not all areas are currently being covered. For a list of nationwide DAB statuses and worldwide DAB frequencies, check WorldDAB online at "<http://www.worlddab.org/>".
- If the DAB signal is weak, use a commercially available outdoor DAB antenna for better reception.

Connecting the power cable

Once all connections are complete, plug the power cable into the AC wall outlet.

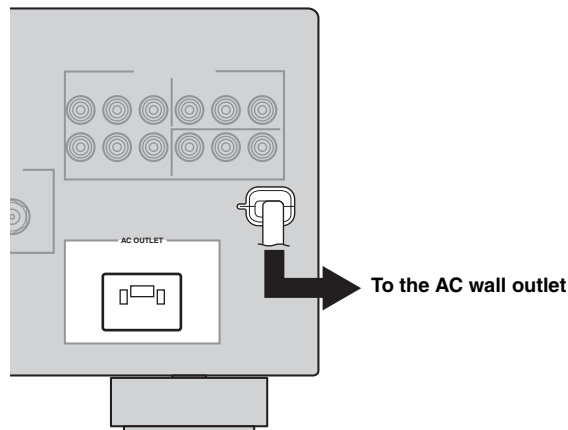

AC OUTLET (SWITCHED)

Use this outlet to supply power to any connected components. Connect the power cable of another component to this outlet. Power to this outlet is supplied when this unit is turned on. However, power to this outlet is cut off when this unit is in the standby mode or the power cable of this unit is disconnected from the AC wall outlet. For information on the maximum power, see "SPECIFICATIONS" on page 103.

Memory back-up

The memory back-up circuit prevents the stored data from being lost even if this unit is in the standby mode. However, the stored data will be lost in case the power cable is disconnected from the AC wall outlet or if the power supply is cut off for more than one week.

Setting the speaker impedance

CAUTION

If you are to use 4 or 6 ohm speakers, set “SP IMP.” to “6ΩMIN” as follows BEFORE using this unit.

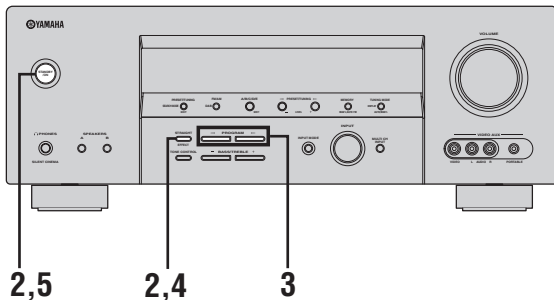

1 Make sure this unit is in the standby mode.
See page 25 for details about turning on this unit or standby mode.

2 Press and hold STRAIGHT (EFFECT) on the front panel and then press STANDBY/ON to turn on this unit.
This unit turns on, and the advanced setup menu appears in the front panel display.



3 Press PROGRAM </> buttons on the front panel to select “SP IMP.”.
The following display appears in the front panel display.

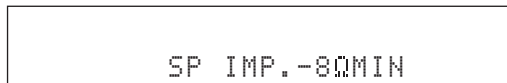
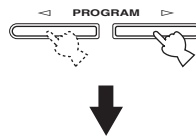

4 Press STRAIGHT (EFFECT) on the front panel repeatedly to select “6ΩMIN”.
The following display appears in the front panel display.

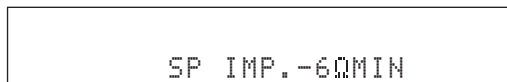

5 Press STANDBY/ON on the front panel to save the new setting and set this unit to the standby mode.



Note

The setting you made is reflected next time you turn on this unit.

Turning on this unit and setting it to the standby mode

When all connections are complete, turn on this unit.

STANDBY/ON

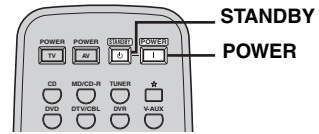
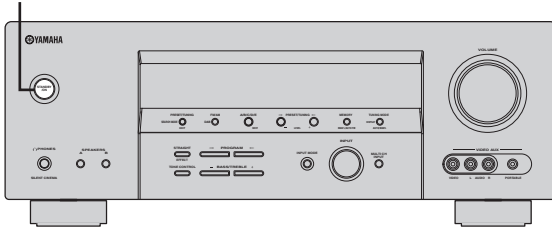

■ Turning on the power

Press **STANDBY/ON** on the front panel (or **POWER** on the remote control) to turn on this unit.



Front panel

or



Remote control

■ Setting this unit to the standby mode

Press **STANDBY/ON** on the front panel again (or **STANDBY** on the remote control) to set this unit to the standby mode.



Front panel

or



Remote control

BASIC SETUP

The “BASIC SETUP” feature is a useful way to set up your system quickly and with minimal effort.

Notes

- Make sure you disconnect your headphones from this unit.
- If you wish to configure this unit manually using more precise adjustments, use the detailed parameters in “SOUND MENU” (see page 82).
- Altering any parameters in “BASIC SETUP” resets all parameters manually adjusted in “SOUND MENU” (see page 82).
- Initial settings are indicated in bold under each parameter.
- Press RETURN on the remote control to return to the previous menu level.

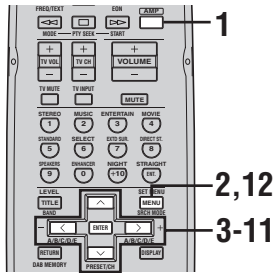

3 Press ENTER to enter “BASIC SETUP”.

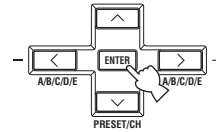

The “ROOM” appears in the front panel display.

1 Press AMP on the remote control.



2 Press SET MENU.

“BASIC SETUP” appears in the front panel display.



4 Press </> to select the desired setting.

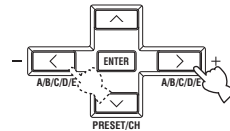

ROOM: S >M L

Select the size of the room where you have installed your speakers. In general, the room sizes are defined as follows:

Choices: S, **M**, L

S (small) 3.6 x 2.8m, 10m²

M (medium) 4.8 x 4.0m, 20m²

L (large) 6.3 x 5.0m, 30m²

5 Press ∇ to select “SUBWOOFER” and then \langle / \rangle to select the desired setting.

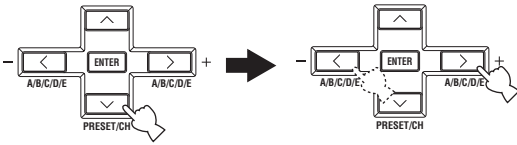

SUBWOOFER • • YES

Choices: **YES**, NONE

- Select “YES” if you have a subwoofer in your system.
- Select “NONE” if you do not have a subwoofer in your system.

6 Press ∇ to select “SPEAKERS” and then \langle / \rangle to select the number of speakers connected to this unit.

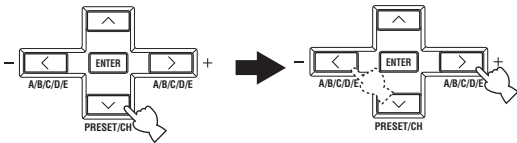

SPEAKERS • • 6spk

Choice	Display	Speakers
2spk		Front L/R
3spk		Front L/R, Center
4spk		Front L/R, Surround L/R
5spk		Front L/R, Center, Surround L/R
6spk		Front L/R, Center, Surround L/R, Surround back

7 Press ∇ to select “SET” and then \langle / \rangle to select the desired setting.

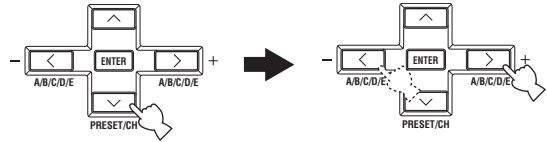

>SET CANCEL

Choices: **SET**, CANCEL

- Select “SET” to apply the settings you made.
- Select “CANCEL” to cancel the setup procedure without making any changes.



You can also press SET MENU to cancel the setup procedure.

8 Press ENTER to confirm your selection.

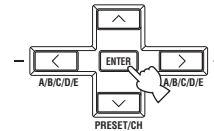

If you selected “SET” in step 7, each speaker outputs a test tone twice in turn. “CHECK:TestTone” appears in the front panel display for a few seconds and then “CHECK OK?” appears in the front panel display.

CHECK:TestTone



Check the speaker connections (see page 12) and adjust the “SPEAKERS” settings back in step 6, if necessary.

9 Press </> to select the desired setting.

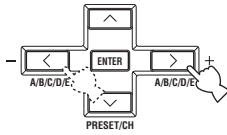

CHECK OK? . . YES

Choices: **YES**, NO

- Select “YES” to complete the setup procedure if the test tone levels from each speaker were satisfactory.
- Select “NO” to proceed to the speaker level adjustment menu to balance the output level of each speaker.

10 Press ENTER to confirm your selection.

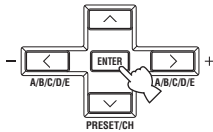

- If you selected “YES” in step 9, the setup procedure is completed and the display returns to the top “SET MENU” display.
- If you selected “NO” in step 9, the front speaker level adjustment display appears in the front panel display.

11 Press ∨/∧ to select a speaker and then </> to adjust the balance.

The selected speaker and the front left speaker (or the surround left speaker) output a test tone in turn.

- Press > to increase the value.
- Press < to decrease the value.

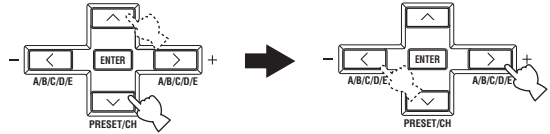

FR -----| |-----

- Select “FR” to adjust the balance between the front left and right speakers.
- Select “C” to adjust the balance between the front left and center speakers.
- Select “SL” to adjust the balance between the front left and surround left speakers.
- Select “SB” to adjust the balance between the surround left and surround back speakers.
- Select “SR” to adjust the balance between the surround left and surround right speakers.
- Select “SWFR” to adjust the balance between the front left speaker and the subwoofer.

12 Press SET MENU to exit from “BASIC SETUP”.



PLAYBACK

CAUTION

Extreme caution should be exercised when you play back CDs encoded in DTS. If you play back a CD encoded in DTS on a DTS-incompatible CD player, you will only hear some unwanted noise that may damage your speakers. Check whether your CD player supports CDs encoded in DTS. Also, check the sound output level of your CD player before you play back a CD encoded in DTS.

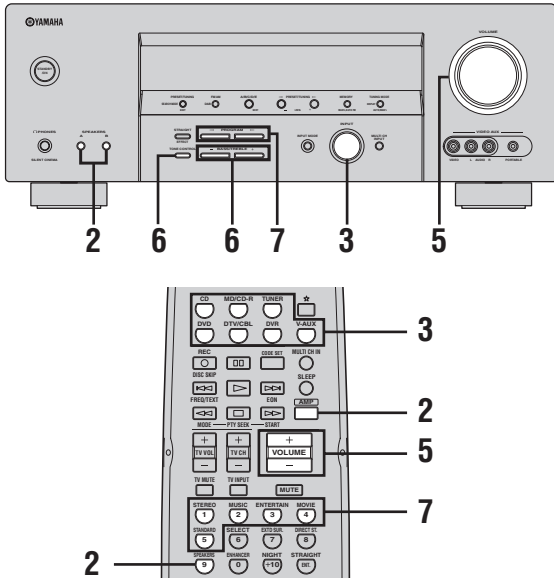

1 Turn on the video monitor connected to this unit.

2 Press **SPEAKERS A** or **B** on the front panel (or press **AMP** and then press **SPEAKERS** on the remote control repeatedly).

Each time you press **SPEAKERS A** or **B** on the front panel, the respective speakers are turned on or off.

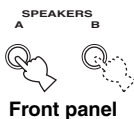

or



Remote control

3 Rotate the **INPUT** selector on the front panel (or press one of the input selector buttons on the remote control) to select the desired input source.

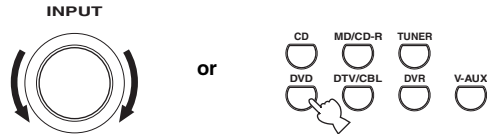

Front panel

Remote control

The name of the currently selected input source appears in the front panel display for a few seconds.

Available input sources

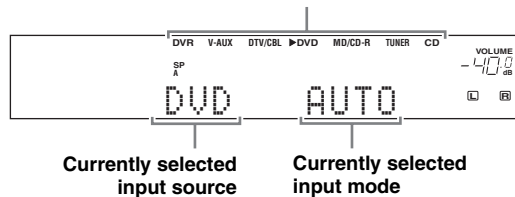

Currently selected input source

Currently selected input mode

Note

If you are to select an input source connected via digital connections, set "INPUT MODE" to "AUTO" or "DTS" (see page 32).

4 Start playback on the selected source component or select a broadcast station.

Refer to the operating instructions for the source component.

- See page 43 for details about FM/AM tuning instructions.
- See page 56 for details about DAB tuning instructions.

- 5 Rotate **VOLUME** on the front panel (or press **VOLUME +/-** on the remote control) to adjust the volume to the desired output level.

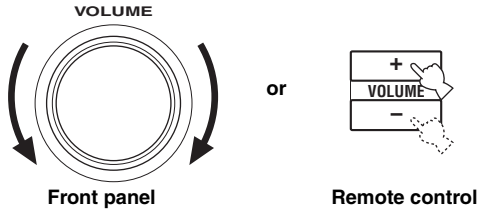

- 6 Press **TONE CONTROL** on the front panel repeatedly to select “**TREBLE**” or “**BASS**” and then press **BASS/TREBLE +/-** buttons to adjust the corresponding frequency response level.

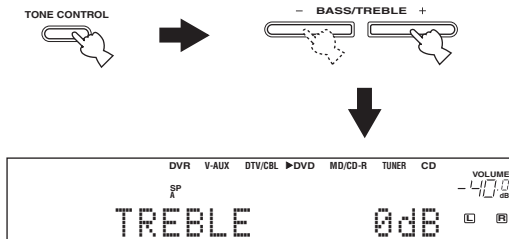

- Select “**TREBLE**” to adjust the high-frequency response.
- Select “**BASS**” to adjust the low-frequency response.

Notes

- Speaker and headphone adjustments are stored independently.
- When “**TC.BYPASS**” is set to “**AUTO**” (see page 84), and “**BASS**” and “**TREBLE**” are set to 0 dB, audio output automatically bypasses the tone control circuitry of this unit.
- If you increase or decrease the high-frequency or low-frequency sound to an extreme level, the tonal quality of the surround speakers may not match that of the front left and right speakers.
- **TONE CONTROL** is not effective when the “**DIRECT STEREO**” mode (see page 37) is selected or when “**MULTI CH INPUT**” (see page 36) is selected as the input source.
- To enjoy multi-channel sources in surround, see page 39 for details.

- 7 Press **PROGRAM** </> buttons on the front panel (or press one of the sound field program selector buttons on the remote control repeatedly) to select the desired sound field program.

The name of the selected sound field program appears in the front panel display.

See page 67 for details about sound field programs.

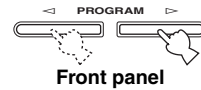

or



Remote control



Currently selected sound field program

Notes

- Choose a sound field program based on your listening preference, not merely on the name of the program.
- When you select an input source, this unit automatically selects the last sound field program used with the corresponding input source.
- Sound field programs cannot be selected when the component connected to the **MULTI CH INPUT** jacks is selected as the input source (see page 36).
- Sampling frequencies higher than 48 kHz (except for DTS 96/24 signals) are sampled down to 48 kHz and then sound field programs are applied.
- To display information about the currently selected input source in the front panel display, see page 37 for details.

USING OTHER FEATURES

Using SILENT CINEMA

SILENT CINEMA allows you to enjoy multi-channel music or movie sound, including Dolby Digital and DTS sources, through ordinary headphones. SILENT CINEMA activates automatically whenever you connect headphones to the PHONES jack while listening to CINEMA DSP or HiFi DSP sound field programs (see page 67). When activated, the SILENT CINEMA indicator lights up in the front panel display.

Notes

- SILENT CINEMA does not activate when "MULTI CH INPUT" is selected as the input source (see page 36).
- SILENT CINEMA is not effective when the "DIRECT STEREO" (see page 37) or "2ch Stereo" mode (see page 36) is selected, or when this unit is in the "STRAIGHT" mode (see page 36).

Muting the audio output

Press MUTE on the remote control to mute the audio output. Press MUTE again to resume the audio output.



- You can also rotate VOLUME on the front panel or VOLUME +/- on the remote control to resume the audio output.
- You can adjust the muting level by using the "MUTING TYP." parameter in "SOUND MENU" (see page 84).
- The MUTE indicator flashes in the front panel display when the audio output is muted and disappears from the front panel display when the audio output is resumed.

Selecting the night listening mode

The night listening modes are designed to improve listenability at lower volumes or at night. Choose either "NIGHT:CINEMA" or "NIGHT:MUSIC" depending on the type of material you are playing.

- 1 Press AMP and then press NIGHT on the remote control repeatedly to select "NIGHT:CINEMA" or "NIGHT:MUSIC".



Choices: NIGHT:CINEMA, NIGHT:MUSIC, OFF

- Select "NIGHT:CINEMA" when watching films to reduce the dynamic range of film soundtracks and make dialog easier to hear at lower volumes.
- Select "NIGHT:MUSIC" when listening to music sources to preserve ease-of-listening for all sounds.
- Select "OFF" if you do not want to use this feature.



When a night listening mode is selected, the NIGHT indicator lights up in the front panel display.

- 2 Press </> on the remote control to adjust the effect level while "NIGHT:CINEMA" or "NIGHT:MUSIC" is displayed in the front panel display.

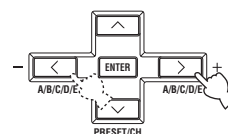

Remote control



Effect.Lvl: MID

Choices: MIN, MID, MAX

- Select "MIN" for minimum compression.
- Select "MID" for standard compression.
- Select "MAX" for maximum compression.



“NIGHT:CINEMA” and “NIGHT:MUSIC” adjustments are stored independently.

Notes

- You cannot use the night listening modes in the following cases:
 - when the “DIRECT STEREO” mode (see page 37) is selected.
 - when the component connected to the MULTI CH INPUT jacks is selected as the input source (see page 36).
 - when headphones are connected to the PHONES jack.
- The night listening modes may vary in effectiveness depending on the input source and surround sound settings you use.

Selecting the input mode

This unit comes with a variety of input jacks. Do the following to select the type of input signals you want to use.



You can adjust the default input mode of this unit by using the “INPUT MODE” parameter in “INPUT MENU” (see page 85).

Notes

- To play DTS-encoded DVDs and CDs, (when using a digital audio connection), be sure to set “INPUT MODE” to “DTS”.
- If the digital output data of the player has been processed in any way, you may not be able to perform DTS decoding depending on the player even if you make a digital connection between this unit and the player.

- 1 Rotate the INPUT selector on the front panel to select the desired input source.**

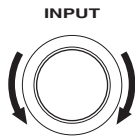

- 2 Press INPUT MODE on the front panel repeatedly to select the desired input mode.**

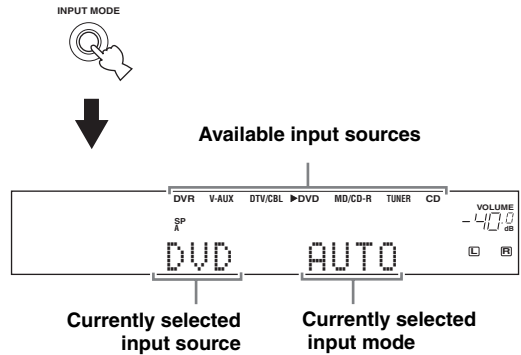

- AUTO** Automatically selects input signals in the following order:
 - 1) Digital signals
 - 2) Analog signals
- DTS** Selects only digital signals encoded in DTS. If no DTS signals are input, no sound is output.
- ANALOG** Selects only analog signals. If no analog signals are input, no sound is output.

Notes

- When “INPUT MODE” is set to “AUTO”, this unit automatically switches to the appropriate decoder if a Dolby Digital or DTS signal is detected.
- We recommend setting “INPUT MODE” to “AUTO” in most cases.

Using the sleep timer

Use this feature to automatically set this unit to the standby mode after a certain amount of time. The sleep timer is useful when you are going to sleep while this unit is playing or recording a source. The sleep timer also automatically turns off any external components connected to AC OUTLET (see page 23).

- 1 Press one of the input selector buttons on the remote control to select the desired input source.**

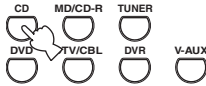

- 2 Start playback on the selected source component or select a broadcast station.**

Refer to the operating instructions for the source component.
See page 43 for details about tuning instructions.

- 3 Press SLEEP on the remote control repeatedly to set the amount of time.**

Each time you press SLEEP, the front panel display changes as shown below.

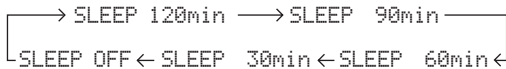

The SLEEP indicator flashes while you are switching the amount of time for the sleep timer. Once the sleep timer is set, the SLEEP indicator lights up in the front panel display, and the display returns to the selected sound field program.

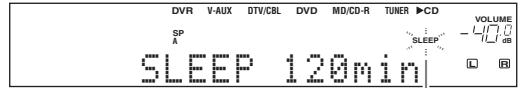

Flashes



Lights up

- 4 To cancel the sleep timer, press SLEEP on the remote control repeatedly until "SLEEP OFF" appears in the front panel display.**



The SLEEP indicator turns off, and "SLEEP OFF" disappears from the front panel display after a few seconds.



The sleep timer setting can also be canceled by pressing STANDBY on the remote control (or STANDBY/ON on the front panel) to set this unit to the standby mode.

Adjusting the speaker level

You can adjust the output level of each speaker while listening to a music source. This is also possible when playing sources input at the MULTI CH INPUT jacks.

Note

This operation will override the level adjustments made in "BASIC SETUP" (see page 26) and "SP LEVEL" (see page 83).

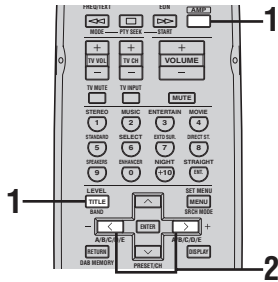

2 Press </> on the remote control to adjust the speaker output level.

- Press > to increase the value.
 - Press < to decrease the value.
- Control range: -10 dB to +10 dB

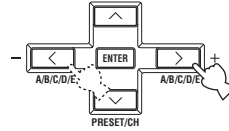

This operation can also be performed using the control buttons on the front panel. Press NEXT on the front panel repeatedly to select the speaker channel whose output level you want to adjust and then press LEVEL +/- on the front panel to adjust the output level.

1 Press AMP and then press LEVEL on the remote control repeatedly to select the speaker you want to adjust.



- Select "FRONT L" to adjust the front left speaker output level.
- Select "CENTER" to adjust the center speaker output level.
- Select "FRONT R" to adjust the front right speaker output level.
- Select "SUR. R" to adjust the surround right speaker output level.
- Select "SUR. B" to adjust the surround back speaker output level.
- Select "SUR. L" to adjust the surround left speaker output level.
- Select "SWFR" to adjust the subwoofer output level.



Once you press LEVEL on the remote control, you can also select the speaker by pressing ^ / v.

Selecting the Compressed Music Enhancer mode

Compression artifacts (such as the MP3 format) are created by a lossy compression scheme where the audio is resampled to lower the bitrate and to remove sounds that are indistinguishable to typical human hearing. The Compressed Music Enhancer feature of this unit enhances your listening experience by regenerating the missing harmonics in a compression artifact. As a result, flattened complexity due to the loss of the high-frequency fidelity as well as lack of bass due to the loss of low-frequency bass is compensated, providing the improved performance of the overall sound system.

Notes

- The Compressed Music Enhancer mode is compatible with the PCM signals (32 kHz, 44.1 kHz and 48 kHz) and the analog 2-channel input sources.
- The Compressed Music Enhancer mode is not effective with any of the sound field programs.
- When the Compressed Music Enhancer mode is turned on while an incompatible input source is being played back, "Not Available" appears in the front panel display.
- When the input source is changed to an incompatible input source while the Compressed Music Enhancer mode is turned on, the Compressed Music Enhancer mode is automatically turned off and the incompatible input source is played back in 2-channel or 6-channel stereo.



The ENHANCER indicator lights up in the front panel display when one of the Compressed Music Enhancer modes is selected.

- 1 Press **AMP** and then press **ENHANCER** on the remote control repeatedly to select the desired **Compressed Music Enhancer mode**.

The following display is shown in the front panel display and the ENHANCER indicator lights up in the front panel display.

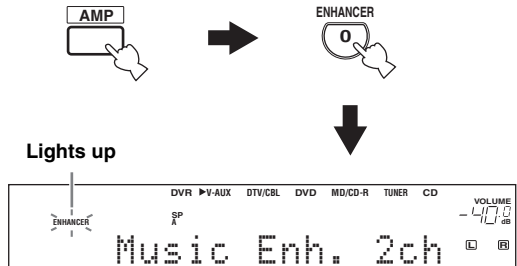

Choices: **Music Enh. 2ch**, Music Enh. 6ch, Off (previously selected sound field program)

- Select "Music Enh. 2ch" to play back compression artifacts in 2-channel stereo.
- Select "Music Enh. 6ch" to play back compression artifacts in 6-channel stereo.
- Select Off (previously selected sound field program) to turn off the Compressed Music Enhancer mode.



You can also switch between "Music Enh. 2ch" and "Music Enh. 6ch" by pressing </> on the remote control when either one of them is displayed in the front panel display.

- 2 Press **∨** once and then **</>** on the remote control to select the desired effect level.

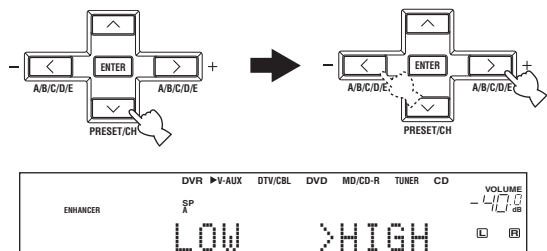

Choices: **HIGH**, **LOW**

- Select "HIGH" for a high effect level.
- Select "LOW" for a low effect level.

Note

Set the effect level to "HIGH" or "LOW" according to the characteristics of a source. The high-frequency signals of some sources may be emphasized too much. In this case, set the effect level to "LOW".

Selecting the MULTI CH INPUT component

Use this feature to select the component connected to the MULTI CH INPUT jacks (see page 20) as the input source.

Press **MULTI CH INPUT** on the front panel (or **MULTI CH IN** on the remote control) so that “MULTI CH INPUT” appears in the front panel display.

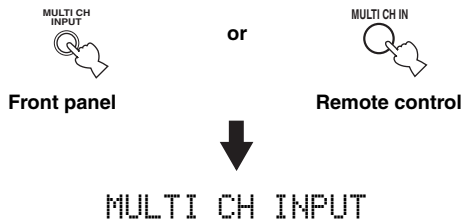

Note

When “MULTI CH INPUT” is shown in the front panel display, no other source can be played. To select another input source with the INPUT selector on the front panel (or one of the input selector buttons), press MULTI CH INPUT (or MULTI CH IN on the remote control) so that “MULTI CH INPUT” disappears from the front panel display.

Enjoying multi-channel sources in 2-channel stereo

You can mix down multi-channel sources to 2 channels and enjoy playback in 2-channel stereo.

Press **AMP** and then press **STEREO** on the remote control repeatedly to select “2ch Stereo”.

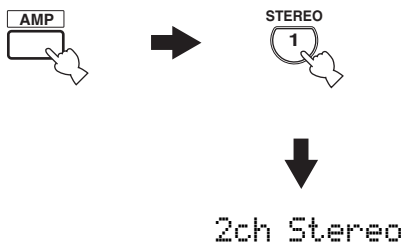

- You can use a subwoofer with this program when “BASS OUT” is set to “SWFR” or “BOTH” (see page 82).
- You can also select “2ch Stereo” by pressing the PROGRAM <|/> buttons on the front panel.

Enjoying unprocessed input sources

When this unit is in the “STRAIGHT” mode, 2-channel stereo sources are output from only the front left and right speakers. Multi-channel sources are decoded straight into the appropriate channels without any additional effect processing.

1 Press **AMP** and then press **STRAIGHT** on the remote control to select “STRAIGHT”.

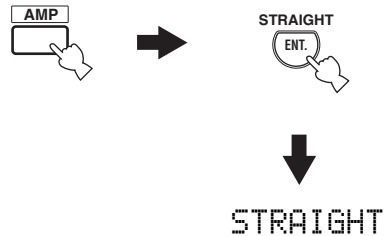

2 To deactivate the “STRAIGHT” mode, press **STRAIGHT** on the remote control again so that “STRAIGHT” disappears from the front panel display.

The sound effect is turned back on.



You can also select “STRAIGHT” by pressing STRAIGHT (EFFECT) on the front panel.

Enjoying pure hi-fi stereo sound

The “DIRECT STEREO” mode allows sources to bypass the decoders and DSP processors of this unit so that you can enjoy pure hi-fi sound from 2-channel PCM and analog sources.

Press **AMP** on the remote control and then press **DIRECT ST.** on the remote control to select “DIRECT STEREO”.

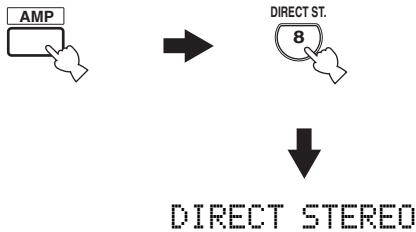

Notes

- To avoid unexpected noise, do not play CDs encoded in DTS when the “DIRECT STEREO” mode is selected.
- When multi-channel signals (Dolby Digital and DTS) are input, this unit automatically switches to the corresponding analog input. When “DTS” is selected as the input mode (see page 32), no sound will be output.
- No sound will be output from the subwoofer.
- “TONE CONTROL” (see page 30) and “SOUND MENU” (see page 82) settings (except for speaker level settings) are not effective.
- The front panel display automatically dims.



You can also select the “DIRECT STEREO” mode by pressing the PROGRAM ◀/▶ buttons on the front panel repeatedly.

Displaying the input source information

You can display the format, sampling frequency, channel, bit rate, and flag data of the current input signal.

- 1 Press one of the input selector buttons to select the desired input source.

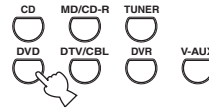

- 2 Press **AMP** on the remote control and then press **STRAIGHT** on the remote control to select “STRAIGHT”.

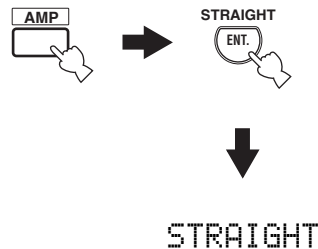

- 3 Press **^ / v** to display the information about the input signal.

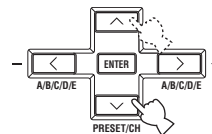

The following information appears in the front panel display for a few seconds.

Signal format

Signal format display. When this unit cannot detect a digital signal, it automatically switches to analog input.

Display status: Analog, Digital, Dolby Digital, DTS, PCM, Unknwn Digital

Note

“Unknwn Digital” appears when this unit detects any undecodable digital signal.

Channel in:

The number of source channels in the input signal (front/surround/LFE). For example, a multi-channel soundtrack with 3 front channels, 2 surround channels and LFE, is displayed as “3/2/LFE”.

Sampling frequency f_s:

The number of samples per second taken from a continuous signal to make a discrete signal.

Display status: 32kHz, 44.1kHz, 48kHz, 64kHz, 88.2kHz, 96kHz

Bit rate rate:

The number of bits passing a given point per second.

Flag flg:

Flag data encoded in DTS, Dolby Digital, or PCM signals. Some flag data cue this unit to automatically switch decoders.



When you are displaying information about the input source, this unit is in the “STRAIGHT” mode (see page 36). To turn back the sound effect on, press “STRAIGHT” again.

Playing video sources in the background

You can combine a video image from a video source with sound from an audio source. For example, you can enjoy listening to classical music while viewing beautiful scenery from the video source on the video monitor.

Press the input selector buttons on the remote control to select a video source and then an audio source.

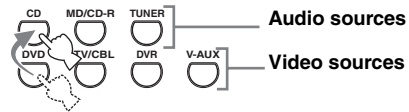

Note

If you want to enjoy an audio source input at the MULTI CH INPUT jacks together with a video source, first select the video source and then press MULTI CH INPUT on the front panel (or MULTI CH IN on the remote control) to select “MULTI CH INPUT” as the input source (see page 36).

ENJOYING SURROUND SOUND

Enjoying multi-channel sources in surround

If you connected a surround back speaker, use this feature to enjoy 6.1-channel playback for multi-channel sources using the Dolby Pro Logic IIX, Dolby Digital EX or DTS-ES decoders.

- 1 Press **AMP** on the remote control and then press **EXTD SUR.** on the remote control repeatedly to switch between 5.1 and 6.1-channel playback.



- 2 Press **</>** repeatedly to select a decoder while **"PLIIXMusic"** (etc.) is displayed.

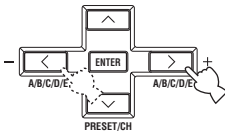

Auto AUTO

When a signal flag that can be recognized by this unit is input, this unit selects the optimum decoder to play back the signal in 6.1 channels.

If this unit cannot recognize the flag or no flag is present in the input signal, it cannot automatically be played in 6.1 channels.

Decoders

You can select from the following decoders depending on the format of the source you are playing.

Decoder	Functions
PLIIXMusic	Plays back Dolby Digital or DTS signals in 6.1 channels using the Pro Logic IIX music decoder.
EX/ES	Plays back Dolby Digital or DTS signals in 6.1 channels using the Dolby Digital EX or DTS-ES decoder.
EX	Plays back Dolby Digital or DTS signals in 6.1 channels using the Dolby Digital EX decoder.

Off OFF

Decoders are not used to create 6.1 channels.

Notes

- Some 6.1-channel compatible discs do not have a signal flag that can be automatically detected by this unit. When playing these kinds of discs in 6.1 channels, select a decoder manually from "PLIIX Music", "EX/ES" or "EX".
- 6.1-channel playback is not possible even if you press EXTD SUR. in the following cases:
 - when "SUR. LR" (see page 82) or "SUR. B" (see page 82) is set to "NONE".
 - when the source connected to the MULTI CH INPUT jacks is being played.
 - when the source being played does not contain surround left and right channel signals.
 - when a Dolby Digital KARAOKE source is being played.
 - when "2ch Stereo" (see page 36) or "DIRECT STEREO" (see page 37) program is selected.
- When this unit is turned off, this setting will be reset to "AUTO".
- The Pro Logic IIX decoder is not available when "SUR. B" is set to "NONE" (see page 82).

Enjoying 2-channel sources in surround

Signals input from 2-channel sources can also be played back on multi-channels.

- 1 Press **AMP** and then press **STANDARD** on the remote control repeatedly to switch between the “SUR. STANDARD” and “SUR. ENHANCED” programs or press **MOVIE** to select the “MOVIE THEATER” programs.

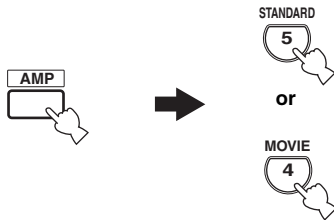

- 2 Press **SELECT** on the remote control repeatedly to select the desired decoder.



You can select from the following modes depending on the type of source you are playing and your personal preference.



You can also select a decoder by pressing **</>** on the remote control while the decoder type is displayed in the front panel display.

SUR. STANDARD	Functions
PRO LOGIC	Dolby Pro Logic processing for any sources
PLII Movie	Dolby Pro Logic II processing for movie sources
PLII Music	Dolby Pro Logic II processing for music sources
PLII Game	Dolby Pro Logic II processing for game sources
PLIIx Movie	Dolby Pro Logic IIx processing for movie sources
PLIIx Music	Dolby Pro Logic IIx processing for music sources
PLIIx Game	Dolby Pro Logic IIx processing for game sources
Neo:6 Cinema	DTS processing for movie sources
Neo:6 Music	DTS processing for music sources

SUR. ENHANCED or MOVIE THEATER	Functions
PRO LOGIC	Dolby Pro Logic processing for any sources
PLII Movie	Dolby Pro Logic II processing for movie sources
PLIIx Movie	Dolby Pro Logic IIx processing for movie sources
Neo:6 Cinema	DTS processing for movie sources

Note

The Pro Logic IIx decoder is not available when “SUR. B” is set to “NONE” (see page 82).

Using Virtual CINEMA DSP

Virtual CINEMA DSP allows you to enjoy the CINEMA DSP programs without surround speakers. It creates virtual speakers to reproduce the natural sound field. If you set "SUR. LR" to "NONE" (see page 82), Virtual CINEMA DSP activates automatically whenever you select a CINEMA DSP sound field program (see page 67).

Note

Virtual CINEMA DSP will not activate even when "SUR. LR" is set to "NONE" (see page 82) in the following cases:

- when the component connected to the MULTI CH INPUT jacks is selected as the input source (see page 36).
- when headphones are connected to the PHONES jack.
- when the "DIRECT STEREO" (see page 37) or "2ch Stereo" mode (see page 36) is selected, or when this unit is in the "STRAIGHT" mode (see page 36).

RECORDING

Recording adjustments and other operations are performed from the recording components. Refer to the operating instructions for those components.

Notes

- When this unit is set to the standby mode, you cannot record between other components connected to this unit.
- The setting of the TONE CONTROL (see page 30), VOLUME, the speaker level (see page 83) and the sound field programs (see page 66) do not affect recorded material.
- The source connected to the MULTI CH INPUT jacks of this unit cannot be recorded.
- S-video and composite video signals pass independently through the video circuits of this unit. Therefore, when recording or dubbing video signals input from a video source component that provides only an S-video or a composite video signal, you can record only an S-video or a composite video signal on your VCR.
- Digital signals input at the DIGITAL INPUT jacks are not output at the analog OUT (REC) jacks for recording.
- A given input source is not output on the same OUT (REC) channel.
- Check the copyright laws in your country to record from CDs, radio, etc. Recording of copyrighted material may infringe copyright laws.



Do a test recording before you start an actual recording.

If you play back a video source that uses scrambled or encoded signals to prevent it from being dubbed, the picture itself may be disturbed due to those signals.

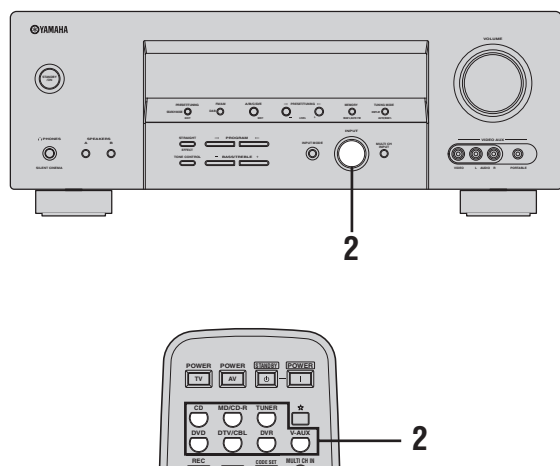

1 Turn on all the connected components.

2 Rotate the INPUT selector on the front panel (or press one of the input selector buttons on the remote control) to select the source component you want to record from.

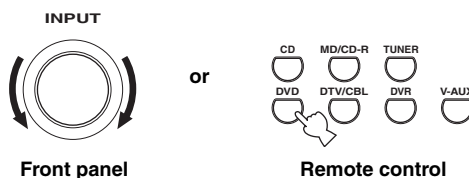

3 Start playback on the selected source component or select a broadcast station.

4 Start recording on the recording component.

FM/AM TUNING

There are 2 tuning methods: automatic and manual. Automatic tuning is effective when station signals are strong and there is no interference. If the signal from the station you want to select is weak, tune into it manually. You can also use the automatic and manual preset tuning features to store up to 40 stations (A1 to E8: 8 preset station numbers in each of the 5 preset station groups). Furthermore, you can recall any preset stations and exchange the assignment of two preset stations with each other.

Note

Orient the connected FM and AM antenna for the best reception.

Automatic tuning

Automatic tuning is effective when station signals are strong and there is no interference.

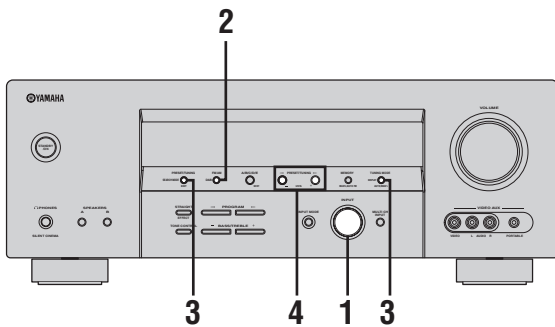

- 1 Rotate the INPUT selector to select "TUNER" as the input source.

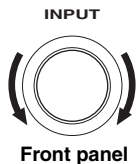

- 2 Press FM/AM to select the reception band. "FM" or "AM" appears in the front panel display.



- 3 Press TUNING MODE (AUTO/MAN'L) so that the AUTO indicator lights up in the front panel display.

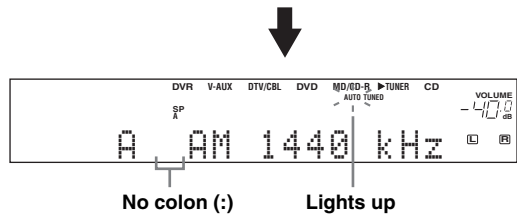

If a colon (:) appears in the front panel display, tuning is not possible. Press PRESET/TUNING to turn the colon (:): off.



- 4 Press PRESET/TUNING </> once to begin automatic tuning.

When this unit is tuned into a station, the TUNED indicator lights up and the frequency of the received station is shown in the front panel display.

- Press > to tune into a higher frequency.
- Press < to tune into a lower frequency.

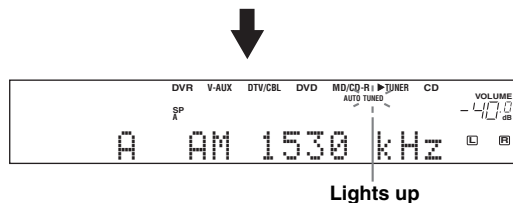
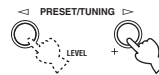

Manual tuning

If the signal received from the station you want to select is weak, tune into it manually.

Note

Manually tuning into an FM station automatically switches the tuner to monaural reception to increase the signal quality.

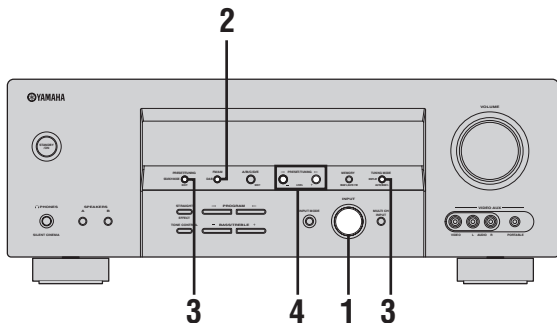

- 1 Rotate the INPUT selector to select "TUNER" as the input source.

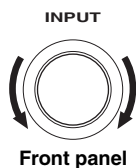

- 2 Press FM/AM to select the reception band. "FM" or "AM" appears in the front panel display.



- 3 Press TUNING MODE (AUTO/MAN'L) so that the AUTO indicator disappears from the front panel display.

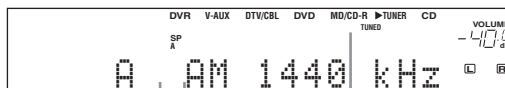

No colon (:) Disappears

If a colon (:) appears in the front panel display, tuning is not possible. Press PRESET/TUNING to turn the colon (:) off.



- 4 Press PRESET/TUNING </> to tune into the desired station manually.

Hold down the button to continue searching.



Automatic preset tuning

You can use the automatic preset tuning feature to store FM stations with strong signals up to 40 (A1 to E8: 8 preset station numbers in each of the 5 preset station groups) of those stations in order. You can then recall any preset station easily by selecting the preset station number.

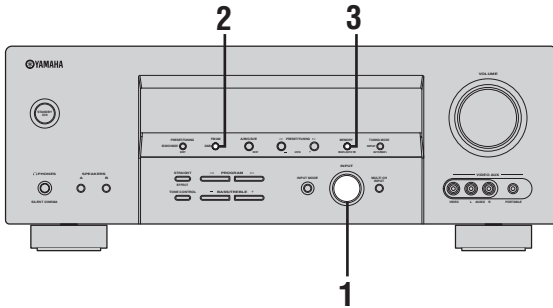

- 1 Rotate the INPUT selector to select "TUNER" as the input source.

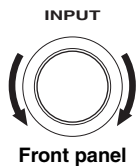

- 2 Press FM/AM to select "FM" as the reception band.

"FM" appears in the front panel display.



- 3 Press and hold MEMORY (MAN'L/AUTO FM) for more than 3 seconds.

The preset station number and the MEMORY and AUTO indicators flash. After approximately 5 seconds, automatic presetting starts from the current frequency and proceeds toward the higher frequencies.

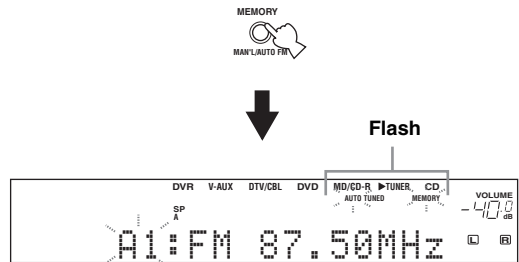

Flashes

When automatic preset tuning is completed, the front panel display shows the frequency of the last preset station.



You can specify the preset number from which this unit stores FM stations and/or begins tuning toward lower frequencies. For details, see "Automatic preset tuning options" on page 46.

Notes

- Any stored station data existing under a preset station number is cleared when you store a new station under the same preset station number.
- If the number of received stations does not reach 40 (E8), automatic preset tuning automatically stops after searching for all the available stations.
- Only FM stations with sufficient signal strength are stored automatically by automatic preset tuning. If the station you want to store is weak in signal strength, tune into it manually and store it as described in "Manual preset tuning" (see page 46).

Automatic preset tuning options

You can specify the preset number from which this unit stores FM stations and/or begins tuning toward lower frequencies.

Note

First carry out steps 1 through 3 in “Automatic preset tuning” on page 45.

- Press **A/B/C/D/E** and then **PRESET/TUNING** $\triangleleft/\triangleright$ to select the preset station number under which the first station will be stored. Automatic preset tuning stops when stations have all been stored up to E8.



- Press **PRESET/TUNING** so that the colon (:) disappears from the front panel display and then press **PRESET/TUNING** \triangleleft to begin tuning toward lower frequencies.



Manual preset tuning

You can also store up to 40 stations (A1 to E8: 8 preset station numbers in each of the 5 preset station groups) manually.

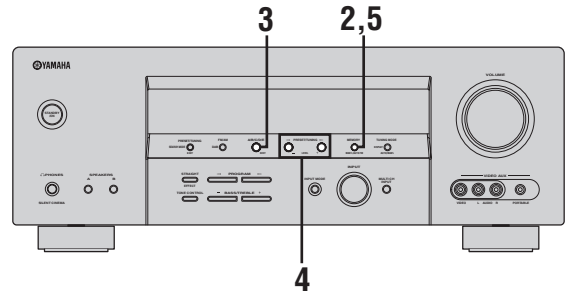

- 1 Tune into a station automatically or manually.**
See pages 43 and 44 for tuning instructions.

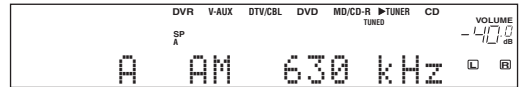

When this unit is tuned into a station, the front panel display shows the frequency of the station received.

- 2 Press MEMORY (MAN'L/AUTO FM).**

The MEMORY indicator flashes in the front panel display for approximately 5 seconds.

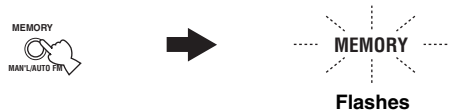

- 3 Press A/B/C/D/E repeatedly to select a preset station group (A to E) while the MEMORY indicator is flashing.**

The selected preset station group letter appears. Check that the colon (:) appears in the front panel display.

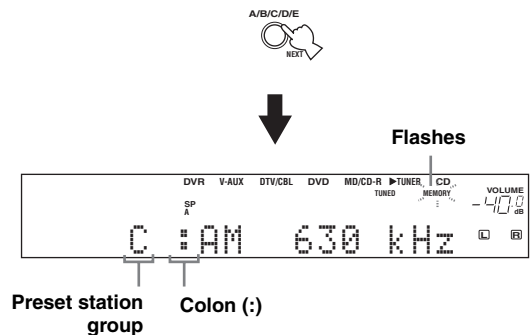

- 4** Press PRESET/TUNING ◀/▶ to select a preset station number (1 to 8) while the MEMORY indicator is flashing.
- Press ▶ to select a higher preset station number.
 - Press ◀ to select a lower preset station number.

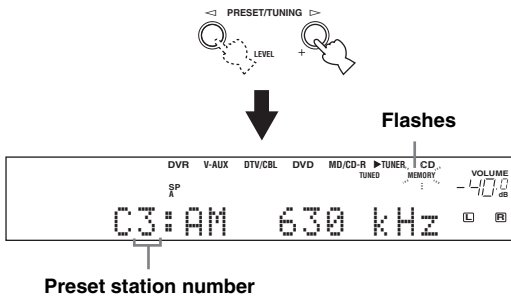

- 5** Press MEMORY (MAN'L/AUTO FM) while the MEMORY indicator is flashing.
- The station band and frequency appear in the front panel display with the preset station group and number you have selected. The MEMORY indicator disappears from the front panel display.

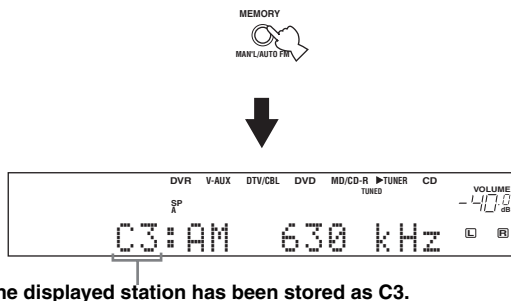

- 6** Repeat steps 1 through 5 to store other stations.

Notes

- Any stored station data existing under a preset station number is cleared when you store a new station under the same preset station number.
- The reception mode (stereo or monaural) is stored along with the station frequency.

Selecting preset stations

You can tune into any desired station simply by selecting the preset station group and number under which it was stored.

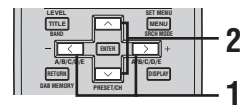
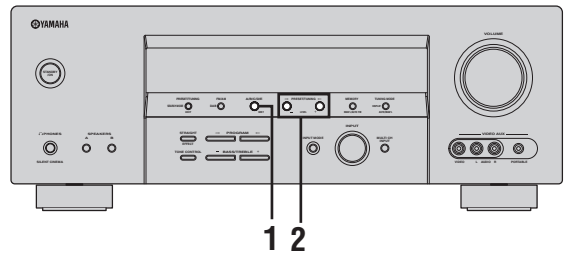

When performing this operation with the remote control, press TUNER to select "TUNER" as the input source.

- 1** Press A/B/C/D/E on the front panel (or A/B/C/D/E on the remote control) to select the desired preset station group (A to E). The preset station group letter appears in the front panel display and changes each time you press the button.



Front panel

or

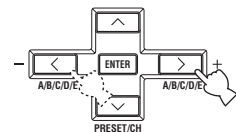

Remote control

- 2 Press PRESET/TUNING </> on the front panel (or PRESET/CH ^ / v on the remote control) to select the desired preset station number (1 to 8).**

The preset station group and number appear in the front panel display along with the station band and frequency.

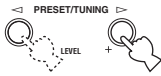

Front panel

or

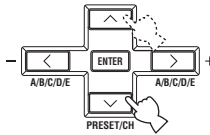

Remote control



You can select the desired preset station number (1 to 8) directly by pressing the numeric buttons on the remote control.

Exchanging preset stations

You can exchange the assignments of two preset stations with each other. The example below describes the procedure to exchange preset station “E1” with “A5”.

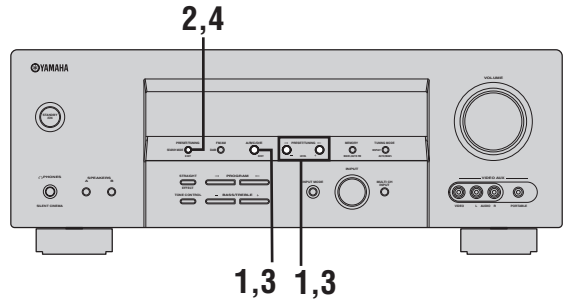

- 1 Select preset station “E1” using A/B/C/D/E and PRESET/TUNING </>.**

See “Selecting preset stations” on page 47.

- 2 Press and hold EDIT for more than 3 seconds.**

“E1” and the MEMORY indicator flash in the front panel display.



Flashes



Flashes

3 Select preset station “A5” using A/B/C/D/E and PRESET/TUNING ◀/▶.

“A5” and the MEMORY indicator flash in the front panel display.

See “Selecting preset stations” on page 47.

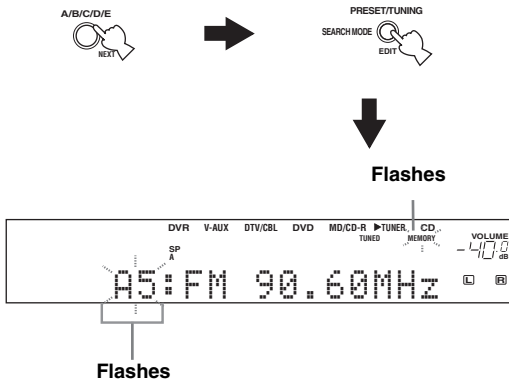

4 Press EDIT again.

“EDIT E1–A5” appears in the front panel display and the assignments of the two preset stations are exchanged.

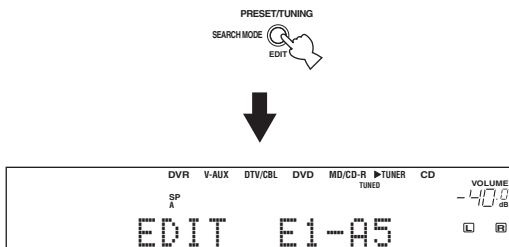

RADIO DATA SYSTEM TUNING

Radio Data System is a data transmission system used by FM stations in many countries. The Radio Data System function is carried out among the network stations. This unit can receive various Radio Data System data such as PS (program service), PTY (program type), RT (radio text), CT (clock time), and EON (enhanced other networks) when receiving Radio Data System broadcasting stations.

Selecting the Radio Data System program

Use this feature to select one of the 15 Radio Data System program types and search for all the available preset stations of the selected program type.

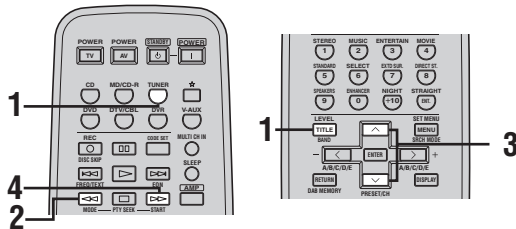

- 1 Press TUNER on the remote control and then press BAND to select "FM" as the reception band.**

"FM" appears in the front panel display.



- 2 Press PTY SEEK MODE on the remote control to set this unit to the PTY SEEK mode.**

The name of the program type or "NEWS" flashes in the front panel display.

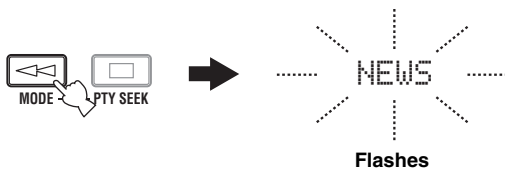

To cancel the PTY SEEK mode, press PTY SEEK MODE on the remote control again.

- 3 Press PRESET/CH ^ / v on the remote control to select the desired program type.**
The name of the selected program type appears in the front panel display.

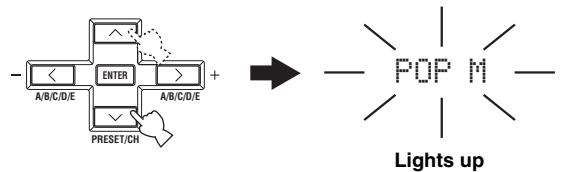

Program type	Descriptions
NEWS	News
AFFAIRS	Current affairs
INFO	General information
SPORT	Sports
EDUCATE	Education
DRAMA	Drama
CULTURE	Culture
SCIENCE	Science
VARIED	Light entertainment
POP M	Popular music
ROCK M	Rock music
M.O.R. M	Middle-of-the-road music (easy-listening)
LIGHT M	Light classics
CLASSICS	Serious classics
OTHER M	Other music

4 Press PTY SEEK START on the remote control to start searching for all the available Radio Data System preset stations.

The name of the selected program type flashes and the PTY HOLD indicator lights up in the front panel display while this unit is searching for stations.

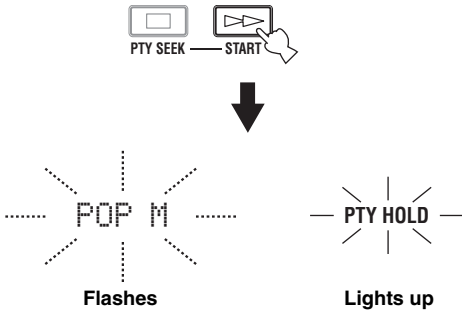

To stop searching for stations, press PTY SEEK START on the remote control again.

Notes

- This unit stops searching for stations when a station broadcasting the selected program type is found.
- If the station found is not the one you desire, press PTY SEEK START again to resume searching for another station broadcasting the same program type.

Using the Radio Data System station network

Use this feature to receive the EON (enhanced other networks) data service of the Radio Data System station network. Once you select one of the 4 Radio Data System program types (NEWS, AFFAIRS, INFO, or SPORT), this unit automatically searches for all the available preset stations that are scheduled to broadcast the EON data service of the selected program type for a certain duration of time. When the scheduled EON data service starts, this unit automatically switches to the local station broadcasting the EON data service and then switches back to the national station once the EON data service ends.

Notes

- You can use this feature only when the EON data service is available.
- The EON indicator lights up in the front panel display only when the EON data service is being received from a Radio Data System station.

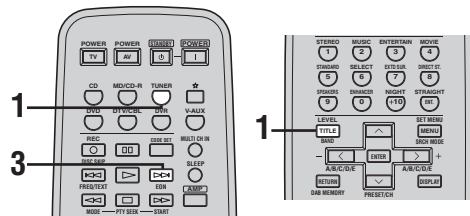

BASIC OPERATION

1 Press TUNER on the remote control and then press BAND to select "FM" as the reception band.

"FM" appears in the front panel display.



2 Make sure the EON indicator is lit in the front panel display.

If the EON indicator is not lit in the front panel display, select another Radio Data System program so that the EON indicator lights up.

- Press EON on the remote control repeatedly to select one of the 4 Radio Data System program types (NEWS, AFFAIRS, INFO or SPORT).

The name of the selected program type appears in the front panel display.

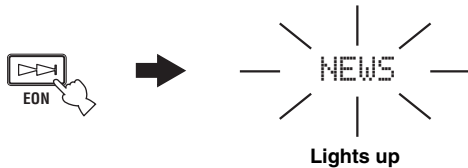

To cancel the EON feature, press EON on the remote control repeatedly until the name of the program type disappears and "EON OFF" appears in the front panel display.

Displaying the Radio Data System information

Use this feature to display the 4 types of the Radio Data System information: PS (program service), PTY (program type), RT (radio text) and CT (clock time). The corresponding indicators light up in the front panel display.

Notes

- You can select one of the Radio Data System modes only when the corresponding Radio Data System indicator lights up in the front panel display. It may take a while for this unit to receive all of the Radio Data System data from the station.
- You can select only the available Radio Data System modes being offered by the station.
- If the signals being received are not strong enough, this unit may not be able to utilize the Radio Data System data. In particular, the "RT" mode requires a large amount of data and may not be available even when the other Radio Data System modes are available.
- In case of poor reception conditions, press TUNING MODE (AUTO/MAN'L) on the front panel so that the AUTO indicator disappears from the front panel display.
- If the signal strength is weakened by external interference while this unit is receiving the Radio Data System data, the reception may be cut off unexpectedly and "...WAIT" appears in the front panel display.
- When the "RT" mode is selected, this unit can display the program information by a maximum of 64 alphanumeric characters, including the umlaut symbol. Unavailable characters are displayed with the "_" (underscore).
- If the reception is cut off when the "CT" mode is selected, "CT WAIT" appears in the front panel display.

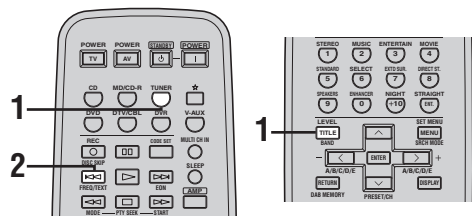

- Press TUNER on the remote control and then press BAND to select "FM" as the reception band.

"FM" appears in the front panel display.



- 2 Press **FREQ/TEXT** on the remote control repeatedly to select the desired Radio Data System display mode.

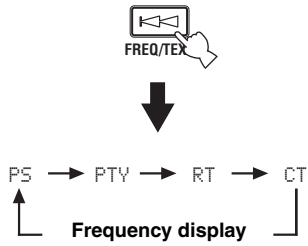

- Select “PS” to display the name of the Radio Data System program currently being received.
- Select “PTY” to display the type of the Radio Data System program currently being received.
- Select “RT” to display the information on the Radio Data System program currently being received.
- Select “CT” to display the current time.

DAB (DIGITAL AUDIO BROADCASTING) TUNING

DAB (Digital Audio Broadcasting), also known as digital radio, is a new way of radio broadcasting. DAB is broadcast using digital signals instead of analog signals, resulting in near CD-quality sound. Analog signals (i.e. AM/FM) are susceptible to interference (i.e. distorting and noise) caused by electrical equipment, weather conditions, tall buildings, mountains, etc. whereas digital signals are not. Thus, with DAB, there is virtually interference-free reception and no hiss or crackle.

Another advantage of DAB is that a large amount of information can be carried within the digital signal. DAB is broadcast in blocks of data called ensembles (also known as multiplexes). Several radio programs called services can be broadcast simultaneously in each ensemble. This means that you can choose between several radio programs within one frequency.

In addition to the audio signal, service information is also broadcast and displayed in the front panel display of this unit. Part of the service information is text data information called Dynamic Label Segment (DLS). For more information, see page 59.

With DAB, there is no need to remember channel frequencies. All broadcasts are selected by simply selecting the service name.

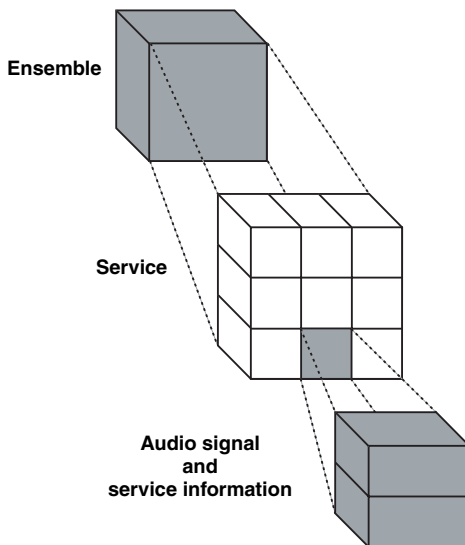

Notes

- Be sure to check the DAB coverage in your area in that not all areas are currently being covered. For a list of nationwide DAB statuses and worldwide DAB frequencies, check WorldDAB online at "<http://www.worlddab.org/>".
- The sound quality and service information are controlled by the DAB broadcaster, not this unit. Not all DAB broadcasters transmit service information.
- DAB signals are broadcast in Band-III (174 – 240 MHz) and L-Band (1452 – 1492 MHz). This unit is able to receive both bands.

Preparing the DAB tuning

Before tuning into DAB services, you have to perform the initial scan.

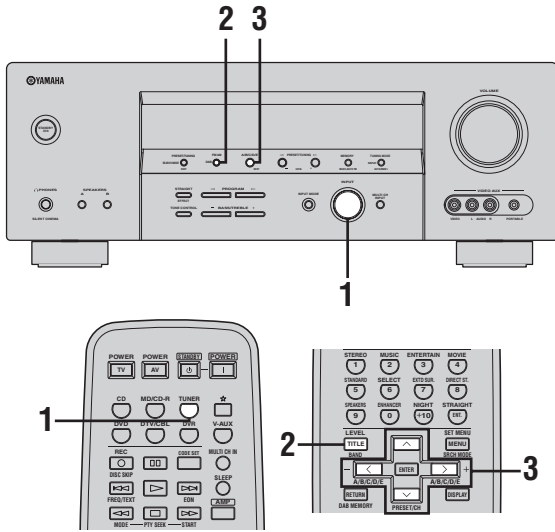

- 1 Rotate the INPUT selector on the front panel (or press TUNER on the remote control) to select "TUNER" as the input source.

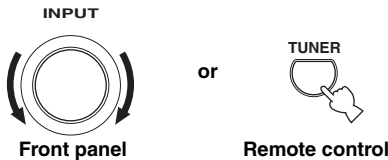

- 2 Press DAB on the front panel (or BAND on the remote control) repeatedly to select DAB as the reception band.

The DAB indicator lights up in the front panel display. When you did not perform the initial scan, "Initiate Scan" appears in the front panel display.

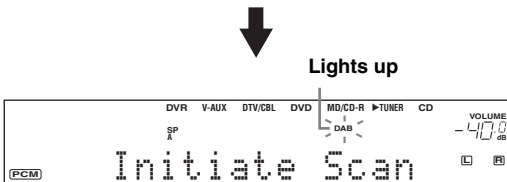
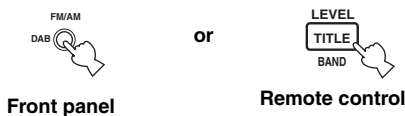

When you already performed the initial scan before you set this unit to the DAB tuning mode for the first time, "Initiate Scan" does not appear in the front panel display. See step 3 on page 56, and proceed with the DAB tuning operation.

- 3 Press A/B/C/D/E on the front panel (or $\wedge/\vee / \langle / \rangle$ on the remote control) to start the initial scan operation.

This unit starts the scan for DAB ensembles. While the scan is in progress, "Scanning" and the percentage of the progress of the scan appears in the front panel display. When this unit completes the scan, "FINISH" and the number of receivable DAB services appears in the front panel display, and then this unit enters the DAB tuning mode automatically.

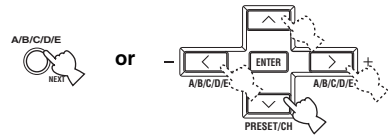

Scanning 30%

FINISH [015]

Example: if 15 DAB services were found



Notes

- If the initial scan operation is not successful, "Not Available" appears in the front panel display. You can start the initial scan again by pressing A/B/C/D/E on the front panel (or $\wedge/\vee / \langle / \rangle$ on the remote control). When you want to exit the DAB tuning mode, press BAND on the remote control to select the other bands.
- For further details about problems and their proper remedies, see the "Tuner" section in "TROUBLESHOOTING" on page 94.

DAB tuning

There are five DAB tuning methods: “ALPHANUMERIC”, “ACTIVE”, “ENSEMBLE”, “FAVOURITE”, and “PRESET”. You can select the desired services with the channel labels displayed in the front panel display.

Note

Once you perform an initial scan, the registry list of available services is updated automatically as long as this unit is in the DAB tuning mode. To register new ensembles, perform an initial scan again (see page 62).

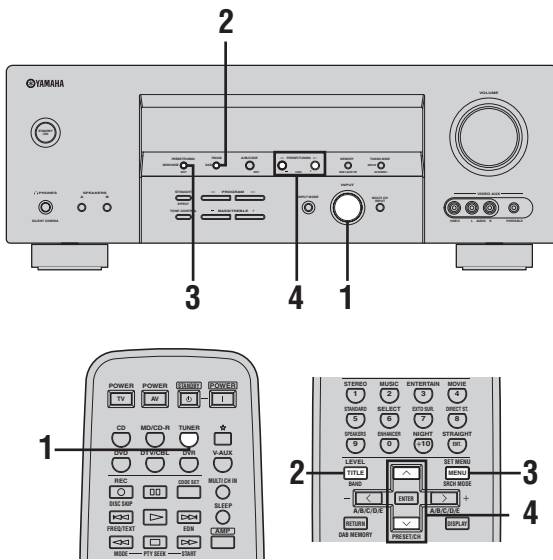

1 Rotate the INPUT selector on the front panel (or press TUNER on the remote control repeatedly) to select “TUNER” as the input source.

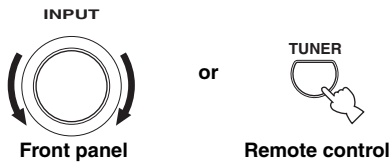

2 Press DAB on the front panel (or BAND on the remote control) repeatedly to select “DAB” as the reception band.

The DAB indicator lights up in the front panel display while this unit is in the DAB tuning mode.

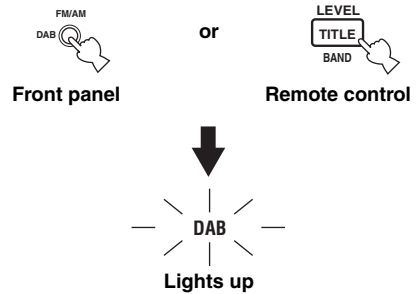

3 Press SEARCH MODE on the front panel (or SRCH MODE on the remote control) repeatedly to select the desired DAB tuning method.

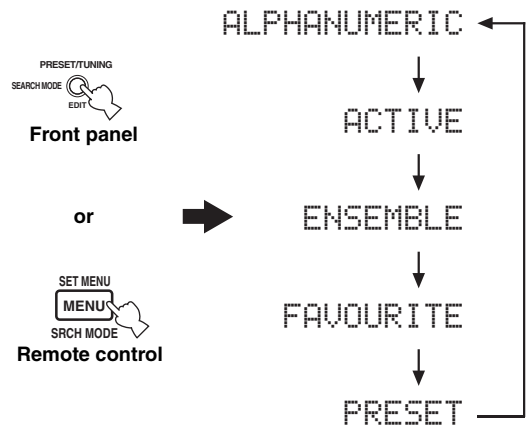

- Select “ALPHANUMERIC” to browse through all of the registered DAB services in the alphanumeric order.
- Select “ACTIVE” to browse through all of the receivable DAB services in the alphabetical order.
- Select “ENSEMBLE” to browse through the registered channel labels from the lowest to the highest channel labels.
- Select “FAVOURITE” to browse through the top 10 services most frequently selected with this unit.
- Select “PRESET” to tune into preset DAB services by entering the corresponding preset service number. When you select “PRESET”, the PRESET indicator lights up in the front panel display.

Note

For details about tuning into preset DAB services, see pages 57 and 58.

- 4 Press PRESET/TUNING ◀/▶ on the front panel (or PRESET/CH ^/∨ on the remote control) repeatedly to search for registered DAB services.

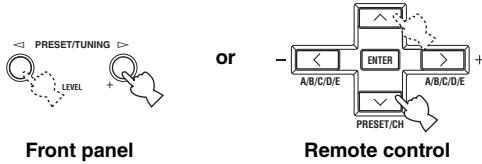

To return to the top of the list, press A/B/C/D/E on the front panel (or </> on the remote control).

Notes

- The SECONDARY indicator lights up when this unit is receiving a secondary service. This unit returns to the corresponding primary service when the secondary service becomes timed out.
- You can change the information in the front panel display. See page 59 for details.

DAB preset tuning

You can use the DAB preset tuning feature to store preset DAB services in the memory. You can then recall any preset service easily by selecting the preset service number assigned to the corresponding DAB service.

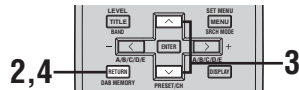
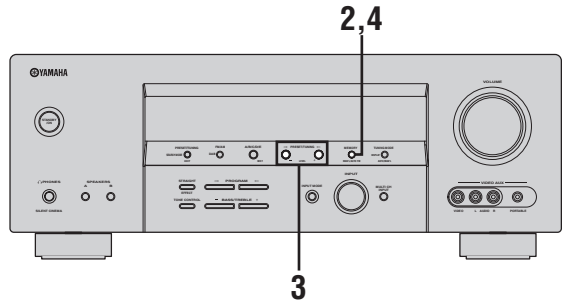

BASIC OPERATION

- 1 Tune into the desired DAB service.
See page 56 for tuning instructions.

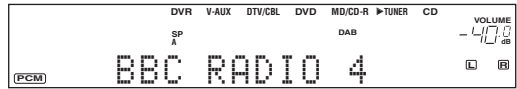

- 2 Press MEMORY on the front panel (or DAB MEMORY on the remote control).

The MEMORY indicator flashes in the front panel display for approximately 5 seconds.

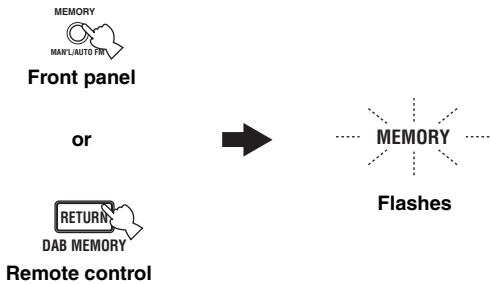

- Press **PRESET/TUNING** $\triangleleft/\triangleright$ on the front panel (or **PRESET/CH** \wedge/\vee on the remote control) repeatedly until “EMPTY” appears next to the preset service number in the front panel display.

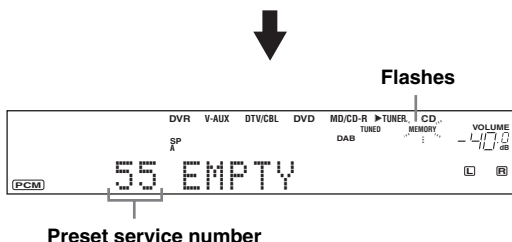
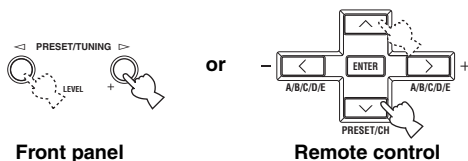

- “EMPTY” appears when no preset DAB service is assigned to the corresponding service number.
- You can select the desired preset service number directly by pressing the numeric buttons on the remote control.

Note

Any stored DAB service data existing under a preset service number is cleared when you store a new service under the same preset service number.

- Press **MEMORY** on the front panel (or **DAB MEMORY** on the remote control). The MEMORY indicator disappears from the front panel display.

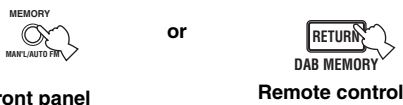

- Repeat steps 1 through 4 to store other DAB services.

Note

While you are browsing and changing the SET MENU parameters, you cannot preset any DAB service.

Selecting preset DAB services

You can tune into any desired DAB service simply by entering the corresponding preset service number under which it was stored.

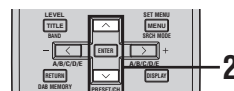
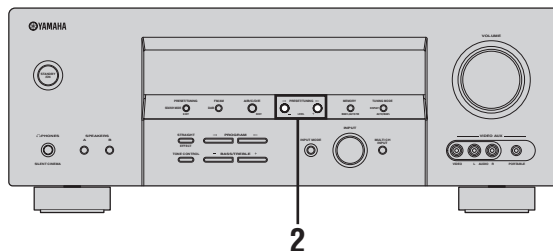

- Select “DAB” as the reception band and then select “PRESET” as the DAB tuning method. The PRESET indicator lights up in the front panel display. See page 56 for the DAB tuning instruction.

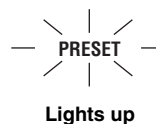

Lights up

2 Press PRESET/TUNING $\triangleleft/\triangleright$ on the front panel (or PRESET/CH \wedge/\vee on the remote control) to browse through the preset DAB services in the registry list.

Unassigned preset service numbers are skipped and only assigned preset service numbers along with their DAB service names appear in the front panel display for approximately 3 seconds.

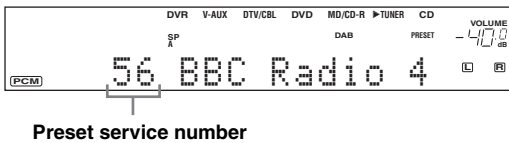
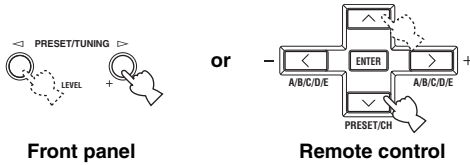

Approximately after 3 seconds



- You can select the desired preset service number directly by pressing the numeric buttons and ENTER on the remote control. To enter numbers less than 10 (i.e. 1 to 9), simply press 0 and then the number itself. For example, to select the preset DAB service assigned to preset service number 7, press 0 and then 7 in turn.
- “EMPTY” appears briefly when no preset DAB service is assigned to the corresponding preset service number. The DAB service currently being received is then displayed in the front panel display.

DAB service information

Use this feature to display various information about the DAB service currently being received.

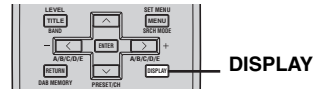
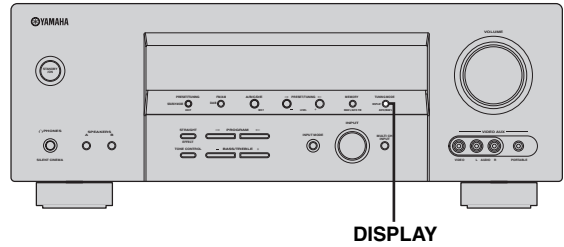

Press DISPLAY on the front panel (or on the remote control) repeatedly while a DAB service is currently being broadcast.

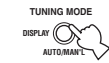

Each time you press DISPLAY on the front panel (or on the remote control), information displayed in the front panel display changes in the following order.

Order	Information type	Example
1	Service label	Classic FM
2	Dynamic Label Segment (DLS)	Classic FM on the internet...
3	Ensemble label	Digital11 Network
4	Program type	Classic Music
5	Date and time	05JUL05 10:50
6	Audio mode and bit rate	Stereo 160kbps
7	Channel label and frequency	11D 222.06MHz
8	Signal quality	Signal0.: 100

Notes

- The information order starts from the beginning again after the signal quality information has been displayed in the front panel display.
- If the DAB information contains a character that cannot be recognized by this unit, the character will be displayed with an underscore “_”.

Service label

Displays the name of the current DAB service up to 16 characters.

Dynamic Label Segment (DLS)

Displays information about the current DAB service. Examples are the title of the current song or program, the name of the artist or speaker, and the name of the next song or program. This data is continuously updated by the DAB broadcaster, thus changing often with every new song or program. Other data, such as news, weather, and sports headlines, may be broadcast as well.

Ensemble label

Displays the name of the current ensemble up to 16 characters.

Program type

Displays the genre (song or program type) of the current DAB service up to 16 characters.

Date and time

Displays the current date and time. This data is updated with each passing minute.

Audio mode and bit rate

Displays the audio mode and bit rate of the current DAB service.

Channel label and frequency

Displays the channel label and frequency of the current DAB service.

Signal quality

Displays the signal quality (from 0 (none) to 100 (best)) of the current DAB service. A higher number means a better reception level.



The front panel display can indicate up to 14 alphanumeric characters at once. The dynamic label segment scrolls in a continuous manner and the service label, ensemble label and program type scroll at once.

Using DAB MENU

There are 5 operations in DAB MENU: "INIT SCAN", "TUNE AID", "DRC MODE", "PRUNE LIST", and "PRESET DEL". Use the remote control to access and adjust each operation in DAB MENU.

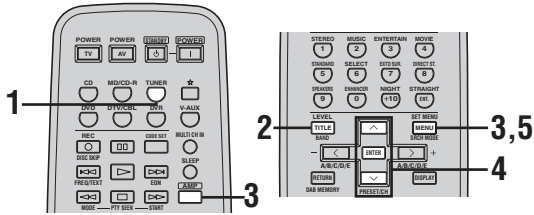

- 1 Press TUNER to select "TUNER" as the input source.



- 2 Press BAND repeatedly to select "DAB" as the reception band.

The DAB indicator lights up in the front panel display.

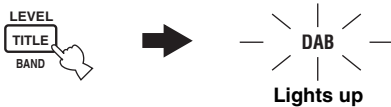

- 3 Press AMP and then press SET MENU. "INIT SCAN" appears in the front panel display.

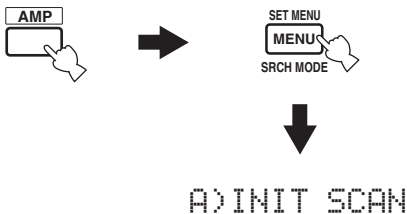

- 4 Press ^/∨ repeatedly and then press ENTER to select and enter the desired submenu.

For details about each operation, see pages 62 to 65.

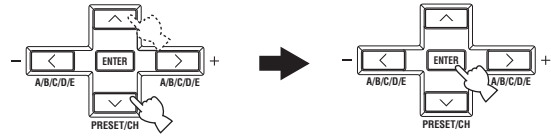

- 5 Press SET MENU to exit from "SET MENU".



Initial scan A) INIT SCAN

Use this feature to locate all of the DAB ensembles and services in your area. When "INIT SCAN" is selected, this unit scans the entire range of Band III and L-Band (or the limited range of Band III, if selected), and creates a registry list of all the receivable DAB ensembles and services.

1 Press ^ / v repeatedly to select "INIT SCAN" in "DAB MENU", and then press ENTER.

See page 61 for details.

The current setting appears in the front panel display.

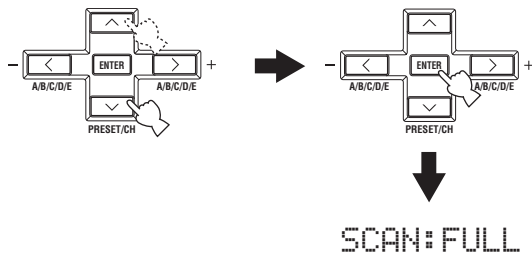

2 Press </> to select the desired option.

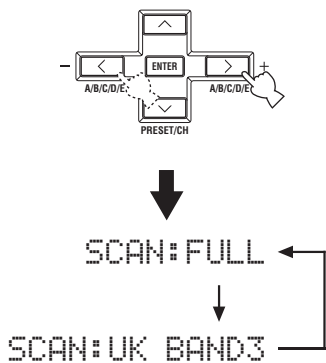

Choices: **FULL**, UK BAND3

- Select "FULL" to scan both Band III (174 – 240 MHz) and L-Band (1452 – 1490 MHz) for DAB ensembles.
- Select "UK BAND3" to scan within the range of Band III limited for United Kingdom (218 – 230 MHz) for DAB ensembles.

3 Press ENTER to confirm the desired option.

"SCAN?[ENTER]" appears in the front panel display.

SCAN?[ENTER]



When you want to cancel the initial scan, press RETURN on the remote control.

4 Press ENTER again to start the selected initial scan operation.

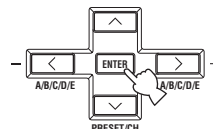

This unit starts scanning the selected band(s) for DAB ensembles. While scanning is in progress, "Scanning" appears in the front panel display. Once scanning has been completed, "FINISH [###]" appears in the front panel display for approximately 3 seconds ("###" indicates the number of receivable DAB services), and then this unit returns to the DAB tuning mode automatically.

Scanning 30%

FINISH [015]

Example: if 15 DAB services were found



Note

If the initial scan operation was not successful, "Not Available" appears in the front panel display. In such cases, press A/B/C/D/E on the front panel (or ^ / v on the remote control) to start "INIT SCAN" automatically.



- You can cancel the initial scan in the middle by pressing RETURN on the remote control. When "BREAK?[ENTER]" appears in the front panel display, press ENTER on the remote control to return to "INIT SCAN".
- For further details about problems and their proper remedies, see the "Tuner" section in "TROUBLESHOOTING" on page 94.

Tuning aid B)TUNE AID

Use this feature to display the strength of the current DAB signals in the front panel display. You can use this feature to adjust the positioning of the DAB antenna and this unit. It is recommended that you perform this operation when setting up this unit in order to maximize the DAB reception capability.

1 Press ^ / v to select "TUNE AID" in "DAB MENU", and then press ENTER.

See page 61 for details.
The signal strength level of the selected DAB channel appears in the front panel display.
Display status: 0 (none) to 100 (best)

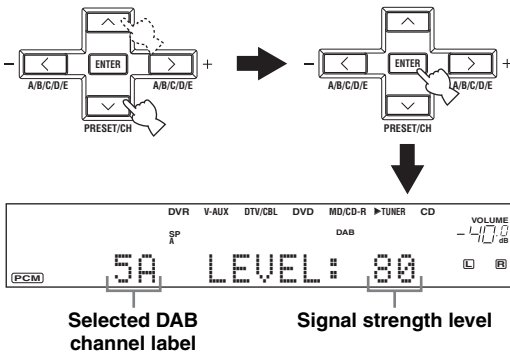

2 Press </> to switch between channel labels.

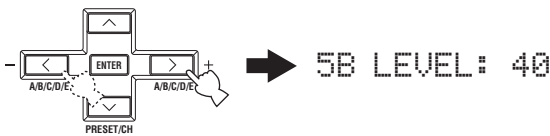

For a complete list of channel labels, see "DAB frequency information" on page 102.

3 Press ENTER.

This unit returns to the "TUNE AID" menu.



DRC mode C)DRC MODE

Some DAB broadcasters transmit a wide dynamic range enabling high quality sound, accompanied by DRC (Dynamic Range Control) data. Use this feature to compress the dynamic range of the DAB broadcast. This is especially useful when you listen to a DAB service in a noisy environment or at a low volume at night.

1 Press ^ / v to select "DRC MODE" in "DAB MENU", and then press ENTER.

See page 61 for details.
The current setting appears in the front panel display.

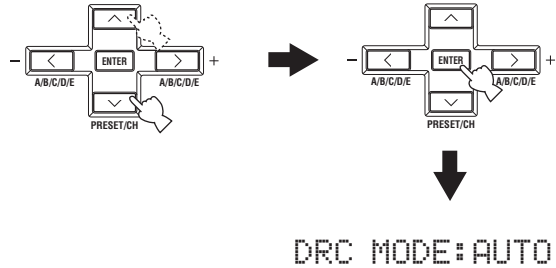

2 Press </> to select the desired option.

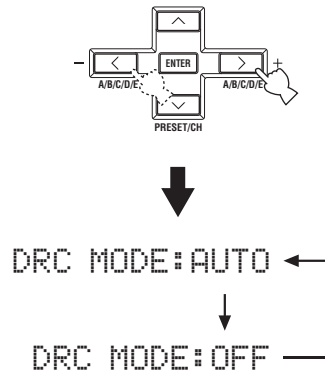

Choices: **AUTO**, **OFF**

- Select "AUTO" to utilize DRC data (if transmitted). The dynamic range of the DAB signals is compressed, enhancing the audio quality in a noisy environment or at a low volume at night.
- Select "OFF" not to utilize DRC data (if transmitted). The dynamic range of the DAB signals is played in full, enabling high quality sound.

Note

If "AUTO" is selected and the DAB broadcast contains DRC data, the DRC indicator lights up in the front panel display.

3 Press ENTER.

This unit returns to the "DRC MODE" menu.

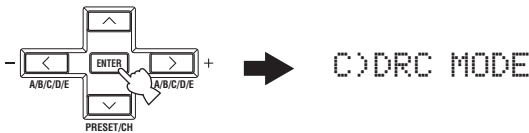

Prune list D>PRUNE LIST

Use this feature to delete a group of inactive DAB ensembles and services from the DAB registry list.

1 Press ^ / v to select "PRUNE LIST" in "DAB MENU", and then press ENTER.

See page 61 for details.

"OK?[ENTER]" appears in the front panel display.

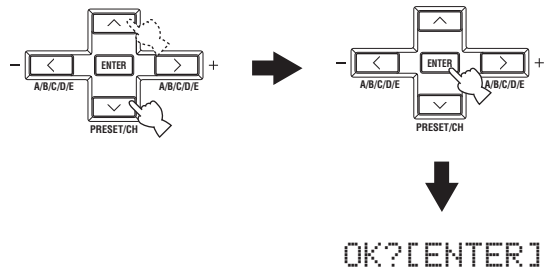

2 Press ENTER again to confirm your selection.

Inactive DAB ensembles and services are deleted from the DAB registry list. Once this operation has been completed, "FINISH" appears in the front panel display, and then this unit returns to the "PRUNE LIST" menu.

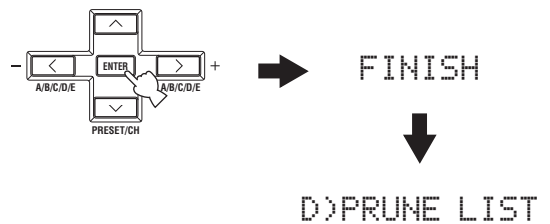

■ Preset delete E)PRESET DEL

Use this feature to specify and delete unnecessary DAB services from the DAB registry list.

1 Press ^ / v to select "PRESET DEL" in "DAB MENU", and then press ENTER.

See page 61 for details.

"DELETE:--" appears in the front panel display.

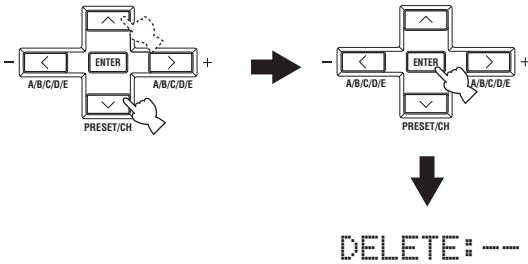

2 Press </> to select the desired preset service number.

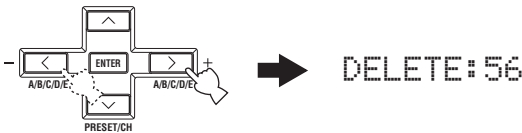

Note

Only the preset service number appears in the front panel display.

3 Press ENTER to confirm the selection.

"OK?[ENTER]" appears in the front panel display.

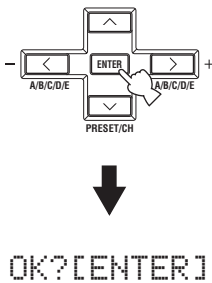

4 Press ENTER to delete the selected preset DAB service from the DAB registry list.

Once this operation is completed, "DELETE OK" appears in the front panel display, and then this unit returns to the "PRESET DEL" menu.



To cancel the procedure, press RETURN.

SOUND FIELD PROGRAMS

What really creates the rich, full tones of a live instrument are the multiple reflections from the walls of the room. In addition to making the sound live, these reflections enable us to tell where the player is situated as well as the size and shape of the room in which we are sitting.

■ Elements of a sound field

There are two distinct types of sound reflections that combine to make up the sound field in addition to the direct sound coming straight to our ears from the player's instrument.

Early reflections

Reflected sounds reach our ears extremely rapidly (50 ms to 100 ms after the direct sound), after reflecting from one surface only (for example, from a wall or the ceiling). Early reflections actually add clarity to the direct sound.

Reverberations

These are caused by reflections from more than one surface (for example, from the walls, and the ceiling) so numerous that they merge together to form a continuous sonic afterglow. They are non-directional and lessen the clarity of the direct sound.

Direct sound, early reflections and subsequent reverberations taken together help us to determine the subjective size and shape of the room, and it is this information that the digital sound field processor reproduces in order to create sound fields.

If you could create the appropriate early reflections and subsequent reverberations in your listening room, you would be able to create your own listening environment. The acoustics in your room could be changed to those of a concert hall, a dance floor, or a room with virtually any size at all. This ability to create sound fields at will is exactly what YAMAHA has done with the digital sound field processor.

Selecting sound field programs

Notes

- Choose a sound field program based on your listening preference, not merely on the name of the program.
- When you select an input source, this unit automatically selects the last sound field program used with the corresponding input source.
- Sound field programs cannot be selected when the component connected to the MULTI CH INPUT jacks is selected as the input source (see page 36).
- Sampling frequencies higher than 48 kHz (except for DTS 96/24 signals) are sampled down to 48 kHz and then sound field programs are applied.

■ Front panel operations

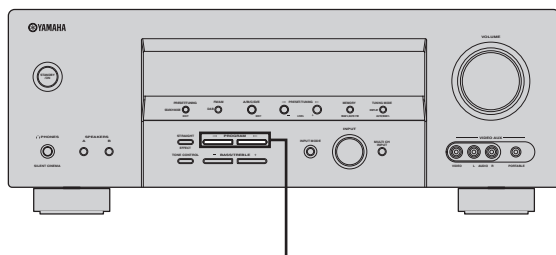

Press the PROGRAM </> buttons on the front panel repeatedly.

The name of the selected sound field program appears in the front panel display.

■ Remote control operations

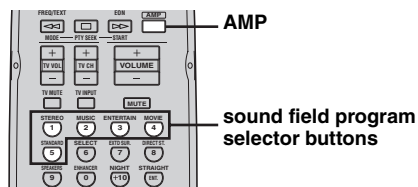

Press AMP and then press one of the sound field program selector buttons on the remote control repeatedly.

The name of the selected sound field program appears in the front panel display.

Sound field program descriptions

This unit is equipped with a variety of precise digital decoders that allow you to enjoy multi-channel playback from almost any stereo or multi-channel sound source. This unit is also equipped with a YAMAHA digital sound field processing (DSP) chip containing several sound field programs which you can use to enhance your playback experience.



The YAMAHA CINEMA DSP modes are compatible with all Dolby Digital, DTS, and Dolby Surround sources. Set "INPUT MODE" to "AUTO" (see page 32) to enable this unit to automatically switch to the appropriate digital decoder according to the input signal.

Notes

- The DSP sound field programs of this unit are recreations of real-world acoustic environments made from precise measurements taken in the actual concert hall, music venue, movie theater, etc. Thus, you may notice variations in the strength of the reflections coming from the front, back, left and right.
- Choose a sound field program based on your listening preference, not merely on the name of the program itself.

■ For movie/video sources

You can select from the following sound fields when playing movie or video sources. The sound fields marked "MULTI" can be used with multi-channel sources, like DVD, digital TV, etc. Those marked "2-CH" can be used with 2-channel stereo sources like TV programs, video tapes, etc.



Press the PROGRAM ◀/▶ buttons on the front panel (or press AMP and then press one of the sound field program selector buttons on the remote control) to select the desired sound field program (see page 66).

Remote control button	Sound Field Program	Features	Sources
1	STEREO 2ch Stereo	Downmixes multi-channel sources to 2 channels or plays back 2-channel sources as they are.	
2	MUSIC Pop/Rock	CINEMA DSP processing. Creates an enthusiastic atmosphere where you can feel as if you are in an actual jazz or rock concert.	
3	ENTERTAINMENT TV Sports	CINEMA DSP processing. Reproduces the sound environment of a large concert hall using the surround sound field to enhance your experience of watching various TV programs such as news, variety shows, music programs or sports programs.	MULTI 2-CH
	ENTERTAINMENT Mono Movie	CINEMA DSP processing. Reproduces monaural video sources (such as old movies) at the optimum reverberation level to create sound depth using only the presence sound field.	
	ENTERTAINMENT Game	CINEMA DSP processing. Adds a deep and spatial feeling to video game sounds.	

Remote control button	Sound Field Program	Features	Sources
4	MOVIE THEATER Spectacle	CINEMA DSP processing. This program reproduces the extremely wide sound field of a 70-mm movie theater in detail, making both the video and the sound field incredibly real. This is ideal for any kind of video source encoded in Dolby Surround, Dolby Digital or DTS, especially large-scale movie productions.	MULTI 2-CH
	MOVIE THEATER Sci-Fi	CINEMA DSP processing. This program reproduces dialog and sound effects in the latest sound form for science fiction films, thus creating a broad and expansive cinematic space amid silence. You can enjoy science fiction films encoded in Dolby Surround, Dolby Digital or DTS in a virtual-space sound field employing the most advanced techniques.	
	MOVIE THEATER Adventure	CINEMA DSP processing. This program reproduces the sound design of the newest 70-mm and multi-channel soundtrack films similar to the sound field of the newest movie theaters, so the reverberations of the sound field itself are restrained as much as possible.	
	MOVIE THEATER General	CINEMA DSP processing. This program reproduces sounds from 70-mm and multi-channel soundtrack films characterized by soft and extensive sound field.	
5	SUR. STANDARD	Standard processing for the selected decoder.	
	SUR. ENHANCED	Enhanced processing for the selected decoder.	

■ **For music sources**

You can select from the following sound fields when playing music sources, like CD, FM/AM broadcasting, tapes, etc.



Press the PROGRAM </> buttons on the front panel (or press AMP and then press one of the sound field program selector buttons on the remote control) to select the desired sound field program (see page 66).

Remote control button	Sound field program	Features	Sources
1	STEREO 2ch Stereo	Plays back 2-channel sources.	2-CH
	STEREO 6ch Stereo	Plays back 2-channel sources from all speakers in 6.1 channels, providing a larger sound field ideal for background music at parties, etc.	
2	MUSIC Hall in Vienna	HiFi DSP processing. The program reproduces a classic shoe-box type concert hall with approximately 1700 seats. Pillars and ornate carvings create extremely complex reflections which produce a very full, rich sound.	MULTI 2-CH
	MUSIC The Bttm Line	HiFi DSP processing. This program reproduces the stage front in "The Bottom Line", a famous New York jazz club where 300 people can be seated.	
	MUSIC The Roxy Thtr	HiFi DSP processing. This program reproduces the dynamic rock music environment of "The Roxy Theatre", one of the hottest rock clubs in L.A. The listener's imaginary seat is at the center-left of the hall.	
3	ENTERTAINMENT Disco	HiFi DSP processing. This program reproduces the acoustic environment of a lively disco in the heart of a big city to create a highly concentrated and energetic sound.	
5	SUR. STANDARD	Standard processing for the selected decoder.	
	SUR. ENHANCED	Enhanced processing for the selected decoder.	

Changing sound field parameter settings

You can enjoy good quality sound with the initial factory settings. Although you do not have to change the initial factory settings, you can change some of the parameters to better suit the input source or your listening room.

Notes

- Use the "PARAM. INI" feature in "OPTION MENU" to initialize the parameters of each sound field program within a sound field program group (see page 87).
- You cannot change the sound field parameter values when "MEMORY GUARD" in "OPTION MENU" is set to "ON" (see page 87). If you want to change the sound field parameter values, set "MEMORY GUARD" to "OFF".



- For details about the function and control range of each sound field parameter, see page 70.
- Repeat steps 2 and 3 as necessary to change other sound field program parameter settings.
- If you press and hold </> to change the sound field parameter value, the initial factory settings are shown momentarily in the front panel display.

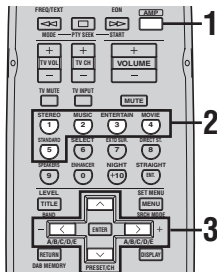

1 Press AMP on the remote control.



- ### 2 Press one of the sound field program selector buttons repeatedly to select the desired sound field program you want to adjust.



- ### 3 Press ^ / v to select the desired sound field parameter and then </> to change the selected sound field parameter value.

- Press > to increase the value.
- Press < to decrease the value.

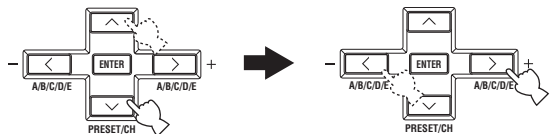

■ Sound field parameter descriptions

You can adjust the values of certain digital sound field parameters so that the sound fields are recreated accurately in your listening room. Not all of the following parameters are found in every program.



To change sound field parameter settings to suit your listening environment, see page 69 for details.

Sound field parameter	Features
DSP LEVEL	DSP level. Adjusts the level of all the DSP effect sounds within a narrow range. Depending on the acoustics of your listening room, you may want to increase or decrease the DSP effect level relative to the level of the direct sound. Control range: -6 dB to +3 dB
INIT. DLY P. INIT. DLY S. INIT. DLY SB INI. DLY	Initial delay. Presence, surround, and surround back initial delay. Changes the apparent distance from the source sound by adjusting the delay between the direct sound and the first reflection heard by the listener. The smaller the value, the closer the sound source seems to the listener. The larger the value, the farther it seems. For a small room, set to a small value. For a large room, set to a large value. Control range: 1 to 99 ms (INIT. DLY and P. INIT. DLY) 1 to 49 ms (S. INIT. DLY and SB INI. DLY)

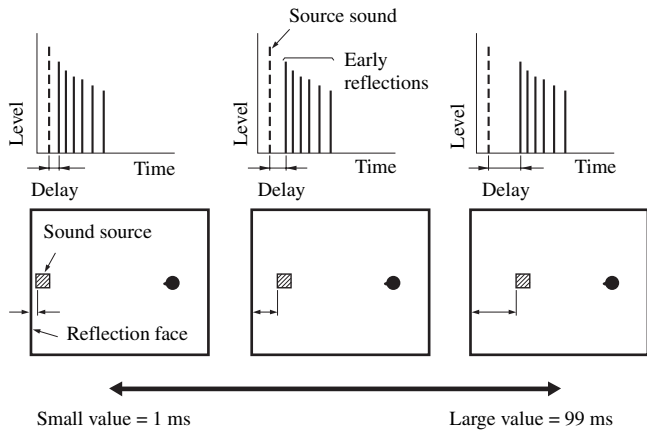

Sound field parameter	Features
-----------------------	----------

ROOM SIZE
P.ROOM SIZE
S.ROOM SIZE
SB RM SIZE

Room size. Presence, surround, and surround back room size. Adjusts the apparent size of the surround sound field. The larger the value, the larger the surround sound field becomes. As the sound is repeatedly reflected around a room, the larger the hall is, the longer the time between the original reflected sound and the subsequent reflections. By controlling the time between the reflected sounds, you can change the apparent size of the virtual venue. Changing this parameter from one to two doubles the apparent length of the room.

Control range: 0.1 to 2.0

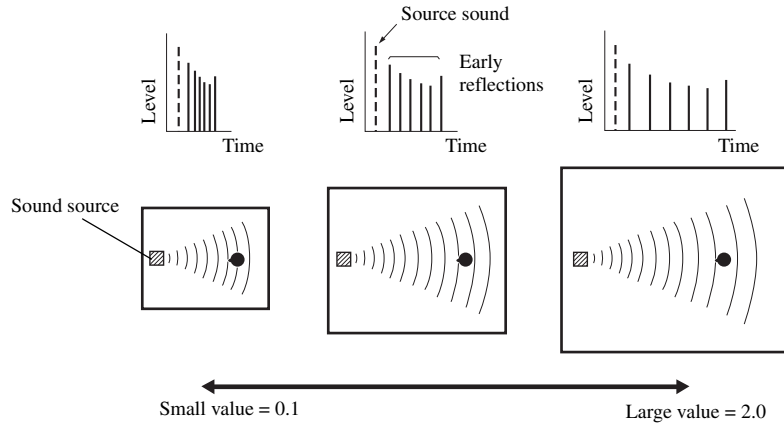

LIVENESS
S.LIVENESS
SB LIVENESS

Liveness. Surround and surround back liveness. Adjusts the reflectivity of the virtual walls in the hall by changing the rate at which the early reflections decay. The early reflections of a sound source decay much faster in a room with acoustically absorbent wall surfaces than in one which has highly reflective surfaces. A room with acoustically absorbent surfaces is referred to as “dead”, while a room with highly reflective surfaces is referred to as “live”. This parameter lets you adjust the early reflection decay rate and thus the “liveness” of the room.

Control range: 0 to 10

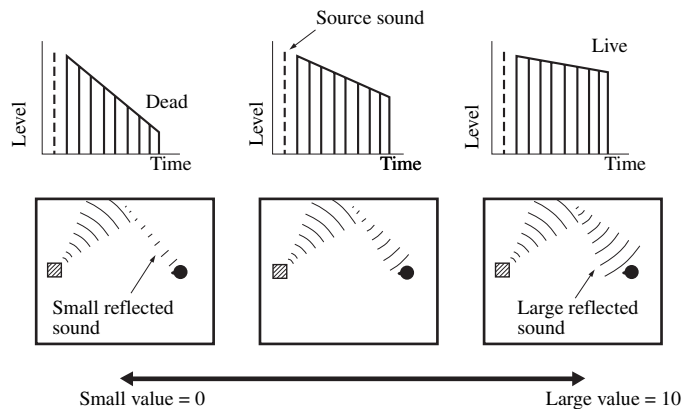

Sound field parameter	Features
-----------------------	----------

REV.TIME

Reverberation time. Adjusts the amount of time taken for the dense, subsequent reverberation sound to decay by 60 dB at 1 kHz. This changes the apparent size of the acoustic environment over an extremely wide range. Set a longer reverberation time for “dead” sources and listening room environments, and a shorter time for “live” sources and listening room environments.

Control range: 1.0 to 5.0 s

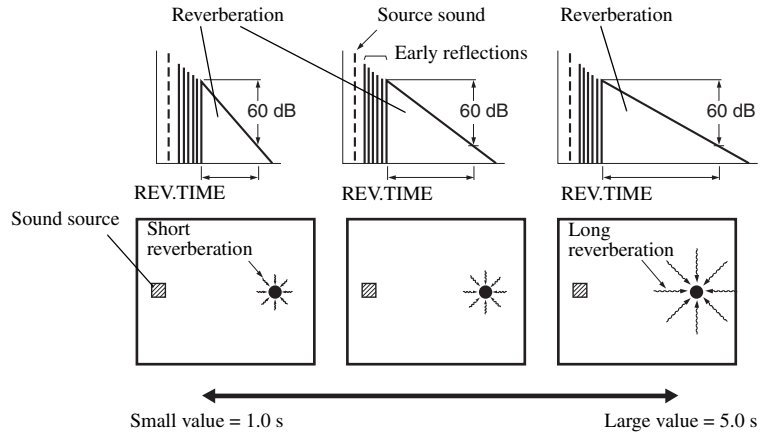



REV.DELAY

Reverberation delay. Adjusts the time difference between the beginning of the direct sound and the beginning of the reverberation sound. The larger the value, the later the reverberation sound begins. A later reverberation sound makes you feel as if you are in a larger acoustic environment.

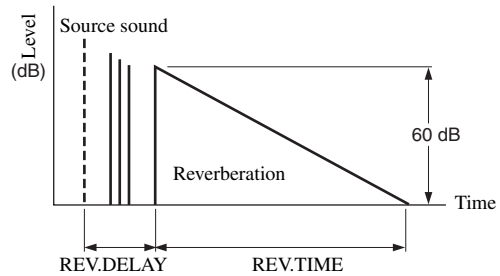
Control range: 0 to 250 ms

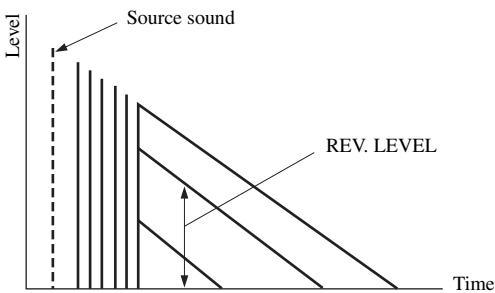

Sound field parameter	Features
REV. LEVEL	<p>Reverberation level. Adjusts the volume of the reverberation sound. The larger the value, the stronger the reverberation becomes.</p> <hr/> <p>Control range: 0 to 100%</p> <hr/>
	
<p>2ch Stereo DIRECT</p>	<p>2-channel stereo direct. Bypasses the decoders and DSP processors of this unit for pure hi-fi stereo sound when playing 2-channel analog sources.</p> <hr/> <p>Choices: AUTO, OFF</p> <hr/> <p></p> <ul style="list-style-type: none"> • The “AUTO” setting bypasses the decoders and DSP processors only when “BASS” and “TREBLE” are set to 0 dB (see page 30). • When multi-channel signals (Dolby Digital and DTS) are input, they are downmixed to 2 channels and output from the front left and right speakers. • The low-frequency signals input from the front left and right speakers are redirected to the subwoofer in the following cases: <ul style="list-style-type: none"> – “BASS OUT” is set to “BOTH” (see page 82). – “FRONT” is set to “SMALL” (see page 82) and “BASS OUT” is set to “SWFR” (see page 82).
<p>6ch Stereo CT LEVEL SL LEVEL SR LEVEL SB LEVEL</p>	<p>6-channel stereo center, surround left, surround right and surround back levels. Adjusts the volume level of each channel in the 6-channel stereo mode.</p> <hr/> <p>Control range: 0 to 100%</p> <hr/>

Sound field parameter	Features
PRO LOGIC IIx Music PRO LOGIC II Music PANORAMA	Pro Logic IIx Music and Pro Logic II Music panorama. Sends stereo signals to the surround speakers as well as the front speakers for a wraparound effect. Choices: OFF , ON
PRO LOGIC IIx Music PRO LOGIC II Music DIMENSION	Pro Logic IIx Music and Pro Logic II Music dimension. Adjusts the sound field either towards the front or towards the rear. Control range: -3 (towards the rear) to +3 (towards the front) Initial setting: STD (standard)
PRO LOGIC IIx Music PRO LOGIC II Music CT WIDTH	Pro Logic IIx Music and Pro Logic II Music center width. Moves the center channel output completely towards the center speaker or towards the front left and right speakers. A larger value moves the center channel output towards the front left and right speakers. Control range: 0 (center channel sound is output only from the center speaker) to 7 (center channel sound is output only from the front left and right speakers) Initial setting: 3
DTS Neo:6 Music C. IMAGE	DTS Neo:6 Music center image. Adjusts the front left and right channel output relative to the center channel to make the center channel more or less dominant as necessary. Control range: 0.0 to 1.0 Initial setting: 0.3



The “PRO LOGIC IIx Music”, “PRO LOGIC II Music”, and “DTS Neo:6 Music” parameters can be set only when “SUR. STANDARD” is selected. Press AMP and then press STANDARD on the remote control repeatedly to select “SUR. STANDARD” (see page 40).

Sound field program speaker layouts

Sound output from each speaker depends on the type of audio signals being input. Refer to the diagrams in the table below to understand the speaker layout for each sound field program.

Note

Be advised that there may be no or not enough sound output from speakers depending on the type of input source being played back. Furthermore, there may be some channels that can only be used partially when they are adjusted to specific aspects of movies, such as special sound effects, etc.

☀️
 Except for “2ch Stereo”, “6ch Stereo”, and “STRAIGHT”, you can select a decoder to output sound from the surround back speaker (see page 39).

The abbreviations and symbols used in each diagram are as follows:

- | | | | |
|---------------------------------------|--|--|---|
| <input checked="" type="checkbox"/> L | Front left speaker | <input checked="" type="checkbox"/> SL | Surround left speaker |
| <input checked="" type="checkbox"/> C | Center speaker | <input checked="" type="checkbox"/> SR | Surround right speaker |
| <input checked="" type="checkbox"/> R | Front right speaker | <input checked="" type="checkbox"/> SB | Surround back speaker |
| <input checked="" type="checkbox"/> | Speaker from which sound is being output | <input type="checkbox"/> | Speaker from which no sound is being output |

* When the EX / PL IIX / ES indicators are turned off in the front panel display

Sound field program	2-channel audio (monaural)	2-channel audio (stereo)	5.1/6.1-channel audio *
STEREO 2ch Stereo			
Monaural playback			
STEREO 6ch Stereo			
MUSIC Hall in Vienna The Bttm Line The Roxy Thtr ENTERTAINMENT Disco			

Sound field program	2-channel audio (monaural)	2-channel audio (stereo)	5.1/6.1-channel audio *
MUSIC Pop/Rock ENTERTAINMENT TV Sports Mono Movie Game			
MOVIE THEATER Spectacle Sci-Fi Adventure General			
SUR. STANDARD DOLBY DIGITAL PRO LOGIC DTS			
	Pro Logic	Pro Logic	
SUR. STANDARD PLII Movie PLII Music PLII Game PLIIx Movie PLIIx Music PLIIx Game			
	Movie / Game	Pro Logic II	
	Music	Pro Logic IIx	
SUR. STANDARD Neo:6 Cinema Neo:6 Music			
	Cinema	Cinema/Music	
	Music		

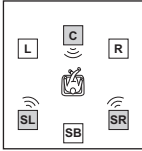
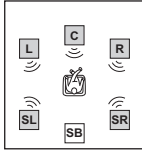
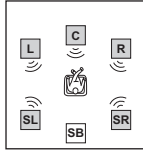
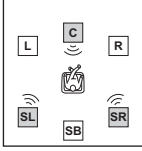
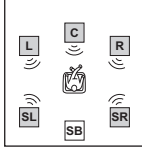
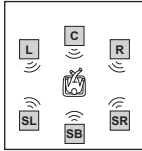
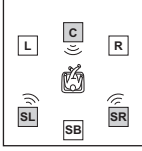
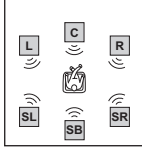
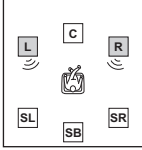
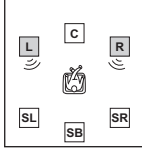
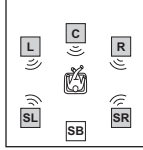
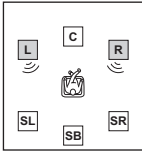
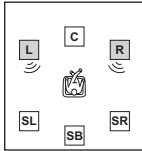
Sound field program	2-channel audio (monaural)	2-channel audio (stereo)	5.1/6.1-channel audio *
SUR. ENHANCED DOLBY DIGITAL PRO LOGIC DTS			
	Pro Logic	Pro Logic	
SUR. ENHANCED PLII Movie PLIIx Movie			
		Pro Logic II	
			
		Pro Logic IIx	
SUR. ENHANCED Neo:6 Cinema			
STRAIGHT			
	Monaural playback		
DIRECT STEREO			
	Monaural playback		

SET MENU

You can use the following parameters in “SET MENU” to adjust a variety of system settings and customize the way this unit operates. Change the initial settings (indicated in bold under each parameter) to reflect the needs of your listening environment.

■ BASIC SETUP BASIC SETUP

Use this feature to set up your system quickly and with minimal effort (see page 26).

■ MANUAL SETUP MANUAL SETUP

Use this feature to manually adjust speaker and system parameters.

Sound menu 1 SOUND MENU

Use this menu to manually adjust any speaker settings, alter the quality and tone of the sound output by the system or compensate for video signal processing delays when using LCD monitors or projectors.

Parameter	Features	Page
A)SPEAKER SET	Selects the size of each speaker, the speakers for low-frequency signal output, and the crossover frequency.	82
B)SP LEVEL	Adjusts the output level of each speaker.	83
C)SP DISTANCE	Adjusts the delay time of each speaker.	83
D)CENTER GEO	Adjusts the tonal quality of the center speaker.	84
E)LFE LEVEL	Adjusts the output level of the LFE channel for Dolby Digital or DTS signals.	84
F)D. RANGE	Adjusts the dynamic range of Dolby Digital or DTS signals.	84
G)AUDIO SET	Adjusts the muting level, audio delay and tone bypass settings.	84

Input menu 2 INPUT MENU

Use this menu to manually reassign the input jacks, select the input mode or rename the input source.

Parameter	Features	Page
A)INPUT ASSIGN	Assigns the input jacks of this unit according to the component to be used.	85
B)INPUT MODE	Selects the initial input mode of the source.	85
C)INPUT RENAME	Changes the name of the input source.	85
D)VOLUME TRIM	Adjusts the output volume of each jack.	86

DAB menu 3 DAB MENU

Use this menu to manually perform the DAB operations. For details, See “Using DAB MENU” on page 61.

Parameter	Features	Page
A) INIT SCAN	Locates all of the DAB ensembles and services in your area.	62
B) TUNE AID	Displays the strength of the current DAB signals.	63
C) DRC MODE	Compresses the dynamic range of the DAB broadcast.	63
D) PRUNE LIST	Deletes a group of inactive DAB ensembles and services from the DAB registry list.	64
E) PRESET DEL	Specifies and deletes unnecessary DAB services from the DAB registry list.	65

Option menu 4 OPTION MENU

Use this menu to manually adjust the optional system parameters.

Parameter	Features	Page
A) DISPLAY SET	Adjusts the brightness of the display.	87
B) MEMORY GUARD	Locks sound field program parameters and other “SET MENU” settings.	87
C) PARAM. INI	Initializes the parameters of a group of sound field programs.	87
D) MULTI ZONE	Specifies the location of the speakers connected to the SPEAKERS B terminals.	87

Using SET MENU

Use the remote control to access and adjust each parameter.

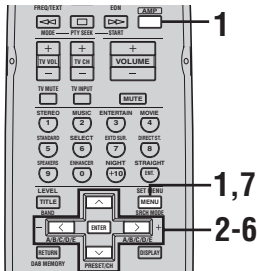

- You can change the “SET MENU” parameters while this unit is reproducing sound.
- If you press one of the sound field program selector buttons during the “SET MENU” operation, the “SET MENU” operation is canceled.
- Repeat the following procedure to select and adjust each parameter setting.
- To return to the previous menu level, press RETURN.

Note

You cannot change some “SET MENU” parameters when “NIGHT:CINEMA” or “NIGHT:MUSIC” is selected as the night listening mode (see page 31).

- 1 Press AMP and then press SET MENU to enter “SET MENU”.**

“BASIC SETUP” appears in the front panel display.



• BASIC SETUP

- 2 Press ^ / v to select “MANUAL SETUP” and then press ENTER.**

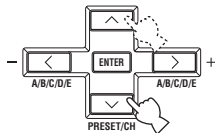

• MANUAL SETUP

- 3 Press ENTER to enter “MANUAL SETUP”.**
“1 SOUND MENU” appears in the front panel display.

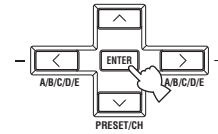

1 SOUND MENU

- 4 Press ^ / v repeatedly and then press ENTER to select and enter the desired menu.**

The following menus appear in the front panel display as you press ^ / v repeatedly.

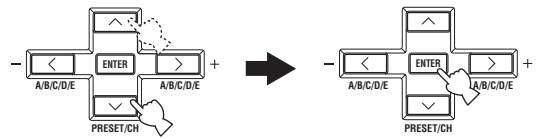

1 SOUND MENU
↓
2 INPUT MENU
↓
3 DAB MENU
↓
4 OPTION MENU

- 5 Press ^ / v repeatedly and then press ENTER to select and enter the desired submenu.**

Repeat step 5 and 6 to navigate to and enter the items you want to adjust.

To return to the previous menu level, press RETURN.

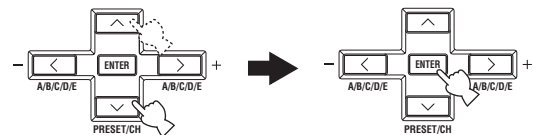

6 Press \wedge / \vee to select the desired parameter and then \langle / \rangle to change the parameter settings.

- Press \rangle to increase the value.
- Press \langle to decrease the value.

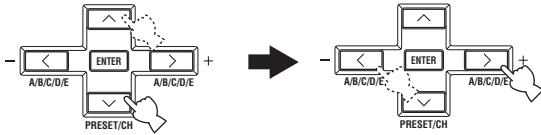

7 Press SET MENU to exit from “SET MENU”.



Memory back-up

The memory back-up circuit prevents the stored data from being lost even if this unit is in the standby mode. However, the stored data will be lost in case the power cable is disconnected from the AC wall outlet or if the power supply is cut off for more than one week.

1 SOUND MENU

Use this menu to manually adjust any speaker settings or compensate for video signal processing delays when using LCD monitors or projectors.

■ Speaker settings A)SPEAKER SET

Use this feature to manually adjust any speaker settings.



If you are not satisfied with the bass sounds from your speakers, you can change these settings according to your preference.

Front speakers FRONT

Choices: SMALL, **LARGE**

- Select “SMALL” (small) if you have small front speakers that do not reproduce low-frequency signals effectively. The low-frequency signals of the front left and right channels are directed to the speakers selected in BASS OUT.
- Select “LARGE” (large) if you have large front speakers that reproduce low-frequency signals effectively. All the front left and right channel signals are directed to the front left and right speakers.

Note

If “BASS OUT” is set to “FRNT” (see page 82), the LFE signals found in Dolby Digital or DTS sources, the low-frequency signals of the front left and right channels, and the low-frequency signals of other speakers set to “SML” or to “NONE” are all directed to the front left and right speakers regardless of the “FRONT” setting.

Center speaker CENTER

Choices: NONE, **SML**, LRG

- Select “NONE” (none) if you did not connect a center speaker. The center channel signals are directed to the front left and right speakers.
- Select “SML” (small) if you have a small center speaker that does not reproduce low-frequency signals effectively. The low-frequency signals of the center channel are directed to the speakers selected in “BASS OUT” (see page 82).
- Select “LRG” (large) if you have a large center speaker that reproduces low-frequency signals effectively. All the center channel signals are directed to the center speaker.

Surround left/right speakers SUR. LR

Choices: NONE, **SML**, LRG

- Select “NONE” (none) if you did not connect surround speakers. This unit is set to the Virtual CINEMA DSP mode (see page 41) and “SUR. B” is automatically set to “NONE” (see below).
- Select “SML” (small) if you have small surround left and right speakers that do not reproduce low-frequency signals effectively. The low-frequency signals of the surround left and right channels are directed to the speakers selected in “BASS OUT” (see page 82).
- Select “LRG” (large) if you have large surround left and right speakers that reproduce low-frequency signals effectively. All the surround channel signals are directed to the surround left and right speakers.

Surround back speakers SUR. B

Choices: NONE, **SML**, LRG

- Select “NONE” (none) if you did not connect a surround back speaker. The surround back channel signals are directed to the surround left and right speakers.
- Select “SML” (small) if you have a small surround back speaker that does not reproduce low-frequency signals effectively. The low-frequency signals of the surround back channel are directed to the speakers selected in “BASS OUT” (see page 82).
- Select “LRG” (large) if you have a large surround back speaker that reproduces low-frequency signals effectively. All the surround back channel signals are directed to the surround back speaker.

LFE/Bass out BASS OUT

Use this feature to select the speakers that output the LFE (low-frequency effect) and the low-frequency signals.

Choices: SWFR, FRNT, **BOTH**

- Select “SWFR” (subwoofer) if you connected a subwoofer. The LFE signals as well as the low-frequency signals of other speakers set to “SML” (or “SMALL”) are directed to the subwoofer.
- Select “FRNT” (front) if you did not connect a subwoofer. The LFE signals, the low-frequency signals of the front left and right channels, and the low-frequency signals of other speakers set to “SML” are all directed to the front left and right speakers regardless of the “FRONT” setting (see page 82).
- Select “BOTH” (both) if you connected a subwoofer. The low-frequency signals of any source are output from subwoofer. The LFE signals as well as the low-frequency signals of other speakers set to “SML” are directed to the subwoofer. The low-frequency signals of the front left and right channels are directed to the front left and right speakers and the subwoofer regardless of the “FRONT” setting (see page 82).

Crossover CROSSOVER

Use this feature to select a crossover frequency of all the speakers set to “SML” (or “SMALL”) or to “NONE” in “SPEAKER SET” (see page 82). All frequencies below the selected frequency will be sent to the subwoofer or to the speakers set to “LRG” (or “LARGE”) in “SPEAKER SET” (see page 82).

Choices: 40Hz, 60Hz, **80Hz**, 90Hz, 100Hz, 110Hz, 120Hz, 160Hz, 200Hz

Subwoofer phase SWFR PHASE

Use this feature to switch the phase of your subwoofer if bass sounds are lacking or unclear.

Choices: **NRM**, REV

- Select “NRM” if you do not want to reverse the phase of your subwoofer.
- Select “REV” to reverse the phase of your subwoofer.

Speaker level B) SP LEVEL

Use this feature to manually balance the speaker levels between the front left or surround left speakers and each speaker selected in “SPEAKER SET” (see page 82). The selected speaker outputs test tone and the speaker indicator of the speaker flashes.

Control range: -10.0 to +10.0 dB

Control step: 1.0 dB

Initial setting: 0 dB

The following is an example where “FL” is selected to adjust the balance of the front left speaker.

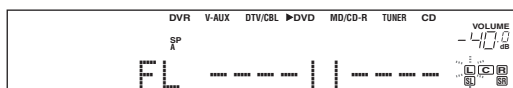

Flashes

- Select “FL” to adjust the balance of the front left speaker.
- Select “FR” to adjust the balance of the front right speaker.
- Select “C” to adjust the balance of the center speaker.
- Select “SL” to adjust the balance of the surround left speaker.
- Select “SR” to adjust the balance of the surround right speaker.
- Select “SB” to adjust the balance of the surround back speaker.
- Select “SWFR” to adjust the balance of the subwoofer.

Note

“C”, “SL”, “SR”, “SB” and “SWFR” cannot be adjusted if “CENTER” (see page 82), “SUR. LR” (see page 82), “SUR. B” (see page 82) and “BASS OUT” (see page 82) are set to “NONE” respectively.

Speaker distance C) SP DISTANCE

Use this feature to manually adjust the distance of each speaker and the delay applied to the respective channel. Ideally, each speaker should be the same distance from the main listening position. However, this is not possible in most home situations. Thus, a certain amount of delay must be applied to the sound from each speaker so that all sounds will arrive at the listening position at the same time.

Unit UNIT

Choices: **meters** (m), feet (ft)

- Select “meters” to adjust speaker distances in meters.
- Select “feet” to adjust speaker distances in feet.

Speaker distances

Control range: 0.30 to 24.00 m (1.0 to 80.0 ft)

Control step: 0.10 m (0.5 ft)

- Select “FRONT L” to adjust the distance of the front left speaker.
Initial setting: 3.00 m (10.0 ft)
- Select “FRONT R” to adjust the distance of the front right speaker.
Initial setting: 3.00 m (10.0 ft)
- Select “CENTER” to adjust the distance of the center speaker.
Initial setting: 3.00 m (10.0 ft)
- Select “SUR. L” to adjust the distance of the surround left speaker.
Initial setting: 3.00 m (10.0 ft)
- Select “SUR. R” to adjust the distance of the surround right speaker.
Initial setting: 3.00 m (10.0 ft)
- Select “SUR. B” to adjust the distance of the surround back speaker.
Initial setting: 2.10 m (7.0 ft)
- Select “SWFR” to adjust the distance of the subwoofer.
Initial setting: 3.00 m (10.0 ft)

Note

“CENTER”, “SUR. L”, “SUR. R”, “SUR. B” and “SWFR” cannot be adjusted if “CENTER” (see page 82), “SUR. LR” (see page 82), “SUR. B” (see page 82) and “BASS OUT” (see page 82) are set to “NONE” respectively.

■ Center graphic equalizer D)CENTER GEO

Use this feature to adjust the built-in 5-frequency band (100Hz, 300Hz, 1kHz, 3kHz and 10kHz) graphic equalizer for the center channel so that the tonal quality of the center speaker matches that of the front speakers. You can make adjustments while listening to the currently selected source component or a test tone.

Control range: -6 to +6 dB

Control step: 0.5 dB

Initial setting: 0 dB



Press \wedge / \vee to select a frequency band and \langle / \rangle to adjust the selected frequency band.

Following is an example where "100 Hz" is selected as the frequency band.

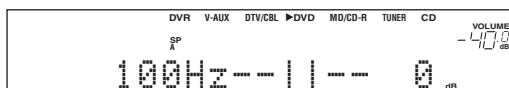

Test tone TEST

Choices: **OFF**, ON

- Select "OFF" to stop test tones and output the currently selected source component.
- Select "ON" to output test tones from the front left and center speakers, and adjust the tonal quality of the center speaker.

■ Low-frequency effect level E)LFE LEVEL

Use this feature to adjust the output level of the LFE (low-frequency effect) channel according to the capacity of your subwoofer or headphones. The LFE channel carries low-frequency special effects which are only added to certain scenes. This setting is effective only when this unit decodes Dolby Digital or DTS signals.

Control range: -20 to 0 dB

Control step: 1 dB

Speaker SP LFE

Adjusts the speaker LFE level.

Headphone HP LFE

Adjusts the headphone LFE level.

Note

Depending on the settings of "BASS OUT" (see page 82), some signals may not be output at the SUBWOOFER OUTPUT jack.

■ Dynamic range F)D. RANGE

Use this feature to select the amount of dynamic range compression to be applied to your speakers or headphones. This setting is effective only when this unit is decoding Dolby Digital and DTS signals.

Speaker SP D.R

Adjusts the speaker compression.

Headphone HP D.R

Adjusts the headphone compression.

Choices: MIN, STD, **MAX**

- Select "MIN" (minimum) if you regularly listen at low volume levels.
- Select "STD" (standard) for general use.
- Select "MAX" (maximum) to preserve the greatest amount of dynamic range.

■ Audio settings G)AUDIO SET

Use this feature to adjust the overall audio settings of this unit.

Muting type MUTE TYP.

Use this feature to adjust how much the mute function reduces the output volume (see page 31).

Choices: **FULL**, -20dB

- Select "FULL" to completely mute all the audio output.
- Select "-20dB" to reduce the current volume by 20 dB.

Audio delay A.DELAY

Use this feature to delay the sound output and synchronize it with the video image. This may be necessary when using certain LCD monitors or projectors.

Control range: 0 to 160 ms

Control step: 1 ms

Tone bypass TC.BYPASS

Use this feature to select whether audio output bypasses tone control circuitry when "TREBLE" and "BASS" are set to 0 dB (see page 30).

Choices: **AUTO**, OFF

- Select "AUTO" if you want signals to bypass tone control circuitry to provide the purest signal possible.
- Select "OFF" if you do not want signals to bypass tone control circuitry.

2 INPUT MENU

Use this menu to reassign the input jacks, select the input mode or rename the input source.

■ Input assignment

A) INPUT ASSIGN

Use this feature to assign the input jacks according to the component to be used if the initial settings of this unit do not correspond to your needs. Change the following parameters to reassign the respective jacks and effectively connect more components.

Once the input jacks are reassigned, you can select the corresponding component by using the INPUT selector on the front panel (or the input selector buttons on the remote control).

For COMPONENT VIDEO jacks A, B and C

C.V[A]
C.V[B]
C.V[C]

Choices: [A] **DVD**, DTV/CBL, V-AUX, DVR
[B] DVD, **DTV/CBL**, V-AUX, DVR
[C] DVD, DTV/CBL, V-AUX, **DVR**

For OPTICAL INPUT jacks 1 and 2

IN (1)
IN (2)

Choices: (1) CD, MD/CD-R, **DVD**, DTV/CBL, V-AUX, DVR
(2) CD, MD/CD-R, DVD, **DTV/CBL**, V-AUX, DVR

For COAXIAL INPUT jack 3 COAXIAL IN (3)

Choices: (3) CD, MD/CD-R, **DVD**, DTV/CBL, V-AUX, DVR

Notes

- You cannot select a specific item more than once for the same type of jack.
- When you connect a component to both the DIGITAL INPUT (COAXIAL) and DIGITAL INPUT (OPTICAL) jacks, priority is given to the signals input at the DIGITAL INPUT (COAXIAL) jack.

■ Input mode B) INPUT MODE

Use this feature to set this unit to reset "INPUT MODE" back to "AUTO" (see page 32) regardless of the previous setting or to recall the last input mode ("AUTO", "DTS", or "ANALOG") used for that source whenever you turn on this unit.

Choices: **AUTO**, LAST

- Select "AUTO" to reset "INPUT MODE" back to "AUTO" (see page 32) regardless of the previous setting whenever you turn on this unit. This unit automatically selects input signals in the following order:
 - Digital signals
 - Analog signals
- Select "LAST" to set this unit to automatically recall the last input mode ("AUTO", "DTS", or "ANALOG") used for that source whenever you turn on this unit.

■ Input rename C) INPUT RENAME

Use this feature to change the name of the input source that appears in the front panel display.

The following is an example where "DVD" is renamed "My DVD".

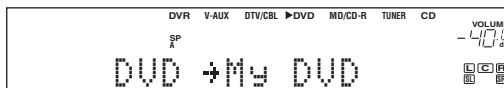

- Press one of the input selector buttons on the remote control to select the input source you want to change the name of.

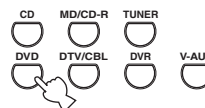

- Press AMP and then press </> on the remote control to place the "_" (underscore) under the space or the character you want to edit.

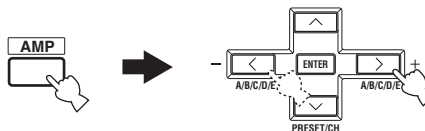

- 3 Press ^/∨ to select the character you want to use and then press </> to move to the next space.**

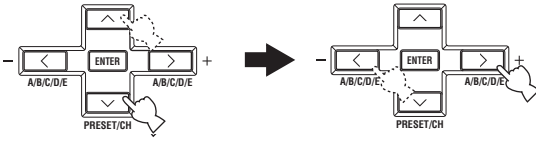

Notes

- You can use up to 8 characters for each input.
- Press ∨ to change the character in the following order, or press ^ to go in the reverse order:
A to Z, a space, 0 to 9, a space, a to z, a space, symbols (#, *, -, +, etc.)

- 4 Repeat steps 1 through 3 to rename each input source.**

- 5 Press SET MENU on the remote control to exit from “INPUT RENAME”.**



■ Volume Trim D) VOLUME TRIM

Use this feature to adjust the level of the signal input at each jack. This is useful if you want to balance the level of each input source to avoid sudden changes in volume when switching between input sources.

Choices: CD, MD/CD-R, TUNER, DVD, DTV/CBL, V-AUX, DVR, MULTI CH IN

Control range: -6.0 to 6.0 dB

Control step: 1.0 dB

Initial setting: 0.0 dB

3 DAB MENU

Use this menu to perform the DAB operations as well as the DAB ensemble/service registry list. See page 61 for details about this menu.

- **Initial scan** A) INIT SCAN
See page 62 for details.
- **Tuning aid** B) TUNE AID
See page 63 for details.
- **DRC mode** C) DRC MODE
See page 63 for details.
- **Prune list** D) PRUNE LIST
See page 64 for details.
- **Preset delete** E) PRESET DEL
See page 65 for details.

4 OPTION MENU

Use this menu to adjust the optional system parameters.

■ Display settings A)DISPLAY SET

Dimmer DIMMER

Use this feature to adjust the brightness of the front panel display.

Control range: -4 to 0

Control step: 1

- Press < to make the front panel display dimmer.
- Press > to make the front panel display brighter.

■ Memory guard B)MEMORY GUARD

Use this feature to prevent accidental changes to DSP program parameter values and other system settings.

Choices: OFF, ON

- Select "OFF" to turn off the "MEMORY GUARD" feature.
- Select "ON" to protect:
 - DSP program parameters
 - All "SET MENU" items
 - All speaker levels

Note

When "MEMORY GUARD" is set to "ON", you cannot select and adjust any other "SET MENU" items.

■ Parameter initialization C)PARAM. INI

Use this feature to initialize the parameters of each sound field program within a sound field program group. When you initialize a sound field program group, all of the parameter values within that group revert to their initial factory settings.

Press the corresponding sound field program selector buttons on the remote control to select the sound field program that you want to initialize.

Choices: STEREO, MUSIC, ENTERTAINMENT, MOVIE THEATER, STANDARD

Notes

- You cannot automatically revert to the previous parameter settings once you initialize a sound field program group.
- You cannot separately initialize individual sound field programs.
- You cannot initialize any sound field program groups when "MEMORY GUARD" is set to "ON".

■ Zone set D)MULTI ZONE

Use this feature to specify the location of speakers connected to the SPEAKERS B terminals of this unit.

Speaker B setting SP B

Use this feature to select the location of the front speakers connected to the SPEAKERS B terminals.

Choices: FRONT, ZONE B

- Select "FRONT" to turn on or off SPEAKERS A and B when the speakers connected to the SPEAKERS B terminals are set in the main zone.
- Select "ZONE B" if the speakers connected to the SPEAKERS B terminals are set in another zone. If SPEAKERS A is turned off and SPEAKERS B is turned on, all the speakers in the main zone are muted and this unit outputs sound at the SPEAKERS B terminals only.

Notes

- If you connect headphones to the PHONES jack of this unit, the sound is output from both headphones and the SPEAKERS B terminals when "SP B" is set to "ZONE B".
- If a DSP program is selected when "SP B" is set to "ZONE B", this unit automatically enters the Virtual CINEMA DSP mode (see page 41).

ADVANCED SETUP

This unit has additional menus that are displayed in the front panel display. The advanced setup menu offers additional operations to adjust and customize the way this unit operates. Change the initial settings (indicated in bold under each parameter) to reflect the needs of your listening environment.

Notes

- The settings you make are reflected next time you turn on this unit by pressing **STANDBY/ON** on the front panel (or **POWER** on the remote control) to turn on this unit (see page 25).
- Only **STANDBY/ON**, **STRAIGHT (EFFECT)** and the **PROGRAM** </> buttons are effective while you are using the advanced setup menu.
- All the other operations cannot be made while you are using the advanced setup menu.
- The advanced setup menu is only available in the front panel display.

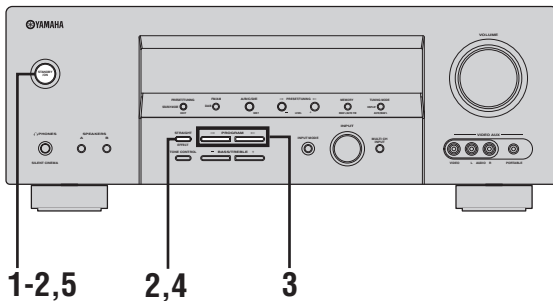

- 1 Press **STANDBY/ON** on the front panel to set this unit to the standby mode.**



- 2 Press and hold **STRAIGHT (EFFECT)** on the front panel and then press **STANDBY/ON** to turn on this unit.**

This unit turns on, and the advanced setup menu appears in the front panel display.

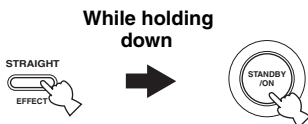

- 3 Press the **PROGRAM** </> buttons on the front panel repeatedly to select the parameter you want to adjust.**

The name of the selected parameter appears in the front panel display.

See page 89 for a complete list of available parameters.



Currently selected parameter

Currently selected parameter setting

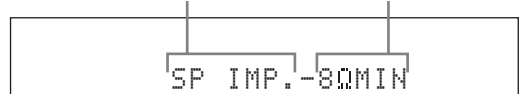

- 4 Press **STRAIGHT (EFFECT)** on the front panel repeatedly to change the selected parameter setting.**



- 5 Press **STANDBY/ON** on the front panel to save the new setting and set this unit to the standby mode.**



The settings you made are reflected next time you turn on this unit.

■ **Speaker impedance** SP IMP.

Use this feature to set the speaker impedance of this unit so that it matches that of your speakers.

Choices: **8ΩMIN**, **6ΩMIN**

- Select “8ΩMIN” to set the speaker impedance to 8 Ω.
- Select “6ΩMIN” to set the speaker impedance to 6 Ω.

SP IMP.	Speaker	Impedance level
8ΩMIN	Front	If you use one set (A or B), the impedance of each speaker must be 8 Ω or higher. <hr/> If you use two sets (A and B), the impedance of each speaker must be 16 Ω or higher.*
	Center	
	Surround	The impedance of each speaker must be 8 Ω or higher.
	Surround back	
6ΩMIN	Front	If you use one set (A or B), the impedance of each speaker must be 4 Ω or higher. <hr/> If you use two sets (A and B), the impedance of each speaker must be 8 Ω or higher.
	Center	
	Surround	The impedance of each speaker must be 6 Ω or higher.
	Surround back	

■ **Factory presets** PRESET

Use this feature to reset all the parameters of this unit to the initial factory settings (see page 93).

Choices: **CANCEL**, **RESET**

- Select “CANCEL” not to reset any parameters of this unit.
- Select “RESET” to reset the parameters of this unit.

Notes

- This setting completely resets all the parameters of this unit including the “SET MENU” parameters. However, the advanced setup menu parameters will not be initialized.
- The initial factory settings are activated next time you turn on this unit.

REMOTE CONTROL FEATURES

In addition to controlling this unit, the remote control can also operate other audiovisual components made by YAMAHA and other manufacturers. To control your TV or other components, you must set the appropriate remote control code for each input source (see page 92).

Controlling this unit, a TV, or other components

■ Controlling this unit

Press AMP to control this unit.

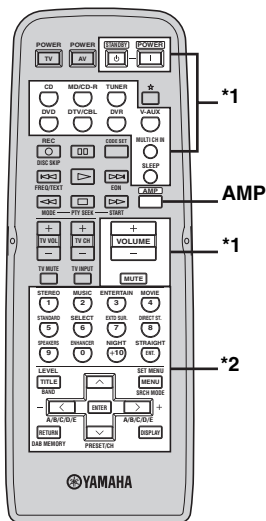

■ Controlling a TV

Press DTV/CBL to control your TV. To control your TV, you must set the appropriate remote control code for DTV/CBL (see page 92).

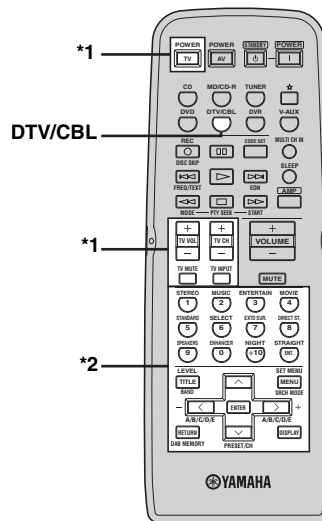

Notes

- *1 These buttons always control this unit.
- *2 These buttons control this unit only when AMP is pressed.

Notes

- *1 These buttons always control your TV.

Remote control	Digital TV/Cable TV
TV POWER	Turns on or off the power.
TV VOL +/-	Increases or decreases the volume level.
TV CH +/-	Changes the channel number.
TV MUTE	Mutes the audio output.
TV INPUT	Changes the input source.

*2 These buttons control your TV only when DTV/CBL is pressed. For details, see the "Digital TV/ Cable TV" column on page 91.

■ Controlling other components

Once you set the appropriate remote control codes (see page 92), use the input selector buttons and ☆ to select the component you want to control. Note that some buttons may not correctly operate the selected component.

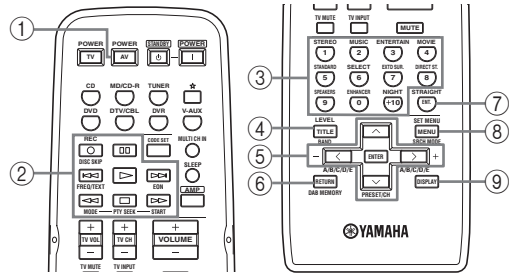

Remote control	DVD player	VCR	Digital TV/ Cable TV	CD player	MD/CD recorder	Tuner
① AV POWER	Power *1	Power *1	VCR power *2	Power *1	Power *1	Power *1
② REC/ DISC SKIP	O	Rec *3	VCR rec *2,3	Disc Skip	Rec (MD)	
▷	Play	Play	VCR play *2	Play	Play	
◀◀	Search backward	Search backward	VCR search backward *2	Search backward	Search backward	
▶▶	Search forward	Search forward	VCR search forward *2	Search forward	Search forward	
⏸	Pause	Pause	VCR pause *2	Pause	Pause	
◀◀◀	Skip backward			Skip backward	Skip backward	
▶▶▶	Skip forward			Skip forward	Skip forward	
◻	Stop	Stop	VCR stop *2	Stop	Stop	
③ 0-9, +10	Numeric buttons	Numeric buttons	Numeric buttons	Numeric buttons	Numeric buttons	Preset stations (1-8)
④ TITLE	Title					Band
⑤ PRESET/CH ^	Up	VCR channel up				Preset up (1-8)
PRESET/CH v	Down	VCR channel down				Preset down (1-8)
A-E/CAT. <	Left					Preset down (A-E)
A-E/CAT. >	Right					Preset up (A-E)
ENTER	Select					
⑥ RETURN	Return					
⑦ ENT.	Title/Index	Enter	Enter	Index	Index	
⑧ MENU	Menu					
⑨ DISPLAY	Display		Display	Display	Display	

Notes

*1 This button functions only when the original remote control of the component has a POWER button.

*2 These buttons can operate your VCR when the remote control code of your VCR is set in DVR and DTV/CBL is selected.

*3 When you use this button to record a source, press it twice repeatedly to prevent a malfunction.

Setting remote control codes

You can control other components by setting the appropriate remote control codes. You can set the remote control codes for each input source. For a complete list of available remote control codes, refer to “LIST OF REMOTE CONTROL CODES” at the end of this manual.

The following table shows the default component (Library: component category) and the remote control code for each input source.

Remote Control Code Default Settings

Input source	Library (component category)	Manufacturer	Default code
CD	CD	YAMAHA	199
MD/CD-R	CD-R	YAMAHA	499
DVD	DVD	YAMAHA	699
TUNER *1	TUNER	YAMAHA	Fixed
DTV/CBL *2	-	-	-
DVR	-	-	-
V-AUX	-	-	-
☆	-	-	-

*1 You can control this unit only.

*2 You can only set TV remote control codes in DTV/CBL.

Note

You may not be able to operate your YAMAHA component even if a YAMAHA remote control code is initially set as listed above. In this case, try setting other YAMAHA remote control codes.

- 1 While holding down CODE SET, press one of the input selector button or ☆ to select the component you want to set up.

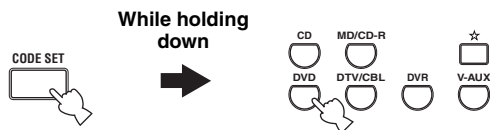

Note

You need hold to down CODE SET throughout this procedure.

- 2 While holding down CODE SET, press the numeric buttons (0 to 9) to enter the three-digit remote control code for the component to be used.

When the setting succeeds, “PRESET OK” appears; however, when it does not, “PRESET NG” appears in the front panel display. Refer to “LIST OF REMOTE CONTROL CODES” at the end of this manual.

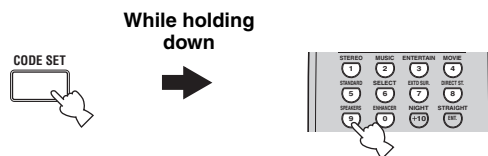

Notes

- If the manufacturer of your component has more than one code, try each of them until you find the correct one.
- You can only assign one remote control code to each input selector button.

RESETTING THE SYSTEM

Use this feature to reset all the parameters of this unit to the initial factory settings.

Notes

- This procedure completely resets all the parameters of this unit including the “SET MENU” parameters. However, the advanced setup menu parameters will not be initialized.
- The initial factory settings are activated next time you turn on this unit.



To cancel the initialization procedure at any time without making any changes, press **STANDBY/ON** on the front panel (or **STANDBY** on the remote control) to set this unit to the standby mode.

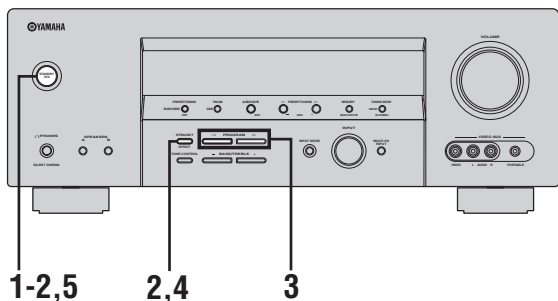

- 1 Press **STANDBY/ON** on the front panel to set this unit to the standby mode.**



- 2 Press and hold **STRAIGHT (EFFECT)** on the front panel and then press **STANDBY/ON** to turn on this unit.**

This unit turns on, and the advanced setup menu appears in the front panel display.



- 3 Press the **PROGRAM** </> buttons on the front panel to select “PRESET”.**



PRESET-CANCEL

- 4 Press **STRAIGHT (EFFECT)** on the front panel repeatedly to select “RESET”.**



PRESET-RESET



Select “CANCEL” to cancel the initialization procedure without making any changes.

- 5 Press **STANDBY/ON** on the front panel to confirm your selection and set this unit to the standby mode.**



TROUBLESHOOTING

Refer to the table below when this unit does not function properly. If the problem you are experiencing is not listed below or if the instruction below does not help, set this unit to the standby mode, disconnect the power cable, and contact the nearest authorized YAMAHA dealer or service center.

■ General

Problem	Cause	Remedy	See page
This unit fails to turn on or enters the standby mode soon after the power is turned on.	The power cable is not connected or the plug is not completely inserted.	Connect the power cable firmly.	—
	The speaker impedance setting is incorrect.	Set the speaker impedance to match your speakers.	24
	The protection circuitry has been activated.	Make sure that all speaker wire connections on this unit and on all speakers are secure and that the wire for each connection does not touch anything other than its respective connection.	12
	This unit has been exposed to a strong external electric shock (such as lightning or strong static electricity).	Set this unit to the standby mode, disconnect the power cable, plug it back in after 30 seconds and then use it normally.	—
No sound	Incorrect input or output cable connections.	Connect the cables properly. If the problem persists, the cables may be defective.	16–23
	“INPUT MODE” is set to “DTS” or “ANALOG”.	Set “INPUT MODE” to “AUTO”.	32
	No appropriate input source has been selected.	Select an appropriate input source with the INPUT selector on the front panel (or the input selector buttons on the remote control) and MULTI CH INPUT on the front panel (or MULTI CH IN on the remote control).	29, 36
	Speaker connections are not secure.	Secure the connections.	12
	The front speakers to be used have not been selected properly.	Select the set of front speakers with SPEAKERS A/B and/or B on the front panel or SPEAKERS on the remote control.	29
	The volume is turned down.	Turn up the volume.	—
	The sound is muted.	Press MUTE or VOLUME +/- on the remote control to resume audio output and then adjust the volume.	31
	“INPUT MODE” is set to “ANALOG” while playing a source encoded in DTS.	Set “INPUT MODE” to “AUTO” or “DTS”.	32
Signals this unit cannot reproduce are being input from a source component, such as a CD-ROM.	Play a source whose signals can be reproduced by this unit.	—	
No picture	The output and input for the picture are connected to different types of video jacks.	Connect your video source components in the same way as you connect your video monitor to this unit.	17

Problem	Cause	Remedy	See page
The sound suddenly goes off.	The protection circuitry has been activated because of a short circuit, etc.	Check that the speaker impedance setting is correct.	24
		Check that the speaker wires are not touching each other and then turn this unit back on.	—
	The sleep timer has turned off this unit.	Turn on this unit, and play the source again.	—
	The sound is muted.	Press MUTE or VOLUME +/- on the remote control to resume audio output.	31
Sound is heard from the speaker on one side only.	Incorrect cable connections.	Connect the cables properly. If the problem persists, the cables may be defective.	16–23
	Incorrect settings in “SPEAKER LEVEL”.	Adjust the “SPEAKER LEVEL” settings.	83
Only the center speaker outputs substantial sound.	When playing a monaural source with a CINEMA DSP program, the source signal is directed to the center channel, and the front and surround speakers output effect sounds.		
No sound is heard from the center speaker.	“CENTER” in “SET MENU” is set to “NONE”.	Set “CENTER” to “SML” or “LRG”.	82
	One of the HiFi DSP programs (except for 6ch Stereo) has been selected.	Try another sound field program.	66
No sound is heard from the surround speakers.	“SUR. LR” in “SET MENU” is set to “NONE”.	Set “SUR. LR” to “SML” or “LRG”.	82
	This unit is in the “STRAIGHT” mode and a monaural source is being played back.	Press STRAIGHT (EFFECT) on the front panel so that “STRAIGHT” disappears from the front panel display.	36
No sound is heard from the surround back speaker.	“SUR. LR” in “SET MENU” is set to “NONE” and “SUR. B” is automatically set to “NONE”.	Set “SUR. LR” and “SUR. B” to “SML” or “LRG”.	82
	“SUR. B” in “SET MENU” is set to “NONE”.	Set “SUR. B” to “SML” or “LRG”.	82
No sound is heard from the subwoofer.	“BASS OUT” in “SET MENU” is set to “FRNT” when a Dolby Digital or DTS signal is being played.	Set “BASS OUT” to “SWFR” or “BOTH”.	82
	“BASS OUT” in “SET MENU” is set to “SWFR” or “FRNT” when a 2-channel source is being played.	Set “BASS OUT” to “BOTH”.	82
	The source does not contain low-frequency bass signals.		

Problem	Cause	Remedy	See page
Dolby Digital or DTS sources cannot be played. (Dolby Digital or DTS indicator in the front panel display does not light up.)	The connected component is not set to output Dolby Digital or DTS digital signals.	Make an appropriate setting following the operating instructions for your component.	—
	“INPUT MODE” is set to “ANALOG”.	Set “INPUT MODE” to “AUTO” or “DTS”.	32
A humming sound is heard.	Incorrect cable connections.	Connect the audio cables firmly. If the problem persists, the cables may be defective.	—
The volume level cannot be increased, or the sound is distorted.	The component connected to the AUDIO OUT (REC) jacks of this unit is turned off.	Turn on the power of the component.	—
The sound effect cannot be recorded.	It is not possible to record the sound effect with a recording component.		
A source cannot be recorded by an analog component connected to the AUDIO OUT (REC) jacks.	The source component is not connected to the analog AUDIO IN jacks of this unit.	Connect the source component to the analog AUDIO IN jacks.	17–19
The sound field parameters and some other settings of this unit cannot be changed.	“MEMORY GUARD” in “SET MENU” is set to “ON”.	Set “MEMORY GUARD” to “OFF”.	87
This unit does not operate properly.	The internal microcomputer has been frozen by an external electric shock (such as lightning or excessive static electricity) or by a power supply with low voltage.	Disconnect the power cable from the AC wall outlet and then plug it in again after about 30 seconds.	—
“CHECK SP WIRES” appears in the front panel display.	Speaker cables are short-circuited.	Make sure all speaker cables are connected correctly.	12
There is noise interference from digital or radio frequency equipment.	This unit is too close to the digital or high-frequency equipment.	Move this unit further away from such equipment.	—
The picture is disturbed.	The video source uses scrambled or encoded signals to prevent dubbing.		
This unit suddenly enters the standby mode.	The internal temperature becomes too high and the overheat protection circuitry has been activated.	Wait about 1 hour for this unit to cool down and then turn it back on.	—

■ Tuner

	Problem	Cause	Remedy	See page	
FM	FM stereo reception is noisy.	The characteristics of FM stereo broadcasts may cause this problem when the transmitter is too far away or the antenna input is poor.	Check the antenna connections.	21	
			Try using a high-quality directional FM antenna.	—	
			Use the manual tuning method.	44	
	There is distortion, and clear reception cannot be obtained even with a good FM antenna.	There is multi-path interference.	Adjust the antenna position to eliminate multi-path interference.	—	
The desired station cannot be tuned into with the automatic tuning method.	The signal is too weak.	Use a high-quality directional FM antenna.	—		
		Use the manual tuning method.	44		
Previously preset stations can no longer be tuned into.	This unit has been disconnected for a long period.	Set preset stations.	45, 46		
AM	The desired station cannot be tuned into with the automatic tuning method.	The signal is weak or the antenna connections are loose.	Tighten the AM loop antenna connections and orient it for the best reception.	—	
			Use the manual tuning method.	44	
	There are continuous crackling and hissing noises.	Noises result from lightning, fluorescent lamps, motors, thermostats and other electrical equipment.	Use an outdoor antenna and a ground wire. This will help somewhat, but it is difficult to eliminate all noise.	—	
There are buzzing and whining noises.	A TV set is being used nearby.	Move this unit away from the TV set.	—		
DAB	Cannot tune into any DAB services.	The initial scan operations were not performed, or the DAB registry list needs to be updated.	Perform the initial scan operations.	62	
			There is no DAB coverage in your area.	Check with your dealer or WorldDAB online at " http://www.worlddab.org " for a listing of the DAB coverage in your area.	—
			The DAB signals are too weak.	Use a high-quality outdoor DAB antenna.	—
	The initial scan operations are not successful and "Not Available" appears in the front panel display.	The DAB antenna may not be connected.	Make sure the DAB antenna is firmly connected.	22	
			The DAB signals are too weak.	Use a high-quality outdoor DAB antenna.	—
			There is no DAB coverage in your area.	Check with your dealer or WorldDAB online at " http://www.worlddab.org " for a listing of the DAB coverage in your area.	—
	The DAB service reception is weak.	The positioning of the indoor DAB antenna and/or this unit is not optimal for DAB reception.	Use the tuning aid feature to locate the best positioning of the DAB antenna and this unit for optimal DAB reception.	63	
			The DAB signals are too weak.	Use a high-quality outdoor DAB antenna.	—
	There is noise interference (e.g. hiss or crackle).	The indoor DAB antenna needs to be repositioned.	Readjust the position of the indoor DAB antenna.	—	
			The DAB signals are too weak.	Use a high-quality outdoor DAB antenna.	—
The DAB service information does not appear or is inaccurate.	The DAB service may be temporarily out of service, or the DAB service information is not provided by the DAB broadcaster.	Contact the DAB broadcaster.	—		

■ Remote control

Problem	Cause	Remedy	See page	
The remote control does not work nor function properly.	Wrong distance or angle.	The remote control functions within a maximum range of 6 m and no more than 30 degrees off-axis from the front panel.	7	
	Direct sunlight or lighting (from an inverter type of fluorescent lamp, etc.) is striking the remote control sensor of this unit.	Reposition this unit.	—	
	The batteries are weak.	Replace all batteries.	3	
	The remote control code is not correctly set.	Set the remote control code correctly using “LIST OF REMOTE CONTROL CODES” at the end of this manual.		92
		Try setting another code for the same manufacturer using “LIST OF REMOTE CONTROL CODES” at the end of this manual.		92
Even if the remote control code is correctly set, there are some models that do not respond to the remote control.				

Audio information

■ Dolby Digital

Dolby Digital is a digital surround sound system that gives you completely independent multi-channel audio. With 3 front channels (front L/R and center), and 2 surround stereo channels, Dolby Digital provides 5 full-range audio channels. With an additional channel especially for bass effects, called LFE (Low Frequency Effect), the system has a total of 5.1-channels (LFE is counted as 0.1 channel). By using 2-channel stereo for the surround speakers, more accurate moving sound effects and surround sound environment are possible than with Dolby Surround. The wide dynamic range from maximum to minimum volume reproduced by the 5 full-range channels and the precise sound orientation generated using digital sound processing provide listeners with unprecedented excitement and realism. With this unit, any sound environment from monaural up to a 5.1-channel configuration can be freely selected for your enjoyment.

■ Dolby Digital EX

Dolby Digital EX creates 6 full-bandwidth output channels from 5.1-channel sources. This is done using a matrix decoder that derives 3 surround channels from the 2 in the original recording. For the best results, Dolby Digital EX should be used with movie sound tracks recorded with Dolby Digital Surround EX. With this additional channel, you can experience more dynamic and realistic moving sound especially with scenes with “fly-over” and “fly-around” effects.

■ Dolby Pro Logic II

Dolby Pro Logic II is an improved technique used to decode vast numbers of existing Dolby Surround sources. This new technology enables a discrete 5-channel playback with 2 front left and right channels, 1 center channel, and 2 surround left and right channels instead of only 1 surround channel for conventional Pro Logic technology. There are three modes available: “Music mode” for music sources, “Movie mode” for movie sources and “Game mode” for game sources.

■ Dolby Pro Logic IIx

Dolby Pro Logic IIx is a new technology enabling discrete multi-channel playback from 2-channel or multi-channel sources. There are three modes available: “Music mode” for music sources, “Movie mode” for movie sources (for 2-channel sources only) and “Game mode” for game sources.

■ Dolby Surround

Dolby Surround uses a 4-channel analog recording system to reproduce realistic and dynamic sound effects: 2 front left and right channels (stereo), a center channel for dialog (monaural), and a surround channel for special sound effects (monaural). The surround channel reproduces sound within a narrow frequency range. Dolby Surround is widely used with nearly all video tapes and laser discs, and in many TV and cable broadcasts as well. The Dolby Pro Logic decoder built into this unit employs a digital signal processing system that automatically stabilizes the volume on each channel to enhance moving sound effects and directionality.

■ DTS 96/24

DTS 96/24 offers an unprecedented level of audio quality for multi-channel sound on DVD video, and is fully backward-compatible with all DTS decoders. “96” refers to a 96 kHz sampling rate compared to the typical 48 kHz sampling rate. “24” refers to 24-bit word length. DTS 96/24 offers sound quality transparent to the original 96/24 master, and 96/24 5.1-channel sound with full-quality full-motion video for music programs and motion picture soundtracks on DVD video.

■ DTS (Digital Theater Systems) Digital Surround

DTS digital surround was developed to replace the analog soundtracks of movies with a 6.1-channel digital sound track, and is now rapidly gaining popularity in movie theaters around the world. Digital Theater Systems Inc. has developed a home theater system so that you can enjoy the depth of sound and natural spatial representation of DTS digital surround in your home. This system produces practically distortion-free 6.1-channel sound (technically, front left and right, center, surround left and right and LFE 0.1 (subwoofer) channels for a total of 5.1 channels). This unit incorporates a DTS-ES decoder that enables 6.1-channel reproduction by adding the surround back channel to the existing 5.1-channel format.

■ ITU-R

ITU-R is the radio communication sector of the ITU (International Telecommunication Union). ITU-R recommends a standard speaker placement which is used in many critical listening rooms, especially for mastering purposes.

■ LFE 0.1 channel

This channel reproduces low-frequency signals. The frequency range of this channel is from 20 Hz to 120 Hz. This channel is counted as 0.1 because it only enforces a low-frequency range compared to the full-range reproduced by the other 5/6 channels in Dolby Digital or DTS 5.1/6.1-channel systems.

■ Neo:6

Neo:6 decodes the conventional 2-channel sources for 6-channel playback by the specific decoder. It enables playback with the full-range channels with higher separation just like digital discrete signal playback. There are two modes available: "Music mode" for music sources and "Cinema mode" for movie sources.

■ PCM (Linear PCM)

Linear PCM is a signal format under which an analog audio signal is digitized, recorded and transmitted without using any compression. This is used as a method of recording CDs and DVD audio. The PCM system uses a technique for sampling the size of the analog signal per very small unit of time. Standing for "Pulse Code Modulation", the analog signal is encoded as pulses and then modulated for recording.

■ Sampling frequency and number of quantized bits

When digitizing an analog audio signal, the number of times the signal is sampled per second is called the sampling frequency, while the degree of fineness when converting the sound level into a numeric value is called the number of quantized bits. The range of rates that can be played back is determined based on the sampling rate, while the dynamic range representing the sound level difference is determined by the number of quantized bits. In principle, the higher the sampling frequency, the wider the range of frequencies that can be played back, and the higher the number of quantized bits, the more finely the sound level can be reproduced.

Video information

■ Component video signal

With the component video signal system, the video signal is separated into the Y signal for the luminance and the Pb and Pr signals for the chrominance. Color can be reproduced more faithfully with this system because each of these signals is independent. The component signal is also called the “color difference signal” because the luminance signal is subtracted from the color signal. A monitor with component input jacks is required in order to output component signals.

■ Composite video signal

With the composite video signal system, the video signal is composed of three basic elements of a video picture: color, brightness and synchronization data. A composite video jack on a video component transmits these three elements combined.

■ S-video signal

With the S-video signal system, the video signal normally transmitted using a pin cable is separated and transmitted as the Y signal for the luminance and the C signal for the chrominance through the S-video cable. Using the S VIDEO jack eliminates video signal transmission loss and allows recording and playback of even more beautiful images.

Sound field program information

■ CINEMA DSP

Since the Dolby Surround and DTS systems were originally designed for use in movie theaters, their effect is best felt in a theater having many speakers designed for acoustic effects. Since home conditions, such as room size, wall material, number of speakers, and so on, can differ so widely, it is inevitable that there are differences in the sound heard. Based on a wealth of actually measured data, YAMAHA CINEMA DSP uses YAMAHA original sound field technology to combine Dolby Pro Logic, Dolby Digital and DTS systems to provide the audiovisual experience of movie theater in the listening room of your own home.

■ SILENT CINEMA

YAMAHA has developed a natural, realistic sound effect DSP algorithm for headphones. Parameters for headphones have been set for each sound field so that accurate representations of all the sound field programs can be enjoyed on headphones.

■ Virtual CINEMA DSP

YAMAHA has developed a Virtual CINEMA DSP algorithm that allows you to enjoy DSP sound field surround effects even without any surround speakers by using virtual surround speakers. It is even possible to enjoy Virtual CINEMA DSP using a minimal two-speaker system that does not include a center speaker.

DAB frequency information

■ Band III

Note

When you select "UK BAND3" in the initial scan operation, this unit scans only within the frequencies marked with an asterisk (*) in the following table (see page 62).

Frequency	Channel label
174.928 MHz	5A
176.640 MHz	5B
178.352 MHz	5C
180.064 MHz	5D
181.936 MHz	6A
183.648 MHz	6B
185.360 MHz	6C
187.072 MHz	6D
188.928 MHz	7A
190.640 MHz	7B
192.352 MHz	7C
194.064 MHz	7D
195.936 MHz	8A
197.648 MHz	8B
199.360 MHz	8C
201.072 MHz	8D
202.928 MHz	9A
204.640 MHz	9B
206.352 MHz	9C
208.064 MHz	9D
209.936 MHz	10A
211.648 MHz	10B
213.360 MHz	10C
215.072 MHz	10D
216.928 MHz	11A
* 218.640 MHz	11B
* 220.352 MHz	11C
* 222.064 MHz	11D
* 223.936 MHz	12A

* 225.648 MHz	12B
* 227.360 MHz	12C
* 229.072 MHz	12D
230.784 MHz	13A
232.496 MHz	13B
234.208 MHz	13C
235.776 MHz	13D
237.488 MHz	13E
239.200 MHz	13F

■ L-Band

Frequency	Channel label
1452.960 MHz	LA
1454.672 MHz	LB
1456.384 MHz	LC
1458.096 MHz	LD
1459.808 MHz	LE
1461.520 MHz	LF
1463.232 MHz	LG
1464.944 MHz	LH
1466.656 MHz	LI
1468.368 MHz	LJ
1470.080 MHz	LK
1471.792 MHz	LL
1473.504 MHz	LM
1475.216 MHz	LN
1476.928 MHz	LO
1478.640 MHz	LP
1480.352 MHz	LQ
1482.064 MHz	LR
1483.776 MHz	LS
1485.488 MHz	LT
1487.200 MHz	LU
1488.912 MHz	LV
1490.624 MHz	LW

SPECIFICATIONS

AUDIO SECTION

- Minimum RMS Output Power for Front, Center, Surround, Surround back
20 Hz to 20 kHz, 0.06% THD, 8 Ω 90 W
- Dynamic Power (IHF)
8/6/4/2 Ω 120/155/190/235 W
- Maximum Output Power for Front, Center, Surround, Surround back
1 kHz, 0.7% THD, 4 Ω 140 W
- IEC Output Power
Front L/R, 1 kHz, 0.06% THD, 8 Ω 100 W + 100 W
- Damping Factor (IHF)
20 Hz to 20 kHz, 8 Ω 120 or more
- Frequency Response
CD, etc. 10 Hz to 100 kHz, -3 dB
V-AUX 10 Hz to 20 kHz, -3 dB
- Total Harmonic Distortion
CD, etc. to Front L/R (20 Hz to 20 kHz, 45 W, 8 Ω)
..... 0.06% or less
- Signal to Noise Ratio (IHF-A Network)
CD, etc. (250 mV) to Front L/R 100 dB or more
- Residual Noise (IHF-A Network)
SP OUT 150 μ V or less
- Channel Separation (1 kHz/10 kHz)
CD, etc. (5.1 k Ω shorted) 60 dB/45 dB or more
- Tone Control (Front L/R)
BASS Boost/Cut \pm 10 dB/60 Hz
TREBLE Boost/Cut \pm 10 dB/20 kHz
- Phones Output 150 mV/100 Ω
- Input Sensitivity/Input Impedance
CD, etc. 200 mV/47 k Ω
MULTI CH INPUT 200 mV/47 k Ω
- Output Level/Output Impedance
OUT (REC) 200 mV/1.2 k Ω
SUBWOOFER 4 V/1.2 k Ω

VIDEO SECTION

- Rated Input Voltage
Composite 1 Vp-p/75 Ω
S-video (Y) 1 Vp-p/75 Ω
S-video (C) 0.286 Vp-p/75 Ω
Component (Y) 1 Vp-p/75 Ω
Component (P_b, P_s) 0.7 Vp-p/75 Ω
- Signal to Noise Ratio 50 dB or more
- Frequency Response (MONITOR OUT)
Component 5 Hz to 60 MHz, -3 dB

FM SECTION

- Tuning Range 87.50 to 108.00 MHz
- Usable Sensitivity (IHF)..... 1.0 μ V (11.2 dBf)
- Signal to Noise Ratio (IHF)
Mono/Stereo 76 dB/70 dB
- Harmonic Distortion (1 kHz)
Mono/Stereo 0.2%/0.3%
- Stereo Separation (1 kHz) 42 dB
- Frequency Response 20 Hz to 15 kHz, +0.5, -2 dB

AM SECTION

- Tuning Range 531 to 1611 kHz
- Usable Sensitivity 300 μ V/m

DAB SECTION

- Tuning Range
(Band III) 174 to 240 MHz
(L-Band) 1452 to 1492 MHz
- Sensitivity
(Band III) -99 dBm
(L-Band) -95 dBm
- Signal to Noise Ratio 97 dB
- Total Harmonic Distortion 0.01%
- Stereo Separation (1 kHz) 95dB
- Frequency Response 20 Hz to 20 kHz/ \pm 0.5 dB

GENERAL

- Power Supply AC 230 V, 50 Hz
- Power Consumption 360 W
- Standby Power Consumption 0.1 W or less
- AC Outlets 1 (Total 100 W maximum)
- Dimensions (W x H x D) 435 x 161 x 391 mm
- Weight 10.7 kg

LIST OF REMOTE CONTROL CODES

TV

ADMIRAL 292, 293
 AIWA 276, 283, 284, 294
 AKAI 295, 296
 ALBA 296
 AOC 297
 BELL&HOWELL 292
 BESTAR 298
 BLAUPUNKT 222, 229
 BLUE SKY 298
 BRANDT 223
 BROCSONIC 297
 BUSH 296
 CLATRONIC 298
 CRAIG 224
 CROSLEX 225
 CURTIS MATHIS 226, 297
 DAEWOO 224, 227, 228, 297, 298
 DAYTRON 239
 DUAL 298
 DWIN 293
 EMERSON 224, 232, 239, 297
 FERGUSON 223, 265, 266
 FIRST LINE 298
 FUNAI 277, 278
 FISHER 233, 295
 FRABA 298
 GE 234, 235, 236, 293, 297
 LG/GOLDSTAR 297, 298, 239, 237
 GOODMANS 296, 298, 223
 GRUNDIG 229, 238, 249
 HITACHI 297, 239, 242, 243, 285
 ICE 296
 IRRADIO 296
 ITT/NOKIA 244, 245
 JC PENNY 293, 297, 234, 237
 JVC 296, 246, 247, 286
 KENDO 298
 KTV 297, 239
 LOEWE 298, 248
 LXI 293, 297, 225, 226, 233
 MAGNAVOX 297, 225, 239
 MARANTZ 298
 MATSUI 295
 MEMOREX 297
 MITSUBISHI 299, 297, 259, 287
 NEC 297, 252, 282
 NOKIA 244, 245
 NOKIA OCEANIC 245
 NORDMENDE 265, 266
 ONWA 296
 PANASONIC 234, 235, 236, 253, 288, 211
 PHILCO 297, 225, 239
 PHILIPS 225, 298
 PIONEER 226, 235, 254, 255, 268
 PORTLAND 297, 256
 PROSCAN 293
 PROTON 297
 QUASAR 234, 235
 RADIO SHACK 299, 293, 297

RCA 293, 297, 234, 256, 257, 258
 SABA 223, 269, 265, 266
 SAMPO 297
 SAMSUNG 297, 239, 248, 262, 275
 SANYO 295, 233, 279, 272, 273, 274, 212
 SCHNEIDER 296
 SCOTT 297
 SHARP 292, 239, 232, 213, 216
 SIEMENS 229
 SIGNATURE 292
 SONY 263, 214
 SYLVANIA 297, 225
 TELEFUNKEN 269, 264, 265, 266
 THOMSON 223, 266
 TOSHIBA 292, 226, 267, 215
 VIDECH 297, 242
 WARDS 297, 239, 232
 YAMAHA 213, 299, 292, 253, 242

VCR

ADMIRAL 395
 AIWA 396, 397, 398, 329
 AKAI 322, 323, 324
 AUDIO DYNAMIC 392, 394
 BELL&HOWELL 393
 BLAUPUNKT 325, 326
 BROCSONIC 327
 BUSH 322
 CANON 325, 328
 CGM 396, 332
 CITIZEN 396
 CRAIG 396, 363
 CURTIS MATHIS 397, 328, 333
 DAEWOO 328, 334, 335
 DBX 392, 394
 DIMENSIA 333
 DYNATECH 397
 EMERSON 327, 334, 396, 397
 FISHER 393, 336
 FUNAI 397
 GE 328, 333, 387
 GO VIDEO 353
 GOODMANS 334, 337
 GRUNDIG 332, 338
 HITACHI 325, 333, 349, 342, 343
 INSTANT REPLAY 325, 328
 ITT/NOKIA 393
 JC PENNY 392, 393, 394, 328, 333, 349, 396, 363
 JVC 392, 394, 344, 345, 346, 347
 KENDO 396
 KENWOOD 392, 394, 396
 LG/GOLDSTAR 396, 388
 LOEWE 396, 337
 LUXOR 395
 LXI 393, 396, 397, 336, 349
 MAGNAVOX 325, 326, 328

MARANTZ 392, 394
 MARTA 396
 MATSUI 396
 MEMOREX 328, 336, 396, 397
 MINOLTA 333, 349
 MITSUBISHI 399, 344, 348, 359, 353
 MTC 363, 397
 MULTITECH 397, 348, 354
 NEC 392, 394, 344, 383
 NOKIA OCEANIC 395
 NOKIA 393, 395
 OKANO 323
 OLYMPIC 325, 328
 ORION 327
 PANASONIC 325, 328, 355, 378, 384, 385, 386
 PENTAX 333, 349
 PHILCO 325, 328, 397
 PHILIPS 325, 326, 328, 337, 356, 357
 PHONOLA 337
 PILOT 396
 PIONEER 325
 QUASAR 325, 328
 RCA/PROSCAN 325, 326, 328, 333, 335, 349, 358, 363, 397
 REALISTIC 393, 397, 328, 336, 359, 396, 363
 SAMSUNG 354, 358, 363, 364, 366
 SANSUI 394
 SANYO 393, 336, 367
 SCHNEIDER 337
 SCOTT 399, 335, 336, 348, 359, 354, 358
 SELECO 322
 SHARP 395, 382
 SIEMENS 393
 SIGNATURE 2000 395, 397, 368, 379, 372, 373, 374, 375
 SONY 397, 325, 326, 328
 SYMPHONIC 397
 TANDBERG 334
 TANDY 397
 TASHIRO 396
 TATUNG 392, 394
 TEAC 392, 394, 397
 TECHNICS 325, 328
 TEKNIKA 396
 TELEFUNKEN 376, 377
 THOMAS 397
 THORN 393, 396
 TOSHIBA 335, 389
 TOTEVISION 363, 396
 UNITECH 363
 UNIVERSUM 396, 327, 376
 VIDEOSONIC 363
 W.WHOUSE 396
 WARDS 395, 396, 336
 YAMAHA 399, 392, 393, 394
 ZENITH 344, 368, 379, 396, 397

DVD PLAYER

DENON 623, 624
 FUNAI 625
 HITACHI 626
 JVC 627
 KENWOOD 628
 LG/GOLD STAR 645
 MITSUBISHI 629
 ONKYO 632, 633, 634
 PANASONIC 623, 635
 PHILIPS 699, 647
 PIONEER 636, 637, 638
 RCA 639
 SAMSUNG 642
 SHARP 643
 SONY 644
 THOMSON 646
 TOSHIBA 634
 YAMAHA 622, 623, 647, 699

CD PLAYER

YAMAHA 199

CD RECORDER

YAMAHA 499

MD RECORDER

YAMAHA 599



© 2006 YAMAHA CORPORATION All rights reserved.

YAMAHA ELECTRONICS CORPORATION, USA 6660 ORANGETHORPE AVE., BUENA PARK, CALIF. 90620, U.S.A.
YAMAHA CANADA MUSIC LTD. 135 MILNER AVE., SCARBOROUGH, ONTARIO M1S 3R1, CANADA
YAMAHA ELECTRONIK EUROPA G.m.b.H. SIEMENSSTR. 22-34, 25462 RELINGEN BEI HAMBURG, GERMANY
YAMAHA ELECTRONIQUE FRANCE S.A. RUE AMBROISE CROIZAT BP70 CROISSY-BEAUBOURG 77312 MARNE-LA-VALLEE CEDEX02, FRANCE
YAMAHA ELECTRONICS (UK) LTD. YAMAHA HOUSE, 200 RICKMANSWORTH ROAD WATFORD, HERTS WD18 7GQ, ENGLAND
YAMAHA SCANDINAVIA A.B. J A WETTERGRENS GATA 1, BOX 30053, 400 43 VÄSTRA FRÖLUNDA, SWEDEN
YAMAHA MUSIC AUSTRALIA PTY, LTD. 17-33 MARKET ST., SOUTH MELBOURNE, 3205 VIC., AUSTRALIA

YAMAHA CORPORATION
Printed in Malaysia ◀ WG76210

Free Manuals Download Website

<http://myh66.com>

<http://usermanuals.us>

<http://www.somanuals.com>

<http://www.4manuals.cc>

<http://www.manual-lib.com>

<http://www.404manual.com>

<http://www.luxmanual.com>

<http://aubethermostatmanual.com>

Golf course search by state

<http://golfingnear.com>

Email search by domain

<http://emailbydomain.com>

Auto manuals search

<http://auto.somanuals.com>

TV manuals search

<http://tv.somanuals.com>