

YAMAHA

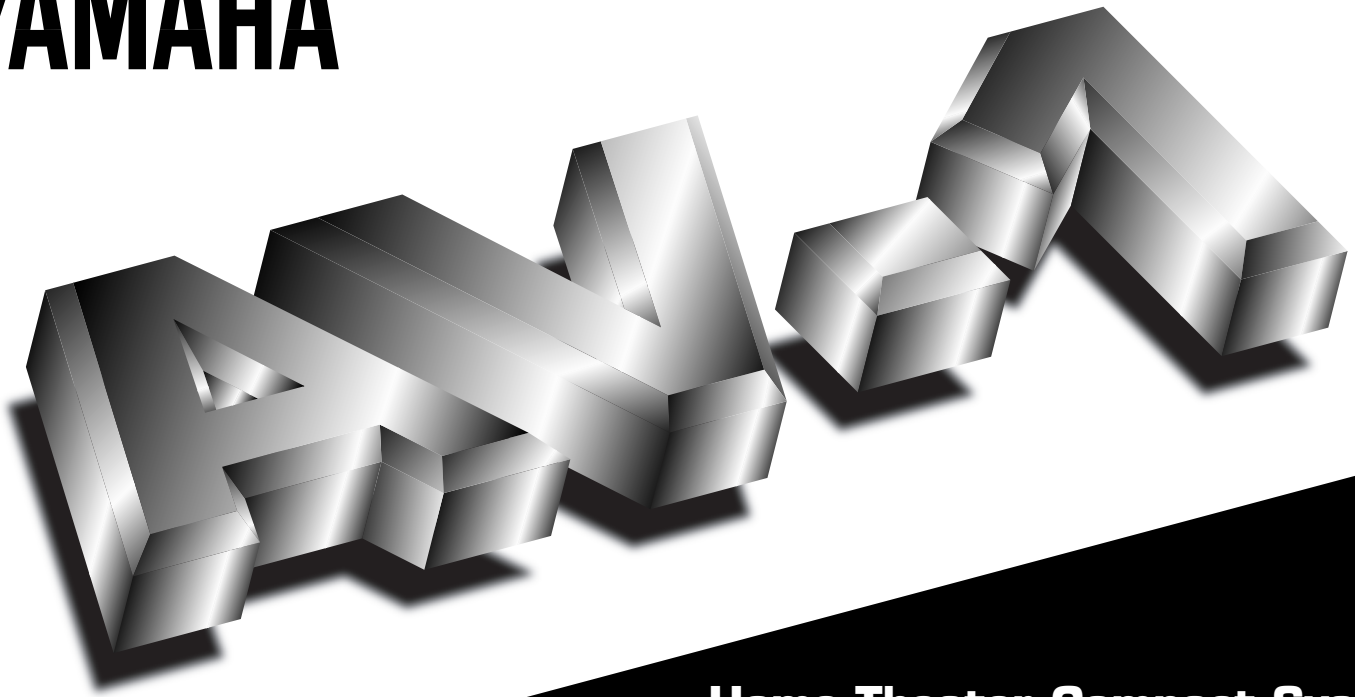

Home Theater Compact System
Salle de cinéma domestique compacte

Home Theater Kompaktanlage

Kompakt anläggning av Home Theater-typ

Sistema compatto di sala cinematografica ad uso domestico

Sistema compacto del Cine en el Hogar

Thuis Theater Compact System

OWNER'S MANUAL

MODE D'EMPLOI

BEDIENUNGSANLEITUNG

BRUKSANVISNING

MANUALE DI ISTRUZIONI

MANUAL DE INSTRUCCIONES

GEBRUIKSAANWIJZING

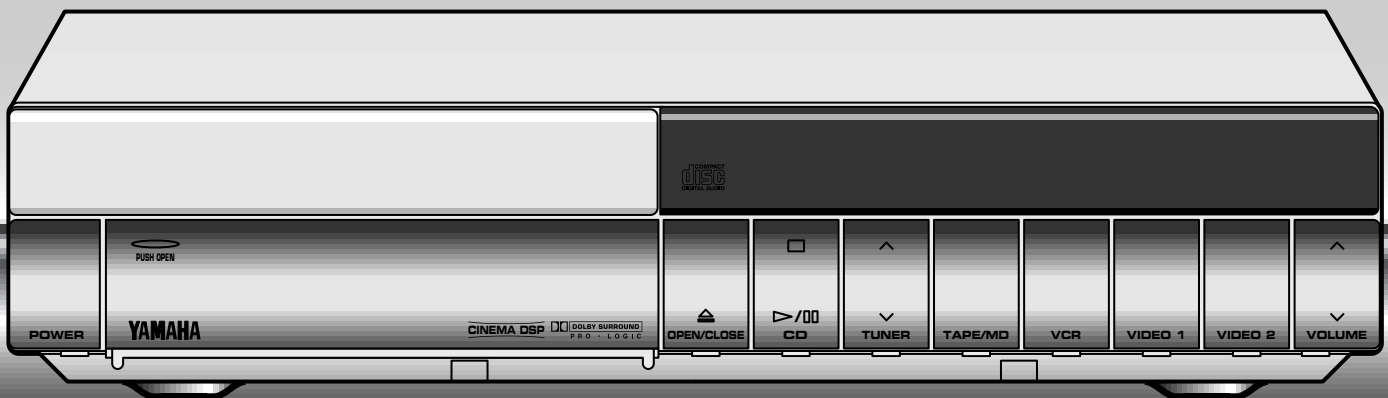

SUPPLIED ACCESSORIES
ACCESSOIRES FOURNIS
MITGELIEFERTES ZUBEHÖR
MEDFÖLJANDE TILLBEHÖR
ACCESSORI IN DOTAZIONE
ACCESORIOS INCLUIDOS
BIJGELEVERDE ACCESSOIRES

- After unpacking, check that the following parts are contained.
- Après le déballage, vérifier que les pièces suivantes sont incluses.
- Nach dem Auspacken überprüfen, ob die folgenden Teile vorhanden sind.
- Kontrollera efter det apparaten packats upp att följande delar finns med.
- Verificare che tutte le parti seguenti siano contenute nell'imballaggio dell'apparecchio.
- Desembale el aparato y verificar que los siguientes accesorios están en la caja.
- Controleer na het uitpakken of de volgende onderdelen voorhanden zijn.

<ul style="list-style-type: none"> • Remote control transmitter • Télécommande • Fernbedienung • Fjärrkontroll • Telecomando • Controlador remoto • Afstandbediening 	<ul style="list-style-type: none"> • System connector cable • Câble de connexion du système • System-Verbindungskabel • Systemkontrollkabel • Cavo di collegamento del sistema • Cable de conexión del sistema • Systeemaansluitkabel 
<ul style="list-style-type: none"> • Batteries (size AA, UM/SUM-3, R6, HP-7) • Piles (format AA, UM/SUM-3, R6, HP-7) • Batterien (Größe AA, UM/SUM-3, R6, HP-7) • Batterier (Storl. AA, UM/SUM-3, R6, HP-7) • Batterie (dimensioni AA, o UM/SUM-3, o R6, o HP-7) • Pilas (tamaño AA, tipo UM/SUM-3, R6, HP-7) • Batterijen (maat AA, UM/SUM-3, R6, HP-7) 	<ul style="list-style-type: none"> • Speaker cords • Câbles d'enceintes • Lautsprecheranschlußkabel • Högtalarledninggar • Cavi per gli altoparlanti • Cables de los altavoces • Luidsprekerdraden 
<ul style="list-style-type: none"> • AM (MW/LW) loop antenna • Cadre-antenne AM (PO/GO) • MW/LW-Rahmenantenne • AM (MV/LV) ramantenn • Antenna ad anello per AM (MW e LW) • Antena de cuadro AM (OM/OL) • AM (MW/LW) lusantenne 	<ul style="list-style-type: none"> • Mounting brackets • Supports de montage • Befestigungshalterungen • Monteringsfästen • Staffe di montaggio • Ménsulas de instalación • Montagesteunen 
<ul style="list-style-type: none"> • Indoor FM antenna • Antenne intérieure FM • UKW-Innenantenne • FM inomhusantenn • Antenna FM per interni • Antena interior de FM • FM binnenantenne 	<ul style="list-style-type: none"> • Screws • Vis • Schrauben • Skruvar • Viti • Tornillos • Schroeven 
<ul style="list-style-type: none"> • Audio connection cord • Câble de connexion audio • Audio-Anschlußkabel • Audio anslutningsssladdar • Cavo di collegamento audio • Cable de conexión de audio • Audio aansluitkabel 	<ul style="list-style-type: none"> • Tag sheet (for speaker cords) • Plaquette d'étiquettes (pour les cordons d'enceinte) • Markierungsflagge (für Lautsprecherkabel) • Etikettark (för högtalarledninggar) • Cartellini (per i cavi degli altoparlanti) • Hoja de etiquetas (para los cables de altavoz) • Etikettenvel (voor luidsprekerkabels) 

INTRODUCTION

Thank you for purchasing this YAMAHA product. We hope it will give you many years of trouble-free enjoyment. For the best performance, read this manual carefully. It will guide you in operating your YAMAHA product.

A Brief Guide to Proper Use of This System and The Owner's Manual

The following procedure shows you how to begin using this system and the owner's manual from the time just after you bought this system.

1. Unpack the package, and check the contents. (Refer to the inside of the cover and page 6.)
2. Read "PRECAUTIONS" on this manual (on pages 3 to 5) first of all.
3. To understand this system, see pages 6 to 8.
4. Position and install all units in this system (see pages 9 to 11), and then make connections (see pages 12 to 17).

Do not plug in this system until all connections are completed.

5. Before listening to a source, make some adjustments. (See pages 24 to 27.)
6. Begin listening to a source. (See pages 28 to 29.)
 - To listen to a compact disc, see pages 30 to 32.
 - To listen to a radio program, see pages 33 to 37.
(For U.K. and Europe models only, see pages 33 to 43.)
 - To listen to or watch a source played on an external unit, see page 44.
7. To enjoy listening to a source with surround sound effects, see pages 45 to 48.
 - To use the built-in timer, see pages 49 to 51.
 - If you want to know the function of a button, switch or indicator, see pages 18 to 23.

CONTENTS

	Page		Page
PRECAUTIONS		ENJOYING LISTENING TO A SOURCE	
PRECAUTIONS	3-4	BASIC LISTENING OPERATIONS	28-29
NOTES ABOUT THE REMOTE CONTROL TRANSMITTER	5	LISTENING TO A COMPACT DISC	
OUTLINE OF THIS SYSTEM		COMPACT DISC PLAYER OPERATION.....	30-32
SYSTEM CONFIGURATION	6	LISTENING TO A RADIO PROGRAM	
FEATURES	7	TUNING OPERATION	33-37
DIGITAL SOUND FIELD PROCESSOR (DSP)	8	RECEIVING RDS STATIONS <U.K. and Europe models only>	
SETTING UP THE SPEAKERS		RECEIVING RDS STATIONS <U.K. and Europe models only>.....	38-43
SETTING UP THE SPEAKERS	9-11	LISTENING TO A SOURCE ON AN EXTERNAL UNIT	
CONNECTIONS		OPERATING EXTERNAL UNITS CONNECTED WITH THIS SYSTEM.....	44
CONNECTIONS	12-17	USING DIGITAL SOUND FIELD PROCESSOR (DSP)	
CONTROLS AND THEIR FUNCTIONS		USING DIGITAL SOUND FIELD PROCESSOR (DSP).....	45-48
CONTROLS AND THEIR FUNCTIONS.....	18-23	HOW TO USE THE BUILT-IN TIMER	
TURNING THE POWER TO THIS SYSTEM ON OR IN THE STANDBY MODE		TIMER PLAY	49-50
TURNING THE POWER TO THIS SYSTEM ON OR IN THE STANDBY MODE	24	SLEEP TIMER OPERATION	51
ADJUSTMENTS BEFORE LISTENING OPERATIONS		TROUBLESHOOTING	
SETTING THE CLOCK	25	TROUBLESHOOTING	52
ADJUSTING BRIGHTNESS OF THE DISPLAY	25	SPECIFICATIONS	
SPEAKER BALANCE ADJUSTMENT	26-27	SPECIFICATIONS	53-54

PRECAUTIONS

PRECAUTIONS: READ THIS BEFORE OPERATING THIS SYSTEM

- To assure the finest performance, please read this manual carefully. Keep it in a safe place for future reference.
- Choose the installation location of this unit carefully. Avoid placing it in direct sunlight or close to a source of heat. Also avoid locations subject to vibration and excessive dust, heat, cold or moisture. Keep it away from sources of hum such as transformers and electric motors.
- Do not operate this unit upside-down. It may overheat, possibly causing damage.
- Never open the cabinet. If something drops into the set, contact your dealer.
- The openings on the surface of the power amplifier/subwoofer unit assure proper ventilation of the unit. If these openings are obstructed, the temperature inside the unit will rise rapidly. Therefore, avoid placing objects against these openings, and install the unit in well-ventilated condition. Make sure to allow a space of at least 10 cm behind, 10 cm on the both sides and 20 cm above the top panel of the unit, and never use the unit with the unit laid down on the floor. Otherwise it may not only damage the unit, but also cause fire.
- Always make the volume setting to minimum before starting an audio source play: increase the volume gradually to an appropriate level after play has started.
- When not planning to use this unit for long periods of time (ie., vacation, etc.), disconnect the AC power plug from the wall outlet.
- Grounding or polarization – Precautions should be taken so that the grounding or polarization of the unit is not defeated.
- Do not use force on switches, controls or connection wires. When moving the unit, first disconnect the power plug and the wires connected to other equipment. Never pull the wire itself.
- Do not attempt to clean the unit with chemical solvents; this might damage the finish. Use a clean, dry cloth.
- Be sure to read the “TROUBLESHOOTING” section regarding common operating errors before concluding that the unit is faulty.
- To prevent lightning damage, disconnect the AC power plug and the antenna cable when there is an electrical storm.
- Do not plug the AC power plug to the wall socket before you finish all connections.
- The voltage to be used must be the same as that specified on this unit. Using this unit with a higher voltage than that which is specified is dangerous and may result in a fire or other type of accident causing damage. YAMAHA will not be held responsible for any damage resulting from use of this unit with a voltage other than that which is specified.
- The sound level at a given volume setting depends on speaker location and other factors. Care should be taken to avoid exposure to sudden high levels of sound, which may occur when turning on the unit with the volume setting at high, and to continuous high levels of sound.
- Sudden temperature changes and storage or operation in an extremely humid environment may cause condensation inside the unit. Condensation can cause the unit to malfunction. To eliminate condensation:
 - **CD pickup**
Leave the power on with no disc in the unit until normal playback is possible (about 1 hour).
 - **Remote control**
Wipe off condensation on the transmitter window with a soft cloth before operating the unit.
- **Secure placement or installation is the owner’s responsibility.**
YAMAHA shall not be liable for any accident caused by improper placement or installation of this system.

IMPORTANT

Please record the serial number of this unit in the space below.

Serial No.:

The serial number is located on the rear of the unit. Retain this Owner’s Manual in a safe place for future reference.

WARNING

TO REDUCE THE RISK OF FIRE OR ELECTRIC SHOCK, DO NOT EXPOSE THIS APPLIANCE TO RAIN OR MOISTURE.

PRECAUTIONS

CAUTION (FOR CANADA MODEL)

TO PREVENT ELECTRIC SHOCK, MATCH WIDE BLADE OF PLUG TO WIDE SLOT AND FULLY INSERT.

FOR CANADIAN CUSTOMER

THIS CLASS B DIGITAL APPARATUS MEETS ALL REQUIREMENTS OF THE CANADIAN INTERFERENCE-CAUSING EQUIPMENT REGULATIONS.

NOTE

Please check the copyright laws in your country to record from records, compact discs, radio, etc. Recording of copyright material may infringe copyright laws.

For U.K. customers

If the socket outlets in the home are not suitable for the plug supplied with this appliance, it should be cut off and an appropriate 3 pin plug fitted. For details, refer to the instructions described below.

Note: The plug severed from the mains lead must be destroyed, as a plug with bared flexible cord is hazardous if engaged in a live socket outlet.

SPECIAL INSTRUCTIONS FOR U.K. MODEL

IMPORTANT:

The wire in the mains lead are coloured in accordance with the following code:

Blue: NEUTRAL

Brown: LIVE

The colours of the wires in the mains lead of this apparatus may not correspond with the coloured markings identifying the terminals in your plug. Proceed as follows: the wire which is coloured BLUE must be connected to the terminal which is marked with the letter N or coloured BLACK. The wire which is coloured BROWN must be connected to the terminal which is marked with the letter L or coloured RED. Making sure that neither core is connected to the earth terminal of the three pin plug.

This system is not disconnected from the AC power source as long as it is connected to the wall outlet, even if this system itself is turned off. In this state, this system is designed to consume a very small quantity of power.

VOLTAGE SELECTOR (General model only)

The voltage selector on bottom of the power amplifier/subwoofer (SW-AV1) must be set for your local main voltage BEFORE plugging into the AC main supply.

Voltages are 110/120/220/240V AC, 50/60 Hz.

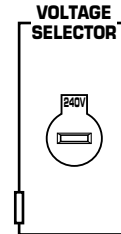

WARNING

To reduce the risk of fire or electric shock, do not expose this unit to rain or moisture.

To avoid electrical shock, do not open the cabinet. Refer servicing to qualified personnel only.

CAUTION 1

Use of controls or adjustments or performance of procedures other than those specified herein may result in hazardous radiation exposure.

CAUTION 2

As the laser beam used in this unit is harmful to the eyes, do not attempt to disassemble the cabinet. Refer servicing to qualified personnel only.

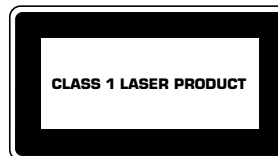

This unit is classified as a CLASS 1 LASER product. The CLASS 1 LASER PRODUCT label is located on the rear exterior.

Laser component in this product is capable of emitting radiation exceeding the limit for Class 1.

Laser Diode Properties

- Material: GaAlAs
- Wavelength: 780nm
- Emission Duration: continuous
- Laser Output: max. 44.6μW*

* This output is the value measured at a distance of about 200mm from the objective lens surface on the Optical Pick-up Block.

NOTES ABOUT THE REMOTE CONTROL TRANSMITTER

Loading the batteries for the remote control transmitter

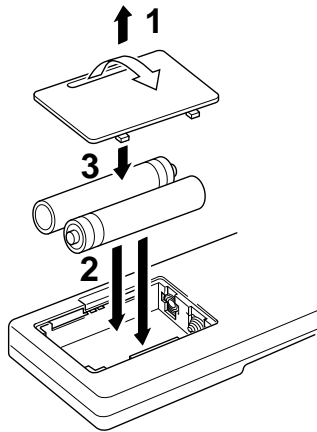

- 1** Remove the battery compartment cover. (Slide the cover in the direction of the arrow.)
- 2** Insert 2 “AA” size batteries (UM/SUM-3, R6, HP-7 or equivalent) into the battery compartment.
 - * Installing the batteries improperly may cause failure.
- 3** Replace the battery compartment cover.

Precautions for battery use

- Insert the batteries according to the direction indicated in the battery compartment.
- Replace all batteries with new ones at the same time.
- Remove the batteries if they are weak or if the unit is not in use for long periods.
- Don't mix normal batteries with rechargeable batteries.

Proper use of the remote control transmitter

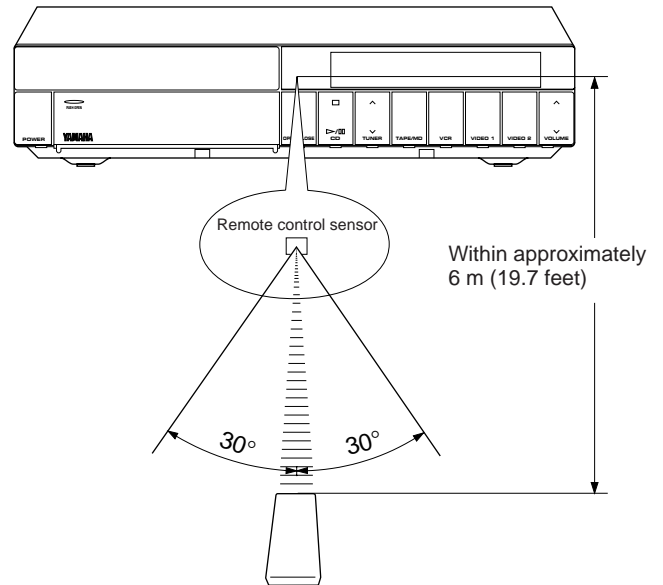

Aim (within the range of 60° with no obstacles) the remote control transmitter at the remote control sensor and operate as shown.

Notes concerning use

- Replace the batteries if control distance decreases or operation becomes unstable.
- Periodically clean the transmitter window on the remote control transmitter and the sensor on the main unit with a soft cloth.
- Exposing the sensor on the main unit to strong light (especially an inverter type of fluorescent lamp etc.) may interfere with operation. In this case, reposition the main unit to avoid direct lighting.
- Keep the remote control transmitter away from moisture, excessive heat, shock and vibrations.
- The remote control transmitter's usable range is within 0.2m (8") and 6m (20') away from the sensor.

SYSTEM CONFIGURATION

This system is a multi-channel audio system which consists of the units shown below. By driving 6 speakers, the built-in digital sound field processor (DSP) creates various kinds of Yamaha original digital sound fields simulating an actual concert hall, live house, etc. When watching a movie source, the built-in Dolby Pro Logic Surround decoder and the digital sound field processor turns your room into a movie theater with tremendous impact. Ultralow bass reproduced by the subwoofer (SW-AV1) makes sound more real and more powerful. The built-in CD player and tuner provide you with effortless operation and high performance. You will be given great enjoyment in listening to music and watching TV with this system.



SW-AV1
(6 channel power amplifier and Active Servo Processing Subwoofer system)

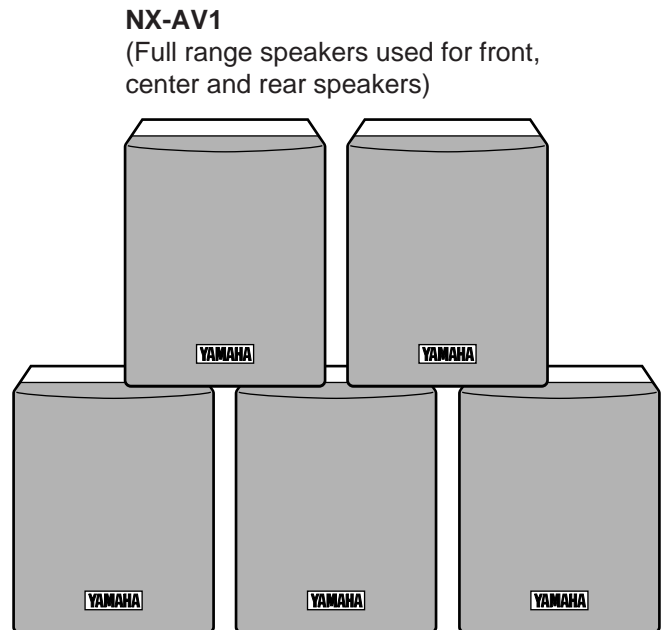

NX-AV1
(Full range speakers used for front, center and rear speakers)

TCD-AV1
(Main control unit including Tuner, CD player and Digital Sound Field Processor)

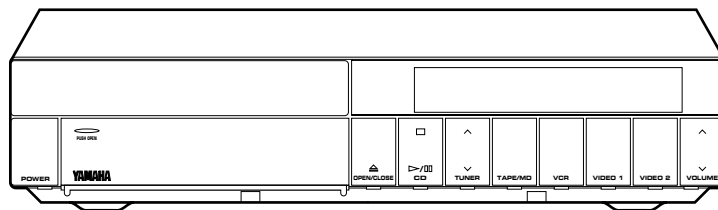

FEATURES

The System

- **6 Speaker Multi-Channel Audio System Including Two Front Speakers, One Center Speaker, Two Rear Speakers and One Subwoofer**
- **Minimum RMS Output Power per Channel**
 Front L, R: **30W + 30W (6Ω) RMS Output Power, 10% THD, 1 kHz**
 Center: **30W (6Ω) RMS Output Power, 10% THD, 1 kHz**
 Rear L, R: **30W + 30W (6Ω) RMS Output Power, 10% THD, 1 kHz**
 Subwoofer: **50W (4Ω) RMS Output Power, 10% THD, 100 Hz**
- **Active Servo Processing Subwoofer System for Super Low Bass Reproducing (SW-AV1)**
- **Simple and Easy Operating Methods**
- **Direct Playback by a Simple Operation**
- **Automatic Function to Turn the System into the Standby Mode**
- **Adjustable Display Brightness**
- **Multi-Use Timer/Sleep Timer**
- **5 External Audio/Video Component Connecting Capability**
- **On Screen Display Function (Displays Volume Setting, Speaker Balance Adjustment, Program Names, etc. on the TV Monitor)**
- **Remote Control Capability**

Compact Disc Player

- **Single Track/Entire Disc Repeat Play**

Tuner

- **40 Station Random Access Preset Tuning**
 - **40 Station Automatic Preset Tuning**
- <Europe and U.K. models only>
- **Multi-Functions for RDS Broadcast Reception**

Sound Field Processor Including Dolby Pro Logic Surround Decoder

- **Digital Sound Field Processor (Programs: STADIUM, DISCO, CONCERT HALL, ROCK CONCERT, MONO MOVIE, CONCERT VIDEO)**
- **Dolby Pro Logic Surround Decoder (Program: DOLBY PRO LOGIC)**
- **CINEMA DSP: Theater-like Sound Experience by the Combination of Dolby Pro Logic and YAMAHA DSP Technology (Program: DOLBY PRO LOGIC ENHANCED)**
- **Automatic Input Balance Control for Dolby Pro Logic Surround**
- **Test Tone Generator for Easier Speaker Balance Adjustment**

DIGITAL SOUND FIELD PROCESSOR (DSP)

The Digital Sound Field Processor (DSP) built into this system takes advantage of Yamaha's undisputed leadership in the field of digital audio processing to bring you a whole new world of listening experiences. Follow the instructions in this manual carefully when setting up your system, and this unit will sonically transform your room into a wide range of listening environments –movie theater, concert hall, and so on. In addition, you get incredible realism from sources encoded with Dolby Surround using the built-in Dolby Pro Logic Surround Decoder.

Please read this operation manual carefully and store it in a safe place for later reference.

Digital Sound Field Processing

What is it that makes live music so good? Today's advanced sound reproduction technology lets you get extremely close to the sound of a live performance, but chances are you'll still notice something missing: the acoustic environment of the live concert hall. Extensive research into the exact nature of the sonic reflections that create the ambience of a large hall has made it possible for Yamaha engineers to bring you this same sound in your own listening room, so you'll feel all the sound of a live concert.

Furthermore, our technicians, armed with sophisticated measuring equipment, have even made it possible to capture the acoustics of a variety of venues such as an actual concert hall, theater, etc. to allow you to accurately recreate one of several actual live performance environments, all in your own home.

Dolby Pro Logic Surround

This unit employs a Dolby Pro Logic Surround decoder similar to professional Dolby Stereo decoders used in many movie theaters. By using the Dolby Pro Logic Surround decoder, you can experience the dramatic realism and impact of Dolby Surround movie theater sound in your own home. Dolby Pro Logic employs a four channel five speaker system. The Pro Logic Surround system divides the input signal into four levels: the left and right main channels, the center channel (used for dialog), and the rear surround sound channels (used for sound effects, background noise, and other ambient noises). The center channel allows listeners seated in even less-than-ideal positions to hear the dialog originating from the action on the screen while experiencing good stereo imaging.

Dolby Surround is encoded on the sound track of pre-recorded video tapes, laser discs, and some TV/cable broadcasts. When you play a source encoded with Dolby

Surround on this unit, the Dolby Pro Logic Surround decoder decodes the signal and distributes the surround-sound effects.

This Dolby Pro Logic Surround Decoder employs a digital signal processing system. This system improves the stability of sound at each channel and minimizes crosstalk between channels, so that positioning of sounds around the room is more accurate compared with conventional analog signal processing systems. In addition, this unit features a built-in automatic input balance control. This always assures you the best performance without manual adjustment.

Manufactured under license from Dolby Laboratories Licensing Corporation. "Dolby", "Pro Logic", and the double-D symbol are trademarks of Dolby Laboratories Licensing Corporation.

Dolby Pro Logic Surround + DSP

Dolby Surround sound system shows its full ability in a large movie theater, because movie sounds are originally designed to be reproduced in a large movie theater using many speakers. It is difficult to create a sound environment similar to that of a movie theater in your listening room, because the room size, materials of inside walls, the number of speakers, etc. of your listening room is much different from those of a movie theater.

Yamaha DSP technology made it possible to present you with nearly the same sound experience as that of a large movie theater in your listening room by compensating for lack of presence and dynamics in your

listening room with its original digital sound fields combined with Dolby Surround sound field.

The combination of Dolby Pro Logic Surround and DSP is used on the sound field program "  PRO LOGIC ENHANCED".

CINEMA DSP

The YAMAHA "CINEMA DSP" logo indicates these programs are created by the combination of Dolby Pro Logic and YAMAHA DSP technology.

SETTING UP THE SPEAKERS

Before you make connections, place all units in this system in their proper positions respectively. Above all, the positioning of speakers are important, because it controls the whole sound quality of this system. Position the speakers on the basis of your listening position by following instructions on this section.

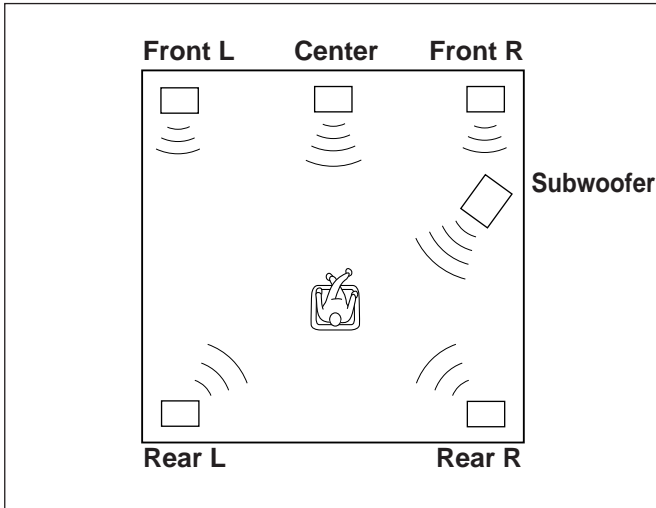

Speaker configuration

This system employs a 6 speaker configuration: 2 front speakers, 2 rear speakers, a center speaker and a subwoofer.

The front speakers are used for the main source sound plus the effect sounds. The rear speakers are used for the effect and surround sounds, and the center speaker is for the center sounds (dialog etc.). The subwoofer is for reinforcing low frequencies of the main source sound and the center sounds.

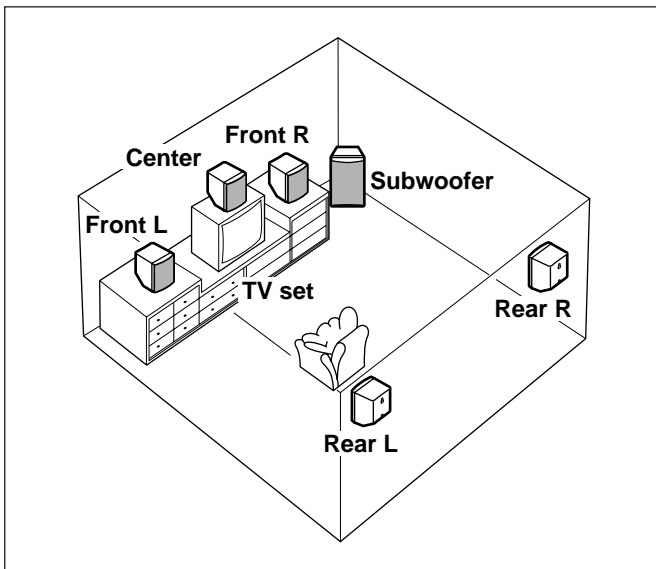

Placing speakers

- Front speakers:** On both sides of the TV and in almost the same height as the TV.
- Rear speakers:** Behind your listening position, facing slightly inward. Nearly six feet (approx. 1.8 m) up from the floor.
- Center speaker:** Precisely between the front speakers.
- Subwoofer:** The position of the subwoofer is not so critical because low bass tones are not highly directional.

SETTING UP THE SPEAKERS

1

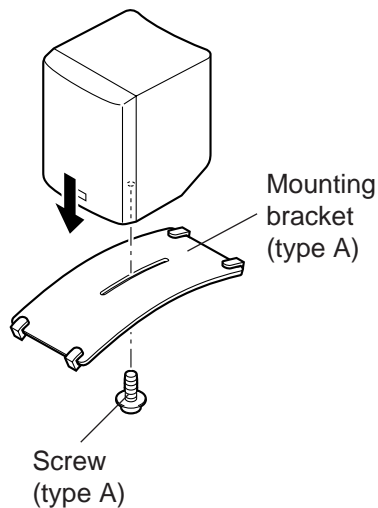

2

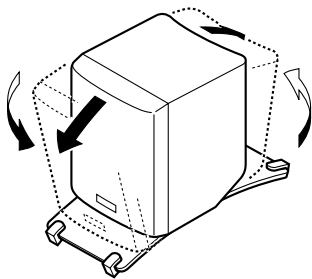

■ Mounting the front and center speakers

Place the front speakers on a rack or on a shelf, and place the center speaker on top of the TV or on a shelf or inside the TV rack so that it is stabilized.

To obtain more stability and usefulness, we recommend that you mount those speakers on the provided mounting brackets (type A).

To mount speakers on the mounting brackets (type A)

- 1 Attach the bracket to bottom of the speaker by using the provided screw (type A).
- 2 Turn and/or slide the speaker on the bracket according as you desire, and after that, tighten the screw.

Note

Though this speaker is a magnetically shielded type, there may be some influence on a TV picture depending on the type of TV or the placement of the speaker. In such a case, place the speaker apart from the TV so that there is no influence on TV picture.

1

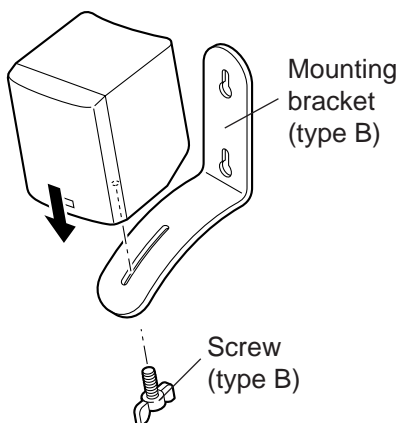

2

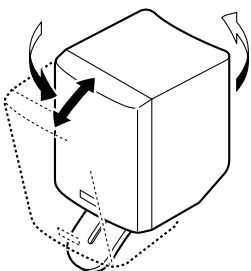

■ Mounting the rear speakers

Mount the rear speakers on a shelf, rack or on the floor directly, or hang them on the wall.

To mount the rear speakers on a wall by using the provided mounting brackets (type B)

Note

It is recommended that you connect the speaker cords to the speaker's terminals before attaching the bracket to the speaker.

- 1 Attach the bracket to bottom of the speaker by using the provided screw (type B).
- 2 Turn and/or slide the speaker on the bracket according as you desire, and after that, tighten the screw.

3

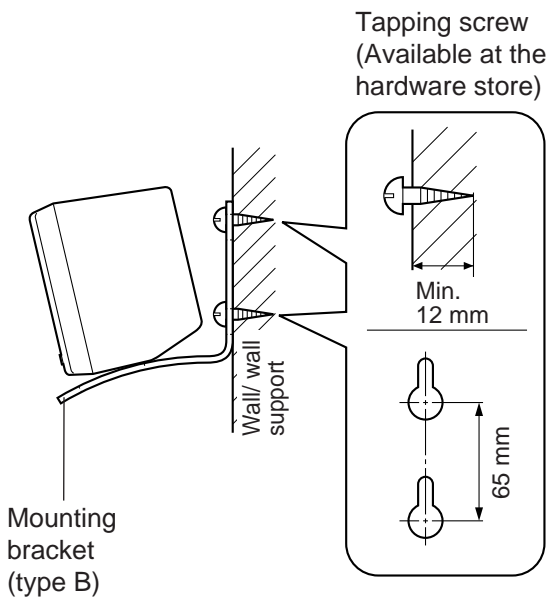

- 3 Fasten screws into a firm wall or wall support as shown in the figure, and hang the holes of the mounting bracket on the protruding screws.
- * Make sure that the screws are caught by a narrow part of the holes securely.

Note

If desired, you can hang the speaker on the protruding screws on the wall without using the bracket.

WARNING:

- Each speaker weighs 0.7 kg (1 lbs. 9 oz.). Do not mount them on thin plywood or soft wall surface material, as the screws may come out of the flimsy surface, causing the speakers to fall down and be damaged, or result in personal injury.
- Do not fasten the speakers to wall with nails, adhesives, or other unsound hardware. Long-term use and vibrations may cause them to fall down.
- To avoid accidents resulting from tripping over loose speaker cords, fix them to the wall.
- Select a proper position on the wall to mount the speaker and the bracket so that no one will hit his head or face on the sticking part of the bracket, resulting in personal injury.

■ If you want to mount the speaker on a commercially available speaker stand

The provided mounting bracket (type C) which has 1 pair of screw holes (at an interval of 60 mm) are available to mount the speaker on a speaker stand.

- * Those screw holes can be used with M4 screws only.

- 1 Attach the bracket to bottom of the speaker by using the provided screw (type A) so that the convex part of the bracket fits in grooved part on bottom of the speaker as figured left.

- 2 Mount the speaker on the speaker stand by using the screw holes on the bracket.

Note

The mounting bracket (type C) is provided for each of 5 speakers.

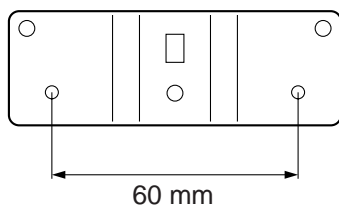
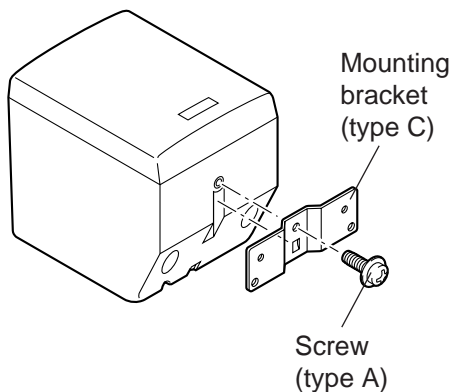

CONNECTIONS

When you have finished placing or installing all units in this system, begin making connections by following instructions on this section.

This system needs 6 kinds of connections: system connection, speaker connection, antenna connection and external unit connection, however the order of them is not important.

Never plug the AC supply lead of this system into the AC outlet until all connections are completed.

■ Making a system connection between the main control unit (TCD-AV1) and the power amplifier/subwoofer (SW-AV1)

- 1 Connect the SYSTEM CONNECTOR terminals on both units with each other by using the provided system connector cable.
 - * When connecting the system connector cable to both terminals, take notice of the directions of each SYSTEM CONNECTOR terminal's face.
- 2 Connect the AUDIO OUTPUT terminals on TCD-AV1 to the INPUT terminals on SW-AV1 by using the provided connection cord.
 - * Make sure to connect the red plug of the connection cord to the "R" (right) terminal and connect the white plug to the "L" terminal.

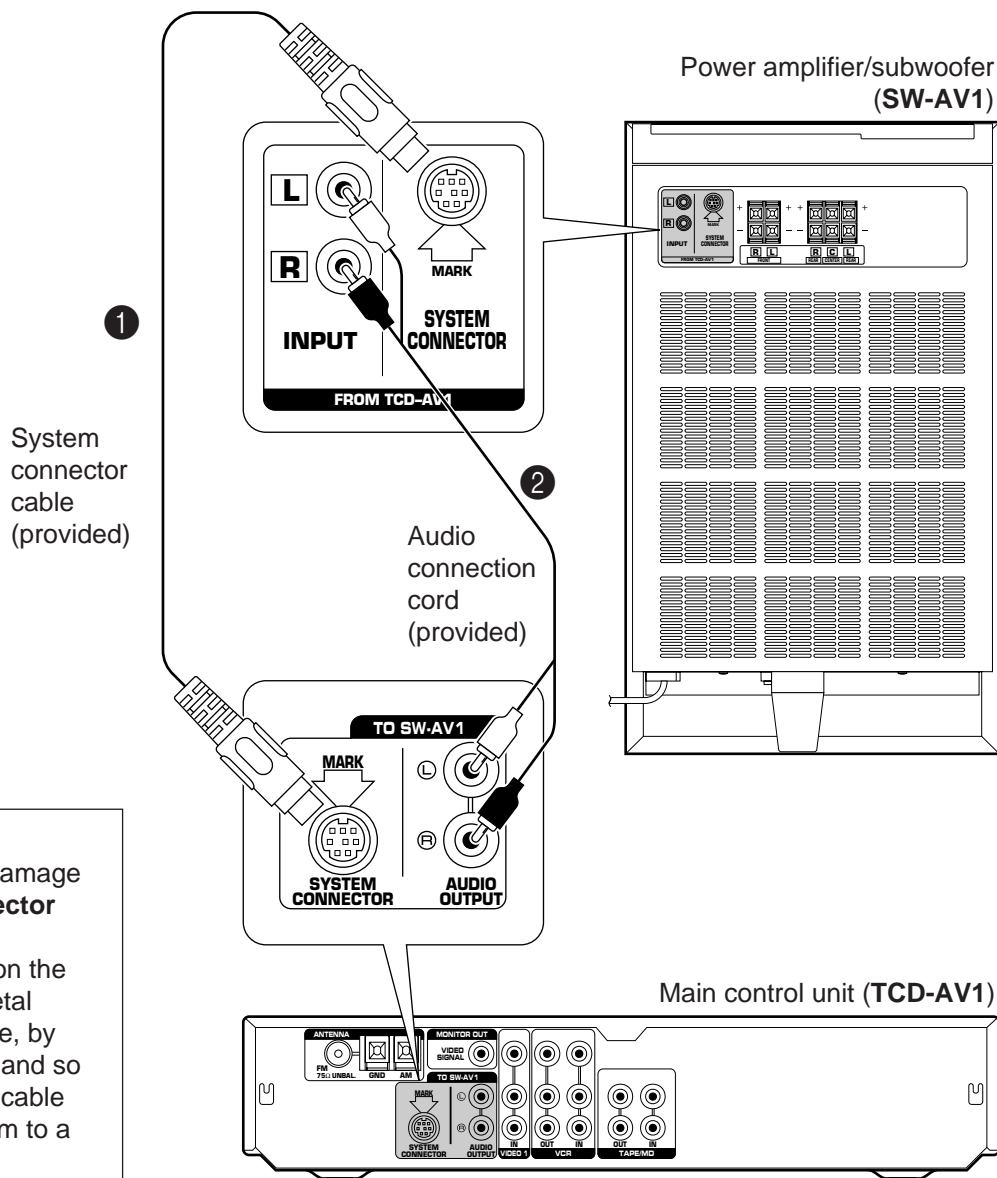

Caution
Be careful not to damage the **system connector cable** by placing something heavy on the cable, by fixing metal fittings on the cable, by tugging the cable, and so on. Damaging the cable will lead this system to a breakdown.

■ Connecting the speakers (NX-AV1) to the power amplifier/subwoofer (SW-AV1)

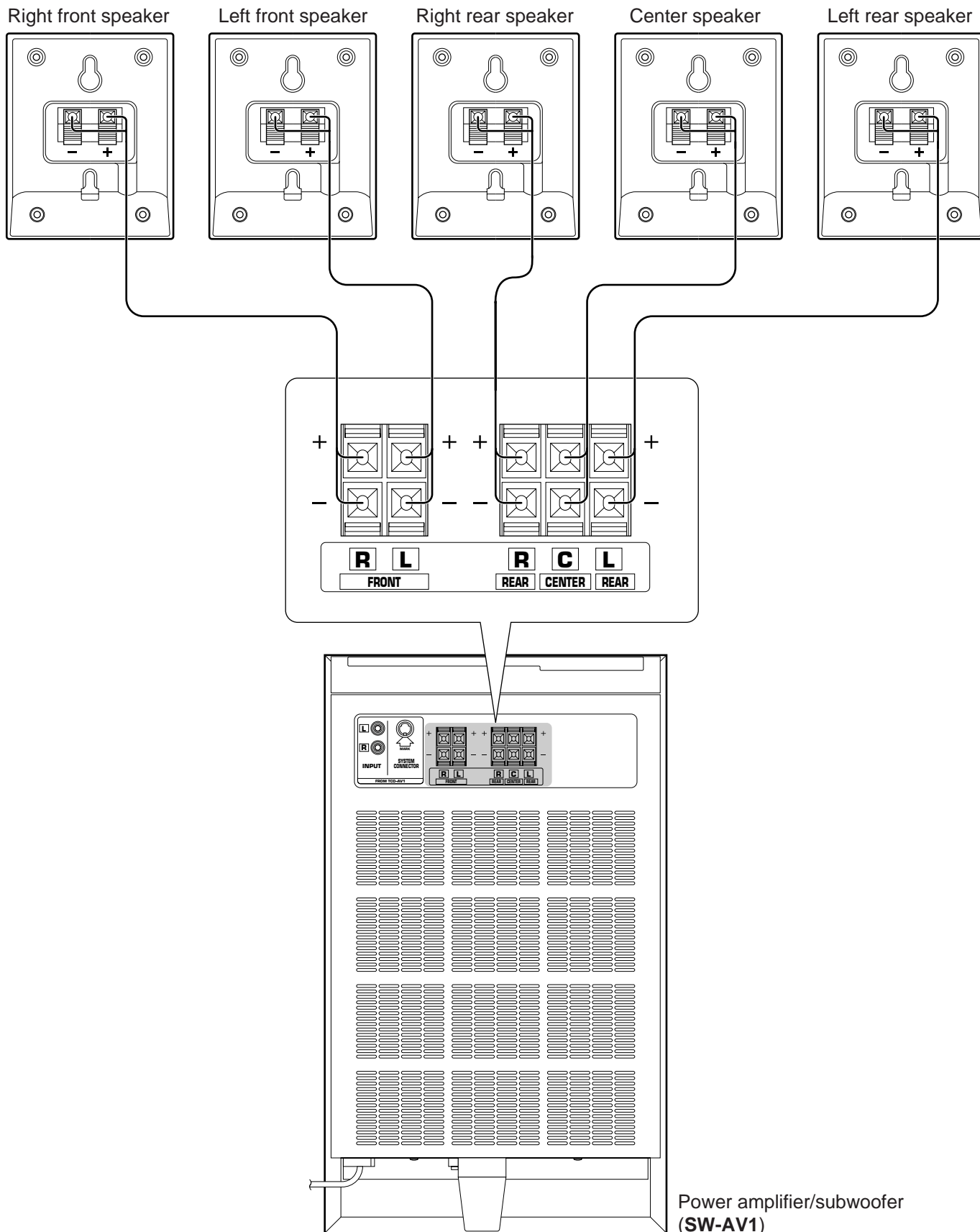

CONNECTIONS

Connect the provided speakers (NX-AV1) to the SPEAKERS terminals on the rear of SW-AV1.

All of the speakers (NX-AV1) are identical.

The speakers connected to the FRONT R and L terminals should be used as the right and left front speakers.

The speaker connected to the CENTER terminal should be used as the center speaker.

The speakers connected to the REAR R and L terminals should be used as the right and left rear speakers.

Notes

- Do not connect speakers other than the provided ones to SW-AV1.
- Use the provided speaker cords for the connections. Normally, use the short cords to connect with the front and center speakers, and use the long ones to connect with the rear speakers.
- The provided tag sheet for speaker cords is useful for preventing wrong connections between speakers and SW-AV1.

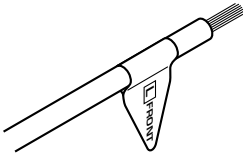

How to Connect:

Connect the provided speaker cords between the SPEAKERS terminals on the power amplifier/subwoofer (SW-AV1) and the speaker terminals on each speaker (NX-AV1) properly as shown below. If the connections are faulty, no sound will be heard from the speakers. Make sure that the polarity of the speaker wires is correct, that is the + and – markings are observed. If these wires are reversed, the sound will be unnatural and lack bass.

As a sure method, connect the wire with a silver line to the + terminals on both the power amplifier/subwoofer (SW-AV1) and speaker, and connect the wire with a no line to the – terminals on both of them.

Caution

Do not let the bare speaker wires touch each other as this could damage SW-AV1 and/or speakers.

On SW-AV1:

Red: positive (+)

Black: negative (–)

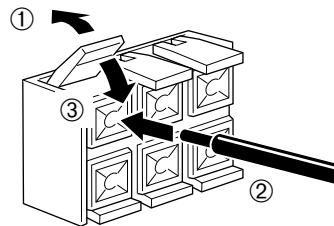

- ① Press up the tab.
- ② Insert the bare wire. [Remove approx. 5mm (1/4") insulation from the speaker wires.]
- ③ Press down the tab and secure the wire.

On NX-AV1:

Red: positive (+)

Black: negative (–)

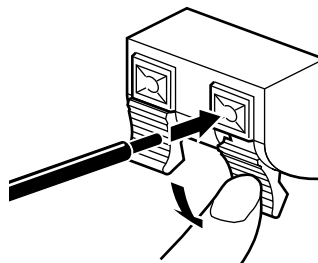

- ① Press the tab.
- ② Insert the bare wire. [Remove approx. 5mm (1/4") insulation from the speaker wires.]
- ③ Release the tab and secure the wire.

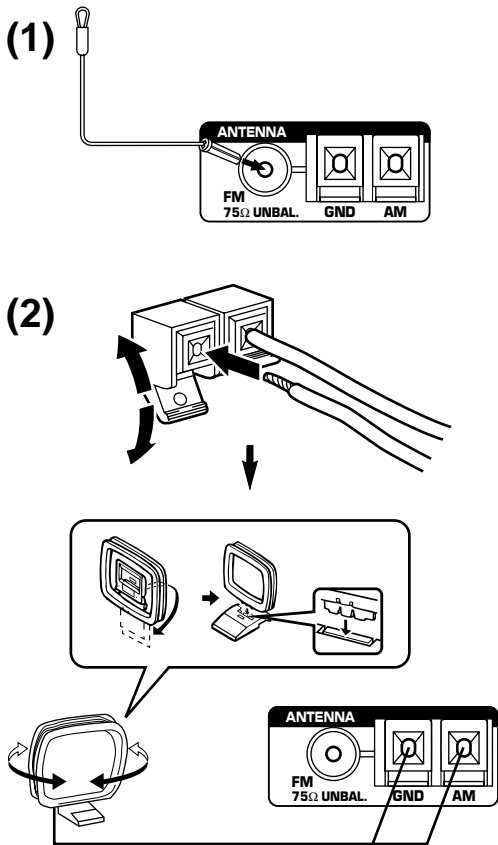

Antenna connection

(1) Supplied FM antenna

Connect the FM antenna wire to the corresponding terminal and direct the FM antenna wire to the direction where the strongest signal can be received.

(2) Supplied AM (MW/LW) loop antenna

Connect the AM (MW/LW) loop antenna wires to the corresponding terminals. Position the AM (MW/LW) loop antenna for optimum reception. Place the AM (MW/LW) loop antenna on a shelf etc., or install it on the rack or wall with screws (not provided).

Notes

- When static is still heard even after adjusting the position of the AM (MW/LW) loop antenna, try reversing the wire connections (right to left).
- Do not place the AM (MW/LW) loop antenna on the unit. It will result in noise generation, since the unit is equipped with digital electronics. Place the AM (MW/LW) loop antenna away from the unit.

(3) External FM antenna

Use an external FM antenna instead of an indoor FM antenna if you need better reception. Consult your dealer.

(4) External AM (MW/LW) antenna

Use an external AM (MW/LW) antenna if you need better reception. Consult your dealer.

Note

When using an external AM (MW/LW) antenna, be sure to keep the wire of the AM (MW/LW) loop antenna connected.

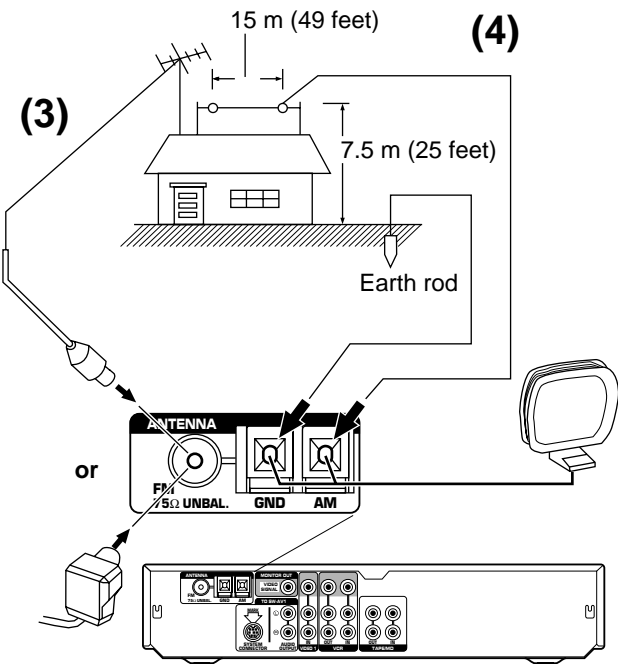

CONNECTIONS

■ Connecting external components

This system can be connected with external audio and video components. Make connections between this system and other components using RCA pin plug connector cables correctly, that is to say **L** (left) to **L** and **R** (right) to **R**. Also, refer to the owner's manual for each component to be connected to this system.

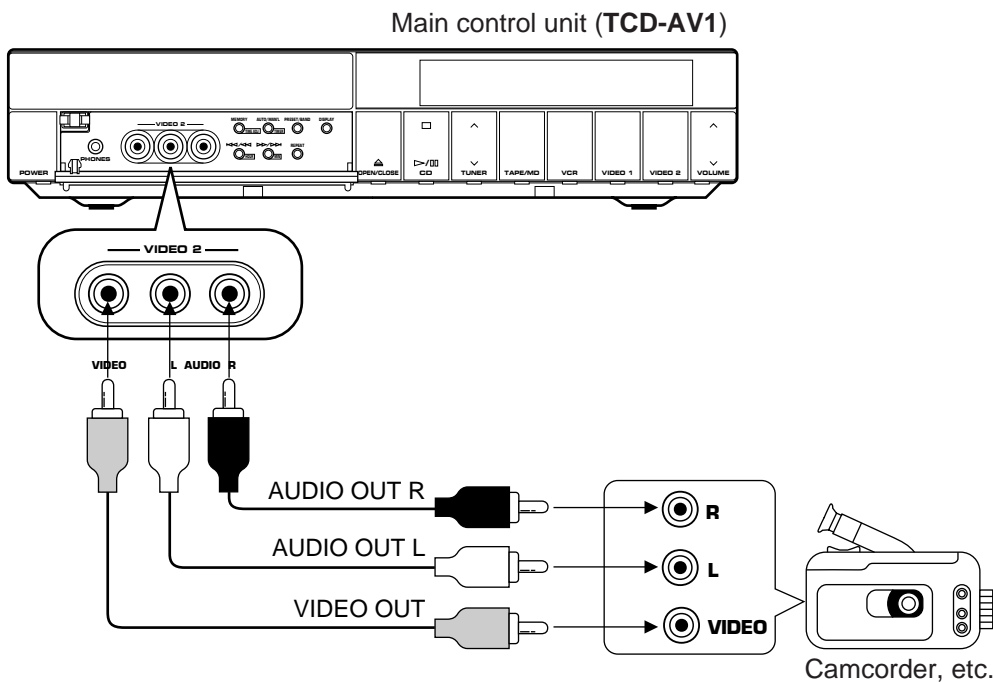
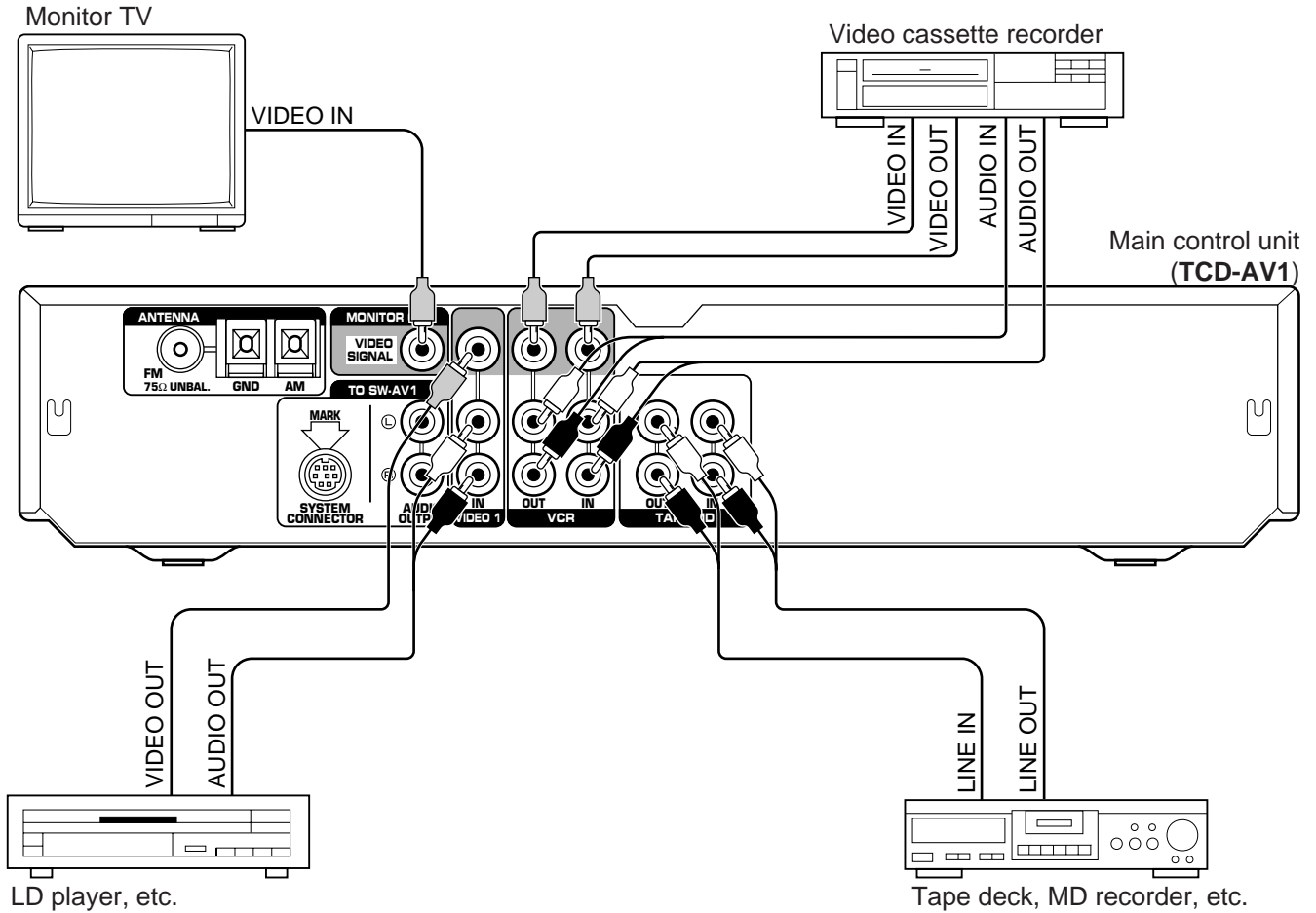

For General model only

FREQUENCY STEP switch

Because the interstation frequency spacing differs in different areas, set the **FREQUENCY STEP** switch (located at the rear) according to the frequency spacing in your area. Before setting this switch, disconnect the AC supply lead of this unit from the AC outlet.

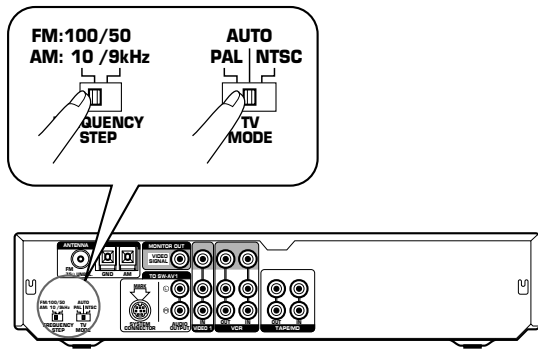

TV MODE switch

This system is designed for use with the NTSC and PAL television formats. Set this switch to the position for the format your monitor TV employs.

PAL: Outputs signals in the PAL format no matter which format (PAL or NTSC) of video signal is sent from an external video unit to this system. Set to this position if your monitor TV employs the PAL format.

Note: In this position, the On Screen Display function of this system will not work unless a video signal is input to this system.

AUTO: Outputs signals in the same format as the video signal input to this system employs. Set to this position if your monitor TV can be switched in between the PAL and NTSC formats automatically.

NTSC: Outputs signals in the NTSC format no matter which format (PAL or NTSC) of video signal is sent from an external video unit to this system. Set to this position if your monitor TV employs the NTSC format.

Note

Make sure to input a video signal which employs the same format that your monitor TV employs, otherwise a picture will not be played back normally.

■ Connecting the AC supply lead

General model only

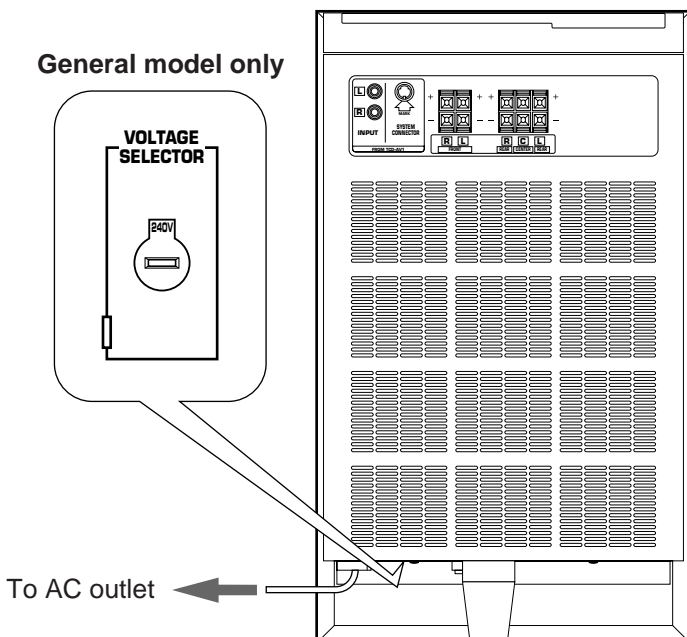

- After completing all connections, plug the AC supply lead into a convenient AC outlet.
- Unplug the AC supply lead from the AC outlet if this system is not to be used for a long period of time.

VOLTAGE SELECTOR (General model only)
 The voltage selector on bottom of the power amplifier/subwoofer (SW-AV1) must be set for your local main voltage **BEFORE** plugging into the AC main supply.
 Voltages are 110/120/220/240V AC, 50/60 Hz.

CONTROLS AND THEIR FUNCTIONS

FRONT PANEL

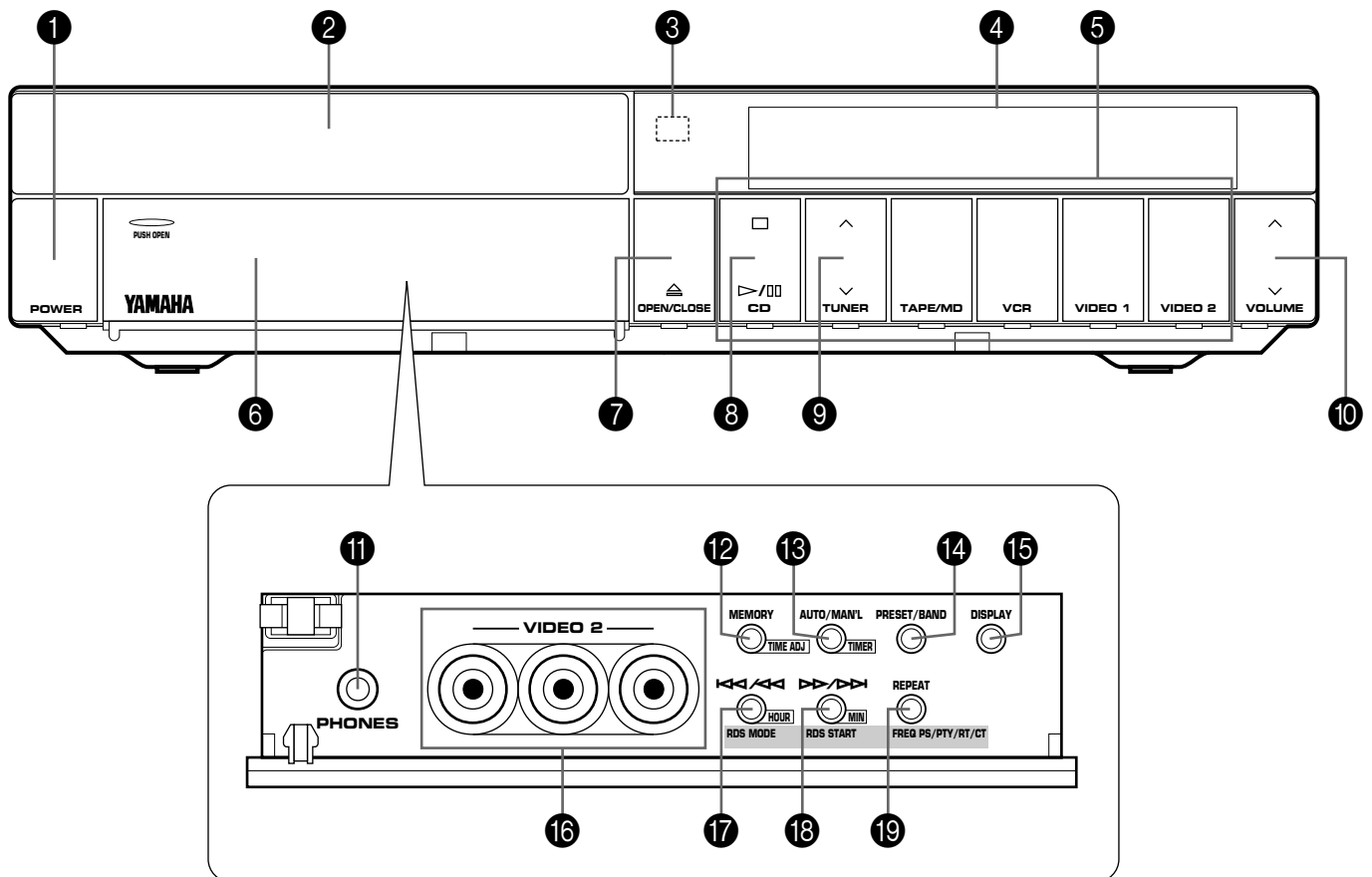

Letters in the shaded area (■) are printed on U.K. and Europe models only.

1 POWER switch

Press this switch to switch the power on. Press it again to switch this system into the standby mode.

2 Disc tray

When you will play back a compact disc, load the disc on this tray. When the CD playback is finished, unload the disc from this tray. Open and close this tray by pressing the **OPEN/CLOSE** button.

3 Remote control sensor

Receives signals from the remote control transmitter.

4 Display panel

Shows various information. (Refer to page 21 for details.)

5 Input selector buttons

Select a program source to listen to or watch. When a button is pressed, the name of selected source appears on the display.

If this system is in the standby mode, pressing one of these buttons turns this system on and selects the corresponding input source.

6 Control door

See page 20 for how to open and close the control door.

7 OPEN/CLOSE button

Opens and closes the disc tray.

If this system is in the standby mode, pressing this button turns this system on, then selects the CD player, and then opens the disc tray.

8 CD input selector button [□ (Stop), ▷/⏸ (play/pause)]

When an input source other than the built-in CD player is selected, pressing this button selects the CD player as an input source and starts playback if a disc is loaded on the disc tray.

While playing back a disc, pressing the lower side (▷/⏸) of this button pauses the playback. Pressing the lower side again resumes the playback.

While playing back a disc, pressing the upper side (□) stops the play.

9 TUNER input selector button [^ (up)/ ∨ (down)]

When an input source other than the built-in tuner is selected, pressing this button selects the tuner as an input source.

When the tuner is in the automatic or manual tuning mode, this button is used for tuning search. Pressing the upper side (^) makes a tuning search to higher frequencies, and pressing the lower side (∨) makes a tuning search to lower frequencies.

When the tuner is in the preset tuning mode, this button is used for selecting a preset station number. Pressing the upper side (^) selects a higher preset station number and pressing the lower side (∨) selects a lower preset station number.

<For U.K. and Europe models only>

When the tuner is in the PTY SEEK mode, pressing this button changes the currently selected program type.

10 VOLUME button [^ (up)/ ∨ (down)]

Pressing the upper side (^) raises and pressing the lower (∨) side lowers the volume of whole sound output of this system.

11 PHONES jack

When you listen with headphones, connect the headphones to the **PHONES** jack. You can listen to the sound to be output from the front speakers through headphones.

When listening with headphones privately, switch off the digital sound field processor (so that no DSP program name is illuminated on the display) by pressing the DSP **ON/OFF** button on the remote control transmitter.

12 MEMORY button

This button is available when the tuner is selected. When this button is pressed, "MEMORY" flashes on the display for about 5 seconds. During this period, select a desired preset station number by pressing the **TUNER** " ^ " or " ∨ " button on the front panel (or the **PRESET** station number selector " < " or " > " button on the remote control transmitter) and press the **MEMORY** button again to enter the displayed station into the memory.

When this button is pressed and held for about 2 seconds, the automatic preset tuning begins. (Refer to page 37 for details.)

TIME ADJ

This button is also used for setting the built-in clock. (See page 25 for details.)

13 AUTO/MAN'L button

Press this button to switch the tuning mode to automatic or manual. To select the automatic tuning mode, press this button so that "AUTO" lights up on the display. To select the manual tuning mode, press this button so that "AUTO" goes off.

TIMER

This button is also used for setting the built-in timer. (See pages 49 to 50 for details.)

14 PRESET/BAND button

Whenever this button is pressed, the mode of tuner is changed to the FM band reception mode, AM band reception mode and the preset tuning mode in turn.

<For U.K. and Europe models only>

The mode of tuner is changed to the FM mode, MW mode, LW mode and the preset tuning mode in turn.

15 DISPLAY button

Used for setting the built-in clock, timer, etc. (See pages 25 and 49 to 50 for details.)

16 VIDEO 2 input terminals

Connect an auxiliary video or audio input source unit such as a camcorder to these terminals. The source connected to these terminals can be selected by the corresponding input selector button.

CONTROLS AND THEIR FUNCTIONS

17 <<< (skip)/<<< (search)

When the CD player is selected, this button is used for the skip search or the manual search (in reverse direction).

HOUR

Used to change "hour" when setting the clock or timer.

RDS MODE (for U.K. and Europe models only)

When the tuner is selected, pressing this button turns the tuner into the PTY SEEK mode.

18 >>> (search)/>>> (skip)

When the CD player is selected, this button is used for the skip search or the manual search (in advance direction).

MIN

Used to change "minute" when setting the clock or timer.

RDS START (for U.K. and Europe models only)

When the tuner is selected, press this button to begin searching for a station after the desired program type is selected in the PTY SEEK mode.

19 REPEAT button

When the CD player is selected, pressing this button turns the CD player into the single repeat play mode. (In this mode, "REP" lights up on the display.) Pressing this button again changes into the full repeat play mode (In this mode, "F REP" lights up on the display.), and pressing once more cancels the repeat play mode.

FREQ PS/PTY/RT/CT (for U.K. and Europe models only)

When an RDS station is received, pressing this button changes the display mode into the PS mode, PTY mode, RT mode and/or CT mode (if the station employs those RDS data services), and frequency display in turn.

Open and close the control door

When it is not necessary to operate controls inside the control door, close the door.

To open the door

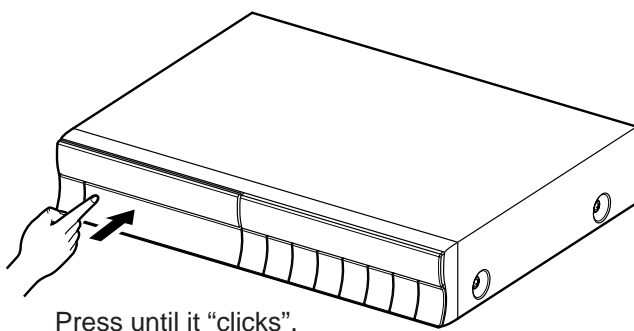

To close the door

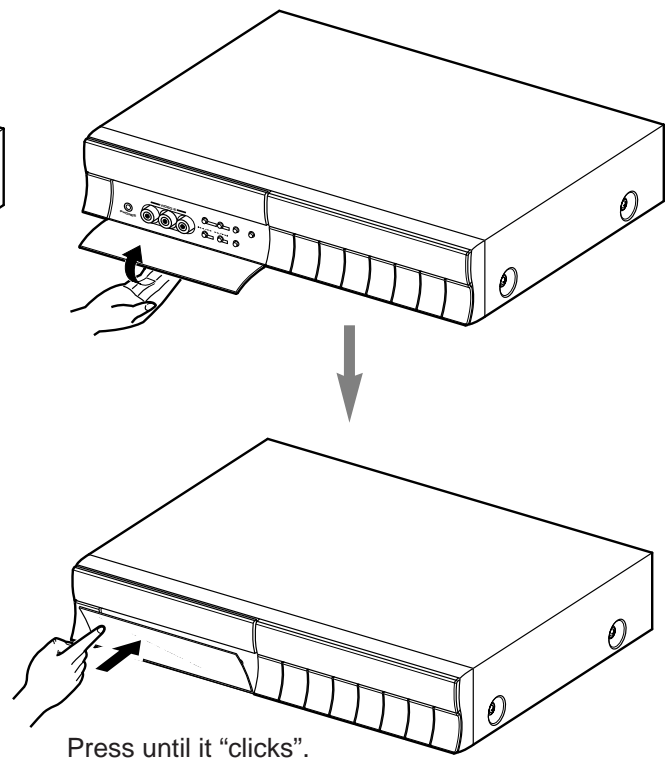

DISPLAY PANEL

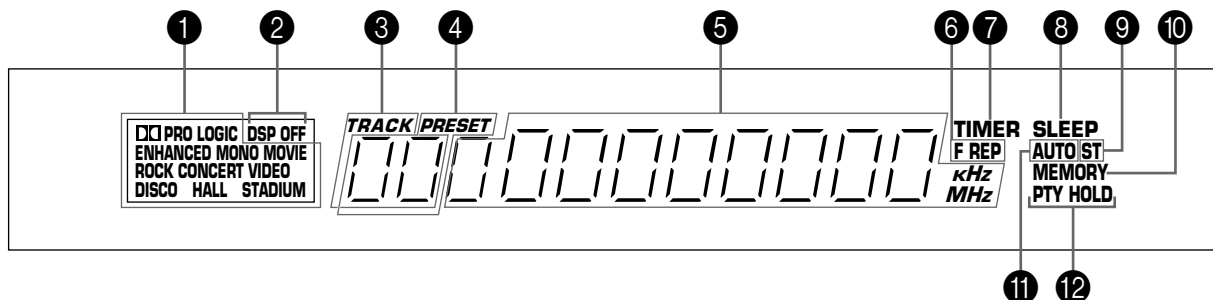

1 DSP program indicators

The name of a selected DSP program lights up when the built-in digital sound field processor and/or the Dolby Pro Logic Surround decoder is on.

2 DSP OFF indicator

Lights up if neither the digital sound field processor nor the Dolby Pro Logic Surround decoder is on. In this state, sound output is 2-channel stereo.

3 Track number indicator

When the CD player is selected, the currently selected track number is shown here.

4 Preset number indicator

When the tuner is selected and it is in the preset tuning mode, the currently selected preset number is shown here.

5 Multi-information display

Displays various information, for example station frequency, playing time of compact disc and name of selected input source.

6 (F) REP indicator

When the CD player is selected and it is in the single repeat play mode, "REP" lights up. When the CD player is in the full repeat play mode, "F REP" lights up.

7 TIMER indicator

Lights up while the built-in timer is functioning.

8 SLEEP indicator

Lights up while the built-in SLEEP timer is functioning.

9 ST indicator

Lights up when an FM stereo broadcast with sufficient signal strength is received.

10 MEMORY indicator

When the **MEMORY** button is pressed, this indicator flashes for about 5 seconds. During this period, the displayed station can be programmed to the memory by selecting a desired preset station number and then pressing the **MEMORY** button again.

11 AUTO indicator

Lights up when the tuner is in the automatic tuning mode.

12 PTY HOLD indicator (for U.K. and Europe models only)

Lights up while the search is performed in the PTY SEEK mode.

REMOTE CONTROL TRANSMITTER

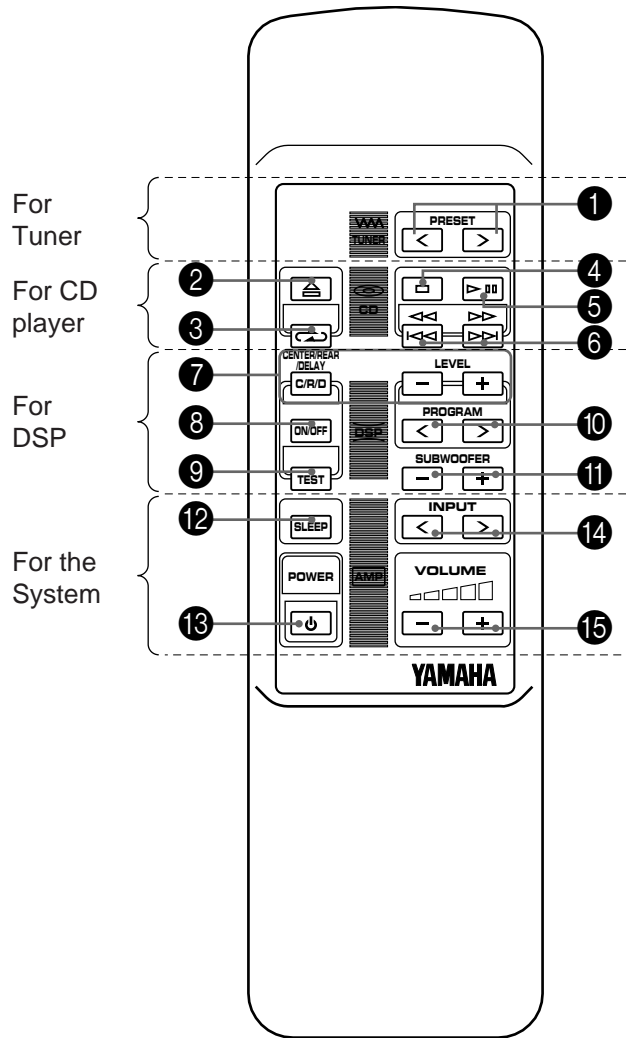

For tuner

1 PRESET station number selector (< / >) buttons

Controls tuner.

- < : Selects lower preset station number.
- > : Selects higher preset station number.

If the tuner is not selected as the input source, pressing one of these buttons selects the tuner, and then selects a preset station number.

If this system is in the standby mode, pressing one of these buttons turns this system on, and then operates in the same way.

For CD player

2 Open/close (\triangle) button

Opens and closes the disc tray.

3 Repeat (\curvearrowright) button

Pressing this button turns the CD player into the single repeat play mode. (In this mode, "REP" lights up on the display.)

Pressing this button again changes into the full repeat play mode (In this mode, "F REP" lights up on the display.), and pressing once more cancels the repeat play mode.

CONTROLS AND THEIR FUNCTIONS

4 Stop (□) button

Stops playing back the disc.

If the CD player is not selected as the input source, pressing this button selects the CD player with the CD player stopped.

If this system is in the standby mode, pressing this button turns this system on, and then operates in the same way.

5 Play/pause (>/⏸) button

Pressing this button starts playing back a disc.

Pressing this button again pauses the playback, and pressing it once more resumes the playback.

If the CD player is not selected as the input source, pressing this button selects the CD player and starts playing back a disc.

If this system is in the standby mode, pressing this button turns this system on, and then operates in the same way.

6 Skip (search) ⏮ (<<)/⏭ (>>) buttons

Used for the skip search or the manual search.

For DSP

7 CENTER/REAR/DELAY and LEVEL (+/-) buttons

Adjust the center channel output level (CENTER), the rear channel output level (REAR) and the delay time (DELAY).

Select the item which you want to adjust by pressing the **CENTER/REAR/DELAY** button and adjust its level or time by pressing the **LEVEL (+/-)** button.

8 DSP ON/OFF button

Switches on/off the digital sound field processor (including the Dolby Pro Logic Surround decoder).

9 TEST button

Used for speaker balance adjustment. (For details, refer to pages 26 to 27.)

10 PROGRAM selector (< / >) buttons

When the built-in digital sound field processor (including the Dolby Pro Logic Surround decoder) is on, whenever the “<” or “>” button is pressed, the currently selected DSP program is changed in turn. The name of selected program lights up on the display.

11 SUBWOOFER level (+/-) buttons

Pressing the “+” button raises and pressing the “-” button lowers the output level to the subwoofer (SW-AV1).

For the system

12 SLEEP button

This button is used to turn the built-in SLEEP timer on and off, and to set the SLEEP time. (See page 51 for details.)

13 POWER switch

Turns the power to this system on and turns this system in the standby mode alternately.

14 INPUT selector (< / >) buttons

Whenever the “<” or “>” button is pressed, the currently selected input source is changed in turn. The name of selected input source is shown on the display.

15 VOLUME (+/-) buttons

Pressing the “+” button raises and pressing the “-” button lowers the volume of whole sound output of this system.

TURNING THE POWER TO THIS SYSTEM ON OR IN THE STANDBY MODE

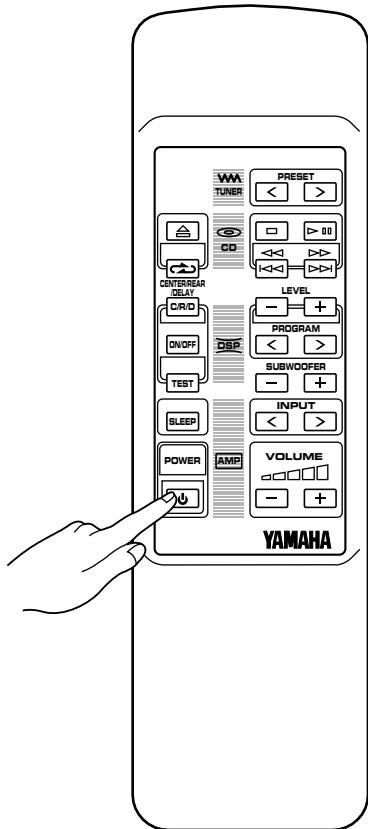
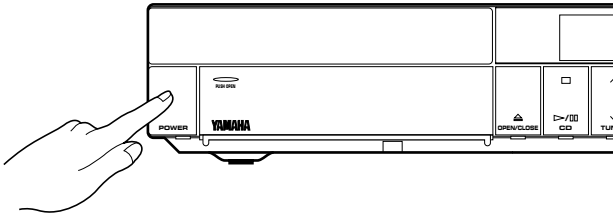

If the AC supply lead is connected to the AC outlet, this system can be turned on and turned into the standby mode by pressing the **POWER** switch on the front panel of the main control unit or the **POWER** switch on the remote control transmitter.

- While the power is on, the display on the main control unit shows the name of currently selected input source or other information. In the standby mode, the display shows only the time.

Automatic function to turn the system into the standby mode

The power of this system will be automatically turned into the standby mode if there is no operation on the control parts of this system, and no playback of CD for about 30 minutes.

- * This function is not available unless time setting is made on the built-in clock.

Direct input source selection

When this system is in the standby mode, pressing an input selector button will turn the power on and select the corresponding input source.

Standby mode

While the power is on, pressing the **POWER** switch (or the **POWER** switch on the remote control transmitter) switches the system to the Standby mode. (In this mode, the display shows only the time.) In this mode, main voltage is still present inside the system. If you want to switch off the system completely, disconnect the AC power plug from the AC outlet.

ADJUSTMENTS BEFORE LISTENING OPERATIONS

SETTING THE CLOCK

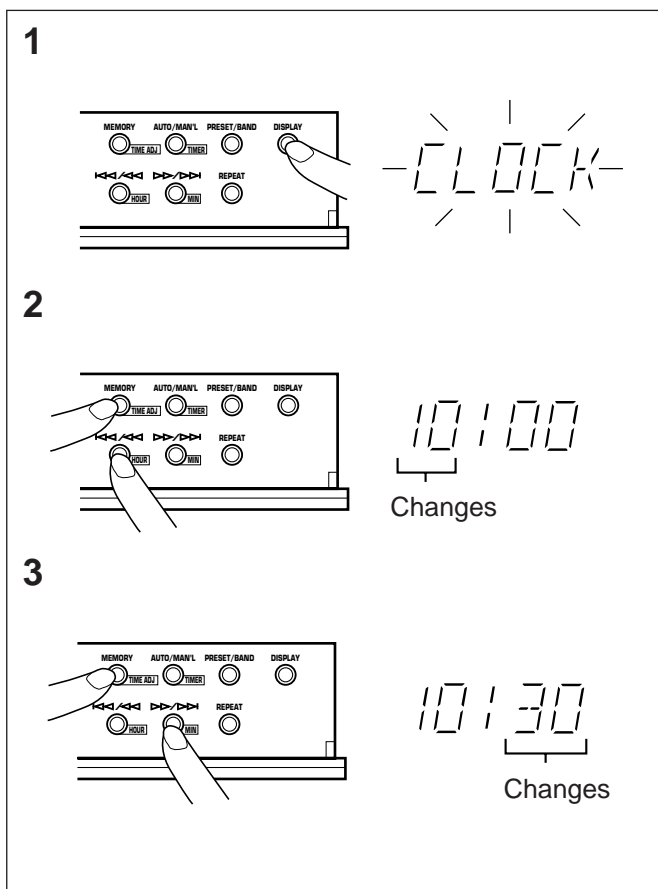

- 1 While the power is on, press the **DISPLAY** button to display the time. If this system is in the standby mode, you can proceed to the next step.
- 2 While holding the **TIME ADJ** button pressed, press the **HOUR** button and set the hour.
 - * Press the **HOUR** button once to advance the time by 1 hour. Press and hold to advance continuously.
- 3 While holding the **TIME ADJ** button pressed, press the **MIN** button and set the minute.
 - * Press the **MIN** button once to advance the time by 1 minute. Press and hold to advance continuously.
 - * The hour setting will not advance even if minute is advanced from "59" to "00".

Europe, U.K., Australia and Singapore models use a 24-hour display. U.S.A. and Canada models use a 12-hour display shown by "AM (PM) 12:00". For General model, either the 24-hour display or the 12-hour display is selected depending on the setting of the **FREQUENCY STEP** switch on the rear panel, so you cannot select a desired type freely.

In the event of a power failure or when the AC supply lead is disconnected.

The time display will go out, however, the clock will function for about 5 minutes without power supply. So you do not have to reset the time if the AC power supply is resumed within about 5 minutes.

When the AC power supply is resumed after more than 5 minutes pass without power supply, the time display will flash on and off to indicate that the time must be reset.

ADJUSTING BRIGHTNESS OF THE DISPLAY

If desired, you can adjust brightness of the display.

- 1 Press and hold the **DISPLAY** button for more than 2 seconds so that "DIMMER±0" appears on the display.
- 2 Holding the **DISPLAY** button pressed, press the "▶▶ / ▶▶" button once or more to increase or press the "◀◀ / ◀◀" button once or more to decrease brightness.

This adjustment can be made even though this system is in the standby mode.

Control range

When the power is on: ±0 to -6 (Preset value: ±0)
 In the standby mode: +3 to -3 (Preset value: ±0)

SPEAKER BALANCE ADJUSTMENT

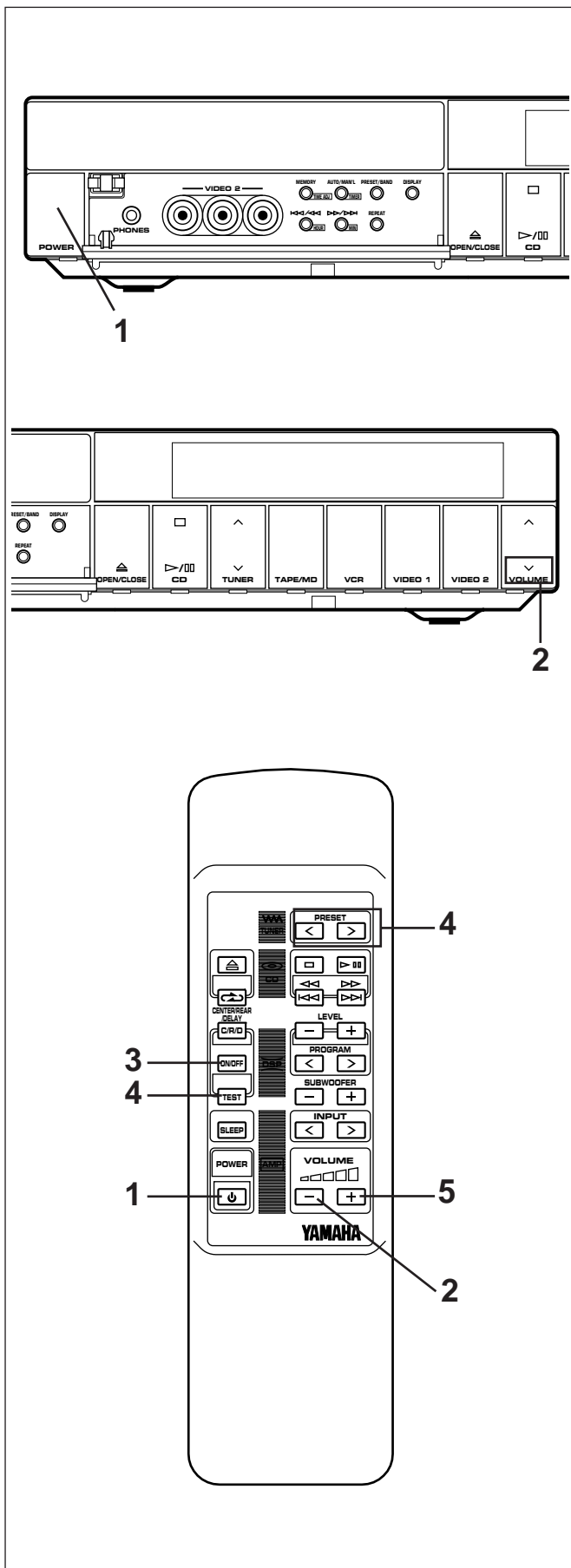

This procedure lets you adjust the sound output level balance between the front, center, and rear speakers using the built-in test tone generator. When this adjustment is performed, the sound output level heard at the listening position will be the same from each speaker. This is important for the best performance of the built-in Dolby Pro Logic surround decoder. **The adjustment of each speaker output level should be done at your listening position with the remote control transmitter. Otherwise, the result may not be satisfactory.**

- 1 Press the **POWER** switch to turn the power on.
- 2 Press the **VOLUME** “-” (or “∨”) button to decrease the volume to minimum until “MIN” is shown on the display.
- 3 If no DSP program name is illuminated on the display, press the **DSP ON/OFF** button so that a name of program lights up on the display.
- 4 Press the **TEST** button.
* “TEST” appears on the display.
- 5 Press the **VOLUME** “+” button to increase the volume.
* Volume level is shown on the display.

You will hear a test tone (like pink noise) from the left front speaker, then the center speaker, then the right front speaker, and then the rear speakers, for about two seconds each. The display changes as shown below.

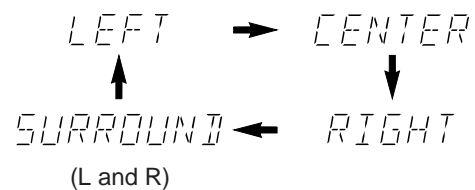

* The test tone from the left rear speaker and the right rear speaker will be heard at the same time.

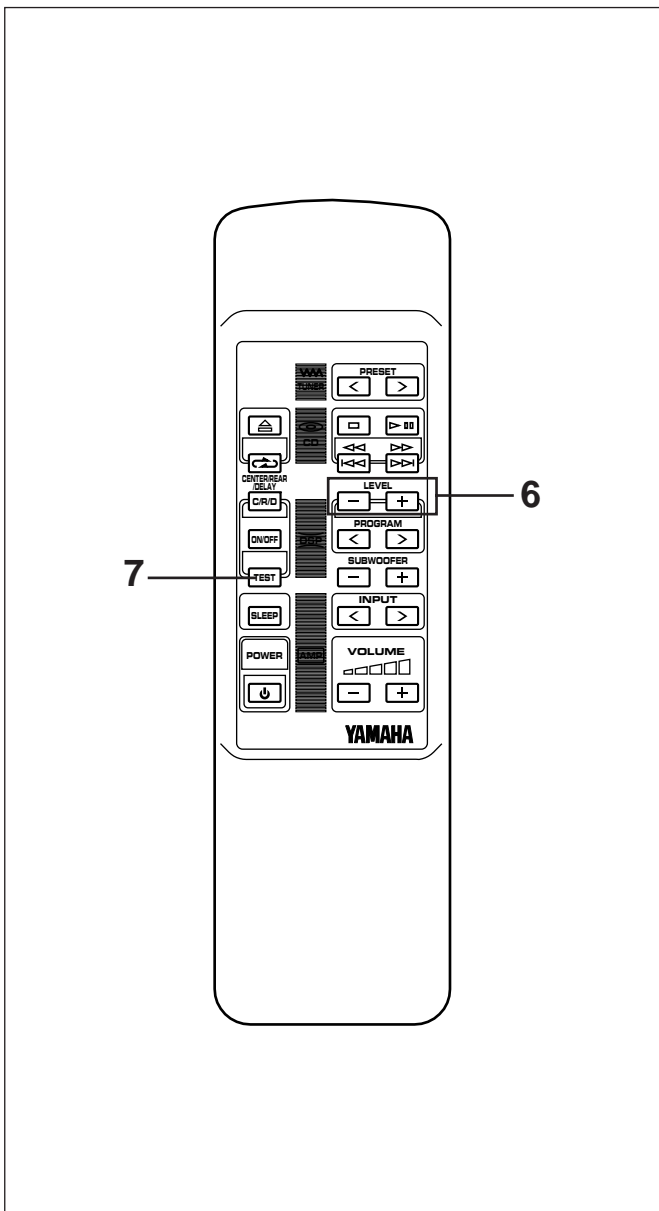

6 Adjust the sound output levels of the center speaker and the rear speakers by using the **LEVEL +/-** buttons so that they become almost as same as that of the front speakers.

- When the test tone is output from the center speaker, pressing the **LEVEL +** or **-** button changes the output level of the center speaker.

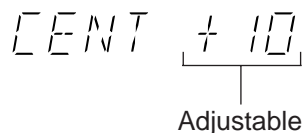

- When the test tone is output from the rear speakers, pressing the **LEVEL +** or **-** button changes the output level of the rear speakers.

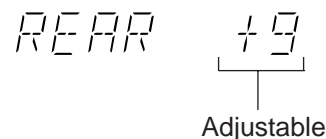

- * Pressing the **“+”** button raises and the **“-”** button lowers the level.
- * You can adjust the subwoofer output level by pressing the **SUBWOOFER** level **+** or **-** button only when the test tone is output from the left front, center or right front speaker.

7 If the adjustments have finished, press the **TEST** button to cancel the test tone.

- * **“TEST”** disappears from the display.

Note

Once you have completed these adjustments, you can adjust whole sound level on this system by using the **VOLUME** button (or the **VOLUME** buttons on the remote control transmitter) only.

BASIC LISTENING OPERATIONS

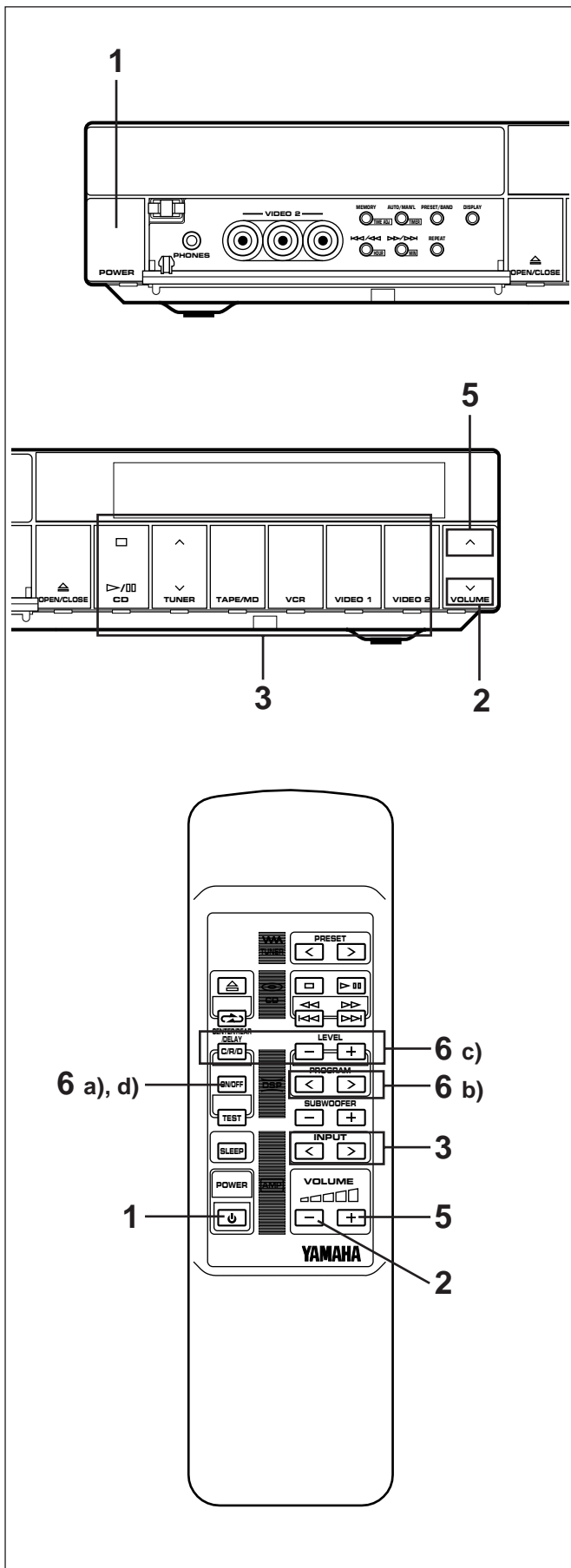

When you have completed all connections and adjustments before listening operations, begin listening to a source on this system.

- 1 Press the **POWER** switch to turn the power on.
* When the power is on, the display on the main control unit shows the name of currently selected input source or other information.
- 2 Press the **VOLUME** “∨” (or “-”) button to decrease the volume to minimum until “MIN” is shown on the display.
- 3 Select a source which you want to listen to or watch by pressing the corresponding input selector button.
* The name of selected input source is shown on the display.
- 4 Play the source.

- To play a CD on the built-in CD player, see pages 30 to 32.
 - To listen to a radio program on the built-in tuner, see pages 33 to 37.
 - To play a source on an external audio/video unit connected to this system, see page 44.
- 5 Press the **VOLUME** “∧” (or “+”) button to increase the volume.
* Volume level is shown on the display.
- 6 If you prefer, use the built-in digital sound field processor including the Dolby Pro Logic Surround decoder.

- a) Press the DSP **ON/OFF** button so that a name of DSP program appears on the display.

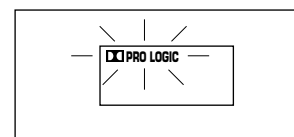

- b) Select a desired program by pressing the **PROGRAM** selector “<” or “>” button.
(See page 45 for descriptions about programs.)
- c) According as you prefer, adjust the delay time, the center speaker output level and/or the rear speaker output level. (See pages 47 to 48 for details.)
- d) To switch off the digital sound field processor;
Press the DSP **ON/OFF** button.
* Sound output becomes 2-channel stereo.

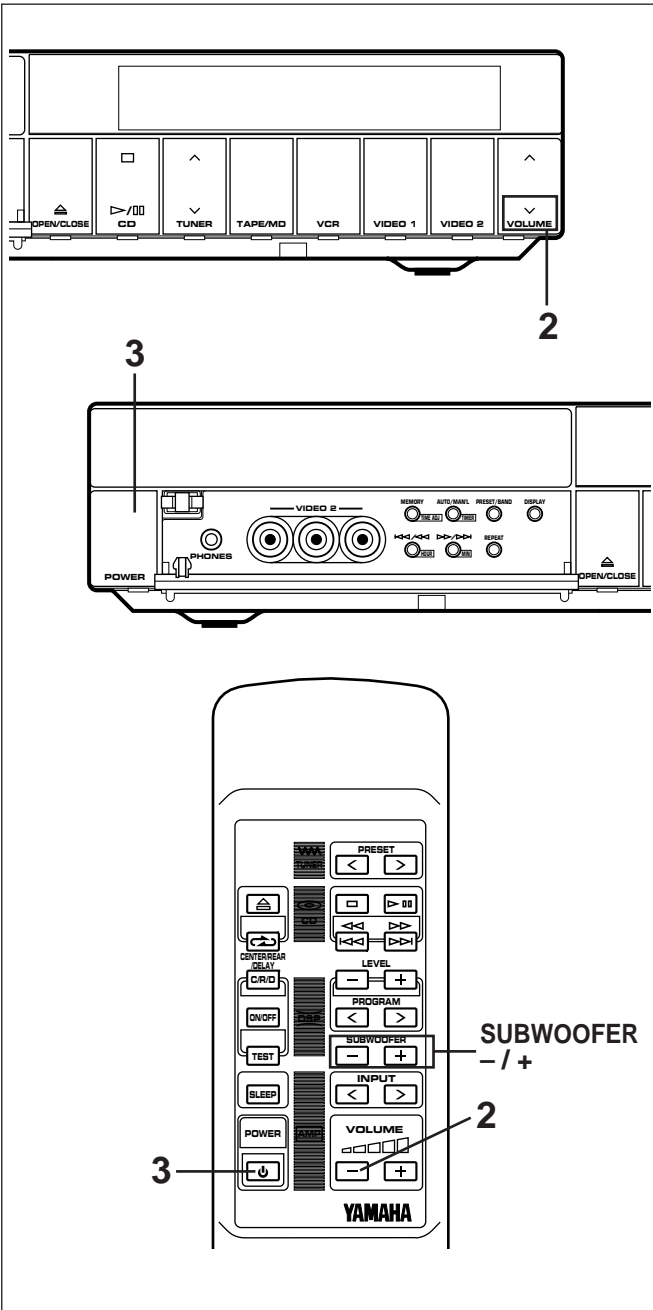

To finish listening to a source

- 1 Stop playing a source.
- 2 Press the **VOLUME** “ ∨ ” (or “-”) button to decrease the volume to minimum until “MIN” is shown on the display.
- 3 Press the **POWER** switch to turn this system into the standby mode.
 - * In this mode, only the time is shown on the display.

Adjusting the subwoofer output level

According as you prefer, adjust the subwoofer output level by pressing the **SUBWOOFER** level + (up) or – (down) button.

If you feel that bass tone is insufficient, increase the level, and if you feel that bass tone is overly emphasized, decrease the level.

Listening with headphones

- Be sure that your headphones have a 3.5 mm (1/8”) diameter plug and are between 16 ohms and 50 ohms impedance. Recommended impedance is 32 ohms.
- When you listen with headphones, connect the headphones to the **PHONES** jack. You can listen to the sound to be output from the front speakers through headphones. When listening with headphones privately, switch off the digital sound field processor (so that no DSP program name is illuminated on the display) by pressing the **DSP ON/OFF** button on the remote control transmitter. Adjust the **VOLUME** buttons for desired volume.

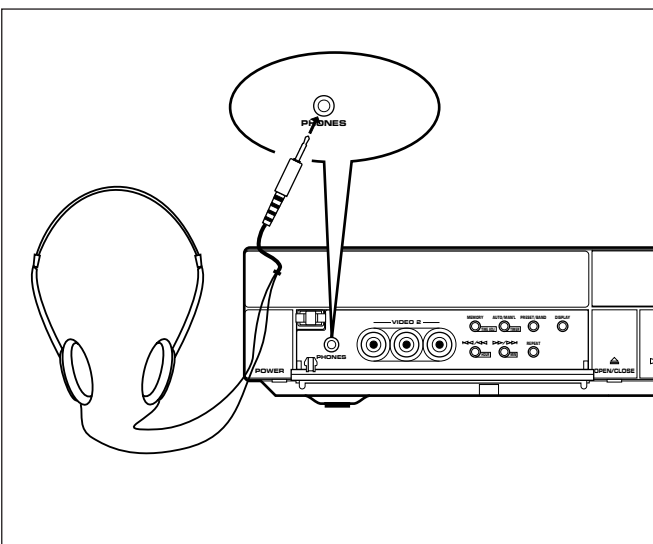

COMPACT DISC PLAYER OPERATION

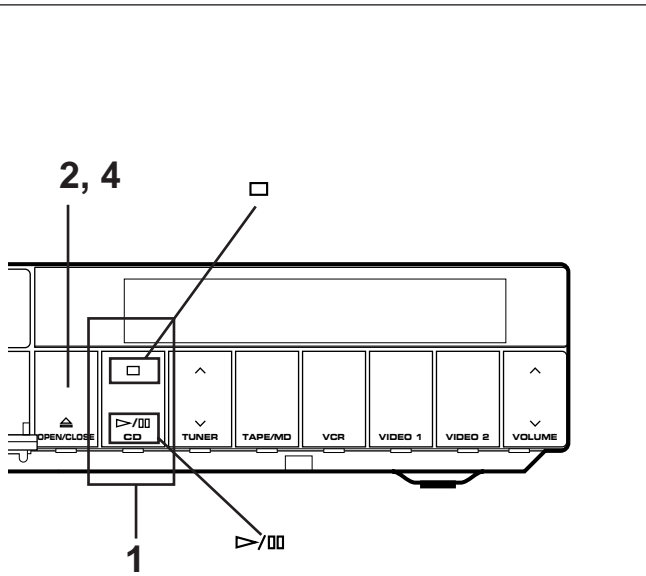

CD playback

- 1 Press the CD input selector button.
- 2 Press the **OPEN/CLOSE** button to open the disc tray.
- 3 Place a disc on the tray, label side up.
* 8 cm (3") disc may be played without an adaptor.

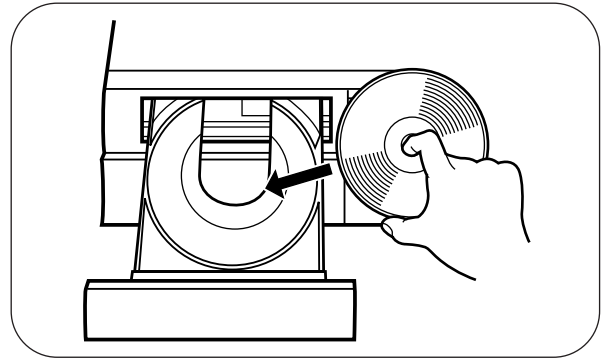

- 4 Press the **OPEN/CLOSE** button to close the disc tray.
* The total number of tracks and the total playing time of the disc are displayed for several seconds.

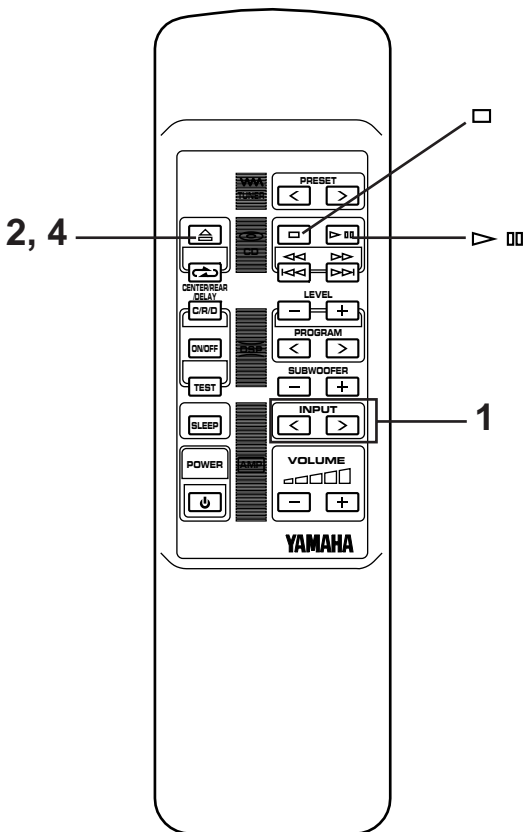
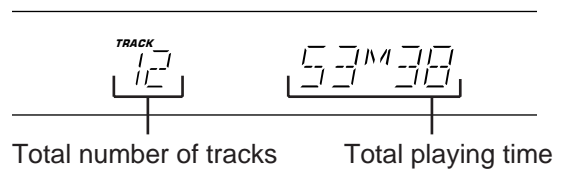

- 5 Press ">/00" to start playback from track 1.

To interrupt playback

- 1 Press ">/00".
- 2 Press ">/00" again to resume playback from the same point.

To stop playback

Press "□".

LISTENING TO A COMPACT DISC

Direct operation

When this system is in the standby mode, pressing the CD input selector button will turn the power on and start CD playback automatically.

* In this way, however, the display will not show the total number of tracks and the total playing time of the disc.

Precautions

- If TV or radio interference occurs during CD player operation, move the unit away from the TV or radio.
- Subjecting the unit to shock or vibration can cause mistracking.
- Playing back some compact discs at high volume can cause mistracking. In this case, listen at lower volume.
- Do not pull open the disc tray forcibly with your hands.
- Do not push the disc tray while it is moving.
- If the power fails while the tray is open, wait until the power supply returns or gently push the tray manually to close it.
- The temperature range for playing back compact discs is recommended to be 5°C (41°F) – 35°C (95°F).

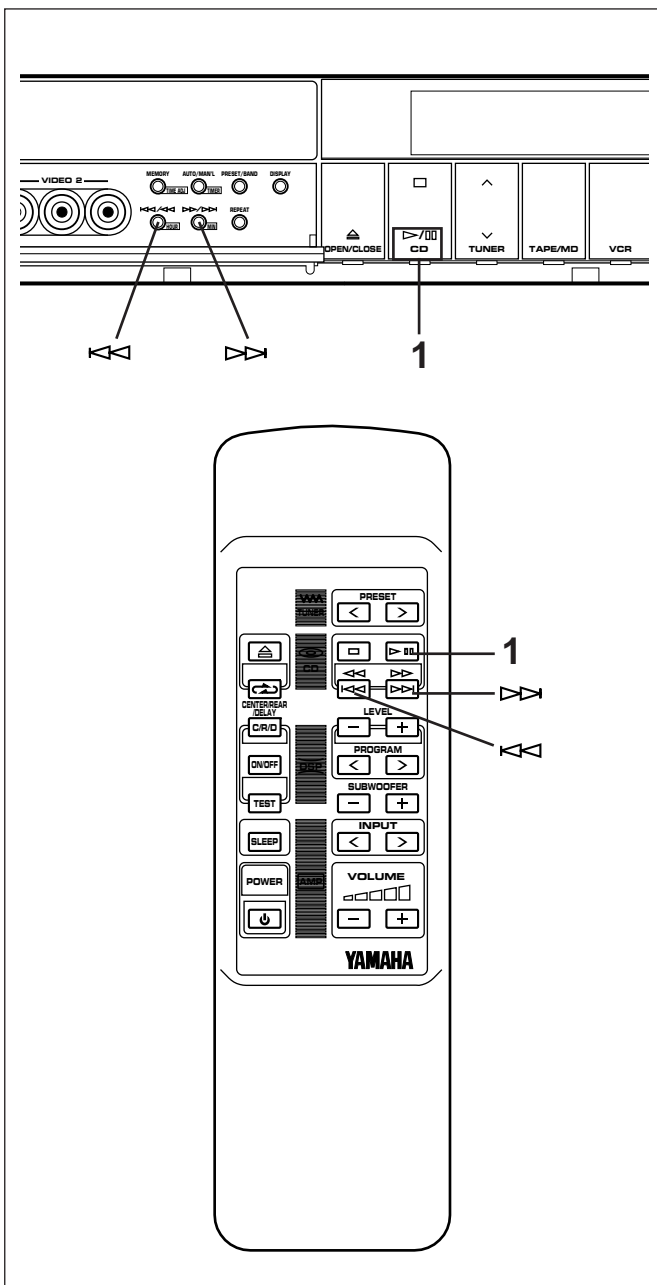

To play a desired track on the disc (Skip search)

The beginning of any track can be found automatically.

- 1 Begin playback.
- 2 Press the >>> button to advance or <<< button to reverse through the disc. Press once for each track to be advanced or reversed.
 - Press >>> once to advance to the track following the one now playing back.
 - Press <<< once to return to the start of the track now playing back.
 - Press <<< twice to return to the track before the track now playing back.

Notes

- This function can also be performed while the unit is stopped. Press ">/00" when your desired track number appears on the track number display. Playback will begin from the beginning of the track.
- This function will be performed forward or backward from any point on the disc. However, it will not move forward during playback of the final track.

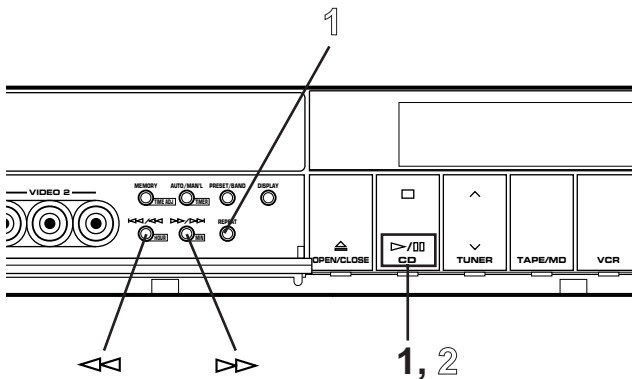

To advance or reverse play rapidly (Manual search)

- 1 Begin playback.
- 2 Press and hold the button to advance playback rapidly, and the button to reverse playback rapidly.
 - * The sound can be heard (although slightly garbled) during manual search in either direction. This is convenient for reviewing the contents quickly.

Note

Manual search can also be performed while playback is paused, though no sound will be heard.

Repeat play

A single track or an entire disc can be continuously repeated.

Repeat play modes

Single repeat ("REP" lights up on the display.)

A selected single track is played back repeatedly.

Full repeat ("F REP" lights up on the display.)

An entire disc is played back repeatedly.

- 1 Press the **REPEAT** button once or more to select the single repeat play mode (REP) or the full repeat play mode (F REP) confirming it on the display.

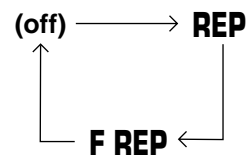

- 2 Press "".

To cancel the repeat play

Press the **REPEAT** button once or more so that both "REP" and "F REP" go off from the display.

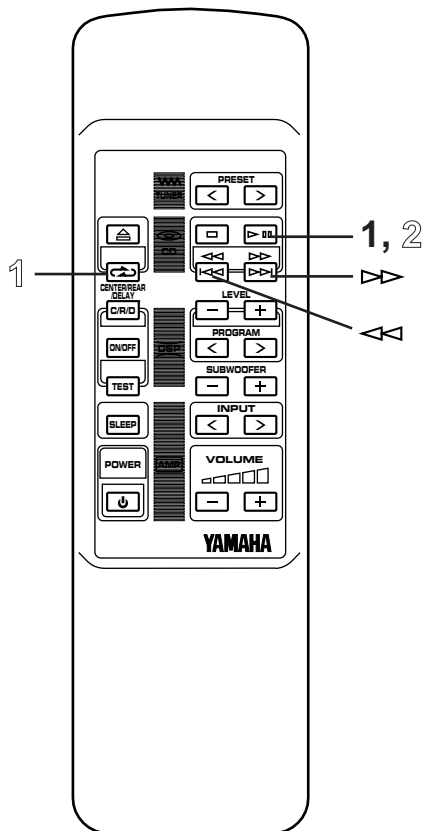

TUNING OPERATION

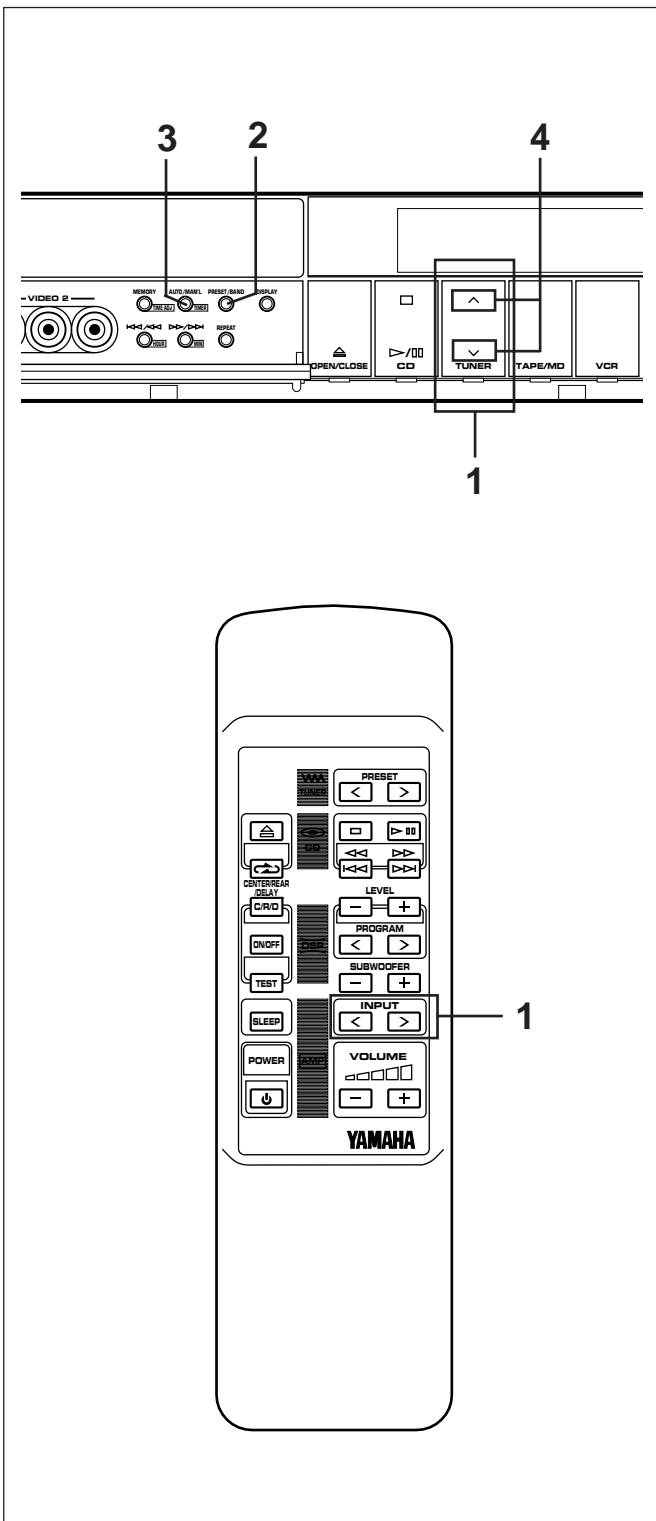

Normally, if station signals are strong and there is no interference, quick automatic-search tuning (Automatic tuning) is possible. However, if signals of the station you want to select are weak, you must tune to it manually (Manual tuning).

Automatic tuning

- 1 Select the built-in tuner as the input source by pressing the **TUNER** input selector button.
- 2 Select the reception band [FM or AM (MW or LW)] by pressing the **PRESET/BAND** button confirming it on the display.

<Except U.K. and Europe models>

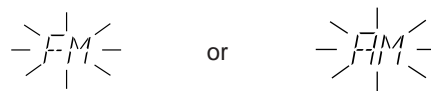

<U.K. and Europe models>

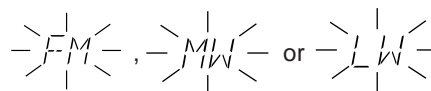

* Do not select a preset tuning mode (Do not select the mode in which "PRESET" lights up on the display.)

- 3 Press the **AUTO/MAN'L** button so that "AUTO" appears on the display.

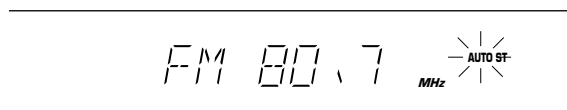

(In this mode, stations are received in stereo or monaural automatically.)

- 4 Press " ^ " to tune to a higher frequency, or press " v " to tune to a lower frequency.
- 5 If the station where tuning search stopped is not the desired one, follow step 4 again.

* If the tuning search does not stop at the desired station, change to the Manual tuning method as described on the next page.
 * ST (Stereo) indicator will light up when an FM stereo broadcast with sufficient signal strength is received.

"AM" is for U.S.A., Canada, Australia, Singapore and General models.
 "MW/LW" is for U.K. and Europe models.

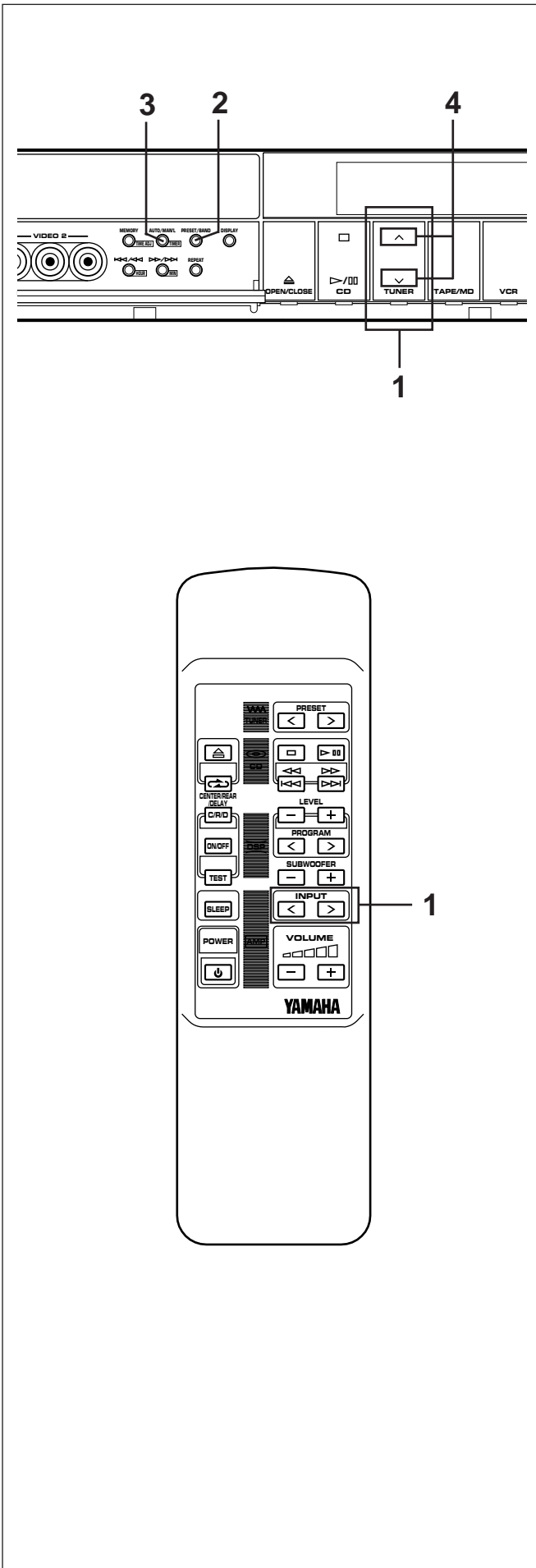

Manual tuning

- 1 If the built-in tuner is not selected as the input source, press the **TUNER** input selector button.
- 2 Select the reception band [FM or AM (MW or LW)] by pressing the **PRESET/BAND** button confirming it on the display.

<Except U.K. and Europe models>

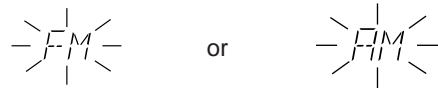

<U.K. and Europe models>



- * Do not select a preset tuning mode (Do not select the mode in which "PRESET" lights up on the display.)

- 3 Press the **AUTO/MAN'L** button so that "AUTO" disappears from the display.
(In this mode, stations are received in monaural.)
- 4 Press and hold "**^**" to tune to a higher frequency, or press and hold "**v**" to tune to a lower frequency. Release it just before reaching the desired frequency, and then press it repeatedly until the desired frequency appears.

Note

If you tune in to an FM station with the manual tuning method, it is received in monaural automatically to increase the signal quality.

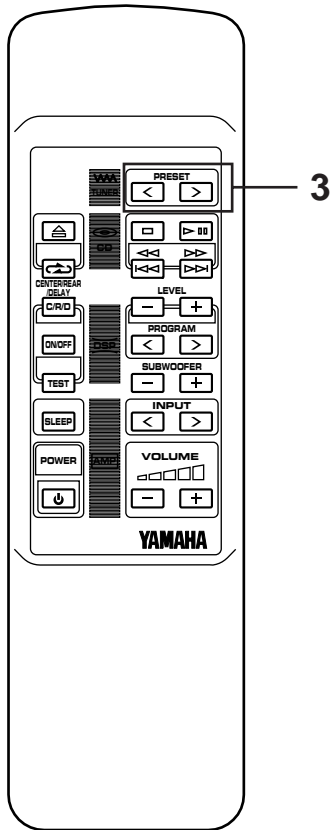
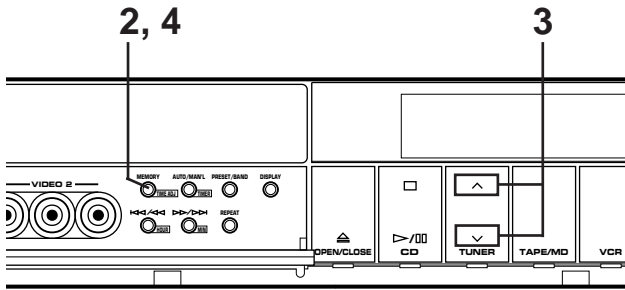

40 preset station numbers

		Number							
		1	2	3	4	5	6	7	8
Group	A	A1	A2	A3	A4	A5	A6	A7	A8
	B	B1	B2	B3	B4	B5	B6	B7	B8
	C	C1	C2	C3	C4	C5	C6	C7	C8
	D	D1	D2	D3	D4	D5	D6	D7	D8
	E	E1	E2	E3	E4	E5	E6	E7	E8

Preset tuning

This unit can store station frequencies selected by tuning operation. With this function, you can select any desired station by only calling the corresponding preset station number. Up to 40 stations (8 stations x 5 groups) can be stored.

To store stations

(Example: To store a station to the preset station number A1)

- 1 Tune in to a desired station.
(Refer to pages 33 to 34 for tuning procedure.)
- 2 Press the **MEMORY** button.
* "MEMORY" and "PRESET" will flash on the display for about 5 seconds.

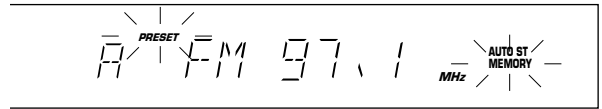

- 3 Select a preset station number by pressing the **TUNER** " ^ " or " v " button on the front panel (or the **PRESET** station number selector " < " or " > " button on the remote control transmitter) repeatedly before "MEMORY" goes out.
* Holding a button pressed will change the group (A, B, C, D, E) of preset station numbers in turn.

(In this case, select "A1".)

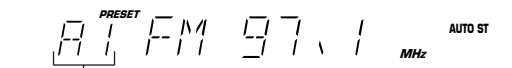

Changes.

- 4 Within about 5 seconds, press the **MEMORY** button again.

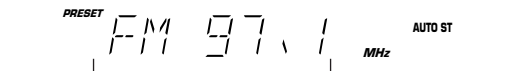

The currently displayed station has been programmed to A1.

- 5 In the same way, program other stations to the preset station number A2, A3... A8, B1, B2...C1....

LISTENING TO A RADIO PROGRAM

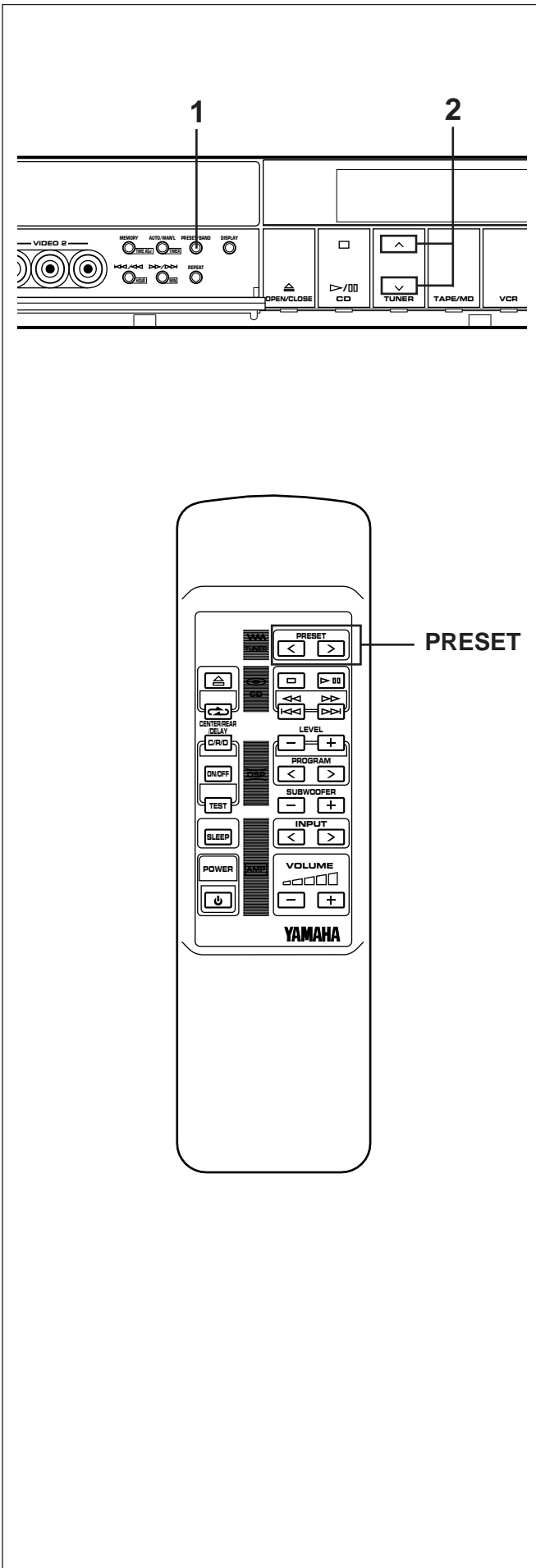

To recall a preset station

On the remote control transmitter:

Select the desired preset station number by pressing the **PRESET** station number selector “<” or “>” button.

On the front panel:

- 1 If “PRESET” is not illuminated on the display, press the **PRESET/BAND** button once or more so that “PRESET” lights up on the display.
- 2 Select the desired preset station number by pressing the **TUNER** “v” or “^” button.

Notes

- A new setting can be programmed in place of the former one.
- For every preset station, the setting of the **AUTO/MAN'L** button is stored along with the station frequency.

Memory back-up

The memory back-up circuit prevents the programmed data from being lost even if the AC supply lead is disconnected from the AC outlet or the power is cut due to temporary power failure. If, however, the power is cut for more than one week, the memory may be erased. If so, it can be re-programmed by simply following the Preset tuning steps.

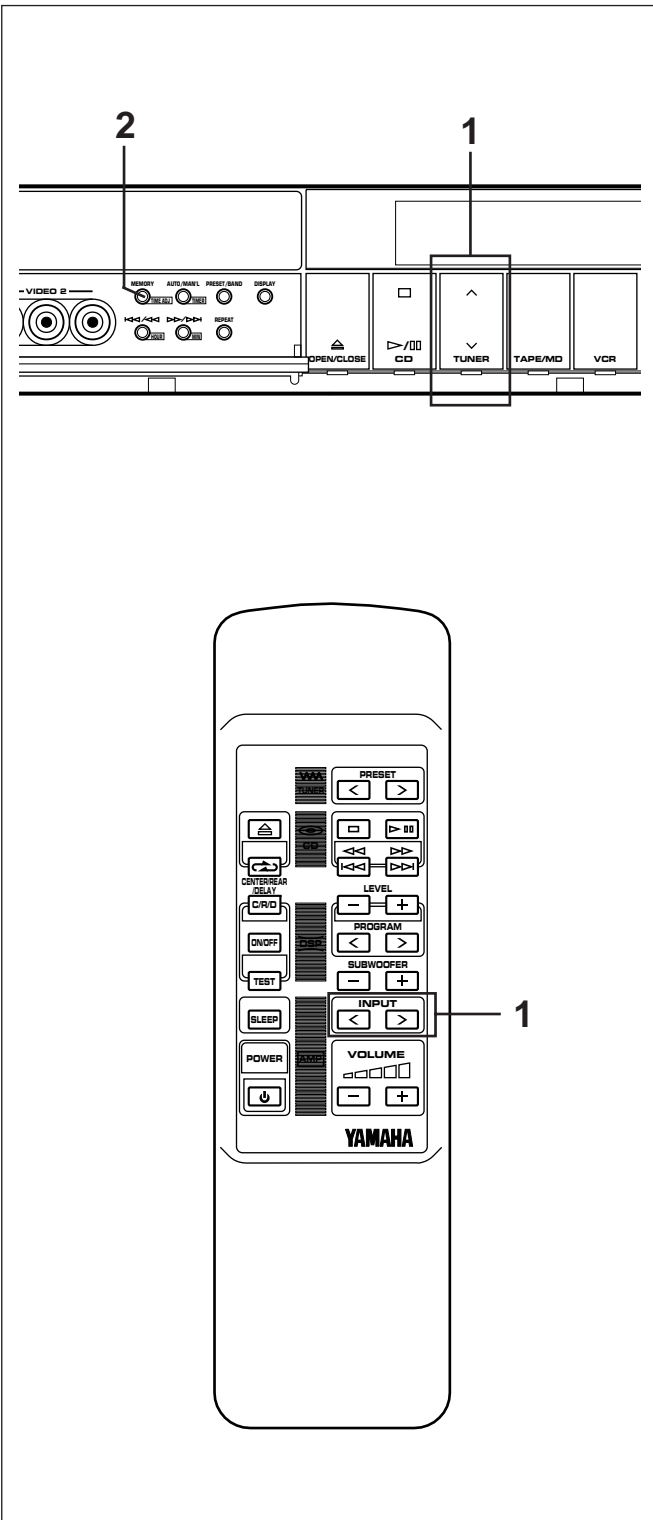

Automatic preset tuning

You can also make use of an automatic preset tuning function. By this function, this tuner performs automatic tuning and stores stations with strong signals sequentially. Up to 40 stations are stored automatically in the same way as in the manual preset tuning method on page 35.

- 1 Select the built-in tuner as the input source by pressing the **TUNER** input selector button.
- 2 Press and hold the **MEMORY** button for about 2 seconds.
 * "MEMORY" and "AUTO" will flash.

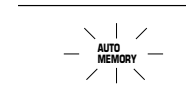

This tuner performs automatic tuning and searches FM and AM (MW and LW for U.K. and Europe models only) stations in that order. Received stations are programmed to the preset station number A1, A2, A3... A8, B1... sequentially.

When the automatic preset tuning is completed

The display shows the frequencies of the first preset station (stored to A1). Check the contents and the number of preset stations by following the procedure of the section "To recall a preset station" on the previous page.

To recall a preset station

Simply follow the procedure of the section "To recall a preset station" on the previous page.

Notes

- The automatic preset tuning search will be performed through all frequencies until 40 stations are stored. If the number of received stations is less than 40, the search will stop after searching all frequencies.
 * Since FM stations are searched for first, there may be a case that 40 preset stations are occupied by FM stations only.
- With this function, only stations with sufficient signal strength are stored automatically. If the station you want to program is weak in signal strength, tune in to it with the Manual tuning method (in monaural) and program it by following the procedure of the section "To store stations" on page 35.
- You can replace a preset station by another FM or AM (MW or LW) station manually by simply following the procedure of the section "To store stations" on page 35.
- **<For U.K. and Europe models only>**
 This tuner is originally set so that only RDS stations are searched instead of all FM stations by this operation. (FM stations that employ no RDS network service cannot be programmed.) However, you can change the setting so that the unit can program not only RDS stations but also other FM stations. (Refer to page 43 for details.)

RECEIVING RDS STATIONS <U.K. and Europe models only>

RDS (Radio Data System) is a data transmission system gradually being introduced by FM stations in many countries. Stations using this system transmit an inaudible stream of data in addition to the normal radio signal. RDS data contains various information, such as PI (Program Identification), PS (Program Service name), PTY (Program Type), RT (Radio Text), CT (Clock Time), etc.

RDS function is carried out among the network stations.

* This unit utilizes PS, PTY, RT and CT to receive RDS broadcast stations.

Displaying RDS data

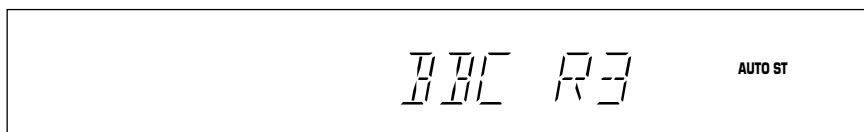

This unit can be turned into the following four modes to display RDS data.

PS (Program Service name) mode:

Displays the name of the RDS station now being received instead of the frequency.

PTY (Program Type) mode:

Displays the type of the program on the RDS station now being received. There are 15 program types to classify RDS stations as shown on the next page.

RT (Radio Text) mode:

Displays information about the program (such as title of the song, name of the singer, etc.) on the RDS station now being received.

CT (Clock Time) mode:

Displays current time. This signal comes from the RDS station now being received. Time of the built-in clock can be automatically corrected on the basis of this signal.

■ Program types in the PTY mode

- NEWS** **News:**
Short accounts of facts, events and publicly expressed views, reportage and actuality.

- AFFAIRS** **Current affairs:**
Topical program expanding or enlarging upon the news, generally in different presentation style or concept, including documentary debate, or analysis

- INFO** **Information:**
Program whose purpose is to impart advice in the widest sense, including meteorological reports and forecasts, consumer affairs, medical help, etc.

- SPORT** **Sport:**
Program concerned with any aspect of sport.

- EDUCATE** **Education:**
Program intended primarily to educate, of which the formal element is fundamental.

- DRAMA** **Drama:**
All radio plays and serials.

- CULTURE** **Culture:**
Programs concerned with any aspect of national or regional culture, including religious affairs, philosophy, social science, language, theatre, etc.

- SCIENCE** **Science:**
Programs about the natural sciences and technology.

- VARIED** **Varied:**
Used for mainly speech-based programs usually of light-entertainment nature, not covered by above categories. Examples are: quizzes, panel games, personality interviews, comedy and satire.

- POP M** **Pop:**
Commercial music, which would generally be considered to be of current popular appeal, often featuring in current or recent record sales charts.

- ROCK M** **Rock:**
Contemporary modern music, usually written and performed by young musicians.

- M.O.R. M** **M.O.R.:**
(Middle of the Road Music). Common term to describe music considered to be "easy-listening", as opposed to Pop, Rock or Classical. Music in this category is often but not always, vocal, and usually of short duration (<5 min.)

- LIGHT M** **Light classics:**
Classical Musical for general, rather than specialist appreciation. Examples of music in this category are instrumental music, and vocal or choral works.

- CLASSICS** **Serious classics:**
Performances of major orchestral works, symphonies, chamber music etc., and including Grand Opera.

- OTHER M** **Other music:**
Musical styles not fitting into any of the above categories. Particularly used for specialist music, of which Jazz, Rhythm & Blues, Folk, Country, and Reggae are examples.

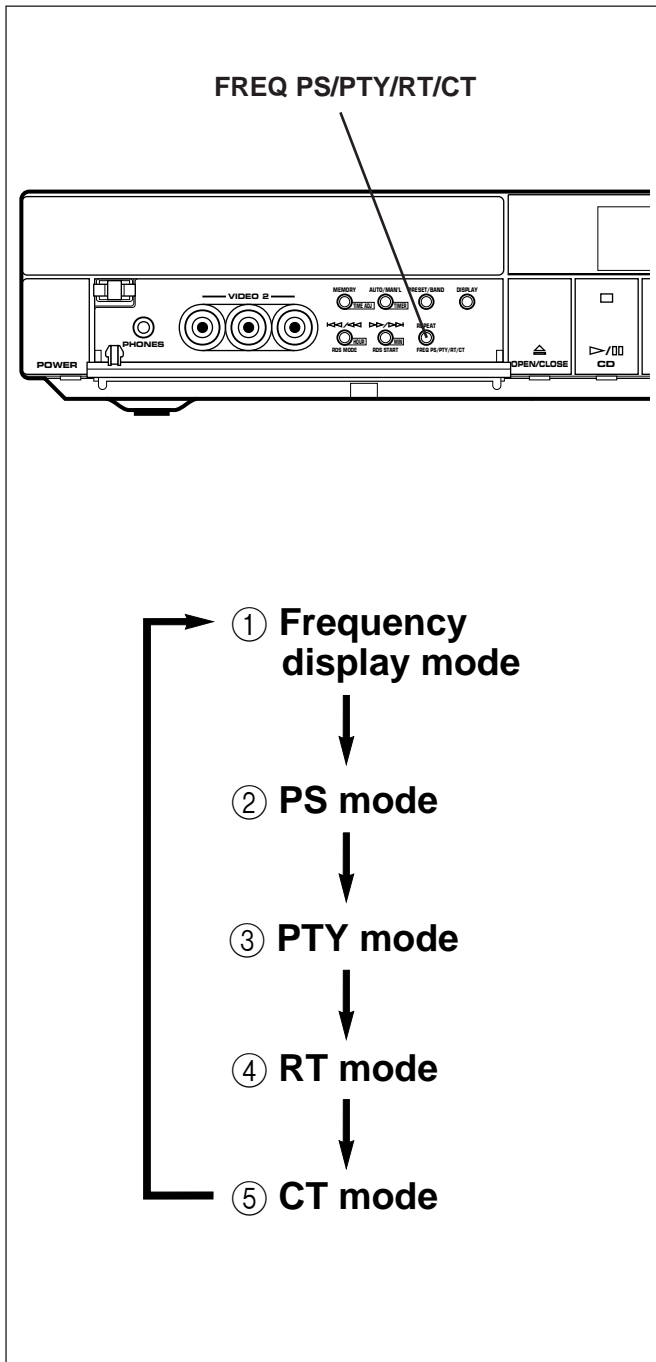

Changing the RDS modes

When an RDS station is received, by pressing the **FREQ PS/PTY/RT/CT** selector button once or more, you can change the display mode among the RDS modes employed by the received station in the order shown below. (The RDS mode not employed by the station cannot be selected.)

Notes

- If the received station is not an RDS station, pressing the **FREQ PS/PTY/RT/CT** selector button displays "NO RDS" on the display, and then it returns to the frequency display mode.
- When an RDS station is received, the display is automatically turned into the PS mode. Do not press the **FREQ PS/PTY/RT/CT** selector button until the display is turned into the PS mode. If the button is pressed before the display mode is changed, it may occur that "NO PS" appears on the display. This is because the unit has not received all of the RDS data on the station yet.

① Frequency display mode

The frequency of the station being received is displayed.

② PS (Program Service name) mode

The name of the station being received is displayed using characters selected from among 64 Roman Alphabets including umlaut sign.

- * If other characters are used on the PS data, they are displayed with underbars.
- * "PS WAIT" may flash while the unit is receiving the data.
- * If the station does not employ the PS data service, "NO PS" lights up on the display for about 2 seconds and then returns to frequency display mode.

③ PTY (Program Type) mode

The type of the program on the station being received is displayed.

In this mode, you can make this unit search for a station which is broadcasting a program of your desired program type. For details, refer to page 42.

- * If the RDS station does not employ the PTY data service, "NO PTY" lights up on the display for about 2 seconds and then returns to frequency display mode.
- * If the station has PS data, after that, it turns into the PS mode.

④ **RT (Radio Text) mode**

Information about the program on the station being received is displayed. Information is displayed by a maximum of 64 Roman Alphabets including umlaut sign.

- * If other characters are used on the RT data, they are displayed with underbars. "RT WAIT" may flash while the unit is receiving the data.
- * If the RDS station does not employ the RT data service, "NO RT" lights up on the display for about 2 seconds and then returns to frequency display mode.
- * If the station has PS data, after that, it turns into the PS mode.

⑤ **CT (Clock Time) mode**

Current time is displayed in the following form. The CT data from the station being received changes every minute.

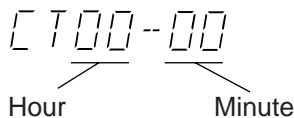

This unit corrects time of the built-in clock by synchronizing it with the CT data. (This function can also be canceled, if so desired. Refer to page 43 for details.)

- * "CT WAIT" may flash while the unit is receiving the data. If the data is accidentally cut off, "CT WAIT" may flash and then turn into "NO CT".
- * If the RDS station does not employ the CT data service, "NO CT" lights up on the display for about 2 seconds and then returns to frequency display mode.
- * If the station has PS data, after that, it turns into the PS mode.

Notes

- RDS data service cannot be utilized by this unit if the received signal is not strong enough. Especially, the RT (Radio Text mode) needs much data to be received, so it may occur that RT mode cannot be displayed even if other RDS modes (PS, PTY, etc.) are displayed.
- There may be a case that RDS data reception is not possible due to poor reception conditions. If so, press the **AUTO/MAN'L** button so that "AUTO" goes off from the display. Though the reception mode is changed to monaural by this operation, when you change the display to an RDS mode, RDS data may be displayed.
- If the signal strength gets weakened by external interference during receiving an RDS station, the RDS data service may be cut off suddenly and turn into the frequency display mode.

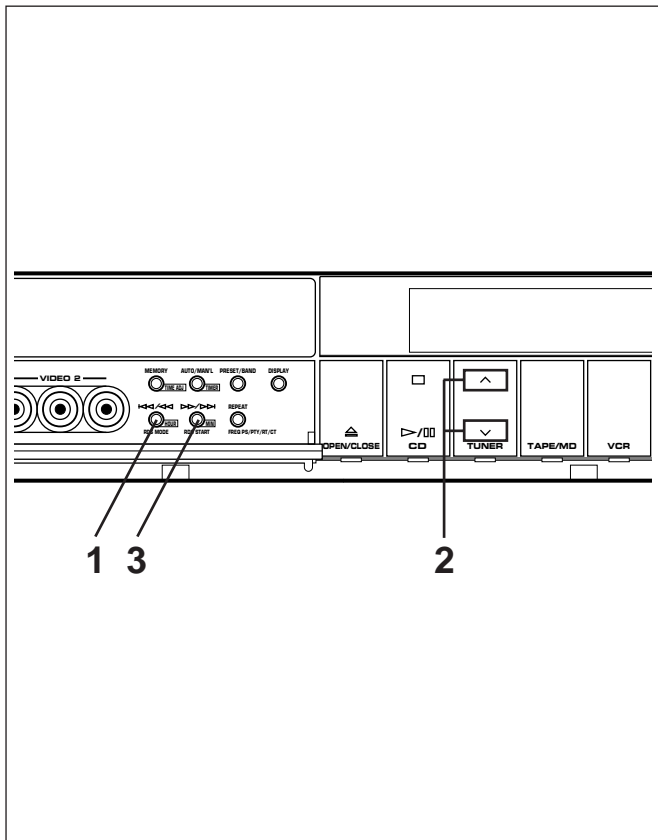

Calling a program of your desired program type from among preset RDS stations (PTY SEEK)

By designating a program type, the unit automatically searches all preset FM stations for an RDS station which broadcasts a program of that program type.

* There are 15 program types to classify RDS stations. For details, refer to page 39.

1 Turn the tuner into the PTY SEEK mode by pressing the **PTY SEEK MODE** button.

* The name of the program type of the station now being received or "NEWS" flashes on the display.

2 Select the desired program type by pressing "∨" or "∧".

* If there is no operation for about 20 seconds, this mode is canceled and turns into the frequency display. If the station has PS data, after that, it turns into the PS mode.

3 Press the **PTY SEEK START** button.

The tuner begins searching all preset FM stations.

* "PTY HOLD" lights up on the display.

* The preset station number indicator, the name of the program type and "AUTO" flash. The preset station number changes rapidly in sequence.

- If a station which broadcasts a program of the program type is found, the tuner stops at the station and turns into the frequency display. If the station has PS data, after that, it turns into the PS mode.
- If the called station is not the desired one, press the **PTY SEEK START** button once more before "PTY HOLD" goes out from the display. The tuner begins searching for another station which broadcasts a program of the same program type.
- If no station is found, "NO PTY" appears and then returns to frequency display. If the station has PS data, after that, it turns into the PS mode.
 - * If the **PTY SEEK START** button is pressed once more during searching, this mode is canceled and turns into the frequency display. If the station has PS data, after that, it turns into the PS mode.

To cancel this function

If the **PTY SEEK MODE** button is pressed once more, the PTY SEEK mode is canceled and turns into the frequency display. If the station has PS data, after that, it turns into the PS mode.

Other functions which make use of RDS data service

This tuner has the following functions which make use of RDS data service. These are originally in operation [ON].

However, you can cancel these functions [OFF], if so desired.

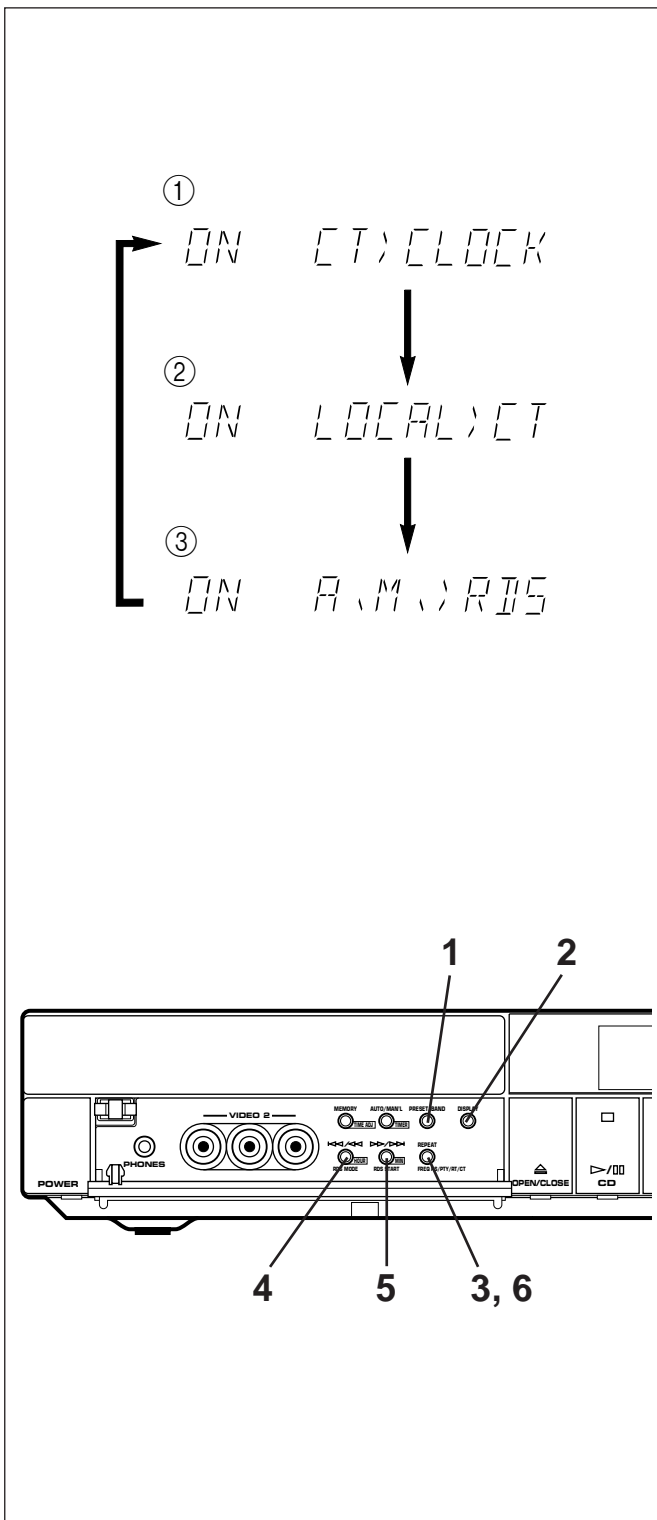

① ON (OFF) CT > CLOCK

This unit corrects the time of the built-in clock automatically by synchronizing it with the CT data on the RDS station being received.

- * If you receive an RDS station of some other country, the built-in clock is synchronized with the time setting of the country.
- * If the built-in clock is not yet set for current time or reset due to a power failure etc., it will be set for the time of the CT data automatically, whether this setting is ON or OFF.

② ON (OFF) LOCAL > CT

If the RDS station being received employs the local time (summer time etc.) data service, its time is displayed in the CT mode.

- * If the setting of function ① is "ON", the built-in clock is synchronized with the local time data.

③ ON (OFF) A. M. > RDS

Only RDS stations are searched instead of all FM stations by the automatic preset tuning operation when the setting is ON.

(See page 37 for the operating procedure.)
If you switch this function OFF, not only RDS stations but also other FM stations are programmed along with MW and LW stations by the automatic preset tuning operation.

To switch these functions on and off

- 1 Select the FM band by pressing the **PRESET/BAND** button, confirming it on the display.
- 2 Press the **DISPLAY** button to display the current time.
- 3 Press the **FREQ PS/PTY/RT/CT** selector button. The title of function ① "ON CT > CLOCK" is displayed.
- 4 Select the title of function whose setting you want to switch by pressing the **PTYP** button once or more.
- 5 Switch the function ON or OFF by pressing the **PTYS** button, confirming it on the display.
- 6 Press the **FREQ PS/PTY/RT/CT** selector button again to restore the frequency display mode.
 - * If the station has PS data, after that, it turns into the PS mode.

Notes

- Once the setting is changed, it will be stored until it is changed again by the above operation.
- During the operation, if there is no operation for about 20 seconds, this mode is canceled and turns into the frequency display. If the station has PS data, after that, it turns into the PS mode.

OPERATING EXTERNAL UNITS CONNECTED WITH THIS SYSTEM

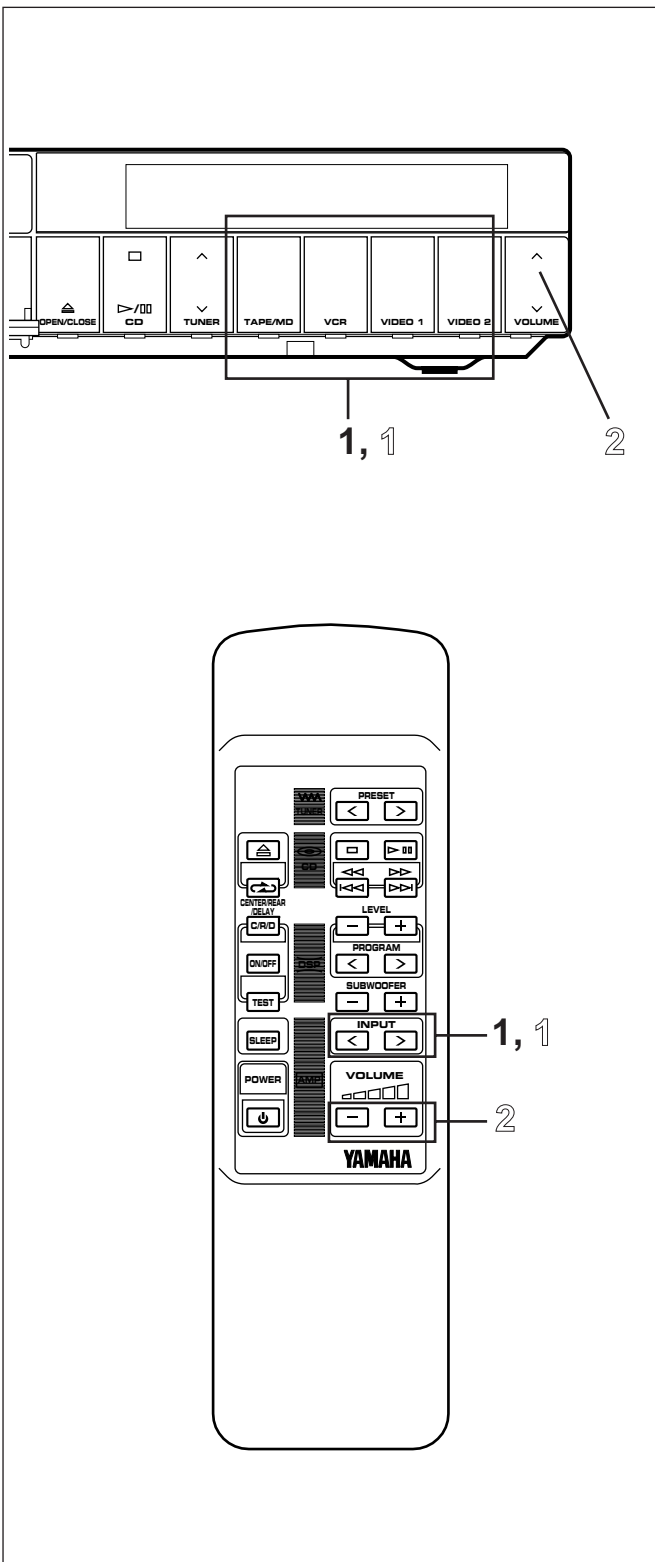

To listen to or watch a source on an external unit connected with this system

- 1** Select a desired input source by pressing the corresponding input selector button.
 - * The name of selected input source is shown on the display.
 - * The names of input selector buttons correspond with the names of terminals to connect with external units on the rear of the main control unit.
- 2** Play back the source.
(For a video source, turn the monitor TV on.)

On screen display

If the monitor TV connected to this system is turned on, the name of selected input source, the name of selected DSP program, volume level settings, etc. are shown on the monitor screen.

To record a source to tape

Any input source can be recorded by a tape deck and/or a VCR, MD, etc. connected with this system.

- 1** Select the source to be recorded by pressing the corresponding input selector button.
- 2** Play back the source and then turn the volume up to confirm the input source.
- 3** Begin recording on the tape deck or VCR etc. connected with this system.

USING DIGITAL SOUND FIELD PROCESSOR (DSP)

This system incorporates a sophisticated, multi-program digital sound field processor. The processor allows you to electronically expand and change the shape of the audio sound field from both audio and video sources, creating a theater-like experience in your listening room. You can create an excellent audio sound field by selecting a suitable sound field program (this will, of course, depend on what you will be listening to), and adding desired adjustments.

In addition, this unit incorporates a Dolby Pro Logic Surround decoder for multi-channel sound reproduction of sources encoded with Dolby Surround. The operation of the Dolby Pro Logic Surround decoder can be controlled by selecting the DSP program, **PRO LOGIC** or **PRO LOGIC ENHANCED**.

Brief Overview of Digital Sound Field Programs

The following list gives you a brief description of the sound fields produced by each of the DSP programs. Keep in mind that most of these are precise digital recreations of actual acoustic environments. The data for these sound fields was recorded at actual locations using sophisticated sound field measurement equipment.

Note

The channel level balance between the left and right rear effect speakers may vary depending on the sound field you are listening to. This is due to the fact that most of these sound field recreations are actual acoustic environments.

PROGRAM	FEATURE
PRO LOGIC	This program is used for playback of sources encoded with Dolby Surround. The application of a sophisticated digital signal processing system reduces crosstalk and directs or steers the sound source more smoothly and precisely, as compared to conventional types.
PRO LOGIC ENHANCED	This program is also used for playback of sources encoded with Dolby Surround. Enhancing the "Normal" Dolby Pro Logic, the DSP technology simulates the multi-surround speaker systems of a 35 mm movie theater. This effect creates a wide surround sound field, and expands the sound stage with an improved presence image. This program is used for musical based movies, as well as drama and comedy based movies.
STADIUM	This program gives you long delays between direct sounds and effect sounds, and extraordinarily spacious feel of a large stadium.
DISCO	This program recreates the acoustic environment of a lively disco in the heart of a very lively city. The sound is dense and highly concentrated. It is also characterized by a high-energy, "immediate" sound.
CONCERT HALL	In this program, the center will appear to be deep behind the main speakers, creating an expansive large hall ambience. Orchestra and opera music are suited for this sound field.
ROCK CONCERT	This program is ideally suited for rock music. You will experience a very dynamic or lively sound field.
MONO MOVIE	This program is designed specifically to enhance mono source programs. Compared to a strictly mono setting, the sound image created in this mode is wider and slightly forward of the speaker pair, lending an immediacy to the overall sound. It is particularly effective when used with old mono movies, news broadcasts and dialog.
CONCERT VIDEO	This program is effective for music videos and gives excellent depth and clarity for vocals. For opera, the orchestra and stage are ideally recreated, letting you feel as if you were in an actual concert hall.

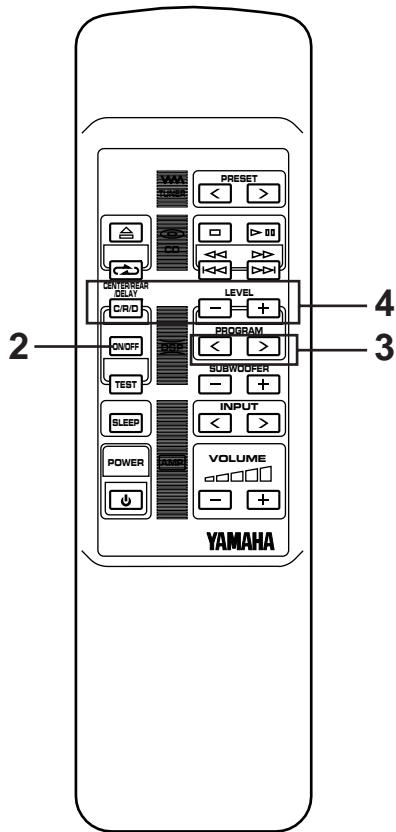

Listening to a source with effect sounds by the digital sound field processing (including the Dolby Pro Logic Surround decoding)

- 1 Play back a source. (For source playback, refer to the sections beginning from page 30.)
- 2 If no DSP program name is illuminated on the display, press the DSP **ON/OFF** button so that a name of program lights up on the display.

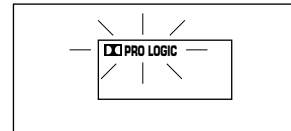

- 3 Press the **PROGRAM** selector “ < ” or “ > ” button once or more so that the name of a desired program appears on the sound field program indicator.
 - * Whenever you press the **PROGRAM** selector “ < ” button, the program changes and is displayed as figured left.
 - * Pressing the **PROGRAM** selector “ > ” button changes the programs in the reverse order.
- 4 If desired, adjust the delay time and the output level of each speaker. (For details, refer to the corresponding descriptions on pages 47 to 48.)



Notes

- Program selection can be made to individual input sources. Once you select a program, it is linked with the input source selected at that time. So, when you select the input source next time, the same program is automatically called.
- If you prefer to cancel the DSP, press the DSP **ON/OFF** button. The sound will be the normal 2-channel stereo without surround sound effect.
- When **STADIUM**, **DISCO**, **CONCERT HALL**, **ROCK CONCERT**, **MONO MOVIE** or **CONCERT VIDEO** is selected, no sound is heard from the center speaker.
- When a monaural sound source is played with **DOLBY PRO LOGIC** or **DOLBY PRO LOGIC ENHANCED**, no sound is heard from the front speakers and the rear speakers. Sound is heard only from the center speaker.

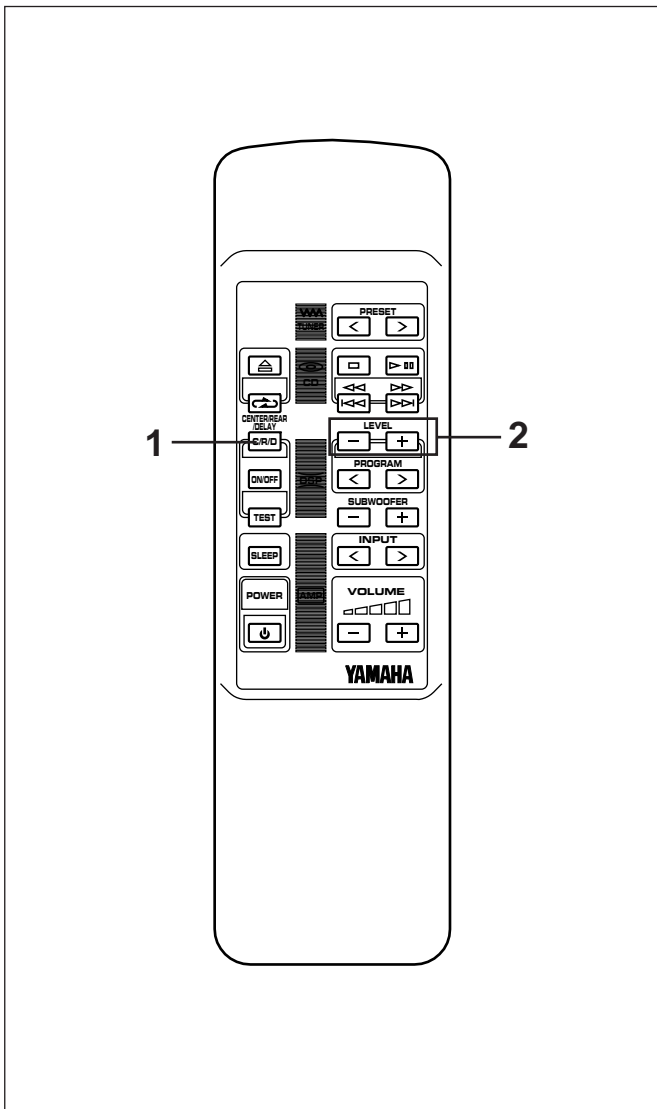

Adjusting center speaker level

If desired, you can adjust the sound output level of the center speaker even if the output level is already set in “SPEAKER BALANCE ADJUSTMENT” on pages 26 to 27.

Control range : +10 to -20

- 1 Press the **CENTER/REAR/DELAY** selector button once or more so that “CENT” appears on the display.

CENT + 10

- 2 By continuously pressing the **LEVEL** control + or - button, the level value changes continuously. The value stops changing momentarily at “±0”.

CENT + 0

Adjustable

Notes

- This adjustment can be made only when the digital sound field program **DOLBY PRO LOGIC** or **DOLBY PRO LOGIC ENHANCED** is selected.
- Once the output level is adjusted, the level value will be the same in all the digital sound field programs mentioned above.

Adjusting rear speaker level

If desired, you can adjust the sound output level of the rear speakers even if the output level is already set in “SPEAKER BALANCE ADJUSTMENT” on pages 26 to 27.

Control range : +10 to -20

- 1 Press the **CENTER/REAR/DELAY** selector button once or more so that “REAR” appears on the display.

REAR + 9

- 2 By continuously pressing the **LEVEL** control + or - button, the level value changes continuously. The value stops changing momentarily at “±0”.

REAR + 0

Adjustable

Notes

- This adjustment can be made only when the built-in digital sound field processor is on.
- Once the output level is adjusted, the level value will be the same in all the digital sound field programs.

Adjusting delay time

You can adjust the time difference between the beginning of the sound from the front speakers and the beginning of the effect sound from the rear speakers. The larger the value, the later the effect sound is generated.

This adjustment can be made to all programs individually.

Control range

PRO LOGIC	: from 15 to 30 milliseconds (Preset value: 20 milliseconds)
PRO LOGIC ENHANCED	: from 15 to 30 milliseconds (Preset value: 20 milliseconds)
STADIUM	: from 1 to 50 milliseconds (Preset value: 45 milliseconds)
DISCO	: from 1 to 100 milliseconds (Preset value: 14 milliseconds)
CONCERT HALL	: from 1 to 100 milliseconds (Preset value: 30 milliseconds)
ROCK CONCERT	: from 1 to 100 milliseconds (Preset value: 17 milliseconds)
MONO MOVIE	: from 1 to 100 milliseconds (Preset value: 20 milliseconds)
CONCERT VIDEO	: from 1 to 100 milliseconds (Preset value: 28 milliseconds)

- 1 Press the **CENTER/REAR/DELAY** selector button once or more so that "DEL" appears on the display.

DEL 20ms

- 2 By continuously pressing the **LEVEL** control + or - button, the value changes continuously. The value stops changing momentarily at the preset point.

DEL 25ms
Adjustable

Notes

- Adding too much delay will cause an unnatural effect with some sources.
- When the **LEVEL** control button is pressed, sound is momentarily interrupted.

Note

The values of the delay time, center level and rear level you set the last time will remain memorized even when this system is in the standby mode.

However, if the power cord is kept disconnected for more than one week, these values will be automatically changed back to the original factory settings.

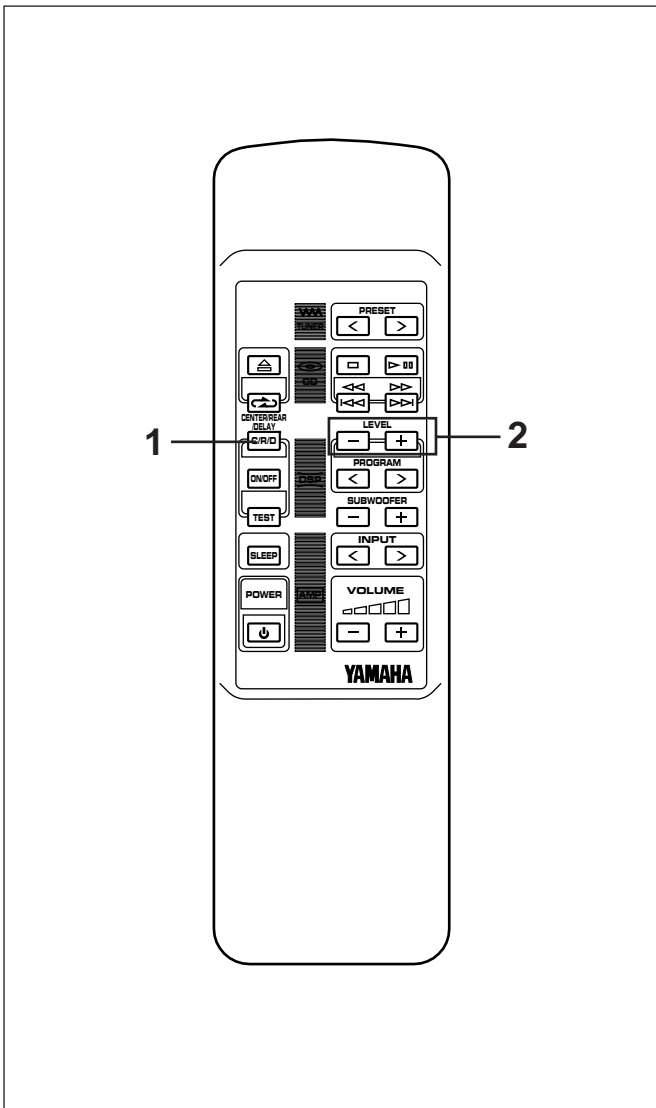

TIMER PLAY

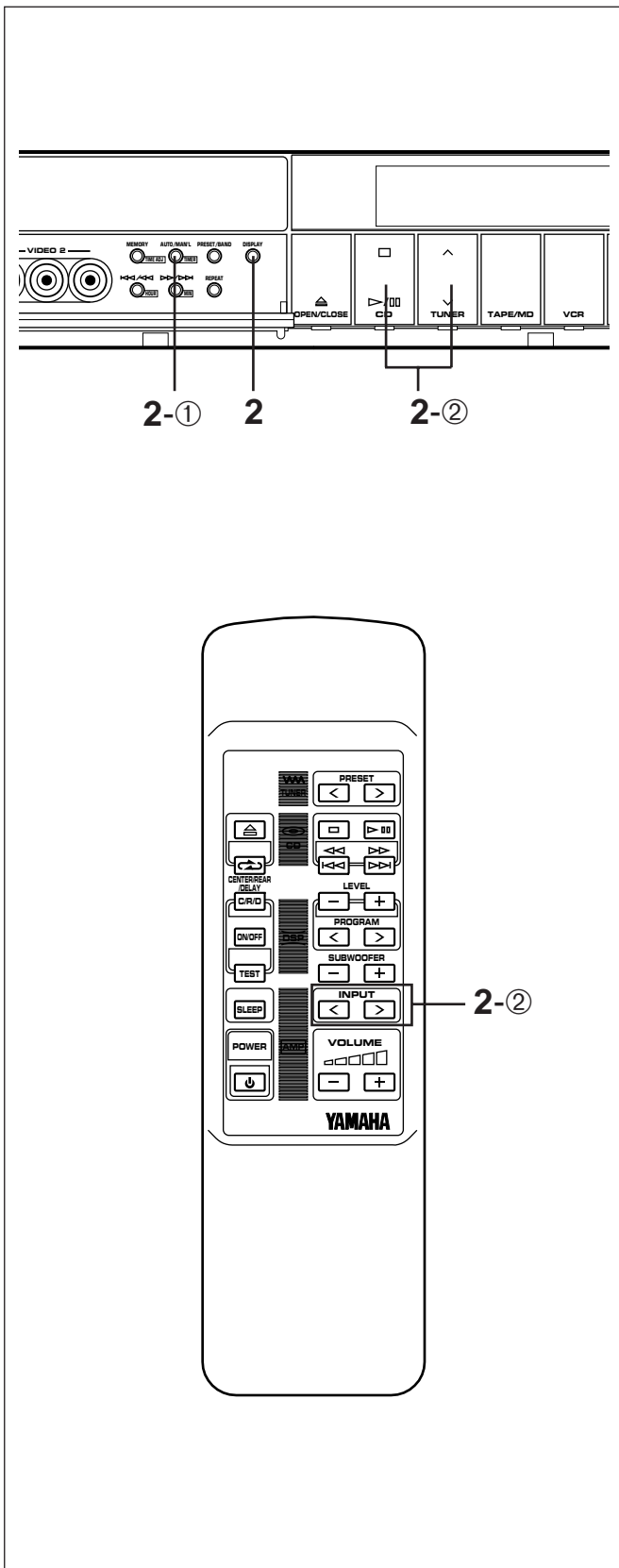

By using the built-in timer, you can set the time when this system turns on and a source begins playing automatically, and the time when this system turns into the standby mode automatically.

1 Prepare the source to be played.

For tuner:

Tune in to the station you will listen to.

For CD player:

Load a disc on the disc tray.

2 Press the **DISPLAY** button.

Whenever the **DISPLAY** button is pressed, the display mode changes as follows. On each mode, make a setting for the timer play, following the setting procedure described below.

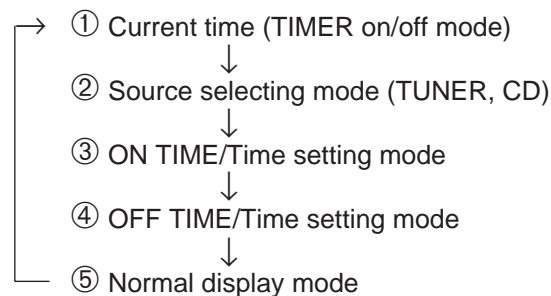

Note

The display mode will be changed to the next mode after about 8 seconds elapse in turn automatically. If the mode is changed before the setting is completed, call the mode again by pressing the **DISPLAY** button once or more.

Setting procedure:

① Current time

Check to be sure that the current time is correct, and press the **TIMER** button so that "TIMER" lights up on the display.

② Source selecting mode

Select the source (TUNER or CD) to be played by pressing the corresponding input selector button.

* If "TUNER" is selected, soon it is changed to the frequency display mode. In this mode, you can select the station to listen to by the timer play by using the **PRESET/BAND** button and \wedge / \vee button.

HOW TO USE THE BUILT-IN TIMER

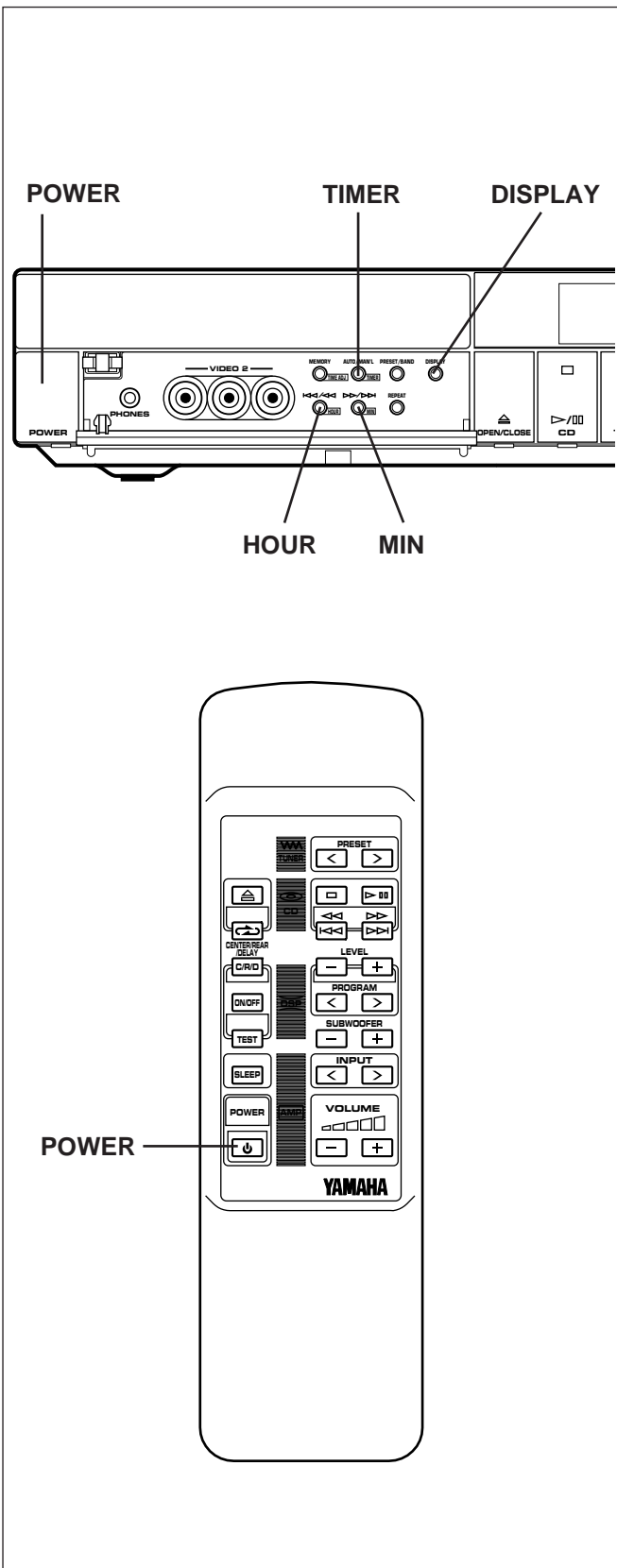

③ ON TIME/time setting mode

["ON TIME" appears on the display, and soon it is changed to a time setting mode.]

Set to the time when you want to begin the timer play by using the **HOUR** button and the **MIN** button.

④ OFF TIME/time setting mode

["OFF TIME" appears on the display, and soon it is changed to a time setting mode.]

If necessary, set to the time when you want to finish the timer play (to turn this system into the standby mode) by using the **HOUR** button and the **MIN** button. Even if you do not set the time, it has already been set so that the timer play finishes after 1 hour.

Note

The **TIMER** button functions also in the time (ON TIME or OFF TIME) setting mode. (However, it also turns this system into the standby mode.)

- 3 If you will not use this unit until the timer play begins, turn this system into the standby mode by pressing the **POWER** switch or the **TIMER** button.

Note

If a timer play setting is made and this system is not turned into the standby mode, the source set for the timer play will begin playing when the time comes in place of the source played at that time.

To cancel the timer play setting

After the timer play is finished, press the **DISPLAY** button to call the current time. While the current time is displayed, press the **TIMER** button so that "TIMER" goes out from the display.

If it is not canceled, the system will be turned on at the same time every day, so it can be used as an alarm. However, if you are planning to go out at that time, cancel the timer play setting.

* Unless the AC supply lead is unplugged or there is a power failure for more than 5 minutes, the time set on the timer will be retained until it is reset.

How to make time setting in the ON TIME or OFF TIME mode

For the hour:

Press the **HOUR** button to change the hour to a higher value. Press and hold to change continuously.

For the minute:

Use the **MIN** button and operate it in the same way as you did to change the hour.

SLEEP TIMER OPERATION

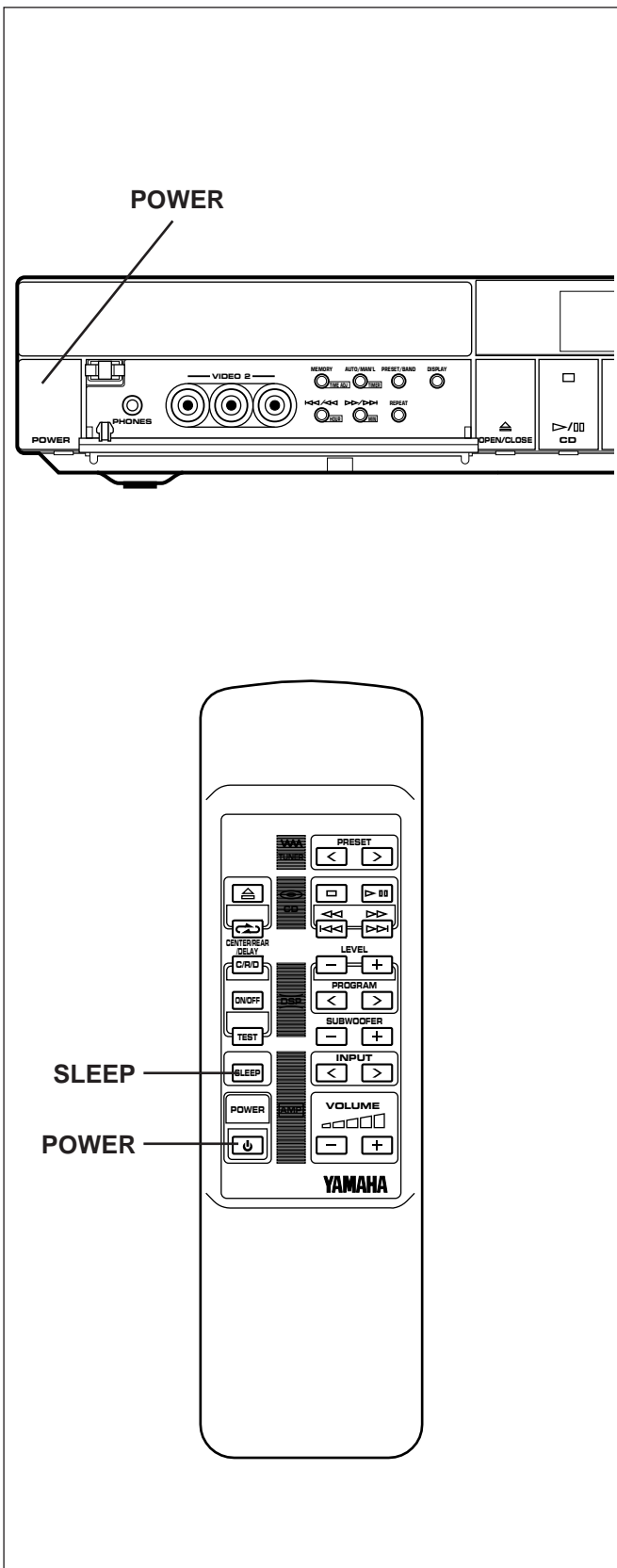

This system can be turned into the standby mode automatically.

- 1 Play the desired sound source.
- 2 Press the **SLEEP** button. "SLEEP" appears on the display, and soon it is replaced by "2h00m".
- 3 Press the **SLEEP** button repeatedly until the desired sleep time appears on the display. The display will change as described below. [Time is displayed by the hour (h) and the minute (m).]

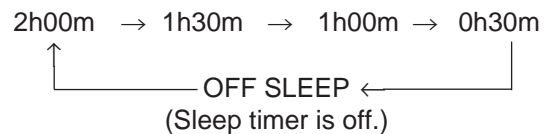

- * The original display mode will resume about 4 seconds after the selection is made.
 - * The SLEEP indicator will light up to indicate that the sleep timer is on.
- 4 The system will turn into the standby mode automatically when the selected sleep time passes.

To confirm the sleep time setting

Press the **SLEEP** button once. "SLEEP" appears on the display, and soon it is replaced by the remaining time of the selected sleep time.

To change the sleep time

While the SLEEP indicator is illuminated, press the **SLEEP** button repeatedly until the desired time appears.

To stop the sleep timer operation

Press the **POWER** switch, or press the **SLEEP** button repeatedly until "OFF SLEEP" appears on the display. (The SLEEP indicator will go out.)

Using the timer and the sleep timer at the same time

- 1 Prepare timer play. (See page 49 and 50.)
 - * Do not turn this system into the standby mode after the timer setting is finished.
- 2 Press the **SLEEP** button and set the sleep time.

When the sleep timer operation finishes, the timer begins functioning to turn the source on at the preset time.

Note

Do not make the timer time setting so that the timer will start during sleep timer operation. (Since sleep timer operation has priority, the timer will not operate.)

TROUBLESHOOTING

If your unit fails to operate normally, check the following points to determine whether the fault can be corrected by the simple measures suggested. If it cannot, or if the fault is not listed in the SYMPTOM column, disconnect the power cord and contact your authorized YAMAHA dealer or service center for help.

	SYMPTOM	CAUSE	REMEDY
GENERAL	No power even if the POWER switch is pressed.	AC supply lead is not plugged in.	Plug in the AC supply lead.
	It happens that this system does not work normally.	There is an influence of strong external noise (lightning, excessive static electricity, etc.) or a misoperation on this system while using this system.	Turn this system into the standby mode and disconnect the AC power cord from the AC outlet. After about 30 seconds have passed, connect the power and operate this system again.
	No sound from one speaker	Loose speaker connections.	Connect properly.
	No sound from speakers.	Internal protection circuit is functioning.	Unplug the AC supply lead from the wall AC outlet, and then plug in again.
	No sound from the rear speakers.	One rear speaker connection is loose or bad.	Connect it properly.
		The sound output level to the rear speakers is set to minimum.	Raise the sound output level to the rear speakers.
		No DSP program is selected.	Select the appropriate program.
	No sound from the center speaker.	The sound output level to the center speaker is set to minimum.	Raise the sound output level to the center speaker.
		Incorrect DSP program selection. No DSP program is selected.	Select the appropriate program.
	No sound (or no picture) from an external unit connected with this system.	Incorrect cord connections.	Connect the cords properly. If the problem persists, the cords may be defective.
		Input source selection is not proper.	Make a proper input source selection.
	Can't set timer.	Current time is not set.	Set current time.
This unit will not operate properly.	The internal microcomputer has been frozen by an external electric shock (lightning, excessive static electricity, etc.) or power supply with low voltage.	Unplug the AC supply lead from the wall AC outlet, and then plug in again after about one minute.	
TUNER	Excessive static in FM broadcasts.	Interference from starting motor of nearby car.	Position the FM antenna as high and as far away from nearby roads as possible. Connect using a coaxial cable.
		Interference from thermostat of nearby electrical appliance.	
	Noise increases during stereo broadcasts.	Antenna input is too weak due to obstructions or excessive distance from broadcasting station.	Check antenna connections. Install a multi-element type FM antenna if possible.
	Stereo broadcasts are noisy and ST indicator blinks on and off.	Insufficient antenna input.	Install an antenna appropriate for the electric field strength of your area.
	Cannot select preset stations.	Preset memory has been erased.	Reprogram memory presets.
	Buzzing or static during AM (LW or MW) broadcasts.	Interference from source such as lightning, fluorescent lights, electric motors or thermostat of nearby electrical appliance.	Problem is difficult to eliminate but can be lessened by grounding MW/LW (AM) loop antenna.
		TV or microprocessor is being used nearby.	Move away from TV or microprocessor.
AM (LW or MW) broadcast sensitivity is poor.	Radio signal is weak or antenna is not properly connected.	Properly connect MW/LW (AM) loop antenna.	
		Change orientation of MW/LW (AM) loop antenna.	
		Install an external MW/LW (AM) antenna.	
CD PLAYER	Playback will not begin even if disc is loaded.	Disc is upside down.	Load disc label side up.
		Disc is dirty.	Clean disc.
	No sound.	Input selector setting is incorrect.	Press the CD input selector button.
	Sound stops suddenly (always at same spot).	Disc is dirty.	Clean disc.
Volume is set too high.		Lower volume.	
REMOTE CONTROL	Remote control doesn't work.	Batteries are dead.	Replace batteries.
		Remote control is too far away or is being used at incorrect angle.	Use within 6 m and 60° radius.
		Direct sunlight or lighting (of an inverter type of fluorescent lamp etc.) is striking the remote control sensor of the main unit.	Change position of the main unit.
	TV functions strangely when the remote control is used.	Remote control is being used near TV set with a remote control sensor.	Relocate this unit away from the TV or cover TV's remote control sensor.

SPECIFICATIONS

As a part of policy of continuous improvement, YAMAHA reserves the right to make design and specification changes for product improvement without prior notice. The performance specification figures indicated are nominal values of production units.

■ Amplifier section

Minimum RMS Output Power per Channel

Front L, R	
6 ohms, 1 kHz, 10% THD	30W+30W
Center	
6 ohms, 1 kHz, 10% THD	30W
Rear L, R	
6 ohms, 1 kHz, 10% THD	30W+30W
Subwoofer	
4 ohms, 100 Hz, 10% THD	50W

DIN Standard Output Power per Channel [Europe model only]

6 ohms, 1 kHz, 1% THD	25W
-----------------------------	-----

IEC Power [Europe model only]

6 ohms, 1 kHz, 0.1% THD	20W
-------------------------------	-----

Input Sensitivity/Impedance

AUX	120 mV/20 k-ohms
-----------	------------------

Headphone Output Impedance

	68 ohms
--	---------

Total Harmonic Distortion (1 kHz)

TAPE/MD to SP OUT (12.5W/6 ohms)	0.08%
--	-------

Signal-to-Noise Ratio (IHF-A Network)

TAPE/MD (Input Shorted)	85 dB
-------------------------------	-------

■ Video section

Video Signal Level

	1 Vp-p/75 ohms
--	----------------

Maximum Input Level

	1.5 Vp-p or more
--	------------------

Signal-to-Noise Ratio

	50 dB or more
--	---------------

Monitor Out Frequency Response

.....	5 Hz to 10 MHz, -3 dB
-------	-----------------------

■ Tuner section

Tuning Range

FM

[U.S.A. and Canada models]	87.5 to 107.9 MHz
[U.K., Europe, Australia, Singapore and General models]	87.5 to 108.0 MHz

AM (MW)

[U.S.A., Canada and General models]	530 - 1,710 kHz
[U.K., Europe, Australia and Singapore models]	531 - 1,611 kHz

LW

[U.K. and Europe models only]	153 - 288 kHz
-------------------------------------	---------------

Usable Sensitivity

FM (75 ohms)

(30 dB S/N Quieting, 1 kHz, 100% mod.)	
[U.S.A., Canada, Singapore and General models]	1.5 μ V (14.8 dBf)
(DIN, Mono, S/N 26 dB)	
[U.K., Europe and Australia models]	1.8 μ V
AM (MW)	280 μ V/m
LW [U.K. and Europe models only]	560 μ V/m

■ CD player section

Type

	Single CD Player
--	------------------

Signal Readout

..... Non-contact, 3-beam semi-conductor laser pick-up

D/A Converter

	1-bit DAC
--	-----------

Filter

	8-time oversampling digital filter
--	------------------------------------

Wow and Flutter

	Below measurable limits
--	-------------------------

SPECIFICATIONS

■ Speaker section

Type

Front, Center, Rear 1-Way, 1-Speaker,
Acoustic-Suspension Type
(Magnetically-Shielded Type)

Subwoofer Active Servo Processing
Speaker System
(Magnetically-Shielded Type)

Speakers

Front, Center, Rear 8 cm (3-1/8")

Subwoofer 20 cm (7-7/8")

Maximum Power Handling Capacity

Front, Center, Rear 30W (13.5V)

Subwoofer 50W (14.2V)

Impedance

Front, Center, Rear 6 ohms

Subwoofer 4 ohms

■ General

Power Supply

[U.S.A. and Canada models] AC 120V, 60 Hz
[U.K., Europe and Singapore models]

.....AC 230V, 50 Hz

[Australia model] AC 240V, 50 Hz

[General model]

.....AC 110/120/220/240V, 60/50 Hz

Power consumption 160W

Dimensions (W x H x D)

SW-AV1 250 x 425 x 418 mm
(9-13/16" x 16-3/4" x 16-7/16")

TCD-AV1 320 x 70 x 258 mm
(12-5/8" x 2-3/4" x 10-3/16")

NX-AV1 94 x 117 x 108 mm
(3-11/16" x 4-5/8" x 4-1/4")

Weight

SW-AV1 14.5 kg (31 lbs. 14 oz.)

TCD-AV1 2.6 kg (5 lbs. 12 oz.)

NX-AV1 0.7 kg (1 lbs. 9 oz.)

YAMAHA

YAMAHA ELECTRONICS CORPORATION, USA 6660 ORANGETHORPE AVE., BUENA PARK, CALIF. 90620, U.S.A.
YAMAHA CANADA MUSIC LTD. 135 MILNER AVE., SCARBOROUGH, ONTARIO M1S 3R1, CANADA
YAMAHA ELECTRONIK EUROPA G.m.b.H. SIEMENSSTR. 22-34, 25462 RELLINGEN BEI HAMBURG, F.R. OF GERMANY
YAMAHA ELECTRONIQUE FRANCE S.A. RUE AMBROISE CROIZAT BP70 CROISSY-BEAUBOURG 77312 MARNE-LA-VALLEE CEDEX02, FRANCE
YAMAHA ELECTRONICS (UK) LTD. YAMAHA HOUSE, 200 RICKMANSWORTH ROAD WATFORD, HERTS WD1 7JS, ENGLAND
YAMAHA SCANDINAVIA A.B. J A WETTERGRENS GATA 1, BOX 30053, 400 43 VÄSTRA FRÖLUNDA, SWEDEN
YAMAHA MUSIC AUSTRALIA PTY, LTD. 17-33 MARKET ST., SOUTH MELBOURNE, 3205 VIC., AUSTRALIA

YAMAHA CORPORATION

VZ30070

Free Manuals Download Website

<http://myh66.com>

<http://usermanuals.us>

<http://www.somanuals.com>

<http://www.4manuals.cc>

<http://www.manual-lib.com>

<http://www.404manual.com>

<http://www.luxmanual.com>

<http://aubethermostatmanual.com>

Golf course search by state

<http://golfingnear.com>

Email search by domain

<http://emailbydomain.com>

Auto manuals search

<http://auto.somanuals.com>

TV manuals search

<http://tv.somanuals.com>