

HOME THEATER SOUND SYSTEM**AVX-S80**

AVX-S80: AVR-S80 + NX-S80S + NX-S80C + SW-S80

OWNER'S MANUAL

IMPORTANT SAFETY INSTRUCTIONS

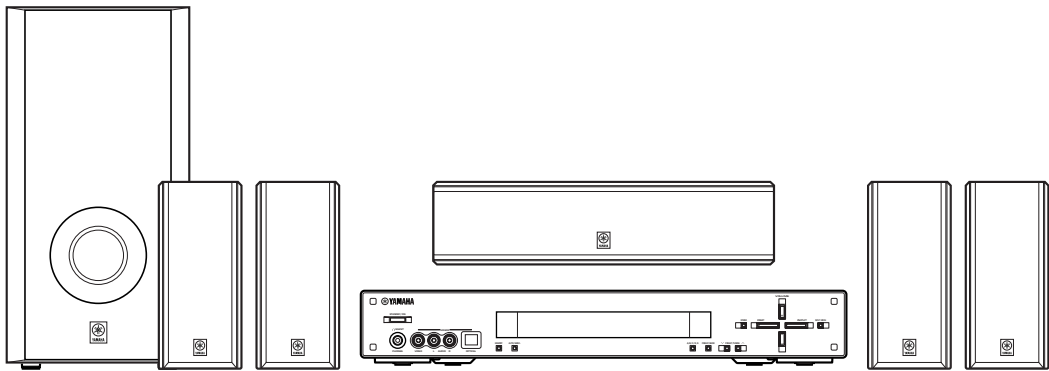
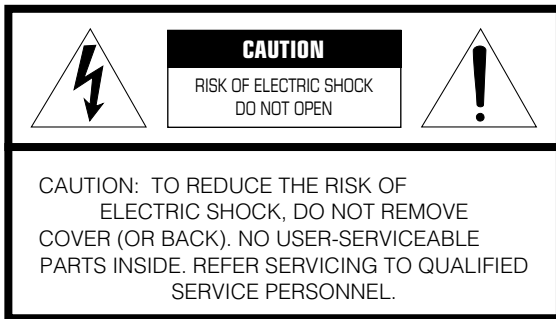

• Explanation of Graphical Symbols

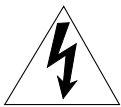

The lightning flash with arrowhead symbol, within an equilateral triangle, is intended to alert you to the presence of uninsulated "dangerous voltage" within the product's enclosure that may be of sufficient magnitude to constitute a risk of electric shock to persons.



The exclamation point within an equilateral triangle is intended to alert you to the presence of important operating and maintenance (servicing) instructions in the literature accompanying the appliance.

WARNING

TO REDUCE THE RISK OF FIRE OR ELECTRIC SHOCK, DO NOT EXPOSE THIS UNIT TO RAIN OR MOISTURE.

- 1 Read Instructions – All the safety and operating instructions should be read before the product is operated.
- 2 Retain Instructions – The safety and operating instructions should be retained for future reference.
- 3 Heed Warnings – All warnings on the product and in the operating instructions should be adhered to.
- 4 Follow Instructions – All operating and use instructions should be followed.
- 5 Cleaning – Unplug this product from the wall outlet before cleaning. Do not use liquid cleaners or aerosol cleaners. Use a damp cloth for cleaning.
- 6 Attachments – Do not use attachments not recommended by the product manufacturer as they may cause hazards.
- 7 Water and Moisture – Do not use this product near water – for example, near a bath tub, wash bowl, kitchen sink, or laundry tub; in a wet basement; or near a swimming pool; and the like.
- 8 Accessories – Do not place this product on an unstable cart, stand, tripod, bracket, or table. The product may fall, causing serious injury to a child or adult, and serious damage to the product. Use only with a cart, stand, tripod, bracket, or table recommended by the manufacturer, or sold with the product. Any mounting of the product should follow the manufacturer's instructions, and should use a mounting accessory recommended by the manufacturer.
- 9 A product and cart combination should be moved with care. Quick stops, excessive force, and uneven surfaces may cause the product and cart combination to overturn.



- 10 Ventilation – Slots and openings in the cabinet are provided for ventilation and to ensure reliable operation of the product and to protect it from overheating, and these openings must not be blocked or covered. The openings should never be blocked by placing the product on a bed, sofa, rug, or other similar surface. This product should not be placed in a built-in installation such as a bookcase or rack unless proper ventilation is provided or the manufacturer's instructions have been adhered to.
- 11 Power Sources – This product should be operated only from the type of power source indicated on the marking label. If you are not sure of the type of power supply to your home, consult your product dealer or local power company. For products intended to operate from battery power, or other sources, refer to the operating instructions.
- 12 Grounding or Polarization – This product may be equipped with a polarized alternating current line plug (a plug having one blade wider than the other). This plug will fit into the power outlet only one way. This is a safety feature. If you are unable to insert the plug fully into the outlet, try reversing the plug. If the plug should still fail to fit, contact your electrician to replace your obsolete outlet. Do not defeat the safety purpose of the polarized plug.
- 13 Power-Cord Protection – Power-supply cords should be routed so that they are not likely to be walked on or pinched by items placed upon or against them, paying particular attention to cords at plugs, convenience receptacles, and the point where they exit from the product.
- 14 Lightning – For added protection for this product during a lightning storm, or when it is left unattended and unused for long periods of time, unplug it from the wall outlet and disconnect the antenna or cable system. This will prevent damage to the product due to lightning and power-line surges.
- 15 Power Lines – An outside antenna system should not be located in the vicinity of overhead power lines or other electric light or power circuits, or where it can fall into such power lines or circuits. When installing an outside antenna system, extreme care should be taken to keep from touching such power lines or circuits as contact with them might be fatal.
- 16 Overloading – Do not overload wall outlets, extension cords, or integral convenience receptacles as this can result in a risk of fire or electric shock.
- 17 Object and Liquid Entry – Never push objects of any kind into this product through openings as they may touch dangerous voltage points or short-out parts that could result in a fire or electric shock. Never spill liquid of any kind on the product.
- 18 Servicing – Do not attempt to service this product yourself as opening or removing covers may expose you to dangerous voltage or other hazards. Refer all servicing to qualified service personnel.
- 19 Damage Requiring Service – Unplug this product from the wall outlet and refer servicing to qualified service personnel under the following conditions:
 - a) When the power-supply cord or plug is damaged,
 - b) If liquid has been spilled, or objects have fallen into the product,
 - c) If the product has been exposed to rain or water,

- d) If the product does not operate normally by following the operating instructions. Adjust only those controls that are covered by the operating instructions as an improper adjustment of other controls may result in damage and will often require extensive work by a qualified technician to restore the product to its normal operation,
 - e) If the product has been dropped or damaged in any way, and
 - f) When the product exhibits a distinct change in performance - this indicates a need for service.
- 20 Replacement Parts – When replacement parts are required, be sure the service technician has used replacement parts specified by the manufacturer or have the same characteristics as the original part. Unauthorized substitutions may result in fire, electric shock, or other hazards.
- 21 Safety Check – Upon completion of any service or repairs to this product, ask the service technician to perform safety checks to determine that the product is in proper operating condition.
- 22 Wall or Ceiling Mounting – The unit should be mounted to a wall or ceiling only as recommended by the manufacturer.
- 23 Heat – The product should be situated away from heat sources such as radiators, heat registers, stoves, or other products (including amplifiers) that produce heat.

Note to CATV system installer:

This reminder is provided to call the CATV system installer's attention to Article 820-40 of the NEC that provides guidelines for proper grounding and, in particular, specifies that the cable ground shall be connected to the grounding system of the building, as close to the point of cable entry as practical.

- 24 Outdoor Antenna Grounding – If an outside antenna or cable system is connected to the product, be sure the antenna or cable system is grounded so as to provide some protection against voltage surges and built-up static charges. Article 810 of the National Electrical Code, ANSI/NFPA 70, provides information with regard to proper grounding of the mast and supporting structure, grounding of the lead-in wire to an antenna discharge unit, size of grounding conductors, location of antenna discharge unit, connection to grounding electrodes, and requirements for the grounding electrode.

EXAMPLE OF ANTENNA GROUNDING

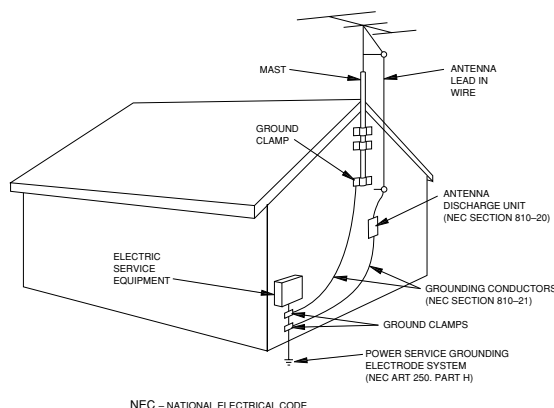

NEC – NATIONAL ELECTRICAL CODE

FCC INFORMATION (for US customers)

1. IMPORTANT NOTICE : DO NOT MODIFY THIS UNIT!

This product, when installed as indicated in the instructions contained in this manual, meets FCC requirements. Modifications not expressly approved by Yamaha may void your authority, granted by the FCC, to use the product.

2. IMPORTANT : When connecting this product to accessories and/or another product use only high quality shielded cables. Cable/s supplied with this product MUST be used. Follow all installation instructions. Failure to follow instructions could void your FCC authorization to use this product in the USA.

3. NOTE : This product has been tested and found to comply with the requirements listed in FCC Regulations, Part 15 for Class "B" digital devices. Compliance with these requirements provides a reasonable level of assurance that your use of this product in a residential environment will not result in harmful interference with other electronic devices. This equipment generates/uses radio frequencies and, if not installed and used according to the instructions found in the users manual, may cause interference harmful to the operation of other electronic devices.

Compliance with FCC regulations does not guarantee that interference will not occur in all installations. If this product is found to be the source of interference, which can be determined by turning the unit "OFF" and "ON", please try to eliminate the problem by using one of the following measures:

Relocate either this product or the device that is being affected by the interference.

Utilize power outlets that are on different branch (circuit breaker or fuse) circuits or install AC line filter/s.

In the case of radio or TV interference, relocate/reorient the antenna. If the antenna lead-in is 300 ohm ribbon lead, change the lead-in to coaxial type cable.

If these corrective measures do not produce satisfactory results, please contact the local retailer authorized to distribute this type of product. If you can not locate the appropriate retailer, please contact Yamaha Electronics Corp., U.S.A. 6660 Orangethorpe Ave, Buena Park, CA 90620.

The above statements apply ONLY to those products distributed by Yamaha Corporation of America or its subsidiaries.

CAUTION

CAUTION: READ THIS BEFORE OPERATING YOUR SYSTEM.

- 1 To assure the finest performance, please read this manual carefully. Keep it in a safe place for future reference.
- 2 Install this sound system in a well ventilated, cool, dry, clean place with at least 5 cm on the top, 5 cm on the left and right, and 5 cm at the back of AVR-S80, and 20 cm on the top, 10 cm on the left and right, and 10 cm at the back of SW-S80 — away from direct sunlight, heat sources, vibration, dust, moisture, and/or cold.
- 3 Locate this system away from other electrical appliances, motors, or transformers to avoid humming sounds. To prevent fire or electrical shock, do not place this system where it may get exposed to dripping or splashing, and never put any objects filled with liquids, such as vases, on the top of the system.
- 4 Do not expose this system to sudden temperature changes from cold to hot, and do not locate this system in an environment with high humidity (i.e. a room with a humidifier) to prevent condensation inside this system, which may cause an electrical shock, fire, damage to this system, and/or personal injury.
- 5 Avoid installing this system in a place where foreign objects and liquid might fall. It might cause a fire, damage to this system and/or personal injury. Do not place the following objects on this system:
 - Other components, as they may cause damage and/or discoloration on the surface of this system.
 - Burning objects (i.e. candles), as they may cause fire, damage to this system, and/or personal injury.
 - Containers with liquid in them, as they may cause electrical shock to the user and/or damage to this system.
- 6 Do not cover this system with a newspaper, tablecloth, curtain, etc. in order not to obstruct heat radiation. If the temperature inside this system rises, it may cause fire, damage to this system, and/or personal injury.
- 7 Do not plug in this system to a wall outlet until all connections are complete.
- 8 Do not operate this system upside-down. It may overheat, possibly causing damage.
- 9 Do not use force on switches, knobs and/or cords.
- 10 When disconnecting the power cord from the wall outlet, grasp the plug; do not pull the cord.
- 11 Do not clean this system with chemical solvents; this might damage the finish. Use a clean, dry cloth.
- 12 Only voltage specified on this system must be used. Using this system with a higher voltage than specified is dangerous and may cause fire, damage to this system, and/or personal injury. YAMAHA will not be held responsible for any damage resulting from use of this system with a voltage other than specified.
- 13 To prevent damage by lightning, disconnect the power cord from the wall outlet during an electrical storm.
- 14 Take care of this system so that no foreign objects and/or liquid drops inside this system.
- 15 Do not attempt to modify or fix this system. Contact qualified YAMAHA service personnel when any service is needed. The cabinet should never be opened for any reasons.
- 16 When planning to use this system for long periods of time (i.e. vacation), disconnect the AC power plug from the wall outlet.
- 17 Be sure to read the "TROUBLESHOOTING" section on common operating errors before concluding that this system is faulty.
- 18 Before moving this system, press STANDBY/ON to set this system in the standby mode, and disconnect the AC power plug from the wall outlet.

This system is not disconnected from the AC power source as long as it is connected to the wall outlet, even if this system itself is turned off. This state is called the standby mode. In this state, this system is designed to consume a very small quantity of power.

IMPORTANT

Please record the serial number of this system in the space below.

MODEL:

Serial No.:

The serial number is located on the bottom of AVR-S80 and the rear of SW-S80.

Retain this Owner's Manual in a safe place for future reference.

■ For U.K. customers

If the socket outlets in the home are not suitable for the plug supplied with this appliance, it should be cut off and an appropriate 3 pin plug fitted. For details, refer to the instructions described below.

Note

- The plug severed from the mains lead must be destroyed, as a plug with bared flexible cord is hazardous if engaged in a live socket outlet.

■ Special Instructions for U.K. Model

IMPORTANT

THE WIRES IN MAINS LEAD ARE COLOURED IN ACCORDANCE WITH THE FOLLOWING CODE:

Blue: NEUTRAL

Brown: LIVE

As the colours of the wires in the mains lead of this apparatus may not correspond with the coloured markings identifying the terminals in your plug, proceed as follows:

The wire which is coloured BLUE must be connected to the terminal which is marked with the letter N or coloured BLACK.

The wire which is coloured BROWN must be connected to the terminal which is marked with the letter L or coloured RED. Making sure that neither core is connected to the earth terminal of the three pin plug.

The name plate is located on the bottom of AVR-S80.

FREQUENCY STEP switch (China, Korean and General models only)

Because the interstation frequency spacing differs in different areas, set the FREQUENCY STEP switch (locating at the rear of AVR-S80) according to the frequency spacing in your area.

North, Central and South America: 100 kHz/10 kHz

Other area: 50 kHz/9 kHz

Before setting this switch, disconnect the AC power plug of this system from the AC outlet.

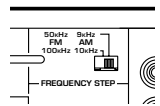

We Want You Listening For A Lifetime

YAMAHA and the Electronic Industries Association's Consumer Electronics Group want you to get the most out of your equipment by playing it at a safe level. One that lets the sound come through loud and clear without annoying blaring or distortion – and, most importantly, without affecting your sensitive hearing.

Since hearing damage from loud sounds is often undetectable until it is too late, YAMAHA and the Electronic Industries Association's Consumer Electronics Group recommend you to avoid prolonged exposure from excessive volume levels.



CAUTION

CONTENTS

INTRODUCTION

INTRODUCTION	2
FEATURES	2
CHECKING THE ACCESSORIES	3
INSTALLING BATTERIES IN THE REMOTE CONTROL	3
CONTROLS AND FUNCTIONS	4
Front panel	4
Remote control	5
Front panel display	7

PREPARATION

PREPARATION STEPS	8
SPEAKER SETUP	9
Speaker placement	9
Installing the speakers	10
CONNECTIONS	12
Connecting TV and audio/video components	12
Connecting the antennas	14
Connecting the speakers	15
Connecting to an external amplifier	17
Connecting the AC power cord	17
Turning on the power	17
ADJUSTING SPEAKER OUTPUT LEVELS	18
Using the test tone	18

USING BASIC FUNCTIONS

BASIC PLAYBACK	19
Basic operations	19
Selecting a sound field program	21
RECORDING	26

TUNING

TUNING	27
Automatic and manual tuning	27
Presetting stations	28
Exchanging preset stations	29
Tuning in to a preset station	29
RECEIVING RDS STATIONS (U.K. and Europe models only)	30
Description of RDS data	30
Changing the RDS mode	31
PTY SEEK function	31

REMOTE CONTROL FEATURES

OPERATING OTHER COMPONENTS USING THE REMOTE CONTROL	32
Setting the manufacturer code	32
Other component controlling functions	33

ADJUSTMENTS

SET MENU	35
List of SET MENU items	35
Adjusting the items on the SET MENU	35
1 SPEAKER SET (speaker mode settings)	36
2 LFE LEVEL	37
3 SP DLY TIME (speaker delay time)	38
4 D. RANGE (dynamic range)	38
5 L/R BALANCE (balance of the front left and right speakers)	38
6 HP TONE CTRL (headphone tone control)	38
7 INPUT MODE (initial input mode)	39
8 DISPLAY SET (brightness of front panel display)	39
9 SP/PRE OUT (output source settings)	39
ADJUSTING THE LEVEL OF THE EFFECT SPEAKERS	40
CHANGING THE PARAMETER SETTINGS FOR DSP PROGRAMS	41
Adjusting the delay time	41
Adjusting the parameter settings for PRO LOGIC II Music	42

APPENDIX

TROUBLESHOOTING	43
GLOSSARY	46
SPECIFICATIONS	47

INTRODUCTION

Thank you for purchasing this YAMAHA product. We hope it will give you many years of trouble-free enjoyment. For the best performance, read this manual carefully. It will guide you in operating your YAMAHA product. This product is a home theater sound system consisting of the components shown on the table at right. Please check the all components are contained without fail by referring to the table.

Model name	Category	No. of pcs.
AVR-S80	AV receiver	1
NX-S80S	Speaker (for front/rear)	4
NX-S80C	Center speaker	1
SW-S80	Subwoofer	1

FEATURES

The AVX-S80 is the Home Theater Sound System that delivers a powerful and realistic sound experience like that found in a movie theater just by combining the system with the TV.

The newest DSP programs will enhance the power and realism of various sources, from movies to concerts, and sporting events. Also, the SILENT CINEMA DSP program allows you to enjoy the sound field even through the headphones.

Since the AVX-S80 consists of an AV receiver, a center speaker, front speakers, rear speakers and a subwoofer, you can enjoy stronger bass and surround effects as well as a good balance throughout the speakers. Moreover, the One-touch connection of the speaker connectors designed exclusively for this system allows you to easily connect the speakers.

- ◆ Dolby Pro Logic/Dolby Pro Logic II decoder
- ◆ Dolby Digital/Dolby Digital + Matrix 6.1 decoder
- ◆ DTS/DTS + Matrix 6.1 decoder
- ◆ CINEMA DSP: Combination of YAMAHA DSP technology and Dolby Pro Logic, Dolby Digital or DTS
- ◆ Virtual CINEMA DSP
- ◆ SILENT CINEMA DSP
- ◆ Built-in 5.1-channel power amplifier
- ◆ Sophisticated FM/AM tuner
- ◆ Multi-function remote control which can also be used for other AV components of certain manufacturers

■ About this manual

-  indicates a tip for your operation.
- Some operations can be performed by using the buttons on either the main unit or the remote control. In this case, the operations performed by using the remote control are described in this manual.
- This manual is printed prior to production. Design and specifications are subject to change in part for the reason of the improvement in operativity ability, and others. In this case, the product has priority.
- Some of the illustrations and names of the package contents etc. written in this manual may differ from the actual products and the names written on the package etc.



Manufactured under license from Dolby Laboratories. "Dolby", "Pro Logic", and the double-D symbol are trademarks of Dolby Laboratories.



"DTS" and "DTS Digital Surround" are registered trademarks of Digital Theater Systems, Inc.

CHECKING THE ACCESSORIES

Check your package to make sure it contains the following items.

AVR-S80

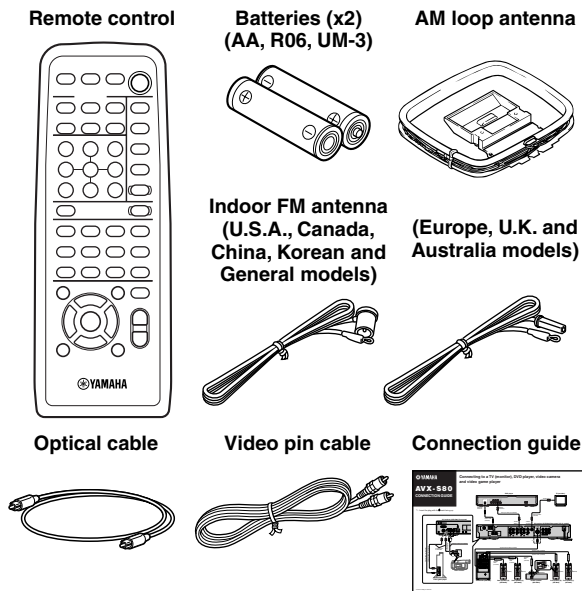

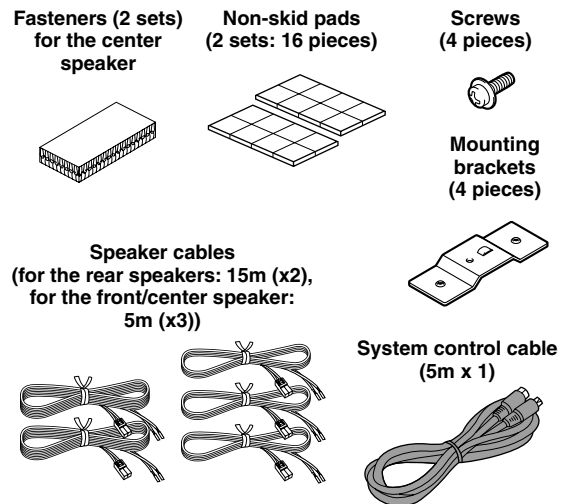

NX-SW80 (NX-S80S x4, NX-S80C, SW-S80)

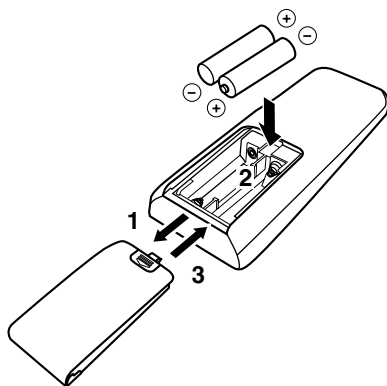

INSTALLING BATTERIES IN THE REMOTE CONTROL

Insert the batteries in the correct direction by aligning the + and – marks on the batteries with the polarity markings (+ and –) inside the battery compartment.



- 1** Press the  part and slide off the battery compartment cover.
- 2** Insert the two batteries (AA, R06, UM-3 type) with + and – oriented properly.
- 3** Slide the cover back on so that it snaps into place.

Notes on batteries

- Change all of the batteries if you notice a decrease in the operating range of the remote control.
- Do not use old batteries together with new ones.
- Do not use different types of batteries (such as alkaline and manganese batteries) together. Read the packaging carefully as these different types of batteries may have the same shape and color.
- If the batteries have leaked, dispose of them immediately. Avoid touching the leaked material or letting it come into contact with clothing, etc. Clean the battery compartment thoroughly before installing new batteries.

Preserving the manufacturer code

Replace batteries early before they become unusable. The manufacturer code set by the user will be preserved for about two minutes when batteries run out or when they are removed. Note that the manufacturer code setting may be lost if more than two minutes elapses. Also, if you press any button on the remote control accidentally while replacing batteries, the manufacturer code setting will be lost.

CONTROLS AND FUNCTIONS

Front panel

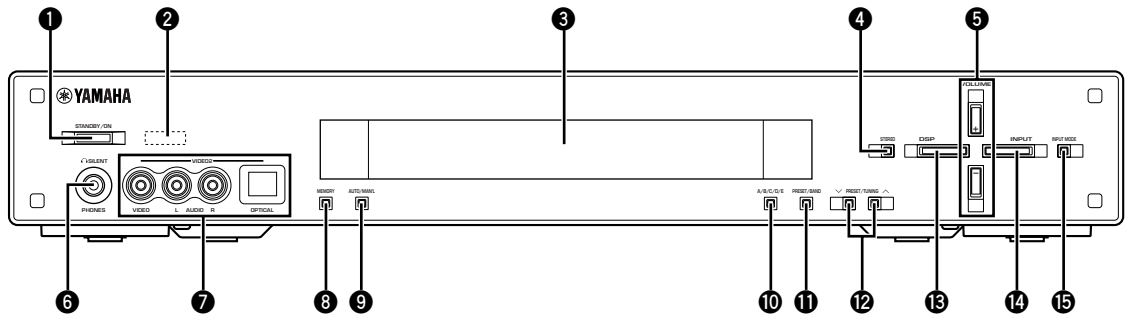

1 STANDBY/ON

Turns this system on, or set it to the standby mode. When you turn this system on, you will hear a click and there will be a 4 to 5-second delay before this system can reproduce sound.

Standby mode

In this mode, this system will consume a small amount of power in order to receive infrared-signals from the remote control.

2 Remote control sensor

Receives signals from the remote control.

3 Front panel display

Shows information about the operational status of this system.

4 STEREO

Switches between normal stereo and DSP effect reproduction. When STEREO is selected, 2-channel signals are directed to the front left and right speakers without effect sounds.

5 VOLUME +/-

Controls the output level of all audio channels. This does not affect the output level at the VCR OUT jacks.

6 PHONES (SILENT)

Allows you enjoy DSP effect for private listening with headphones. When you connect headphones, no signals are output to the speakers.

7 VIDEO 2 jacks

These jacks are for connecting a video component such as a camcorder or video game player. To select the component connected to these jacks, select "VIDEO2" with the INPUT button.

8 MEMORY

Stores the current station in the memory.

9 AUTO/MAN'L

Switches the tuning mode between automatic and manual.

10 A/B/C/D/E

Selects preset station groups A to E.

11 PRESET/BAND

Switches the reception band between FM and AM and also the mode between the tuning mode and the preset mode.

12 PRESET/TUNING

Selects preset station numbers 1 to 8 or the tuning frequency.

13 DSP

Selects the DSP program. This button is disabled when the stereo mode is selected by the STEREO button.

14 INPUT

Selects the input source you want to listen to or watch.

15 INPUT MODE

Sets the priority for the types of input signals (AUTO, DTS, ANALOG) to receive when one component is connected to both digital and analog input jacks.

Remote control

This section explains the function of each button on the remote control when you operate this system as an amplifier. Make sure that the AMP mode is selected before starting operation.

Refer to “OPERATING OTHER COMPONENTS USING THE REMOTE CONTROL” on pages 32–34 for the details about the remote control functions for controlling other components connected to this system.



- The buttons on the remote control whose names are written in purple are operation buttons when you operate this system in the AMP mode.

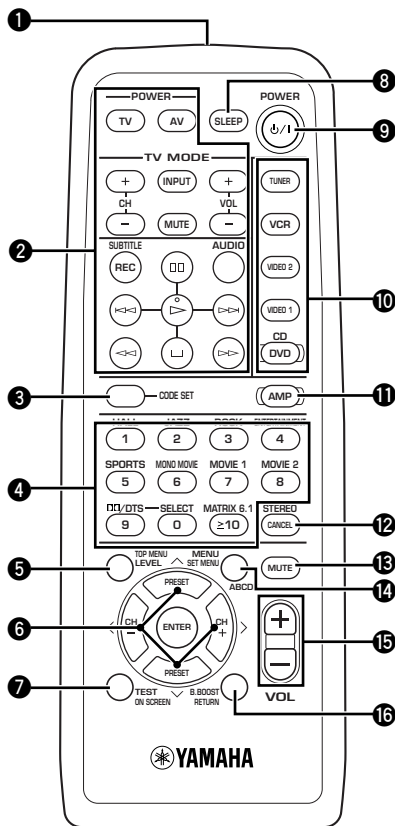

(U.S.A. model)

1 Infrared window

Outputs infrared control signals. Aim this window at the component you want to operate.

2 Basic operation buttons

Used to operate the components selected with input selector buttons.

3 CODE SET

Used when setting up the manufacturer code.

4 DSP program buttons

Select DSP programs for the AMP position. For some programs, pressing a button repeatedly selects its subprograms.

5 LEVEL

Selects the effect speaker channel to be adjusted.

6 Cursor buttons (<, >, ^, v)

Select SET MENU items and change the settings on the SETUP menu etc.

7 TEST

Outputs the test tone to adjust the speaker levels.

8 SLEEP

Sets the sleep timer.

9 POWER (⏻/⏷)

Turns this system on, or set it to the standby mode.

10 Input selector buttons

Select the input source and set the remote control to operate the selected source component. Sets the remote control to the AMP mode for controlling this system.

11 AMP

Switches the functions of the remote control buttons to the functions for controlling this system. The DSP program buttons, B.BOOST, etc. are made available by pressing this button.

12 STEREO

Switches between normal stereo and DSP effect reproduction. When STEREO is selected, 2-channel signals are directed to the front left and right speakers without effect sounds.

13 MUTE

Mutes the sound. Press again to restore the audio output to the previous volume level.

14 SET MENU

Selects the SET MENU mode.

15 VOL +/-

Increases or decreases the volume level.

16 B. BOOST

Turns BASS BOOST function on or off.

■ Using the remote control

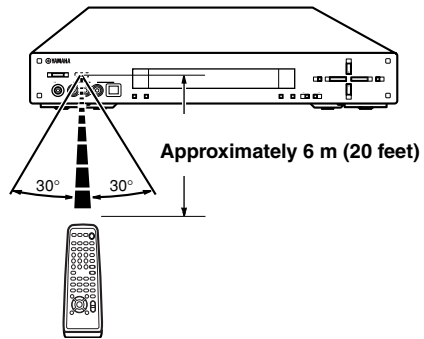

Handling the remote control

- Do not spill water or other liquids on the remote control.
- Do not drop the remote control.
- Do not leave or store the remote control in the following types of conditions:
 - high humidity or temperature such as near a heater, stove or bath;
 - dusty places; or
 - in places subject to extremely low temperatures.

Front panel display

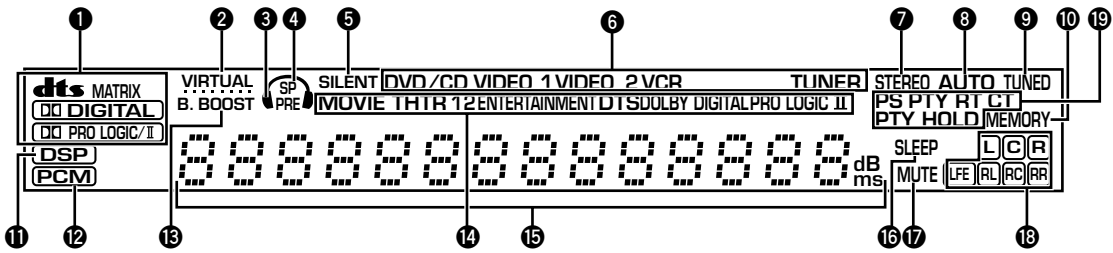

1 Decoder indicators

Lights up when the **dts**, **DIGITAL**, **PRO LOGIC II** or **MATRIX** are activated.

2 VIRTUAL indicator

Lights up in the Virtual CINEMA DSP mode.

3 Headphones indicator

Lights up when headphones are connected.

4 SP/PRE indicator

The indicator of the item selected in "9 SP/PRE OUT" on the SET MENU lights up. (But it does not light up when headphones are connected.)

5 SILENT indicator

Lights up when headphones are connected while the digital sound field processor is on.

6 Input source indicator

Shows the current input source with a cursor.

7 STEREO indicator

Lights up when this system is receiving a strong signal for an FM stereo broadcast while the "AUTO" indicator is lit.

8 AUTO indicator

Shows that this system is in the automatic tuning mode.

9 TUNED indicator

Lights up when this system is tuned to a station.

10 MEMORY indicator

Flashes to show a station can be stored.

11 DSP indicator

Lights up when you select DSP programs.

12 PCM indicator

Lights up when this system is reproducing PCM (pulse code modulation) digital audio signals.

13 B. BOOST indicator

Lights up when BASS BOOST is ON. (But it does not light up when headphones are connected.)

14 DSP program indicators

The name of the selected DSP program lights up when the ENTERTAINMENT, MOVIE THEATER 1, MOVIE THEATER 2 or **DIGITAL/DTS SURROUND** DSP program is selected.

15 Multi-information display

Shows the current DSP program name and other information when adjusting or changing settings.

16 SLEEP indicator

Lights up while the sleep timer is on.

17 MUTE indicator

Flashes while the MUTE function is on.

18 Input channel indicator

Indicates the channel components of input signals being received.

19 RDS indicator (U.K. and Europe models only)

The name(s) of the RDS data offered by the currently received RDS station light(s) up.

PTY HOLD indicator lights up while searching for stations in the PTY SEEK mode.

PREPARATION STEPS

In order to enjoy sound and video images with this sound system, follow the procedures as described below. See each page for details.

Installing batteries in the remote control (P.3)



Speaker setup (P.9)

- Speaker placement (P.9)
- Installing the speakers (P.10)



Connections (P.12 – 17)

- Connecting TV and audio/video components (P.12)
- Connecting the antennas (P.14)
- Connecting the speakers (P.15)
- Connecting the AC power cord (P.17)
- Turning on the power (P.17)



Adjusting speaker output levels (P.18)

Before connecting components

- Do not connect this system or other components to the mains power until all connections between the components have been completed.
- Be sure all connections are made correctly, that is to say, L (left) to L, R (right) to R, “+” to “+” and “-” to “-”. Some components require different connection methods and have different jack names. Refer to the operation instructions for each component to be connected to this system.
- Insert the plugs properly. The speakers may not output any sound or may output noise if they are not inserted properly.
- The name of jack corresponds to input selector.
- The VOLTAGE SELECTOR on the rear panel of AVR-S80 and SW-S80 must be set for your local main voltage BEFORE plugging into the AC main supply. Voltages are 110-120V/220-240V AC, 50/60 Hz. (China, Korean and General models only)

AVR-S80 (General model)

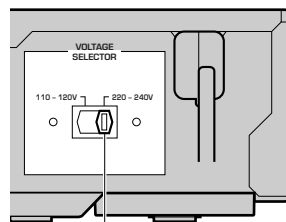

VOLTAGE SELECTOR

SW-S80 (General model)

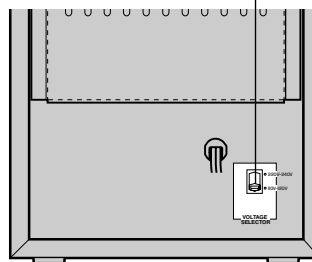

After connecting components

- Check them again to make sure they are correct.

SPEAKER SETUP

This system has been designed to provide the best sound-field quality with a 5-speaker system, using front left and right speakers, rear left and right speakers and a center speaker.

The front speakers are used for the main source sound plus effect sounds. The rear speakers are used for effect and surround sounds. The center speaker is for the center sounds (dialog, vocals, etc.).

Notes

- If you do not use any of effect speakers (rear and/or center), change the settings of SPEAKER SET items at the SET MENU (p.36) to designate the signals to other terminals you connect speakers to.
- If you use speakers (with different tonal qualities) instead of the included speakers, the tone of a moving human voice and other types of sound may not shift smoothly. We recommend that you use speakers from the same manufacturer or speakers with the same tonal quality.

Speaker placement

Refer to the following diagram when you place the speakers.

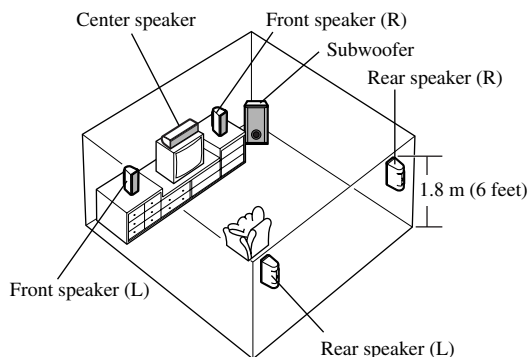

Front speakers

Place the front left and right speakers an equal distance from the ideal listening position. The distance between each speaker and each side of the video monitor should also be the same.

Center speaker

Align the front face of the center speaker with the front face of your video monitor. Place the speaker as close to the monitor as possible (such as directly over or under the monitor) and centrally between the front speakers.

Rear speakers

Place these speakers behind your listening position, facing slightly inwards, nearly 1.8 m (6 feet) above the floor.

Subwoofer

The position of the subwoofer is not so critical, because low bass sounds are not highly directional. But it is better to place the subwoofer near the front speakers. Turn it slightly toward the center of the room to reduce wall reflections.

Note

- Although the speaker system in this system is magnetically shielded, it may still affect the color on the television monitor when using this system near the television. Adjust the relative positions of this system and the television if this happens.

Installing the speakers

■ Placing the center speaker

Place the speaker on TV whose top is flat or on the floor under the TV or inside the TV rack so that it is stabilized. When placing the speaker on top of the TV, to prevent the speaker from falling down, put the provided fasteners at two points on the bottom of the speaker and the top of the TV.

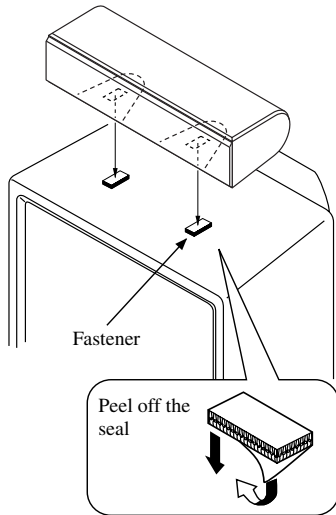

Cautions

- Do not place the speaker on top of the TV whose area is smaller than the bottom area of the speaker. If placed, the speaker may drop out causing an injury to you.
- Do not place the speaker on top of the TV with an inclination.
- Do not touch the adhesive surface after peeling off the seal as this will weaken its adhesive strength.
- Thoroughly wipe clean the surface where the fastener is to be applied. Note that adhesive strength is weakened if the surface is dirty, oily or wet and that this may cause the center speaker to drop.

■ Placing the front and rear speakers

When placing the front and rear speakers on a flat surface, attach the included non-skid pads to the corners on the bottom of the speakers as shown below. This prevents the speakers from sliding around.

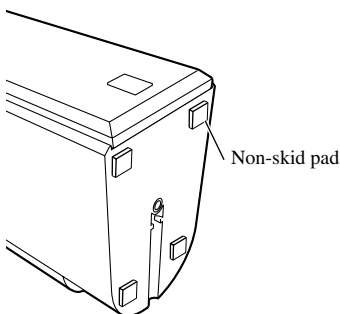

■ Mounting the front and rear speakers on a wall

When mounting the speakers on a wall, use the holes on the speakers' back panels.

1 Fasten screws into a firm wall or wall support as shown in the figure.

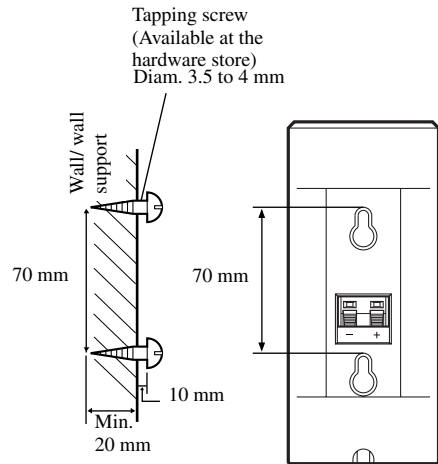

2 Hang the holes on the protruding screws.

Make sure that the screws are securely caught by the narrow parts of the holes.

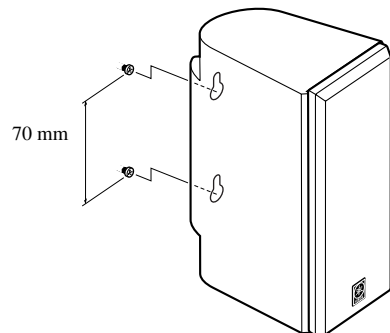

Warning

- Each speaker weighs 0.9 kg (11 lbs. 16 oz.). Do not mount them on thin plywood or a wall with soft surface material. If mounted, the screws may come out of the flimsy surface and the speakers may fall. This damages the speakers or causes personal injury.
- Do not install the speakers to a wall with nails, adhesives, or any other unstable hardware. Long-term use and vibrations may cause them to fall.
- To avoid accidents resulting from tripping over loose speaker cables, fix them to the wall.
- Select a proper position on the wall to mount the speaker so that no one will injure his/her head or face.

Using the Yamaha Speaker Stand SPS-80 (option)

By using the Yamaha Speaker Stand SPS-80, speakers can be placed on the floor. (Two stands make a set.)

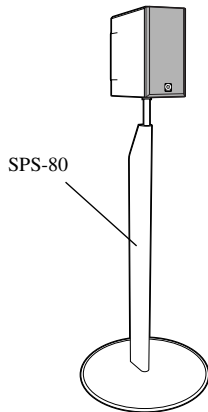

* The SPS-80 is not available in some areas.

■ If you want to mount a speaker on a commercially available speaker stand

The provided mounting bracket with 1 pair of screw holes (at an interval of 60 mm) can be used to mount the speaker on a speaker stand.

* Those screw holes can be used with M4 screws only.

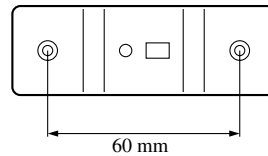

- 1** Attach the bracket to the bottom of the speaker by using the provided screw so that the convex part of the bracket fits in the grooved part on the bottom of the speaker as shown below.

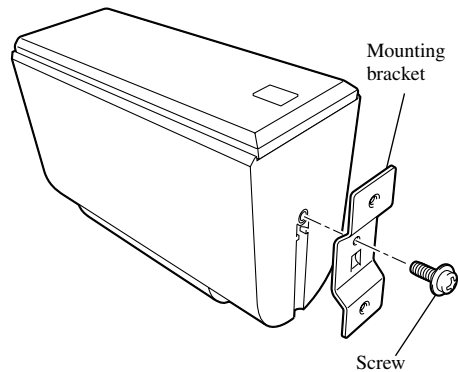

- 2** Mount the speaker on the speaker stand by using the screw holes on the bracket.

Note

The mounting bracket is provided for each speaker.

CONNECTIONS

Connecting TV and audio/video components

Types of audio jacks

Rear panel (U.S.A. model)

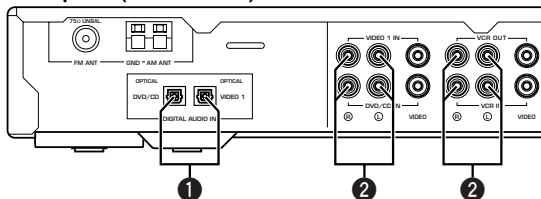

Front panel

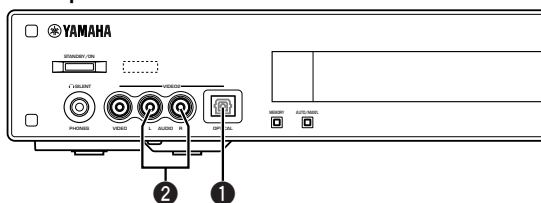

1 OPTICAL (digital) jack

Connects an optical cable and provides the better quality sound than analog audio jacks.

The cable can be inserted directly into the OPTICAL jack on the front panel.

For the OPTICAL jacks on the rear panel, first remove the anti-dust cap from a jack, and then connect the cable to the jack.

2 Analog audio jacks

Connect the audio pin cable of an audio/video cable.



- You can use the digital jacks to input PCM, Dolby Digital and DTS bitstreams.
- All digital input jacks are acceptable for 96-kHz or lower sampling digital signals.
- By connecting to the digital jacks, you can enjoy listening to the multi-channel sound track of a DVD source with sound field effects.

Notes

- The OPTICAL jacks on this system conform to the EIA standard. If you use an optical cable that does not conform to this standard, this system may not function properly.
- Once you have connected a recording component to this system, keep its power turned on while using this system. If the power is off, this system may distort the sound from other components.

Anti-dust cap

Remove the cap covering the OPTICAL jack when connecting an optical cable to an OPTICAL jack on the rear panel of this system. Safely store the cap and always re-insert it in the terminal when the terminal is not in use. (This cap prevents the entrance of dust.)



Type of video jacks

Rear panel (U.S.A. model)

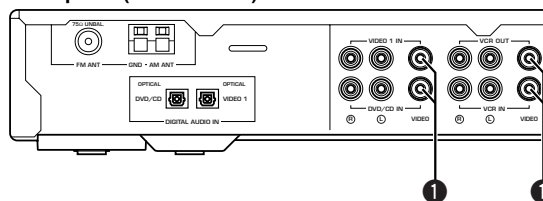

Front panel

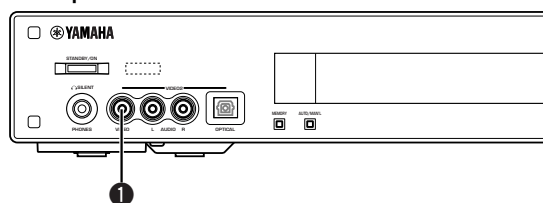

1 VIDEO jack

Inputs/outputs conventional composite video signal.

Note

- If you connect this system to a video monitor through a video cassette recorder, the picture may not be played back properly due to the copyright protection technology incorporated in this system.

■ The connection example

Use the following included or commercially available connection cables.

For Audio component



Optical cable

For Video Component

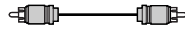

Video pin cable

For AV component

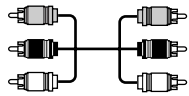

Audio/Video cable

The connection example shown below is just an example. Connect in accordance with the components you have.

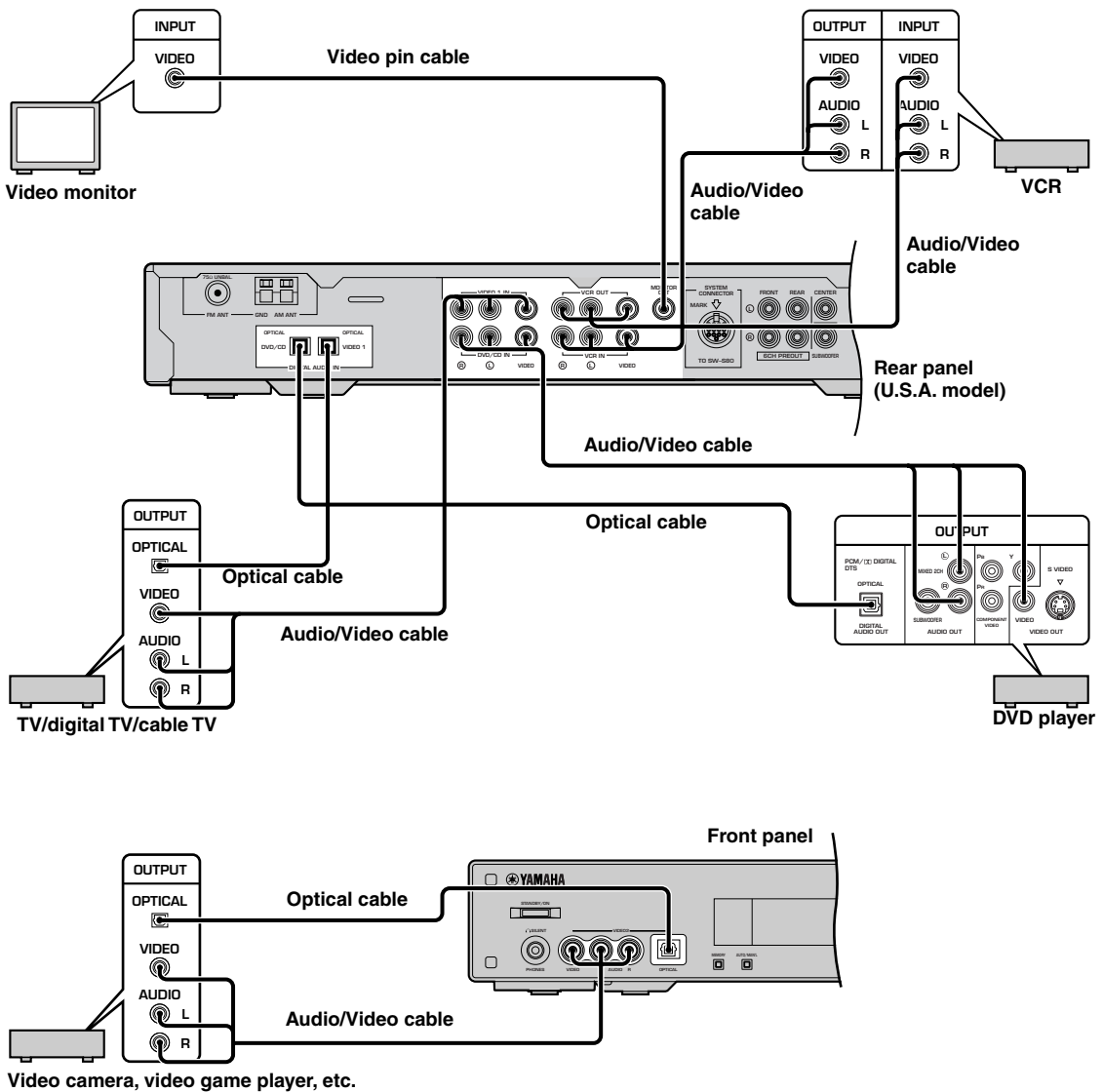

Connecting the antennas

Both AM and FM indoor antennas are included with this system. In general, these antennas should provide sufficient signal strength.

Connect each antenna correctly to the designated terminals.

■ Connecting indoor FM antenna

Connect the included indoor FM antenna to the FM ANT terminal.

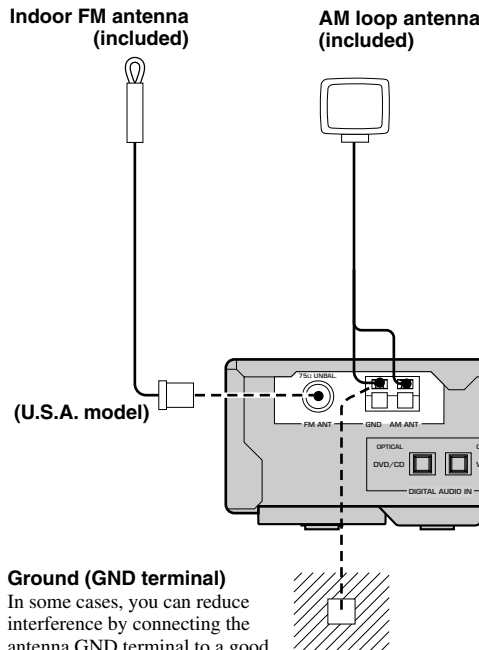

Ground (GND terminal)

In some cases, you can reduce interference by connecting the antenna GND terminal to a good earth ground. A good earth ground is a metal stake driven into moist earth.

■ Connecting the AM loop antenna

1 Set up the AM loop antenna, then connect it.

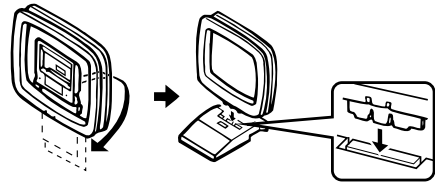

2 Press and hold the tab to insert the AM loop antenna lead wires into the AM ANT and GND terminals.

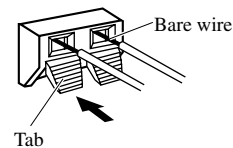

3 Release the tab. (The tab will return to its original position when you release your finger.)

Once connected, pull the wires gently to check that they are connected securely.

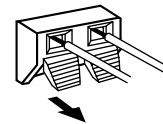

4 Orient the AM loop antenna for the best reception.



- A properly installed outdoor antenna provides clearer reception than an indoor one. If you experience poor reception quality, an outdoor antenna may improve the quality. Consult the nearest authorized YAMAHA dealer or service center about the outdoor antennas.

Notes

- The AM loop antenna should be placed away from this system.
- The AM loop antenna should always be connected, even if an outdoor AM antenna is connected to this system.

Connecting the speakers

Connect the included speakers to the AV receiver (AVR-S80) using the included speaker cables and system control cable as shown below.

AV receiver
(AVR-S80)

(U.S.A. model)

As this terminal is used for testing at the factory, do not connect any equipment to this terminal.

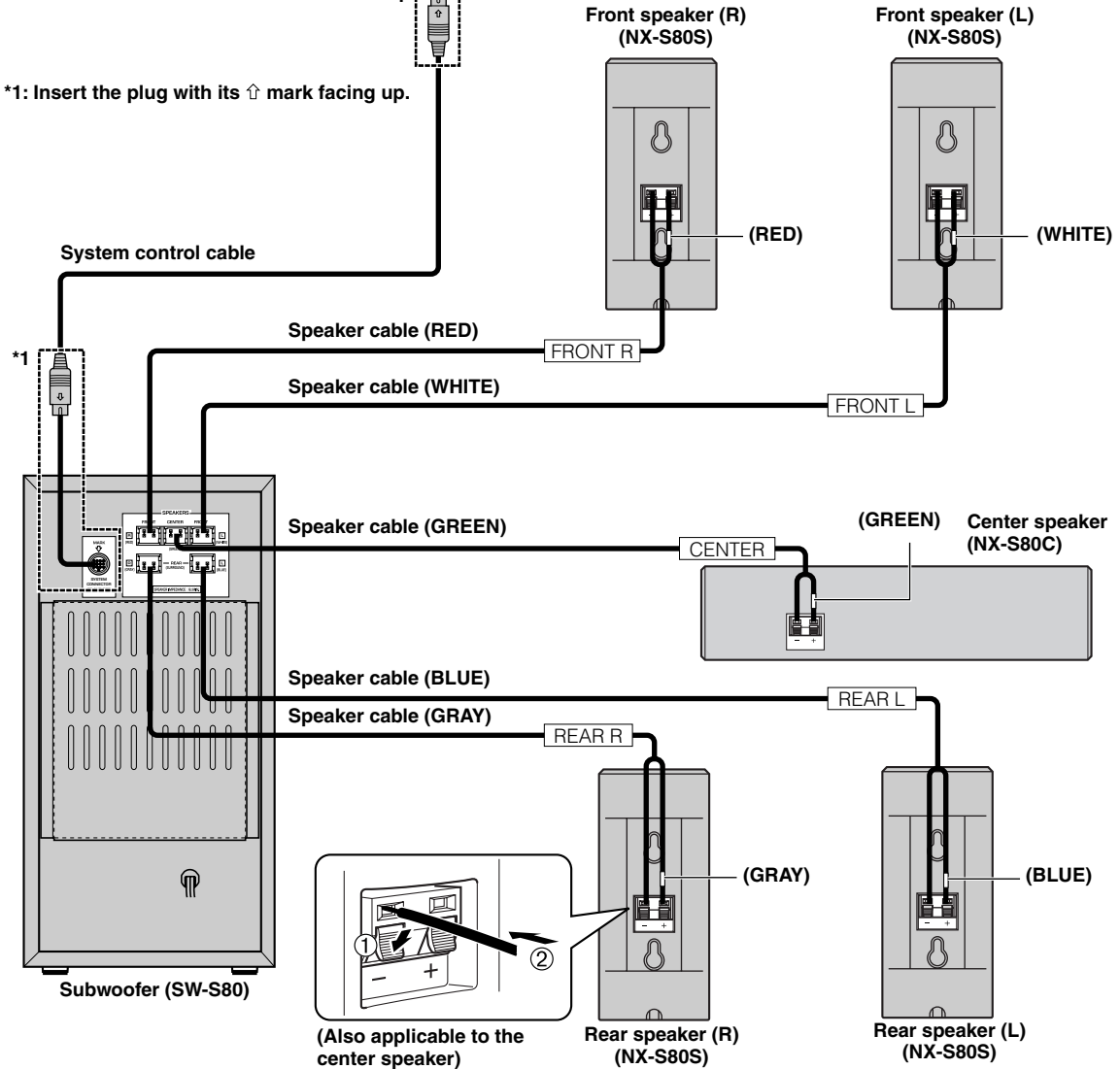

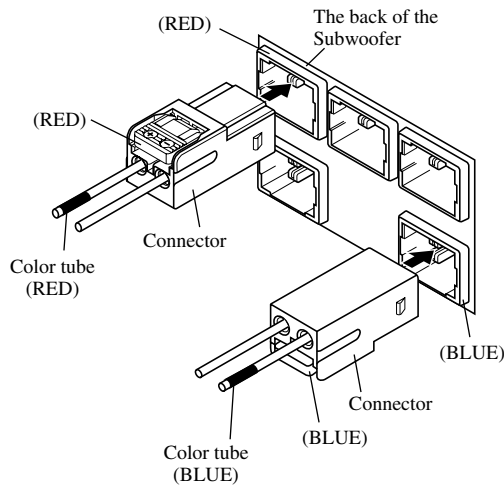

- The connector of the included speaker cable and the terminal of the subwoofer are classified by color. Connect a connector to the terminal of the same color.
- The label of the speaker is attached to each speaker cable. Connect the speakers in accordance with the labels.
- Connect the color tube of the speaker cable to the plus (+) side of each speaker. If the polarity of the speaker connections is incorrect, the sound will be unnatural and lack bass.
- A cover is attached to the end of the speaker cable. Connect the speakers after removing the cover.
- Make sure that the plugs of the system control cable and the connectors of the speaker cables are inserted correctly before inserting them.

Notes

- Do not let the bare speaker wires touch each other or any metal part of this system. This could damage this system and/or the speakers.
- Do not insert the plug or connector forcibly. Doing so may damage the plug, connector or terminal.
- Do not scratch, forcibly bend, or pull the system control or speaker cable as this may damage the cable, causing loss of audio output, and may possibly result in a fire or electric shock. Take particular care in making sure that the cable is not squashed by a rack or caster.
- Before disconnecting or connecting the system control cable, disconnect the power supply cord of the subwoofer and AV receiver.

Using commercially available speakers and speaker cables

You can use commercially available speaker cables and speakers except for a subwoofer. If you use them, note the following.

- Use the speaker whose impedance is 6Ω or higher. When using the speaker whose impedance is lower than 6Ω, the protection circuit may start working or this system may be damaged.
- Use magnetically shielded speakers. If this type of speakers still creates the interference with the monitor, place the speakers away from the monitor.
- Use the speaker cable that is as thick as the included cable. Too thick cables cannot be used.

Exchanging the speaker cables

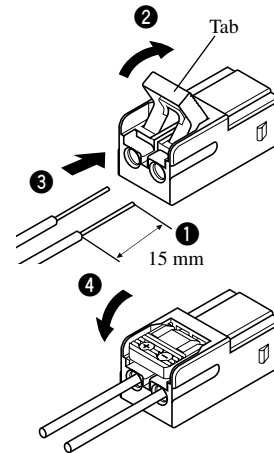

- 1 Remove approximately 15 mm (9/16") of insulation from each of the speaker cables.**
Twist the exposed wires of the cable together to prevent short circuits.
- 2 Open the tab.**
- 3 Pull the inserted bare wire of the speaker cable from the connector and insert the bare wire of the commercially available speaker cable.**
- 4 Return the tab to secure the wire.**

Connecting to an external amplifier

If you want to increase the power output to the speakers, or want to use another amplifier, connect an external amplifier to the 6CH PREOUT jacks as follows.

Note

- When you have connected this system to an external amplifier, select PRE or BOTH in “9 SP/PRE OUT” on the SET MENU. (See page 39.)

1 FRONT jacks

Front channel line output jacks.

2 REAR jacks

Rear channel line output jacks.

3 CENTER jack

Center channel line output jack.

4 SUBWOOFER jack

Low bass signals distributed from the front, center and/or rear channels are directed to this jack if they are assigned to this jack. (The cut-off frequency of this jack is 90 Hz.) The LFE (low-frequency effect) signals generated when Dolby Digital or DTS is decoded are also directed if they are assigned to this jack.

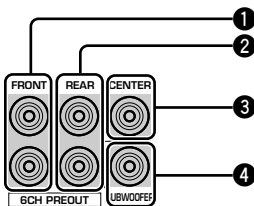

- The adjustments made in the following settings have an effect on the signals output from the 6CH PREOUT jacks.
 - BASS BOOST settings
 - Speaker settings
 - DSP programs

Connecting the AC power cord

Plug in this system to the wall outlet.

Memory back-up

The memory back-up circuit prevents the stored data from being lost when the power cord is disconnected from the AC outlet, or the power supply is temporarily cut due to power failure. However, if the system is turned off for more than one week, the stored setting will be cleared. If so, set the setting again.

- Volume level
- Input source
- Speaker output level (center, rear L/R and subwoofer)
- Sleep timer
- Parameter
- Delay time
- Set menu
- Preset station

Turning on the power

When all connections are complete, turn on the power of this system.

STANDBY/ON

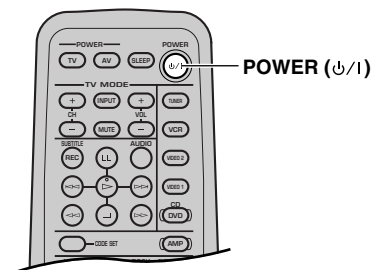
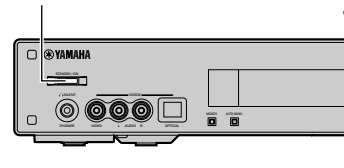

1 Press STANDBY/ON (POWER (⏻/⏻)) on the remote control to turn on the power of this system.

2 Turn on the video monitor connected to this system.

Note

- When you use only some of the included 6 speakers or when using commercially available speakers, adjust speaker mode settings soon after turning the power on. See “1 SPEAKER SET (speaker mode settings)” on page 36 for details.

ADJUSTING SPEAKER OUTPUT LEVELS

This section explains how to adjust speaker output levels using the test tone generator. When this adjustment is complete, the output level heard at the listening position should be the same from each speaker. This is important for best performance of the digital sound field processor, and the various decoders (Dolby Digital, Dolby Pro Logic, Dolby Pro Logic II and DTS).

Note

- Since this system cannot enter the test mode while headphones are connected to this system, be sure to unplug the headphones from the PHONES (SILENT) jack when using the test tone.

Using the test tone

Use the test tone to balance the output levels of the speakers.

Note

- The adjustment of each speaker output level should be made at your listening position using the remote control.

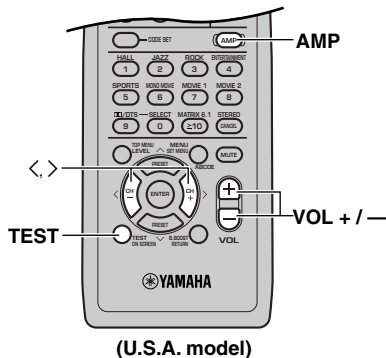

(U.S.A. model)

- 1 Press AMP.**
- 2 Press TEST to output the test tone.**
- 3 Press VOL +/- to adjust the volume of this system so you can hear the test tone.**

The test tone is heard (in order) from the LEFT (front left speaker), CENTER (center speaker), RIGHT (front right speaker), R SUR. (rear right speaker), L SUR. (rear left speaker), and the SUBWOOFER (subwoofer). The tone is produced for about 2 seconds from each speaker.

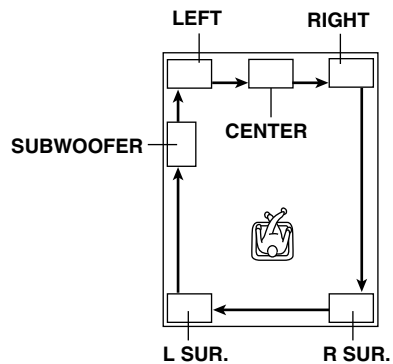

- 4 Adjust the level of the effect speakers using </> so that it matches the level of the front speakers.**

While adjusting, the test tone is heard from the selected speaker. After < or > is released, the test tone begins travelling to another speaker again.

Note

- To adjust the level of the front speakers, use VOL +/- on the remote control.

- 5 When adjustment is complete, press TEST to stop the test tone.**



- It is not necessary to readjust the speaker levels once they are set (as long as you do not change the speakers). You can enjoy listening to or watching the input source at the desired volume simply by pressing VOL +/- on the remote control.
- If the output level of the effect speakers (center, rear left, and rear right) cannot be increased enough to match the level of the front speakers, set "1E F. Level" on SET MENU to -10 dB (see page 37). This setting decreases the front speaker output level to about one-third of the normal level. After you have set "1E F. Level" on the SET MENU to -10 dB, adjust the levels for the center and rear speakers again.

Notes

- If "1A CENTER" on the SET MENU is set to NON, the level of the center speaker cannot be adjusted. The test tone skips the center speaker.
- If "1C REAR LR" on the SET MENU is set to NON, the output level of the rear left and right speakers cannot be adjusted in step 4. The test tone will be circulated skipping the rear right and left speakers.
- If "1D BASS" on the SET MENU is set to FRONT, the test tone will be circulated skipping the subwoofer.

BASIC PLAYBACK

Basic operations

You can play the software loaded on the audio and video components connected to this system.

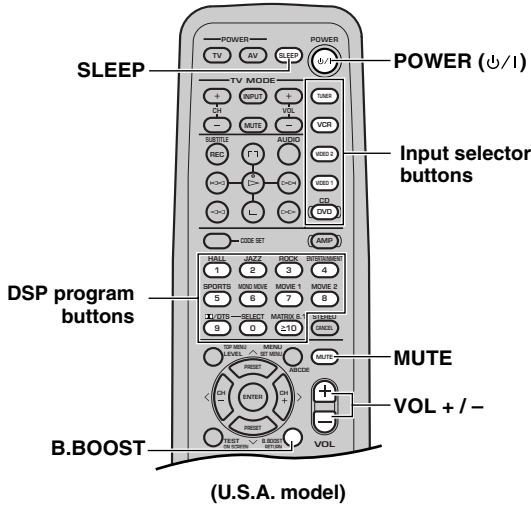

Indication on the front panel display (example):

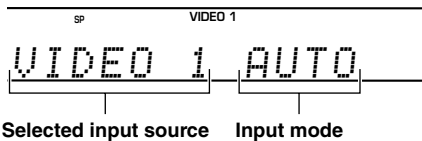

- 1** Press **POWER** (⏻/1) to turn on the power.
- 2** Turn on the **AV** component connected to this system.
- 3** Press **INPUT** on the front panel repeatedly (one of the input selector buttons on the remote control) to select the input source. The selected input source name and input mode appear on the front panel display for a few seconds.
- 4** Start playback or select a broadcast station on the source component. Refer to the operation instructions for the component.

5 Adjust the volume to the desired level.

The volume level is displayed digitally.

Example: -70 dB

Control range: VOLUME MUTE (minimum) to
0 dB (maximum)

Note

- If you have connected a recording component to the VCR OUT jacks, and you notice distortion or low volume during playback of other components, try turning the recording component on.

Enhancing the bass tones

First press **AMP**, then press **B. BOOST**.

- “Bass Boost ON” appears in the display.
- This function enhances the bass tones of the subwoofer by increasing the level of the low-range frequencies.
- To cancel B. BOOST mode, press B. BOOST again.



- The B. BOOST mode does not function when the headphones are connected.

Note

- If a thudding noise is heard from the subwoofer when this function is turned on, lower the subwoofer level. Otherwise, the subwoofer may be damaged due to an excessive input level of low-bass signal.

To mute the sound

Press **MUTE** on the remote control.

To resume the audio output, press MUTE again.



- You can also cancel mute by pressing VOL +/-, etc.
- During muting, the “MUTE” indicator flashes on the front panel display.

■ When you have finished using this system

Press STANDBY/ON on the front panel (POWER (⏻/⏪) on the remote control) to set this system in the standby mode.

■ Setting the sleep timer

Use this feature to automatically set this system in the standby mode after the amount of time you have set. The sleep timer is useful when you are going to sleep while this system is playing or recording a source.



- By connecting a commercially available timer to this system, you can also set a wake-up timer. Refer to the operation instructions of the timer.

(While playing a source)

Press SLEEP repeatedly to set the amount of time.

Each time you press SLEEP, the front panel display changes as shown below.

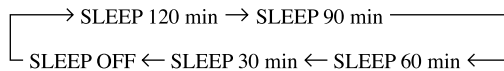

The “SLEEP” indicator lights up on the front panel display soon after the sleep timer has been set. The display then returns to the previous indication.

Canceling the sleep timer

Press SLEEP repeatedly until “SLEEP OFF” appears on the front panel display.

After a few seconds, “SLEEP OFF” disappears, the “SLEEP” indicator goes off and the display returns to the previous indication.



- The sleep timer setting can also be canceled by setting this system in the standby mode by using POWER (⏻/⏪) on the remote control (or STANDBY/ON on the front panel) or by disconnecting the AC power cord from the AC outlet.

■ Input modes and indications

This system comes with a variety of input jacks. You can select the type of input signals you desire.

Press INPUT MODE (the input selector button that you have pressed to select the input source on the remote control) repeatedly until the desired input mode is shown on the front panel display.

- **AUTO:** In this mode, the input signal is selected automatically as follows:
 - 1) Digital signal
 - 2) Analog signal
- **DTS:** In this mode, only the digital input signal encoded with DTS is selected.
- **ANALOG:** In this mode, only the analog input signal is selected.



- When AUTO is selected, this system automatically determines the type of signal. If this system detects a Dolby Digital or DTS signal, the decoder automatically switches to the appropriate setting.
- Each time you turn on the power of this system, the input mode is set according to “7 INPUT MODE” setting on the SET MENU (see page 39 for details).

Notes

- When playing a disc encoded with Dolby Digital or DTS on some LD players, the sound output may be delayed for a moment when playback resumes after a search because the digital signal is selected again.
- When playing a LD source that has not been digitally recorded, the sound may not be output for some LD players. In this case, set the input mode to ANALOG.

About playing DTS-CD/LDs

- If you use a player with a digital volume level controller, set the level to maximum when playing a source.
- If you play a source encoded with a DTS signal and set the input mode to ANALOG, this system may reproduce the noise of an unprocessed DTS signal. In this case, connect the source to a digital (optical) input jack and set the input mode to AUTO or DTS.
- If you switch the input mode to ANALOG while playing a source encoded with a DTS signal, this system reproduces no sound.
- If you play a source encoded with a DTS signal with the input mode set to AUTO;
 - This system automatically switches to the DTS-decoding mode (The “**dts**” indicator lights up) after having detected the DTS signal. When playback of the DTS source is completed, the “**dts**” indicator may flash. While this indicator is flashing, only DTS source can be played. If you want to play a normal PCM source soon, set the input mode back to AUTO.
 - When the input mode is set to AUTO and a search or skip operation is performed during playback of a DTS source, the “**dts**” indicator may flash. If this status continues for longer than 30 seconds, this system will automatically switch from “DTS-decoding” mode to PCM digital signal input mode. The “**dts**” indicator will turn off.

Selecting a sound field program

This system's built-in DSP (Digital Sound field Processor) can simulate various acoustic environments, including a concert hall and movie theater, with its 9 sound field programs. For the best results, choose a program appropriate for the selected audio source.

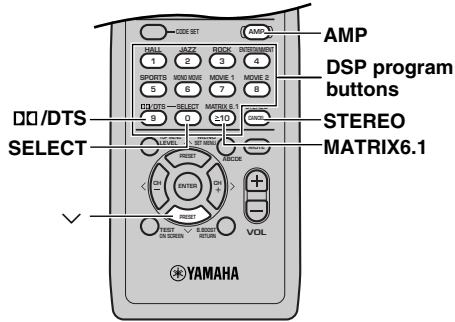

(U.S.A. model)

Indication on the front panel display (example):

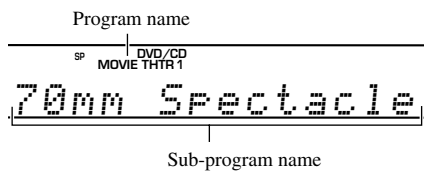

- 1** Press AMP.
- 2** Press one of the DSP program buttons on the remote control to select the desired program.
- 3** After selecting the desired program, press the same button repeatedly to select the desired sub-program if available.



- You can also select DSP program by pressing DSP on the front panel.
 DSP is not available when "STEREO" is illuminated on the display. To use DSP, press STEREO to turn "STEREO" off.
- Select the DSP program that you feel sounds best regardless of the name and description given for it below.

■ Feature of DSP programs

	No.	Program	Features
Hi-Fi DSP (for music sources)	1	CONCERT HALL	A large round concert hall with a rich surround effect. Pronounced reflections from all directions emphasize the extension of sounds. The sound field has a great deal of presence, and your virtual seat is near the center, close to the stage.
	2	JAZZ CLUB	This is the sound field at stage front in "The Bottom Line", a famous New York jazz club, that seats up to 300 people. Its wide left to right seating arrangement offers a real and vibrant sound.
	3	ROCK CONCERT	The ideal program for lively, dynamic rock music. The data for this program was recorded at LA's "hottest" rock club. The listener's virtual seat is at the center-left of the hall.
	4	ENTERTAINMENT/ Disco	This program recreates the acoustic environment of a lively disco in the heart of a big city. The sound is dense and highly concentrated. It is also characterized by a high-energy, "immediate" sound.
		ENTERTAINMENT/ 5ch Stereo	Using this program increases the listening position range. This is a sound field suitable for background music at parties, etc.

	No.	Program	Features
CINEMA-DSP (for video sources)	4	ENTERTAINMENT/ Game	This program adds a deep and spatial feeling to video game sounds.
		ENTERTAINMENT/ Concert Video	This program produces an enthusiastic atmosphere and lets you feel as if you are at an actual jazz or rock concert.
	5	TV SPORTS	With this program, you can enjoy watching various TV programs such as news, variety shows, music programs or sports programs. In a stereo broadcast of a sports game, the commentator is oriented at the center position, and the shouts and the atmosphere in the stadium spread on the surround side, while their spread to the rear is properly restrained.
	6	MONO MOVIE	This program is provided for reproducing monaural video sources (such as old movies). The program produces the optimum reverberation to create sound depth by using only the presence sound field.
CINEMA-DSP (for cinema sources)	7	MOVIE THEATER 1/ Spectacle	This program creates the extremely wide sound field of a 70-mm movie theater. It precisely reproduces the source sound in detail, making both the video and the sound field incredibly real. This is ideal for any kind of video source encoded with Dolby Surround, Dolby Digital or DTS (especially large-scale movie productions).
		MOVIE THEATER 1/ Sci-Fi	This program clearly reproduces dialog and sound effects in the latest sound form of science fiction films, thus creating a broad and expansive cinematic space amid the silence. You can enjoy science fiction films in a virtual-space sound field that includes Dolby Surround, Dolby Digital and DTS-encoded software employing the most advanced techniques.
	8	MOVIE THEATER 2/ Adventure	This program is ideal for precisely reproducing the sound design of the newest 70-mm and multichannel soundtrack films. The sound field is made to be similar to that of the newest movie theaters, so the reverberations of the sound field itself are restrained as much as possible.
		MOVIE THEATER 2/ General	This program is for reproducing sounds from 70-mm and multichannel soundtrack films, and is characterized by a soft and extensive sound field. The presence sound field is relatively narrow. It spatially spreads all around and toward the screen, restraining the echo effect of conversations without losing clarity.
	9	DSP/DTS/Enhanced	This program ideally simulates the multi-surround speaker systems of the 35-mm film theaters. Dolby Pro Logic and Dolby Pro Logic II decoding, Dolby Digital decoding or DTS decoding and digital sound field processing create precise effects without altering the original sound orientation. The surround effects produced by this sound field wrap around the viewer naturally from the back to the left and right, and toward the screen.
STRAIGHT DECODE	9	DSP/DTS/Normal	The built-in decoder precisely reproduces sounds and sound effects from sources. The highly efficient decoding process improves crosstalk and channel separation and makes sound positioning smoother and more precise. In this program, no DSP effect is applied.



- When you set this system in the standby mode, the current source and DSP program are memorized and are automatically selected when you turn on the power again.
- When you select an input source, this system automatically selects the last DSP program used with that source.
- The “ **DSP** ” indicator does not light up when selecting program No. 9 except in Enhanced mode.
- The acoustics of your listening room affect the DSP program. It is recommended to use a room with fewer sound reflections to maximize the effect created by the program.

Notes

- There are 9 programs with sub-programs available with this system. However, the selection depends on the input signal format and not all sub-programs can be used with all input signal formats.
- When a monaural source is being played with PRO LOGIC/Normal or PRO LOGIC/Enhanced, or PRO LOGIC II Movie, sound will be hardly heard from the front speakers and the rear speakers. Sound can only be heard from the center speaker. (If “1A CENTER” on the SET MENU is set to NON, the center channel sound is output from the front speakers.)

■ Table of Program Names for Each Input Format

This system automatically chooses the appropriate decoder and DSP sound field pattern according to the input signal format.

No.	Input Program	2 channel	5.1 channel		6.1 channel *	
		ANALOG, PCM, DOLBY DIGITAL, DTS	DOLBY DIGITAL	DTS	DOLBY DIGITAL + Matrix 6.1	DTS + Matrix 6.1
7	MOVIE THEATER 1	70 mm Spectacle	DGTL Spectacle	DTS Spectacle	Spectacle 6.1	Spectacle 6.1
		70 mm Sci-Fi	DGTL Sci-Fi	DTS Sci-Fi	Sci-Fi 6.1	Sci-Fi 6.1
8	MOVIE THEATER 2	70 mm Adventure	DGTL Adventure	DTS Adventure	Adventure 6.1	Adventure 6.1
		70 mm General	DGTL General	DTS General	General 6.1	General 6.1
9	DOLBY DIGITAL	—	Normal	—	Matrix 6.1	—
		—	Enhanced	—	Enhanced 6.1	—
	DTS DIGITAL SUR	—	—	Normal	—	Matrix 6.1
		—	—	Enhanced	—	Enhanced 6.1
	PRO LOGIC	Normal	—	—	—	—
		Enhanced	—	—	—	—
	PRO LOGIC II	Movie	—	—	—	—
		Music	—	—	—	—

* Only when the Matrix 6.1 decoder is ON.



- If Dolby Digital Surround EX software or DTS ES software is played when AUTO is selected by pressing the MATRIX 6.1 button on the remote control, the Dolby Digital + Matrix 6.1 or DTS + Matrix 6.1 decoder usually turns on and the corresponding DSP program is selected.
- MATRIX 6.1 on the remote control can be used to play Dolby Digital or DTS 5.1 channel sources with the virtual rear center speaker. In this case the program name changes to the corresponding name for 6.1 channel.
- When playing a 6.1 channel source with MATRIX 6.1 on the remote control turned off, the program name changes to the corresponding name for 5.1 channel.

■ Selecting PRO LOGIC II

You can enjoy the 2-channel sources decoded into five discrete channels by selecting PRO LOGIC II in program No. 9.

(While playing a 2-channel source)

1 Press AMP.

2 Press DDD/DTS.

The previously selected sub program appears on the front panel display.

3 Press SELECT repeatedly to select the decoder, PRO LOGIC II.

4 After selecting on the decoder (PRO LOGIC II), select the mode appropriate for the source by pressing DDD/DTS.

The selection switches as follows:
PRO LOGIC II Movie ↔ PRO LOGIC II Music



- You can select PRO LOGIC, PRO LOGIC II Movie, and PRO LOGIC II Music by pressing DSP on the front panel repeatedly.

Note

- Playback using DOLBY PRO LOGIC II decoders is possible only for 2-channel signals.

■ Playing Dolby Digital Surround EX or DTS ES software

While playing a 5.1-channel source, press MATRIX 6.1 to turn on the Dolby Digital + Matrix 6.1 or DTS + Matrix 6.1 decoder.

The rear center channel is created from rear left and right channels, and output from virtual rear center speaker.

While playing a 5.1-channel source, the display changes AUTO → Matrix6.1 → OFF each time the MATRIX 6.1 button is pressed.

- AUTO: This mode automatically switches Dolby Digital + Matrix 6.1 and DTS + Matrix 6.1 depending on the signal. Virtual rear center speaker does not work for 5.1 channel sources.
- Matrix6.1: This setting produces 6-channel playback of the input source using the Matrix 6.1 decoder. The virtual rear center speaker can be used when playing a 5.1-channel source.
- OFF: Virtual rear center speaker does not work in this setting.



- When the Matrix 6.1 decoder is functioning, the “MATRIX” indicator lights up on the front panel display.

Notes

- Some Dolby Digital Surround EX or DTS ES software may not contain the signal that is necessary for this system to switch to the Matrix 6.1 decoding mode. To turn on the Matrix 6.1 decoder when playing such a source, press Matrix6.1.
- Playing a 6.1-channel source is not possible even if MATRIX6.1 is pressed in the following cases:
 - when “1C REAR LR” in the SET MENU is set to NON;
 - when the sound effect is turned off;
 - when headphones are connected;
 - when a Dolby Digital KARAOKE source is being played;
 - when 5ch Stereo is selected.
- The setting becomes AUTO once this system turns into standby mode.

■ Virtual CINEMA DSP

With Virtual CINEMA DSP, you can enjoy all DSP programs without rear speakers. It creates virtual speakers to reproduce a natural sound field.

You can listen to Virtual CINEMA DSP by setting “1C REAR LR” in the SET MENU to NON. Sound field processing changes to Virtual CINEMA DSP automatically.



- When Virtual CINEMA DSP is functioning, the “VIRTUAL” indicator lights up on the front panel display.

Note

- This system is not set in the Virtual CINEMA DSP mode even if “1C REAR LR” is set to NON in the following cases:
 - when the 5ch Stereo, DOLBY DIGITAL Normal, Pro Logic Normal, Pro Logic II, or DTS Normal program is selected;
 - when the sound effect is turned off;
 - when 96-kHz sampling digital signals are input to this system;
 - when using the test tone; or
 - when connecting the headphones.

■ SILENT CINEMA DSP

You can enjoy a powerful sound field similar to what you could expect from actual speakers with SILENT CINEMA DSP. You can listen to SILENT CINEMA DSP by connecting your headphones to the PHONES (🎧 SILENT) jack while the digital sound field processor is on. Enjoy all the DSP program using the headphones. The “SILENT” indicator lights up on the front panel display. (When sound effects are off, you listen to the source with normal stereo reproduction.)



- When SILENT CINEMA DSP is functioning, the “SILENT” indicator lights up on the front panel display.

Notes

- This feature is not available when 96-kHz sampling digital signals are input to this system.
- The sound of LFE channel will be mixed and output from the headphone.

■ Normal Stereo Reproduction

Press STEREO to turn off the sound effect for normal stereo reproduction.

Press STEREO again to turn the sound effect back on.

Notes

- If you turn off the sound effects, no sound is output from the center or rear speakers.
- The volume may be greatly reduced when you turn off the sound effects or if you set “4 D. RANGE” on the SET MENU to MIN. In this case turn on the sound effect.
- The sound of LFE channel will be directed to the front left and right or the subwoofer (or both) channels depending on the setting of “ID BASS” on the SET MENU.
- If you turn off the sound effects while a Dolby Digital or DTS signal is being output, the dynamic range of the signal is automatically compressed and the sounds of the center and rear speaker channels are mixed and output from the front speakers.

■ Displaying the information about input signal

During stereo reproduction, you can display information such as the type, format and sampling frequency of the signal input from the components connected to this system.

(While playing a stereo source)

- 1 Press AMP.
- 2 Press \vee to display the information about the input signal.



• Format:

The type of an input signal. When digital input is not known, the mode is set to the analog mode.

Input signal	Display
Analog signal	Analog
PCM signal	PCM
Dolby Digital signal	Dolby Digital
DTS signal	DTS
Other digital signals	Unkwn Digital (Unknown Digital)

• fs:

The sampling frequency of an input signal when a digital signal is input. If the frequency is not known, “unknown” appears on the front panel display.

• Audio Channels:

The number of audio channels included in an input signal when a Dolby Digital or DTS signal is input.

• Rate (bit rate):

The amount of data contained in an input signal per second when a Dolby Digital or DTS signal is input. If the bit rate is not known, “unknown” appears on the front panel display.

• Flg (flag):

An identification signal contained in an input signal when a Dolby Digital or DTS signal is input. If the flag is not detected, “None” appears on the front panel display.

■ About 96-kHz sampling digital signals

The digital input jacks of this system can handle 96-kHz sampling digital signals. Note the following when 96-kHz sampling digital signal is input to this system:

- DSP programs cannot be selected.
- Sound will be output as 2-channel stereo from only the front left and right speakers. (There may be sound output from the subwoofer depending on the SPEAKER SET settings on the SET MENU.) Therefore, the level of the effect speakers cannot be adjusted while listening to such a source.

RECORDING

Recording adjustments and other operations are performed from the recording components. Refer to the operation instructions for these components.

1 Turn on the power of this system and all connected component.

2 Select the source component you want to record from.

The procedure for selecting an input source is the same as the one described in "BASIC PLAYBACK" on page 19.

3 Start playback (or select a broadcast station) on the source component.

4 Start recording on the recording component.

Notes

- Do a test recording before you start an actual recording.
- When this system is set in the standby mode, you cannot record between the components connected to this system.
- The setting of BASS BOOST, VOLUME, "5 L/R BALANCE" on the SET MENU and DSP programs does not effect the recorded material.
- The signal input from VCR IN is not output to VCR OUT.
- Check the copyright laws in your country to record from records, CDs, radio, etc. Recording of copyrighted material may infringe copyright laws.
- It is not possible to record the sound effect created by this system's DSP processing.

If you playback a video source that uses scrambled or encoded signals to prevent it from being dubbed, the picture itself may be disturbed due to those signals.

■ Timer playback/recording

This system can perform playback or recording with an external timer (not supplied). Refer to the operating instructions for the component and the timer to be used.

Notes

- Stored data, such as input source, will be reflected when playback or recording with the timer.
- If you do not want any sound output when recording with a timer, turn the volume down.

TUNING

Indication on the front panel (example)

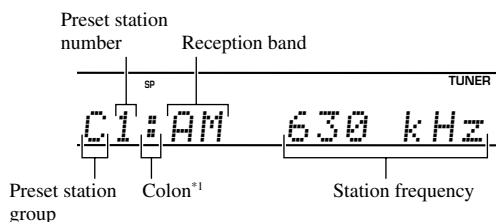

^{*1}The colon (:) lights up in the preset mode and goes off in the tuning mode.

Automatic and manual tuning

There are 2 ways to tune; automatic and manual. Automatic tuning is effective when station signals are strong and there is no interference.

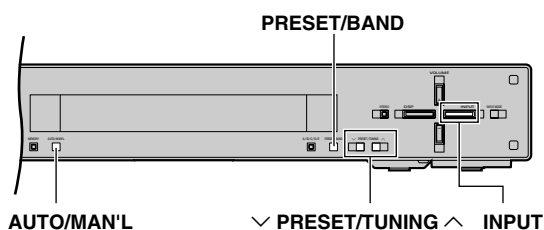

Automatic tuning

- 1 Press INPUT (TUNER on the remote control) to select TUNER as the input source.**
- 2 Press PRESET/BAND to select the reception band. ("FM" or "AM")**
Each time PRESET/BAND is pressed, the mode changes as follows:
FM (Tuning mode) → AM (Tuning mode) → (Preset mode) → FM (Tuning mode) → ...
- 3 Press AUTO/MAN'L so that the "AUTO" indicator lights up on the front panel display.**
- 4 Press ∨ PRESET/TUNING ∧ once to begin automatic tuning.**
Press ∧ to tune in to a higher frequency, or press ∨ to tune in to a lower frequency.



- Use the manual tuning method if the tuning search does not stop at the desired station because the signal is weak.
- When tuned in to a station, the "TUNED" indicator lights up and the frequency of the received station is shown on the front panel display.

Manual tuning

If the signal from the station you want to select is weak, you must tune in to it manually.

- 1 Select TUNER and the reception band following steps 1 and 2 described in "Automatic tuning" at left.**
- 2 Press AUTO/MAN'L so that the "AUTO" indicator goes off from the front panel display.**
- 3 Press ∨ PRESET/TUNING ∧ to tune in to the desired station manually.**
Hold down the button to continue the tuning search.



- Manually tuning in to an FM station will automatically change the reception mode to monaural to increase the signal quality.

Presetting stations

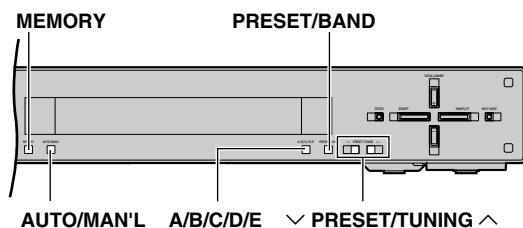

■ Automatically presetting stations (for FM stations)

This function enables this system to automatically tune in to FM stations with strong signals, and to store up to 40 (8 stations x 5 groups) of those stations in order. This feature enables you to easily tune in to any preset station by selecting the preset station number.

- 1** Press PRESET/BAND to select the FM band.
- 2** Press AUTO/MAN'L so that the "AUTO" indicator lights up on the front panel display.

- 3** Press and hold MEMORY for more than 3 seconds.

The preset number and the "MEMORY" and "AUTO" indicators flash. Then, after about 5 seconds, automatic preset tuning begins from the frequency currently displayed toward the higher frequencies.

When automatic preset tuning is completed, the front panel display shows the frequency of the last preset station.



- When a station data is stored under a preset number, the frequency and reception band are also stored.
- You can manually replace a preset station with another FM or AM station by simply following the procedure in the section "Exchanging preset stations" on page 29.
- If the number of the received stations does not reach E8, automatic preset tuning has automatically stopped after searching all stations.

Notes

- Any stored station data existing under a preset number is cleared when you store a new station under that preset number.
- Only FM stations with sufficient signal strength are stored automatically by automatic preset tuning. If the station you want to store is weak in signal strength, tune in to it manually in the monaural mode, and store it by following the procedure in "Manually presetting stations".
You can also store AM stations manually.

Automatic preset tuning options

You can select the preset group and number from which this system will store FM stations and/or begin tuning toward lower or higher frequencies.

- 1** Follow steps 1 and 2 described in "Automatically presetting stations (for FM stations)" on the left.

(After keeping MEMORY pressed for more than 3 seconds)

- 2** Press A/B/C/D/E and ∨ PRESET/TUNING ^ to select the preset number under which the first station will be stored.

Automatic preset tuning will stop when stations have all been stored up to E8.

- 3** Press PRESET/BAND to turn off the colon (:), and then press ∨ PRESET/TUNING ^.

When pressing ∨, automatic preset tuning begins from the frequency currently displayed toward the lower frequencies, and when pressing ^, it begins toward the higher ones.

■ Manually presetting stations

You can also store up to 40 stations (8 stations x 5 groups) manually.

You can also store AM stations manually.

- 1** Tune in to a station.

See page 27 for tuning instructions.

When tuned in to a station, the front panel display shows the frequency of received station.

- 2** Press MEMORY.

The "MEMORY" indicator flashes for about 5 seconds.

- 3** Press A/B/C/D/E repeatedly to select a preset station group (A to E) while the "MEMORY" indicator is flashing.

The group letter appears and make sure that the colon (:) appears on the front panel display.

- 4** Press ∨ PRESET/TUNING ^ to select a preset station number (1 to 8) while the "MEMORY" indicator is flashing.

Press ^ to select a higher preset station number.
Press ∨ to select a lower preset station number.

- 5** Press **MEMORY** on the front panel while the “**MEMORY**” indicator is flashing.

The station band and frequency appear on the front panel display with the preset group and number you have selected.

- 6** Repeat steps 1 to 5 to store other stations.

Notes

- Any stored station data existing under a preset number is cleared when you store a new station under that preset number.
- The reception mode (stereo or monaural) is stored along with the station frequency.

Exchanging preset stations

You can exchange the assignment of two preset stations. The example below describes the procedure for exchanging preset station “E1” with “A5”.

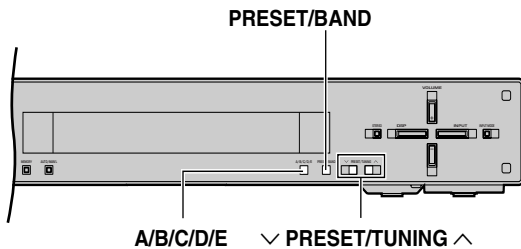

- 1** Tune in to preset station “E1” by using the **A/B/C/D/E** and **PRESET/TUNING** \wedge . See “Tuning in to a preset station” at right.
- 2** Press and hold **PRESET/BAND** for more than **3 seconds**. “E1” appears and the “MEMORY” indicator flashes on the front panel display.
- 3** Tune in to preset station “A5” by using the **A/B/C/D/E** and **PRESET/TUNING** \wedge . “A5” appears and the “MEMORY” indicator flashes on the front panel display.
- 4** Press **PRESET/BAND** again. “EDIT E1-A5” appears on the front panel display, and then the preset stations are exchanged.

Tuning in to a preset station

You can tune any desired station simply by selecting the preset station number under which it was stored.

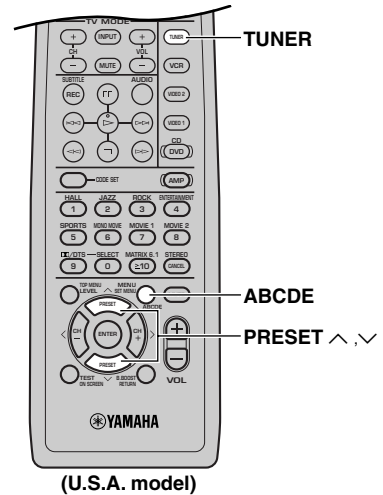

- 1** Press **TUNER**.
- 2** Press **ABCDE** (**A/B/C/D/E** on the front panel) to select the preset station group. The preset group letter appears on the front panel display and changes each time you press **ABCDE**.
- 3** Press **PRESET** \wedge / \vee (**PRESET/TUNING** \wedge on the front panel) to select a preset station number (1 to 8). The preset group and number appear on the front panel display along with the station band and frequency, and the “TUNED” indicator lights up.

RECEIVING RDS STATIONS (U.K. and Europe models only)

RDS (Radio Data System) is a data transmission system by FM stations in many countries.

RDS data contains various information such as PS (Program Service name), PTY (Program Type), RT (Radio Text), CT (Clock Time), etc. The RDS function is carried out among the network stations.

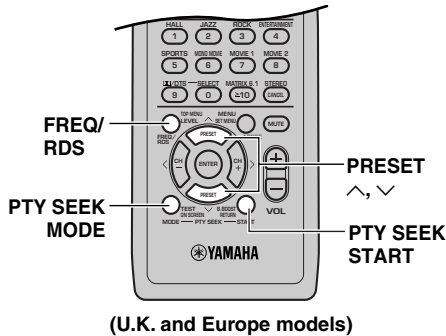

(U.K. and Europe models)

FREQ/RDS

When an RDS station is received, press this button to change the display mode among the PS mode, PTY mode, RT mode, CT mode (if the station offers those RDS data service) and/or frequency display mode in turn.

PTY SEEK MODE

Press this button to set the system in the PTY SEEK mode.

PTY SEEK START

Press this button to begin searching for a station after the desired program type has been selected in the PTY SEEK mode.

Description of RDS data

This system can receive, PS, PTY, RT and CT data when receiving RDS broadcasting stations.

■ PS (Program Service name) mode:

The name of the RDS station being received is displayed.

■ PTY (Program Type) mode:

There are 15 program types to classify RDS stations.

NEWS	News
AFFAIRS	Current affairs
INFO	General information
SPORT	Sports
EDUCATE	Education
DRAMA	Drama
CULTURE	Culture
SCIENCE	Science
VARIED	Light entertainment
POP M	Pops
ROCK M	Rock
M.O.R. M	Middle-of-the-road music (easy-listening)
LIGHT M	Light classics
CLASSICS	Serious classics
OTHER M	Other music

■ RT (Radio Text) mode:

Information about the program (such as the title of the song, name of the singer, etc.) on the RDS station being received is displayed by a maximum of 64 alphanumeric characters, including the umlaut symbol. If other characters are used for RT data, they are displayed with under-bars.

■ CT (Clock Time) mode:

The current time is displayed and updated every minute. If the data are accidentally cut off, "CT WAIT" may appear.

Changing the RDS mode

The four modes are available in this system for displaying RDS data. When an RDS station is being received, PS, PTY, RT and/or CT mode indicators that correspond to the RDS data services offered by the station light up on the front panel display. Press **FREQ/RDS** repeatedly to change the display mode among the RDS data offered by the transmitting station in the order shown below.

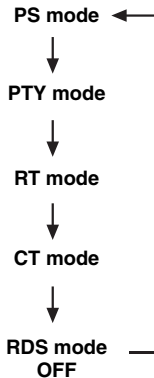

Notes

- When an RDS station is being received, do not press **FREQ/RDS** until one or more RDS mode indicators light up on the front panel display. If you press the button before the indicators light up on the front panel display, the mode cannot be changed. This is because this system has not yet received all of the RDS data on the station.
- RDS data not offered by the station cannot be selected.
- The RDS data service cannot be utilized by this system if the received signal is not strong enough. In particular, the RT mode requires a large amount of data to be received, so it is possible that the RT mode may not be displayed even if other RDS modes (PS, PTY, etc.) are displayed.
- RDS data cannot sometimes be received under poor reception conditions. If so, press **AUTO/MAN'L** so that the "AUTO" indicator goes off from the front panel display. Although the reception mode is changed to monaural by this operation, when you change the display to RDS mode, RDS data may be displayed.
- If the signal strength is weakened by external interference during the reception of an RDS station, the RDS data service may be cut off suddenly and "...WAIT" will appear on the front panel display.

PTY SEEK function

If you select the desired program type, this system automatically searches all preset RDS stations that are broadcasting a program of the required type.

1 Press **PTY SEEK MODE** to set this system in the **PTY SEEK mode**.

The program type of the station being received or "NEWS" flashes on the front panel display.

2 Press **PRESET ^/∨** (∨ **PRESET/TUNING ^** on the front panel) to select the desired program type.

The selected program type appears on the front panel display.

3 Press **PTY SEEK START** to begin searching all preset RDS stations.

The selected program type flashes and the "PTY HOLD" indicator lights up on the front panel display while searching for stations.

- If a station that is broadcasting a program of the required type is found, this system stops at that station.
- If the called station is not the desired one, press **PTY SEEK START** again. This system begins searching for another station that is broadcasting a program of the same type.

■ To cancel the steps 1 or 2

Press **PTY SEEK MODE** twice.

OPERATING OTHER COMPONENTS USING THE REMOTE CONTROL

Setting the manufacturer code (remote control signal assigned to each manufacturer) for your TV, VCR or DVD player on the remote control allows you to operate not only the AVX-S80 but also your TV, VCR or DVD player using the remote control.

Note

- Depending on the model, certain components from other manufacturers cannot be controlled, or only limited functions can be controlled, even though the proper manufacturer code has been set. If you encounter this problem, please use the remote control supplied with the component.

Setting the manufacturer code

Manufacturer codes can be set for TV, VCR and DVD/CD buttons only.

Note

- TV manufacturer codes can be set for the TV button only. However, any of the manufacturer codes can be set for the VCR and DVD/CD buttons.

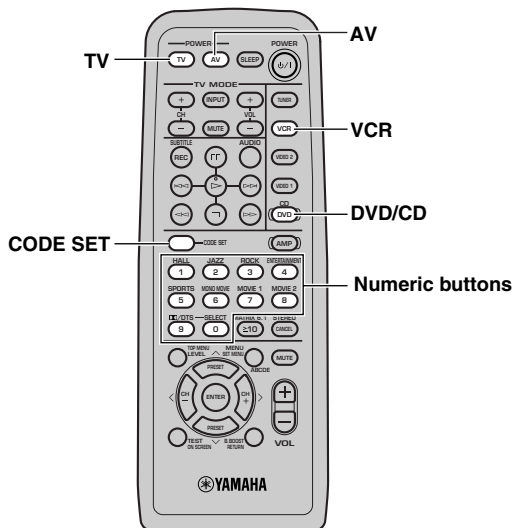

(U.S.A. model)

- 1** While pressing **CODE SET**, press the input selector button (**TV**, **VCR**, **DVD/CD**) for which the manufacturer code is to be set.

Only one manufacturer code can be set for each input selector button.

Note

- Keep pressing **CODE SET** between step 1 and 2.
- Refer to "LIST OF MANUFACTURER'S CODES" at the end of this manual.

- 2** Keeping **CODE SET** pressed, enter the 1-digit device code and the 2-digit manufacturer code for the component to be controlled using the numeric buttons.

You can release **CODE SET** after entering the code.



- The manufacturer code 99 has been set for the remote control selector buttons (**TV**, **VCR** and **DVD/CD**) at the factory.

- 3** Press **POWER (TV or AV)** and check that the component to be controlled turns on and off (standby).

Precautions when performing the setting

You can operate the component using the TV, VCR or DVD player operation buttons on the remote control once the manufacturer code is set properly. If unsuccessful, perform the procedure from step 1 again. Pay attention to the following points when you perform the procedure.

- Check that the correct remote control selector button has been selected when setting the manufacturer code.
- If more than one code is given for a manufacturer, try entering each code in the order given.
- Remove and replace the remote control's batteries (complete this step within 2 minutes) and then perform the procedure. While replacing the batteries, be sure not to press any button on the remote control. Doing so may erase the manufacturer code which has been set for other remote control selector buttons.

To reset the manufacturer code to the factory-set code

Follow steps 1 to 2 for the procedure "Setting the manufacturer code", and enter the device code for the component and "99" while pressing **CODE SET** in step 2. (It is not necessary to follow step 3.)

Other component controlling functions

By pressing an input selector button (TV, VCR, DVD/CD) for which the manufacturer code is set, the functions of the remote control buttons change for controlling the corresponding component as follows.

Controlling a TV

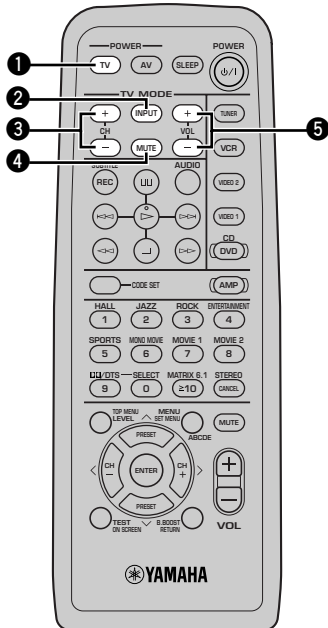

(U.S.A. model)

1 TV (POWER)

Turns the TV on, or set it to the standby mode.

2 INPUT (TV MODE)

Changes the TV's input.

3 CH +/- (TV MODE)

Changes the channel.

4 MUTE (TV MODE)

Mutes the sound.

5 VOL +/- (TV MODE)

Press to increase/decrease the volume level.

Controlling a VCR

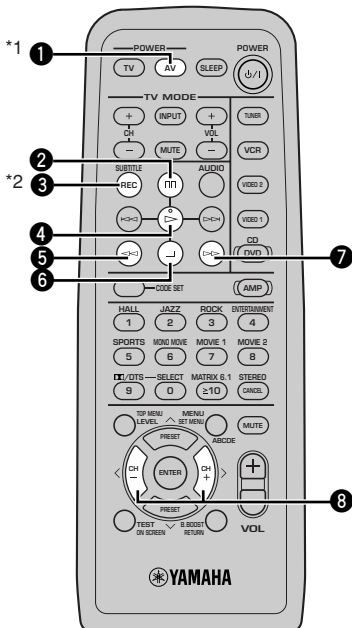

(U.S.A. model)

1 AV (POWER)

Turns the VCR on, or set it to the standby mode.

2 □

Temporarily stops playback.

3 REC

Starts recording.

4 ▷

Starts playback.

5 ◀◀

Makes playback fast backward.

6 □

Stops playback.

7 ▶▶

Makes playback fast forward.

8 CH +/-

Changes the channel.

*1 This button functions only when the original remote control of the component has POWER button.

*2 Only when pressing this button twice in quick succession within one second, the button functions.

Controlling a DVD player



- The buttons on the remote control whose names are written in green are operation buttons for a DVD player.

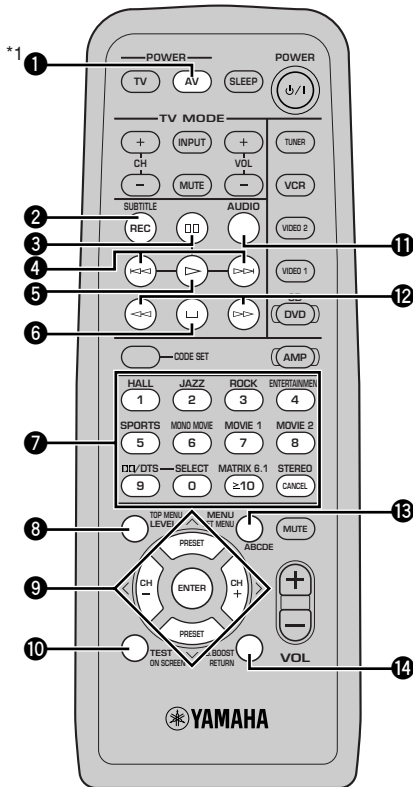

(U.S.A. model)

1 AV (POWER)

Press to turn on the DVD player or set it to the standby mode.

2 SUBTITLE

Press to select a subtitle language.

3

Press to pause.

4

Press to skip forward or backward.

5

Press to start playback.

6

Press to stop playback.

7 Numeric buttons/CANCEL

Press to enter numbers./Press to cancel a specific mode or a setting.

8 TOP MENU

Press to display a DVD's disc menu screen.

9

Use to select and determine an item on menu screen, etc.

10 ON SCREEN

Press to turn the on-screen icons on and off on the video monitor.

11 AUDIO

Press to switch the audio track language to others recorded on the disc.

12

Press to play back a disc fast forward or backward.

13 MENU

Press to call up menu screen contained in the disc.

14 RETURN

Press to go back to the previous screen when operating in the menu screen.

*1 This button functions only when the original remote control of the component has POWER button.



- If the manufacturer code of TV has been set for the TV button, the TV (POWER) and TV MODE buttons can also operate your TV even if any input selector button is pressed.

SET MENU

The SET MENU consists of 9 items including the speaker mode setting. Choose the appropriate item and adjust or select the values as necessary.



- You can adjust the items on the SET MENU while playing a source.

List of SET MENU items

Items	Initial settings
1 SPEAKER SET	
A CENTER	SML (small)
B FRONT	SMALL
C REAR LR	SML (small)
D BASS	SWFR
E F. Level	Nrm (Normal)
2 LFE LEVEL	
SP LFE	0 dB
HP LFE	0 dB
3 SP DLY TIME	0 ms
4 D. RANGE	
SP D.R	MAX
HP D.R	MAX
5 L/R BALANCE	0 dB for L/R
6 HP TONE CTRL	
HP BASS	0 dB
HP TRBL	0 dB
7 INPUT MODE	AUTO
8 DISPLAY SET	0
9 SP/PRE OUT	BOTH

In the descriptions for each item from the following page, the default setting is indicated in bold.

Adjusting the items on the SET MENU

Adjustment should be made with the remote control.

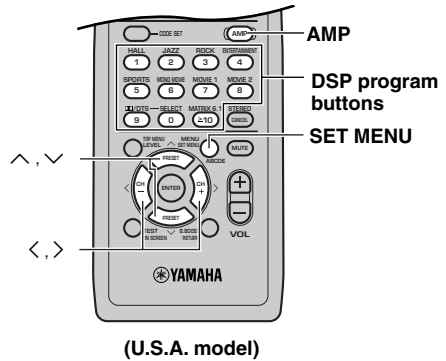

Note

- Some items require extra steps.

- 1 Press AMP.**
- 2 Press SET MENU to enter the SET MENU.**
- 3 Press ∇/\blacktriangle repeatedly to select the item you want to adjust (1 to 9).**



- Pressing \blacktriangle cancels the SET MENU mode when the item 1 is shown on the display. (The same result is gained by pressing ∇ when the item 9 is selected.)

- 4 Press \langle / \rangle once to enter the setup mode of the selected item.**
The last setting you adjusted appears on the front panel display.
Depending on the item, press ∇/\blacktriangle to select a sub item.
- 5 Press \langle / \rangle repeatedly to change the setting of the item.**
- 6 Press \blacktriangle/∇ repeatedly until the menu disappears or simply press one of the DSP program buttons to exit SET MENU.**

1 SPEAKER SET (speaker mode settings)

Use this feature to select suitable output modes for your speaker configuration.

If you do not use one or any of the included speakers, or if you use other speakers instead of the included speakers, set the following.

Note

- When 96-kHz sampling digital signals are input to this system, some items are not affected.

■ 1A CENTER (center speaker mode)

By adding a center speaker to your speaker configuration, this system can provide better dialog localization for several listeners and superior synchronization of sound and images.

Choices: LRG (large), **SML** (small), NON (none)

LRG

Select this if you have a large center speaker. The entire range of the center channel signal is directed to the center speaker.

SML

Select this if you have a small center speaker. The low-frequency signals (90 Hz and below) of the center channel are directed to the speakers selected with "1D BASS".

NON

Select this if you do not have a center speaker. All of the center channel signals are directed to the front left and right speakers.

■ 1B FRONT (front speaker mode)

Choices: LARGE, **SMALL**

LARGE

Select this if you have large front speakers. The entire range of the front left and right channel signal is directed to the front left and right speakers.

SMALL

Select this if you have small front speakers. The low-frequency signals (90 Hz and below) of the front channel are directed to the speakers selected with "1D BASS".

Note

- When you select FRONT for "1D BASS", the low-frequency signals (90 Hz and below) of the front channel are directed to the front speakers even if you select SMALL for the front speaker mode.

■ 1C REAR LR (rear speaker mode)

Choices: LRG (large), **SML** (small), NON (none)

LRG

Select this if you have large rear left and right speakers or if a rear subwoofer is connected to the rear speakers. The entire range of the rear channel signal is directed to the rear left and right speakers.

SML

Select this if you have small rear left and right speakers. The low-frequency signals (90 Hz and below) of the rear channel are directed to the speakers selected with "1D BASS".

NON

Select this if you do not have rear speakers.



- This system is set in the Virtual CINEMA DSP mode when you select NON for "1C REAR LR".

■ 1D BASS (LFE/bass out mode)

LFE signals carry low-frequency effects when this system decodes a Dolby Digital or DTS signal. Low-frequency signals are defined as 90 Hz and below. The Low-frequency signals can be directed to both front left and right speakers, and the subwoofer (subwoofer can be used for both stereo reproduction and the DSP program).

Choices: **SWFR** (subwoofer), **FRONT**, **BOTH**

SWFR

Select this if you use a subwoofer. The LFE signals are directed to the subwoofer.

FRONT

Select this if you do not use a subwoofer. The LFE signals are directed to the front speakers.

BOTH

The LFE signals are directed to the subwoofer. Low-frequency signals designated to the front channels in accordance with other speaker mode settings are directed to both front speakers and a subwoofer.

■ 1E F. Level (front level mode)

Change this setting if you cannot match the output level of the center and rear (L/R) speakers with that of the front speakers because of unusually high-efficiency performance from the front speakers.

Choices: **Nrm** (Normal), **-10 dB**

Nrm

Select this if you can match the output level of the center and rear speakers with that of the front speakers when using the test tone.

-10 dB

Select this if you cannot match the output level of the effect speakers with that of the front speakers when using the test tone.

2 LFE LEVEL

Use this feature to adjust the output level of the LFE (low-frequency effect) channel when playing back a Dolby Digital or DTS signal. Adjust the LFE level according to the capacity of your subwoofer or headphones.

Control range:

SPEAKER

(SP LFE) -20 to 0 dB

HEADPHONE

(HP LFE) -20 to 0 dB

Initial setting: 0 dB

1 Press ∇/\wedge to select the item to be adjusted.

2 Press \leftarrow to adjust the LFE level.

3 SP DLY TIME (speaker delay time)

Use this feature to adjust the delay of the center channel sounds. This feature works when there is sound output from the center speaker, with a source like Dolby Digital or DTS, etc. Ideally, the center speaker should be the same distance from the main listening position as the left and right speakers.

However, in most home situations, the center speaker is placed in line with the front speakers. By delaying the sound from the center speaker, the apparent distance from the center speaker to the main listening position can be adjusted to make it seem the same as the distance between the front left and right speaker to the listening position. Adjusting the delay time for the center speaker is especially important for giving depth to the dialogue.

Control range:

CENTER 0 to 5 ms

Initial setting:

CENTER 0 ms

Press < / > to increase or decrease the delay of the center channel sounds.

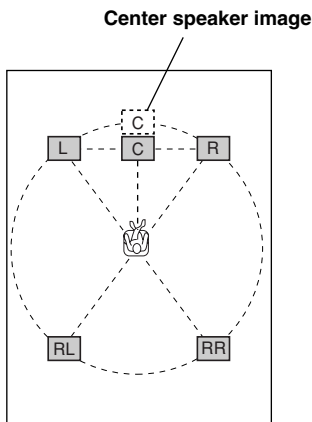

- Increasing the delay by 1 ms simulates moving the speakers about 30 cm (one foot) farther away from the listening position.

4 D. RANGE (dynamic range)

Use this feature to adjust the dynamic range. This setting is effective only when this system is decoding Dolby Digital signals.

The dynamic range can be adjusted for speaker listening and headphone listening independently.

Choices: **MAX**, STD (standard), MIN (minimum)

MAX

Select the "MAX" for feature films.

STD

Select the "STD" for general use.

MIN

Select the "MIN" for listening to sources at low volume levels.

1 Press ∇/\blacktriangle to select "SP D.R" (for speaker listening) or "HP D.R" (for headphone listening).

2 Press < / > to adjust the dynamic range.

Note

- Some types of the Dolby Digital software do not support "MIN" for the dynamic range. If "MIN" is selected to play this type of software, the volume may be extremely lowered fall greatly, sharply. If this happens, select "MAX" or "STD".

5 L/R BALANCE (balance of the front left and right speakers)

Use this feature to adjust the balance of the output level from the front left and right speakers.

Control range: 20 steps each for L/R

Initial setting: 0 dB for L/R

Press > to decrease the output level for the front left speaker. Press < for the front right speaker.

6 HP TONE CTRL (headphone tone control)

Use this feature to adjust the level of the bass and treble when you use your headphones.

Control range (dB):

BASS -6 to +3

TRBL (treble) -6 to +3

Initial setting:

BASS 0 dB

TRBL 0 dB

Press > to increase the level of the bass and treble, and press < to decrease the level.

7 INPUT MODE (*initial input mode*)

Use this feature to designate the input mode for sources connected to the digital (optical) input jacks when you turn on this system.

Choices: **AUTO**, **LAST**

AUTO

Select this to allow this system to automatically detect the type of input signal and select the appropriate input mode.

LAST

Select this to set this system to automatically select the last input mode used for the respective source.

8 DISPLAY SET (*brightness of front panel display*)

■ **DIMMER**

Use this feature to adjust the brightness of the front panel display.

Control range: -4 to 0

Initial setting: 0

Press > to increase or < to decrease the brightness.

9 SP/PRE OUT (*output source settings*)

Choices: **BOTH**, **SP**, **PRE**

BOTH

Select this to direct signals to both the speakers connected to the subwoofer (SW-S80) and the 6CH PREOUT jacks.

SP

Select this to direct signals to the speakers connected to the subwoofer (SW-S80). (No sound is output from 6CH PREOUT jacks.)

PRE

Select this to direct signals to 6CH PREOUT jacks or if you connect your external amplifier to 6CH PREOUT jacks on this system. (No sound is output from the speakers connected to the subwoofer (SW-S80).)

ADJUSTING THE LEVEL OF THE EFFECT SPEAKERS

You can adjust the output level of each effect speaker (center, rear left and right, and subwoofer) while listening to a source.

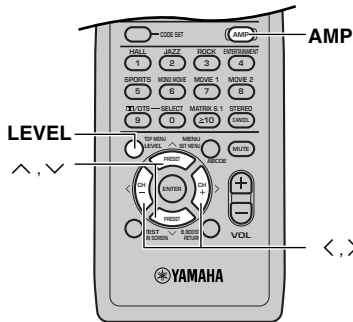

(U.S.A. model)

(While playing a source)

1 Press AMP.

2 Press LEVEL repeatedly to select the speaker(s) you want to adjust.

Each time you press LEVEL, the selected speaker changes and appears on the front panel display as follows: center, rear right, rear left and subwoofer.

CENTER (Center speaker) → R SUR. (Rear right speaker) → L SUR. (Rear left speaker) → SWFR (Subwoofer) → CENTER (Center speaker)...



• Once you press LEVEL, you can also select the speaker(s) to be adjusted by pressing \vee / \wedge .

3 Press \langle / \rangle to adjust the speaker output level.

- The control range for the center or rear left and right speakers is from +10 dB to -10 dB.
- The control range for the subwoofer is from +10 dB to -10 dB.

Notes

- When the speaker output modes for “1A CENTER” and “1C REAR LR” are set to NON, and “1D BASS” to FRONT, the output level of those speakers cannot be adjusted because there is no sound coming from these speakers.
- When you adjust the output level with LEVEL, the settings you made with the test tone will be changed.
- We recommend adjusting the speakers by following the steps described in “Using the test tone” on page 18.

■ For 5ch Stereo

You can adjust the volume level for each channel in 5-channel Stereo mode.

Control range: 0 to 100%

Initial Setting: 100%

- **CT level** (Center level)
- **RL level** (Rear left level)
- **RR level** (Rear right level)

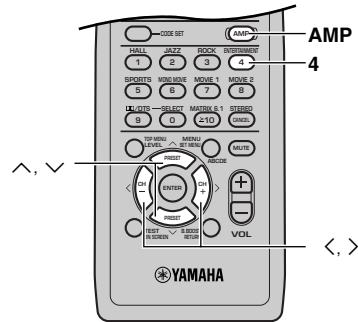

(U.S.A. model)

(While playing a source)

1 Press AMP.

2 Press “4” button to select 5ch Stereo.

3 Press \wedge / \vee repeatedly to select the speaker(s) you want to adjust.

4 Press \langle / \rangle to adjust the speaker output level.

Notes

- During the 5ch Stereo mode, the output level adjusted with the test tone or LEVEL is replaced with the level adjusted in the 5-channel stereo mode.
- When the speaker output modes for “1A CENTER” and “1C REAR LR” are set to NON, the output level of those speakers cannot be adjusted because there is no sound coming from these speakers.

CHANGING THE PARAMETER SETTINGS FOR DSP PROGRAMS

Adjusting the delay time

You can adjust the time difference between the beginning of the sound from the front speakers and the beginning of the sound effect from the rear speakers. The larger the value, the later the sound effect is generated. The delay time can be individually adjusted to all DSP programs.

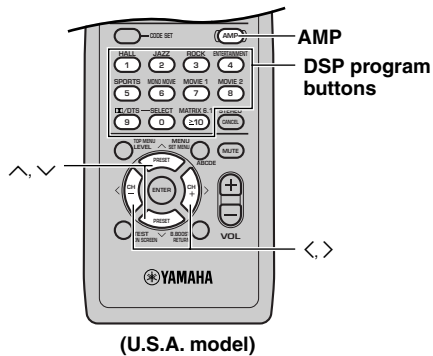

(While playing a source)

- 1** Press AMP.
- 2** Select a DSP program you want to adjust the delay time.
- 3** Press \wedge / \vee so that "DELAY" appears on the front panel display.
- 4** Press \langle / \rangle to adjust the delay time.

Notes

- Adding too much delay will cause an unnatural effect with some sources.
- The sound is momentarily interrupted while adjusting the delay time.

The following table shows factory-set delay time.

	Program	Preset value (ms)
1	CONCERT HALL	45
2	JAZZ CLUB	30
3	ROCK CONCERT	15
4	DISCO	26
	GAME	36
	CONCERT VIDEO	21
5	TV SPORTS	10
6	MONO MOVIE	69
7	70 mm SPECTACLE	23
	DGTL SPECTACLE	15
	DTS SPECTACLE	15
	Spectacle 6.1	15
	70 mm SCI-FI	20
	Sci-Fi 6.1	15
	DGTL SCI-FI	15
	DTS SCI-FI	15
8	70 mm ADVENTURE	20
	DGTL ADVENTURE	15
	DTS ADVENTURE	15
	Adventure 6.1	15
	70 mm GENERAL	20
	DGTL GENERAL	15
	DTS GENERAL	15
	General 6.1	15
9	PRO LOGIC/NORMAL	15
	DOLBY DIGITAL/NORMAL	5
	DTS DIGITAL SUR./NORMAL	5
	Matrix 6.1	5
	PRO LOGIC/ENHANCED	20
	DOLBY DIGITAL/ENHANCED	5
	DTS DIGITAL SUR./ENHANCED	5
	Enhanced 6.1	5
PRO LOGIC II Movie	15	
PRO LOGIC II Music	5	

Adjusting the parameter settings for PRO LOGIC II Music

■ Changing parameter settings

You can adjust the values of PRO LOGIC II Music parameters so the sound fields are recreated accurately in your listening room.

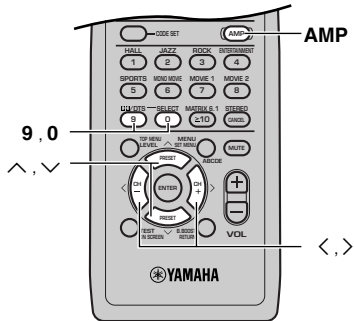

(U.S.A. model)

- 1** Press AMP.
- 2** Select PRO LOGIC II Music.
Refer to “Selecting PRO LOGIC II” on page 24 for details.
- 3** Press ^ / v to select the parameter.
- 4** Press < / > to change the parameter value.
- 5** Repeat steps 3 and 4 above as necessary to change other parameters.

■ PRO LOGIC II Music parameter descriptions

PANORAMA

Function: Turning the function on extends the front stereo image to include the surround speakers for wraparound effect.
Choices: OFF/ON, initial setting is OFF.

DIMENSION

Function: Gradually adjusts the soundfield either towards the front or towards the rear.
Control range: -3 (towards the rear) to +3 (towards the front), initial setting is STD (standard).

CT WIDTH (Center width)

Function: Adjusts the center image from the center and front speakers to varying degrees. The larger the value, adjusts the center image towards the front left and right speakers.
Control range: 0 (center channel sound is output only from center speaker) to 7 (center channel sound is output only from front left and right speakers), initial setting is 3.

TROUBLESHOOTING

Refer to the chart below when this system does not function properly. If the problem you are having is not listed below or if the instruction below does not help, set this system to the standby mode, disconnect the power cord, and contact the nearest authorized YAMAHA dealer or service center.

■ General

Problem	Cause	Remedy	Refer to page
This system fails to turn on when STANDBY/ON (or POWER (⏻/⏻) is pressed, or enters in the standby mode soon after the power has been turned on.	The power cord is not connected or the plug is not completely inserted.	Firmly connect the power cord.	—
	This system has been exposed to a strong external electric shock (such as lightning and strong static electricity).	Set this system in the standby mode, disconnect the power cord, plug it back in after 30 seconds, then start operating.	—
No sound.	Incorrect input or output cable connections.	Connect the cables properly. If the problem persists, the cables may be defective.	12 – 17
	An appropriate input source has not been selected.	Select an appropriate input source with the input selector buttons.	19
	The speaker connections are not secure.	Secure the connections.	15 – 16
	The volume is turned down.	Turn up the volume.	19
	The sound is muted.	Press MUTE or any operation buttons of this system to cancel a mute and adjust the volume.	19
	The source that this system cannot reproduce, such as a CD-ROM, is being played.	Play a source whose signals this system can reproduce.	—
The sound suddenly goes off.	The sleep timer has functioned.	Turn on the power, and play the source again.	20
Only the speaker on one side can be heard.	Incorrect cable connections.	Connect the cables properly. If the problem persists, the cables may be defective.	15 – 16
Sound can be heard only from the front speakers.	The sound effect is off.	Press STEREO to turn it on.	25
	A Dolby Surround, Dolby Digital or DTS decoding DSP program is being used with material not encoded with Dolby Surround, Dolby Digital or DTS.	Select another DSP program.	21 – 22
	A 96-kHz sampling digital signal is being input to this system.	When a 96-kHz sampling digital signal is being input to this system, sound is output from the front speakers only.	25

Problem	Cause	Remedy	Refer to page
No sound from the center speaker.	The output level of the center speaker is set to minimum.	Raise the level of the center speaker.	40
	“1A CENTER” on the SET MENU is set to NON.	Select the appropriate mode for your center speaker.	36
	One of the Hi-Fi DSP programs (1 to 4) has been selected (except for 5ch Stereo).	Select another DSP program.	21 – 22
	The source encoded with a Dolby Digital or DTS signal does not have a center channel signal.		—
No sound from the rear speakers.	The output level of the rear speakers is set to minimum.	Raise the output level of the rear speakers.	40
	A monaural source is being played with program 9.	Select another DSP program.	21 – 22
No sound from the subwoofer.	“1D BASS” on the SET MENU is set to FRONT when a Dolby Digital or DTS signal is being played.	Select SWFR or BOTH.	37
	“1D BASS” on the SET MENU is set to SWFR or FRONT when a 2-channel source is being played.	Select BOTH.	37
	The source does not contain low bass signals (90 Hz and below).		—
Poor bass reproduction.	The speaker mode settings (front, center, or rear) on the SET MENU do not match your speaker configuration.	Select the appropriate position for each speaker based on the size of the speakers in your configuration.	36 – 37
A “humming” sound can be heard.	Incorrect cable connections to the analog audio jacks.	Firmly connect the audio plugs to the analog audio jacks. If the problem persists, the cables may be defective.	12 – 13
The volume level cannot be increased, or the sound is distorted.	The component connected to the output (VCR OUT) jacks of this system is turned off.	Turn on the power to the component.	—
The sound effect cannot be recorded.	It is not possible to record the sound effect by a recording component.		—
This system does not operate properly.	The internal microcomputer has been frozen by an external electric shock (such as lightning or excessive static electricity) or by a power supply with low voltage.	Disconnect the AC power cord from the outlet and then plug it in again after about 30 seconds.	—
There is noise interference from digital or high-frequency equipment, or this system.	This system is too close to the digital or high-frequency equipment.	Move this system further away from such equipment.	—

■ Tuner

Problem		Cause	Remedy	Refer to page
FM/AM	Previously preset stations cannot be tuned in.	The preset stations are cleared.	Pre-set the stations once again.	28
FM	FM stereo reception is noisy.	The characteristics of FM stereo broadcasts may cause this problem when the transmitter is too far away or the antenna input is poor.	Check the antenna connections. Try using a high-quality directional FM antenna.	14
			Use the manual tuning method.	27
	There is distortion, and clear reception cannot be obtained even with a good FM antenna.	There is multipath interference.	Adjust the antenna position to eliminate multipath interference.	14
	The desired station cannot be tuned in with the automatic tuning method.	The station is too weak.	Use a high-quality directional FM antenna.	14
			Use the manual tuning method.	27
AM	The desired station cannot be tuned in with the automatic tuning method.	The signal is weak or the antenna connections are loose.	Tighten the AM loop antenna connections and orient it for best reception.	14
			Use the manual tuning method.	27
	There are continuous crackling and hissing noises.	Noises result from lightning, fluorescent lamps, motors, thermostats and other electrical equipment.	Use an outdoor antenna and a ground wire. This will help somewhat, but it is difficult to eliminate all noise.	14
	There are buzzing and whining noises (especially in the evening).	A TV set is being used nearby.	Move this system away from the TV.	—

■ Remote control

Problem	Cause	Remedy	Refer to page
The remote control does not work nor function properly.	Wrong distance or angle.	The remote control will function within a maximum range of 6 m (20 feet) and no more than 30 degrees off-axis from the front panel.	6
	Direct sunlight or lighting (from an inverter type of fluorescent lamp, etc.) is striking the remote control sensor of this system.	Reposition this system.	—
	The batteries are weak.	Replace all batteries with new ones.	3
	The manufacture code is not correctly set.	Set the code correctly.	32
		Try setting another code of the same manufacturer.	32
	Even if the manufacturer code is correctly set, there are some models that do not respond to the remote control.	Operate the component using its remote control.	—
	The functions of the remote control are not switched to the functions for controlling this system.	First press the AMP button on the remote control, then try to control this system by using the remote control.	—
The component you want to control with the remote control is not selected.	Select the component you want to control by pressing the corresponding input selector button.	—	

GLOSSARY

Bitstream

This is the digital form of multiple channel audio data (eg., 5.1 channel) before it is decoded into its various channels.

CINEMA DSP

Since the Dolby Surround and DTS systems were originally designed for use in movie theaters, their effect is best felt in a theater having many speakers and designed for acoustic effects. Since home conditions, such as room size, wall material, number of speakers, and so on, can differ so widely, it's inevitable that there are differences in the sound heard as well. Based on a wealth of actually measured data, YAMAHA CINEMA DSP uses YAMAHA original sound field technology to combine Dolby Pro Logic, Dolby Digital and DTS systems to provide the visual and audio experience of movie theater in the listening room of your own home.

Decoder

A decoder restores the coded signals on DVDs to normal. This is called decoding.

Dolby Digital

This is a method of coding digital signals developed by Dolby Laboratories. Apart from stereo (2-channel) audio, these signals can also be 5.1-channel audio. A large amount of audio information can be recorded on one disc using this method.

Dolby Pro Logic

A surround system where a 4-channel audio track is recorded as 2 channels and then is restored to 4 channels for play. The surround channel is monaural and can reproduce up to 7 kHz.

Dolby Pro Logic II

Dolby Pro Logic II is an improved technique used to decode vast numbers of existing Dolby Surround software. This new technology enables a discrete 5-channel playback with 2 front channels, 1 center channel, and 2 rear channels (instead of only 1 rear channel for conventional Pro Logic technology). A music mode is also available for 2-channel sources in addition to the movie mode.

DTS (Digital Theater Systems)

This surround system is used in many movie theaters around the world. There is good separation between the channels, so realistic sound effects are possible.

Dynamic range

Dynamic range is the difference between the lowest level of sound that can be heard above the noise of the equipment and the highest level of sound before distortion occurs.

LFE 0.1 channel

This channel is for the reproduction of low bass signals. The frequency range for this channel is 20 Hz to 120 Hz. This channel is counted as 0.1 because it only enforces a low frequency range compared to the full-range reproduced by the other 5 channels in a Dolby Digital or DTS 5.1 channel systems.

Linear PCM (pulse code modulation)

PCM is the usual digital method used for music CDs. DVDs have a greater volume so they use linear PCM, which has a higher sampling rate. Compressed PCM signals are called packed PCM (PPCM).

Matrix 6.1

The system incorporates Matrix 6.1 decoder for Dolby Digital and DTS multi-channel software that enables 6.1-channel reproduction by adding the rear center channel to existing 5.1-channel format. (The rear center channel is created from rear left and right channels, and outputted from virtual rear center speaker.) With this additional channel, you can experience more dynamic and realistic moving sound especially with scenes with "fly-over" and "fly-around" effects.

Sampling frequency and number of quantized bits

When digitizing an analog audio signal, the number of times the signal is sampled per second is called the sampling frequency, while the degree of fineness when converting the sound level into a numeric value is called the number of quantized bits.

SILENT CINEMA

YAMAHA has developed a natural, realistic sound effect DSP algorithm for headphones.

Parameters for headphones have been set for each sound field so that accurate representations of all the sound field programs can be enjoyed using headphones.

Virtual CINEMA DSP

YAMAHA has developed a virtual CINEMA DSP algorithm that allows you to enjoy DSP sound field surround effects even without center or rear speakers by using virtual rear speakers.

SPECIFICATIONS

AUDIO SECTION

- **Minimum RMS Output Power**
[U.S.A. and Canada models]
FRONT L/R, CENTER, REAR L/R
20 Hz to 20 kHz, 0.9% THD, 6 Ω **25 W**
- **Output Power**
FRONT L/R, CENTER, REAR L/R
1 kHz, 0.9% THD, 6 Ω 33 W
SUBWOOFER
100 Hz, 0.9% THD, 5 Ω 40 W
- **Maximum Power (EIAJ)**
FRONT L/R, CENTER, REAR L/R (1 kHz, 10% THD, 6 Ω)
..... 40 W
SUBWOOFER (100 Hz, 10% THD, 5 Ω)
..... 50 W
- **Total Harmonic Distortion**
FRONT L/R (20 W, 1 kHz) 0.05 %
- **Signal to Noise Ratio (IHF-A Network, shorted)** 95 dB
- **Input Sensitivity**
DVD/CD, VCR, VIDEO 1, VIDEO 2 200 mV/47 kΩ
- **Output Level (when 200 mV is input.)**
6CH PRE OUT (FRONT L/R, CENTER, REAR L/R) ... max. 1 V
6CH PRE OUT (SUBWOOFER) max. 4 V
VCR OUT 200 mV/1.2 kΩ
Headphones 165 mV/100 Ω

VIDEO SECTION

- **Video Signal Level** 1 V_{p-p}/75 Ω
- **Signal to Noise Ratio** 50 dB

TUNER SECTION

- **FM Tuning Range**
[U.S.A. and Canada models] 87.5 to 107.9 MHz
[Other models] 87.5/87.50 to 108.0/108.00 MHz
- **AM Tuning Range**
[U.S.A. and Canada models] 530 to 1710 kHz
[U.K., Europe and Australia models] 531 to 1611 kHz
[China, Korean and General models] .. 530/531 to 1710/1611 kHz

SPEAKER SECTION

- **Front and Rear Speakers**
Model Name NX-S80S
Type Acoustic suspension
Speakers 5 cm (2 inch) full range cone x 2,
magnetic shielding
Impedance 6 Ω
- **Center Speaker**
Model Name NX-S80C
Type Acoustic suspension
Speakers 5 cm (2 inch) full range cone x 2,
magnetic shielding
Impedance 6 Ω
- **Subwoofer**
Model Name SW-S80
Type Advanced YAMAHA Active Servo Technology system
Speaker 16 cm (6-1/2 inch) woofer, magnetically shielded
Impedance 5 Ω

GENERAL

- **Power Supply**
[U.S.A. and Canada models] AC 120 V/60 Hz
[Australia model] AC 240 V/50 Hz
[U.K. and Europe models] AC 230 V/50 Hz
[China, Korean and General models]
..... AC 110–120/220–240 V, 50/60Hz
- **Power Consumption**
AVR-S80 20 W
SW-S80 160 W
- **Standby Power Consumption**
AVR-S80
[China, Korean and General models] 0.5 W
[Other models] 0.4 W
- **Dimensions (W x H x D)**
AVR-S80 435 x 67 x 265 mm
(17-1/8" x 2-5/8" x 10-7/16")
SW-S80 200 x 395 x 416 mm
(7-7/8" x 15-9/16" x 16-3/8")
NX-S80C 300 x 72 x 110 mm
(11-13/16" x 2-13/16" x 4-5/16")
NX-S80S 72 x 164 x 111 mm
(2-13/16" x 6-7/16" x 4-3/8")
- **Weight**
AVR-S80 4.0kg
(8 lbs 13 oz)
SW-S80 11.2kg
(24 lbs 10 oz)
NX-S80C 1.1kg
(2 lbs 7 oz)
NX-S80S 0.9kg
(2 lbs)
- **Usable temperature range** 5°C to 35°C
- **Usable humidity range**
..... 5% to 90% (There should be no condensation.)

LIST OF MANUFACTURER'S CODES

TV

(Device Code: 2)

Yamaha	99	92
Admiral	92	93
Aiwa	94	76 83
Akai	95	96
Alba	96	
AOC	97	
Bell&Howell	92	
Bestar	98	
Blaupunkt	29	22
Blue sky	98	
Brandt	23	
Brocsonic	97	
Bush	96	
Clatronic	98	
Craig	24	
Croslex	25	
Curtis Mathis	97	26
Daewoo	97	98 24 27 28
Daytron	39	
Dual	98	
Emerson	97	24 39 32
Ferguson	23	65 66
First line	98	
Funai	77	78
Fisher	95	33
Fraba	98	
GE	93	97 34 35 36
Goodmans	96	98 23
Grundig	29	38 49
Hitachi	97	39 42 43
ICE	96	
Irradio	96	
Itt/Nokia	44	45
JC Penny	93	97 34 37
JVC	96	46 47
Kendo	98	
KTV	97	39
LG (Goldstar)	97	98 39 37
Loewe	98	48
LXI	93	97 25 26 33
Magnavox	97	25 39
Matsui	95	
Mitsubishi	99	97 59
NEC	97	52 82
Nokia	44	45
Nokia Oceanic	45	
Nordmende	65	66
Onwa	96	
Panasonic	34	35 36 53
Philco	97	25 39
Philips	25	
Pioneer	26	35 54 55 68
Portland	97	56
Quasar	34	35
Radio Shack	99	93 97
RCA	93	97 34 56 57 58
SABA	23	69 65 66
Samsung	97	39 48 62 75
Sanyo	95	33 79 72 73 74
Schneider	96	
Scott	97	
Sharp	92	39 32
Siemens	29	

Signature	92
Sony	63
Sylvania	97 25
Telefunken	69 64 65 66
Thomson	23 66
Toshiba	92 26 67
Videch	97 42
Wards	97 39 32

VCR

(Device Code: 3)

Yamaha	99	92	93	94
Admiral	95			
Aiwa	96	97	98	29
Akai	22	23	24	
Audio Dynamic	92	94		
Bell&Howell	93			
Blaupunkt	25	26		
Brocsonic	27			
Bush	22			
Canon	25	28		
CGM	96	32		
Citizen	96			
Craig	96			
Curtis Mathis	97	28	33	
Daewoo	28	34	35	
DBX	92	94		
Dimensia	33			
Emerson	27	34		
Fisher	93	36		
Funai	97			
GE	28	33		
Goodmans	34	37		
Grundig	32	38		
Hitachi	25	33	49	42 43
Instant Replay	25	28		
Itt/Nokia	93			
JC Penny	92	93	94	28 33 49
JVC	92	94	44	45 46 47
Kendo	96			
Kenwood	92	94	96	
LG (Goldstar)	96	88		
Loewe	96	37		
Luxor	95			
LXI	93	96	97	36 49
Magnavox	25	26	28	
Marantz	92	94		
Marta	96			
Matsui	96			
Memorex	28	36		
Minolta	33	49		
Mitsubishi	99	44	48	59 52 53
Multitech	97	48	54	
NEC	92	94	44	83
Nokia	93	95		
Nokia Oceanic	95			
Okano	23			
Olympic	25	28		
Orion	27			
Panasonic	25	28	39	55 78 84 85
Pentax	33	49		
Philco	25	28		
Philips	25	26	28	37 56 57
Phonola	37			

Pioneer	25
Quasar	25 28
RCA/PROSCAN	25 26 28 33 35 49 58 69
Realistic	93 97 28 36 59 62
Samsung	54 58 63 64 65 66
Sansui	94
Sanyo	93 36 67
Schneider	37
Scott	99 35 36 48 59 52 54 58
Seleco	22
Sharp	95 62 82
Siemens	93
Signature 2000	95 97
Sony	68 79 72 73 74 75
Sylvania	97 25 26 28
Symphonic	97
Tandberg	34
Tashiro	96
Tatung	92 94
Teac	92 94 97
Technics	25 28
Telefunken	76 77
Thorn	93 96
Toshiba	35 69 89
Universum	96 27 76
W.WHouse	96
Wards	95 96 36 62

DVD

(Device Code: 4)

Yamaha	99 22 23
DENON	99 24
Funai	25
HITACHI	26
JVC	27
KENWOOD	28
Mitsubishi	29
Onkyo	32 33 34
Panasonic	99 35
Philips	23
Pioneer	36 37 38
RCA	39
Samsung	42
Sharp	43
Sony	44
Toshiba	34



YAMAHA ELECTRONICS CORPORATION, USA 6660 ORANGETHORPE AVE., BUENA PARK, CALIF. 90620, U.S.A.
YAMAHA CANADA MUSIC LTD. 135 MILNER AVE., SCARBOROUGH, ONTARIO M1S 3R1, CANADA
YAMAHA ELECTRONIK EUROPA G.m.b.H. SIEMENSSTR. 22-34, 25462 RELINGEN BEI HAMBURG, F.R. OF GERMANY
YAMAHA ELECTRONIQUE FRANCE S.A. RUE AMBROISE CROIZAT BP70 CROISSY-BEAUBOURG 77312 MARNE-LA-VALLEE CEDEX02, FRANCE
YAMAHA ELECTRONICS (UK) LTD. YAMAHA HOUSE, 200 RICKMANSWORTH ROAD WATFORD, HERTS WD1 7JS, ENGLAND
YAMAHA SCANDINAVIA A.B. J A WETTERGRENS GATA 1, BOX 30053, 400 43 VÄSTRA FRÖLUNDA, SWEDEN
YAMAHA MUSIC AUSTRALIA PTY, LTD. 17-33 MARKET ST., SOUTH MELBOURNE, 3205 VIC., AUSTRALIA

YAMAHA CORPORATION
Printed in Malaysia ☼ V940570



AVX-S80 CONNECTION GUIDE

Connecting to a TV (monitor), DVD player, video camera and video game player

*1 : Insert the plug with its ↑ mark facing up.

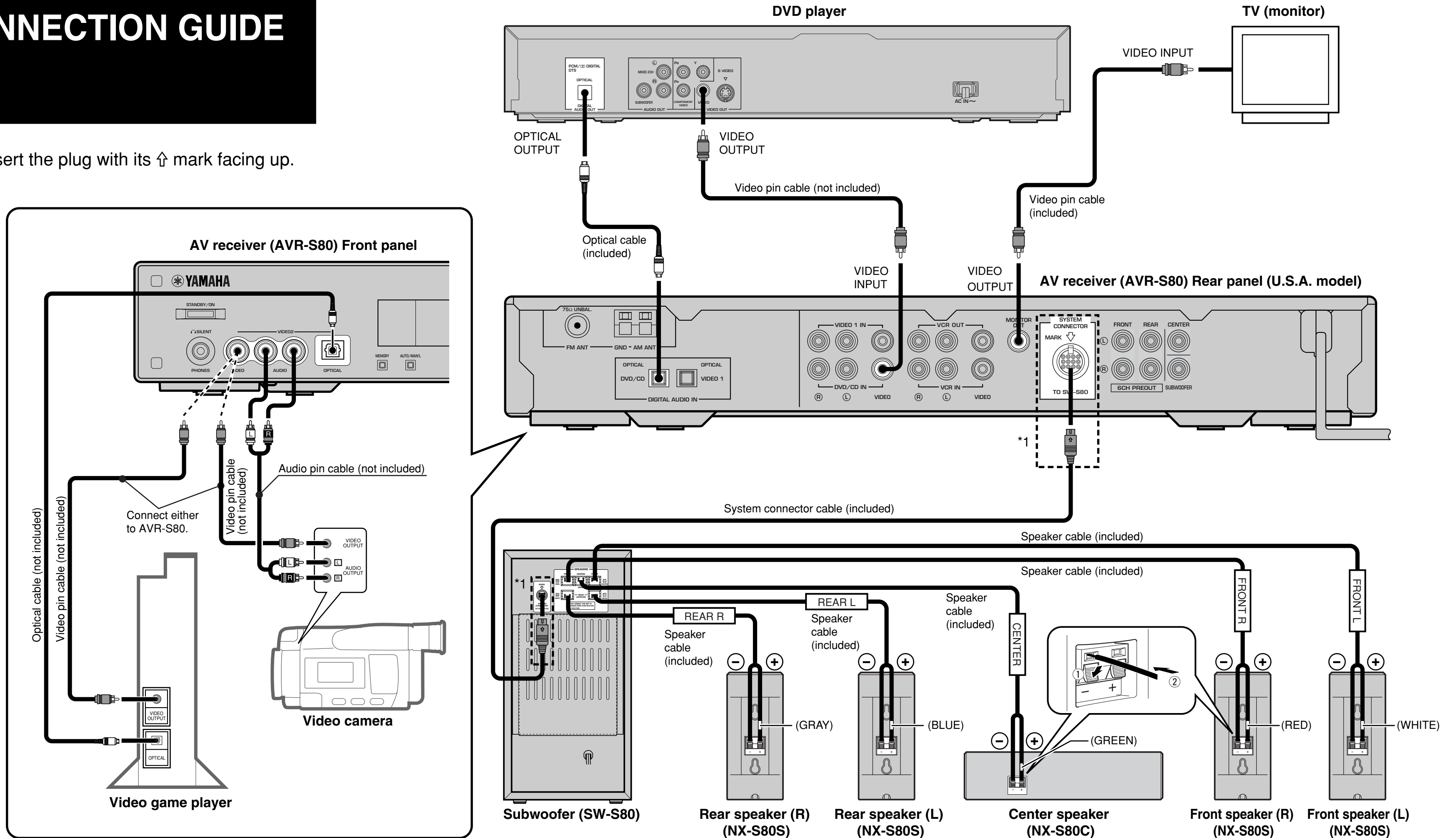

DVD/VIDEO CD/CD PLAYER

DVD-S80



Before connecting, operating or adjusting this product, please read these instructions completely. Please keep this manual for future reference.



OWNER'S MANUAL

Dear customer

Thank you for purchasing this product. For optimum performance and safety, please read these instructions carefully.

Getting started

CAUTION!

**THIS PRODUCT UTILIZES A LASER.
USE OF CONTROLS OR ADJUSTMENTS OR PERFORMANCE OF PROCEDURES OTHER THAN THOSE SPECIFIED HEREIN MAY RESULT IN HAZARDOUS RADIATION EXPOSURE. DO NOT OPEN COVERS AND DO NOT REPAIR YOURSELF. REFER SERVICING TO QUALIFIED PERSONNEL.**

WARNING:

TO REDUCE THE RISK OF FIRE, ELECTRIC SHOCK OR PRODUCT DAMAGE, DO NOT EXPOSE THIS APPARATUS TO RAIN, MOISTURE, DRIPPING OR SPLASHING AND THAT NO OBJECTS FILLED WITH LIQUIDS, SUCH AS VASES, SHALL BE PLACED ON THE APPARATUS.

CAUTION:

**TO PREVENT ELECTRIC SHOCK MATCH WIDE BLADE OF PLUG TO WIDE SLOT, FULLY INSERT.
This Class B digital apparatus complies with Canadian ICES-003.**



**CAUTION: TO REDUCE THE RISK OF ELECTRIC SHOCK, DO NOT REMOVE SCREWS. NO USER-SERVICEABLE PARTS INSIDE.
REFER SERVICING TO QUALIFIED SERVICE PERSONNEL.**



The lightning flash with arrowhead symbol, within an equilateral triangle, is intended to alert the user to the presence of un-insulated "dangerous voltage" within the product's enclosure that may be of sufficient magnitude to constitute a risk of electric shock to persons.



The exclamation point within an equilateral triangle is intended to alert the user to the presence of important operating and maintenance (servicing) instructions in the literature accompanying the appliance.

DANGER	- VISIBLE AND INVISIBLE LASER RADIATION WHEN OPEN, AVOID DIRECT EXPOSURE TO BEAM. (FDA 21 CFR)
CAUTION	- VISIBLE AND INVISIBLE LASER RADIATION WHEN OPEN, AVOID EXPOSURE TO BEAM. (IEC60825-1)
ATTENTION	- RAYONNEMENT LASER VISIBLE ET INVISIBLE EN CAS D'OUVERTURE. EXPOSITION DANGEREUSE AU FAISCEAU.
ADVARSEL	- SYNLIG OG USYNLIG LASERSTRÅLING VED ÅBNING. UNGÅ UDSÆTTELSE FOR STRÅLING.
VARO!	- AVATTAESSA OLET ALTTIINA NÄKYVÄÄ JA NÄKYMÄTÖN LASERSÄTEILYLLE. ÄLÄ KATSO SÄTEESEEN.
VARNING	- SYNLIG OCH OSYNLIG LASERSTRÅLNING NÄR DENNA DEL ÄR ÖPPNAD. BETRÄKTA EJ STRÅLEN.
ADVARSEL	- SYNLIG OG USYNLIG LASERSTRÅLING NÄR DEKSEL ÅPNES. UNGÅ EKSPONERING FOR STRÅLEN.
VORSICHT	- SICHTBARE UND UNSICHTBARE LASERSTRÄHLUNG, WENN ABDECKUNG GEÖFFNET. NICHT DEM STRAHL AUSSETZEN.
注意	- 打开时有可见及不可见激光辐射。避免激光束照射。
注意	- ここを開くと可視及び不可視のレーザー光が出ます。ビームを直接見たり、感れたりしないでください。 RQLS0233

(Inside of product)

FCC INFORMATION (for U.S. customers only)

- IMPORTANT NOTICE: DO NOT MODIFY THIS UNIT!** This product, when installed as indicated in the instructions contained in this manual, meets FCC requirements. Modifications not expressly approved by Yamaha may void your authority, granted by the FCC, to use the product.
- IMPORTANT:** When connecting this product to accessories and/or another product use only high quality shielded cables. Cable/s supplied with this product **MUST** be used. Follow all installation instructions. Failure to follow instructions could void your FCC authorization to use this product in the USA.
- NOTE:** This product has been tested and found to comply with the requirements listed in FCC Regulations, Part 15 for Class "B" digital devices. Compliance with these requirements provides a reasonable level of assurance that your use of this product in a residential environment will not result in harmful interference with other electronic devices.

This equipment generates /uses radio frequencies and, if not installed and used according to the instructions found in the users manual, may cause interference harmful to the operation of other electronic devices. Compliance with FCC regulations does not guarantee that interference will not occur in all installations. If this product is found to be the source of interference, which can be determined by turning the unit "OFF" and "ON", please try to eliminate the problem by using one of the following measures:

Relocate either this product or the device that is being affected by the interference.

Utilize power outlets that are on different branch (circuit breaker or fuse) circuits or install AC line filter/s.

In the case of radio or TV interference, relocate/reorient the antenna. If the antenna lead-in is 300 ohm ribbon lead, change the lead-in to coaxial type cable.

If these corrective measures do not produce satisfactory results, please contact the local retailer authorized to distribute this type of product. If you can not locate the appropriate retailer, please contact Yamaha Electronics Corp., U.S.A. 6660 Orangethorpe Ave, Buena Park, CA 90620.

The above statements apply ONLY to those products distributed by Yamaha Corporation of America or its subsidiaries.

We Want You Listening For A Lifetime

YAMAHA and the Electronic Industries Association's Consumer Electronics Group want you to get the most out of your equipment by playing it at a safe level. One that lets the sound come through loud and clear without annoying blaring or distortion—and, most importantly, without affecting your sensitive hearing. Since hearing damage from loud sounds is often undetectable until it is too late, YAMAHA and the Electronic Industries Association's Consumer Electronics Group recommend you to avoid prolonged exposure from excessive volume levels.



User memo:

DATE OF PURCHASE _____
 DEALER NAME _____
 DEALER ADDRESS _____
 TELEPHONE NUMBER _____

The model number and serial number of this product can be found on either the back or the bottom of the unit.

Please note them in the space provided below and keep for future reference.

MODEL NUMBER _____ DVD-S80
 SERIAL NUMBER _____

Getting started

PRECAUTIONS	3
Accessories	4
Connection	4
Audio connection	4
Video connection	5
Connecting the power cable	5
The remote control	6
QUICK SETUP	6
Control reference guide	7
Disc information	7

Basic operations

Basic play	8
Starting play from a selected title or track	8
Skipping chapters or tracks	9
Fast forward and rewind—SEARCH	9
Slow-motion play	9
Frame-by-frame viewing	9
Resume function	9

Advanced operations

Convenient features	10
Repeat play	10
Program play	10
Random play	11
Using menus to play MP3 discs	11
Increasing your enjoyment of movies	12
Soundtracks	12
Subtitles	12
Angles	12
Using On-Screen Menu Icons	13
Common procedures	13
Disc information	14
Unit information	14
Changing settings	16
Common procedures	17
Entering a password (Ratings)	17
Digital output	17

Reference

Troubleshooting guide	18
Maintenance	19
Glossary	19
Specifications	Back cover

PRECAUTIONS

Before using this unit please read these operating instructions carefully. Take special care to follow the warnings indicated on the unit itself as well as the safety suggestions listed below. Afterwards keep them handy for future reference.

Safety

- Power Source**—The unit should be connected to a power supply only of the type described in the operating instructions or as marked on the unit. If you are not sure of the type of power supply to your home, consult your appliance dealer or local power company.
- Polarization**—If the unit is equipped with a polarized AC power plug (a plug having one blade wider than the other), that plug will fit into the AC outlet only one way. This is a safety feature. If you are unable to insert the plug fully into the outlet, try reversing the plug. If the plug should still fail to fit, contact your electrician to replace your obsolete outlet. Do not defeat the safety purpose of the polarized plug.
- Power Cord Protection**—AC power supply cords should be routed so that they are not likely to be walked on or pinched by items placed upon or against them. Never take hold of the plug or cord if your hand is wet, and always grasp the plug body when connecting or disconnecting it.
- Overloading**—Do not overload wall outlets and extension cords as this can result in a risk of fire or electric shock.
- Nonuse Periods**—When the unit is not being used, turn the power off. When left unused for a long time, the unit should be unplugged from the household AC outlet.
- Attachments**—Do not use attachments not recommended by the unit manufacturer as they may cause hazards.

Installation

Environment

- Water and Moisture**—Do not use this unit near water—for example, near a bathtub, washbowl, swimming pool, or the like. Damp basements should also be avoided.
- Condensation**—Moisture may form on the lens in the following conditions...
 - immediately after a heater has been turned on.
 - in a steamy or very humid room.
 - when the unit is suddenly moved from a cold environment to a warm one. If moisture forms inside this unit, it may not operate properly. To correct this problem, turn on the power and wait about one hour for the moisture to evaporate.
- Heat**—The unit should be situated away from heat sources such as radiators and the like. It also should not be placed in temperatures less than 5 °C (41 °F) or greater than 35 °C (95 °F).

Placement

- Ventilation**—The unit should be situated so that its location or position does not interfere with its proper ventilation. Allow 10 cm (4") clearance from the rear of the unit.
- Foreign Material**—Care should be taken so that objects do not fall into and liquids are not spilled into the unit. Do not subject this unit to excessive smoke, dust, mechanical vibration, or shock.
- Carts and Stands**—The unit should be used only with a cart or stand that is recommended by the manufacturer. The unit and cart combination should be moved with care. Quick stops, excessive force, and uneven surfaces may cause the unit and cart combination to overturn. 
- Mounting**—Any mounting of the appliance should follow the manufacturer's instructions, and should use a mounting accessory recommended by the manufacturer.

Maintenance

Disconnect this unit from the AC outlet before cleaning. Clean the cabinet, panel and controls with a soft cloth lightly moistened with a mild detergent solution. Do not use any type of abrasive pad, scouring powder or solvent such as alcohol or benzene.

Do not place the unit on amplifiers or equipment that may become hot.

The heat can damage the unit.

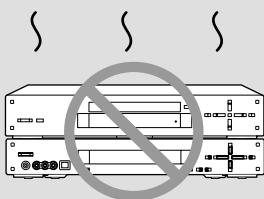

Accessories



Please check and identify the supplied accessories.

Remote control

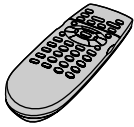

Batteries (x2)
for remote control

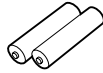

Power cable

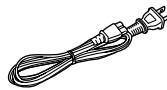

Audio/Video cable

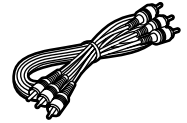

Note

The included power cable is for use with this unit only.
Do not use it with other equipment.

Connection

Notes

- Never plug the power cable to a household AC outlet until all connections are complete.
- Please refer to the manuals of other equipment as necessary to make the best connections.

Audio connection

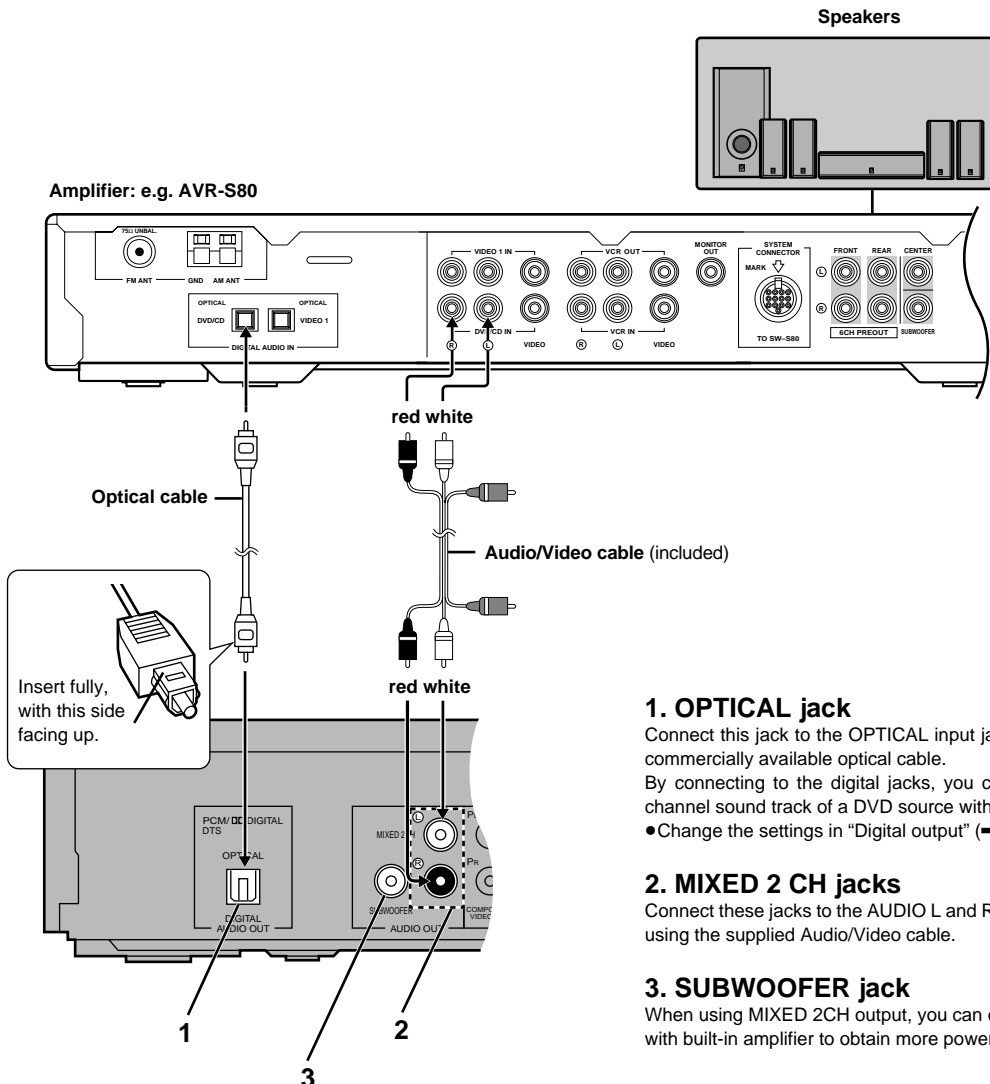

Video connection

This unit equips three types of video jacks as follows:

1. VIDEO jack

This jack transmits conventional composite video signal. Connect this jack to your AV amplifier so that you can switch the both audio and video inputs at once.

2. S VIDEO jack

This jack transmits color and luminance separately and achieves high quality color reproduction. Connect this jack to your television using a commercially available S-Video cable. If your AV amplifier equipped with S VIDEO input and output jacks, connect to the AV amplifier so that you can switch the both audio and video inputs at once.

3. COMPONENT VIDEO OUT jacks

These jacks transmit color difference and luminance separately and provide the best quality picture. Connect these jacks to the corresponding jacks of your television. If your AV amplifier equipped with COMPONENT VIDEO input and output jacks, connect to the AV amplifier so that you can switch the both audio and video inputs at once.

•After making this connection, change the black level for a better picture (➔ page 16, Video—Black Level Control).

Note

Do not connect this unit to a television through a video cassette recorder. If you do so, the picture may not be played back properly due to the copyright protection technology incorporated in this unit.

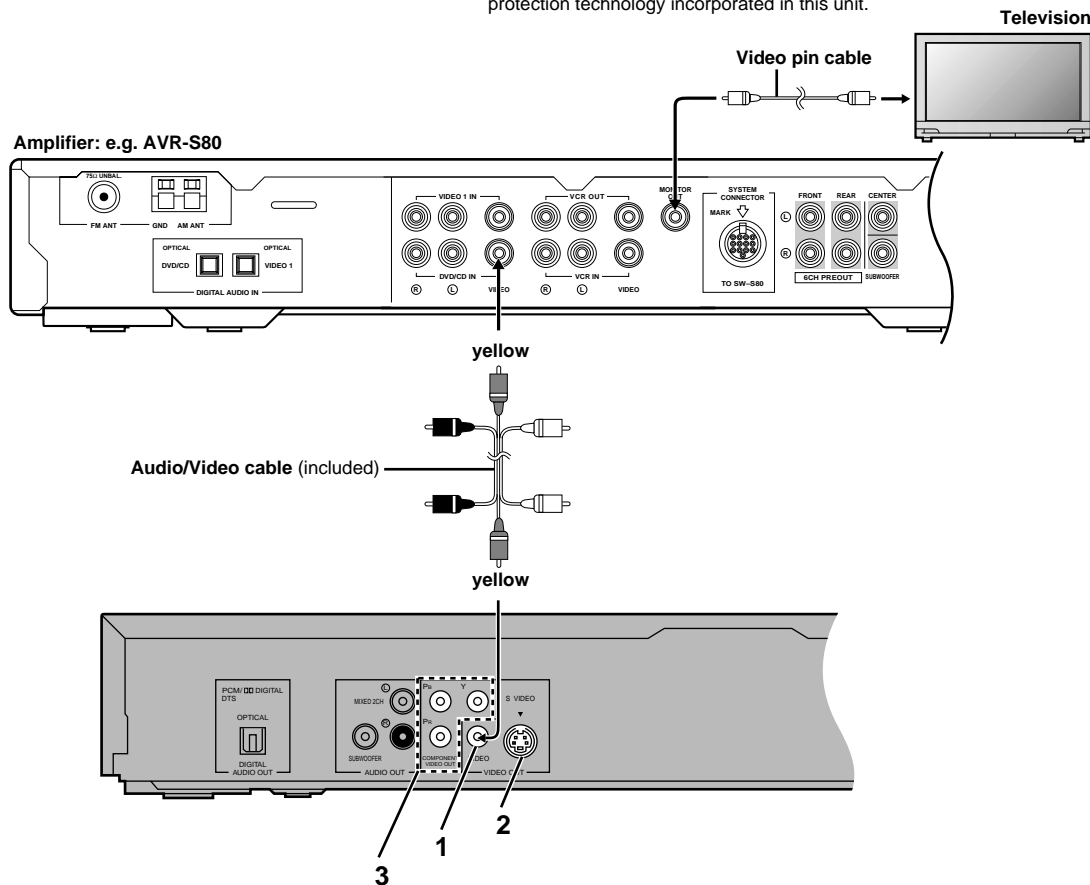

Connecting the power cable

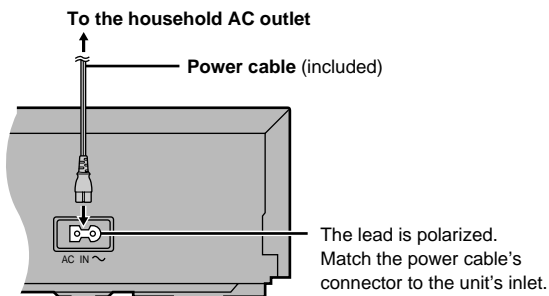

Plug the power cable into the AC IN when all connections are complete, and then plug this unit to the household AC outlet.

Caution

Do not use other AC power cables than the one provided. Otherwise it may result in causing fire or an electrical shock.

To enjoy 5.1-ch surround sound

•Change the settings in "Digital output" to suit the equipment you connect (➔ page 17).

Note

You cannot use DTS Digital Surround decoders not suited to DVD.

The remote control

■ Batteries

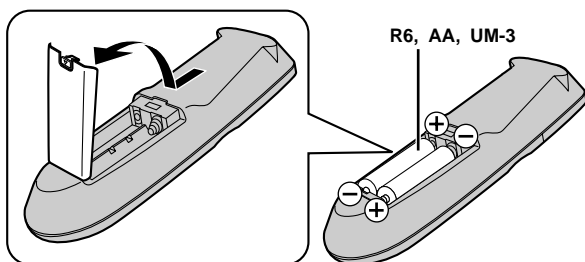

- Insert so the poles (+ and -) match those in the remote control.
- Do not use rechargeable type batteries.

Do not:

- mix old and new batteries.
 - use different types at the same time.
 - heat or expose to flame.
 - take apart or short circuit.
 - attempt to recharge alkaline or manganese batteries.
 - use batteries if the covering has been peeled off.
- Mishandling of batteries can cause electrolyte leakage which can damage items the fluid contacts and may cause a fire.

Remove if the remote control is not going to be used for a long period of time. Store in a cool, dark place.

■ Use

Aim at the sensor, avoiding obstacles, at a maximum range of 7 m (23 feet) directly in front of the unit.

QUICK SETUP

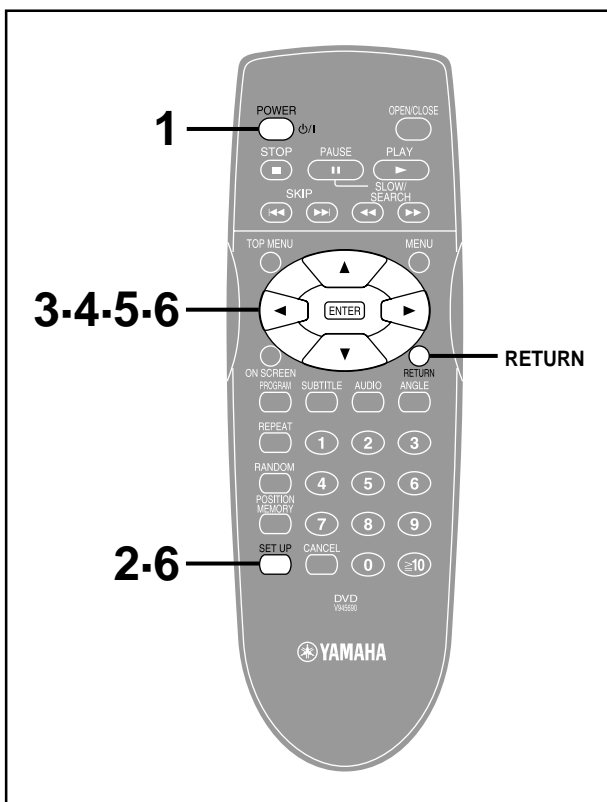

- 1 Press [POWER] to turn on the unit.
- 2 Press [SET UP] to show the QUICK SETUP screen.

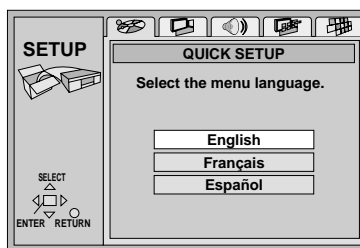

- 3 Press [▲, ▼, ◀, ▶] to select the menu language and press [ENTER].
- 4 Press [▲, ▼] to select "Yes" to continue and press [ENTER].
- 5 Press [▲, ▼, ◀, ▶] to select the item and press [ENTER].
 - Audio Language (For setting details → page 16)
 - Subtitle Language (For setting details → page 16)
 - TV Aspect (For setting details → "TV Aspect" below)
- 6 Press [ENTER] and then [SET UP] to end the settings.

To return to the previous screen
Press [RETURN].

■ TV Aspect

Select "4:3" (regular) or "16:9" (widescreen) to suit your television.

If you have a regular 4:3 television, you can also select how video on some discs is shown (→ page 16, Video—TV Aspect).

• 4:3 Pan&Scan (Factory preset)

The pan and scan (the original widescreen images are converted for viewing on a regular television) version of the video is automatically selected if recorded on the disc.



• 4:3 Letterbox

The letterbox (the original widescreen images appear with black bands above and below) version of the video is automatically selected if recorded on the disc.



Remote control only

The **QUICK SETUP** screen appears when you press [SET UP] the first time after purchase and assists you to make necessary settings. You can access this screen again later if you need to (→ page 16, Others—QUICK SETUP).

Preparation

Turn on the television and select the appropriate video input on the television to suit the connections for the player.

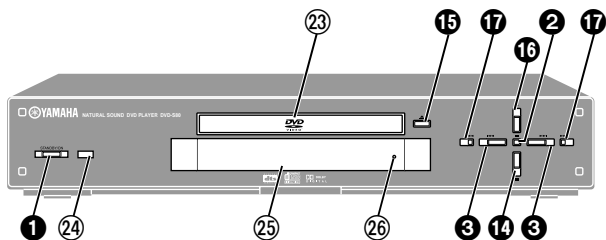
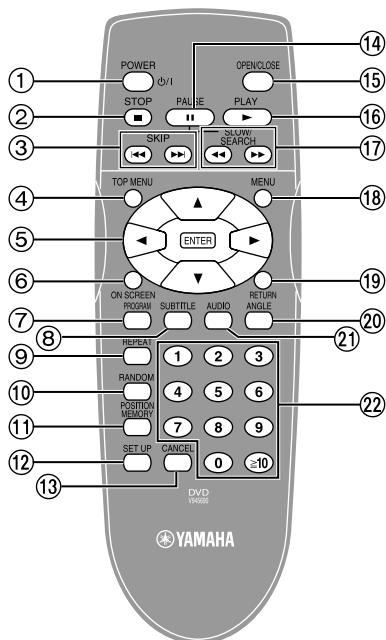

Buttons such as ❶ function the same as the controls on the remote control.

- ❶ Standby/on switch (POWER \odot /I) 6
Press to switch the unit from on to standby mode or vice versa.
In standby mode, the unit is still consuming a small amount of power.
- ❷ Stop button (■ STOP) 8
- ❸ Skip buttons (◀◀, ▶▶) SKIP 9
- ❹ Top menu button (TOP MENU) 8, 11
- ❺ Cursor buttons (▲, ▼, ◀, ▶)/Enter button (ENTER) 6, 8
- ❻ Display button (ON SCREEN) 13
- ❼ Program button (PROGRAM) 10
- ❽ Subtitle button (SUBTITLE) 8, 12
- ❾ Repeat button (REPEAT) 10
- ❿ Random play button (RANDOM) 11
- ⓫ Position memory button (POSITION MEMORY) 9
- ⓬ Setup button (SET UP) 6, 17
- ⓭ Cancel button (CANCEL) 10
- ⓮ Pause button (|| PAUSE) 8
- ⓯ Open/Close button (OPEN/CLOSE) 8
- ⓰ Play button (▶ PLAY) 8
- ⓱ Slow/Search buttons (◀◀, ▶▶) SLOW/SEARCH 9
- ⓲ Menu button (MENU) 8, 11
- ⓳ Return button (RETURN) 6
- ⓴ Angle button (ANGLE) 12
- ⓵ Audio button (AUDIO) 12
- ⓶ Numbered buttons (1–9, 0, \cong 10) 8
- ⓷ Disc tray 8
- ⓸ Remote control signal sensor
- ⓹ Display
- ⓺ Standby indicator
When the unit is connected to the household AC outlet, this indicator lights up in standby mode and goes out when the unit is turned on.

Operations in these instructions are described mainly with the remote control, but you can do the operations on the main unit if the controls are the same.

Disc information

Discs that can be played

DVD-Video	DVD-R	Audio CD	Video CD
Indication used in instructions			
DVD-V		CD*	VCD

*Including CD-R/RW and discs recorded with MP3.
Do not use irregularly shaped discs (e.g. heart-shaped), as these can damage the unit.

Region number supported by this player

Region numbers are allocated to DVD players and software according to where they are sold.

- The region number of this player is "1".
- The player will play DVD-Video marked with labels containing "1" or "ALL".

Example:



Discs that cannot be played

DVD-Audio, PAL discs, DVD-ROM, DVD-RAM, CD-ROM, CDV, CD-G, +RW, DVD-RW, CVD, SVCD, SACD, Divx Video Discs and Photo CD.

DVDs that can be played

This unit has a Dolby Digital decoder so you can play DVDs with this mark.

This unit does not have a DTS decoder. Connect this unit to equipment that has a DTS decoder to enjoy DVDs with this mark.



Playing DVDs and Video CDs

The producer of these discs can control how they are played so you may not always be able to control play as described in these operating instructions. Read the disc's instructions carefully.

CD-R and CD-RW discs

This unit can play CD-DA (digital audio) and video CD format audio CD-R and CD-RW that have been finalized (a process that enables CD-R/CD-RW players to play audio CD-R and CD-RW) upon completion of recording. It may not be able to play some CD-R or CD-RW due to the condition of the recording.

DVD-R discs

It may not be possible to play these discs in all cases due to the type of disc or condition of the recording.

Handling precautions

- Do not write on the label side with a ball-point pen or other writing instrument.
- Do not use record cleaning sprays, benzine, thinner, static electricity prevention liquids or any other solvent.
- Do not attach labels or stickers to discs. (Do not use discs with exposed adhesive from tape or left over peeled-off stickers.)
- Do not use scratch-proof protectors or covers.
- Do not use discs printed with label printers available on the market.

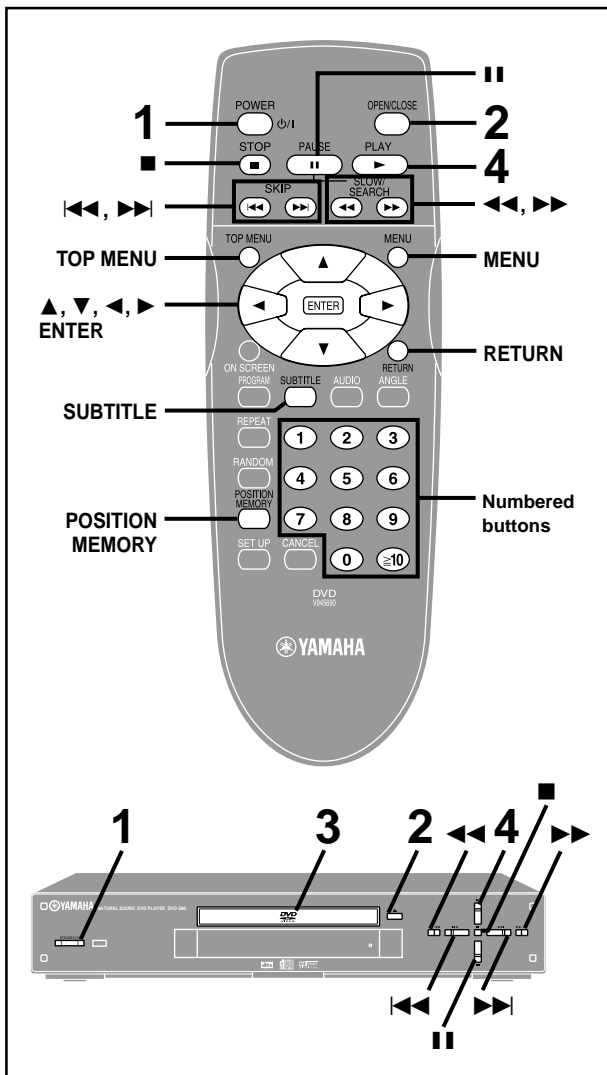

To stop play

Press [■] (→ page 9, Resume function).

To pause play

Press [⏸] during play.

Press [▶] (PLAY) to restart play.

■ Auto standby

The unit switches to standby mode after about 30 minutes in the stop mode.

Notes

● If "⊙" appears on the television

The operation is prohibited by the unit or disc.

● The disc continues to rotate while the menu is displayed even after you finish playing an item. Press [■] when you finish to preserve the unit's motor and your television screen.

● Volume may be lower when playing DVDs than when playing other discs or during television broadcasts.

If you turn the volume up on the television or amplifier, be sure to reduce the volume again before playing other sources so that a sudden increase in output does not occur.

When a menu screen appears on the television

DVD-V **VCD**

Remote control only

Press the numbered buttons to select an item.

To select a 2-digit number

Example: To select item 23, press [≧10] → [2] → [3].

● When playing DVDs, you can also use [▲, ▼, ◀, ▶] to select items. Press [ENTER] to confirm your selection.

Play of the selected item now begins.

Other buttons used to operate menus

Read the disc's instructions for further details about operation.

[▶▶]: Shows the next menu.

[◀◀]: Shows the previous menu.

[RETURN]: Shows the menu screen. **VCD**

[TOP MENU]: Shows the first menu screen. **DVD-V**

[MENU]: Shows the menu screen. **DVD-V**

Starting play from a selected title or track

DVD-V **CD** **VCD**

Remote control only

Press the numbered buttons to select the item.

To select a 2-digit number

Example: To select track 23, press [≧10] → [2] → [3].

CD (MP3 discs)

Press [ENTER] after pressing the numbered buttons.

(You do not have to press [≧10].)

Play starts from the selected item.

Note

This works only when stopped with some discs.

DVD-V **CD** **VCD**

Preparation

Turn on the television and select the appropriate video input on the television to suit the connections for the player.

- 1 Press [POWER ⏻] to turn on the unit.
- 2 Press [OPEN/CLOSE] to open the disc tray.
- 3 Place the disc on the disc tray.

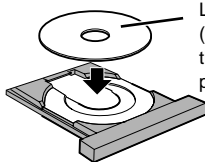

Label must face upward.
(With double-sided discs, load so the label for the side you want to play is facing up.)

- 4 Press [▶] (PLAY).

The disc tray closes and play begins.

CD (MP3 discs)

Group and track names are displayed on the television.

Press [SUBTITLE] to turn the display on or off.

Skipping chapters or tracks

DVD-V CD VCD

During play or while paused
Press [**⏮**] or [**⏭**].

- Each press increases the number of skips.

Fast forward and rewind—SEARCH

DVD-V CD VCD

During play
Press [**⏮**] or [**⏭**].

- Audio will be heard during search. You can turn this audio off if you want to (➔ page 16, Audio—Audio during Search).

Slow-motion play

DVD-V VCD

While paused
Press [**⏮**] or [**⏭**].

Frame-by-frame viewing

DVD-V VCD

Remote control only

While paused
Press [**⏮**] or [**⏭**].

The frame changes each time you press the button.

- The frames change in succession if you press and hold the button.
- Pressing [**⏭**] also activates forward frame-by-frame.

Notes

- The speed of search and slow-motion increases up to 5 steps.
- Press [**▶**] (PLAY) to restart play.
- You cannot move backwards with Video CD during slow-motion and frame-by-frame.

When playing Video CDs with playback control

Pressing buttons to perform skip, search or slow-motion may take you to a menu screen.

Resume function

DVD-V CD VCD

(When the elapsed play time is displayed)

The position you stopped play at is recorded by the unit when “▷” is flashing on the display.

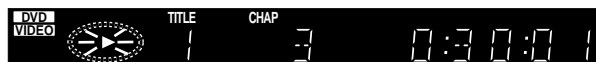

While “▷” is flashing, press [**▶**] (PLAY) to start play from where you stopped it. (When playing DVD ➔ Chapter Preview below)

- The position is cleared when the disc tray is opened or the unit is switched to standby.
- Press [**■**] to clear the position.

Position Memory function

Remote control only

This function allows you to memorize a position to start from even after switching the unit to standby or changing discs.

1. During play, press [POSITION MEMORY].
2. Press [POWER ⏻/⏼] to switch the unit to standby, or press [OPEN/CLOSE] to remove the disc.
3. When you are ready to play the disc again, press [**▶**] (PLAY). Play starts from the memorized position and the position is cleared. (When playing DVD ➔ Chapter Preview below)

Position memorized

To clear the position before play

Press [**■**] before recalling the memorized position.

- You can memorize positions on up to five different discs at a time. When you memorize another position, the earliest position is replaced.

Chapter Preview DVD-V

The following message appears immediately after you press [**▶**] (PLAY).

Press PLAY to Preview Chapters

Press [**▶**] (PLAY) while the message is displayed and the beginning portions of each chapter up to the current one are played. Full play resumes from the point where you pressed [**■**] or [POSITION MEMORY]. (This feature works only within a title.)

If you do not press [**▶**] (PLAY), the message disappears and play starts from where you pressed [**■**] or [POSITION MEMORY].

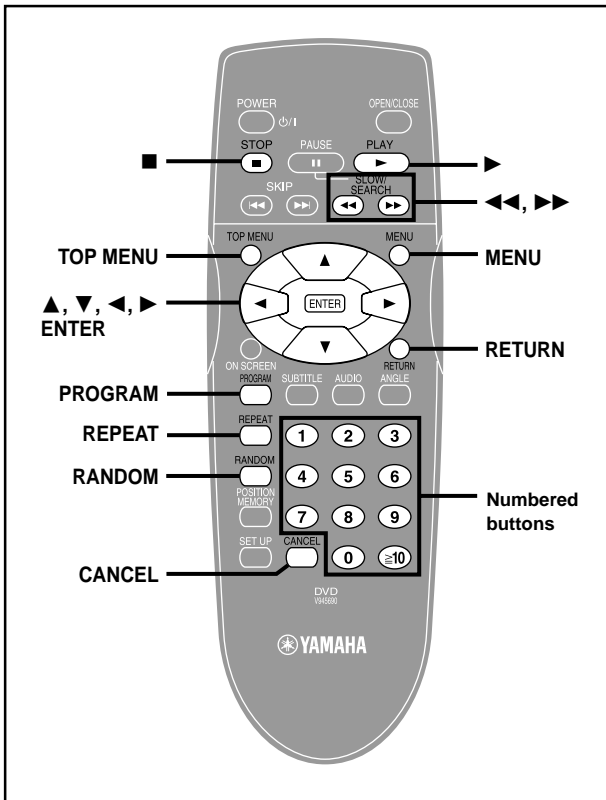

DVD-V **CD** **VCD**

(When the elapsed play time is displayed)

Repeat play

Remote control only

During play

Press [REPEAT].

Each time you press the button:

DVD-V

Chapter (C) → Title (T)* → OFF

CD **VCD**

Track (T) → Entire disc (A) → OFF

CD (MP3 discs)

Track (T) → Group (G)* → OFF

*"All (A)" during program and random play.

e.g. DVD-Video

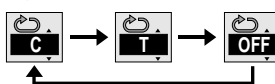

If the Video CD has playback control

1. Press [■] during play until "PBC PLAY" is cleared from the display.
2. Press the numbered buttons to select a track to start play (⇒ page 8).
3. Press [REPEAT] (⇒ above).

Note

You cannot use repeat play to repeat an entire DVD or an entire MP3 disc.

■ To repeat only your favorite tracks

Start program play (see right) and press [REPEAT] to display "A".

Program play

Remote control only

You can select up to 32 tracks/chapters to play in the order you choose.

While stopped

1. Press [PROGRAM].
e.g. CD

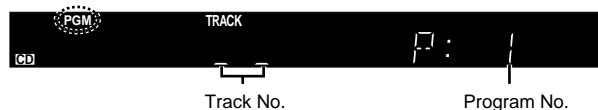
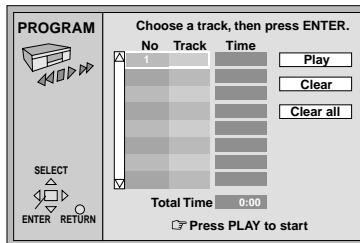

2. **DVD-Video, MP3 discs only**
Press the numbered buttons to select a title (DVD-Video) or group (MP3 discs).
 - Some items cannot be selected.
 - Different titles have different soundtracks and subtitles.
3. **Press the numbered buttons to select a track (CD or VCD) or chapter (DVD-Video) (and, for MP3 discs press [ENTER]).**
 - Repeat steps 2 and 3 to program other items.
 - **To select an item using the cursor buttons**
Press [ENTER] and [▲, ▼] to select an item, then press [ENTER] again to register the number.
All the items on a disc, a title or a group are selected when you select "ALL".
 - Times are not displayed when programming DVD-Video and MP3.
4. **Press [▶] (PLAY).**
Play now begins in the programmed sequence.
 - Some items cannot be played even if you program them. **DVD-V**

To add or change items

Press [▲, ▼] to select an available item, then repeat steps 2 and 3.

To move to the page before or after the one shown

Press [◀◀] or [▶▶].

To clear the programmed items one by one

Press [▲, ▼] to select the item number (No) and press [CANCEL]. (Alternatively, you can select "Clear" with [▲, ▼, ◀, ▶] and press [ENTER].)

To clear the whole program

Move to "Clear all" with [▲, ▼, ◀, ▶] and press [ENTER]. The whole program is also cleared when the unit is turned off or the disc tray is opened.

To exit the program mode

Press [PROGRAM] while stopped. (The program is retained in memory.)

Random play

DVD-V CD VCD

Remote control only

While stopped

- 1 Press [RANDOM].

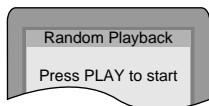

- 2 Press the numbered buttons to select a title (DVD-Video only) and press [▶] (PLAY).

•Some titles cannot be selected. DVD-V
Play now begins in random order.

To exit the random mode

Press [RANDOM] while stopped.

Using menus to play MP3 discs

CD (MP3 discs)

Remote control only

This unit can play MP3 files recorded on CD-R/RW with a computer. Files are treated as tracks and folders are treated as groups.

- 1 Press [TOP MENU] or [MENU].

A file list appears.

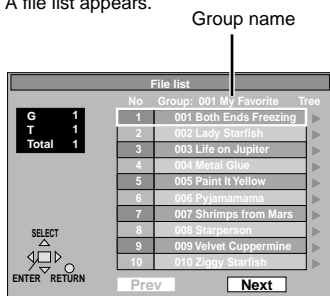

- 2 Press [▲, ▼] to select the track and press [ENTER].

Play starts and continues to the last track in the last group.

"▶" indicates the track currently playing.

To show other pages

Press [▲, ▼, ◀, ▶] to select "Prev" or "Next" and press [ENTER].

After listing all the tracks in one group, the list for the next group appears.

To close the file list screen

Press [TOP MENU] or [MENU].

Using the tree screen to find a group

- 1 Press [▶] while a track is highlighted to display the tree screen.

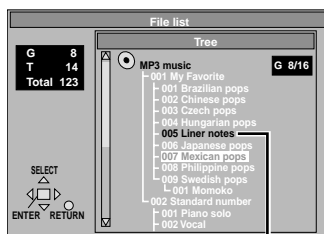

You cannot select groups that contain no compatible files.

- 2 Press [▲, ▼] to select a group and press [ENTER].

The file list for the group appears.

For your reference

Press [◀, ▶] to jump layers in the tree screen.

To return to the file list screen

Press [RETURN].

Notes

- Discs must conform to ISO9660 level 1 or 2 (except for extended formats). MP3 files must have the extension ".MP3" or ".mp3".
- This unit is compatible with multi-session but if there are a lot of sessions it takes more time for play to start. Keep the number of sessions to a minimum to avoid this.
- This unit is not compatible with ID3 tags.
- This unit is not compatible with files with a sampling rate of 32 kHz.

Naming folders and files

At the time of recording, prefix folder and file names with 3-digit numbers in the order you want to play them (this may not work at times).

Example:

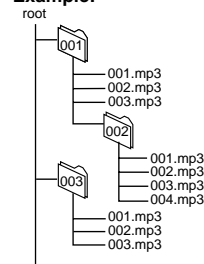

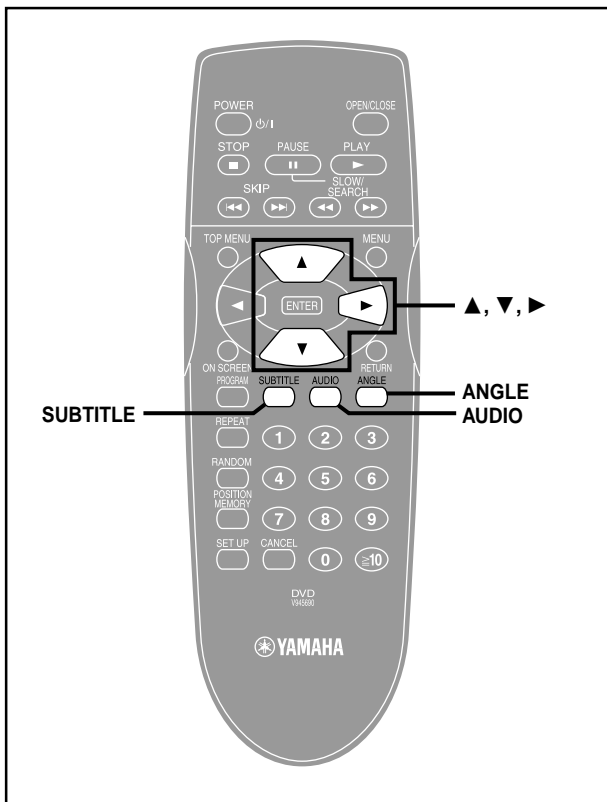

DVD-V

Remote control only

Some DVDs have multiple soundtracks, subtitle languages and camera angles, and you can change these during play.

- “—” or “—” is displayed instead of the language number in circumstances such as when no languages is recorded on the disc.

Soundtracks

During play

Press [AUDIO].

The number changes each time you press the button.

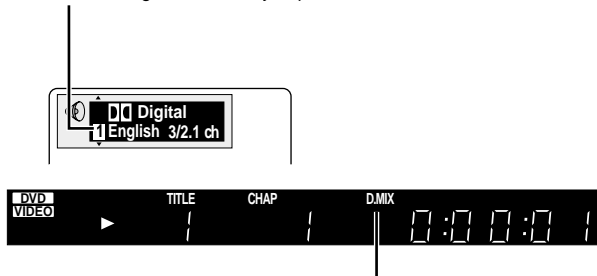

“D.MIX” indicates that a multi-channel soundtrack can be down-mixed to two channels.

- You can also use this button to turn the vocals on and off on karaoke discs. Read the disc's instruction for details.
- Refer to **B** on page 15 for audio signal type details.

Subtitles

During play

Press [SUBTITLE].

The number changes each time you press the button.

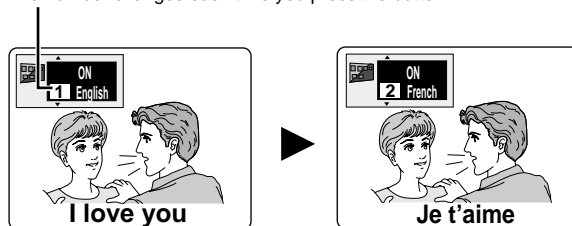

- In some cases, the subtitle language is not changed to the selected one immediately.
- If the subtitles overlap closed captions recorded on discs, turn the subtitles off.

To clear/display the subtitles

1. Press [SUBTITLE].
2. Press [▶].
3. Press [▲, ▼] to select “OFF” or “ON”.

Angles

During play

Press [ANGLE].

The number changes each time you press the button.

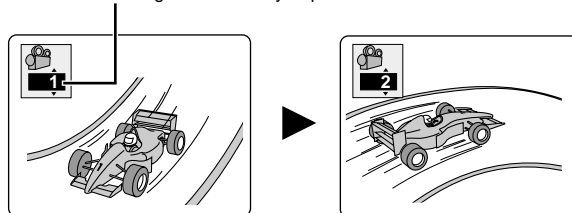

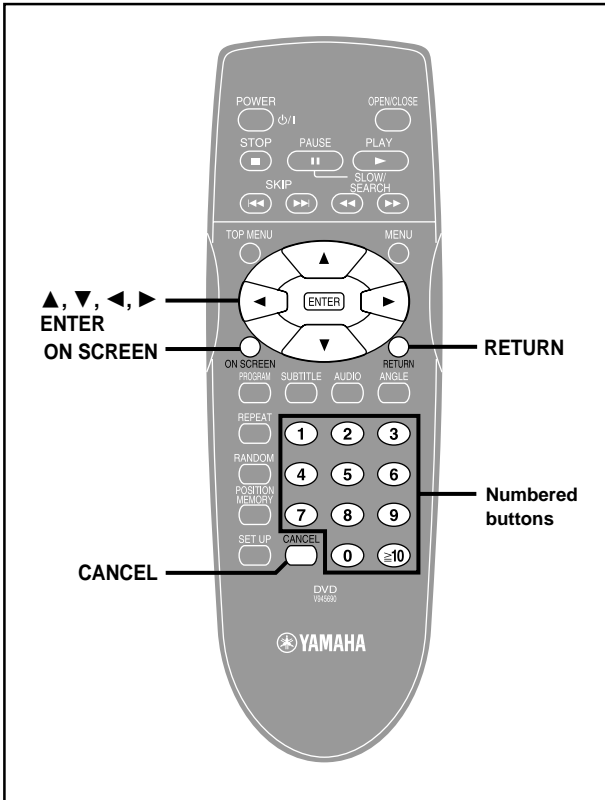

On-Screen Menu Icons are menus that contain information about the disc or unit. These menus allow you to perform operations by changing this information.

Common procedures

DVD-V CD VCD

Remote control only

1 Press [ON SCREEN].

Each time you press the button:

Disc information

Original display ← Unit information (⇒ step 2)

2 **Unit information only**

While the leftmost icon is highlighted

Press [▲, ▼] to select the menu.

Each time you press the button:

Play menu ↔ Video menu

Display menu ↔ Audio menu

3 Press [◀, ▶] to select the item.

4 Press [▲, ▼] to select the setting.

- Items with "▲" or "▼" above and below can be changed by [▲, ▼].
- Press [ENTER] if the setting does not change after pressing [▲, ▼].
- Some items require different operations. Read the following explanations.

For your reference

- Depending on the condition of the unit (playing, stopped, etc.) and the type of software you are playing, there are some items that you cannot select or change.
- When numbers are displayed (e.g. title No.), the numbered buttons are also effective for setting. After entering numbers, press [ENTER] to register the setting.

To clear the icons

Press [RETURN] until the menus disappear.

■ To change the position of the icons

1. Press [◀, ▶] to select the rightmost icon.
2. Press [▲, ▼] to move the icons.
(There are 5 positions.)



Disc information

e.g. DVD-Video

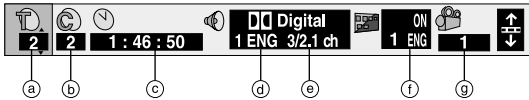

e.g. MP3 disc

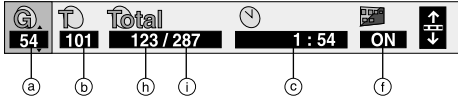

e.g. Video CD

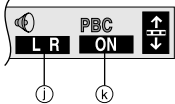

- a **T: Title number** **DVD-V**
- T: Track number** **CD VCD**
- G: Group number** **CD** (MP3 discs)
- b **C: Chapter number** **DVD-V**
- T: Track number in group** **CD** (MP3 discs)
- c **Time** **DVD-V**

- Press [▲, ▼] to show the elapsed play time or remaining time for the title (or chapter during program and random play).
- Select a position to start play by specifying a time with the numbered buttons and press [ENTER].

Changing the time display **CD VCD**

Press [▲, ▼] to show the elapsed play time, remaining time for the track, or remaining time for the disc.

Elapsed play time **CD** (MP3 discs)

(display only, cannot be changed)

- d **Soundtrack language** **DVD-V** (→ page 12)

(See **A** on page 15 for language abbreviations.)

- e **Audio signal type** **DVD-V**

(See **B** on page 15 for details.)

Karaoke vocal on/off (Karaoke DVD only) **DVD-V**

Solo: OFF or ON

Duet: OFF, V1+V2, V1 or V2

- f **Subtitle language** **DVD-V** (→ page 12)

(See **A** on page 15 for language abbreviations.)

Subtitles on/off **DVD-V**

ON ↔ OFF

Group/Track name display on/off **CD** (MP3 discs)

ON ↔ OFF

- g **Angle number** **DVD-V** (→ page 12)

- h **Track number in disc** **CD** (MP3 discs)

- i **Total number of tracks on disc** **CD** (MP3 discs)

- j **Audio mode** **VCD**

LR ↔ L ↔ R

- k **Playback control** **VCD**

Indicates whether playback control is on or off.

Unit information

Play menu

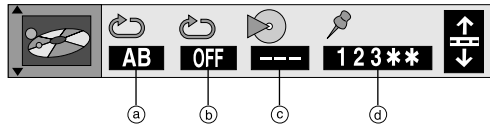

- a **A-B repeat** **DVD-V CD VCD**

You can repeat a section between points A and B within a title or track.
[ENTER] (start point) → [ENTER] (finish point)

To cancel: [ENTER]

- Some subtitles recorded around point A or B may fail to appear.

DVD-V

- The unit automatically determines the end of a title/track as point B when the end of the title/track is reached.

- b **Repeat play** (→ page 10)

DVD-V

Chapter (C) ↔ Title (T)*

↔ OFF ↔

CD (MP3 discs)

Track (T) ↔ Group (G)*

↔ OFF ↔

CD VCD

Track (T) ↔ Entire disc (A)

↔ OFF ↔

*"All (A)" during program and random play.

- c **Play mode display** **DVD-V CD VCD**

---: Normal play PGM: Program play RND: Random play

- d **Marker** **DVD-V CD VCD**

You can mark up to 5 positions to play again.

[ENTER] (The unit is now ready to accept markers.)

To mark a position: [ENTER] (at the desired point)

To mark another position: [◀, ▶] → [ENTER]

To recall a marker: [◀, ▶] → [ENTER]

To erase a marker: [◀, ▶] → [CANCEL]

Video menu



Cinema image **DVD-V VCD**

You can change the picture quality for movie viewing.

→ **Nor.:** Normal mode (Factory preset)



Cin.1: Mellows images and enhances detail in dark scenes



Cin.2: Sharpens images and enhances detail in dark scenes



→ **User:** User mode

The following items are also displayed when you select "User".

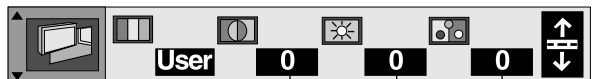

- a **Contrast** (−7 to +7)

- b **Brightness** (0 to +15)

- c **Color** (−7 to +7)

Audio menu

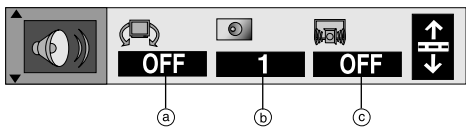

a) ADVANCED SURROUND **DVD-V (Dolby Digital, 2-channel or over only)**

Use ADVANCED SURROUND Virtual Surround Sound to enjoy a surround-like effect if you are using 2 front speakers. If you are playing a disc with surround effects recorded on it, the effect is broadened and sound seems to come from virtual speakers on either side.

- 1: Natural effect
- ↕
- 2: Emphasized effect
- ↕
- OFF: Cancel (Factory preset)

Optimum seating position

<When using the television's speakers>
Distance A =
Television's width

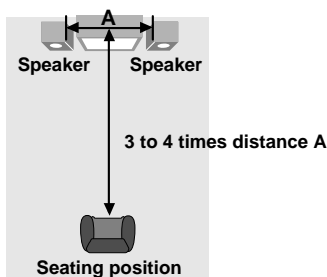

- Turn ADVANCED SURROUND off when using Dolby Pro Logic. Dolby Pro Logic will not work correctly if it is on.
- ADVANCED SURROUND will not work, or will have less effect with some discs.
- Turn off the surround sound effects on the equipment you have connected when using this effect.
- Turn ADVANCED SURROUND off if it causes distortion.

b) BASS EXTENSION **DVD-V **CD** **VCD****

Turn BASS EXTENSION on when you have connected an active subwoofer to the SUBWOOFER terminal on the rear of the unit (→ page 4).

- OFF (Factory preset)
- ↕
- 1: Natural bass effect
- ↕
- 2: Emphasized bass effect

c) CINEMA DIALOGUE **DVD-V (Dolby Digital, 3-channel or over, where the dialogue is recorded in the center channel)**

This mode makes the dialogue in movies easier to hear.
ON ↔ OFF (Factory preset)

- CINEMA DIALOGUE will not work, or will have less effect with some discs.

Display menu

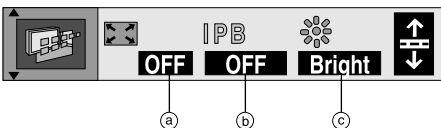

a) 4:3 TV ZOOM **DVD-V**

ON ↔ OFF
Expand a letterbox picture (→ page 6) to fill more of a regular 4:3 aspect television (The sides of the picture are cut off when you select ON).

- 4:3 TV ZOOM is cleared when you open the disc tray or switch the unit to standby.
- Depending on the video format of the disc and current play status, this feature may not work as described.
- Menus may act or appear differently while 4:3 TV ZOOM is on.

b) IPB display **DVD-V (→ page 19, Glossary)**

ON ↔ OFF
Displays the picture type (I/P/B) in the still picture mode.

c) Display dimmer **DVD-V **CD** **VCD****

Changes the brightness of the unit's display.
Bright ↔ Dim ↔ Auto* (**DVD-V** **VCD**)

*The display is dimmed during play, but brightens when you perform operations such as slow-motion, search, and pause.

A Audio/Subtitle language

ENG: English	SVE: Swedish	CHI: Chinese
FRA: French	NOR: Norwegian	KOR: Korean
DEU: German	DAN: Danish	MAL: Malay
ITA: Italian	POR: Portuguese	VIE: Vietnamese
ESP: Spanish	RUS: Russian	THA: Thai
NLD: Dutch	JPN: Japanese	*: Others

B Signal type/data





LPCM/□□ Digital/DTS/MPEG: Signal type
k (kHz): Sampling frequency
b (bit): Number of bits
ch (channel): Number of channels

Example: 3/2 .1ch

- ├ L: 1: Subwoofer signal (not displayed if there is no subwoofer signal)
- ├ 0: No surround
- ├ 1: Mono surround
- ├ 2: Stereo surround (left/right)
- ├ 1: Center
- ├ 2: Front left+Front right
- ├ 3: Front left+Front right+Center

Changing settings

This chart shows the settings for this unit. Change the settings to suit your preferences and to suit the unit to the environment in which it is being used. These settings are retained in memory until they are changed, even if the unit is turned off. See page 17 for details on menu operation.

Menus	Items	Options (Underlined items are the factory preset.)
	Audio <u>DVD-V</u> Choose the preferred audio language.	<u>English</u> French Spanish Original*1 Other *****2
	Subtitle <u>DVD-V</u> Choose the preferred subtitle language.	<u>Automatic</u> *3 English French Spanish Other *****2
	Menus <u>DVD-V</u> Choose the preferred language for disc menus.	<u>English</u> French Spanish Other *****2
	Ratings <u>DVD-V</u> Set a ratings level to limit DVD-Video play. • The password screen is shown if you choose levels 0 to 7 or if you choose "Ratings" when levels 0 to 7 have been selected (⇒ page 17). • Select "Level 0" to prevent play of discs that do not have ratings levels recorded on them.	Setting ratings (When level 8 is selected) 8 <u>No Limit</u> 1 to 7*4 0 Lock All <hr/> Changing ratings (When level 0–7 is selected) Unlock Player Change Password Change Level Temporary Unlock
	TV Aspect (⇒ page 6) Choose the setting to suit your television and preference.	<u>4:3 Pan&Scan</u> 4:3 Letterbox 16:9
	Still Mode (⇒ page 19, Glossary) Specify the type of picture shown when paused.	<u>Automatic</u> Field Frame
	Black Level Control Change the black level of the picture if you connected a television through the COMPONENT VIDEO OUT terminals.	<u>Lighter</u> : when connected to a TV through the VIDEO OUT or S VIDEO OUT terminal. Darker: when connected to a TV through the COMPONENT VIDEO OUT (Y/P _B /P _R) terminals.
	PCM Down Conversion <u>DVD-V</u> (⇒ page 17)	<u>No</u> Yes
	Dolby Digital <u>DVD-V</u> (⇒ page 17)	<u>Bitstream</u> PCM
	DTS Digital Surround <u>DVD-V</u> (⇒ page 17)	<u>Off</u> <u>Bitstream</u>
	D. Range Compression <u>DVD-V</u> Dolby Digital only (⇒ page 19, Glossary) Change the dynamic range for late night viewing.	<u>Off</u> On
	Audio during Search Choose whether to have sound during search.	<u>On</u> Off
	Menu Language Choose the preferred language for these menus and the on-screen messages.	<u>English</u> Français Español
	On-Screen Messages Choose whether to show on-screen messages or not.	<u>On</u> Off
	Demo A demonstration of the unit's on-screen displays starts when you select "On". The demonstration stops when you press a button and the setting reverts to "Off".	<u>Off</u> On
	QUICK SETUP (⇒ page 6) Answer questions to make basic settings.	Yes <u>No</u>

*1 The original language of each disc will be selected.

*2 Input a code number with the numbered buttons (see below).

*3 If the language selected for "Audio" is not available, subtitles of that language will automatically appear if available on that disc.

*4 Prohibits play of DVD-Video with corresponding ratings recorded on them.

Language code list

Abkhazian: 6566	Byelorussian: 6669	Georgian: 7565	Kashmiri: 7583	Mongolian: 7778	Serbo-Croatian: 8372	Tigrinya: 8473
Afar: 6565	Cambodian: 7577	German: 6869	Kazakh: 7575	Nauru: 7865	Shona: 8378	Tonga: 8479
Afrikaans: 6570	Catalan: 6765	Greek: 6976	Kirghiz: 7589	Nepali: 7869	Sindhi: 8368	Turkish: 8482
Albanian: 8381	Chinese: 9072	Greenlandic: 7576	Korean: 7579	Norwegian: 7879	Singhalese: 8373	Turkmen: 8475
Ameharic: 6577	Corsican: 6779	Guarani: 7178	Kurdish: 7585	Oriya: 7982	Slovak: 8375	Twi: 8487
Arabic: 6582	Croatian: 7282	Gujarati: 7185	Laotian: 7679	Pashto, Pushto: 8083	Slovenian: 8376	Ukrainian: 8575
Armenian: 7289	Czech: 6783	Hausa: 7265	Latin: 7665	Persian: 7065	Somali: 8379	Urdu: 8582
Assamese: 6583	Danish: 6865	Hebrew: 7387	Latvian, Lettish: 7686	Polish: 8076	Spanish: 6983	Uzbek: 8590
Aymara: 6588	Dutch: 7876	Hindi: 7273	Lingala: 7678	Portuguese: 8084	Sundanese: 8385	Vietnamese: 8673
Azerbaijani: 6590	English: 6978	Hungarian: 7285	Lithuanian: 7684	Punjabi: 8065	Swahili: 8387	Volapük: 8679
Bashkir: 6665	Esperanto: 6979	Icelandic: 7383	Macedonian: 7775	Quechua: 8185	Swedish: 8386	Welsh: 6789
Basque: 6985	Estonian: 6984	Indonesian: 7378	Malagasy: 7771	Rhaeto-Romance: 8277	Tagalog: 8476	Wolof: 8779
Bengali, Bangla: 6678	Faroese: 7079	Interlingua: 7365	Malay: 7783	Romanian: 8279	Tajik: 8471	Xhosa: 8872
Bhutani: 6890	Fiji: 7074	Irish: 7165	Malayalam: 7776	Russian: 8285	Tamil: 8465	Yiddish: 7473
Bihari: 6672	Finnish: 7073	Italian: 7384	Maltese: 7784	Samoan: 8377	Tatar: 8484	Yoruba: 8979
Breton: 6682	French: 7082	Japanese: 7465	Maori: 7773	Sanskrit: 8365	Telugu: 8469	Zulu: 9085
Bulgarian: 6671	Frisian: 7089	Javanese: 7487	Marathi: 7782	Scots Gaelic: 7168	Thai: 8472	
Burmese: 7789	Galician: 7176	Kannada: 7578	Moldavian: 7779	Serbian: 8382	Tibetan: 6679	

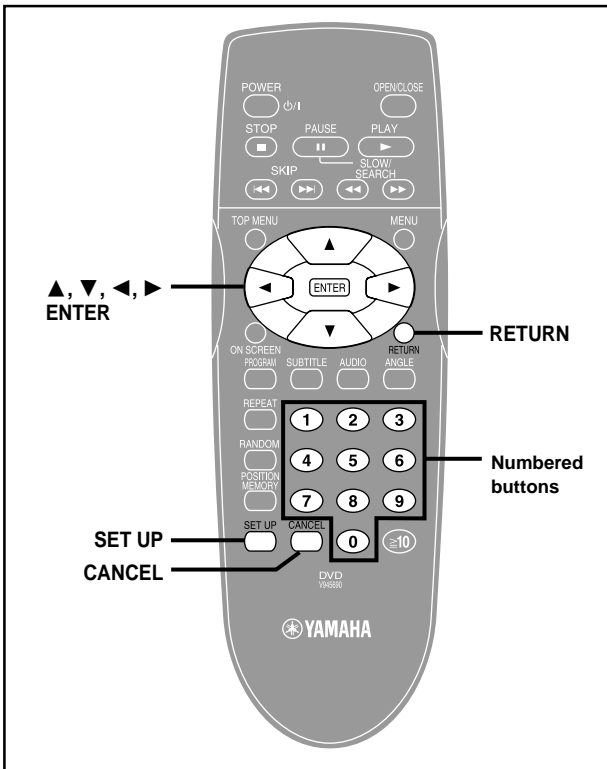

Entering a password (Ratings)

DVD-V

The password screen is shown when you select levels 0 to 7.

1. Input a 4-digit password with the numbered buttons and press [ENTER].
 - If you enter a wrong number, press [CANCEL] to erase it before you press [ENTER].
 - The lock symbol appears closed to show the rating is locked.
 - **Do not forget your password.**
2. Press [ENTER] to confirm the 4 digits.

Now, when you insert a DVD-Video that exceeds the ratings limit you set, a message appears on the television. Follow the on-screen instructions.

Digital output

DVD-V

Change the settings when you have connected equipment through this unit's DIGITAL AUDIO OUT terminal (OPTICAL).

PCM Down Conversion

Select how to output audio with a sampling frequency of 96 kHz.

Select "Yes" if the equipment you connect cannot process signals with a sampling frequency of 96 kHz.

- Select "No" if you use analogue connection, irrespective of the type of equipment.

No (Factory preset):

Output as 96 kHz. There is no output if the disc has copy protection. Select "Yes" in this case.

Yes:

Converted to 48 kHz for output.

Dolby Digital and DTS Digital Surround

Bitstream: (Factory preset for Dolby Digital and DTS Digital Surround)

Select if the equipment you connected can decode the signal.

PCM:

Select if the equipment you connected cannot decode the signal.

Off:

Select if the equipment you connected cannot decode the signal.

IMPORTANT

If the equipment you connected cannot decode the signal, the setting must be changed to PCM or Off. If not, signals the equipment cannot process will be output by this unit, causing high levels of noise which can damage your hearing and the speakers.

Common procedures

Remote control only

See page 16 for menu and option details.

- 1 Press [SET UP] to show the menus.

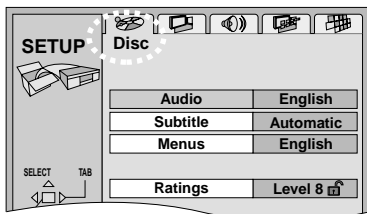

- The QUICK SETUP screen appears when you press [SET UP] the first time after purchase (→ page 6).

- 2 Press [◀, ▶] to select the menu's tab.

The screen changes to display the menu.

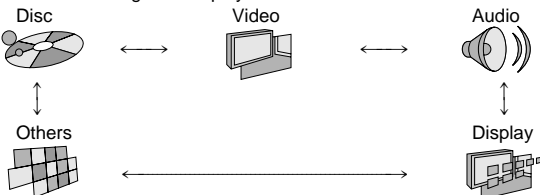

- 3 Press [▲, ▼] to select the item you want to change and press [ENTER].

- 4 Press [▲, ▼, ▶, ◀] to select the option and press [ENTER].

The screen now shows the menu again.

To return to the previous screen

Press [RETURN].

When you are finished

Press [SET UP].

Troubleshooting guide

Before requesting service, make the below checks. If you are in doubt about some of the check points, or if the remedies indicated in the chart do not solve the problem, consult your dealer for instructions.

Power		Page
No power.	●Insert the AC power cable securely into the household AC outlet.	5
The unit is automatically switched to the standby mode.	●To conserve power, the unit automatically switches to standby after approximately 30 minutes in the stop mode. Turn the power back to ON.	–

Operation

No response when buttons pressed.	●Some operations may be prohibited by the disc.	–
	●The unit may not be operating properly due to lightning, static electricity or some other external factor. Reset procedure: Press [STANDBY/ON] to switch the unit to the standby mode and then back to ON. Alternatively, press [STANDBY/ON] to switch the unit to the standby mode, disconnect the AC power cable, and then reconnect it.	–
No operations can be performed with the remote control.	●Check the batteries are installed correctly.	6
	●The batteries are depleted: Replace them with new ones.	6
	●Point the remote control at the remote control signal sensor and operate.	7
Play fails to start even when [▶] (PLAY) is pressed. Play starts but then stops immediately.	●Condensation has formed: Wait 1 to 2 hours for it to evaporate.	–
	●This unit cannot play discs other than DVD-Video, CD and Video CD.	7
	●This unit cannot play DVD-Video with a region number other than "1", "ALL" or multiple region numbers including "1".	7
	●The disc may be dirty and may require cleaning.	–
Alternative languages fail to be selected.	●Ensure that the disc is installed with the label of the side to be played facing upwards.	8
	●An alternative language is not selected with discs which do not contain more than one language.	–
No menus.	●In the case of some discs, the alternative language cannot be selected with [AUDIO] or [SUBTITLE]. Try selecting it from the disc's menu if one is available.	8
	●Menus are only displayed if they are recorded on the disc.	–
No subtitles.	●Subtitles appear only with discs that contain them.	–
	●Subtitles are cleared from the television. Display the subtitles.	12
Soundtrack and/or subtitle language is not the one selected with the SETUP menus.	●The language is not recorded on the disc.	–
Angle cannot be changed.	●This function is dependent on software availability. Even if a disc has a number of angles recorded, these angles may be recorded for specific scenes only.	12
CINEMA DIALOGUE has no effect.	●This feature does not work when the unit is outputting bitstream signals.	–
You have forgotten your ratings password.	●Reset all the settings to Factory Preset. While stopped, press and hold [◀◀] and [■] on the unit and then also press and hold [▲] on the unit until "Initialized" disappears from the television. Turn the unit off and on again. All settings will return to the default values.	–

Picture

Picture distorted.	●Some distortion is normal during SEARCH.	–
No picture.	●Ensure that the equipment is connected properly.	5
	●Make sure the television is on.	–
	●Ensure the television's video input setting (e.g., VIDEO 1) is correct.	–
The picture shown on the television is not normal. (The sides of the picture are cut off or black bands appear at the top and bottom of the screen.)	●Go to the Video menu in the SETUP screen, and change "TV Aspect" to suit your television. You may also need to change the screen mode on the television itself.	6, 16
	●Ensure that the unit is connected directly to the television, and is not connected through a video cassette recorder.	–
	●The 4:3 TV ZOOM function is on.	15
Picture quality is poor.	●Check the settings in the On-Screen Menu Icons' Video menu.	14

Sound

No sound. Distorted sound.	●Check the connections.	4, 5
	●Check the volume on the equipment you have connected.	–
	●Ensure that the input settings for the television and stereo system are correct.	–
Piercing noise comes from the speakers.	●Turn ADVANCED SURROUND off if it causes distortion.	15
	●If you have connected this unit to other equipment through the DIGITAL AUDIO OUT terminal, ensure you have selected the correct settings for "Dolby Digital" and "DTS Digital Surround" in the SETUP menu's Audio menu.	17

"NO PLAY"	●You inserted a disc the unit cannot play; insert one it can.	7
"CHECK DISC"	●Disc is dirty. Wipe the disc clean.	–
"H□□" □□ stands for a number.	●Trouble is likely to have occurred. The number following "H" depends on the status of the unit. Reset procedure: Press [STANDBY/ON] to switch the unit to the standby mode and then back to ON. Alternatively, press [STANDBY/ON] to switch the unit to the standby mode, disconnect the AC power cable, and then reconnect it. ●If the service numbers fail to clear, note the service number and contact a qualified service person.	–
"NO DISC"	●You haven't inserted a disc; insert one. ●You haven't inserted the disc correctly; insert it correctly.	– 8

Television displays

No on-screen display.	●Go to Display in the SETUP menus, and select "On" for "On-Screen Messages".	16
On-Screen Menu Icons not displayed or only partially displayed on the television.	●Press [▲, ▼] while the rightmost icon is highlighted to move them.	13
The disc's menu is displayed in a different language.	●Go to Disc in the SETUP menus, and select the preferred language for "Menus".	16

Maintenance

To clean this unit, wipe with a soft, damp cloth.

- Never use alcohol, paint thinner or benzine to clean this unit.
- Before using chemically treated cloth, read the instructions that came with the cloth carefully.

Glossary

Bitstream

This is the digital form of multiple channel audio data (e.g., 5.1 channel) before it is decoded into its various channels.

Decoder

A decoder restores the coded audio signals on DVDs to normal. This is called decoding.

Dolby Digital

This is a method of coding digital signals developed by Dolby Laboratories. Apart from stereo (2-channel) audio, these signals can also be 5.1-channel audio. A large amount of audio information can be recorded on one disc using this method.

Dolby Pro Logic

A surround system where a 4-channel audio track is recorded as 2 channels and then is restored to 4 channels for play. The surround channel is monaural and can reproduce up to 7 kHz.

DTS (Digital Theater Systems)

This surround system is used in many movie theaters around the world. There is good separation between the channels, so realistic sound effects are possible.

Dynamic range

Dynamic range is the difference between the lowest level of sound that can be heard above the noise of the equipment and the highest level of sound before distortion occurs.

Frame still and field still

Frames are the still pictures that go together to make a moving picture. There are about 30 frames shown each second.

One frame is made up of two fields. A regular television shows these fields one after the other to create frames.

A still is shown when you pause a moving picture. A frame still is made up of two alternating fields, so the picture may appear blurred, but overall quality is high. A field still is not blurred, but it has only half the information of a frame still so picture quality is lower.

I/P/B

MPEG 2, the video compression standard adopted for use with DVD-Video, codes frames using these 3 picture types.

I: Intra coded picture (I-picture)

This is the standard picture and is a complete picture in itself. This means it has the best picture quality and is the best to use when adjusting the picture.

P: Predictive coded picture (P-picture)

This picture is calculated based on past I or P-pictures.

B: Bidirectionally-predictive coded picture (B-picture)

This picture is calculated by comparing past and future I and P-pictures so it has the lowest volume of information.

Linear PCM (pulse code modulation)

These are uncompressed digital signals, similar to those found on CDs.

Playback control (PBC)

If a Video CD has playback control, you can select scenes and information with menus (called menu play in these instructions).

Specifications

Signal system:	NTSC
Operating temperature range:	+5 to +35 °C (+41 to +95 °F)
Operating humidity range:	5 to 90 % RH (no condensation)
Discs played [8 cm (3") or 12 cm (5")]:	
(1) DVD-Video, DVD-R (DVD-Video compatible)	
(2) CD-Audio (CD-DA)	
(3) Video CD	
(4) CD-R/CD-RW (CD-DA, Video CD formatted discs)	
(5) MP3	
• Maximum number of tracks and groups recognizable: 999 tracks and 99 groups	
• Compatible compression rate: between 32 kbps and 320 kbps	

Video output:	
Output level:	1 Vp-p (75 Ω)
Output terminal:	Pin jack (1 system)
S video output:	
Y output level:	1 Vp-p (75 Ω)
C output level:	0.286 Vp-p (75 Ω)
Output terminal:	S terminal (1 system)

Component video output:	
Y output level:	1 Vp-p (75 Ω)
P _B output level:	0.7 Vp-p (75 Ω)
P _R output level:	0.7 Vp-p (75 Ω)
Output terminal:	Pin jack (1 system)
	(Y: green, P _B : blue, P _R : red)

Audio output:	
Output level:	2 Vrms (1 kHz, 0 dB)
Output terminal:	Pin jack
Number of terminal:	
2ch:	1 system
Subwoofer output (0.1ch):	1 system
Audio performance:	
(1) Frequency response:	
• DVD (linear audio):	2 Hz–22 kHz (48 kHz sampling) 2 Hz–44 kHz (96 kHz sampling) 2 Hz–20 kHz
• CD audio:	
(2) S/N ratio:	115 dB
• CD audio:	
(3) Dynamic range:	
• DVD (linear audio):	102 dB
• CD audio:	98 dB
(4) Total harmonic distortion:	
• CD audio:	0.0025 %
Digital audio output:	
Optical digital output:	Optical terminal
Pickup:	Wave length: 658 nm/790 nm Laser power: CLASS IIa/CLASS I
Power supply:	AC 120 V, 60 Hz
Power consumption:	14 W
Dimensions:	435 (W)×247.5 (D)×74.5 (H) mm [17 ³ / ₁₆ " (W)×9 ³ / ₄ " (D)×2 ¹⁵ / ₁₆ " (H)] (excluding protrusions)
Weight:	2.6 kg (5.72 lb)

Power consumption in standby mode: approx. 3 W

Note

Specifications are subject to change without notice.
Weight and dimensions are approximate.

Manufactured under license from Dolby Laboratories.
"Dolby", "Pro Logic" and the double-D symbol are trademarks of Dolby Laboratories.

"DTS", "DTS Digital Surround" and "DTS Digital Out" are registered trademarks of Digital Theater Systems, Inc.

Apparatus Claims of U.S. Patent Nos. 4,631,603, 4,577,216, and 4,819,098, licensed for limited viewing uses only.

This product incorporates copyright protection technology that is protected by method claims of certain U.S. patents and other intellectual property rights owned by Macrovision Corporation and other rights owners. Use of this copyright protection technology must be authorized by Macrovision Corporation, and is intended for home and other limited viewing uses only unless otherwise authorized by Macrovision Corporation. Reverse engineering or disassembly is prohibited.

YAMAHA ELECTRONICS CORPORATION, USA 6660 ORANGETHORPE AVE., BUENA PARK, CALIF. 90620, U.S.A.
YAMAHA CANADA MUSIC LTD. 135 MILNER AVE., SCARBOROUGH, ONTARIO M1S 3R1, CANADA
YAMAHA ELECTRONIK EUROPA G.m.b.H. SIEMENSSTR. 22-34, 25462 RELINGEN BEI HAMBURG, F.R. OF GERMANY
YAMAHA ELECTRONIQUE FRANCE S.A. PA PARIS-EST RUE AMBROISE CROIZAT CROISSY-BEAUBOURG BP70-77312 MARNE LAVALLEE, CEDEX 2 FRANCE
YAMAHA ELECTRONICS (UK) LTD. YAMAHA HOUSE, 200 RICKMANSWORTH ROAD WATFORD, HERTS WD1 7JS, ENGLAND
YAMAHA SCANDINAVIA A.B. J A WETTERGRENS GATA 1, BOX 30053, 400 43 VÄSTRA FRÖLUNDA, SWEDEN
YAMAHA MUSIC AUSTRALIA PTY, LTD. 17-33 MARKET ST., SOUTH MELBOURNE, 3205 VIC., AUSTRALIA

YAMAHA CORPORATION

Free Manuals Download Website

<http://myh66.com>

<http://usermanuals.us>

<http://www.somanuals.com>

<http://www.4manuals.cc>

<http://www.manual-lib.com>

<http://www.404manual.com>

<http://www.luxmanual.com>

<http://aubethermostatmanual.com>

Golf course search by state

<http://golfingnear.com>

Email search by domain

<http://emailbydomain.com>

Auto manuals search

<http://auto.somanuals.com>

TV manuals search

<http://tv.somanuals.com>