

Yamaha created this package to greatly enhance your audio and home theater enjoyment. This System Connection Guide will help you get started. Follow the steps to connect the speakers first. Then connect your video monitor, DVD Player and other components. Refer to your Owner's Manuals as well as those that came with your other components for complete instructions and precautions. Be sure that all components are not plugged in while making connections.

STEP 1: Unpack and connect speakers

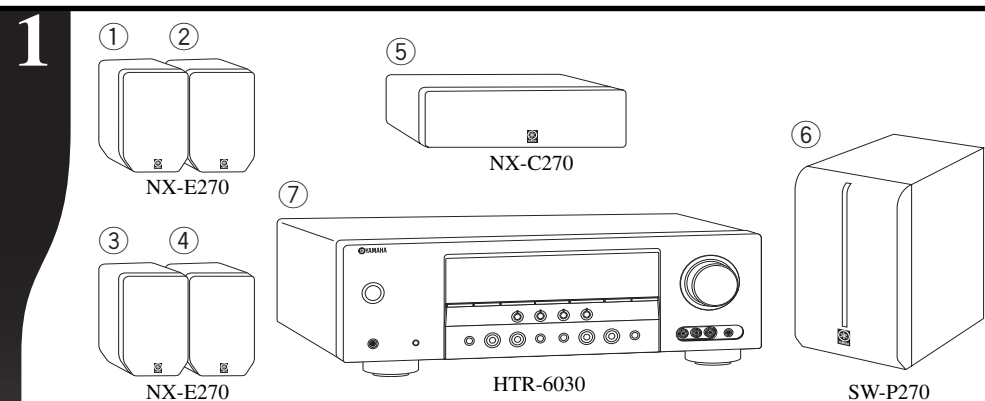

Inspect contents

After unpacking, inspect the contents to confirm you have the above items: NX-E270 two front speakers (1, 2), NX-E270 two surround speakers (3, 4), NX-C270 one center speaker (5), SW-P270 powered subwoofer (6), HTR-6030 AV Receiver (7) with remote control. Also included, but not shown, are five speaker wires, one subwoofer cable, AM and FM antennas, fasteners, non-skid pads, and three related Owner's Manuals.

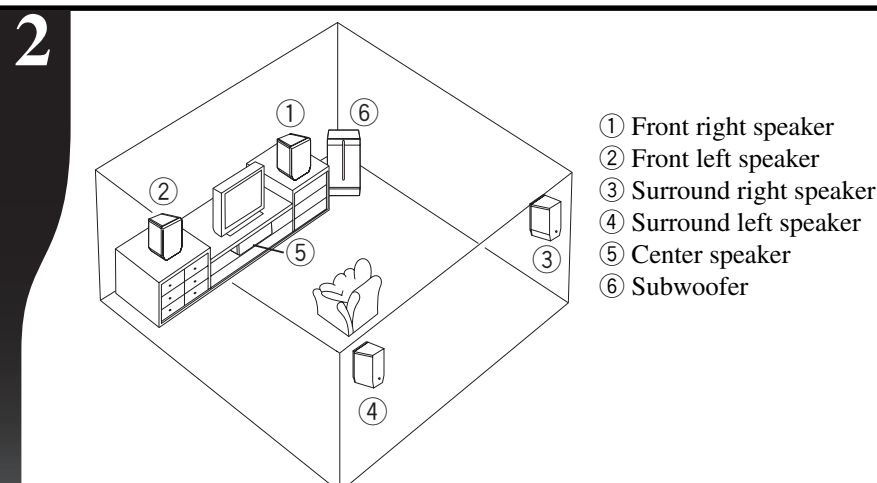

Place speakers

Place speakers so they appear in the approximate positions as shown in the diagram above. See your Owner's Manual for more information on speaker placement and mounting.

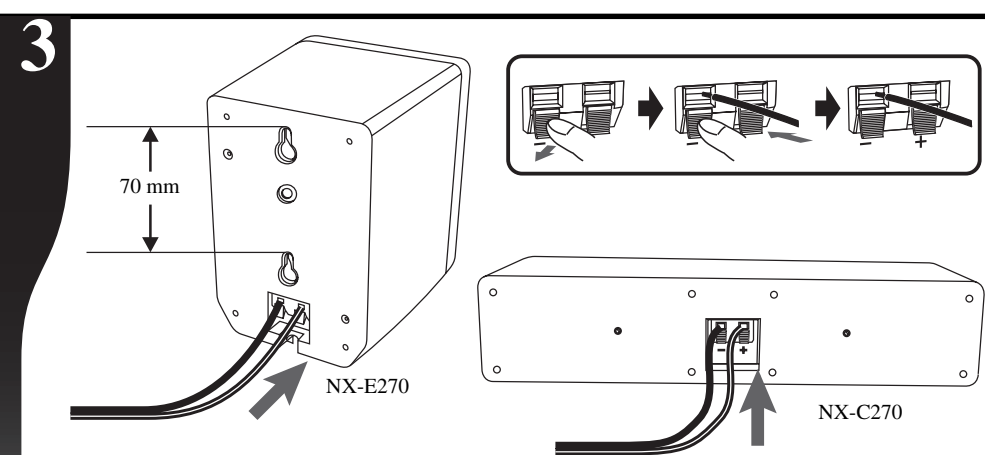

Connect speaker wires

Connect speaker wire for front speakers (1, 2), surround speakers (3, 4), and center speaker (5). The positive (+) side of the wire with the white stripe attaches to the red terminal. The negative (-) side attaches to the black terminal. See your Owner's Manual for more information on speaker wire connections.

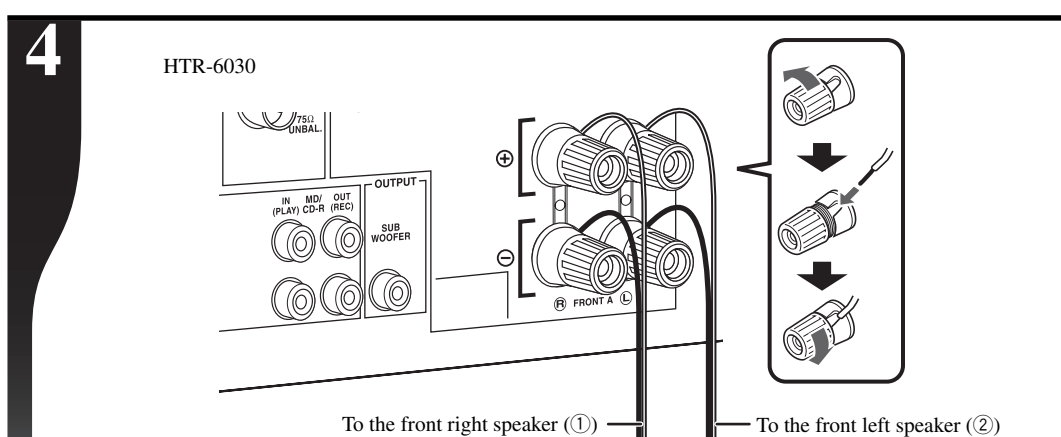

Connect front speakers

Connect speaker wires for front speakers (1, 2). The positive (+) side of the wire with the white stripe attaches to the red terminal. The negative (-) side attaches to the black terminal.

CAUTION

Receiver must not be plugged in while connecting speakers.

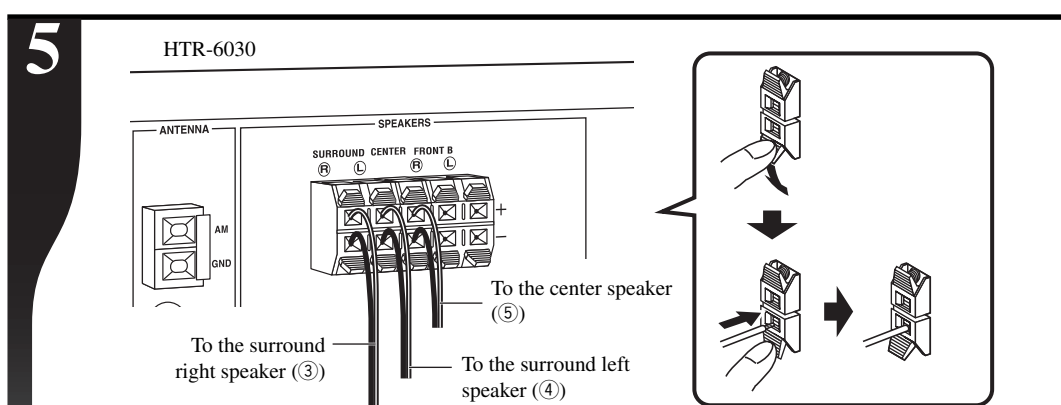

Connect surround and center speakers

Connect speaker wire for surround speakers (3, 4) and center speaker (5). The positive (+) side of the wire with the white stripe attaches to the red terminal. The negative (-) side attaches to the black terminal.

CAUTION

Receiver must not be plugged in while connecting speakers.

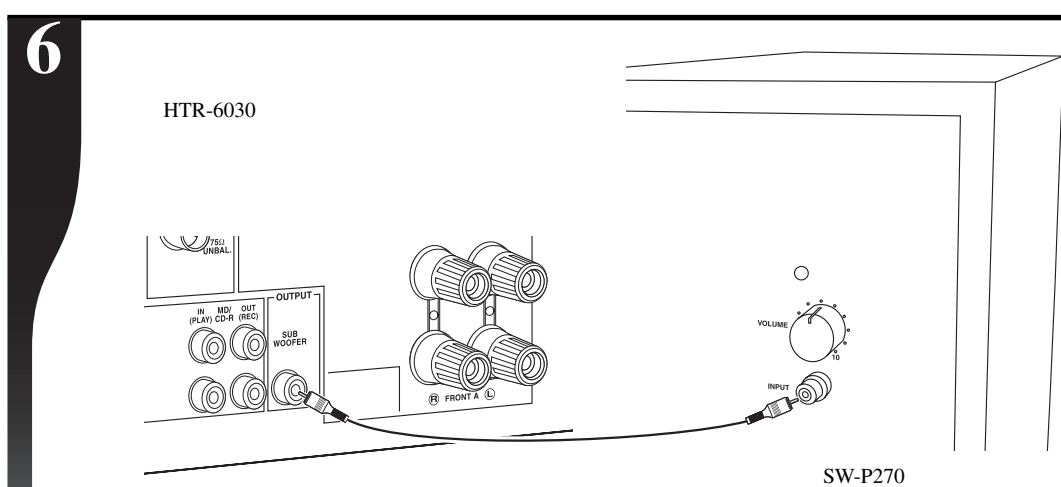

Connect the subwoofer

Connect the subwoofer cable to the subwoofer (6). Set subwoofer VOLUME control to half-way mark and POWER to OFF (rear panel).

CAUTION

Components must not be plugged in while connecting them.

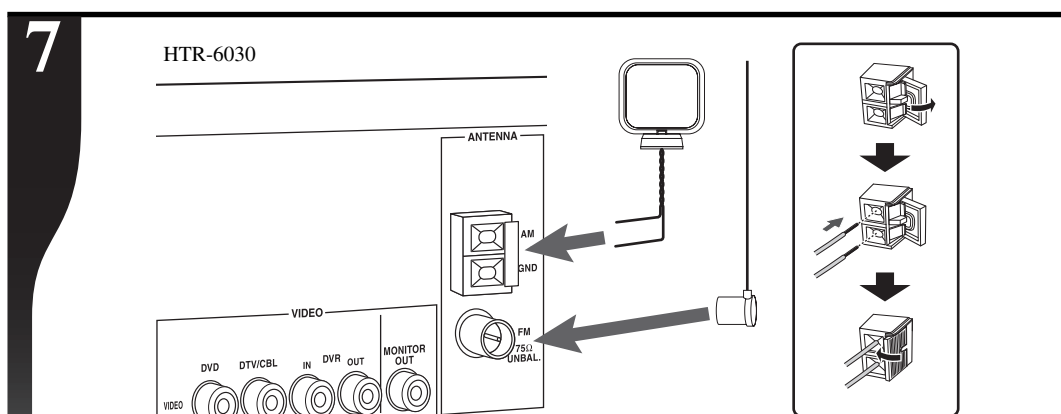

Connect antennas

Keeping receiver unplugged, connect AM loop antenna and indoor FM antenna as shown. For more information about obtaining clear reception and grounding, see your Owner's Manual.

STEP 2: Connect other home theater components (optional)

CAUTION

Components must not be plugged in while connecting them. Wait until all connections are made before plugging in your components.

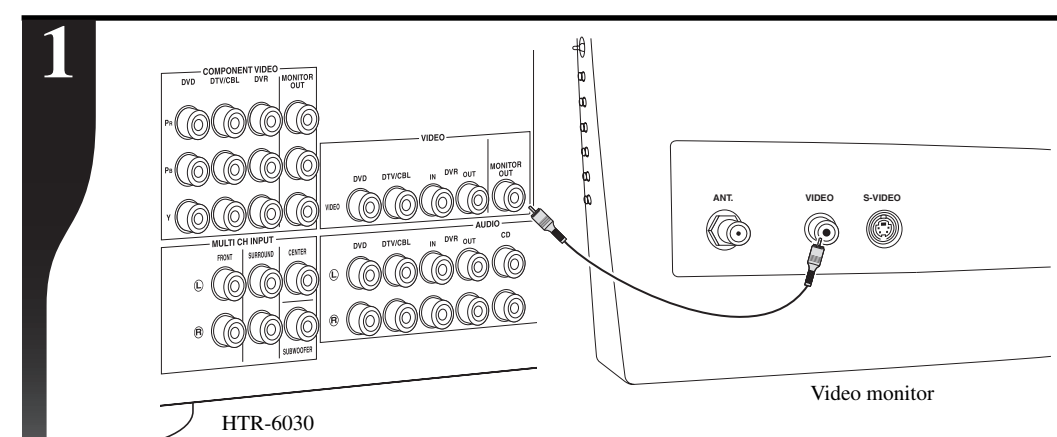

Connect a video monitor

Connect the MONITOR OUT jack of the receiver and the video input jack of your video monitor using an RCA video cable (not included).

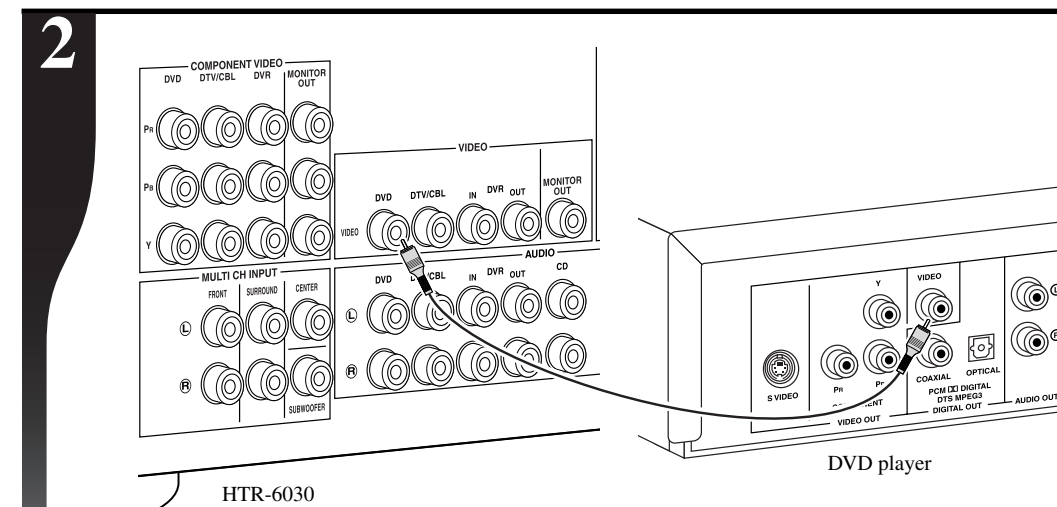

Connect a DVD player (video)

Connect the DVD VIDEO IN jack of the receiver and the video output jack of your DVD player using an RCA video cable (not included).

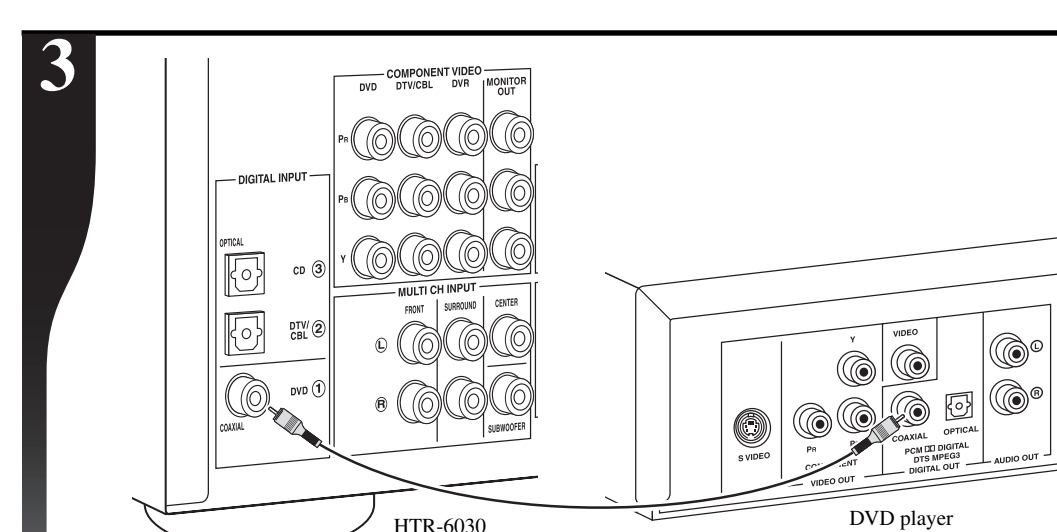

Connect a DVD player (audio)

Connect the DVD DIGITAL INPUT jack of the receiver and the digital output jack of your DVD player using a coaxial cable (not included).

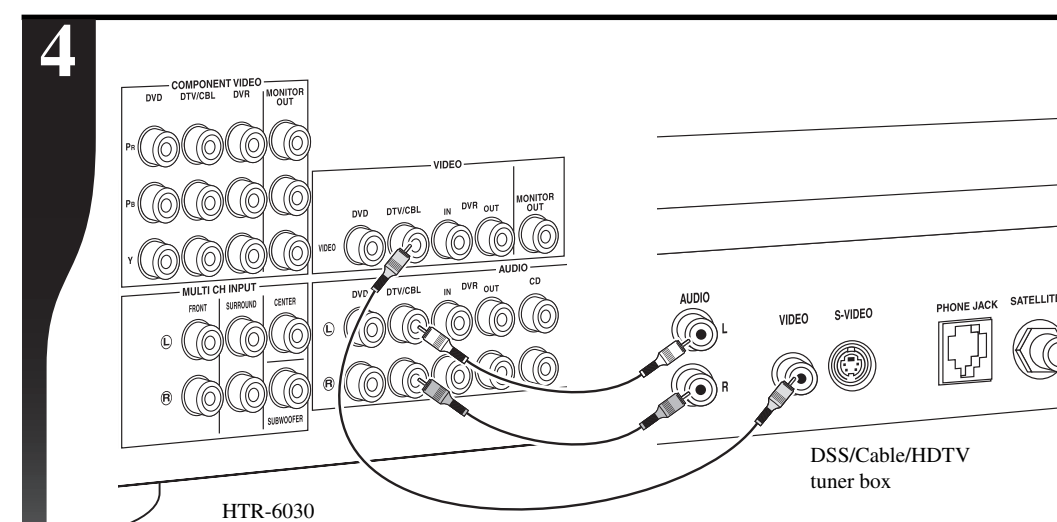

Connect a DSS/Cable/HDTV tuner box

Connect the DTV/CBL jacks of the receiver and the output jacks of your set-top box using RCA audio/video cables (not included) as shown.

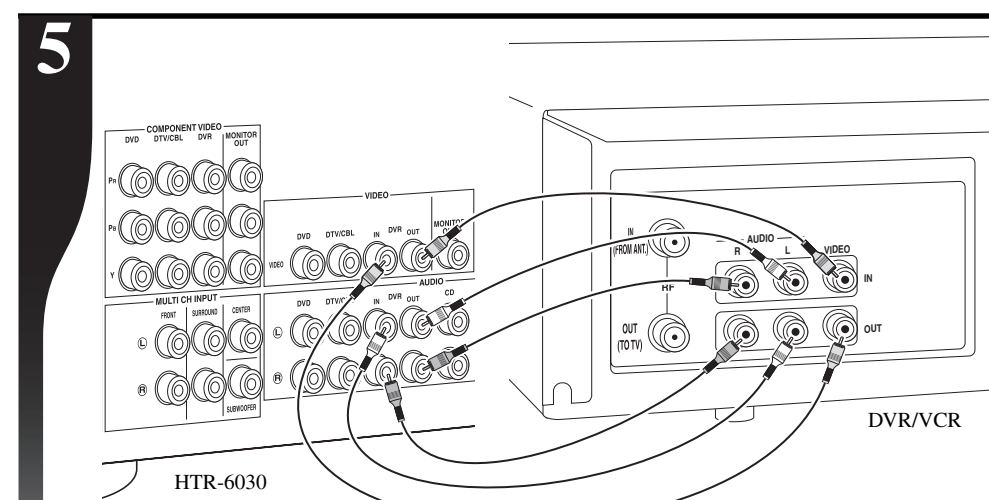

Connect a DVR/VCR

Connect DVR IN/OUT jacks of the receiver and the input/output jacks of your component using RCA audio/video cables (not included) as shown.

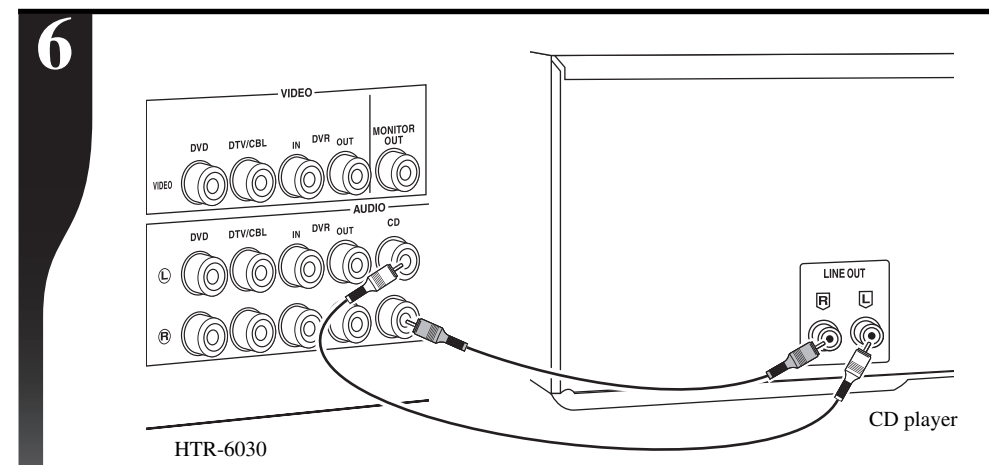

Connect a CD player

Connect CD jacks of the receiver and the output jacks of your CD player using RCA audio cables (not included).

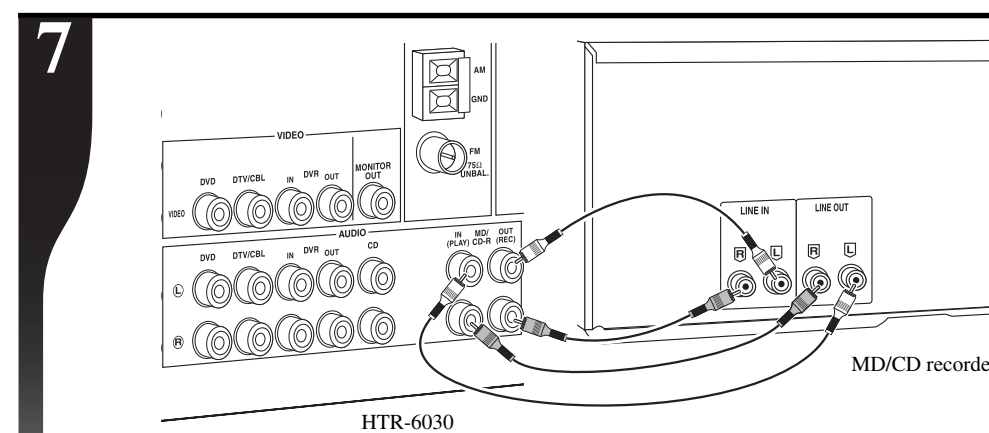

Connect an MD/CD recorder

Connect MD/CD-R IN/OUT jacks of the receiver and the input/output jacks of your components using RCA audio cables (not included) as shown.

STEP 3: Plug in

Plug in the subwoofer, receiver, DVD player and other components. Power on the receiver first, then the subwoofer and other components. Please see each of your respective Owner's Manuals for recommended guidelines and settings.

Enjoy the Yamaha Home Theater experience

- Be sure to put batteries in your remote control (see Owner's Manual for instructions).
- Refer to your Owner's Manuals for each component in your system for more information.
- You can simply operate the receiver by using the SCENE function (see page 4 in the Owner's Manual of HTR-6030).

Now, relax and enjoy the unparalleled sound of your Yamaha Home Theater system.

Free Manuals Download Website

<http://myh66.com>

<http://usermanuals.us>

<http://www.somanuals.com>

<http://www.4manuals.cc>

<http://www.manual-lib.com>

<http://www.404manual.com>

<http://www.luxmanual.com>

<http://aubethermostatmanual.com>

Golf course search by state

<http://golfingnear.com>

Email search by domain

<http://emailbydomain.com>

Auto manuals search

<http://auto.somanuals.com>

TV manuals search

<http://tv.somanuals.com>