

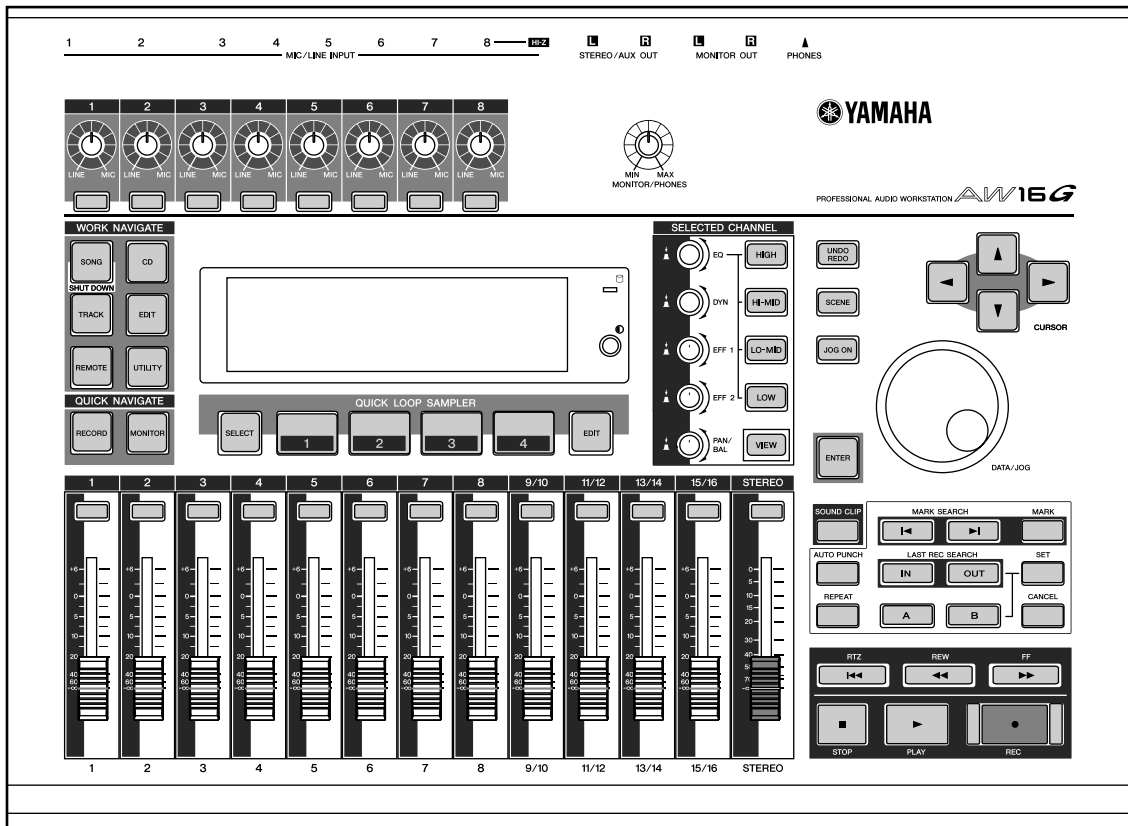

AW16G

PROFESSIONAL AUDIO WORKSTATION

Owner's Manual



Keep This Manual For Future Reference.



FCC INFORMATION (U.S.A.)

1. **IMPORTANT NOTICE: DO NOT MODIFY THIS UNIT!** This product, when installed as indicated in the instructions contained in this manual, meets FCC requirements. Modifications not expressly approved by Yamaha may void your authority, granted by the FCC, to use the product.
2. **IMPORTANT:** When connecting this product to accessories and/or another product use only high quality shielded cables. Cable/s supplied with this product **MUST** be used. Follow all installation instructions. Failure to follow instructions could void your FCC authorization to use this product in the USA.
3. **NOTE:** This product has been tested and found to comply with the requirements listed in FCC Regulations, Part 15 for Class "B" digital devices. Compliance with these requirements provides a reasonable level of assurance that your use of this product in a residential environment will not result in harmful interference with other electronic devices. This equipment generates/uses radio frequencies and, if not installed and used according to the instructions found in the users manual, may cause interference harmful to the operation of other electronic devices. Compliance with FCC regulations does not guarantee that interference will not occur in all installations. If this product is found to be the source of interference, which can be determined by turning the unit "OFF" and "ON", please try to eliminate the problem by using one of the following measures: Relocate either this product or the device that is being affected by the interference. Utilize power outlets that are on different branch (circuit breaker or fuse) circuits or install AC line filter/s. In the case of radio or TV interference, relocate/reorient the antenna. If the antenna lead-in is 300 ohm ribbon lead, change the lead-in to coaxial type cable. If these corrective measures do not produce satisfactory results, please contact the local retailer authorized to distribute this type of product. If you can not locate the appropriate retailer, please contact Yamaha Corporation of America, Electronic Service Division, 6600 Orangethorpe Ave, Buena Park, CA 90620

The above statements apply **ONLY** to those products distributed by Yamaha Corporation of America or its subsidiaries.

IMPORTANT

THE WIRES IN MAINS LEAD ARE COLOURED IN ACCORDANCE WITH THE FOLLOWING CODE:

BLUE : NEUTRAL
BROWN : LIVE

As the colours of the wires in the mains lead of this apparatus may not correspond with the coloured markings identifying the terminals in your plug proceed as follows:

The wire which is coloured BLUE must be connected to the terminal which is marked with the letter N or coloured BLACK.

The wire which is coloured BROWN must be connected to the terminal which is marked with the letter L or coloured RED.

Making sure that neither core is connected to the earth terminal of the three pin plug.

* This applies only to products distributed by YAMAHA KEMBLE MUSIC (U.K.) LTD.

PRECAUTIONS – for safe operation –

WARNING

Installation

- Connect this unit's power cord only to an AC outlet of the type stated in this Owner's Manual or as marked on the unit. Failure to do so is a fire and electrical shock hazard.
- Do not allow water to enter this unit or allow the unit to become wet. Fire or electrical shock may result.
- Do not place a container with liquid or small metal objects on top of this unit. Liquid or metal objects inside this unit are a fire and electrical shock hazard.
- Do not place heavy objects, including this unit, on top of the power cord. A damaged power cord is a fire and electrical shock hazard. In particular, be careful not to place heavy objects on a power cord covered by a carpet.
- Do not install a CD-RW drive into this device while the power cable is plugged into an AC outlet. Doing so is an electrical shock hazard.
- Use the ground connector on the rear panel to securely ground the device. If the device is not grounded, you may suffer a dangerous electrical shock.

Operation

- Do not scratch, bend, twist, pull, or heat the power cord. A damaged power cord is a fire and electrical shock hazard.

- Do not modify the unit. Doing so is a fire and electrical shock hazard.
- If lightning begins to occur, turn off the power switch of the unit as soon as possible, and unplug the power cable plug from the electrical outlet.
- If there is a possibility of lightning, do not touch the power cable plug if it is still connected. Doing so may be an electrical shock hazard.
- Use only the included AC adaptor (PA-300) for this unit. Using other types may be a fire and electrical shock hazard.

In case an abnormality occurs during operation

- If the power cord is damaged (i.e., cut or a bare wire is exposed), ask your dealer for a replacement. Using the unit with a damaged power cord is a fire and electrical shock hazard.
- Should this unit and AC adaptor be dropped or the cabinet be damaged, turn the power switch off, remove the power plug from the AC outlet, and contact your dealer. If you continue using the unit without heeding this instruction, fire or electrical shock may result.
- If you notice any abnormality, such as smoke, odor, or noise, or if a foreign object or liquid gets inside the unit, turn it off immediately. Remove the power cord from the AC outlet. Consult your dealer for repair. Using the unit in this condition is a fire and electrical shock hazard.

CAUTION

Installation

- Hold the power cord plug when disconnecting it from an AC outlet. Never pull the cord. A damaged power cord is a potential fire and electrical shock hazard.
- Do not touch the power plug with wet hands. Doing so is a potential electrical shock hazard.
- This unit has ventilation holes at the bottom and rear to prevent the internal temperature rising too high. Do not block them. Blocked ventilation holes are a fire hazard.
In particular, do not
 - place the unit on its side or upside down,
 - place the unit in any poorly-ventilated location such as a bookcase or closet.
 - cover the unit with a table cloth or place it on a carpet or bed.

- Always touch a well-grounded metal surface or the like to fully discharge any static electric charge on your body and clothing before handling a CD-RW drive.
Neglecting this precaution can cause damage to the unit from static electricity.
- Be careful not to touch the leads (metal feet) on the rear side when handling a CD-RW drive. Touching the leads can cause contact defects.

Operation

- Do not cover or wrap the AC adaptor with a cloth or blanket. Heat may build up under the cloth or blanket, melting the case, or causing fire. Use only in a well-ventilated environment.

PRECAUTIONS – for correct operation –

Connector pin assignments

- XLR-type connectors are wired as follows: pin 1: ground, pin 2: hot (+), and pin 3: cold (-).

Replacing abrasive parts

- The performance of components with moving contacts, such switches, rotary controls, faders, and connectors, deteriorates over time. The rate of deterioration depends on the operating environment and is unavoidable. Consult your dealer about replacing defective components.

Interference with other electrical devices

- The digital circuits of this unit may induce a slight noise into nearby radios and TVs. If noise occurs, relocate the affected equipment.

Influence on cell phone usage

- Using a mobile telephone near this unit may induce noise. If noise occurs, use the telephone away from the unit.

■ Be sure to turn off the power when you are finished

When using the AC adaptor, a small amount of electrical current will still be flowing even if the power is turned off (i.e., the power switch set to "STANDBY"). The standby current consumption is designed to be as small as possible. If you will not be using this product for an extended period of time, be sure to unplug the AC adaptor from the AC outlet.

Handling the CD-R/RW media

Please observe the following points when handling the disc.

Failure to do so may cause problems such as the recorded data being lost, the drive to malfunction, or the printed label to become blurred.

- Do not place the disc in locations of direct sunlight, high temperature, or high humidity.
- Do not touch either surface of the disc.
Hold the disc at the edges.
- Gently wipe dust or dirt off of the recording surface of the disc.
Use an air duster or cleaner to remove dust. Vigorously rubbing the surface of the disc with a dry cloth may scratch the disc.
- Do not write on the disc or affix labels to it.
- Do not wipe the disc with chemicals or detergents.
- Do not bend or drop the disc.

Storing produced data

Produced data can be lost due to breakdown or mistaken operation. We strongly recommend that you store all data on CD-R/CD-RW discs.

Responsibility for loss of data, etc.

Yamaha will accept no responsibility for any damages (including consequential or incidental) incurred by the customer or any third party as a result of loss or impairment of the data stored on the CD-R media, regardless of whether such loss could have been or actually was foreseen by Yamaha.

Nor does Yamaha guarantee the media against any defect that may render it unusable.

Cautions for handling optional equipment

- For inquiries concerning CD-RW drive handling, please consult your Yamaha dealer.
- Always switch off the power for the main unit and all peripherals, unplug the AC adaptor for the main unit and the outlet, then disconnect the cables connecting the main unit with the peripherals before starting installation work.
- Wear thick gloves when working on this equipment to avoid cutting your hands on metal fittings or the like on the main unit or CD-RW drive.
- Always touch a well-grounded metal surface or the like to fully discharge any static electric charge on your body and clothing before starting to work on this equipment.
- Take extreme care to avoid touching any terminals or board surface parts.
- In order to protect the electronic circuits of the CD-RW drive, etc. from damage due to static electricity, when handling any of this equipment, take the most extreme care to avoid touching IC leads or other electronic parts.
- Be careful not to drop any screws into the main unit. If you switch the power on with a dropped screw still in the main unit, the main unit may malfunction or break down. If a dropped screw can not be retrieved, consult your Yamaha dealer.
- If the CD-RW drive breaks down, contact the store where you purchased that equipment.

Copyright Notice

Copyright and other intellectual property laws in various countries permit reproduction of copyrighted materials under certain requirements. The observance of applicable laws for use of this product, however, is your responsibility. Yamaha disclaims any liability for violation of such laws in association with the use of this product.

Although this product is designed for original music production, it can be utilized to make reproduction of copyrighted music and other sound products. While certain reproduction and use of reproduced materials are permitted under applicable laws, such reproduction and use without license may constitute copyright infringement and other violation of laws. Since violation of such laws can have serious consequences, you may wish to consult a legal expert about your planned use of this product.

This product incorporates and bundles computer programs and contents in which Yamaha owns copyrights or with respect to which it has license to use others' copyrights. Such copyrighted materials include, without limitation, all computer software, styles files, MIDI files, WAVE data and sound recordings. Any unauthorized use of such programs and contents outside of personal use is not permitted under relevant laws. Any violation of copyright has legal consequences. DON'T MAKE, DISTRIBUTE OR USE ILLEGAL COPIES.

The illustrations and LCD screens as shown in this owner's manual are for instructional purposes only, and may appear somewhat different from those on your instrument.

Contents

1 Before you start	9	6 Overdubbing.....	55
Introduction	9	About overdubbing.....	55
Remember to back up your data	9	Assigning the input signal to a track.....	56
About the CD-RW drive.....	10	Instantly recalling an EQ library.....	56
Installing the CD-RW drive.....	10	Instantly recalling a dynamics library.....	57
Removing the CD-RW drive.....	11	Setting the mix balance and pan.....	57
Using the CD-RW drive.....	11	Overdubbing.....	58
Connecting the AC adaptor.....	12	Punch-in/out.....	59
Turning the power on/off.....	12	Manual punch-in/out.....	59
		Auto punch-in/out.....	59
2 Introducing the AW16G	13	Using the Undo List.....	61
Features of the AW16G	13	Switching virtual tracks.....	62
AW16G terminology	15	Saving the current song.....	63
Recorder section.....	15	Loading an existing song.....	64
Mixer section.....	15		
Quick Loop Sampler section.....	16	7 Various types of playback	65
Overall.....	16	Using the locator.....	65
Parts of the AW16G and what they do	17	Using markers.....	67
Top panel.....	17	Adjusting the position of a locate point or	
Rear panel.....	21	marker.....	68
Front panel.....	22	Erasing a locate point or marker.....	69
Basic operation on the AW16G.....	23	Repeatedly playing a specific region (the A-B	
Viewing the display.....	23	Repeat function).....	70
Accessing a screen/page/channel.....	23	Finding a location while you listen to the	
Switching a button on/off.....	24	sound (the Nudge function).....	71
Editing a value in the display.....	24	Finding a location while you view the waveform.....	72
Inputting text.....	24		
Using the Selected Channel section.....	25	8 Using libraries and scene	
		 memories.....	73
3 Listening to the demo song.....	27	About the libraries.....	73
Connect external devices and turn on the		About scene memories.....	73
power.....	27	Basic operation for libraries and scene memories.....	74
Loading the demo song.....	28	Storing library or scene data.....	74
Playing the demo song.....	29	Recalling library or scene data.....	75
Mixing the demo song.....	30	Deleting library or scene data.....	75
		Naming library or scene data.....	76
4 Recording to a sound clip.....	33	Details on libraries and scene memory.....	77
Connecting your instrument or mic.....	33	Input library.....	77
Adjusting the input level.....	34	EQ library.....	77
Recording/playing a sound clip.....	35	Dynamics library.....	78
		Effect library.....	78
5 Track recording	39	Mastering library.....	78
Creating a new song.....	39	Sample library.....	78
Direct recording and Bus recording.....	40	Channel library.....	79
Assigning input signals to tracks (Direct		Scene memories.....	79
recording).....	42	Using the Recall Safe function.....	80
Assigning input signals to tracks (Bus recording).....	45		
Enabling the metronome.....	47	9 Mixdown and bounce operations .	81
Recording on a track.....	48	About mixdown and bouncing.....	81
Pairing input channels/track channels.....	49	Preparing for mixdown.....	83
Using the input library.....	50	Using the internal effects via send/return.....	84
Using the EQ library.....	52	Recording on the stereo track.....	86
Using the dynamics library.....	53	Bounce (ping-pong) recording procedure.....	87
		Convenient functions during mixdown/bounce	
		operations.....	89

Adding input signals or pad performances during mixdown	89
Using meters to check the level of each channel	90
Viewing all parameters for a certain channel.....	90
Initializing a channel	91
Editing the EQ parameters.....	92
Editing the dynamics parameters.....	93
Editing the parameters of an internal effect	94
Inserting an effect into a track channel	96

10 Creating an audio CD 97

Creating an audio CD	97
Types of media that you can use with the CD-RW drive.....	97
Methods of writing an audio CD.....	98
Basic settings for the CD-RW drive	99
Writing audio data (Track At Once)	100
Writing audio data (Disc At Once)	102
Finalizing CD-R/RW media	104
Erasing CD-RW media	105
Playing an audio CD	106

11 Quick loop sampler..... 107

About the quick loop sampler	107
Using sample libraries	109
Recording/playing a pad performance	110
Importing from an audio CD/WAV file to a pad	112
Importing from an audio track/stereo track to a pad	114
Sampling an external input signal.....	115
Editing the sample name	117
Trimming the playback region.....	118
Switching the playback mode for each pad	119
Using the Slice function	120
Deleting an unwanted sample	122

12 Track editing 123

What you can do using editing commands.....	123
Basic procedure for track editing	124
List of editing commands.....	126
ERASE.....	126
DELETE.....	127
INSERT	127
COPY	128
MOVE	129
EXCHANGE	130
TIME COMP/EXP (Time Compression/Expansion)	130
PITCH CHANGE.....	131
EXPORT.....	131
Exporting WAV files and importing audio CD or WAV files	132
Exporting WAV files.....	132
Importing from an audio CD or WAV file.....	133

13 Song management..... 137

About songs	137
Editing the song name.....	138
Editing various settings for the song	139

Copying or deleting a song	140
Optimizing a song	141
Creating a tempo map	142
Importing data from an existing song.....	144
Backing up songs and sample libraries	145
Restoring songs or sample libraries	147
Exchanging song data with the AW4416/AW2816	148

14 MIDI and utility functions..... 149

What you can do using MIDI	149
Basic MIDI settings	150
Transmitting the AW16G's settings via MIDI (Bulk Dump).....	154
Using the MIDI Remote function.....	155
About the MIDI Remote function	155
Using the MIDI Remote function presets	155
Using the user-defined Remote function.....	157
Using the test tone oscillator.....	159
Digital input settings/Checking and initializing the internal hard disk.....	160
Overall settings for the AW16G.....	162

15 Using the AW16G with external devices 163

Using the AW16G with a "workstation synth"	163
Synchronizing the AW16G with the workstation's sequencer	163
Recording/playing AW16G mix operations on the workstation's sequencer.....	164
Switching AW16G scenes from the workstation's sequencer	165
Remotely controlling a tone generator module.....	166
Using external effects.....	167
Connecting an MD recorder	169
Mixing down to an MD recorder.....	169
Recording audio data from an MD recorder	170

Appendix 171

Input library list	171
Mastering library list	172
EQ library list	173
Dynamics Parameters	174
Dynamics library list.....	177
Effects library list.....	178
Effects Parameters.....	180
Sample library list	192
Troubleshooting	194
Display message list	198
About the CD-ROM included with the AW16G	200
Caution.....	200
Contents of the CD-ROM.....	200
Restoring the internal hard disk to the factory-set condition	200
Installing a remote file.....	201
MIDI data format.....	204
MIDI Implementation Chart.....	211
Specifications.....	212
Dimensions.....	214
Index.....	215
Block diagram.....	218

Chapter 1

Before you start

This chapter explains what you should know before you begin using the AW16G.

Introduction

■ Check the included items

The AW16G package contains the following items. If any are missing, please contact your dealer.

- The AW16G
- AC adaptor (PA-300)
- Owner's manual (this book)
- CD-ROM

■ Copyright

This product incorporates and bundles computer programs and contents in which Yamaha owns copyrights or with respect to which it has license to use other's copyrights. Such copyrighted materials include, without limitation, all computer software, styles files, MIDI files, WAVE data and sound recordings. Any unauthorized use of such programs and contents outside of personal use is not permitted under relevant laws. Any violation of copyright has legal consequences. DON'T MAKE, DISTRIBUTE OR USE ILLEGAL COPIES.

■ Trademarks

- Macintosh is a registered trademark of Apple Computer, Inc. USA in the United States and other countries.
- Windows is a registered trademark of Microsoft Corporation USA in the United States and other countries.
- Cubase VST is a trademark of Steinberg Media Technologies AG.
- Logic Audio is a trademark of Emagic Soft- and Hardware GmbH.
- Cakewalk is a registered trademark of Twelve Tone Systems, Inc.
- ProTools is a trademark or registered trademark of Avid Technology, Inc. and affiliated companies.
- Other company names and product names in this document are the trademarks or registered trademarks of their respective owners.

■ Yamaha website

<http://www.yamahasyth.com>

<http://www.yamaha.co.jp/product/proaudio/homeenglish/>

Yamaha manual library

<http://www2.yamaha.co.jp/manual/english/>

Remember to back up your data

■ Storing produced data

Produced data can be lost due to breakdown or mistaken operation. We recommend that you store all important data on CD-R or CD-RW discs or other external storage medium.



A CD-RW drive (the separately sold CDRW16G) is necessary in order to back up data.

■ Responsibility for loss of data, etc.

Yamaha will accept no responsibility for any damages (including consequential or incidental) incurred by the customer or any third party as a result of loss or impairment of the data stored on the CD-R media, regardless of whether such loss could have been or actually was foreseen by Yamaha.

Nor does Yamaha guarantee the media against any defect that may render it unusable.

About the CD-RW drive

A CD-RW drive is a device that lets you create or play audio CDs, backup and restore data from the internal hard disk, and read data from a CD-ROM. An optional CDRW16G can be installed in the AW16G. Please be aware that other CD-RW drives cannot be installed in the AW16G.



- *Even if a CD-RW drive is operating normally, it may fail a read or write operation approximately once in five hundred times.*
- *Yamaha will take no responsibility for any damages, direct or consequential, that may result from the use of the above CD-RW drive.*

■ Handling

- ① Do not drop the drive or subject it to strong physical shock.
- ② Never touch the objective lens.
- ③ Be careful that the objective lens does not become dusty or dirty.
- ④ If the objective lens becomes dusty, use a commercially available blower etc. to blow the dust off with clean air.
- ⑤ Before installing the drive, touch a grounded metal object so that the drive is not damaged by any static electricity that may be in your body.
- ⑥ Since the inside of the drive contains powerful magnetic circuitry, do not allow any magnetic material to come near the drive. (In particular, any metallic fragments, screws, or pins that enter the drive mechanism will cause operation to fail.)
- ⑦ Do not press on the upper cover.

Installing the CD-RW drive

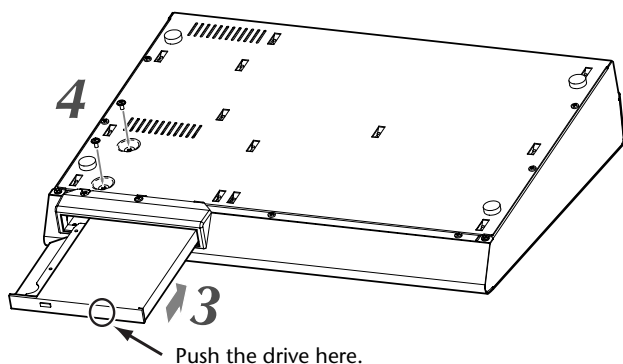

- 1** Turn off the power of the AW16G.
As described in "Turning the power off (shut down)" (→ p. 12), turn off the power of the AW16G. For safety's sake, also unplug the AC adaptor and the AW16G from the electrical outlet.
- 2** Turn the AW16G over on its face.
Be careful not to drop the AW16G on the floor, or damage the components of the top panel. Spread out a soft cloth on a level surface, and stack magazines etc. to support each of the four corners of the upside-down AW16G.

- 3** Insert the CD-RW drive into the slot.
Insert the CD-RW drive into the slot by pressing slightly right of center on the back edge of the drive. The slot cover swings open. When the CD-RW drive reaches the back of the slot, continue applying pressure until you feel the connector click into place. You will need to apply about as much pressure as when pressing an elevator button.
- 4** Fasten the CD-RW drive with screws.
Use the two included screws to fasten the CD-RW drive in place ("4" in the diagram at left).



Be sure to follow installation steps 1–4 exactly as directed. In particular, reading and writing may not occur correctly if the screws have not been tightened sufficiently.

Removing the CD-RW drive

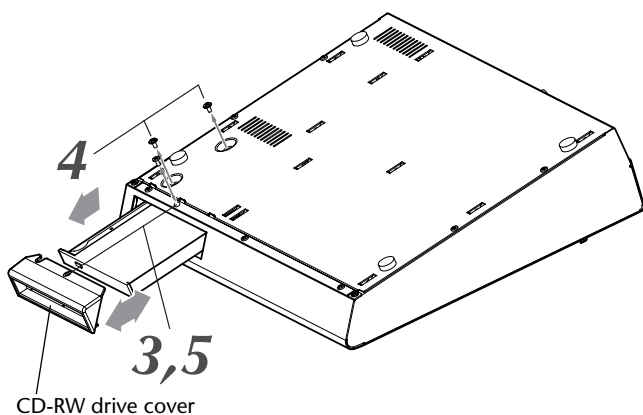

- 1** Turn off the power of the AW16G.
As described in "Turning the power off (shut down)" (→ p. 12), turn off the power of the AW16G. For safety's sake, also unplug the AC adaptor and the AW16G from the electrical outlet.
- 2** Turn the AW16G over on its face.
Be careful not to drop the AW16G on the floor, or damage the components of the top panel.

- 3** Remove the CD-RW drive cover.
Remove the black screw that holds the CD-RW drive cover in place ("3" in the diagram at left).



Do not lose the screw that you removed.

- 4** Pull the CD-RW drive out of the slot.
Remove the two screws that fasten the CD-RW drive in place, and pull out the CD-RW drive ("4" in the diagram at left).

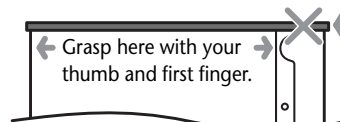

The cover may crack if you attempt to pull out the CD-RW drive by grasping the black cover.

< Bottom of the CD-RW drive >



- Do not lose the screws that you removed.
- Be careful not to cut yourself on any sharp metal edge.

- 5** Attach the CD-RW drive cover.
Using the black screw that you removed in step 3, attach the CD-RW drive cover.

Using the CD-RW drive

The CD-RW drive installed in the AW16G is shipped with a protective pad on the disc tray to prevent it from being damaged during transportation. Before you use the AW16G, you must remove this protective pad.

To insert a disc into the CD-RW drive, press the eject switch. The disc tray will open. Place the disc on the tray, and gently push the disc tray in.



The disc tray is ejected electrically. If the disc tray is not ejected when you press the eject switch, turn on the power of the AW16G and press the eject switch once again.

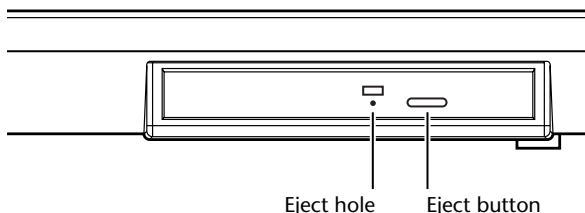

■ Removing a CD in an emergency

If you are unable to remove the disc by pressing the eject switch, insert a wire of less than 2 mm diameter (such as a straightened paper clip) into the eject hole, and push gently. However, pressing the eject switch will not eject the disc when the AW16G is in the following states, so do not use this method in such cases.

- When the AW16G's power is "STANDBY"
- When the disc is being accessed (data is being read, written, or erased)
- While in CD PLAY mode



This removal method is for use in emergencies such as when you cannot remove the disc due to a malfunction of the disc tray or a power failure. Do not use this method unnecessarily, since doing so will damage the CD-RW drive.

Connecting the AC adaptor

When connecting the included AC adaptor (PA-300), you must first connect it to the DC IN jack of the AW16G, and then to the AC wall outlet. After connecting the AC adaptor to the AW16G, wrap the cable around the hook as shown in the diagram. This will prevent the cable from being accidentally pulled out, causing the AW16G to unexpectedly lose power.

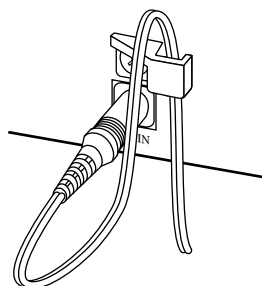

Turning the power on/off

You must use the following procedure to switch the power of the AW16G between ON and STANDBY. If you fail to follow this procedure, the internal hard disk or your external monitor system may be damaged.

■ Turning the power on

In a system that includes the AW16G, turn the power of each device on in the following order.

- ① External devices such as audio sources and effect processors connected to the input/output jacks of the AW16G
- ② The AW16G itself
- ③ The monitor system connected to the AW16G's output jacks



Before you turn on the power, make sure that the AC adaptor is firmly connected to the AW16G and to the AC outlet. If the power is disconnected while the AW16G is being used, the AW16G itself or the hard disk may be damaged.

When you turn on the power of the AW16G, an opening screen will appear, and then the following screen will appear.

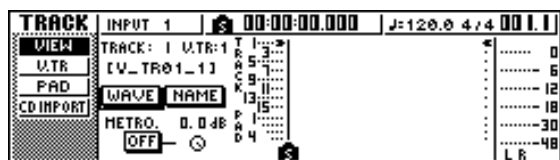

■ Turning the power off (shut down)

In a system that includes the AW16G, turn the power of each device off in the following order.

- ① The monitor system connected to the AW16G's output jacks
- ② The AW16G itself
- ③ External devices such as audio sources and effect processors connected to the input/output jacks of the AW16G

When turning off the power of the AW16G, you must perform the following "shut-down" procedure.

- 1 In the work navigate section located in the upper left of the top panel, press the [SONG] key several times to access the following SHUTDOWN page.

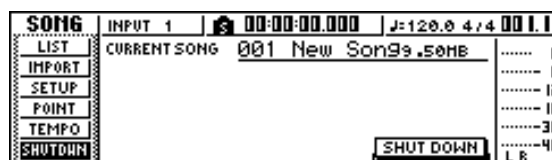

- 2 Press the [ENTER] key located in the middle right of the top panel.

A popup window will ask you whether you want to save the current song.



- 3 Using the CURSOR [◀]/[▶] keys located in the upper right of the top panel, move the cursor (the blinking area in the screen) to the YES button if you want to save the current song, or to the NO button if you do not want to save it. Then press the [ENTER] key.

- 4 When the "Now safe to turn off..." message appears, turn off the [POWER] switch located on the rear panel.



If you turn off the power of the AW16G without performing the above shutdown procedure, not only will any unsaved changes be lost, but you also risk damaging the data on the hard disk, and damaging or drastically shortening the lifespan of the hard disk itself and the internal CD-RW drive. Please use caution.



A small amount of electrical current is flowing even when the power is in STANDBY mode. If you will not be using the AW16G for an extended period of time, be sure to disconnect the AC adaptor from your AC outlet.

Chapter 2

Introducing the AW16G

This chapter describes the features of the AW16G, the name of each part and its function, and introduces terminology you need to know when using the AW16G.

Features of the AW16G

The AW16G is an audio workstation that combines a digital mixer, multi-effect processor, hard disk recorder, sampler, and CD-RW drive.

The following diagram shows the signal flow within the AW16G.

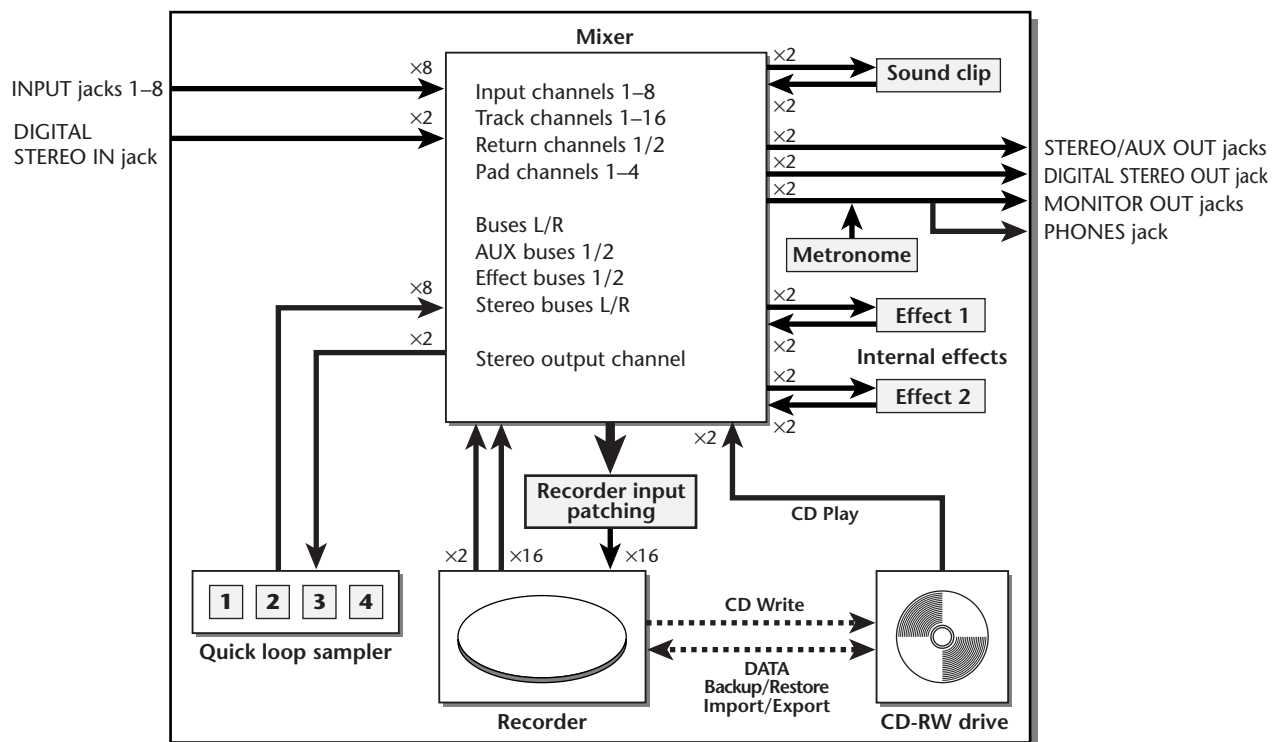

Now let's take a more detailed look at each section of the AW16G.

■ Mixer section

● Full-fledged mixer with 36 input channels

The AW16G contains a digital mixer with a total of 36 input channels, including analog inputs x 8, stereo digital input x 1, recorder tracks x 16, and effect returns x 2. Audio quality is guaranteed by 24-bit AD/DA and 32-bit internal processing. A Hi-Z input jack for directly connecting an electric guitar or bass is also provided.

● Totally redesigned operation

The AW16G is designed to be operated directly by the musician (guitarist, vocalist, drummer etc.). With a minimum number of steps, you can assign input signals to tracks, switch the monitor signal, and record with effects, EQ, and dynamics processing applied.

- **Four-band EQ and dynamics processors on each channel**

Four-band full-parametric EQ and dynamics processing is provided on virtually every channel. You can recall the desired preset from the library, and use the panel knobs and keys to quickly adjust the settings.

- **Two high-quality multi-effect units are built-in**

The two built-in effect units deliver a wide variety of effects including spatial-type effects such as reverb and delay, modulation type effects such as chorus and flanger, and guitar-type effects such as distortion and amp simulation. These effects can be used either via send/return, or inserted into a desired channel.

■ Recorder section

- **8-track simultaneous recording/16-track simultaneous playback**

You can record multiple tracks of instruments one by one, or set up multiple mics to record a drum set or a live performance by an entire band. A stereo track for direct mixdown of all 16 tracks is also provided, letting you manage the multi-track audio and the two-track mix as a single package of data.

For the multi-tracks as well as the stereo track, you can use eight virtual tracks for each track. When recording parts or during mixdown, you can switch virtual tracks to record multiple takes, and select the best take later.

- **Versatile editing functionality**

Audio data recorded on a track can be copied, moved, or edited using a variety of commands. You can make detailed edits, or even make radical changes to the structure of the song by using the same riff repeatedly or increasing the number of choruses.

“Time Compression” lets you compress or expand the time axis of the audio data in a range of 50%–200%. “Pitch Change” lets you modify the pitch in a range of one octave upward or downward. You can use the Undo function to reverse the results of as many as the last fifteen editing operations.

- **A variety of Locate methods, and auto punch-in/out**

Seven locate points (start/end, relative zero, A/B, in/out) and 99 markers can be assigned at any desired point in the song, for quick access via Locate operations. Auto punch-in/out and A-B repeat playback functions are also provided. The AW16G also has a metronome that follows the tempo map.

- **Sound Clip function**

The Sound Clip function lets you record and play back an input signal without affecting the recorder tracks. You can use this as a sketch for your ideas for a song or arrangement.

■ Quick Loop Sampler section

The AW16G has a built-in pad-type sampler. You can assign sixteen stereo waveforms to the four pads with sample banks. Sampling uses the same 16-bit 44.1 kHz high quality as recording. Audio tracks from the hard disk, external input from the mixer, or WAV files from a CD-ROM disc can also be loaded.

The timing at which each pad is pressed can be recorded on a dedicated pad track, and edited later. Drum phrases from the sample library can be assigned to pads, and you can then record pad operations to use this function as a simple rhythm machine.

The maximum polyphony is four stereo notes, and the maximum playback time is a total of 44 seconds of stereo for the entire Quick Loop Sampler.

■ CD-RW drive

A dedicated CD-RW drive (the CDRW16G, option) can be installed in the AW16G. If this is installed, you can produce an audio CD from the stereo tracks of the songs recorded on the hard disk. Markers assigned within a song can also be used as the track numbers of the CD. You can even use advanced techniques such as assigning more than one track number within a single song.

The CD-RW drive can also be used to backup/restore songs, to play back audio CDs, and to load WAV data from a CD-ROM.

AW16G terminology

Recorder section

■ Tracks

A location where data is recorded is called a “track.” The AW16G’s recorder section uses the following types of track.

● Audio tracks

The physical tracks used to record and play back audio data are called “audio tracks,” or simply “tracks.” The AW16G has sixteen audio tracks. You can record eight tracks simultaneously, and play back 16 tracks simultaneously.

● Stereo track

Independently from audio tracks 1–16, the AW16G has a “stereo track” that records and plays a stereo audio signal.

The stereo track is used mainly as a dedicated mix-down track for recording the final mix.

● Virtual tracks

Each audio track 1–16 and the stereo track consists of eight tracks. Each of these eight tracks is called a “virtual track.” For the audio tracks and the stereo track, only one virtual track can be recorded or played at any time. However, you can switch virtual tracks to continue recording other takes while preserving the previously-recorded content.

The diagram below shows the concept of virtual tracks. The horizontal rows indicate audio tracks 1–16, and the vertical columns correspond to virtual tracks 1–8. The shaded areas indicate the virtual track that is currently selected for recording or playback.

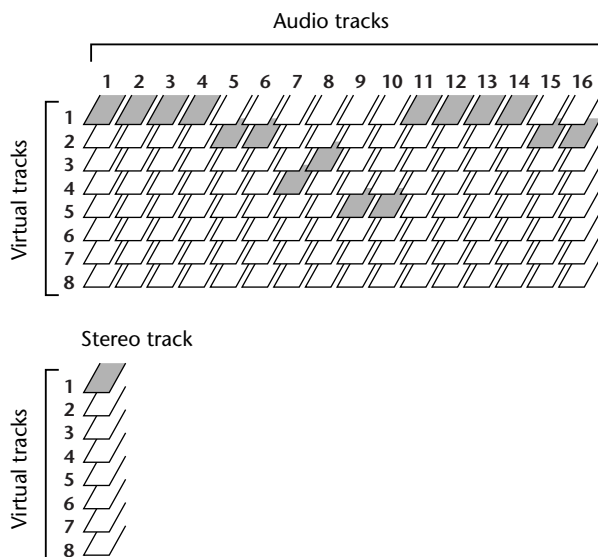

■ Paired tracks

For audio tracks 9/10–15/16, adjacent pairs of tracks are handled by the mixer as a single unit. These pairs of tracks are referred to as “paired tracks.” A paired track can be used to record a stereo source, or a dual-guitar performance, etc.

■ Locate points/markers

Locations within a song that you specified in order to execute a function such as auto punch-in/out or A-B repeat playback are called “locate points.” Locate points include the in/out points and the A/B points, and you can use the keys of the Locate section to move instantly to these points.

Independently of the locate points, you can assign “markers” at desired locations within a song so that you will be able to find these locations quickly. The AW16G lets you set up to ninety-nine markers (1–99). By using the keys of the Locate section you can move instantly to the previous or next marker.

Mixer section

■ Channels

A signal route that processes a single signal within the mixer and sends it to various sections is called a “channel.” The mixer section of the AW16G lets you use the following channels.

● Input channels 1–8

These apply EQ and dynamics processing to the signals that are input from MIC/LINE INPUT jacks 1–8, and send them to the recorder tracks or to the STEREO OUT jacks.

● Track channels 1–16

These channels apply EQ and dynamics processing to the audio playback signals from audio tracks 1–16 of the recorder, and send the signals to the stereo track and the STEREO OUT jacks. You can also perform “bounce recording” by sending these channels to different tracks.

● Return channels 1/2

These channels send the return signals from the internal effects to the stereo track and the STEREO OUT jacks.

● Pad channels 1–4

These channels apply EQ and dynamics processing to the playback of Quick Loop Sampler pads 1–4, and send the signals to the stereo track and the STEREO OUT jacks.

● Stereo output channel

This applies EQ and dynamics processing to the signal of the stereo bus (which combines the signals of the various channels), and sends it to the stereo track or to the STEREO OUT jacks. The same signal is also output from the MONITOR OUT jacks and from the PHONES jack.

■ Paired channels

For track channels 9/10–15/16, pad channels 1–4, and return channels 1/2, the parameters (except for pan and phase) are always linked for adjacent pairs of channels. These are called “paired channels.”

For input channels 1–8 and track channels 1–8, you can also switch two adjacent odd-numbered/even-numbered channels to function as paired channels. The parameters (except for pan and phase) of paired channels will be linked, so that adjusting one parameter will cause the same parameter of the other channel to follow.

■ Buses

A signal route that mixes the signals from multiple channels and send them to an output jack or recorder track input is called a “bus.”

Unlike channels, which handle only a single signal, a bus can combine multiple signals into one or two, and send them to a destination. (The term “bus” comes from the vehicle that carries numerous people simultaneously.)

The AW16G’s mixer section lets you use the following buses.

● Stereo bus

This mixes the input signals to stereo, and sends them via the stereo output channel to the stereo track of the recorder or to the STEREO OUT jacks.

● AUX buses 1/2

These combine the signals from the various track, input, return, and pad channels, and output them via the STEREO/AUX OUT jacks to an external device.

Use these when you will use an external effect processor, or to create a mix differing from the stereo channel for musicians to monitor.

● Effect buses 1/2

These combine the signals from the track, input, return, and pad channels, and input them to built-in effects 1 and 2. (However, it is not possible for the return channel 1/2 signals to be returned to the input of the same effect.)

● Buses L/R

These combine the signals of track, input channels, and send them to recorder track inputs.

Quick Loop Sampler section

■ Sample banks and samples

In the Quick Loop Sampler section you can assign stereo waveforms to the four pads, and strike the pads to play them back. These stereo waveforms are called “samples.”

The memories to which the samples are assigned are called “sample banks,” and each pad provides four sample banks (A–D).

■ Pad track

The AW16G can realtime-record and play back your strikes on the pads. The memory that records these pad operations is called the “pad track.” Unlike the tracks that record audio, the pad track simply records the timing at which you “pressed a pad” or “released a pad.”

Overall

■ Songs

The smallest unit by which the AW16G manages a composition is called a “song.” When you save a song on the hard disk, all data necessary for reproducing that song will be saved; i.e., not just the audio data, but also mixer settings and the samples used by the quick loop sampler. You can return to the original state at any time by loading the saved song.

■ Scenes and scene memories

A “scene” is a stored set of settings for the mixer section and effects. The area of memory that holds the scenes is called “scene memory,” and 96 scenes can be stored for each song. Scene memories are saved on the hard disk as part of the song.

■ Libraries

A “library” is an area of memory that stores individual settings such as for EQ or dynamics. The AW16G has separate libraries for EQ, dynamics, effect, channel, input, and mastering settings. Each library is saved on the hard disk as part of the song.

■ Tempo map

The “tempo map” records changes in tempo and time signature that occur during the course of a song. The tempo map is saved on the hard disk as part of the song.

■ System data

Various global settings that apply to all songs are collectively referred to as “system data.” System data is stored on the hard disk independently of the individual songs.

Parts of the AW16G and what they do

This section explains the names and functions of the various items on the AW16G's top panel, rear panel, and front panel.

Top panel

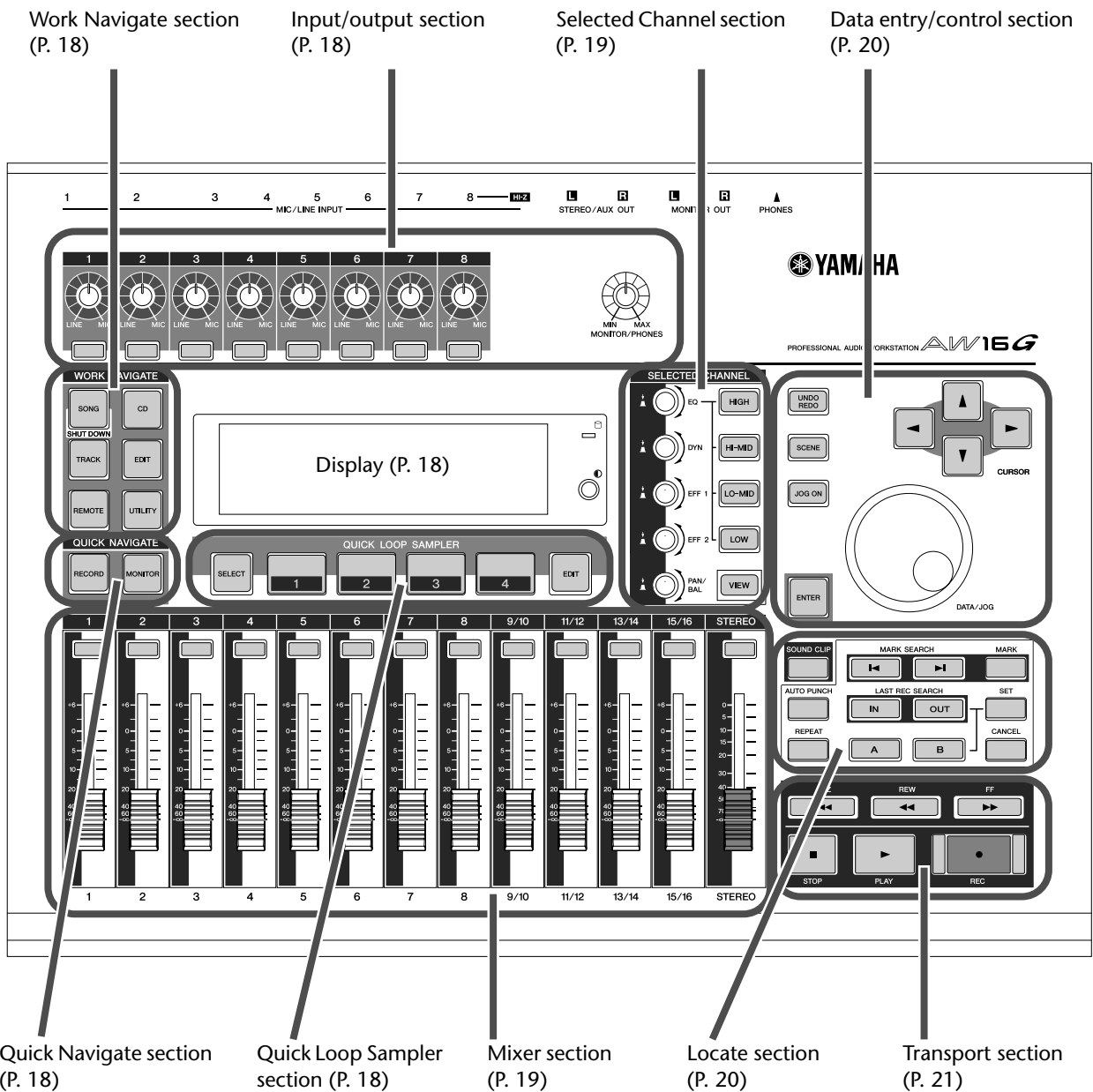

Input/output section

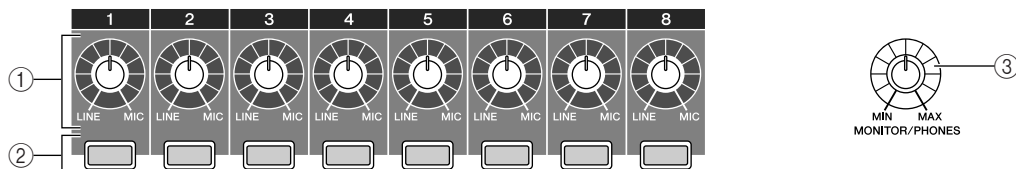

① **[GAIN] knobs 1-8**

These adjust the sensitivity of the signals that are input from the rear panel MIC/LINE INPUT jacks 1-8.

② **[INPUT SEL] keys 1-8**

These keys select the mixer input channel that you will operate.

③ **[MONITOR/PHONES] knob**

This knob adjusts the level of the signal that is output from the MONITOR OUT jacks and the PHONES jack.

Work Navigate section

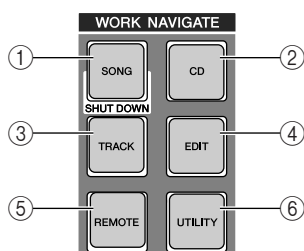

① **[SONG] key**

This key accesses the SONG screen, where you can save or load songs, and perform the shut-down procedure.

② **[CD] key**

This key accesses the CD screen, where you can write or play an audio CD, and backup or restore data.

③ **[TRACK] key**

This key accesses the TRACK screen, where you can check whether each track contains data, and switch the virtual tracks that will be used for recording and playback.

④ **[EDIT] key**

This key accesses the EDIT screen, where you can copy or erase tracks.

⑤ **[REMOTE] key**

This key accesses the REMOTE screen, where you can use the front panel faders and [TRACK SEL] keys to control an external MIDI device or sequencer software on your computer.

⑥ **[UTILITY] key**

This key accesses the UTILITY screen, where you can make MIDI, oscillator, and digital input settings, and format the hard disk.

② **[MONITOR] key**

This key accesses the MONITOR screen, where you can quickly select the signal to be monitored, or switch the stereo track playback on/off.

Display

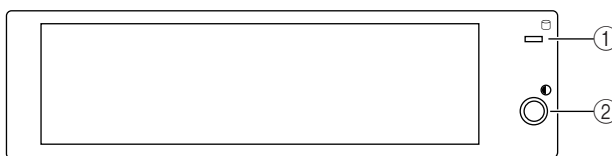

This is a backlit liquid crystal display that indicates the current operating status or the settings of the various parameters. The screens that are displayed will depend on the front panel keys and knobs that are operated.

① **Access indicator**

This indicator indicates the access status of the internal hard disk. When the hard disk is being read or written, this indicator will light.



Never turn off the power of the AW16G when the access indicator is lit. Doing so will not only damage the data on the internal hard disk, but may also damage the hard disk itself. When you want to turn off the power of the AW16G, you must perform the shutdown procedure (→ p. 12).

② **Contrast**

Adjusts the brightness of the display.

Quick Loop Sampler section

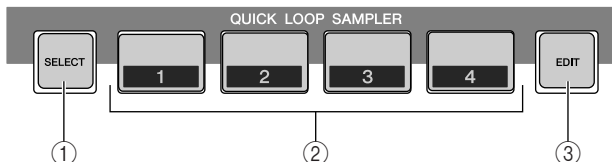

① **[PAD SEL] key**

Hold down this key and press a pad 1-4 to select a pad for operations.

② **Pads 1-4**

Each of these pads plays back the sample that has been assigned to it.

③ **[SAMPLE EDIT] key**

This key accesses the SAMPLE screen, where you can make settings and perform operations for the quick loop sampler.

Quick Navigate section

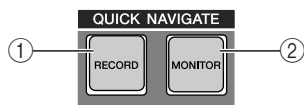

① **[RECORD] key**

This key accesses the RECORD screen, where you can quickly assign the signal to be recorded to the input of each track, and make settings for recording.

■ Mixer section

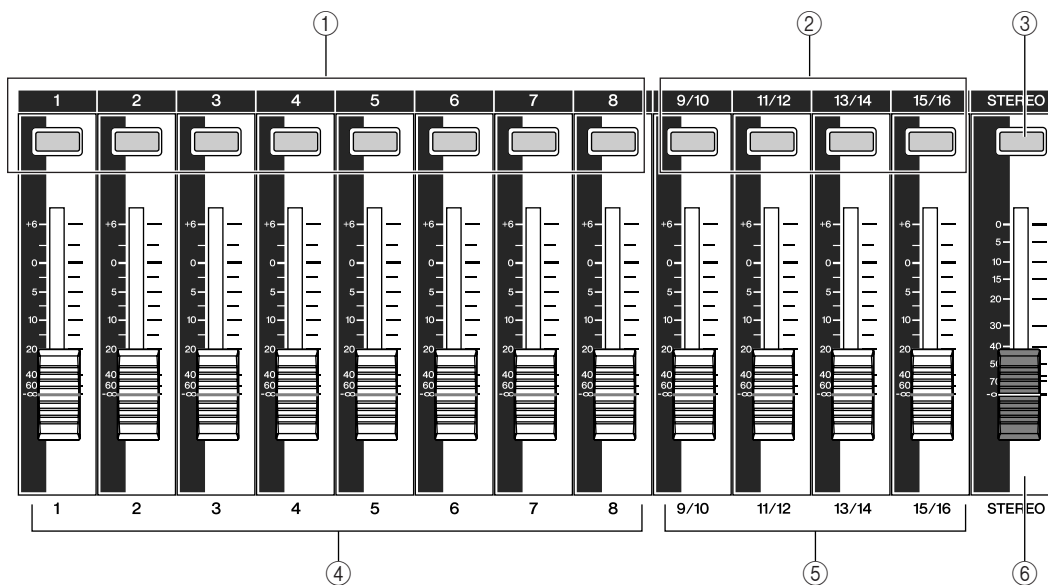

- ① **[TRACK SEL] keys 1–8**
- ② **[TRACK SEL] keys 9/10–15/16**
- ③ **[STEREO SEL] key**
Use these keys to select the mixer track channels or recorder tracks that you want to control.

- ④ **Faders 1–8**
- ⑤ **Faders 9/10–15/16**
Normally, these faders adjust the playback level of each recorder track. By changing the internal settings, you can also use these faders to control the input levels of input channels 1–8 and pads 1–4.
- ⑥ **[STEREO] fader**
This adjusts the output level of the stereo bus.

■ Selected Channel section

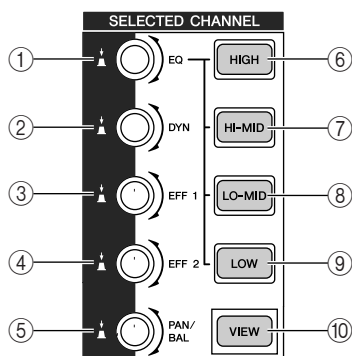

- ① **[EQ] knob**
Turning this knob will adjust the EQ (equalizer) gain for the currently selected channel. You can press this knob to access the EQ screen, where you can adjust all of the EQ settings.
- ② **[DYN] knob**
Turning this knob will adjust the dynamics depth for the currently selected channel. You can press this knob to access the DYN screen, where you can adjust all of the dynamics settings.

- ③ **[EFF 1] knob**
- ④ **[EFF 2] knob**
Turning these knobs will adjust the amount of signal that is sent from the currently selected channel to the internal effects 1 and 2 (i.e., effect send levels 1 and 2). You can press these knobs to access the EFF1 or EFF2 screens, where you can adjust the parameters of the internal effects.
- ⑤ **[PAN/BAL] knob**
Turning this knob will adjust the pan of the currently selected channel (or the balance of the stereo output channel). You can press this knob to access the PAN screen, where you can adjust pan for multiple channels.
- ⑥ **[HIGH] key**
- ⑦ **[HI-MID] key**
- ⑧ **[LO-MID] key**
- ⑨ **[LOW] key**
These keys select one of the four EQ bands (HIGH, HI-MID, LO-MID, LOW) to be adjusted.
- ⑩ **[VIEW] key**
This key accesses the VIEW screen, where you can check the level of each channel, or perform on-screen adjustments to the faders and other mix parameters of each channel.

■ Data entry/control section

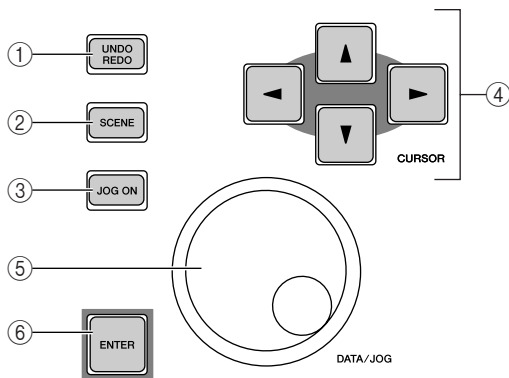

① [UNDO/REDO] key

This key cancels the results of a recording or track editing operation (Undo), or re-executes a cancelled operation (Redo).



- This key will light if Undo can be performed.
- If you press and hold this key, the UNDO LIST screen will appear. Here you can turn the [DATA/JOG] dial to revert as many as the last fifteen operations (→ p. 61).

② [SCENE] key

This key accesses the SCENE screen, where you can save or recall scene memories.

③ [JOG ON] key

This key is an on/off switch for the Nudge function (→ p. 71) which uses the [DATA/JOG] dial (⑤). When this function is on, the key will light.

④ [CURSOR] keys ([▲]/[▼]/[◀]/[▶] keys)

These keys move the cursor in the screen (the blinking frame) to select a specific item.

⑤ [DATA/JOG] dial

Use this dial to change the value of a parameter. If the [JOG ON] key (③) is on, this dial operates the Nudge function.

⑥ [ENTER] key

Use this key to operate a button displayed in the screen, or to execute a specific function.

■ Locate section

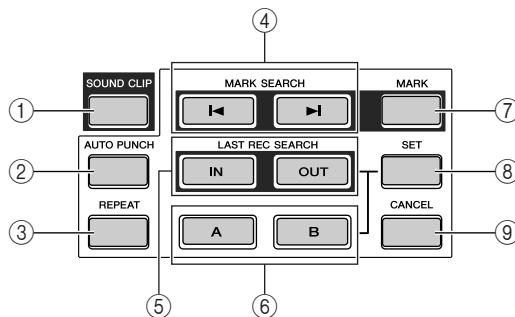

① [SOUND CLIP] key

This key accesses the CLIP screen, where you can record or play sound clips.

② [AUTO PUNCH] key

This key switches the audio punch-in/out function on/off, letting you automate recording.

③ [REPEAT] key

This key switches the A-B repeat function on/off, letting you repeatedly play a specified region.

④ MARK SEARCH [◀]/[▶] keys

These keys search for markers placed within the song.

⑤ [IN]/[OUT] keys

These keys specify the points at which auto punch-in/out recording will begin (the In point) and end (the Out point). These keys can also be used as locate keys to move directly to the In point or Out point.

⑥ [A]/[B] keys

These keys specify the points at which the Repeat function will begin (point A) and end (point B). These keys can also be used as locate keys to move directly to point A or point B.

⑦ [MARK] key

This key places a mark at the current location of the song.

⑧ [SET] key

Use this key in conjunction with the [IN]/[OUT] keys or the [A]/[B] keys to register the current location as a locator.

⑨ [CANCEL] key

Use this key in conjunction with the [IN]/[OUT] keys or the [A]/[B] keys to cancel a locator that you registered.

■ Transport section

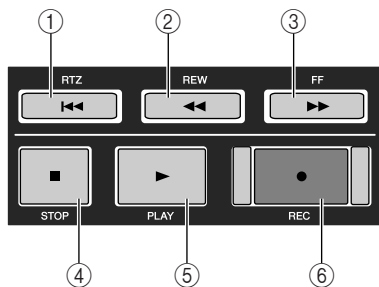

- ① **RTZ [⏮] key**
This key moves directly to the relative zero time location. Used in conjunction with the [SET] key, this registers the current location as the relative zero time.



Tip! Broadly speaking, the times displayed in the AW16G's counter can be either absolute time (ABS) or relative time (REL). The absolute time zero location is fixed, but the relative time zero location can be freely specified.

- ② **REW [⏮] key**
This key rewinds the current location. Each time you press this key, you will alternate between 8x speed and 16x speed.

- ③ **FF [⏭] key**
This key fast-forwards the current location. Each time you press this key, you will alternate between 8x speed and 16x speed.

- ④ **STOP [■] key**
This key stops playback, recording, fast-forward, or rewind.

- ⑤ **PLAY [▶] key**
If you press this key while the recorder is stopped, playback will begin.
If you press this key during fast-forward or rewind, normal-speed playback will begin.
If you press this key during recording, recording will stop and playback will resume ("punch-out").

- ⑥ **REC [●] key**
If you hold down this key and press the PLAY [▶] key while the recorder is stopped, recording will begin.
If you hold down this key and press the PLAY [▶] key during playback, you will switch from playback to recording ("punch-in").

Rear panel

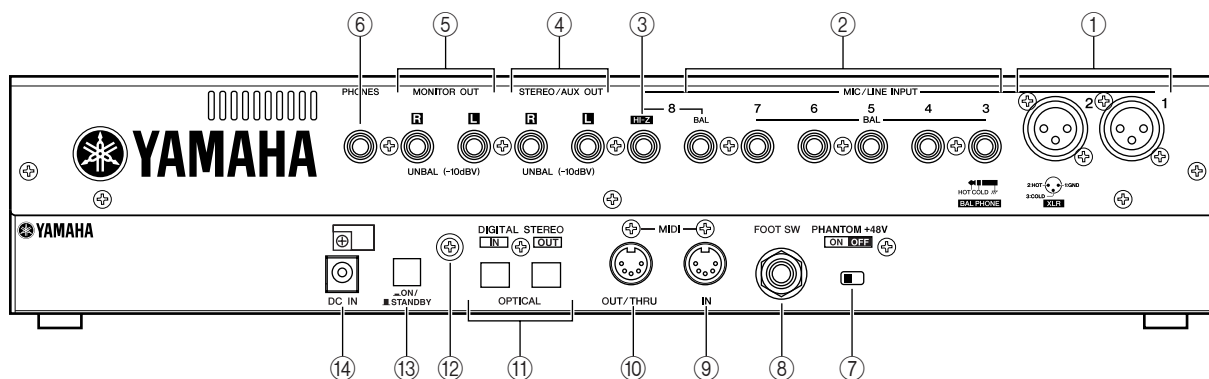

- ① **MIC/LINE INPUT (XLR) jacks 1/2**
These are XLR-3-31 type balanced input jacks. The nominal input level is -46 to +4 dB. Mics, direct boxes, or line level devices with balanced output jacks can be connected here. The pin configuration is shown below.

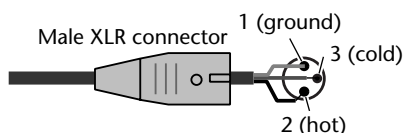

- ② **MIC/LINE INPUT (TRS phone) jacks 3-8**
These are TRS phone type 1/4" input jacks (balanced). The nominal input level is -46 to +4 dB. Devices such as synthesizers or rhythm machines with unbalanced outputs can also be connected here. The pin configuration is shown below.

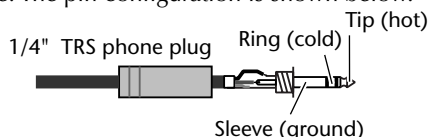

- ③ **MIC/LINE INPUT jack 8 (Hi-Z)**
This is a high impedance 1/4" phone input jack (unbalanced). The nominal input level is -46 to +4 dB. An instrument with high output impedance such as an electric guitar or bass with passive-type pickups can be connected here.

- ④ **STEREO/AUX OUT jacks**
These are 1/4" phone output jacks (unbalanced) that output the signals of the stereo bus or AUX bus 1/2.

- ⑤ **MONITOR OUT jacks**
These are 1/4" phone output jacks (unbalanced) for connection to your monitor setup, such as a stereo system or powered speakers.

- ⑥ **PHONES jack**
This is a 1/4" TRS phone output jack for connecting your headphones for monitoring.

⑦ **PHANTOM +48V switch**

This switch supplies phantom power to MIC/LINE (XLR) jacks 1/2.

Turn this switch on if you connect condenser mics requiring external +48V power to MIC/LINE INPUT (XLR) jacks 1/2.



- **You must turn this switch off if a device not requiring an external power supply is connected to the INPUT (XLR) 1/2 jacks.**
- **If phantom power is turned on, power will be supplied to both the INPUT (XLR) 1/2 jacks.**

⑧ **FOOT SW jack**

A separately sold foot switch (Yamaha FC5) can be connected here to control transport operations such as start/stop, or to perform punch-in/out.



The appropriate operation may not occur if you use a foot switch other than the Yamaha FC5 (or equivalent).

⑨ **MIDI IN connector**

⑩ **MIDI OUT/THRU connector**

These connectors allow MIDI messages to be exchanged with external devices.

MIDI IN receives MIDI messages.

MIDI OUT/THRU can be internally switched to function either as a MIDI OUT jack (which transmits MIDI messages generated within the AW16G) or MIDI THRU jack (which re-transmits messages that are received at the MIDI IN jack).

⑪ **DIGITAL STEREO IN/OUT jacks**

These are optical jacks that allow digital audio signals to be exchanged with external devices. They support the IEC958 consumer format.

⑫ **Grounding terminal**

This is a terminal for electrically grounding the AW16G. To prevent electrical shock, you must connect this terminal to an electrical ground before you plug the AC adaptor into an AC outlet. Grounding will also help prevent hum and noise.

⑬ **POWER switch**

This switches the power between ON and STANDBY.



When switching the power of the AW16G between ON and STANDBY, you must follow the "Turning the power on/off" (→ p. 12) procedures described.

⑭ **DC IN connector**

Connect the included AC adaptor (PA-300) to this connector.



Use only the included AC adaptor (PA-300) for this unit. Using other types may be a fire and electrical shock hazard.

Front panel

■ CD-RW drive

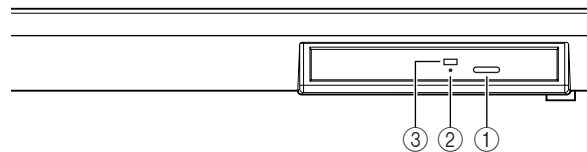

① **Eject button**

This switch ejects the disc tray.

② **Eject hole**

This hole allows you to open the disc tray manually.

③ **Access indicator**

This indicator will light while the CD inserted in the drive is being accessed.

Basic operation on the AW16G

This section explains basic operations on the AW16G.

Viewing the display

The display of the AW16G shows the following information.

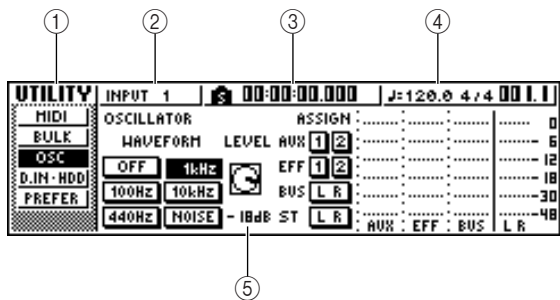

- ① **Screen name**
This is the name of the currently selected screen.
- ② **Selected channel**
This indicates the mixer channel that is selected for operations. The display has the following significance.

TRACK 1-8	Track channels 1-8
TRACK 9/10-15/16	Track channels 9/10-15/16
INPUT 1-8	Input channels 1-8
STEREO	Stereo output channel
PAD 1-4	Pad channels 1-4

Operating the knobs or keys of the Selected Channel section will edit the parameters of the channel that is selected here.
- ③ **Counter (left side)**
This indicates the current location within the song. When the AW16G is in the default state, this counter will indicate the absolute time (the time from where you began recording the song) in units of hours/minutes/seconds/milliseconds. At the left of this value is displayed the locate point or marker that was passed most recently.
- ④ **Counter (right side)**
This indicates the current location within the song in units of measures/beats. The measures/beats are calculated according to the tempo and time signature specified in the tempo map for the song. The current tempo and time signature are displayed at the left of this value.
- ⑤ **Main screen**
The information displayed in this area will depend on the key that was last pressed. The following types of object are displayed in the main screen.

● **Cursor**

The blinking frame within the display is called the "cursor." When an object in the screen is enclosed by the cursor, that object is selected for operations.



● **Buttons**

Buttons in the display are used to switch a parameter on/off, to select one of multiple choices, or to execute a specific function. A button that is currently on will be displayed in black with white text. A button that is currently off will be displayed in white with black text.



● **Knob/fader/parameter display area**

The knob/fader/parameter display area within the display is used to edit the value of the corresponding parameter.

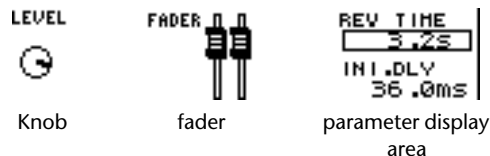

● **Page display area**

Most screens are divided by function into two or more "pages." The page display area lists the pages that can be selected within that screen. The name of the currently selected page is highlighted.



Accessing a screen/page/channel

When you want to edit an internal setting of the AW16G, or to edit a parameter that cannot be operated by a fader or knob shown in the display, you will need to access the desired screen and page.

1 Press the key or knob for the desired screen.

The keys and knobs of various sections listed below have their own screens, and the corresponding screen will be displayed when you press a key or knob.

- All keys in the Work Navigate section
- All keys in the Quick Navigate section
- The [VIEW] key of the Selected Channel section
- All knobs of the Selected Channel section
- The [SAMPLE EDIT] key of the Quick Loop Sampler section



Tip! When you switch screens, the page that was last used in that screen will be displayed.

2 To switch pages within a screen, you can either repeatedly press the same key as in step 1, or hold down the same key as in step 1 and use the CURSOR [▲]/[▼] keys.

If there are more pages than can be shown in one screen, an arrow like the following will appear in the page display area. This arrow means that one or more additional hidden pages exist in that direction.



To access a hidden page, hold down the same key as in step 1, and press the [CURSOR] key of the same direction as the arrow.

In pages that display a list of parameters for multiple channels, the screen may be divided into a page for the input channels/pad channels and a page for the track channels, since not all of the parameters can be shown in a single screen. In this case, use the [INPUT SEL] keys, pads 1–4, or [TRACK SEL] keys to select the channels that you want to view.

Switching a button on/off

Here's how to switch a button in the screen on/off.

1 Use the [CURSOR] keys to move the cursor to the desired button in the screen.



2 Press the [ENTER] key. The button will be switched on/off.

If you move the cursor to a button that executes a specific function and then press the [ENTER] key, that function will be executed.

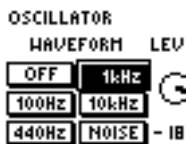

Editing a value in the display

Here's how to edit the value of a fader, knob, or parameter shown in the display.

1 Use the [CURSOR] keys to move the cursor to the desired fader, knob, or parameter value.

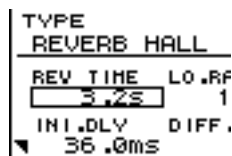

2 Turn the [DATA/JOG] dial to edit the value.

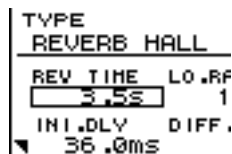

Inputting text

When you create a new song or save a scene memory or library setting, a popup window will appear, allowing you to assign a name for the song or setting.

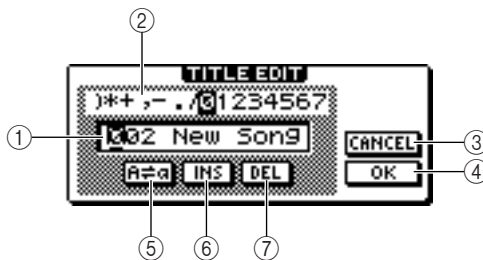

This popup window contains the following items and functions.

- ① Text input box**
This box lets you input characters, numerals, and symbols. When you save the data for the first time, the box will contain a default name.
You can input a scene/library name or song name of up to twelve characters.
- ② Text palette**
This displays the characters, numerals, and symbols that can be input in the text input box.
- ③ CANCEL button**
If you move the cursor to this button and press the [ENTER] key, you will return to the previous screen without changing the name.
- ④ OK button**
If you move the cursor to this button and press the [ENTER] key, the scene/library will be saved or the new song will be created.
- ⑤ A=a button**
If you move the cursor to this button and press the [ENTER] key, the character that is currently selected in the text input box will be switched between uppercase and lowercase.
- ⑥ INS button**
When you move the cursor to this button and press the [ENTER] key, a space will be inserted at the location of the currently selected character (underlined), and subsequent characters will move one character backward.
- ⑦ DEL button**
When you move the cursor to this button and press the [ENTER] key, the currently selected character (underlined) will be deleted, and subsequent characters will move one character forward.
To assign a new name, use the [CURSOR] keys to move the cursor in the text input box to the character that you want to change, and turn the [DATA/JOG] dial to select a character.
When you have finished inputting the name, move the cursor to the OK button and press the [ENTER] key to apply the new name.

Using the Selected Channel section

You can use the knobs and keys of the Selected Channel section to directly operate the mix parameters (EQ, dynamics, pan, etc.) of the currently selected channel.

1 Use the [TRACK SEL] keys, [INPUT SEL] keys, [STEREO SEL] keys, or pads 1–4 to select the channel that you want to operate.

When using the Selected Channel section, you must first select the channel that you want to operate. The currently selected channel is indicated in the upper left of the screen.

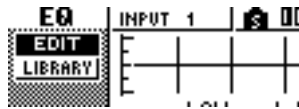

The channels correspond to each key or pad as follows.

- [TRACK SEL] keys 1–8Track channels 1–8
- [TRACK SEL] keys 9/10–15/16Track channels 9/10–15/16
- [INPUT SEL] keys 1–8Input channels 1–8
- [STEREO SEL] keyStereo output channel
- Pads 1–4Pad channels 1–4

2 According to the parameter you want to edit, turn the five knobs of the Selected Channel section.

The following items will change when you turn each knob.

Turn the [EQ] knob

This changes the amount of boost/cut for the selected EQ band. To select the EQ band, use the [HIGH], [HI-MID], [LO-MID], and [LOW] keys located at the right.

Turn the [DYN] knob

This changes the depth of dynamics processing.

Turn the [EFF 1] knob

This adjusts the level of the signal that is sent from that channel to internal effect 1. (If the stereo output channel is selected, this adjusts the return level from internal effect 1.)

Turn the [EFF 2] knob

This adjusts the level of the signal that is sent from that channel to internal effect 2. (If the stereo output channel is selected, this adjusts the return level from internal effect 2.)

Turn the [PAN/BAL] knob

This adjusts the pan of the signal that is sent from that channel to the stereo bus. (If the stereo output channel is selected, this adjusts the balance of the left and right channels.)

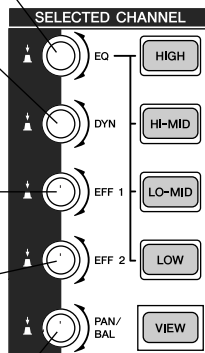

Note

- Simply turning the knobs of the Selected Channel section will not cause the screen to change.
- If you turn the [DYN] knob immediately after recalling a preset library that includes dynamics settings, multiple dynamics parameters will change simultaneously, affecting the way in which dynamics processing is applied. The depth of this change will depend on the library that is recalled.

3 If you want to access the screen for a parameter and edit it in greater detail, press one of the five knobs or the [VIEW] button.

Pressing each knob or button will access the following screens.

Press the [EQ] knob

The EQ screen will appear.

Press the [DYN] knob

The DYN screen will appear.

Press the [EFF 1] knob

The EFF 1 screen will appear.

Press the [EFF 2] knob

The EFF 2 screen will appear.

Press the [PAN/BAL] knob

The PAN screen will appear.

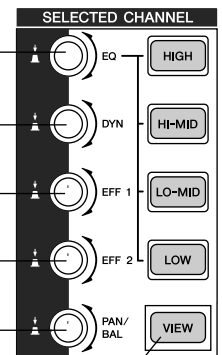

Press the [VIEW] key
The VIEW screen will appear.

EQ screen EDIT page

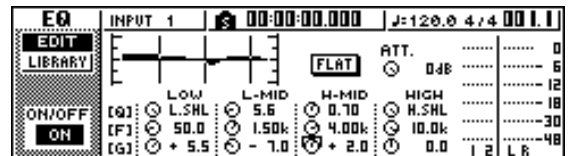

4 Move the cursor in the screen to the desired parameter, and use the [DATA/JO] dial or the [ENTER] key to operate the parameter.

Note

- If you change individual parameters in the DYN screen, the parameter that you operate last will be assigned to the [DYN] knob.
- If you want to return to the state in which turning the [DYN] knob will adjust multiple parameters simultaneously, you must once again recall the library containing the dynamics settings you recalled prior to editing in the DYN screen.

Chapter 3

Listening to the demo song

When the AW16G is shipped from the factory, its hard disk contains a demo song. This chapter explains how to play back the demo song while you operate the faders and keys of the front panel.

Connect external devices and turn on the power

The following diagram shows a typical example of connections to the AW16G. Connect your mics, instruments, and external devices as shown in this diagram.

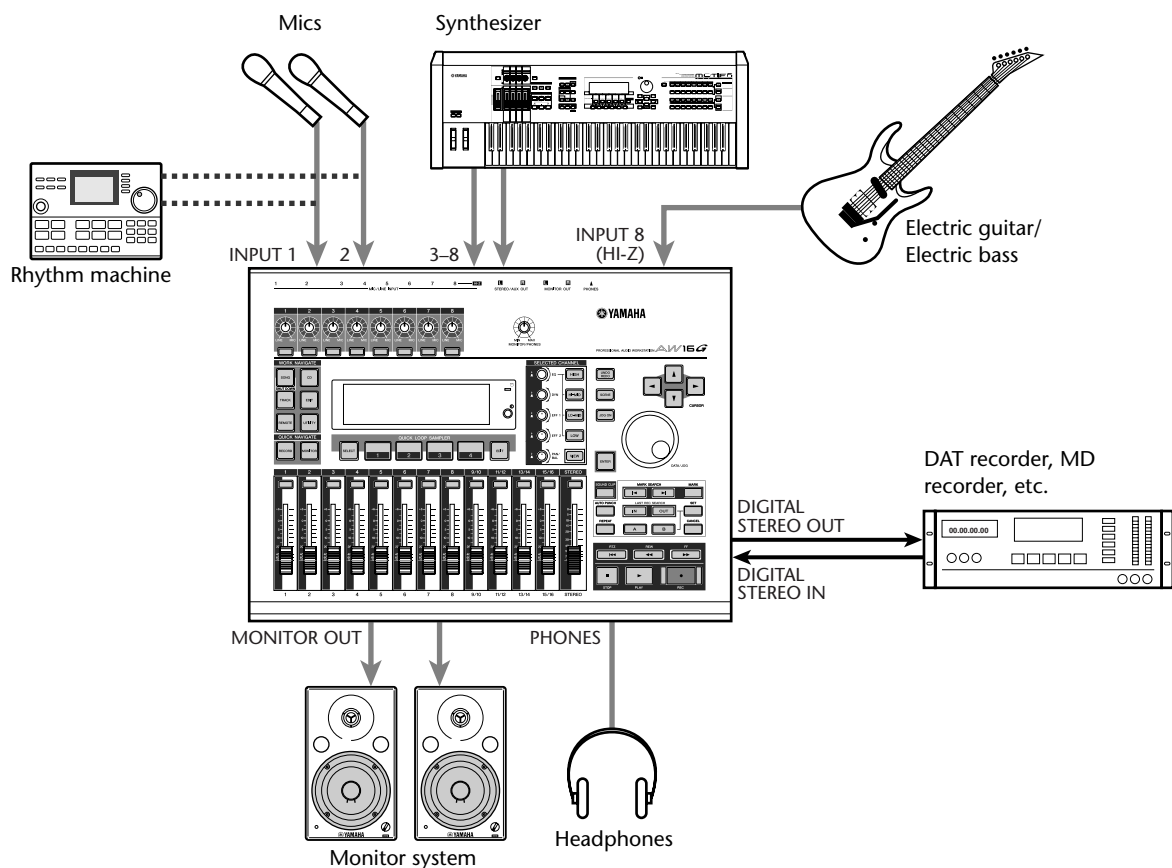

When you have finished making connections, turn on the power switch of each device in the following order.

- ① External devices such as audio sources or effect processors connected to the input/output jacks of the AW16G
- ② The AW16G itself
- ③ The monitor system connected to the output jacks of the AW16G

After the opening screen, the following screen will appear.

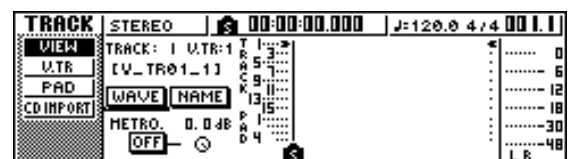

When you turn on the power of the AW16G, the last-used song will be loaded automatically. When you turn on the power of the AW16G with the factory settings, a blank song will be loaded, so you can start recording immediately.

Loading the demo song

Here's how to load the demo song from the hard disk.

- 1 In the work navigate section, press the [SONG] key. The SONG screen will appear, where you can save or load songs.

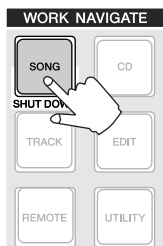

- 2 Either press the [SONG] key repeatedly or hold down the [SONG] key and use the CURSOR [▲]/[▼] keys to access the LIST page. In this page, you can select a song on the hard disk, and load or delete it.

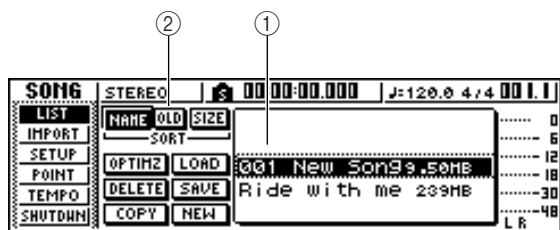

- 1 **List**
This area lists the songs that are saved on the hard disk. The line enclosed by the dotted frame in the center of the list indicates the song that is selected for operations. The highlighted line indicates the song that is currently loaded into the AW16G. (This is called the "current song.")
- 2 **SORT field**
These three buttons let you select how the songs in the list will be sorted. Choose the NAME button (sort alphabetically), OLD button (sort by save date), or SIZE button (sort by size).

- 3 Turn the [DATA/JOG] dial to select the song "Ride with me."



- 4 Move the cursor to the LOAD button in the screen, and press the [ENTER] key.



A popup window like the following will appear. This window asks you whether you want to save the current song.



- 5 Move the cursor to either YES (save the current song) or NO (don't save the current song), and press the [ENTER] key. The song data will be loaded, and "Ride with me" will become the current song.

Note

If you select NO, any changes that you made to the current song since you last saved it will be lost.

Playing the demo song

Here's how to play back the demo song you loaded, and adjust the monitor level.

- 1 Either press the [VIEW] key repeatedly or hold down the [VIEW] key and use the CURSOR [▲]/[▼] keys to access the VIEW screen METER page.

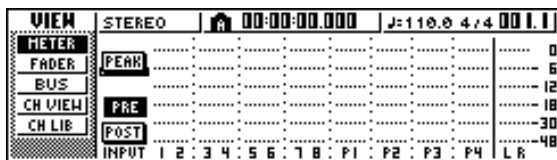
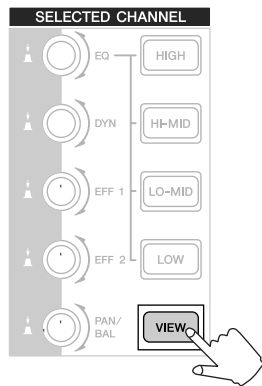

The VIEW screen METER page contains meters that show the input level of each channel and the output level of the stereo output channel. It is convenient to display this page when you want to check the level of each track.

Note

Make sure that the selected channel area at the upper left of the METER page indicates either TRACK 1–8 or TRACK 9/10–15/16. If neither of these are displayed, press either the [TRACK SEL] key 1–8 or 9/10–15/16.

- 2 Lower the AW16G's [STEREO] fader to the -infinity position. Also make sure that the AW16G's [MONITOR PHONES] knob and the volume of your monitor system are turned down.
- 3 Press the PLAY [▶] key.

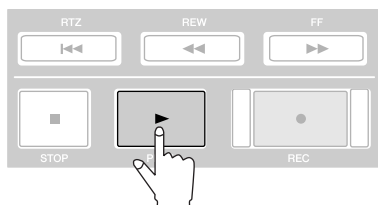

The demo song will begin playing, and the level of each track channel will be displayed in the METER page of the VIEW screen.

- 4 To adjust the monitor level appropriately, use the AW16G's [MONITOR PHONES] knob and the volume control of your monitor system.



The demo song uses the Scene function to switch the settings of the mixer. This means that playback will occur using the pre-specified balance — you do not need to operate the faders.



- 5 To stop the song, press the STOP [■] key.

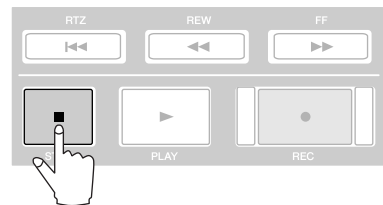

Mixing the demo song

When you play back a song, tracks 1–16 of the recorder are directly connected to track channels 1–8 and 9/10–15/16 of the mixer. The signals that pass through track channels 1–8 and 9/10–15/16 are sent to the stereo bus, routed through the stereo output channel, and sent from the STEREO/AUX OUT jacks or the MONITOR OUT jacks.

● **Signal flow during song playback**

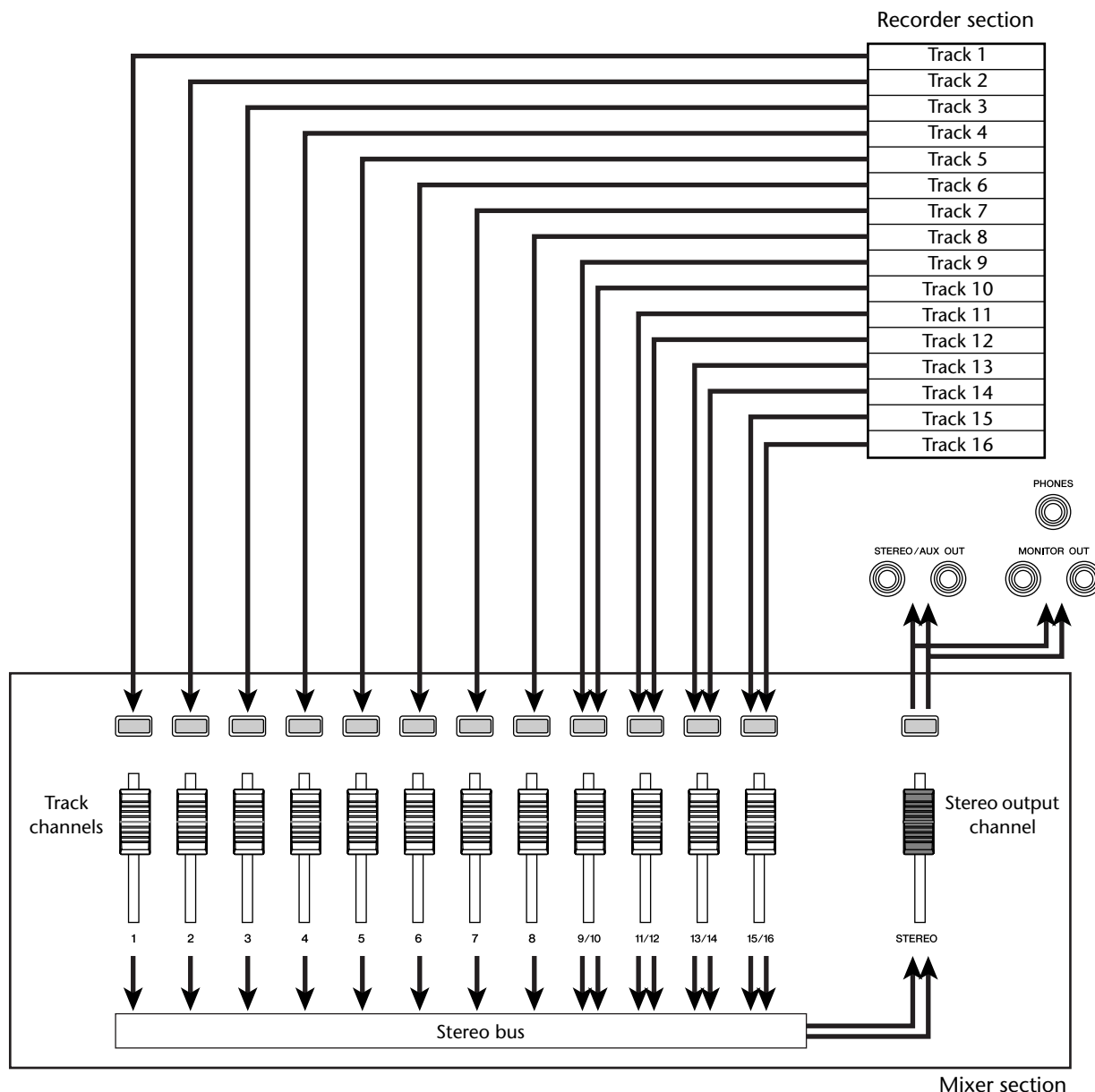

Track channels 1–8 and 9/10–15/16 are directly controlled by the faders and [TRACK SELECT] keys of the panel. Here's how you can adjust the mix level of each track channel and switch it on/off while the song plays back.

1 Press the RTZ [◀◀] key.

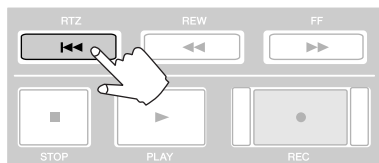

The demo song will be rewound to the beginning.

2 Press the PLAY [▶] button.

The demo song will begin playing.

3 While listening to the demo song, try operating faders 1–8 and 9/10–15/16.

Notice that the level of the corresponding track will change. Operating the [STEREO] fader will change the overall level of the song.

4 To mute the playback of a specific track, access the MONITOR screen ON/OFF page, either by repeatedly pressing the [MONITOR] key or by holding down the [MONITOR] key and using the CURSOR [▲]/[▼] keys.

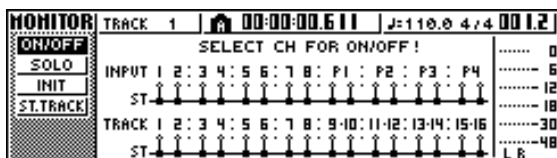
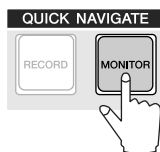

The MONITOR screen ON/OFF page lets you switch each channel on/off. A channel that is switched off in this page will not be sent to the stereo bus or AUX bus, and will be muted.

5 Press the [TRACK SEL] key(s) for the track channel(s) that you want to mute. (You may select more than one channel.)

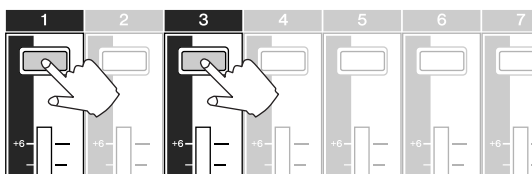

For example if you press [TRACK SEL] keys 1 and 3, the screen will change as follows, and track channels 1 and 3 will be muted. At this time, [TRACK SEL] keys 1 and 3 will go dark. The graphic in the display will also indicate this.

Note

The [TRACK SEL] key you press last will always light orange regardless of the mute status. This indicates that this channel is the “selected channel” (→ p. 25).

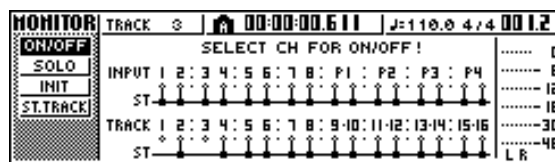

Note

In this page, pressing the [STEREO SEL] key will have no effect.

6 To cancel the muted state, press the same [TRACK SEL] key you pressed in step 5, to make the indicator light green.

7 If you want to monitor the playback of just a specific track, access the MONITOR screen SOLO page by either repeatedly pressing the [MONITOR] key or by holding down the [MONITOR] key and using the CURSOR [▲]/[▼] keys.

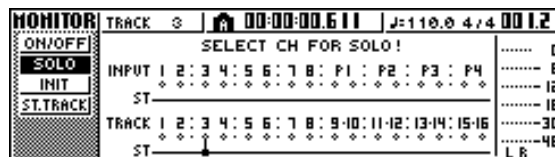

The SOLO page of the MONITOR screen lets you mute all other channels while listening to only a specific channel. (This is called the “solo” function.) When you solo a channel in this page, the signals of the remaining channels will be muted, and will no longer be sent to the stereo bus or AUX buses.

8 Press the [TRACK SEL] key of the track channel that you want to solo.

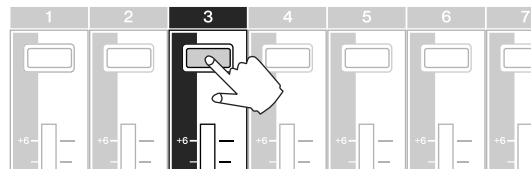

For example if you press [TRACK SEL] key 3, the screen will change as follows, and channels other than track channel 3 will be muted. At this time, [TRACK SEL] key 3 will light orange, and the other [TRACK SEL] keys and [INPUT SEL] keys will go dark.

Note

Only one channel can be soloed at a time.

9 To cancel soloing, press the currently selected [TRACK SEL] key (lit orange) once again.

Note

While playing the demo song, the level or the on/off status of a channel you adjusted manually may return to its previous setting. This is because the Scene function has switched the state of the mixer settings, and is not a malfunction (→ p. 142). You can use the Recall Safe function to temporarily prevent scenes from being recalled. (→ p. 80)

Chapter 4

Recording to a sound clip

The AW16G has a Sound Clip function that lets you record and play back independently of the recorder section. You can use a sound clip to quickly record and play back your performances on an audio source connected to the AW16G or on the pads. This is an ideal way to capture ideas for a song or arrangement, or to record a simple accompaniment for practicing a part.

This chapter explains how an instrument or mic connected to an input jack can be recorded as a sound clip.

Connecting your instrument or mic

First, the instrument or mic that you want to record must be connected to a MIC/LINE INPUT jack. The various types of jack are compatible with the following sources.

- **MIC/LINE INPUT (XLR) jacks 1/2**

These are XLR-type balanced input jacks. Use a male XLR ↔ female XLR cable to connect your mic, direct box, or a guitar/bass preamp that has a balanced output jack.

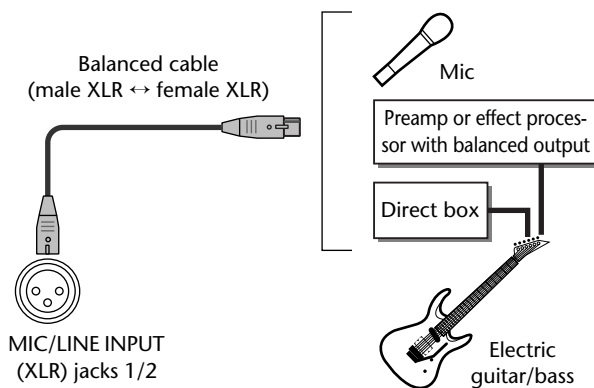

- **MIC/LINE INPUT (TRS phone) jacks 3–8**

These are TRS-type balanced input jacks. Use a 1/4" TRS phone ↔ female XLR cable to connect your mic, direct box, or a guitar/bass preamp that has a balanced output jack.

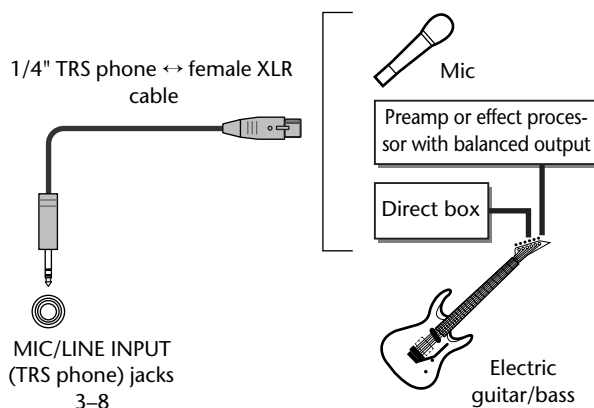

Alternatively, you can use a 1/4" phone ↔ 1/4" phone cable to connect an instrument with unbalanced output, such as a synthesizer or rhythm machine.

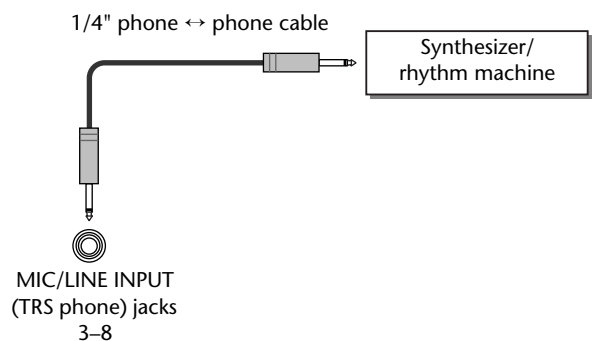

- **MIC/LINE INPUT jack 8 (Hi-Z)**

Use a 1/4" phone ↔ phone cable to directly connect an electric guitar/bass that has passive pickups.

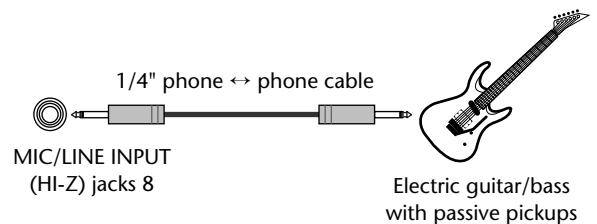

Adjusting the input level

The signals that are input from MIC/LINE INPUT jacks 1–8 are sent to input channels 1–8 respectively. Here's how to adjust the input level of the input channel, and make settings so that you can hear the sound from your monitor system via the stereo bus.

1 Lower the [STEREO] fader to the $-\infty$ position. Also turn down the [GAIN] knob for the MIC/LINE INPUT jack to which your instrument/mic is connected.

2 Press and hold the [INPUT SEL] key for the jack to which your instrument/mic is connected.

When you press and hold an [INPUT SEL] key, the INPUT SETTING popup window will appear, allowing you to make settings for the corresponding input channel. The following diagram is an example of the screen that will appear if you press and hold [INPUT SEL] key 1.

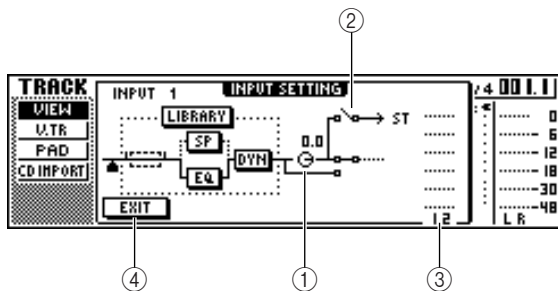

① INPUT LEVEL knob

Move the cursor to this knob and turn the [DATA/JOG] dial to adjust the level of the input channel. Normally you will leave this at the default setting of 0 dB. The current level is shown by the value (dB units) above the knob.

② Stereo bus assign switch

When you move the cursor to this knob and press the [ENTER] key, the signal that is sent from the corresponding input channel to the stereo bus will be switched on/off.

③ Level meter

This indicates the input level of the input channel. The  symbol in the window indicates the location at which the level is detected.

④ EXIT button

Move the cursor to this button and press the [ENTER] key to close the popup window and return to the previous screen.

3 While you watch the level meter in the popup window, produce sound on your instrument, and turn the [GAIN] knob to adjust the input level.

As you turn the [GAIN] knob toward the right, the level meter in the popup window will move more widely. (However, you will not yet hear anything from your monitor system.)

For the best audio quality, adjust the level as high as possible without allowing the meter to clip when the loudest volume occurs.

4 While you play your instrument, raise the [STEREO] fader to the 0 dB position.

The LR meters at the right of the screen will now move. As you turn the [MONITOR/PHONES] knob toward the right, you should begin to hear sound from your monitor system.

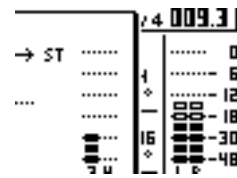

Note

If you still do not hear sound after raising the [STEREO] fader, check the INPUT SETTING popup window to make sure that the stereo bus assign switch is turned on, and that the INPUT LEVEL knob value has not been set below 0.0 dB.

5 To exit the INPUT SETTING popup window, move the cursor to the EXIT button and press the [ENTER] key.

You will return to the previous screen.

Tip!

The level settings described above are the basic settings for any type of recording --- not just for a sound clip. By using the [GAIN] knob to raise the level as far as possible without allowing distortion to occur, you can ensure that the input signal is converted into digital form with the highest possible quality before it is input to the mixer section. If the [GAIN] knob is not raised sufficiently, you may not be taking full advantage of the available dynamic range of the mixer section and recorder section. When the input LEVEL knob and [STEREO] fader are set to the 0 dB position, the input level will be output without change to the recorder and monitor.

Recording/playing a sound clip

Now that preparations are complete, let's record to a sound clip.

The post-fader signal of the stereo output channel can be recorded directly on a sound clip. For playback, the signal will be sent immediately before the stereo output channel fader. (EQ and dynamics cannot be applied to the playback of a sound clip.)

- **Signal flow when using a sound clip**

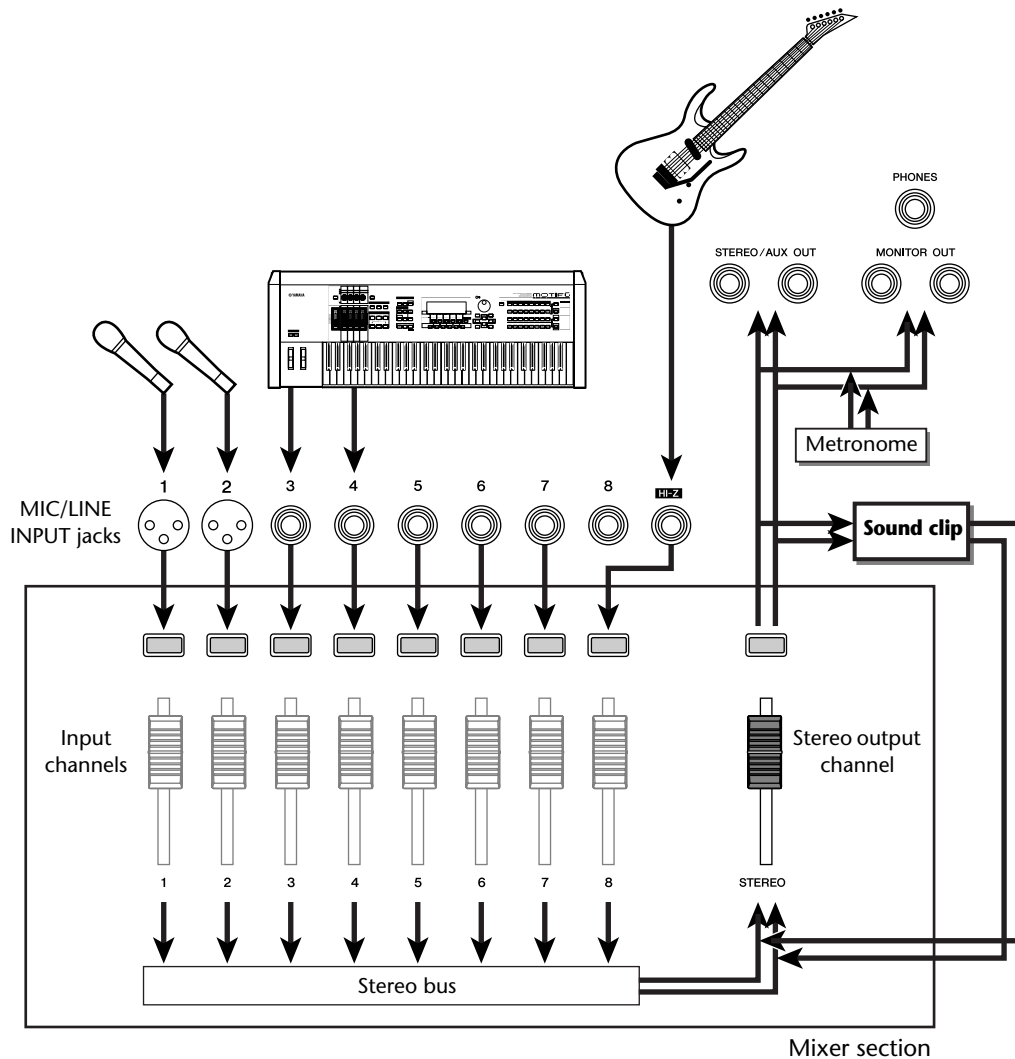

■ Recording a sound clip

- 1** In the Locate section, press the [SOUND CLIP] key.

The CLIP screen will appear, where you can record and play sound clips.

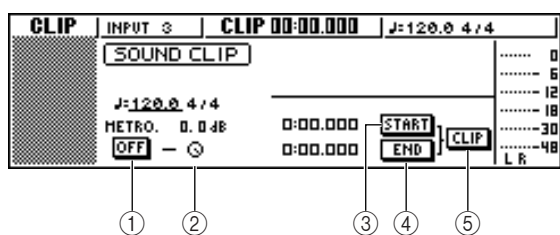

- ① **Metronome button**
Switches the metronome on/off.
- ② **Metronome knob**
Adjusts the volume level of the metronome. The value shown above the knob shows the current setting in dB units.
- ③ **START button**
Specifies the current location as the start point of the sound clip (the location at which playback will begin). The current location is shown in minutes/seconds/milliseconds at the left.
- ④ **END button**
Specifies the current location as the end point of the sound clip (the location at which playback will end). The current location is shown in minutes/seconds/milliseconds at the left.
- ⑤ **CLIP button**
When you turn this button on, the START button (③) and END button (④) settings will be enabled.

Note

Recording and playback in the Recorder section cannot be performed while the CLIP screen is displayed.

- 2** If you want to use the metronome, move the cursor to the metronome button and press the [ENTER] key.

The time signature and tempo used by the metronome are displayed above the metronome button.

- 3** To change the tempo of the metronome, move the cursor to the tempo value and turn the [DATA/JOG] dial.

Note

The time signature of the metronome is determined by the tempo map setting immediately prior to accessing the CLIP screen. Please be aware that the setting cannot be edited from this screen. (For details on tempo map settings → p. 142)

- 4** In the Transport section, hold down the REC [●] key and press the PLAY [▶] key.

The metronome will begin sounding, and the counter display will advance. The counter in the CLIP screen always starts from 0, and indicates the current time in minutes/seconds/milliseconds. This counter is separate from the counter of a conventional song.

- 5** Play your instrument in time with the metronome.

Tip!

- The metronome sound will not be recorded in the sound clip. If necessary, you can move the cursor to the metronome knob and turn the [DATA/JOG] dial to adjust the volume level of the metronome sound.
- In addition to an instrument connected to the MIC/LINE INPUT jacks, your performance on the quick loop sampler pads can also be recorded.
- The knobs/keys of the selected channel are active even while the CLIP screen is displayed. If necessary, you can record the signal processed by EQ and dynamics (→ p. 50).

- 6** To stop recording, press the STOP [■] key. The display will show S and E symbols to indicate the start point and end point.

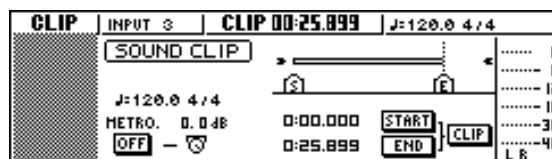

Tip!

- With the default settings of the AW16G, a maximum of 30 seconds can be recorded in a sound clip. If you continue recording for longer than 30 seconds, the last 30 seconds of your playing before you stopped recording will be recorded. (However, the counter display during recording will continue to advance.)
- In the UTILITY screen PREFER page, you can specify up to 180 seconds as the maximum length that can be recorded in a sound clip. You are free to make this setting before creating a new song, but this cannot be changed once the song has been created. (→ p. 162)

■ Playing a sound clip

1 To hear the content that you recorded in the sound clip, press the PLAY [▶] key.

The region from where you began recording to where you stopped recording will play repeatedly. To stop, press the STOP [■] key. If you record again, the previous data will be overwritten.

In the CLIP screen, the keys of the Transport section will have the following functions.

Key	Function
RTZ [◀◀] key	Returns to the location at which you began recording. If the CLIP button is on, this returns to the Start point.
REW [◀◀] key	Rewinds the current location toward the beginning. You will stop when you reach the location at which you began recording or the Start point.
FF [▶▶] key	Fast-forwards the current location. You will stop when you reach the location at which you stopped recording or the End point.
STOP [■] key	Stops playback, recording, rewind, or fast-forward.
PLAY [▶] key	Starts playback. Pressing this key during playback does nothing.
REC [●] key	If you hold down this key while stopped and press the PLAY [▶] key, recording will begin. Pressing this key during playback does nothing.



Tip! You will not hear the metronome and pads 1–4 while a sound clip is playing. However, you can still monitor the signals of input channels 1–8.

2 If you want to change the playback region of the sound clip, stop at the location that you want to specify as the Start point, move the cursor to the START button, and press the [ENTER] key.

The current location will be registered as the Start point.

3 In the same way, stop at the location that you want to specify as the End point, move the cursor to the END button, and press the [ENTER] key.

4 Stop playback, move the cursor to the CLIP button, and press the [ENTER] key.

The CLIP button will turn on, and the specified Start point and End point will be enabled.



Note The START button, END button, and CLIP button are disabled while the sound clip is playing.



Tip! The region of data between the specified Start point and End point can be copied to an audio track of the Recorder section by using the EDIT screen COPY command (→ p. 128).

5 To execute the CLIP screen, press the [SOUND CLIP] key.

A popup window will ask you for confirmation. Move the cursor to the OK button to exit the CLIP screen or to the CANCEL button to cancel, and press the [ENTER] key.

When you exit the CLIP screen, you will return to the TRACK screen VIEW page. However you can press the [SOUND CLIP] key at any time to play back the previously recorded content or record a new performance.



Note When you record a sound clip, the previous recording will be lost. Please be aware that the Undo function cannot be used to recover a deleted sound clip.



- A popup window will also ask you to confirm that you want to exit the CLIP screen if you press a key in the Work Navigate section or Quick Navigate section while playback is stopped in the CLIP screen.
- The recorded contents of the sound clip are stored for each song.

Chapter 5

Track recording

This chapter explains how to create a new song, and record the audio signal from an instrument or mic connected to the AW16G onto the first track of your song.

Creating a new song

In order to begin recording on the AW16G, you must first create a new song.



Tip! When you start up the AW16G for the first time, an empty song will be loaded automatically. If you use this automatically-loaded song, the procedure described here is not necessary.

- 1 In the Work Navigate section, either press the [SONG] key repeatedly or hold down the [SONG] key and use the CURSOR [▲]/[▼] keys to access the LIST page.



- 2 Move the cursor to the NEW button and press the [ENTER] key.
A popup window will ask you whether you want to save the current song.



- 3 Move the cursor to either YES (if you want to save the current song) or NO (if you do not want to save the current song), and press the [ENTER] key.

Next, a popup window will appear, allowing you to specify the items whose settings will be carried over from the current song.



You may choose one or more of the following items if desired.

- SCENE button** Scene memories
- LIBRARY button** EQ, dynamics, effects, and channel libraries
- TEMPO button** Tempo map

For example if you have saved effect settings in a library for the current song and would like to use these settings for the new song as well, you would turn on the LIBRARY button.

- 4 Use the buttons to choose the items that will be carried over from the current song. Then move the cursor to the OK button and press the [ENTER] key.

The TITLE EDIT popup window will appear, allowing you to assign a name to the song.



- 5 Assign a name to the song (for details on assigning a name → p. 24).
- 6 To create the new song, move the cursor to the OK button and press the [ENTER] key.
A new song will be created, and you will return to the SONG screen LIST page.



- If you move the cursor to the CANCEL button (instead of the OK button) and press the [ENTER] key, you will return to the SONG screen LIST page without creating a new song.
- You may also edit the song name later (→ p. 138).

Direct recording and Bus recording

Instruments/mics connected to the AW16G can be assigned to tracks in one of the following two ways.

■ Direct recording

With this method, input channels are assigned to tracks in a one-to-one correspondence. This method requires the same number of tracks as the number of input channels you use. However, this method has the advantage that you will be free to adjust the volume, pan (stereo position), and tone of each instrument after it has been recorded.

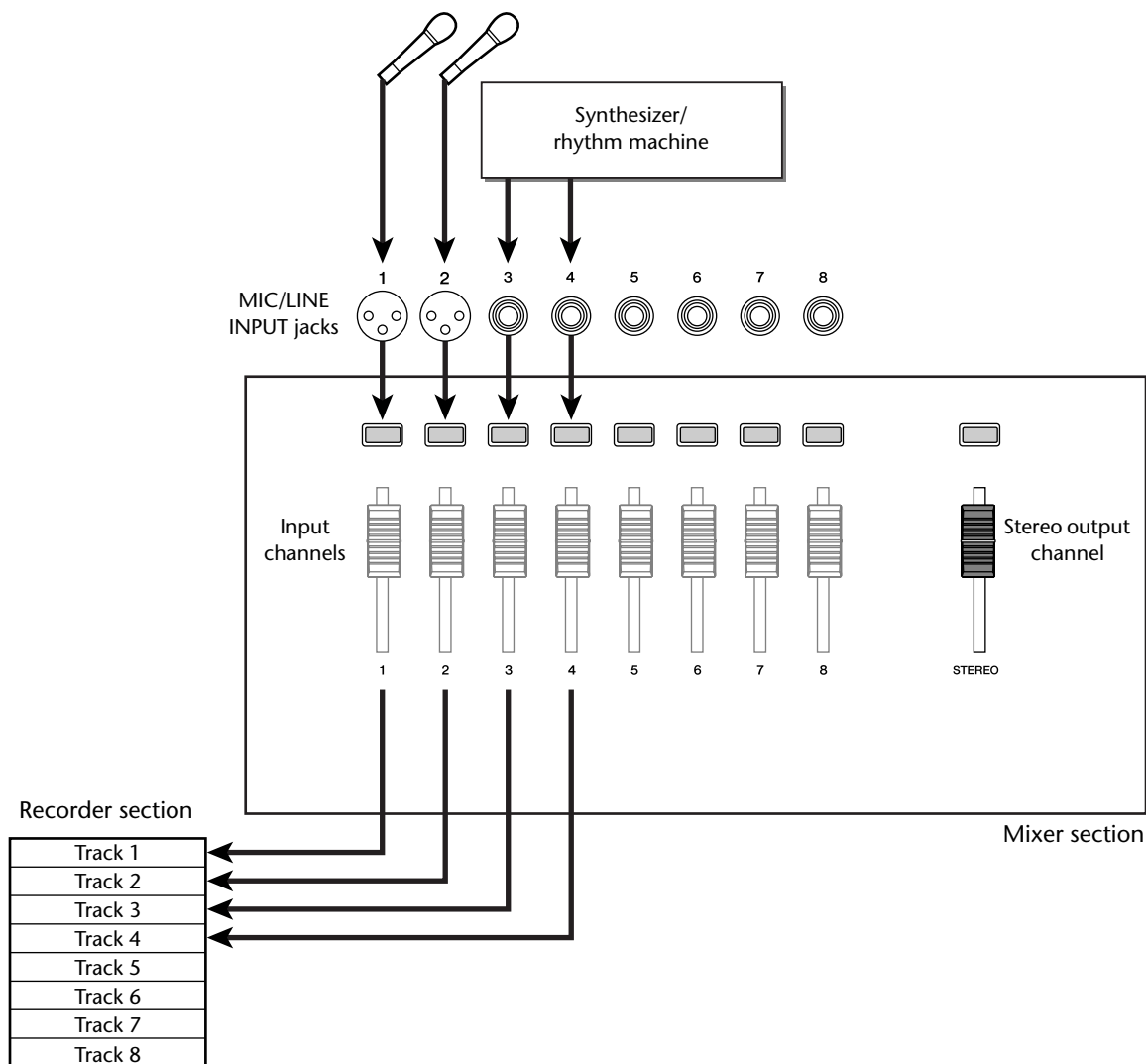

■ Bus recording

With this method, you can send multiple input channels to the L/R bus, and assign the mixed signal to one or two tracks. This method requires fewer tracks. However, you will need to decide on the final volume, pan, and tone of each instrument at the time of recording. (You will not be able to adjust these independently after recording.)

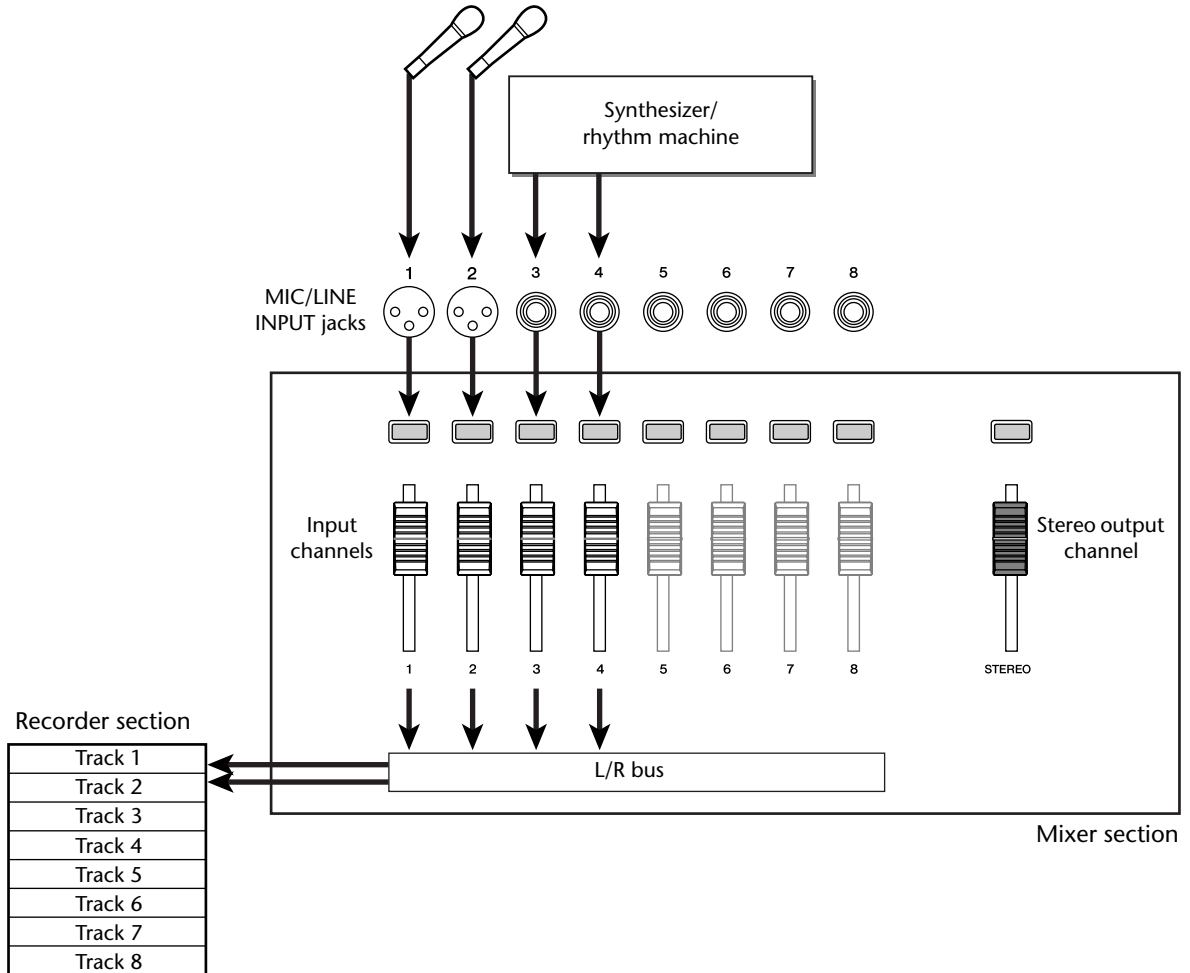

Note

The way in which you assign the input signals to tracks will depend on the method you choose.

Assigning input signals to tracks (Direct recording)

1 Lower the [STEREO] fader to the $-\infty$ position.

2 Connect instruments/mics to MIC/LINE INPUT jacks 1–8.

3 In the Quick Navigate section, either press the [RECORD] key repeatedly or hold down the [RECORD] key and use the CURSOR [\blacktriangle]/[\blacktriangledown] keys to access the DIRECT page of the RECORD screen.

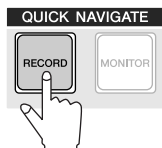

The [INPUT SEL] keys and [TRACK SEL] keys will blink red.

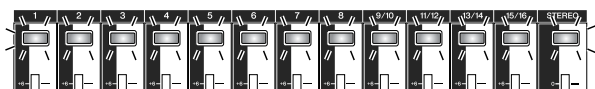
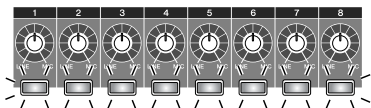

The screen will indicate how input channels are connected to tracks.

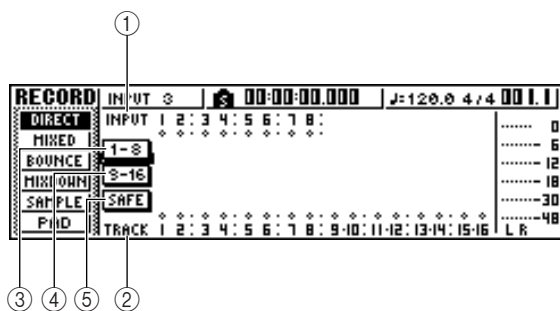

① INPUT

Indicates the connection status of input channels 1–8.

If you move the cursor to numbers 1–8 and press the [ENTER] key, the INPUT SETTING popup window will appear, allowing you to make settings for the corresponding input channel.

If you move the cursor to the \oplus symbol and press the [ENTER] key, the symbol will be highlighted, and the corresponding input channel will be selected as a recording source.

② TRACK

Indicates the connection status of tracks 1–16.

If you move the cursor to the \oplus symbol and press the [ENTER] key, the symbol will be highlighted, and the corresponding track will be selected as a recording destination.

③ 1-8 button

If you move the cursor to this button and press the [ENTER] key, input channels 1–8 will be connected to tracks 1–8.

④ 9-16 button

If you move the cursor to this button and press the [ENTER] key, input channels 1–8 will be connected to tracks 9–16.

⑤ SAFE button

If you move the cursor to this button and press the [ENTER] key, all connections will be cancelled.

4 Press the [INPUT SEL] key for the input channel to which your instrument/mic is connected.

The corresponding [INPUT SEL] key will light red, and the remaining [INPUT SEL] keys will go dark. If this input channel is not yet assigned to a track, all [TRACK SEL] keys will blink red. This blinking indicates that the tracks can be selected as the recording destination.

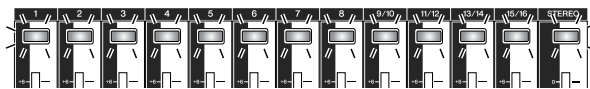
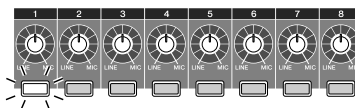

In the screen, the \oplus symbol for that input channel will be highlighted.

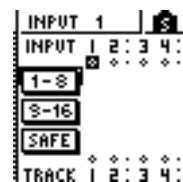

Tip!

- You can also select an input channel by moving the cursor to the \oplus symbol of the desired input channel and pressing the [ENTER] key.
- If you select an input channel to which a track is already assigned, only the corresponding [TRACK SEL] key will blink red.
- If you press and hold the [INPUT SEL] key of an input channel, the INPUT SETTING popup window will appear, allowing you to make settings for the corresponding input channel. To exit this window and return to the previous screen, move the cursor to the EXIT button and press the [ENTER] key.

5 Press the [TRACK SEL] key of the track on which you want to record.

The selected input channel and track will be connected internally. At this time, only the selected [INPUT SEL] key and [TRACK SEL] key will be blinking red. The blinking [TRACK SEL] key indicates that the corresponding track is in record-ready mode.

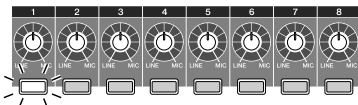

In the screen, a line will be drawn to indicate the connection.

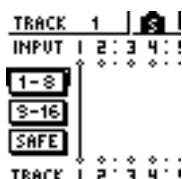

- You can also select a track by moving the cursor to the **+** symbol of the desired track and pressing the [ENTER] key.
- The input channel and track will be internally connected even if you first press the [TRACK SEL] key and then press the [INPUT SEL] key afterward.
- When an input channel is selected as a recording source, its assignment to the stereo bus will automatically be turned off, and it will be connected to allow monitoring via the track channel.
- EQ and dynamics settings will be flat for a track channel that is selected as the recording destination.

6 If you want to record more than one instrument or mic simultaneously, assign other input channels to tracks in the same way.



- To cancel a connection that you made, press the [INPUT SEL] key to make it light red, and then press the [TRACK SEL] key of the track that is selected as the recording destination. To cancel all connections, move the cursor to the SAFE button and press the [ENTER] key.
- To change the recording destination, press the [INPUT SEL] key to make it light red, and then press the [TRACK SEL] key of a different track.
- If both the recording-source inputs and the recording-destination tracks are paired, two adjacent odd-numbered/even-numbered channels will be simultaneously assigned to two adjacent odd-numbered/even-numbered tracks.

7 Press and hold the [INPUT SEL] key for the recording-source input channel, to access the INPUT SETTING popup window.



You can also access the INPUT SETTING popup window by moving the cursor to an input channel number in the RECORD screen DIRECT page, and pressing the [ENTER] key.

8 Use the [GAIN] knob to adjust the input level of the signal.

For details on adjusting the input level, refer to "Recording to a sound clip" (→ p. 33).

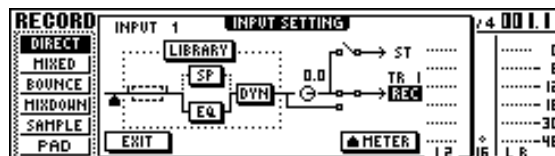

If an input channel is connected to a recording-destination, that recording-destination and the METER button will be added to the display in the INPUT SETTING popup window.

By moving the cursor to the METER button and pressing the [ENTER] key, you can switch the location at which the level is detected between "pre-fader" (default setting; immediately after A/D) and "post-fader" (after the signal has passed through EQ, dynamics, and the level knob). Check that the increase in level after passing through EQ and dynamics does not cause the signal to clip.

9 Raise the [STEREO] fader to the 0 dB position.

10 To monitor the signal that you are recording, raise the fader of the track channel that you selected as the recording destination.

Normally when recording, you do not monitor the input channel signal before it is recorded, but rather the signal after passing through the recorder, via the track channel. This lets you monitor the signal that is actually being recorded, and also lets you adjust the volume and tone of the monitor signal without affecting the signal that is being recorded.

If the track channel fader for the recording-destination track is set to the 0 dB position, the monitor level during recording will be the same as the playback level after recording.

● Monitor signal flow during recording

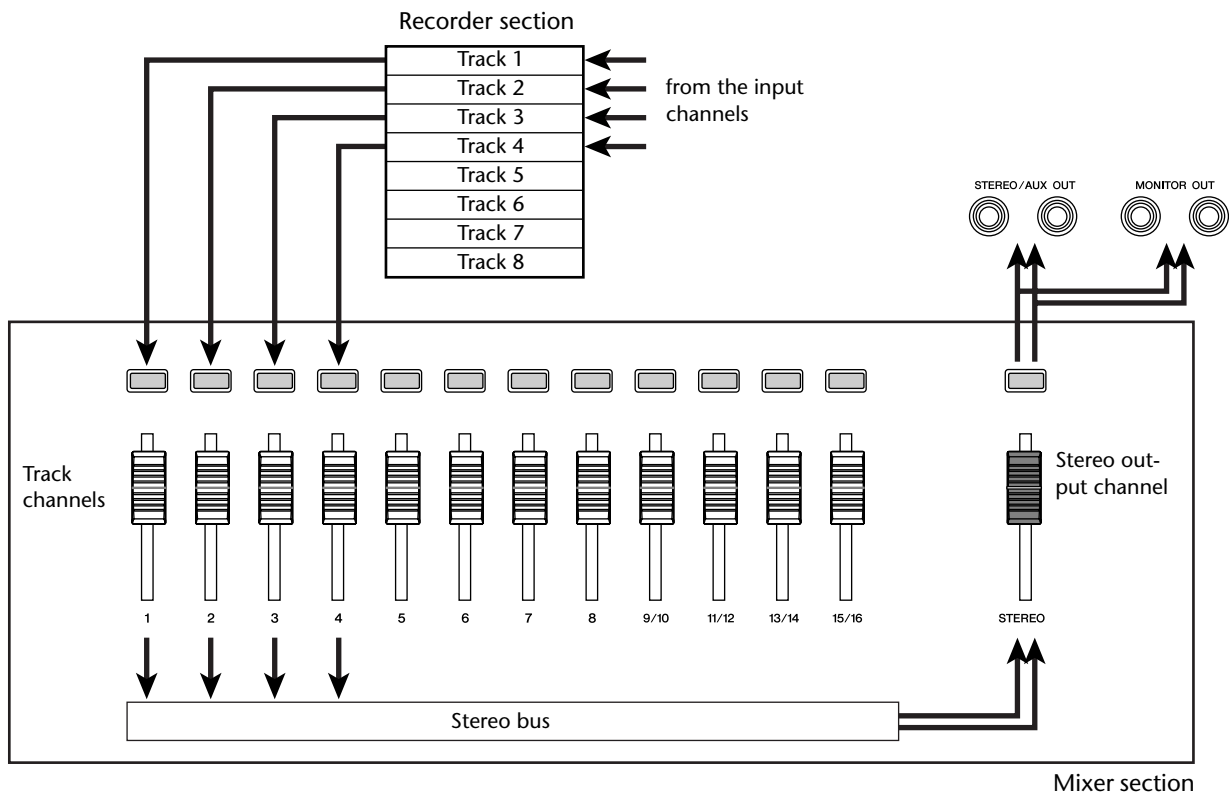

11 To adjust the pan of the monitor signal, press the [TRACK SEL] key for the corresponding track channel, and turn the [PAN/BAL] knob of the Selected Channel section.

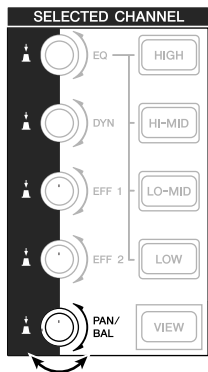

Note

The pan setting of an input channel will have no effect if that input channel is assigned to a track by direct recording.

Assigning input signals to tracks (Bus recording)

- 1 Lower the [STEREO] fader to the $-\infty$ position.
- 2 Connect instruments/mics to MIC/LINE INPUT jacks 1–8.
- 3 In the Quick Navigate section, either press the [RECORD] key repeatedly or hold down the [RECORD] key and use the CURSOR [\blacktriangle] / [\blacktriangledown] keys to access the MIXED page of the RECORD screen.

In the MIXED page of the RECORD screen, you can assign the input channel signals to any one or two tracks via the L/R bus.

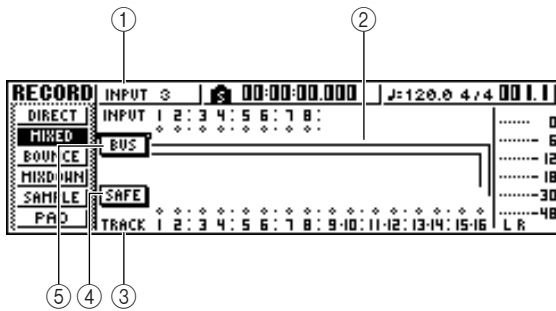

- ① **INPUT**
Selects the record-source input channel.
- ② **L/R bus**
The two horizontal lines indicate the bus L/R signal route. You can check the on/off status of the signal that is sent from the record-source input channel(s) to bus L or R, and check the tracks that will be the record-destination of the L/R bus.
- ③ **TRACK**
Selects the track(s) that will be the record-destination of the L/R bus signal.
- ④ **SAFE button**
To cancel all record-sources and record-destinations, move the cursor to this button and press the [ENTER] key.
- ⑤ **BUS button**
When you move the cursor to this button and press the [ENTER] key, a dedicated fader and level meter for the L/R bus will appear in the right of the screen. You can use this to adjust the master level of the L/R bus.

- 4 Press the [INPUT SEL] key for the input channel to which you connected your instrument or mic.

The current setting [INPUT SEL] key will light orange, and that input channel will be selected for operations.

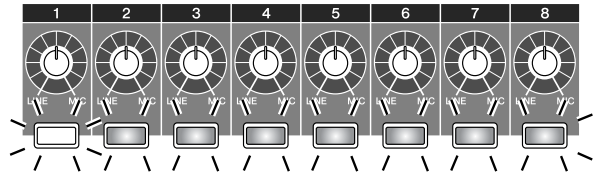

In the screen, the \oplus symbol for the corresponding input channel will be highlighted, and a line will appear, indicating that this channel is connected to the bus.

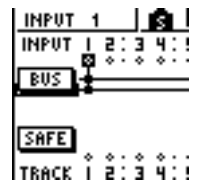

- You can also select an input channel by moving the cursor to the \oplus symbol for the desired input channel and pressing the [ENTER] key.
- If you press and hold the [INPUT SEL] key of an input channel, the INPUT SETTING popup window will appear, allowing you to make settings for the corresponding input channel. To close this popup window and return to the previous screen, move the cursor to the EXIT button and press the [ENTER] key.

- 5 Repeatedly press the same [INPUT SEL] key as in step 4, and the signal sent from that input channel to the L/R bus will be switched on/off.

Each time you press the [INPUT SEL] key, the screen will change as follows.

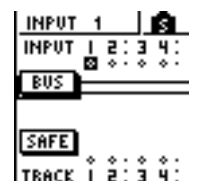
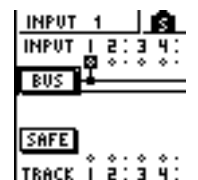
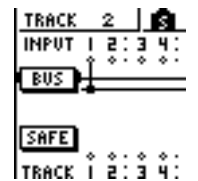
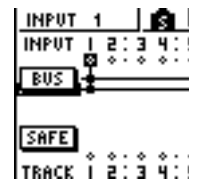

For an input channel that is selected as a record-source, the assignment to the stereo bus will automatically be turned off, and connections will be made so that the signal can be monitored via the track channel.

6 As necessary, use the same procedure to specify other input channels as recording-sources.

7 Press the [TRACK SEL] key(s) for the record-destination track(s).

You can select up to two tracks as the record-destination.

If you select track 1, 3, 5, or 7, the signal will be connected to bus L. If you select track 2, 4, 6, or 8, the signal will be connected to bus R. If you select tracks 9/10–15/16, odd-numbered tracks will be connected to bus L, and even-numbered tracks will be connected to bus R.

The screen will display lines to indicate how the signals are connected to the track(s).

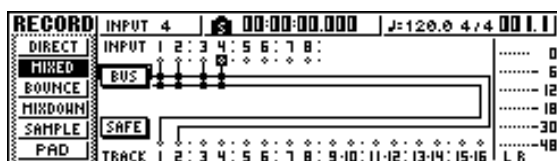

- EQ and dynamics settings will be flat for a track channel whose track has been selected as a record-destination.
- If a single track is selected, the pan of the track channel will be centered. If a paired track (→ p. 49) is selected, the odd-numbered/even-numbered track channels will be panned to left and right respectively.
- The connection will be cancelled if you once again press the [TRACK SEL] key of a currently selected track.

8 For each input channel to which you connected an instrument or mic, press and hold the [INPUT SEL] key to access the INPUT SETTING popup window, and use the [GAIN] knob to adjust the input level of the signal.

For details on adjusting the input level, refer to “Recording to a sound clip” (→ p. 33).

9 Raise the [STEREO] fader to the 0 dB position.

10 Raise the track channel fader for the record-destination track, so that the monitor level is appropriate.

Now you will be able to monitor the signal that is being sent to the track(s) via the L/R bus.

11 To set the pan of each input channel, use the [INPUT SEL] key to select a channel, and turn the [PAN/BAL] knob of the Selected Channel section.

When you use bus recording, it will not be possible to adjust the pan or volume balance for individual instruments after they have been recorded on the track(s). This means that you must finalize the pan and volume balance when you send the signals from the input channels to the L/R bus.

12 To adjust the volume balance of each input channel, repeatedly press the [VIEW] key in the Selected Channel section to access the FADER page.

When you want to set the volume balance of the input channels, it is convenient to use the FADER page of the VIEW screen. Here you can adjust the on/off status and input levels for the input channels, pad channels, and track channels — all in one page.

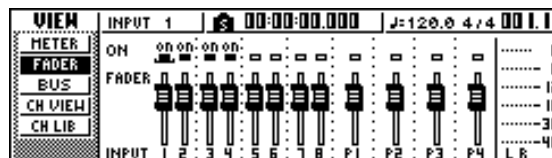

13 While producing sound on your instruments, use the [INPUT SEL] keys or CURSOR [▲]/[▼] keys to move the cursor to the input channel that you want to control, and turn the [DATA/JOG] dial to adjust the volume balance.



We recommend that you not use the [GAIN] knob to adjust the volume balance of the input channels. This will degrade the S/N ratio, and may cause the sound to distort.



- You can also use the INPUT LEVEL knob in the INPUT SETTING popup window to adjust the volume balance of the input channels.
- Normally, the panel faders are dedicated to the track channels. However by changing an internal setting, you can use the faders to control the input levels of the input channels. (→ p. 162)

Enabling the metronome

Before you begin recording, set the tempo and volume of the metronome. If you will not be using the metronome while recording, you can skip the following procedure.

- 1 In the Work Navigate section, repeatedly press the [TRACK] key or hold down the [TRACK] key and use the CURSOR [▲]/[▼] keys to access the VIEW page.

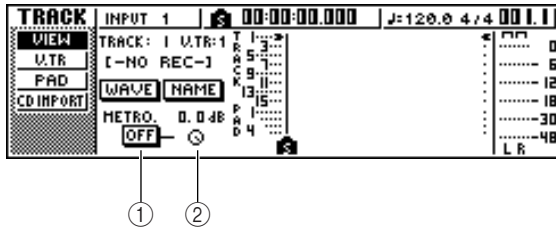

① **Metronome button**

Switches the metronome on/off.

② **Metronome knob**

Adjusts the metronome volume level. The current value is shown above the knob in dB units.

- 2 Move the cursor to the metronome button and press the [ENTER] key.

The metronome will be turned on.

- 3 When you press the [PLAY] key to begin playback, the metronome will begin sounding. As necessary, move the cursor to the metronome knob and turn the [DATA/JOG] dial to adjust the metronome level.

If you want to change the tempo or time signature, press the [STOP] key to stop playback, and perform the following procedure.

- 4 In the Work Navigate section, repeatedly press the [SONG] key or hold down the [SONG] key and use the CURSOR [▲]/[▼] keys to access the TEMPO page.

The TEMPO page lets you create a tempo map that specifies the tempo and time signature of the song. The tempo and time signature that you specify here will be the basis for the measure/beat display counter, the internal metronome, and the MIDI clock messages generated by the AW16G.

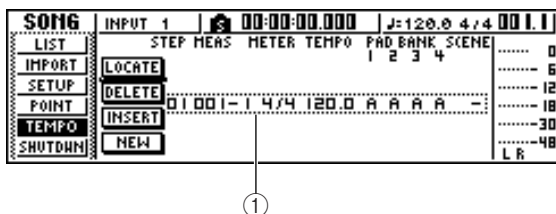

① **Tempo map events**

These are the events recorded in the tempo map. When you create a new song, a tempo map event of time signature = 4/4 and tempo = 120 will be created at the beginning of the song (measure 1, beat 1).

- 5 Move the cursor to the TEMPO field of the event, and turn the [DATA/JOG] dial to set the tempo value.

You can set a tempo in a range of 30–250 (BPM).

- 6 If necessary, move the cursor to the METER field and turn the [DATA/JOG] dial to change the time signature.

You can set a time signature in a range of 1/4–8/4.



- It is also possible to change the tempo or time signature during a song. For details, refer to “Song management” (→ p. 137).
- It is also possible to use the Quick Loop Sampler as a rhythm machine, instead of the metronome. For details, refer to “Using sample libraries” (→ p. 109).

Recording on a track

Now that you have completed your preparations, let's record on a track.

- 1 In the Work Navigate section, repeatedly press the [TRACK] key or hold down the [TRACK] key and use the CURSOR [▲]/[▼] keys to access the VIEW screen.

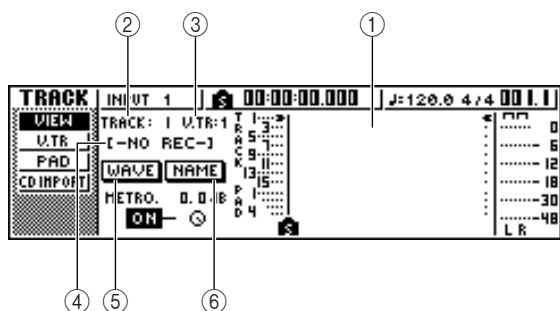

1 Track view

Graphically indicates the presence of data and markers in tracks 1–16, pad tracks 1–4, and the stereo track.

2 TRACK field

Selects the track that you want to operate in the screen. You can select 1–16 (audio track 1–16), ST (stereo track), or PAD 1–4 (pad track 1–4).

Note

Changing the track here will not change the track to be recorded.

3 V.TR field

If you selected 1–16 or ST in the TRACK field, this area will indicate the number of the currently selected virtual track.

4 Track name

Displays the name that has been assigned to the virtual track. If nothing has been recorded, a name of “-NO REC-” will be assigned.

5 WAVE button

When you move the cursor to this button and press the [ENTER] key, the waveform of the currently selected track will be displayed. This button will appear only if you have selected 1–16 or ST in the TRACK field.

6 NAME button

When you move the cursor to this button and press the [ENTER] key, the TITLE EDIT popup window will appear, allowing you to assign a name to the track.

- 2 In the Transport section, hold down the REC [●] key and press the PLAY [▶] key.

The metronome will begin sounding, and the counter display will advance.

In the track view within the screen, the vertical line that indicates the current location will advance toward the right.

- 3 Play your instrument in time with the metronome.

The metronome sound will not be recorded on the track. If necessary, move the cursor to the metronome knob and turn the [DATA/JOG] dial to adjust the metronome volume level.

- 4 To stop recording, press the STOP [■] key.

I (In point) and O (Out point) symbols will appear in the track view of the VIEW page, indicating the location of the most recent recording operation.

The [UNDO/REDO] key of the data entry/control section will light. This indicates that you can press the [UNDO/REDO] key to execute the Undo function.

- 5 To hear the recorded content from the beginning, press the RTZ [◀◀] key to return the counter display to zero, and press the PLAY [▶] key.

- 6 If you want to redo the recording, press the [UNDO/REDO] key.

The [UNDO/REDO] key will go dark, and you will return to the state prior to recording. Repeat steps 2–5.

- 7 When you finish recording, press the Quick Navigate Section [RECORD] key once again, move the cursor to the SAFE button, and press the [ENTER] key.

A popup window will ask you for confirmation, so move the cursor to the OK button and press the [ENTER] key. Assignments of the input signals to tracks will be cancelled. It will no longer be possible to press the [REC] key, and this will prevent recording from occurring accidentally.

- 8 If you are satisfied with the recorded content, save the song. (For details on saving → p. 63)

Please be aware that the recorded content will be lost if you turn off the power of the AW16G before saving the song.

Pairing input channels/track channels

Pad tracks 1–4 and track channels 9/10–15/16 are permanently paired.

However, you may also specify pairing for adjacent odd-numbered/even-numbered input channels (1/2, 3/4, 5/6, 7/8) or track channels (1/2, 3/4, 5/6, 7/8). When two channels are paired, most of their parameters will be linked, so that operating one of the channels will cause the same setting to occur on the other channel as well.

This is convenient when you are recording a stereo audio source, or when you want to play back two bus-recorded tracks as a single stereo track.

- 1 Hold down the [INPUT SEL] key (or [TRACK SEL] key) of one channel that you want to pair, and then press the other [INPUT SEL] key (or [TRACK SEL] key).

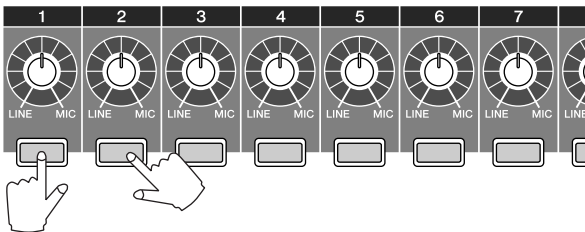

A popup window will appear, asking you to confirm the pairing.

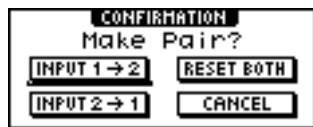

- 2 Move the cursor to one of the following buttons and press the [ENTER] key.

INPUT (TRACK) x → y (x= odd number, y= even number)..... Copy the settings of input (track) channel x to y, and pair them.

INPUT (TRACK) y → x (x= odd number, y= even number)..... Copy the settings of input (track) channel y to x, and pair them.

RESET BOTH..... Initialize both input (track) channels, and pair them.

CANCEL..... Cancel pairing.

When input channels are paired, all mix parameters other than the [GAIN] knob and phase/pan settings will be linked.

When track channels are paired, all mix parameters other than the phase/pan settings will be paired. Operating just the odd-numbered fader will adjust the level of both odd-numbered/even-numbered channels. (While channels are paired, the even-numbered fader has no effect.)

- 3 To defeat pairing, hold down the [INPUT SEL] key (or [TRACK SEL] key) of one of the channels, and press the other [INPUT SEL] key (or [TRACK SEL] key).

A popup window will ask you to confirm that you want to cancel pairing.

- 4 To cancel pairing, press the OK button. If you decide not to cancel pairing, move the cursor to the CANCEL button and press the [ENTER] key.



Tip! In the case of paired channels, setting the pan to far left or far right will produce nominal level. (The levels before and after passing through Pan will be the same.) In the case of paired channels, setting the pan to center will produce nominal level.

Using the input library

The input library is a library of settings used to apply internal effects, EQ, or dynamics settings to the input signal when you want to record the processed signal. Here's how to apply input library settings to the signal of an input channel.

- 1 Press and hold the [INPUT SEL] key of the input channel for which you want to use the input library. The INPUT SETTING popup window will appear.

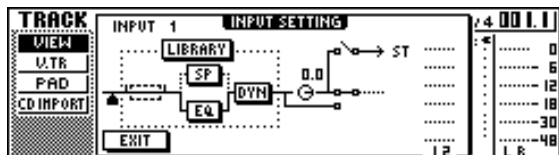

- 2 Move the cursor to the LIBRARY button, and press the [ENTER] key.



The following popup window will appear. In this popup window, you can select whether the internal effect 1 or 2 will be patched to the input channel.

Note

When you use the input library, internal effect 1 or 2 will be disconnected from the send/return of the mixer, and patched to a specific input channel. For this reason, you can use the internal effects on a maximum of two channels.

- 3 Move the cursor to the EFF1 button or EFF2 button, and press the [ENTER] key.

The INPUT LIBRARY popup window will appear, allowing you to select an input library.

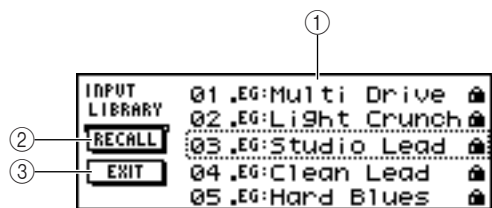

① List

This is the library list. The line surrounded by a dotted line in the middle of the list is the data that is selected for loading. When you turn the [DATA/JOG] dial, the data in the list will scroll upward or downward.

② RECALL button

Move the cursor to this button and press the [ENTER] key to load the currently selected data.

③ EXIT button

Move the cursor to this button and press the [ENTER] key to close the popup window.

- 4 Turn the [DATA/JOG] dial to select the desired input library data.

The input library data is organized into the following categories.

Number	Abbreviation	Category
00		Data for initializing the input channel
01-25	EG	Data suitable for electric guitar.
26-30	AG	Data suitable for acoustic guitar.
31-35	BA	Data suitable for bass.
36-40	VO	Data suitable for vocals

Note

All input library data is read-only.

- 5 Select the desired data, and press the [ENTER] key.

A popup window will ask you to confirm the recall operation.



- 6 Move the cursor to the OK button and press the [ENTER] key.

The data of the selected library will be loaded, and the internal effect, EQ (or speaker simulator), and dynamics effect will be applied to the input signal.

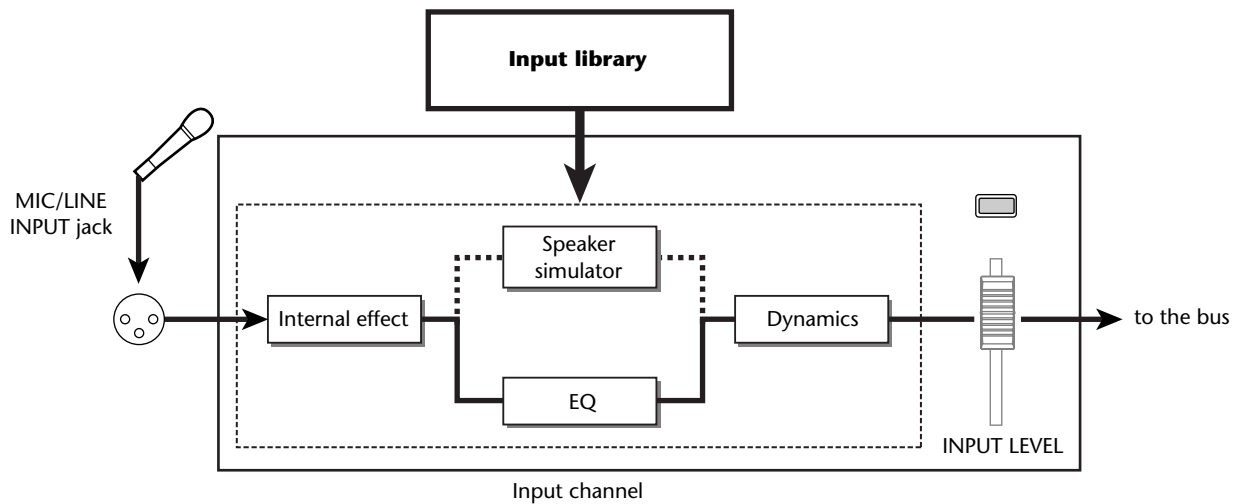

Note

If the input channel is paired, the same settings will be applied to both channels.

- 7** If you want to adjust the effect, use the [INPUT SEL] key to select the input channel. While you produce sound on your instrument, adjust the [EQ] knob, [DYN] knob, or [EFF 1]/[EFF 2] knobs of the Selected Channel section.

Immediately after you select an input library, turning the knobs of the Selected Channel section will control the following items.

Turning the [EQ] knobAdjusts the amount of boost/cut for each EQ band. To select the band that will be adjusted, use the [HIGH] key, [HI-MID] key, [LO-MID] key, or [LOW] key located at the right.

Turning the [DYN] knob....Simultaneously adjusts multiple dynamics parameters to adjust the dynamics effect. The result will depend on the library that you selected.

Turning the [EFF 1] knob...Adjusts the balance of direct sound and processed sound for internal effect 1.

Turning the [EFF 2] knob...Adjusts the balance of direct sound and processed sound for internal effect 2.

Note

Depending on the input library you select, the level of the input channel may change. Re-adjust the volume balance using the INPUT LEVEL knob in the INPUT SETTING popup window.

Tip!

If turning the [EQ] knob or [DYN] knob does not produce the desired result, you can reload new settings from the EQ library or dynamics library (→ p. 77, 78).

- 8** In the same way, select input library settings for the other input channels.

However, a maximum of two input channels can use the internal effects at the same time.

Using the EQ library

The EQ library contains EQ settings appropriate for a variety of instruments. Use these when you want to apply EQ to an input channel while you record, or when you want to modify the EQ settings after recalling an input library.

- 1 Press and hold the [INPUT SEL] key of the input channel for which you want to use the input library, to access the INPUT SETTING popup window.

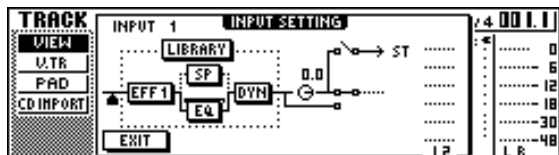

- 2 Move the cursor to the EQ button in the screen, and press the [ENTER] key. The EQ library will appear.

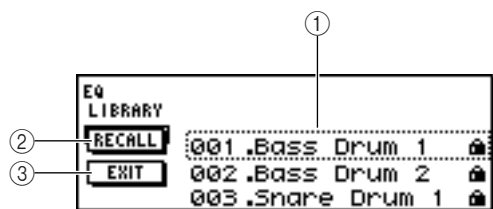

① List

This is the library list. The line surrounded by a dotted line in the middle of the list is the data that is selected for loading. When you turn the [DATA/JOG] dial, the data in the list will scroll upward or downward.

② RECALL button

Move the cursor to this button and press the [ENTER] key to load the currently selected data.

③ EXIT button

Move the cursor to this button and press the [ENTER] key to close the popup window.



You can also access the EQ library by pressing the [EQ] knob of the Selected Channel section. For details, refer to "Using libraries and scene memories" (→ p. 73).

- 3 Turn the [DATA/JOG] dial to select the library that you want to use, and press the [ENTER] key.

A popup window will ask you to confirm the library recall operation.

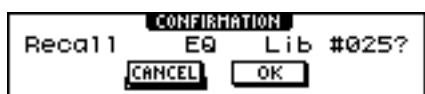

- 4 Move the cursor to the OK button and press the [ENTER] key. The selected library will be loaded.

- 5 Move the cursor to the EXIT button and press the [ENTER] key.

- 6 If you want to adjust the EQ settings, press the [HIGH] key, [HI-MID] key, [LO-MID] key, or [LOW] key of the Selected Channel section to select the band, and turn the EQ knob to adjust the amount of boost/cut.



If turning the EQ knob does not change the tone, check whether EQ may have been turned off for that channel (→ p. 92).



If necessary, you can also adjust the frequency and Q parameters of each band. For details, refer to "Using libraries and scene memories" (→ p. 73).

Using the dynamics library

The dynamics library contains dynamics settings suitable for a variety of instruments. As for the EQ library, you can use this to apply dynamics processing to an input channel while you record, or when you want to modify the dynamics settings after recalling an input library.

- 1 Press and hold the [INPUT SEL] key of the input channel for which you want to use the dynamics library, to access the INPUT SETTING popup window.

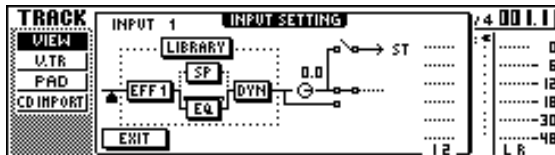

- 2 Move the cursor to the DYN button in the screen, and press the [ENTER] key. The dynamics library will appear.

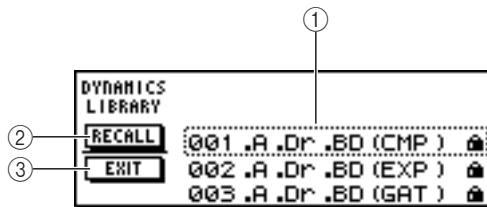

- 1 **List**
This is the library list. The line surrounded by a dotted line in the middle of the list is the data that is selected for loading. When you turn the [DATA/JOG] dial, the data in the list will scroll upward or downward.
- 2 **RECALL button**
Move the cursor to this button and press the [ENTER] key to load the currently selected data.
- 3 **EXIT button**
Move the cursor to this button and press the [ENTER] key to close the popup window.



You can also access the dynamics library by pressing the [DYN] knob of the Selected Channel section. For details, refer to "Using libraries and scene memories" (→ p. 73).

- 3 Turn the [DATA/JOG] dial to select the library that you want to use, and press the [ENTER] key.

A popup window will ask you to confirm the library recall operation.



- 4 Move the cursor to the OK button and press the [ENTER] key. The selected dynamics library will be loaded.

- 5 Move the cursor to the EXIT button and press the [ENTER] key.

- 6 If you want to adjust the dynamics settings, turn the [DYN] knob of the Selected Channel section.

Turning the [DYN] knob immediately after a library has been recalled will simultaneously adjust multiple dynamics parameters to control the dynamics effect. (The result will depend on the library that you select.)



If turning the [DYN] knob does not change the tone, check whether dynamics may have been turned off for that channel (→ p. 93).



If necessary, you can also make detailed adjustments to the individual dynamics parameters. For details, refer to "Using libraries and scene memories" (→ p. 73).

Chapter 6

Overdubbing

This chapter explains how you can record additional performances on other tracks while you listen to the previously-recorded tracks. This chapter also explains how to switch virtual tracks and save songs.

About overdubbing

“Overdubbing” is the process of recording additional performances on other tracks while you monitor the playback of previously-recorded tracks.

The diagram below shows the signal flow when you play back tracks 1–4 and overdub track 5. In this example, the signal that is input from MIC/LINE INPUT jack 1 is routed through recorder track 5 and sent to track channel 5. This signal is then sent to the stereo bus, mixed with the playback sound of track channels 1–4, and output from the STEREO/AUX OUT jacks and the MONITOR OUT jacks / PHONES jack.

- Signal flow when overdubbing

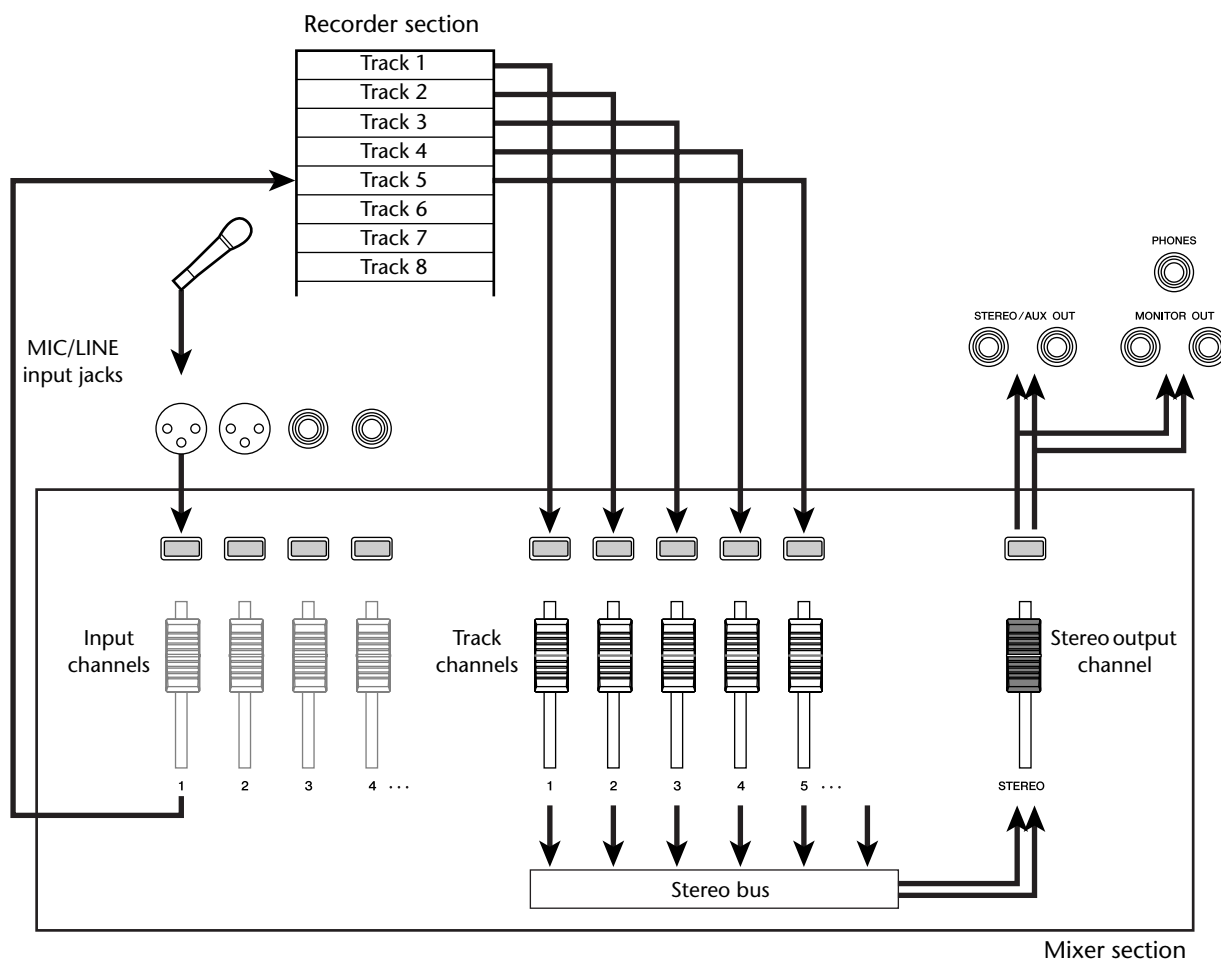

Assigning the input signal to a track

In order to overdub, you must first assign the mic or instrument to a new track. The basic procedure is the same as when recording the first track.

- 1 Lower the [STEREO] fader to the $-\infty$ position.
 - 2 Connect your instrument or mic to a MIC/LINE INPUT jack.
 - 3 In the Work Navigate Section, repeatedly press the [RECORD] key or hold down the [RECORD] key and use the CURSOR [\blacktriangle]/[\blacktriangledown] keys to access the DIRECT page of the RECORD screen.
- The [INPUT SEL] key and [TRACK SEL] key will blink red.



- 4 Assign the input channel to which your instrument/mic is connected to a new track, and adjust the level.

For details on this step, refer to "Track recording" (\rightarrow p. 39). The diagram below shows an example of when input channel 1 is assigned to track 5.



Tip! In this example we will use "direct recording," in which one input channel is assigned to one track. However, you may also use "bus recording," in which multiple input channels are sent to the L/R bus and recorded on one or two tracks.

Instantly recalling an EQ library

The chapter entitled "Track recording" explained how to access the LIBRARY page of the EQ screen and load an EQ library to change the EQ. This section explains how you can instantly recall an EQ library.

- 1 Press the [INPUT SEL] key of the input channel for which you want to use a library. The corresponding input channel will be selected for operations.
- 2 In the Selected Channel section, press down the [EQ] knob and turn it.

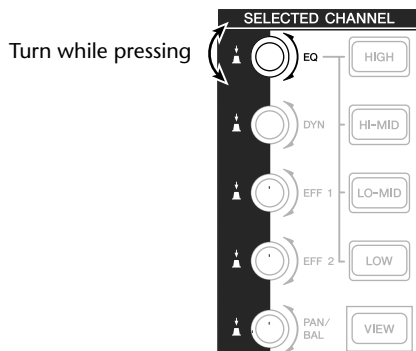

When you turn the [EQ] knob to left or right while pressing it, the LIBRARY page of the EQ screen will appear.

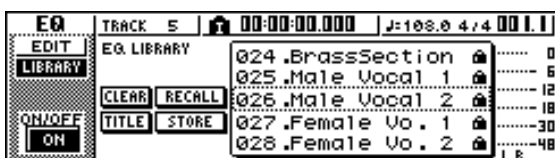

- 3 Turn the [DATA/JOG] dial to select an EQ library. Then move the cursor to the RECALL button and press the [ENTER] key.

The selected library will be loaded.

- 4 If you want to adjust the EQ settings, use the [HIGH] key, [HI-MID] key, [LO-MID] key, and [LOW] key of the Selected Channel section to select the EQ band, and turn the [EQ] knob to adjust the amount of boost or cut.



Tip! If necessary, you can make detailed adjustments to EQ parameters such as the center frequency and Q (\rightarrow p. 92).

Instantly recalling a dynamics library

A dynamics library can be instantly recalled in the same way as an EQ library.

- 1 In the Selected Channel section, press down the [DYN] knob and turn it.

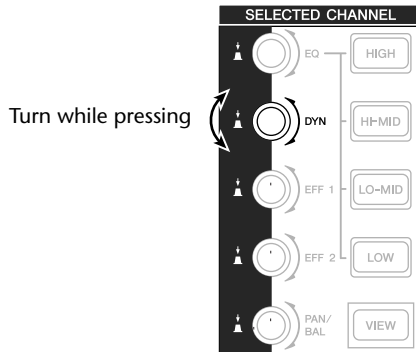

When you turn the [DYN] knob to left or right while pressing it, the LIBRARY page of the DYN screen will appear.



- 2 Turn the [DATA/JOG] dial to select a DYN library. Then move the cursor to the RECALL button and press the [ENTER] key. The selected library will be loaded.

- 3 If you want to adjust the dynamics effect, turn the [DYN] knob in the Selected Channel section.



- In the same way, you can press and turn the [EFF1] knob or [EFF2] knob in the Selected Channel to recall an effect library.
- If necessary, you can make detailed adjustments to the dynamics parameters (→ p. 93).

Setting the mix balance and pan

Here's how to set the volume balance and pan for the previously-recorded tracks and the tracks that you now will be overdubbing.

- 1 While you play back the song, raise the track channel faders for the previously-recorded tracks to an appropriate monitoring level.
- 2 Press the track channel [TRACK SEL] key for a previously-recorded track, and use the [PAN/BAL] knob of the Selected Channel section to set the pan.
- 3 Stop the recorder, and while producing sound on your instrument, adjust the fader of the recording-destination track channel so that the monitoring level is appropriate.

The track channel for the recording-destination track will send the input signal to the stereo bus while recording or stopped, and will send the track playback signal to the stereo bus during playback. This means that in order to monitor the input signal, you must stop the recorder.



The position of the track channel faders will not affect the recording level. However if you set the faders to 0 dB, the playback volume will be the same as when you recorded the tracks.

- 4 Press the [TRACK SEL] key for the recording-destination track channel, and use the [PAN/BAL] knob of the Selected Channel section to set the pan.

In the same way as for the input channel signal, you can also use EQ and dynamics to process the track channel. To do this, press the [TRACK SEL] key to select the track channel, and use the [EQ] knob or [DYN] knob of the Selected Channel section to recall a library and adjust the settings. This procedure will not affect the signal that is recorded on the track.

Overdubbing

Now you can overdub onto the track that you selected as the recording-destination.

- 1 In the Work Navigate section, repeatedly press the [TRACK] key or hold down the [TRACK] key and use the CURSOR [▲]/[▼] keys to access the VIEW page.

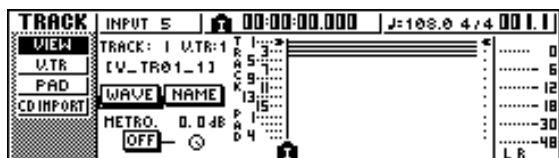

- 2 Move the cursor to the metronome button, and press the [ENTER] key to switch the setting on or off as desired.

You can perform overdubbing whether the metronome is on or off.

- 3 In the transport section, hold down the REC [●] key and press the PLAY [▶] key.

The metronome will begin sounding, and the counter display will advance.

- 4 While monitoring the previously-recorded tracks, play the instrument that you want to overdub.

- 5 To stop recording, press the STOP [■] key. The [UNDO/REDO] key in the data entry / control section will light.

- 6 To listen to the recorded performance from the beginning, press the RTZ [◀◀] key to return the counter display to zero, and press the PLAY [▶] key.



Tip! If you recorded from the middle of the song, you can press the [IN] key to move to the location at which you began recording.

- 7 If you are satisfied with the recorded performance, save the song. (For details on saving → p. 63)

If you decide to re-do the recording, press the [UNDO/REDO] key to cancel the recording, and repeat steps 3–7.

Punch-in/out

If you make a mistake while overdubbing, you can re-record just the region in which you made the mistake. This process is called “punch-in/out.”

Punch-in/out can be performed either as “manual punch-in/out” in which you switch between recording and playback manually, or as “auto punch-in/out” in which recording and playback will switch automatically when you reach the locations you specify beforehand.

Manual punch-in/out

Here’s how to perform punch-in/out using the keys of the transport section or a foot switch.

- 1 If you want to perform punch-in/out using a foot switch, connect a separately sold foot switch (Yamaha FC5 or equivalent) to the rear panel FOOT SW jack.
- 2 Access the DIRECT page of the RECORD screen, and make sure that your instrument/mic is assigned to the track on which you want to punch-in.

At this time, the [INPUT SEL] key of the recording-source and the [TRACK SEL] key of the recording-destination will blink red.

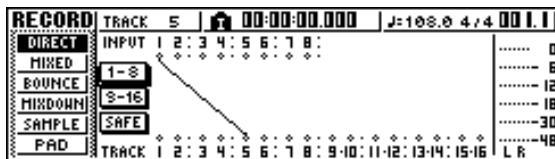

- 3 Locate to a point earlier than where you want to punch-in.

You may find it convenient to register a marker at a location one or two measures earlier than the point at which you want to punch-in, so you can quickly return to that point. (For details on registering a marker → p. 67)

- 4 In the transport section, press the PLAY [▶] key. (Alternatively, press the foot switch.)

The song will begin playing. At this time, the track playback sound of the recording-destination track channel will be sent to the stereo bus, so you will not be able to monitor the input signal.

- 5 At the point where you want to begin recording, hold down the PLAY [▶] key and press the REC [●] key (or press the foot switch once again), and begin playing your instrument.

The recording-destination track will switch from playback to recording (“punch-in”).

The recording-source [INPUT SEL] key and the recording-destination [TRACK SEL] key will light red, and the signal of the corresponding track channel will switch from the track playback to the input signal.

- 6 At the point where you want to stop recording, press the PLAY [▶] key (or press the foot switch).

The recording-destination track will switch from recording back to playback (“punch-out”).

- 7 To stop playback, press the STOP [■] key (or press the foot switch).

- 8 To listen to the newly-recorded content, locate to a point just before the punch-in point, and press the PLAY [▶] key.

- 9 If you are satisfied with the newly-recorded content, save the song. (For details on saving → p. 63)

If you decide to re-do the recording, press the [UNDO/REDO] key to cancel the recording, and repeat steps 4–9.

The following diagram shows the manual punch-in/out procedure.

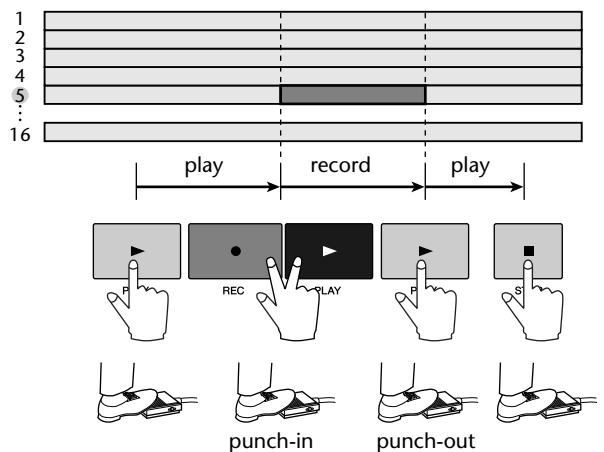

Auto punch-in/out

Auto punch-in/out is a function that performs the punch-in and punch-out operations automatically. In order to use this function, you must first specify the punch-in location (the In point) and the punch-out location (the Out point).

- 1 Access the DIRECT page of the RECORD screen, and make sure that your instrument/mic is assigned to the track on which you want to punch-in.



The recording-source [INPUT SEL] key and the recording-destination [TRACK SEL] key will blink red.

- 2 Locate to the point at which you want to punch-in.
- 3 In the Locate section, hold down the [SET] key and press the [IN] key.
The current location will be registered as the In point.
- 4 Locate to the point at which you want to punch-out.
- 5 In the Locate section, hold down the [SET] key and press the [OUT] key.
The current location will be registered as the Out point.



- If you want to set the In and Out points more precisely, you can use the Nudge function (→ p. 71) which repeatedly plays a short region before or after the current location, or use the WAVE DISPLAY popup window (→ p. 72) which lets you view the contents of the track as a waveform.
- The In point and Out point will be updated each time you record. The location at which you last started recording will be registered as the In point, and the location at which you last stopped recording will be registered as the Out point.

- 6 In the Locate section, press the [AUTO PUNCH] key.
The [AUTO PUNCH] key will light, and the Auto Punch-in/out function will be enabled. You will automatically locate to a point a specific distance (the “pre-roll time”) ahead of the In point. This point is called the “pre-roll point.”

- 7 To rehearse the auto punch-in/out, press the PLAY [▶] key.
 - ① The PLAY [▶] key will light, and playback will begin from the pre-roll point.
 - ② When you reach the auto punch-in point, the REC [●] key will begin blinking, and the signal that you are monitoring from the recording-destination track channel will switch from the track playback to the input signal (recording-source). (However, recording will not actually occur.)
 - ③ When you reach the auto punch-out point, the REC [●] key will go dark, and the signal that you are monitoring from the recording-destination track channel will return to the track playback.
 - ④ When you reach a point that is a specific distance (the “post-roll time”) after the Out point (this point is called the “post-roll point”), you will return to the pre-roll point and stop.



- If you turn the Locate section [REPEAT] key on before step 7, operations ①–④ of step 7 will be repeated up to fifteen times. (The A-B Repeat function is disabled during this time.) If you want to stop repeating the rehearsal, press the [REPEAT] key once again or press the STOP [■] key.
- With the initial settings of the AW16G, the pre-roll and post-roll times are each set to four seconds. You can adjust these values in a range of 0–5 seconds (→ p. 162).

- 8 To perform the actual auto punch-in/out, stop the recorder, then hold down the REC [●] key and press the PLAY [▶] key.
 - ① Only the PLAY [▶] key will light, and playback will begin from the pre-roll point.
 - ② When you reach the auto punch-in point, the REC [●] key will light, and recording will begin (“punch-in”).
 - ③ When you reach the auto punch-out point, the REC [●] key will go dark, recording will stop, and you will return to playback mode (“punch-out”).
 - ④ When you reach the post-roll point, you will return to the pre-roll point and stop.

- 9 To check the newly-recorded content, press the [AUTO PUNCH] key to make it go dark, and then press the PLAY [▶] key.

- 10 If you are satisfied with the newly-recorded content, save the song. (For the Save procedure → p. 63)
If you decide to re-do the recording, press the [UNDO/REDO] key to discard the newly-recorded content, and repeat steps 6–9.
The following diagram shows the auto punch-in/out procedure.

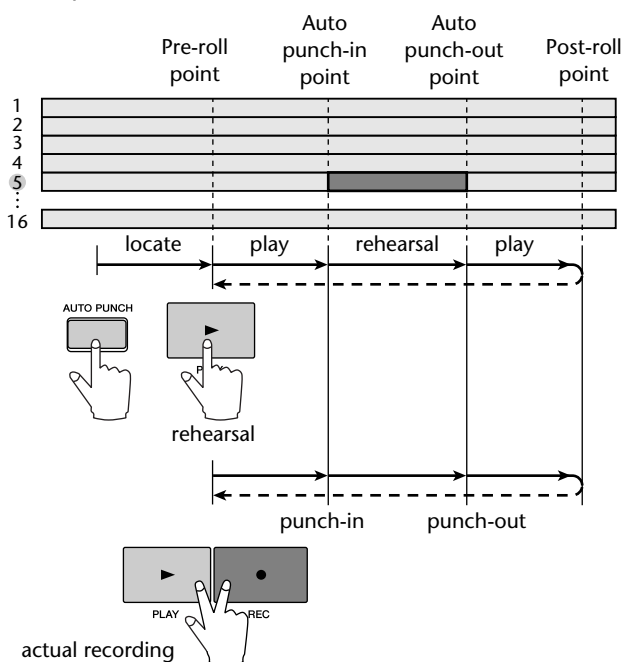

Using the Undo List

By using the AW16G's Undo function, you can not only cancel the most recent recording or editing operation, but can even backtrack through your work for as many as fifteen previous steps. This is convenient when, for example, after performing several overdubs, you decide that you would rather go back to the state immediately after you had recorded the third solo.

- 1 Press and hold the [UNDO/REDO] key.
The UNDO LIST popup window will appear.

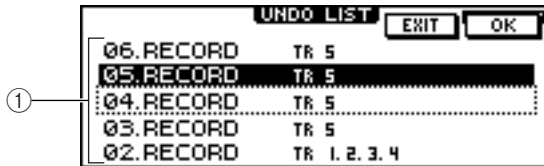

1 Undo list

This is a list of the previously-performed recording and editing operations.

From the left, the list shows a step number that indicates the order in which the operations were performed, the content of the operation, and the track/virtual track that was affected by the recording or editing operation.

The current song is now in the state of the step that is highlighted.

The step enclosed by a dotted frame indicates the step to which the Undo function will return the song.

- 2 Turn the [DATA/JOG] dial to select a step number.
- 3 Move the cursor to the OK button and press the [ENTER] key.
The current song will revert to the state of the step you selected.

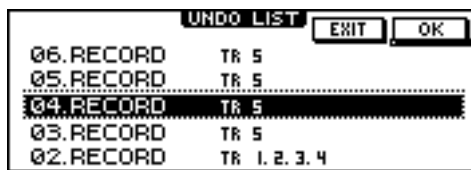

- 4 Move the cursor to the EXIT button and press the [ENTER] key.
The popup window will close, and you will return to the previous screen.

Note

Please note that if you perform recording or editing after "undoing" back to a certain step, the undo/redo data subsequent to that step will be erased. For example if you "undo" the previous three steps, and then perform a recording or editing operation, the undo/redo data for the previous steps 1 and 2 will be erased.

Switching virtual tracks

Each audio track 1–16 contains eight virtual tracks. After overdubbing a solo part, you can switch the virtual track for that track, and record a different take while preserving the previously-recorded content. Here's how to switch the virtual track that is selected for a track.

- 1 In the Work Navigate section, repeatedly press the [TRACK] key or hold down the [TRACK] key and use the CURSOR [▲]/[▼] keys to access the V.TR page.

In the V.TR page you can switch the virtual track (1–8) that will be used for recording/playback by each audio track 1–16.

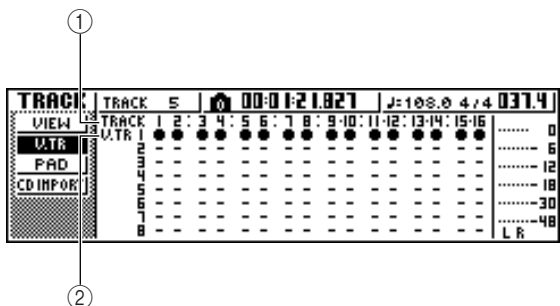

① TRACK

Indicates the track number 1–16.

② V.TR

Indicates the status of virtual tracks 1–8. The virtual track that is currently selected for each track is indicated by a “●” symbol. Of the virtual tracks that are currently not selected, those that have been recorded are indicated by “○”, and those that have not yet been recorded are indicated as “-”.

- 2 Use the CURSOR [▲]/[▼]/[◀]/[▶] keys to select the virtual track number that you want to assign to the desired track.

- 3 Press the [ENTER] key.

The “●” symbol will be displayed at the position of the newly-selected virtual track. This virtual track will now be used for recording/playback.

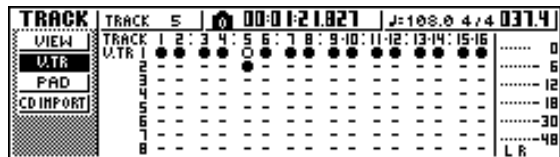

- 4 If you want to assign a name to each virtual track, repeatedly press the Work Navigate [TRACK] key or hold down the [TRACK] key and use the CURSOR [▲]/[▼] keys to access the VIEW page.

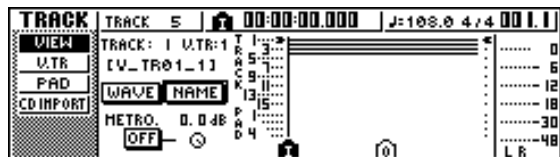

- 5 Move the cursor to the TRACK field, and turn the [DATA/JOG] dial to select a track number.

- 6 Move the cursor to the NAME button and press the [ENTER] key.

The TITLE EDIT popup window will appear, allowing you to assign a name to the virtual track.



- 7 Assign a new name to the virtual track.

For details on how to assign a name, refer to page 24.

Saving the current song

This section explains how to save the current song to the hard disk. If you accidentally turn off the power of the AW16G without saving the song, all recordings or operations that you performed since last saving the song will be lost. You should make a habit of saving the song at appropriate breaks in your work.

- 1 In the Work Navigate section, repeatedly press the [SONG] key or hold down the [SONG] key and use the CURSOR [▲]/[▼] keys to access the LIST page.

In this page you can select a song on the hard disk, and load or delete it.

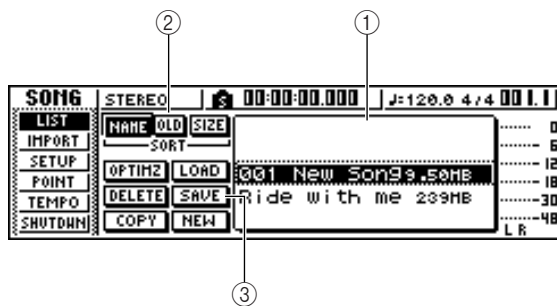

1 List

This is a list of the songs saved on the hard disk. The line enclosed by a dotted frame in the center of the list is the song to which your operation you perform will apply. The highlighted line is the song that is currently loaded into the AW16G. (This is referred to as the “current song.”)

2 SORT field

Use these three buttons to select how the songs in the list will be sorted. You can choose NAME (sort alphabetically), OLD (sort by date of saving), or SIZE (sort by size).

3 SAVE button

When you move the cursor to this button and press the [ENTER] key, the current song will be saved.

- 2 Move the cursor to the SAVE button and press the [ENTER] key.

A popup window will ask you to confirm that you want to save the current song.



- 3 To save the song, move the cursor to the OK button and press the [ENTER] key.

If you move the cursor to the CANCEL button (instead of the OK button) and press the [ENTER] key, the Save operation will be cancelled.

Note

- The song save operation always saves the current song, regardless of the song that is selected in the list.
- You cannot save a song that is protected. If for example you have edited the mixer settings and need to save the song, you must disable the protect setting and then save the song. (Making various settings for a song → p. 139)

Tip!

- If necessary, you can change the name of the song before you save it (→ p. 138).
- In the following situations, a popup window will ask whether you want to save the current song; when you load an existing song from the hard disk, when you create a new song, or when you shut-down the AW16G.
- However, we recommend that you frequently save the song you are working on, as a safeguard against accidents such as the AW16G’s power cable being accidentally disconnected.

Loading an existing song

Here's how to load an existing song from the hard disk.

- 1 In the Work Navigate section, repeatedly press the [SONG] key or hold down the [SONG] key and use the CURSOR [▲]/[▼] keys to access the LIST page.



- 2 Turn the [DATA/JOG] dial to select a song.



- 3 Move the cursor to the LOAD button in the screen, and press the [ENTER] key.
A popup window will ask you whether you want to save the current song.



- 4 Move the cursor to either YES (if you want to save the current song) or NO (if you do not want to save the current song), and press the [ENTER] key.
The song you selected will be loaded.

Note

If you select NO, all changes you made after last saving the current song will be lost.

Chapter 7

Various types of playback

This chapter explains how to use the locator and marker functions, and various other playback methods provided by the AW16G.

Using the locator

“Locate points” are locations you specify within a song in order to execute functions such as auto punch-in/out and A-B repeat. You can use this function to “locate” (move the current location of the song) to one of these points just by pressing a single key. On the AW16G, you can use the following locate points.

- **In/out points**

These locate points are used to specify the region for auto punch-in/out (→ p. 59). Normally, the beginning and end of the recording you last performed will be automatically set as the In point and Out point. However, you may change these points as desired.

- **A/B points**

These locate points are used to specify the region for the A-B Repeat function (→ p. 70). The A point and B point can be set to any point in a song, either by pressing a key or by operations in the screen.

- **Start/end points**

These locate points normally correspond to the beginning and end of the song. When you create a new song, the Start point will initially be set to absolute time 00:00:00.000. When you record, the end of the song will automatically be set as the End point. If you record past the previously-set End point, the End point will automatically move back.

If you select SEC or T.C. as the counter display format, the Start point will be the basis (the zero point) of the time and time code that are displayed. This means that if you change the Start point, the display will change as follows, depending on the counter display format.



When you create an audio CD, the Start and End points can be used to specify the region of the stereo track that will be written to the audio CD (→ p. 98).

Start point = 00:00:00:00.00

Counter display format			
ABS	00:00:00:00.00	00:00:05:00.00	00:00:10:00.00
SEC	00:00:00:00.00	00:00:05:00.00	00:00:10:00.00
T.C	00:00:00:00.00	00:00:05:00.00	00:00:10:00.00

Start point = 00:00:05:00.00

Counter display format			
ABS	00:00:00:00.00	00:00:05:00.00	00:00:10:00.00
SEC	-00:00:05:00.00	00:00:00:00.00	00:00:05:00.00
T.C	23:59:55:00.00	00:00:00:00.00	00:00:05:00.00



When the AW16G transmits MTC to an external device, the Start point will be the basis (the zero point) of the time code that is generated. The Start point will also be the basis (measure 1 beat 1) for the measures displayed in the counter.

- **Relative zero point**

This locate point stores the relative zero position. When you press the RTZ [◀◀] key in the transport section, you will move to this location. If the song is in the initial state, the relative zero point will be the same as absolute time 00:00:00.000, but you can change this if desired by using key operations or operations in the screen.

If you select REL as the counter display format, the current location will be displayed with the Relative Zero point as 0.

The following procedure shows how to register the current location in one of the locate points, and then move the song to that locate point.

1 Move the song to the point that you want to register as a locate point.

You can set a locate point whether the song is playing or stopped.

2 Hold down the [SET] key and press the key for the desired locate point.



The locate points correspond to the following keys.

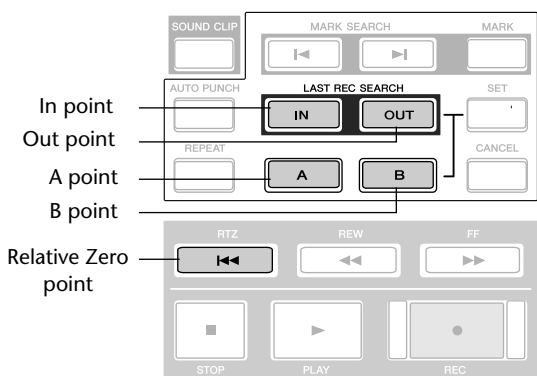

- [IN] key..... In point
- [OUT] key..... Out point
- [A] key..... A point
- [B] key..... B point
- RTZ [<<<] key..... Relative Zero point

Note

- If you want to change the Start point or End point, use the SONG screen POINT page. These points cannot be set by key operations.
- The In point and Out point will be updated automatically when you perform a recording operation.

3 To move to a locate point you registered, press the corresponding key while the song is stopped or playing.

The song will move to that location, and an icon will appear at the left side of the counter to indicate the currently selected locate point.

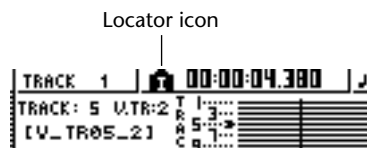

This icon will remain visible until you play or rewind/fast-forward past the previous or next locate point or marker location.

Locate points that you register are displayed in the TRACK screen VIEW page or PAD page as shown below.

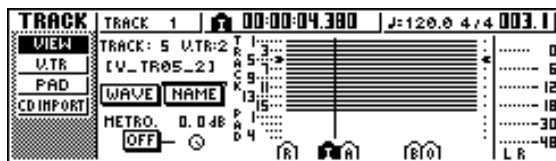

Locator icon

Tip!

- Locate point settings are stored on the hard disk as part of the song.
- Locate points can be adjusted as desired (→ p. 68). Locate points other than the Start point and End point may also be erased (→ p. 69).

Using markers

“Markers” are symbols that you assign at desired locations in a song, so that you can move quickly to a desired point. You can assign up to 99 markers in each song. Use the [◀|▶] keys to find and move to markers.

1 Move to the position in the song at which you want to assign a marker.

You can assign a marker whether the song is playing or stopped.

2 Press the [MARK] key.



The top line of the display will briefly indicate “MARK POINT SET.” This indicates that a marker has been set. A new marker will be added each time you press the [MARK] key.

Markers are automatically numbered 1–99 starting at the beginning of the song. If you register a new marker between two existing markers, subsequent markers will be automatically renumbered upward.

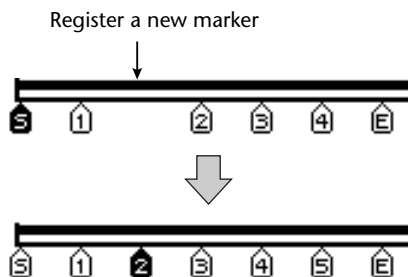

- Marker settings are stored on the hard disk as part of the song.
- Markers can be deleted (→ p. 69) or moved (→ p. 68) as desired.
- If you press the [MARK] key at a location in which a marker has already been registered, the display will indicate “CANNOT SET MARK,” and a new marker will not be created.

3 Press the [◀|▶] key to locate to the previous marker, or press the [▶|▶] key to locate to the next marker.

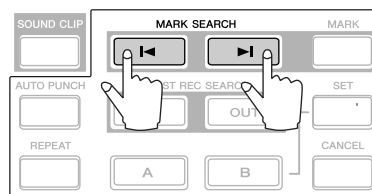

The song will move to that location, and an icon will appear at the left of the counter to indicate the currently selected marker number.

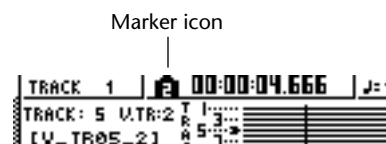

This icon will remain visible until you play or rewind/fast-forward past the previous or next locate point or marker location.

Markers that you register are displayed in the TRACK screen VIEW page or PAD page as shown below.

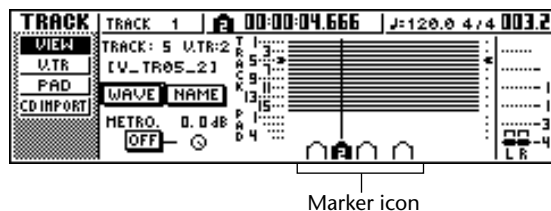

Markers other than the marker displayed at the left of the counter are shown as icons without a number, and indicate their approximate location.



When creating an audio CD, you can use markers to divide the stereo track into the tracks that will be written to the audio CD (→ p. 98).

7
Various types of playback

Adjusting the position of a locate point or marker

Here's how you can adjust the position of a previously-registered locate point or marker.

1 In the Work Navigate section, repeatedly press the [SONG] key or hold down the [SONG] key and use the CURSOR [▲]/[▼] keys to access the POINT page.

In the POINT page you can adjust the time location of each locate point and marker.

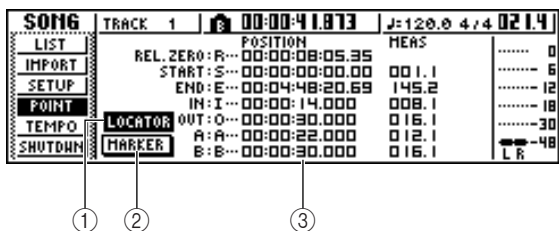

① **LOCATOR button**

② **MARKER button**

These buttons select whether the screen will show locate points or markers. The button that is currently turned on will be highlighted.

③ **Locator point/marker display area**

This area shows a list of the locate points or markers, depending on whether you have selected the LOCATOR button or the MARKER button.

2 If you want to adjust the position of a locate point, make sure that the LOCATE button is turned on (highlighted) in the display.

When the LOCATOR button is on, the POINT page will display the positions of each locate point.

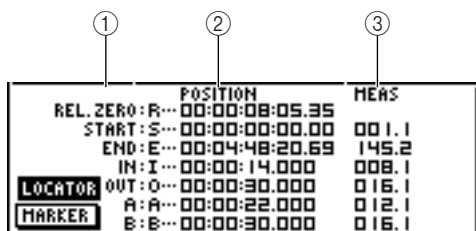

① **Locate points**

Shows the type of locate point and its abbreviation.

② **POSITION**

Shows the position of each locate point as time code or the counter display format.

③ **MEAS**

Shows the position of each locate point as measures/beats. This value is calculated according to the tempo and time signature of the tempo map (→ p. 142).

The format in which the position is displayed will depend on the locate point. The following table shows the display format for each locate point.

Locate point	POSITION field	MEAS field
REL.ZERO	Time code	
START	Time code	Measure/beat
END	Time code	Measure/beat
IN	Counter display format	Measure/beat
OUT	Counter display format	Measure/beat
A	Counter display format	Measure/beat
B	Counter display format	Measure/beat



Tip! If a locate point has not been registered, the numerical field will indicate "--".

3 Move the cursor to the locate point value that you want to adjust, and turn the [DATA/JOG] dial to change the value.

Only in the case of the Start point, a "Change START Position?" popup window will ask you for confirmation when you attempt to change the value. Move the cursor to the OK button and press the [ENTER] key, and then change the value.



Note Changing the Start point will mean that locations already recorded in a track will move relative to the measure lines defined by the tempo map. Please be aware of this if you are using measure display for the metronome or for the quick loop sampler.

4 To adjust the location of a marker, move the cursor to the MARKER button in the display and press the [ENTER] key.

When the MARKER button is on, the POINT page will list the markers that have been registered.

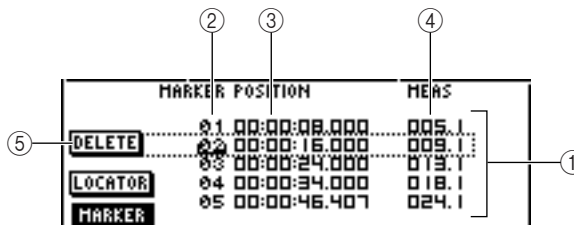

① **List**

Lists the markers that have been registered. The line that is enclosed by a dotted frame is selected for operations.

② **MARKER**

These are the marker numbers 01–99.

③ **POSITION**

Shows the position of each marker, in the counter display format.

- ④ **MEAS**
Shows the position of each marker, in measure/beat units.
- ⑤ **DELETE button**
To delete the currently selected marker, move the cursor to this button and press the [ENTER] key.
- 5 Move the cursor to the **MARKER** area, and turn the [DATA/JOG] dial to scroll the list so that the dotted frame encloses the marker number that you want to edit.
- 6 Move the cursor to the value that you want to edit, and turn the [DATA/JOG] dial to edit the value.

Note

You cannot change the location beyond the next or previous marker.

Erasing a locate point or marker

If necessary, you can erase a previously-registered locate point (except for the Relative Zero, Start, and End points) or marker.

Note

A locate point that you erase cannot be recovered.

■ Erasing a locate point

To erase a locate point, hold down the [CANCEL] key in the Locate section, and press the corresponding locate key ([IN]/[OUT] key, [A]/[B] key). That locate point will be erased, and a message of "LOCATE POINT ERASED" will be displayed for a time.

■ Erasing a marker

You can erase a marker in one of two ways; using key operations, or in the screen.

To erase a marker using key operations, locate to the marker that you want to erase. Then hold down the [CANCEL] key of the Locate section and press the [MARK] key. The corresponding marker will be erased, and a message of "MARK POINT ERASED" will be displayed for a time.

To erase a marker by operations in the screen, access the list of markers in the POINT page of the SONG screen, select the marker that you want to erase, move the cursor to the DELETE button and press the [ENTER] key.

Repeatedly playing a specific region (the A-B Repeat function)

The AW16G provides an “A-B Repeat” function that repeatedly plays the region between the A point and B point. This is useful when you want to repeatedly play back a certain region of the song while you adjust the mix.

- 1 Register the A point and B point to the locations at which you want the repeated playback to start and end.

For details on how to set the A point and B point, refer to “Using markers” (→ p. 67).



Tip! *If you set the B point earlier than the A point, the B → A region will play repeatedly.*

- 2 While the transport is stopped, press the [REPEAT] key.

The [REPEAT] key will light, and the A-B Repeat function will be on. The song will automatically locate to the A point.



Note *The A and B points must be at least one second apart. If they are closer than this, a message of “REPEAT POINTS TOO CLOSE” will appear when you press the [REPEAT] key, and repeat playback will not be possible.*

- 3 To begin repeat playback, press the PLAY [▶] key.

Playback will begin from the A point. When you reach the B point, you will automatically return to the A point and continue playback.



- Playback will stop automatically when the A/B region has been repeated 99 times.
- If you press the [REPEAT] key while the song is playing, repeat playback between the A and B points will begin automatically, regardless of the current position.

- 4 To stop playback, press the STOP [■] key.

Playback will stop, but the A-B Repeat function will remain turned on.

When the A-B Repeat function is on, pressing the PLAY [▶] key will immediately resume repeat playback, regardless of the current position.

- 5 To cancel repeat playback, press the [REPEAT] key.

The [REPEAT] key will go dark, and the A-B Repeat function will be cancelled. If you cancel the A-B Repeat function during repeat playback, normal playback will occur from that point.



Tip! *If you perform a recording operation while the A-B Repeat function is on, the A-B Repeat function will be temporarily disabled.*

Finding a location while you listen to the sound (the Nudge function)

“Nudge” is a function that repeatedly plays a short region before or after the current location. By using the Nudge function, you can find a precise location while listening to the playback. This is useful when you need to specify a location precisely, such as when specifying the auto punch-in/out points, or when editing the contents of a track.

1 Locate to the vicinity of the point you want to find.

2 With the transport stopped, press the [JOG ON] key.

The [JOG ON] key will light, and the Nudge function will be turned on. A fixed region (referred to as the “nudge time”) starting at the current location will play repeatedly.

3 To move the current location forward, turn the [DATA/JOG] dial toward the right. To move the current location backward, turn the [DATA/JOG] dial toward the left.

If time display is selected as the counter display format, you can move the current location forward or backward in millisecond units. If time code display is selected, you can move in sub-frame units.

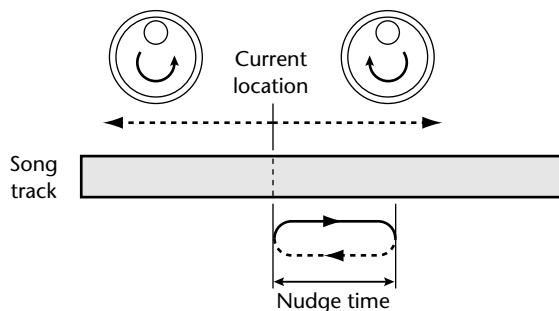

Tip! Even while using the Nudge function, you can use locate points or markers to change the location, or register locate points or markers (→ p. 65).

4 To turn off the Nudge function, press the [JOG ON] key or the transport section STOP [■] key.

The [JOG ON] key will go dark, and the Nudge function will be turned off.

5 If you want to change the playback duration or the playback mode, repeatedly press the Work Navigate section [UTILITY] key or hold down the [UTILITY] key and use the CURSOR [▲]/[▼] keys to access the PREFER page of the UTILITY screen.

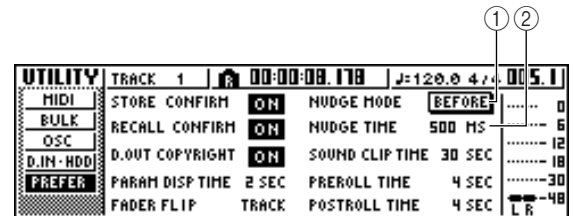

① NUDGE MODE

Specifies the region of sound (before or after the current location) that will be played by the Nudge function.

② NUDGE TIME

Specifies the duration of the region that will be played by the Nudge function.

6 To change the playback duration (nudge time), move the cursor to the value of the NUDGE TIME field, and use the [DATA/JOG] dial to set the nudge time.

You can set the nudge time in a range of 25 ms – 800 ms. (Default = 500 ms).

7 To change the playback position (nudge mode), move the cursor to the NUDGE MODE button, and press the [ENTER] key to switch between the following two nudge modes.

● **AFTER**

Repeatedly play for the duration of the nudge time, starting at the current location (default).

● **BEFORE**

Repeatedly play for the duration of the nudge time, ending at the current location.

NUDGE MODE: BEFORE

Current location

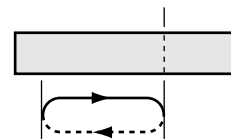

NUDGE MODE: AFTER

Current location

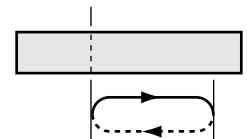

Note You cannot change the nudge time or nudge mode while using the Nudge function. You must turn off the Nudge function, and change these settings while the [JOG ON] key is dark.

Finding a location while you view the waveform

The AW16G lets you find a location while viewing the waveform of the sound recorded on the track.

- 1 Locate to the vicinity of the point you want to find.
- 2 Repeatedly press the Work Navigate section [TRACK] key or hold down the [TRACK] key and use the CURSOR[▲]/[▼] keys to access the VIEW page of the TRACK screen.



- 3 Move the cursor to the TRACK field, and turn the [DATA/JOG] dial to select the number of the track whose waveform you want to view.
- 4 Move the cursor to the WAVE button and press the [ENTER] key.

The WAVE DISPLAY popup window will appear. This popup window displays the waveform of the audio data recorded in the current track of the track (1–16) you selected in step 3.

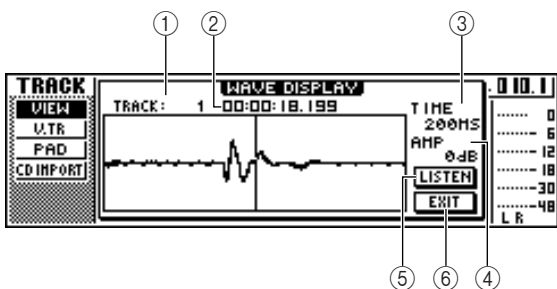

- ① **TRACK**
Indicates the currently selected track number. You can also move the cursor to this field and turn the [DATA/JOG] dial to switch tracks.
- ② **Counter**
Displays the location of the vertical line (pointer) indicating the current location in the WAVE DISPLAY popup window. You can move the cursor to this field and turn the [DATA/JOG] dial to move the current location forward or backward.
- ③ **TIME**
By moving the cursor to this area and turning the [DATA/JOG] dial, you can expand or shrink the waveform display in the time axis. The value of this field indicates the length of time displayed in the WAVE DISPLAY popup window.
If you select 1SEC, the distance from the left edge to the right edge of the screen will correspond to one second. Selecting SAMPLE will produce the highest magnification, and each horizontal pixel will correspond to one sample (1/44,100 second).

- ④ **AMP**
By moving the cursor to this area and turning the [DATA/JOG] dial, you can expand or shrink the waveform display in the amplitude axis. The value of this field indicates the level range of the waveform displayed in the WAVE DISPLAY popup window. If you select 0 dB, the top and bottom edges of the screen will correspond to the maximum level.

- ⑤ **LISTEN button**
If you move the cursor to this button and press the [ENTER] key, the waveform in the display area of the WAVE DISPLAY popup window will be played once. During playback, the vertical line (pointer) that indicates the current location will move, and the counter value will also change.

You cannot perform conventional transport operations when playing back by pressing the LISTEN button.

- ⑥ **EXIT button**
If you move the cursor to this button and press the [ENTER] key, you will exit the WAVE DISPLAY popup window and return to the previous VIEW page.



Tip! Even after displaying the WAVE DISPLAY popup window, you can use the [TRACK SEL] keys to switch the track for viewing.

- 5 As necessary, move the cursor to the TIME/AMP fields and turn the [DATA/JOG] dial to adjust the vertical and horizontal scale of the waveform display.

- 6 To specify a location within the popup window, move the cursor to the counter and turn the [DATA/JOG] dial.

Turning the dial toward the right will move the pointer forward, and turning the dial toward the left will move it backward. If necessary, you can use the LISTEN button to play the waveform region shown in the WAVE DISPLAY popup window, and check the location by listening.



- You can also change the pointer position by using the locate points or markers that are registered in the song (→ p. 65, 67).
- The position displayed in the counter can be registered as a locate point or marker (→ p. 65, 67).

- 7 When you have finished specifying the location, move the cursor to the EXIT button and press the [ENTER] key.

You will return to the previous VIEW page, and the location that you specified in the popup window will remain the current location. As desired, register the location as a locate point or marker.

Chapter 8

Using libraries and scene memories

This chapter explains how to use libraries and scene memories.

About the libraries

Memory areas that store settings for sections such as EQ, dynamics, and effects are called “libraries.” By recalling (loading) data from a library, you can instantly use the desired set of settings. Most types of library also let you store the current settings. The AW16G provides the following libraries.

- **Input channel library**
EQ, dynamics, and internal effect settings can be loaded from this library into the currently selected input channel. This library is read-only, and cannot be used to store your own settings.
- **EQ library**
EQ settings can be loaded from this library into the currently selected channel.
- **Dynamics library**
Dynamics settings can be loaded from this library into the currently selected channel.
- **Effect library**
Effect settings can be loaded from this library into internal effects 1/2.
- **Mastering library**
EQ and dynamics settings can be loaded from this library into the stereo channel. This library is read-only, and cannot be used to store your own settings.
- **Sample library**
Sets of samples can be loaded from this library into the Quick Loop Sampler.
- **Channel library**
Major mix parameters can be loaded from this library into a channel.

About scene memories

On the AW16G, settings for the mix parameters of all channels and the effect parameters etc. can be stored in internal memory as a “scene” with the name you specify.

When you recall one of the various libraries described above, the library settings you recall will be loaded into the settings that you are currently using (referred to as the “current scene”). You can then save the current settings as a scene memory, which will contain the settings that you loaded from a library. Libraries and scene memories are saved on the hard disk as part of the song.

The following diagram shows how libraries, scene, and the song are related to each other on the AW16G.

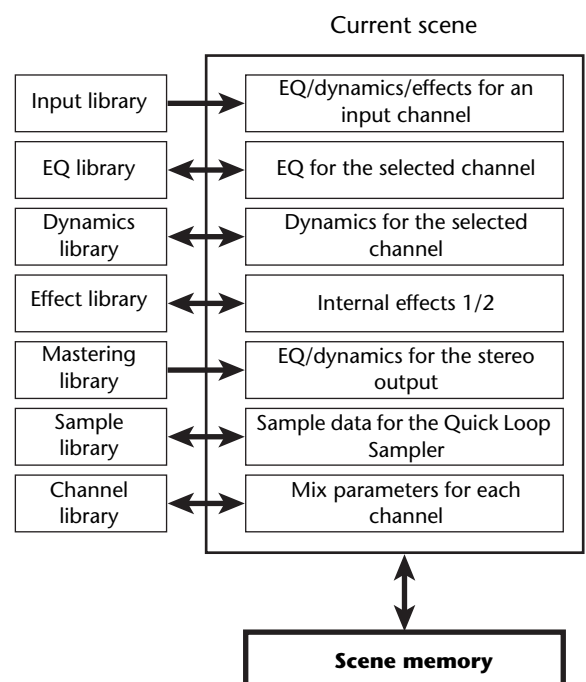

Basic operation for libraries and scene memories

Here are the basic procedures for recalling and storing a library or scene.

Storing library or scene data

Here's how to store the current settings in a library or scene memory.



The input library and mastering library, and the EQ, dynamics, or effect libraries accessed from the INPUT SETTING popup window are all read-only, and therefore have no STORE button.

1 Access the desired library page or the scene memory page.

For details on how to access each library or scene memory page, refer to the explanations on page 77 and following. The illustration below shows an example of when you have selected the LIBRARY page of the EQ screen.

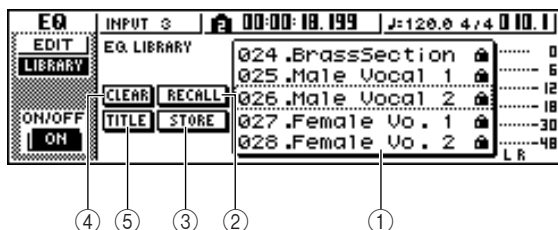

① List

This area lists the data stored in the library or scene memory. The line enclosed by the dotted frame indicates the data that is selected for operations. Read-only data is indicated by a "lock" icon.

② RECALL button

Recalls the library data or scene that is selected in the list.

③ STORE button

Stores the current settings into the location selected in the list.

④ CLEAR button

Deletes the library or scene that is selected in the list.

⑤ TITLE button

Accesses the TITLE EDIT popup window, where you can edit the name of the library or scene selected in the list.



For some libraries or scene memories, buttons other than those listed here may appear, or some of these buttons may not appear. For details, refer to the explanations on page 77 and following.

2 Turn the [DATA/JOG] dial to scroll the list so that the dotted frame encloses the library or scene to which you want to store the data.

Regardless of where the cursor is located, turning the [DATA/JOG] dial will scroll the list.

3 Move the cursor to the STORE button and press the [ENTER] key.

The TITLE EDIT popup window will appear, allowing you to assign a name to the data.



- If you selected read-only data (indicated by a "lock" icon) in step 2, a message of "Read Only" will appear, and it will not be possible to execute the Store operation.
- Scene number 00 is read-only data used to initialize the current scene. Scene numbers 01–96 are writable data.

4 Assign a name to the data as desired. Then move the cursor to the OK button and press the [ENTER] key. (For details on how to assign a name → p. 24)

The library or scene will be stored.



You have the option of making settings so that the TITLE EDIT popup window does not appear when you perform the Store operation. For details, refer to "Overall settings for the AW16G" (→ p. 162).

Recalling library or scene data

Here's how to recall (load) settings from a library or scene.

- 1 Access the desired library or scene memory page.

For details on how to access each library or scene memory page, refer to the explanations on page 77 and following.

The illustration below shows an example of when you have selected the LIBRARY page of the EQ screen.

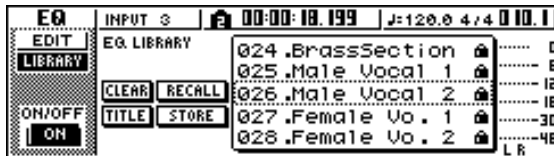

- 2 Turn the [DATA/JOG] dial to scroll the list so that the library data or scene you want to recall is enclosed by the dotted frame.

- 3 Move the cursor to the RECALL button, and press the [ENTER] key.

A popup window will ask you to confirm the Recall operation.

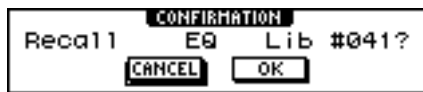

- 4 To execute the recall, move the cursor to the OK button and press the [ENTER] key.

The library or scene will be recalled.



Tip! You have the option of making settings so that the confirmation popup window does not appear when you perform the Recall operation. For details, refer to "Overall settings for the AW16G" (→ p. 162).

Deleting library or scene data

Here's how you can delete unwanted library or scene memory data.



Note The input library and mastering library, and the EQ, dynamics, and effect libraries accessed from the INPUT SETTING popup window are all read-only, and do not have a CLEAR button.

- 1 Access the page for the desired library or scene memory.

The illustration below shows an example of when you have selected the LIBRARY page of the EQ screen.



- 2 Turn the [DATA/JOG] dial to scroll the list so that the library data or scene you want to delete is enclosed by the dotted frame.

- 3 Move the cursor to the CLEAR button and press the [ENTER] key.

A popup window will appear, asking you to confirm the Delete operation.

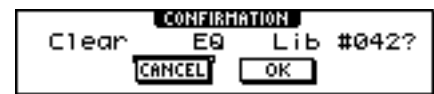

Note If you selected read-only data (indicated by a "lock" icon) in step 2, a message will indicate "Read Only," and the Delete operation will not be executed.

- 4 To execute the Delete operation, move the cursor to the OK button and press the [ENTER] key.

The library or scene will be deleted.

Naming library or scene data

Here's how you can assign a new name to existing library or scene data.

Note

The input library and mastering library, and the EQ, dynamics, or effect libraries accessed from the INPUT SETTING popup window are all read-only, and therefore have no TITLE button.

- 1 Access the page for the desired library or scene memory.

The illustration below shows an example of when you have selected the LIBRARY page of the EQ screen.



- 2 Turn the [DATA/JOG] dial to scroll the list so that the library data or scene you want to rename is enclosed by the dotted frame.

- 3 Move the cursor to the TITLE button and press the [ENTER] key.

The TITLE EDIT popup window will appear.



Note

If you selected read-only data (indicated by a "lock" icon) in step 2, a message of "Read Only" will appear, and you will be unable to edit the name.

- 4 Assign a name to the data. Then move the cursor to the OK button and press the [ENTER] key. (For details on assigning a name → p. 24)

The edited name will be finalized.

Details on libraries and scene memory

This section explains how to access each type of library or scene memory, and describes the functions that are unique to each of these screens.

Input library

From this library you can recall EQ, dynamics, and internal effect settings to the currently selected input channel. Use this when you want to apply EQ, dynamics, and internal effects to the input signal that you are recording. Library numbers 00–40 are all read-only, and 00 is data for initializing an input channel.

In order to use the input library, you will need to insert internal effect 1 or 2 into that input channel.

■ Recalling input library data

- 1 Press and hold the [INPUT SEL] key for the desired input channel.

The INPUT SETTING popup window will appear.

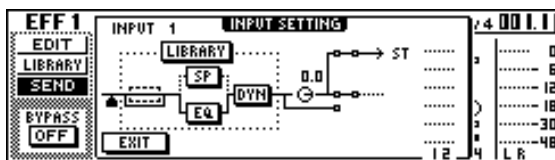

- 2 Move the cursor to the LIBRARY button and press the [ENTER] key.

A popup window will ask you whether you want to insert internal effect 1 or 2 into that input channel.

This popup window will change as follows, depending on how internal effects 1/2 are being used.

- If the song is in the default state

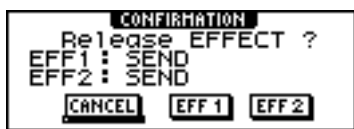

- If effect 1 is already inserted into a specific input channel



- If effects 1 and 2 are already inserted into specific input channels



Tip! If an effect has already been inserted into that input channel, the INPUT LIBRARY popup window will appear immediately.

- 3 Move the cursor to the EFF1 or EFF2 button and press the [ENTER] key.

The corresponding insert effect will be inserted into the input channel, and the INPUT LIBRARY popup window will appear.

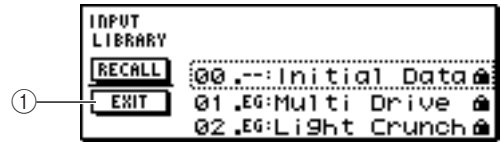

- ① EXIT button

Closes the popup window and returns to the previous INPUT SETTING popup window.

EQ library

From this library you can recall EQ settings to the currently selected channel. Of library numbers 001–128, numbers 001–040 are read-only, and 041–128 can be written.

■ Recalling EQ library data

- 1 Use the [INPUT SEL] keys, [TRACK SEL] keys, [STEREO SEL] key, or pads 1–4 to select the channel into which you want to recall the EQ settings.

- 2 Perform one of the following actions to access the LIBRARY page of the EQ screen

- Press the [EQ] knob repeatedly
- Hold down the [EQ] knob and press the CURSOR [▲]/[▼] keys
- Hold down the [EQ] knob and turn it to left or right

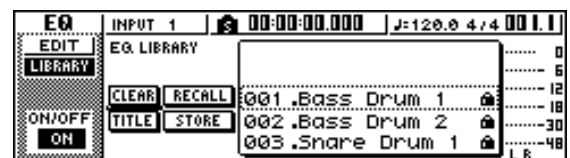

You can also recall EQ library data into an input channel directly from the INPUT SETTING popup window. To do so, move the cursor to the EQ button in the window and press the [ENTER] key.

Dynamics library

From this library you can recall dynamics settings to the currently selected channel. Of library numbers 001–128, numbers 001–040 are read-only, and 041–128 can be written.

■ Recalling dynamics library data

1 Use the [INPUT SEL] keys, [TRACK SEL] keys, [STEREO SEL] key, or pads 1–4 to select the channel into which you want to recall the dynamics settings.

2 Perform one of the following actions to access the LIBRARY page of the DYN screen

- Press the [DYN] knob repeatedly
- Hold down the [DNY] knob and press the CURSOR [▲]/[▼] keys
- Hold down the [DYN] knob and turn it to left or right

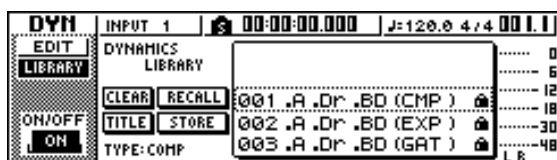

You can also recall dynamics library data into an input channel directly from the INPUT SETTING popup window. To do so, move the cursor to the DYN button in the window and press the [ENTER] key.

Effect library

This library is used by internal effects 1/2. Of library numbers 001–128, numbers 001–041 are read-only, and 042–128 can be written.

■ Recalling effect library data

1 Perform one of the following actions to access the LIBRARY page of the EFFECT 1/2 screen

- Press the [EFFECT 1] or [EFFECT 2] knob repeatedly
- Hold down the [EFFECT 1] or [EFFECT 2] knob and press the CURSOR [▲]/[▼] keys
- Hold down the [EFFECT 1] or [EFFECT 2] knob and turn it to left or right

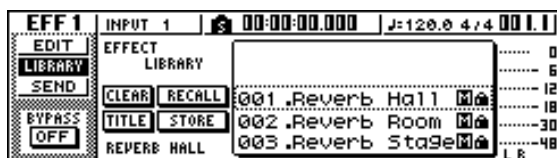

You can also recall library data for an effect that has been inserted in the input channel directly from the INPUT SETTING popup window. To do so, move the cursor to the EFF1 or EFF2 button in the window and press the [ENTER] key.

Note

- The [M] symbol indicates monaural input, and [S] indicates that stereo input is supported. If an effect indicated by [M] is inserted into paired channels (such as the stereo output channel), the sense of stereo will be lost.
- 019. HQ.Pitch cannot be recalled to effect 1.

Mastering library

This library contains settings used to apply EQ and dynamics processing to the stereo output channel during mixdown. It contains EQ and dynamics settings suitable for processing the final mix. All library numbers 00–13 are read-only, and 00 is data for initializing the stereo output channel.

■ Recalling mastering library data

1 Repeatedly press the [RECORD] key or hold down the [RECORD] key and use the CURSOR [▲]/[▼] keys to access the MIXDOWN page of the RECORD screen.

2 Move the cursor to the LIBRARY button in the screen, and press the [ENTER] key.

The MASTERING LIBRARY popup window will appear.

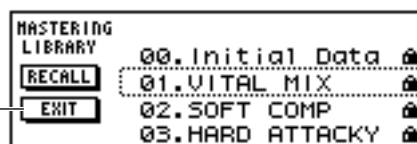

① EXIT button

Closes the popup window and returns to the previous MIXDOWN page.

Sample library

This library contains sets of up to sixteen samples for use with the Quick Loop Sampler. Sets of drum loop or sound-effect samples are saved on the hard disk as sample libraries. When you recall one of these, those samples will be assigned to the pads and sample banks, so you can immediately play them from the pads.

Note

Unlike the other libraries, the sample library data is shared by all songs.

■ Recalling sample library data

Repeatedly press the Quick Loop Sampler section [SAMPLE EDIT] key or hold down the [SAMPLE EDIT] key and use the CURSOR [▲]/[▼] keys to access the LIBRARY page of the SAMPLE screen.

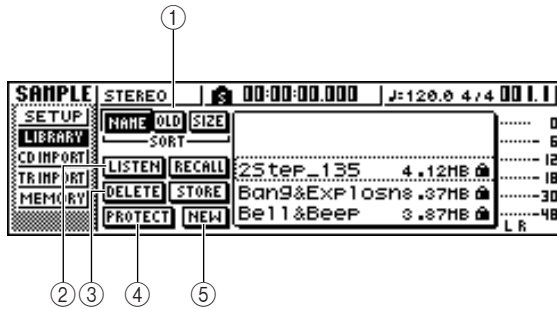

① SORT field

Use these three buttons to specify how the library data in the list will be sorted. You can choose NAME (sort alphabetically), OLD (sort by save date), or SIZE (sort by size).

② LISTEN button

If you move the cursor to this button, press the [ENTER] key, and then press a pad, the sample assigned to sample bank A of the library will play.

③ DELETE button

Deletes the selected library data from the hard disk.

④ PROTECT button

When you move the cursor to this button and press the [ENTER] key, the Protect setting will be switched on/off for the library data selected in the list. Library data for which Protect is turned on is indicated by a “lock” icon, and cannot be edited or deleted.

⑤ NEW button

Creates new library data on the hard disk.

Channel library

This library contains mix parameter settings that can be loaded into a channel. It is convenient to use this library when you want to use the settings of a specific channel for another channel. Library numbers 00–01 are read-only data for initializing a channel, and 02–64 can be written.

Channel library data contains the following parameters.

- Channel on/off
- Attenuator
- EQ on/off
- EQ parameter settings
- Dynamics processor on/off
- Dynamics processor parameter settings
- Fader position
- Aux buses 1/2 pre-fader/post-fader setting
- Send levels to Aux buses 1/2
- Effect buses 1/2 pre-fader/post-fader setting
- Send levels to effect buses 1/2

■ Recalling channel library data

Repeatedly press the Selected Channel section [VIEW] key or hold down the [VIEW] key and use the CURSOR [▲]/[▼] keys to access the CH LIB page of the VIEW screen.

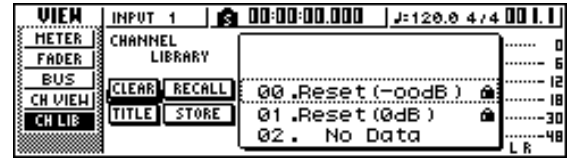

- Data for parameters that do not exist in the recall-destination channel will be ignored.
- If the recall-destination is the stereo output channel or a paired channel, the parameters will be the same for the L and R channels, with the exception of Phase and Pan (phase and pan settings will not change).

Scene memories

Scene memories recall the effect parameter and mix parameter settings of all channels.

Scene number 00 is read-only data used to initialize the current scene. Scene numbers 01–96 are writable data.

■ Recalling a scene memory

In the data entry/control section, repeatedly press the [SCENE] key or hold down the [SCENE] key and use the CURSOR [▲]/[▼] keys to access the LIBRARY page of the SCENE screen.

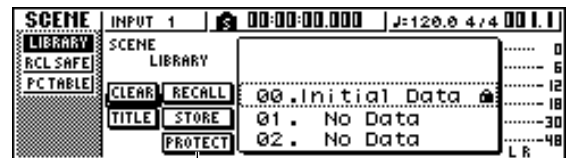

①

① PROTECT button

When you move the cursor to this button and press the [ENTER] key, the Protect setting will be switched on/off for the scene selected in the list. Scene data for which Protect is turned on is indicated by a “lock” icon, and cannot be edited or deleted.

Using the Recall Safe function

You can specify that specific faders or specific channels will be excluded from Recall operations when the scene is changed either manually or from an external MIDI device. This function is called "Recall Safe."

For example, this is convenient if you are performing a mixdown while switching scenes, but want to control specific channels manually.

- 1 In the data entry/control section, repeatedly press the [SCENE] key or hold down the [SCENE] key and use the CURSOR [▲]/[▼] keys to access the RCL SAFE page of the SCENE screen.

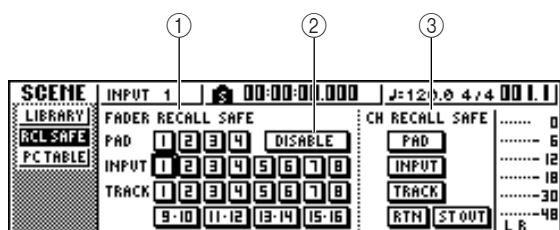

① FADER RECALL SAFE

Here you can select the fader(s) for which recall safe will be enabled. The fader(s) you select here will not change even when another scene is recalled. These buttons correspond to the faders as follows.

PAD 1-4..... Pad channel 1-4 faders
INPUT 1-8..... Input channel 1-8 faders
TRACK 1-8,
9-10-15-16 Track channel 1-8 and 9/10-15/16 faders

② ENABLE/DISABLE button

This button switches Fader Recall Safe between ENABLE and DISABLE states. Move the cursor to this button and press the [ENTER] key to switch the display between ENABLE and DISABLE.

③ CH RECALL SAFE

Selects the channel(s) for which Recall Safe will be enabled. Mix parameters of the selected channel(s) will not change even when another scene is recalled. The buttons correspond to the following channels.

PAD..... All pad channels
INPUT..... All input channels
TRACK All track channels
RTN..... Return channels 1/2
ST OUT..... Stereo output channel

- 2 Select the fader(s) or channel(s) that you want to set to Recall Safe, and turn the corresponding button(s) on (highlighted).

- 3 If you selected a fader in step 2, move the cursor to the ENABLE/DISABLE button and press the [ENTER] key to switch the display to ENABLE.

Fader or channel Recall Safe has now been enabled. The selected fader(s) and/or channel(s) will not be affected by scene recall operations until you change this setting.



Tip! The settings of the RCL SAFE page are shared by all songs.

Chapter 9

Mixdown and bounce operations

This chapter explains mixdown operations, in which you mix previously-recorded tracks and record the result on the stereo track. This chapter also explains how you can use bounce (ping-pong) recording to combine multiple tracks to one or two tracks.

About mixdown and bouncing

“Mixdown” is the process by which the signals recorded on the recorder tracks are mixed to stereo, and recorded on the internal stereo track to complete the song. The contents of the stereo track can be used without further processing as material to create an audio CD.

The diagram below shows the signal flow during mixdown. The playback of each track is sent to the stereo bus, passes through the stereo output channel, and is recorded on the stereo track. At this time you also add the signals from pad channels 1–4 and input channels 1–8.

● Signal flow during mixdown

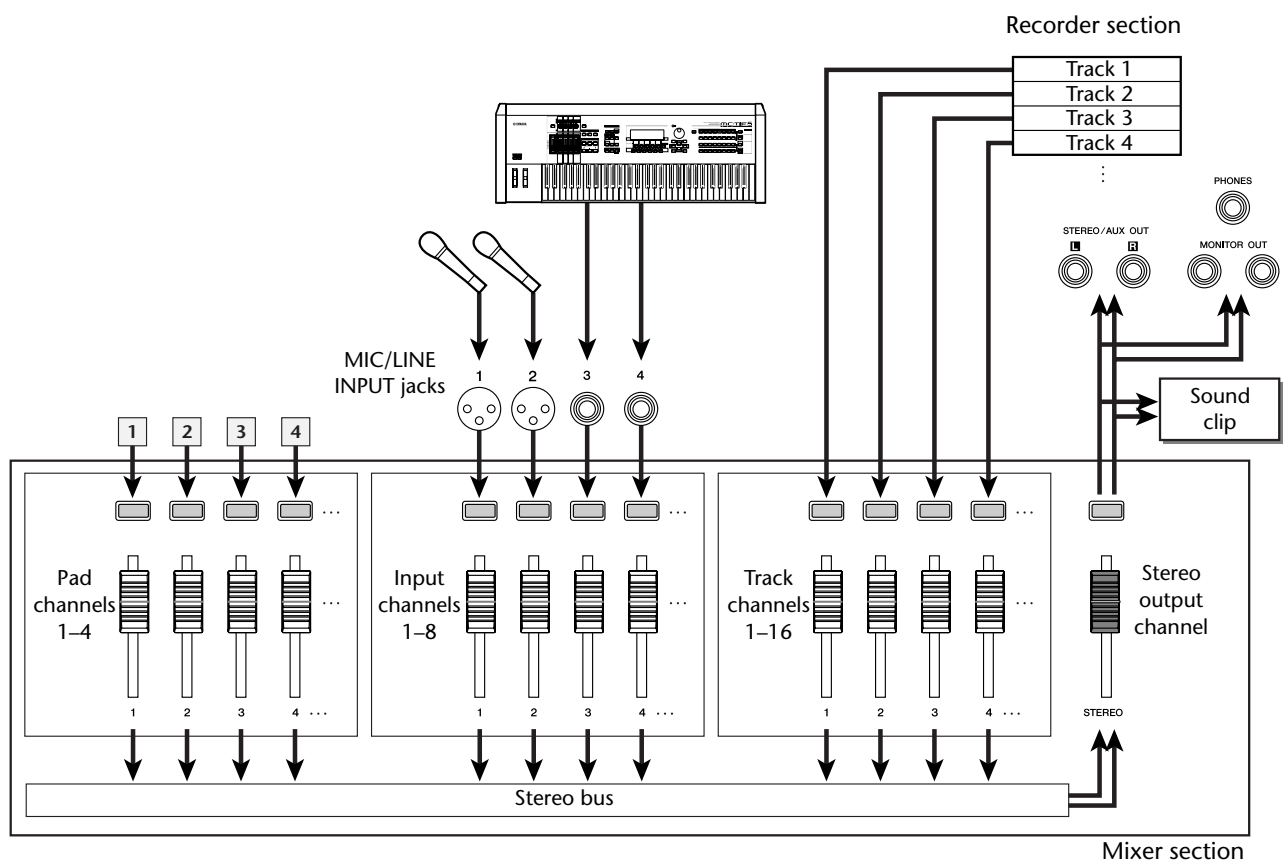

“Bounce” is the process by which the signals recorded on multiple tracks are mixed to the stereo bus, and re-recorded on one or two other tracks. (This process is also called “ping-pong recording.”)

The diagram below shows the signal flow during bouncing. This process differs from mixdown in several points; you use the L/R bus instead of the stereo bus, only the track channels are the recording sources, and that the recording-destination is one or two vacant tracks. This diagram shows an example in which the track 1–8 signals are bounced to tracks 9/10. After bouncing, you can switch the virtual tracks for tracks 1–8, and use these tracks to record other instrumental performances.

● Signal flow during bouncing

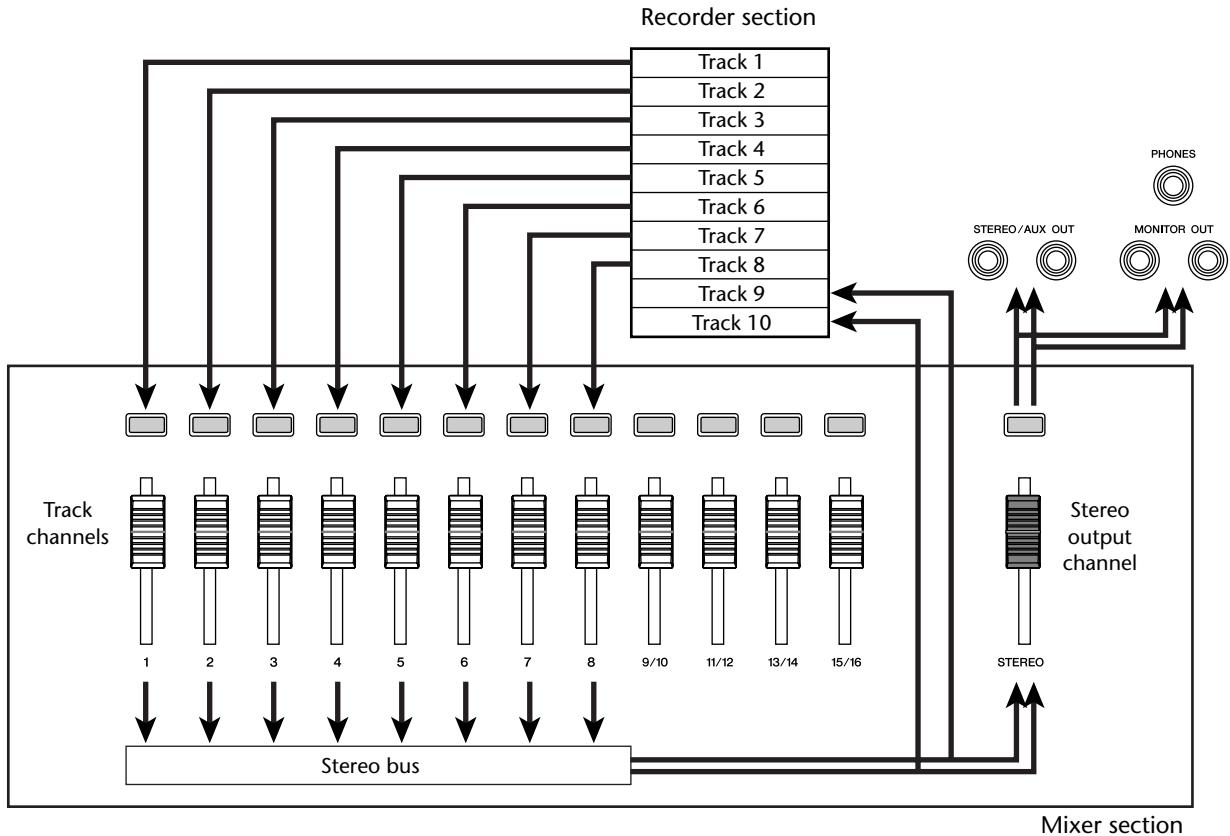

Preparing for mixdown

To prepare for mixdown, select the track channels that you will mix down, and adjust the balance and tone of each track.

1 Lower the [STEREO] fader to the ∞ position.

2 In the Quick Navigate section, repeatedly press the [RECORD] key or hold down the [RECORD] key and use the CURSOR [\blacktriangle]/[\blacktriangledown] keys to access the MIXDOWN page of the RECORD screen.

The MIXDOWN page is where you can perform mixdown operations. In this page you can select the channels that will be recorded via the stereo bus onto the stereo track.

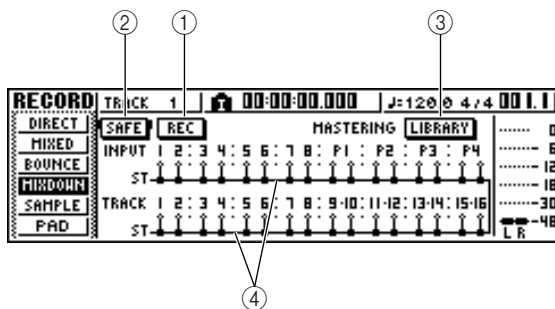

1 REC button

Puts the stereo track in record-ready mode.

2 SAFE button

Defeats the record-ready state of the stereo track.

3 LIBRARY button

Accesses the mastering library.

4 Stereo bus

Indicates the on/off status of the channels being sent to the stereo bus. The numbers within the screen correspond to the following channels.

INPUT 1-8..... Input channels 1-8

P1-P4..... Pad channels 1-4

TRACK 1-16 Track channels 1-16

3 Use the [INPUT SEL] keys, [TRACK SEL] keys, and pad keys 1-4 to select the channels that you want to send to the stereo bus.

The screen will change as follows each time you press a key or pad repeatedly.



- All channels will be turned on by default. However in order to obtain the best S/N ratio, you should turn off any channels that you are not using.
- You can also add the signals of the input channels or pad channels to the mixdown (\rightarrow p. 89).

4 If you want to use the mastering library, move the cursor to the LIBRARY button and press the [ENTER] key.

The MASTERING LIBRARY popup window will appear. Turn the [DATA/JOG] dial to select the desired library data, then move the cursor to the RECALL button and press the [ENTER] key.



The mastering library contains data for loading EQ/dynamics settings into the stereo output channel. (For details, refer to \rightarrow p. 78)

5 If you want to adjust the pan of each track channel, repeatedly press the Selected Channel section [PAN/BAL] knob or hold down the [PAN/BAL] knob and use the CURSOR [\blacktriangle]/[\blacktriangledown] keys to access the PAN page of the PAN screen.

In this page you can set pairing, phase, and pan for each channel.

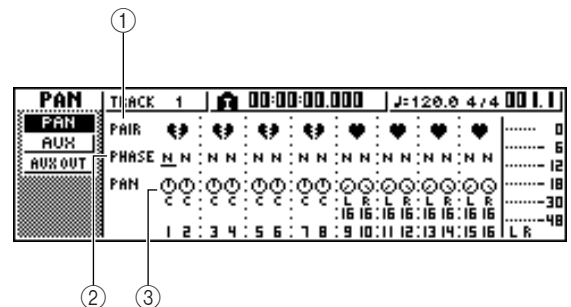

1 PAIR

Indicates the paired status of adjacent odd-numbered/even-numbered channels. A heart symbol indicates channels that are paired, and a broken heart symbol indicates channels that are not paired. You can also set or defeat pairing in this page by moving the cursor to a heart symbol and pressing the [ENTER] key.



Track channels 9/10-15/16 and pad channels 1-4 always function as paired channels. Pairing cannot be defeated for these channels.

2 PHASE

Switches the phase of the signal of each channel between normal and reversed. Move the cursor to this location and press the [ENTER] key to switch between N (Normal) and R (Reverse) phase.

3 PAN

Adjusts the pan (the left/right position when the signal is sent to the stereo bus or L/R bus) of each channel.

Note

- If the page is different than shown above, make sure that you have selected track channels as the object of operations. (This is indicated in the upper left of the screen.) If input channels and pad channels are selected, press any one of the [TRACK SEL] keys.
- Even if channels are paired, their phase and pan are not linked. Set these parameters individually for each channel.

6 Move the cursor to the PAN knob of each track channel, and turn the [DATA/JOG] dial to adjust the pan setting.

Tip!

Another way of adjusting the pan is to press a [TRACK SEL] key to select a track channel, and then turn the [PAN/BAL] knob in the Selected Channel section. This method is convenient when you want to adjust the pan without displaying a different screen. If you use the [PAN/BAL] knob to adjust the pan of track channels 9/10–15/16, moving the knob will initially cause only the pan value of one side to change. When that pan value reaches the far right or left, the other pan value will then begin to change.

7 Raise the [STEREO] fader to the 0 dB position.

8 While you play back the song, raise the track channel faders to an appropriate level. If necessary, adjust the EQ and dynamics of each track channel.

You can adjust the track channel EQ/dynamics in a similar way as for the input channels; press a [TRACK SEL] key to select a track channel, and use the Selected Channel section [EQ] knob and [DYN] knob.

Using the internal effects via send/return

You can use the internal effects via send/return to add effects to the mixdown. As an example, here's how to use internal effect 1 in this way.

Internally connecting an internal effect via send/return

The "Track recording" chapter explained how to insert an internal effect into an input channel by using the input library. If an insert effect has been inserted in a channel, you must first "un-insert" that effect (cancel the insertion) before you can use it in a send/return configuration.

- 1** Press any [INPUT SEL] key to select an input channel for operations.
- 2** Repeatedly press the [EFF1] knob or hold down the [EFF1] knob and use the CURSOR [▲]/[▼] keys to access the SEND page of the EFF1 screen.

The SEND page of the EFF1 screen will appear.

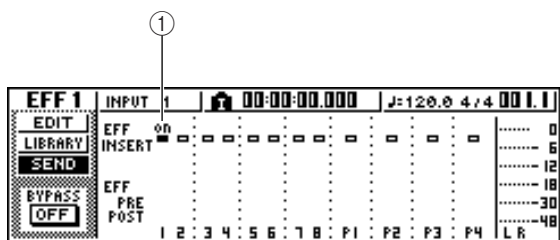

1 EFF INSERT

Inserts/cancels an insert effect for a specific channel. The display will indicate "on" for a channel into which an effect is currently inserted.

Tip!

If the page you see is different than shown above, make sure that input channels are selected as the object of your operations. (This is shown in the upper left of the screen.) If track channels are selected, press one of the [INPUT SEL] keys.

3 Move the cursor to the EFF INSERT field of the channel into which effect 1 is inserted, and press the [ENTER] key.

A popup window will ask you to confirm that you want to cancel (release) the effect insertion.



4 Move the cursor to the OK button and press the [ENTER] key.

Insertion of insert effect 1 into that channel will be cancelled, and now you are free to use this effect in the mixer section via send/return.

■ Adjusting the effect send level

Here's how to load an effect library into internal effect 1, and adjust the level (effect send level) of the signal that is sent from each channel via effect bus 1 to internal effect 1.

1 Repeatedly press the [EFF1] knob or hold down the [EFF1] knob and use the CURSOR [▲]/[▼] keys to access the LIBRARY page of the EFF1 screen.

2 Select the effect library that you want to use, and load it into internal effect 1.

In this example, we will select a reverb-type library.



3 Press the [EFF1] knob once to access the SEND page of the EFF1 screen.

If insert effect 1 is connected via the mixer section send/return, the following items will be added to the SEND page of the EFF1 screen.

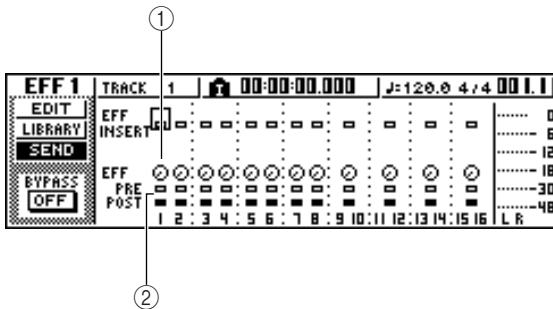

① EFF
Adjusts the send level of the signal that is sent from each channel to insert effect 1.

② PRE/POST
Selects the location from which the signal from each channel will be sent to insert effect 1. Move the cursor to this area and press the [ENTER] key to switch between the following two settings.

PRE (pre-fader) The signal from immediately before the fader will be sent.

POST (post-fader) The signal from immediately after the fader will be sent.

Note

If the page you see is different than shown above, make sure that track channels are selected as the object of your operations. (This is shown in the upper left of the screen.) If input channels/pad channels are selected, press one of the [TRACK SEL] keys.

4 Move the cursor to the PRE/POST field in the screen, and press the [ENTER] key to specify the location from which the signal will be sent from each channel to internal effect 1.

Select POST if you want the volume of the effect sound to be affected by the fader position. Select PRE if you want to set the volume of the effect sound independently of the fader position.

5 While you play back the song, move the cursor to the EFF knobs in the screen, and adjust the level of the signal that is sent from each channel to internal effect 1.

Tip!

Another way of adjusting the send level to internal effect 1 is to press a [TRACK SEL] key to select a track channel, and then turn the [EFF1] knob of the Selected Channel section. This method is convenient if you want to adjust the effect level without displaying a different screen.

6 To adjust the master level of the effect send, repeatedly press the Selected Channel section [VIEW] key or hold down the [VIEW] key and use the CURSOR [▲]/[▼] keys to access the BUS page of the VIEW screen.

The BUS page of the VIEW screen lets you use on-screen faders to adjust the master level of each bus.

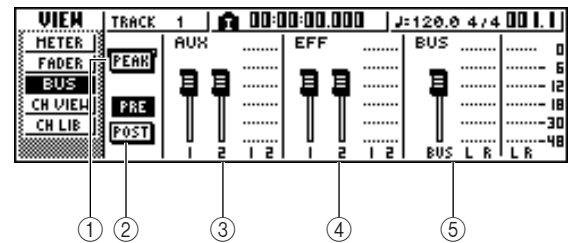

① PEAK button

This is an on/off switch for the peak hold function of the level meters. If this button is on, a peak indicator will show the level meter peaks, and will remain displayed. To reset this indicator, you can temporarily switch the PEAK button off. This setting is shared with the METER page of the VIEW screen.

② PRE/POST button

This selects whether the level meters of the BUS page will indicate the pre-fader level (PRE) or the post-fader level (POST). This setting is independent from the METER page of the VIEW screen.

③ AUX

④ EFF

⑤ BUS

Use these faders to adjust the master levels of AUX buses 1/2, effect buses 1/2, and the L/R bus. The level of each bus is indicated by the level meters at the right of each fader.

7 Move the cursor to the fader for effect bus 1, and use the [DATA/JOG] dial to raise or lower it.

Tip!

You can also adjust the level of the return signal that is returned from the internal effect to the mixer section. For details, refer to "Editing the parameters of an internal effect" (→ p. 94).

Recording on the stereo track

Here's how to record the final mix on the stereo track.

- 1 In the Quick Navigate section, repeatedly press the [RECORD] key or hold down the [RECORD] key and use the CURSOR [▲]/[▼] keys to access the MIXDOWN page of the RECORD screen.

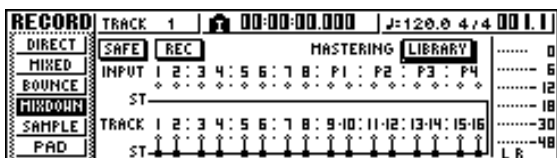

- 2 Move the cursor to the REC button of the MIXDOWN page, and press the [ENTER] key to turn the button on.

The panel [STEREO] key will blink red. This blinking indicates that the stereo track is in record-ready mode.

- 3 Press the RTZ [◀◀] key to rewind the song. Then hold down the REC [●] key and press the PLAY [▶] key.

The song will begin playing, and the playback will be recorded on the stereo track.



Tip! The data that is recorded here on the stereo track will be the data that is used to create an audio CD. If you want to precisely specify the beginning or end of the song, it is convenient to use Auto Punch-in/out (→ p. 59).

- 4 When you reach the end of the song, move the cursor to the SAFE button in the screen and press the [ENTER] key.

A popup window will ask you to confirm that you want to cancel record-ready mode. Move the cursor to the OK button and press the [ENTER] key.

- 5 To play back the stereo track, repeatedly press the Quick Navigate section [MONITOR] key or hold down the [MONITOR] key and use the CURSOR [▲]/[▼] keys to access the ST.TRACK page of the MONITOR screen.

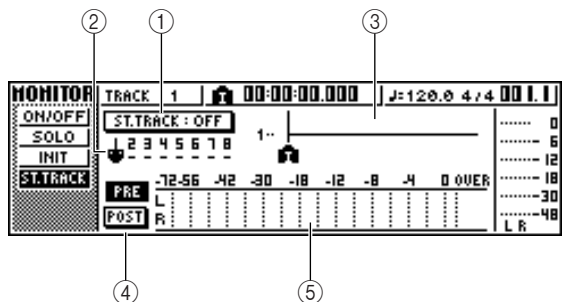

- ① **ST.TRACK ON/OFF button**
Switches stereo track playback on/off.
- ② **Virtual track**
Selects the virtual track that is assigned to the stereo track. The currently selected virtual track is indicated by a "●." Of the other virtual tracks, those that have already been recorded are indicated by "○," and the unrecorded tracks are indicated by "-".

- ③ **Track view**
In this area, markers and the presence or absence of track data are displayed graphically.

- ④ **PRE/POST buttons**
These buttons select whether the level meter in the ST.TRACK page will indicate the pre-fader level (PRE) or the post-fader level (POST). This setting is shared with the BUS page of the VIEW screen.

- ⑤ **Level meter**
This indicates the output level of the stereo track.

- 6 Switch the ST.TRACK ON/OFF button ON.
When this button is on, the stereo track output will be sent to a point directly before the [STEREO] fader, and can be monitored from the STEREO/AUX OUT jacks or the MONITOR OUT jacks. At this time, the record-ready status of all tracks will be cancelled.



Tip! Even while the stereo track is playing, you can still monitor the signals from the input channels.



Note EQ and dynamics processing are applied to the playback of the stereo track.

- 7 Press the RTZ [◀◀] key to rewind the song, and press the PLAY [▶] key.
The stereo track will be played back. Use the [STEREO] fader to adjust the monitor level.

When playback ends and you want to move to a different screen, switch the ST.TRACK ON/OFF button OFF.



Tip! If desired, you can use the [UNDO/REDO] button to cancel the recording that was made on the stereo track (→ p. 61), or use the ST.TRACK page to switch virtual tracks and record another take (→ p. 62).

Bounce (ping-pong) recording procedure

Here's how to perform the bounce (ping-pong) recording procedure, which lets you combine multiple tracks onto one or two tracks.

1 Lower the [STEREO] fader to the ∞ position.

2 In the Quick Navigate section, repeatedly press the [RECORD] key or hold down the [RECORD] key and use the CURSOR [\blacktriangle]/[\blacktriangledown] keys to access the BOUNCE page of the RECORD screen.

In the BOUNCE page you can select the bounce-source tracks, and record them via the L/R bus onto one or two bounce-destination tracks.

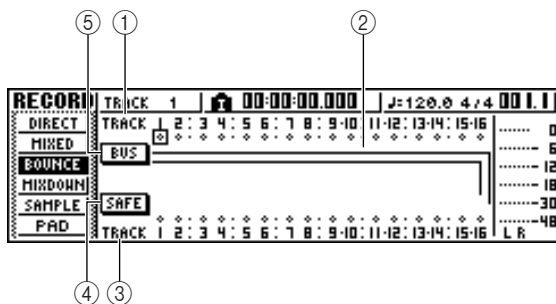

- 1 TRACK (upper line)**
Selects the bounce-source tracks.
- 2 Bus L/R**
The two horizontal lines indicate the L/R bus signal route. This lets you see the on/off status of the signals that are sent from the bounce-source tracks, and see the selected bounce-destination track(s).
- 3 TRACK (lower line)**
Here you can select the bounce-destination track(s).
- 4 SAFE button**
When you move the cursor to this button and press the [ENTER] key, all bounce-source and bounce-destination assignments will be cancelled.
- 5 BUS button**
When you move the cursor to this button and press the [ENTER] key, the right side of the screen will show a fader for adjusting the output level of the L/R bus, and a dedicated level meter for the L/R bus.

3 In the upper TRACK area, select a bounce-source track, move the cursor to the \oplus symbol for that track, and press the [ENTER] key.

Each time you press the [ENTER] key, the screen will change as follows.

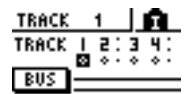
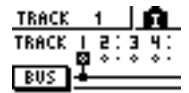
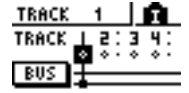
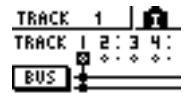

If a track channel is selected as a bounce-source, its assignment to the stereo bus will automatically be turned off.

4 Select other bounce-source tracks in the same way.

5 Use the [TRACK SEL] keys to select a bounce-destination track.

The [TRACK SEL] key will blink red, indicates that the corresponding track is selected as the bounce-destination. A line will appear in the screen to indicate the connection to the track. (To cancel your selection, press the same key once again.)

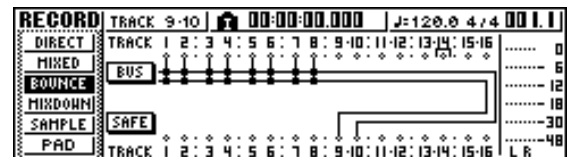

You can select up to two bounce-destination tracks. If you select track 1, 3, 5, or 7, bus L will be connected. If you select track 2, 4, 6, or 8, bus R will be connected. If you select track 9/10–15/16, bus L will be connected to the odd-numbered track, and bus R will be connected to the even-numbered track.



- If you move the cursor to the SAFE button and press the [ENTER] key, all connections will be cancelled.
- EQ and dynamics settings will be "flat" for the track channels of the tracks you select as the recording-destination.
- If you select an unpaired track, the pan of the track channel will be at the center position. If you select paired tracks, the pan of adjacent odd-numbered/even-numbered track channels will be spread to left and right respectively.

- 6 Raise the [STEREO] fader and the faders of the track channel(s) you selected as the bounce-destination to the 0 dB position.
- 7 While you play back the song, raise the faders of the bounce-source track channels to an appropriate level. Adjust the pan, EQ, and dynamics of each track channel as necessary.



The bounce-destination faders will not affect the content that is recorded. However, the bounce-source faders specify the volume balance that will be recorded.

- 8 Press the RTZ [◀◀] key to rewind the song. Then hold down the REC [●] key and press the PLAY [▶] key.
The song will begin playing back, and will be recorded on the bounce-destination track(s).
- 9 When you reach the end of the song, stop the song and press the RTZ [◀◀] key to rewind.
- 10 To check the recorded result, move the cursor to the SAFE button and press the [ENTER] key to cancel the recording settings.
- 11 Access the ON/OFF page of the MONITOR screen (→ p. 31), turn off all track channels other than the bounce-destination, and press the PLAY [▶] key.



- *If you attempt to change the screen or page without using the SAFE button, a popup window asking “Clear Current REC Setting?” will appear, asking you whether it is ok to clear the current recording settings. Move the cursor to the OK button and press the [ENTER] key.*
- *If desired, you can use the [UNDO/REDO] button to cancel the bounce-recording operation (→ p. 61), or switch the virtual track of the bounce-destination and record another take (→ p. 62).*

Convenient functions during mixdown/ bounce operations

Here are some convenient functions that you can use during mixdown or bounce operations.

Adding input signals or pad performances during mixdown

During mixdown, you can add signals from the input channels or pad channels. For example, you could add a performance from a workstation-type synthesizer (with built-in sequencer) that is synchronized to the AW16G song, or add sound effects that have been assigned to the pads. To do this, perform the following steps after you have completed "Preparing for mixdown" (→ p. 83).

- 1 In the Quick Navigate section, repeatedly press the [RECORD] key or hold down the [RECORD] key and use the CURSOR [▲]/[▼] keys to access the MIXDOWN page of the RECORD screen.
- 2 Press the [INPUT SEL] key or pad that corresponds to the input channel or pad channel you want to use, to add that channel as a mixdown-source.

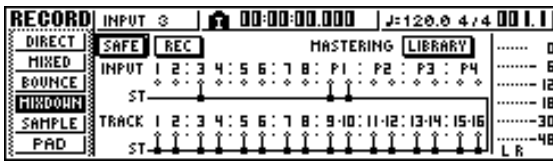

- 3 In the Selected Channel section, repeatedly press the [PAN/BAL] knob or hold down the [PAN/BAL] knob and use the CURSOR [▲]/[▼] keys to access the PAN page of the PAN screen.

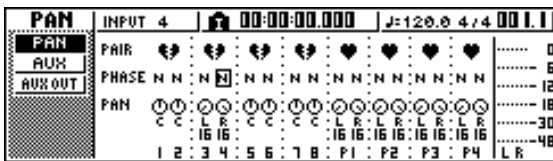

Note

If the page you see is different than shown above, make sure that input channels/pad channels are selected as the object of your operations. (This is shown in the upper left of the screen.) If track channels are selected, press one of the [INPUT SEL] keys or pads.

- 4 Move the cursor to the PAN knob of the channel you want to use, and turn the [DATA/JOG] dial to adjust the pan setting.

- 5 In the Selected Channel section, repeatedly press the [VIEW] key or hold down the [VIEW] key and use the CURSOR [▲]/[▼] keys to access the FADER page of the VIEW screen.

In the FADER page of the VIEW screen, you can use on-screen faders to adjust the faders (input level) of each channel.

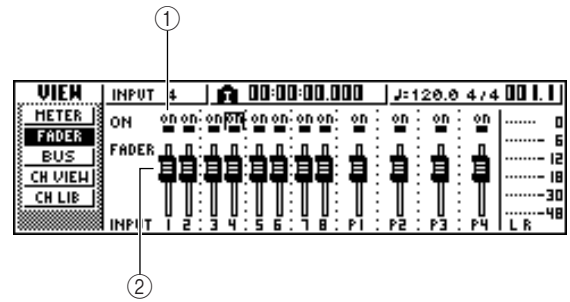

- ① **ON/OFF buttons**
These buttons switch each channel on/off.
- ② **Faders**
These faders adjust the input level of each channel.

- 6 While you play back the song, move the cursor to the on-screen faders and turn the [DATA/JOG] dial to adjust the level of the input channels/pad channels that you want to use.

- 7 If necessary, adjust EQ, dynamics, and the send level to the internal effects for each input channel or pad channel.

Now you have completed the preparations for adding input channel or pad channel signals to the mixdown. Record the mixdown on the stereo channel as described in "Recording on the stereo track" (→ p. 86).

Using meters to check the level of each channel

During mixdown or bouncing, you can watch meters that indicate the input levels in a single screen. To do so, repeatedly press the Selected Channel section [VIEW] key or hold down the [VIEW] key and use the CURSOR [▲]/[▼] keys to access the METER page of the VIEW screen.

In the METER page, the display will change depending on the channel that is currently selected (shown in the upper left of the screen). Press an [INPUT SEL] key to view the meters for the input channels/pad channels, or press a [TRACK SEL] key to view the meters for the track channels.

● If a track channel is selected

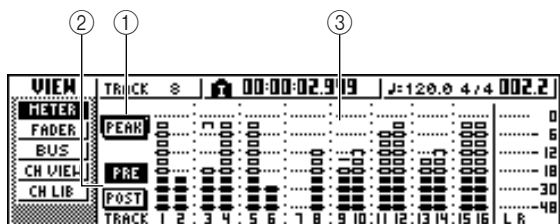

● If an input channel/pad channel is selected

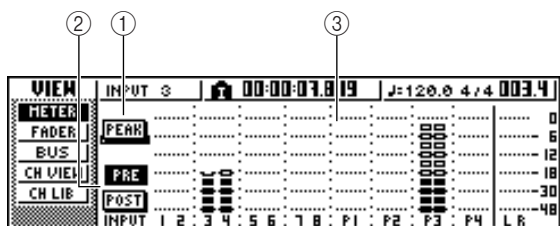

① PEAK button

This button switches the level meter peak hold function on/off. When this button is on, a indicator will show the peaks of the level meters, and this indicator will be held. To reset the indicator, temporarily turn off the PEAK button. This setting is shared with the BUS page of the VIEW screen.

② PRE/POST buttons

These buttons select whether the level meters in the METER page will indicate the pre-fader levels (PRE) or the post-fader levels (POST). This setting is independent from the BUS page of the VIEW screen.

③ Level meters

These indicate the input level of each channel.

Viewing all parameters for a certain channel

Sometimes you will want to see all mix parameters for a certain channel in a single screen. To do this, repeatedly press the Selected Channel section [VIEW] key or hold down the [VIEW] key and use the CURSOR [▲]/[▼] keys to access the CH VIEW page of the VIEW screen. (Some items can also be edited from this page.)

The display in the CH VIEW page will change depending on the currently selected channel (shown in the upper left of the screen). Use the [INPUT SEL] keys, pads 1–4, [TRACK SEL] keys, and [STEREO SEL] key to select the channel that you want to view.

● If an input channel, pad channel, or track channel is selected

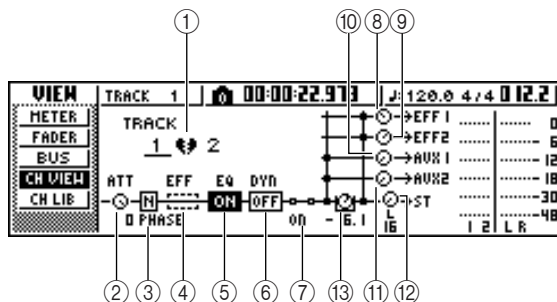

● If the stereo output channel is selected

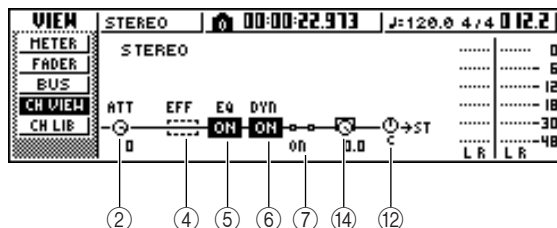

① Pairing

Indicates the pairing status of adjacent odd-numbered/even-numbered channels. Paired channels are indicated by a heart-shaped symbol, and unpaired channels are indicated by a broken heart. Move the cursor here and press the [ENTER] key to switch pairing on/off.

Note

Pairing cannot be switched off for track channels 9/10–15/16, pad channels 1–4, and the stereo channel.

② ATT knob

Move the cursor to this knob and turn the [DATA/JOG] dial to adjust the attenuation of the signal over a range of 0 to –96 dB before it enters the EQ. This is the same function as the ATT. knob in the EDIT page of the EQ screen.

③ Phase (except for the stereo output channel)

Move the cursor here and press the [ENTER] key to switch the phase of the signal between N (Normal) and R (Reverse).

- ④ **Effect insert**
This lets you insert an internal effect into the channel. When you move the cursor here and press the [ENTER] key, a popup window will appear, allowing you to select internal effect 1 or 2.
- ⑤ **EQ**
Move the cursor here and press the [ENTER] key to switch EQ on/off.
- ⑥ **DYN**
Move the cursor here and press the [ENTER] key to switch dynamics on/off.
- ⑦ **ON/OFF**
Move the cursor here and press the [ENTER] key to switch the channel on/off.
- ⑧ **EFF1 (except for the stereo output channel)**
- ⑨ **EFF2 (except for the stereo output channel)**
- ⑩ **AUX1 (except for the stereo output channel)**
- ⑪ **AUX2 (except for the stereo output channel)**
Move the cursor to these knobs and turn the [DATA/JOG] dial to adjust the send levels to effect buses 1/2 and AUX buses 1/2.
By moving the cursor to the left of the knob and pressing the [ENTER] key, you can switch between pre-fader (send the pre-fader signal to the bus) and post-fader (send the post-fader signal to the bus).
- ⑫ **PAN/BALANCE knob**
Move the cursor to this knob and turn the [DATA/JOG] dial to adjust the pan (or balance, in the case of the stereo output channel) of the signal that is sent from the channel to the stereo bus or L/R bus.
- ⑬ **FADER knob (except for the stereo output channel)**
Move the cursor to this knob and turn the [DATA/JOG] dial to adjust the level of the signal that is sent from the channel to the stereo bus or L/R bus. The range is $-\infty$ to +6 dB.

Note

The FADER knob of a track channel will follow the operation of the corresponding panel fader 1–8 or 9/10–15/16. However, please note that if you adjust an on-screen knob and then operate the panel fader, the value will not change until the fader passes the current value.

⑭ **OUTPUT LEVEL (only for the stereo output channel)**

Move the cursor to this knob and turn the [DATA/JOG] dial to adjust the output level of the signal that is sent from the stereo output channel to the STEREO/AUX OUT jacks and MONITOR OUT jacks. The range is $-\infty$ to 0 dB.

Note

The OUTPUT LEVEL knob will follow the operation of the panel [STEREO FADER]. However, please note that if you adjust the on-screen knob and then operate the panel fader, the value will not change until the fader passes the current value.

Initializing a channel

The mix parameters (EQ, dynamics, pan, etc.) of a channel can be reset to their default settings in a single operation. This function lets you start mixdown or bounce operations with the track channels “zeroed,” and provides an easy way to reset the levels back to the nominal setting if you can no longer hear any sound.

- 1 In the Quick Navigate section, repeatedly press the [MONITOR] key or hold down the [MONITOR] key and use the CURSOR [▲]/[▼] keys to access the INIT page.

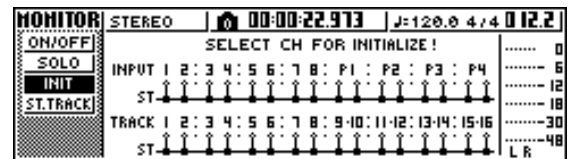

In this page you can separately initialize the mix parameters of input channels 1–8, pad channels 1–4, or track channels 1–16.

- 2 Press the [INPUT SEL] key, pad, or [TRACK SEL] key for the channel that you want to initialize.

When you press a key or pad, the upper line of the screen will indicate “CH.PARAMETER INITIALIZED,” and the corresponding channel will be initialized. (Channel library 00 will be recalled.)

An initialized channel will have the following mix parameter settings.

	Input channel	Pad channel	Track channel
Phase	no change	no change	no change
Attenuation	0 dB	0 dB	0 dB
EQ	ON	ON	ON
EQ parameters	flat	flat	flat
Dynamics on/off	OFF	OFF	OFF
Dynamics type	COMP	COMP	COMP
Dynamics parameters	no effect	no effect	no effect
Pan	If paired: L channel = L16, R channel = R16 If unpaired: center	L channel = L16 R channel = R16	If paired: L channel = L16, R channel = R16 If unpaired: center
Fader	0 dB*	0 dB	no change*

* If FADER FLIP is set to TRACK in the UTILITY screen PREFER page.

Editing the EQ parameters

The chapters entitled “Track recording” and “Overdubbing” explained how to load an EQ library and use the Selected Channel section [EQ] knob to make adjustments. Here’s how you can make more detailed adjustments to the EQ parameters.

- 1 Press an [INPUT SEL] key, a pad 1–4, a [TRACK SEL] key, or the [STEREO SEL] key to select the channel whose EQ you want to adjust.
- 2 If desired, load library data from the EQ library.
- 3 Repeatedly press the Selected Channel section [EQ] knob or hold down the [EQ] knob and use the CURSOR [▲]/[▼] keys to access the EDIT page of the EQ screen.

The EDIT page of the EQ screen lets you edit all of the EQ parameters.

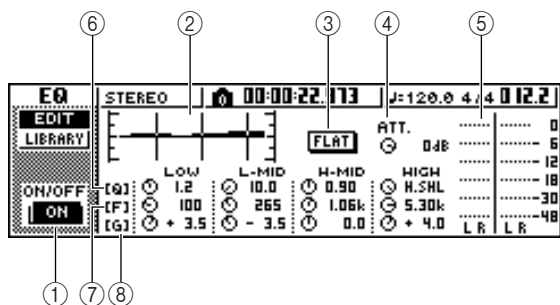

- 1 **ON/OFF button**
Switches the EQ on/off.
- 2 **Response curve**
Graphically indicates the approximate response of the EQ.
- 3 **FLAT button**
Move the cursor to this button and press the [ENTER] key to reset the boost/cut amount of all bands to 0 dB.
- 4 **ATT. (Attenuation) knob**
Attenuates the signal immediately before it is input to the EQ, over a range of –96 to 0 dB. This is used mainly to prevent the signal from clipping when you use the EQ to boost a specific frequency region.
- 5 **Output meter**
Indicates the level of the signal after it has passed through the EQ.
- 6 **Q knobs**
Specify the Q (steepness) at which each band (HIGH, HI-MID, LO-MID, LOW) will be boosted or cut. The range is 10–0.10, and higher settings will produce a steeper curve.
- 7 **F (Frequency) knobs**
Specify the center frequency of the boost/cut, over a range of 21.2 Hz–20.0 kHz.
- 8 **G (Gain) knobs**
Specify the amount of boost/cut, over a range of –18.0 dB to +18.0 dB.

4 Move the cursor to the parameter that you want to edit, and use the [DATA/JOG] dial to adjust the value.

5 To switch the LOW band type, move the cursor to the LOW band Q knob and turn the [DATA/JOG] dial toward the left.

With the default EQ settings, the LOW band is a shelving type. (The value field for the Q knob will indicate “L.SHL”.)

If you turn the Q knob toward the left, the Q knob value field will change to a numerical value, and will switch to the same boost/cut type as the HI-MID and LO-MID bands.

If you continue turning the Q knob toward the left, the Q knob value field will indicate “HPF,” and the LOW band will function as a high-pass filter. If “HPF” is selected, you can use the LOW band G knob to switch the high-pass filter on/off.

6 To switch the HIGH band type, turn the HIGH band Q knob all the way to the left.

With the default EQ settings, the HIGH band is a shelving type. (The value field for the Q knob will indicate “H.SHL”.)

If you turn the Q knob toward the left, the Q knob value field will change to a numerical value, and will switch to the same boost/cut type as the HI-MID and LO-MID bands.

If you continue turning the Q knob toward the left, the Q knob value field will indicate “LPF,” and the HIGH band will function as a low-pass filter. If “LPF” is selected, you can use the HIGH band G knob to switch the low-pass filter on/off.

7 To switch the EQ on/off, press the [ENTER] key.

In the EDIT page, you can press the [ENTER] key to switch the EQ on/off (except when the cursor is located at the FLAT button).



- If the meter display clips because you boosted a certain band, lower the ATT. knob to attenuate the signal.
- The [EQ] knob of the Selected Channel section will still operate even while the EDIT page of the EQ screen is displayed.

Editing the dynamics parameters

You can perform detailed editing of the dynamics parameters in the same way as for the EQ parameters.

- 1 Press an [INPUT SEL] key, a pad 1–4, a [TRACK SEL] key, or the [STEREO SEL] key to select the channel whose dynamics parameters you want to edit.
- 2 From the dynamics library, recall the settings that are closest to what you have in mind.
- 3 Repeatedly press the Selected Channel section [DYN] knob or hold down the [DYN] knob and use the CURSOR [▲]/[▼] keys to access the EDIT page of the DYN screen.

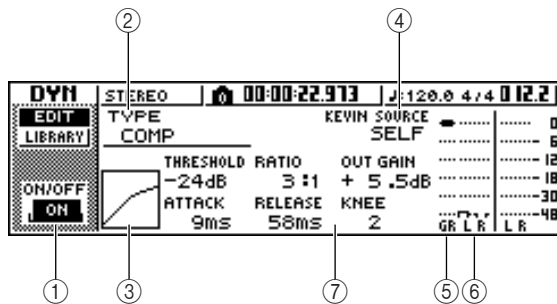

- 1 **ON/OFF button**
Switches dynamics on/off.
- 2 **TYPE**
Indicates the currently selected dynamics type. The displayed indication has the following meaning.
COMP..... Compressor
EXPAND..... Expander
GATE..... Gate
COMPAND-H..... Compander (hard)
COMPAND-S..... Compander (soft)
DUCKING..... Ducking

Note

You cannot change the dynamics type in this page. If you want to use a different type, you must recall library settings that use the desired type.

- 3 **Response curve**
This graph indicates the approximate response of dynamics settings. The horizontal axis of the graph is the input level, and the vertical axis is the output level.
- 4 **KEYIN SOURCE**
Selects one of the following as the trigger signal (key-in signal) that will control dynamics processing.
SELF..... The post-EQ signal of the currently selected channel
LEFT..... The post-EQ signal of the adjacent channel to the left
AUX1..... The signal immediately before the master send level of the AUX 1 bus
AUX2..... The signal immediately before the master send level of the AUX 2 bus

Note

You will not be able to select LEFT if you have selected input channel 1, pad channel 1, track channel 1, or the stereo output channel.

Tip!

Dynamics settings and operation are linked for paired channels and for the stereo output channel. In this case, dynamics processing will operate simultaneously for both channels if either channel exceeds the threshold level.

- 5 **GR (Gain Reduction)**
Indicates the amount of gain reduction produced by the dynamics processor, in a range of -18 dB to 0 dB.
- 6 **Output meter**
Indicates the level of the signal after it has passed through the dynamics processor.
- 7 **Parameters**
Here you can edit the parameters of the dynamics processor. The type of parameters and their ranges will differ depending on the dynamics processor type. For details on the types of parameter and their function, refer to the appendix.

- 4 Move the cursor to the parameter that you want to edit, and use the [DATA/JOG] dial to edit the value.

- 5 To switch dynamics on/off, press the [ENTER] key.

In the EDIT page, you can press the [ENTER] key to switch dynamics on/off regardless of the cursor location.

Please be aware that if you edit even one parameter in the EDIT page of the DYN screen, the operation of the Selected Channel section [DYN] knob will change as follows for that channel.

- Immediately after recalling a read-only library that contains dynamics settings, turning the [DYN] knob will simultaneously adjust multiple parameters to affect the dynamics processing. (The amount of change will depend on the last-recalled library.)

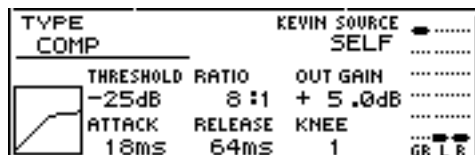
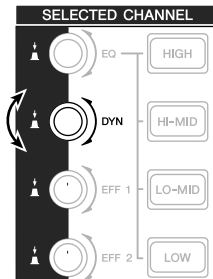
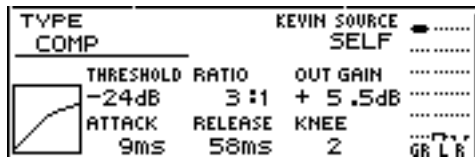

- For a channel for which you edited even one parameter in the EDIT page of the DYN screen, turning the [DYN] knob will adjust only the last-edited parameter. (The last-edited parameter is remembered for each channel.)

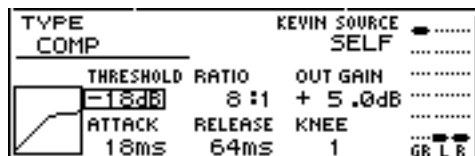
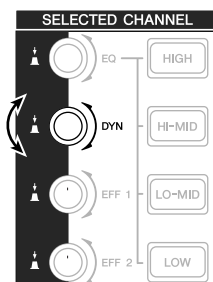
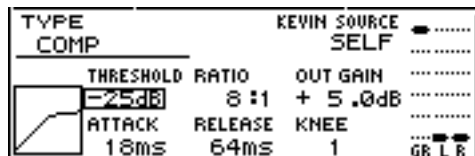

- If you once again recall a read-only library that contains dynamics settings, turning the [DYN] knob will again simultaneously adjust multiple parameters.

Editing the parameters of an internal effect

By using the EDIT page of the EFF1 screen or EFF2 screen, you can make detailed edits to the effect parameters of the internal effects 1 and 2.

If an effect is internally connected via send/return in the mixer section, the parameters (EQ, pan, AUX send, etc.) of the return channel that processes the return signal can also be edited in this page.

As an example, here's how you can edit the settings of internal effect 1, internally connected via send/return.

- For internal effect 1, recall an effect library that uses the desired effect type.
You cannot change the effect type (e.g., reverb, delay) in the EDIT page. You must first recall library settings that use the desired type.
- In the Selected Channel section, repeatedly press the [EFF1] knob or hold down the [EFF1] knob and use the CURSOR [▲]/[▼] keys to access the EDIT page of the EFF1 screen.

The EDIT page lets you edit all of the effect parameters.

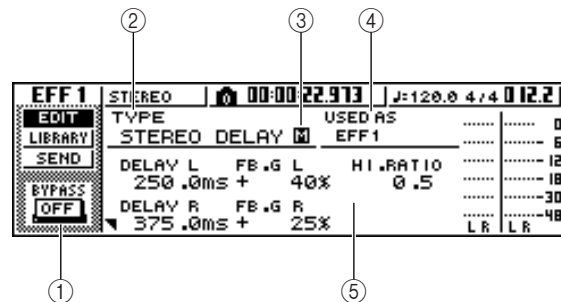

- BYPASS ON/OFF button**
Switches effect bypass on/off. The effect will not be heard if this button is on.
- TYPE**
Indicates the type of the currently selected effect.

Note

You cannot change the effect type in this page. If you want to use a different type, you must recall library settings that use the desired effect type.

- STEREO/MONO**
Indicates whether the effect is stereo or monaural. A stereo-input effect is indicated by , and a monaural-input effect is indicated by .
- USED AS**
Indicates how this effect is being used. If the effect is internally connected to the mixer section via send/return, this will indicate "EFF1" or "EFF2." If the effect is inserted into a specific channel, this will indicate the name of the channel into which the effect is inserted (e.g., "INPUT 1").

⑤ **Parameter page/Return channel page**

In this area you can edit the various effect parameters. The content and range of the parameters will depend on the currently-used effect type.

If the effect is internally connected to the mixer section via send/return, this area will show the mix parameters of the return channel, allowing you to edit them.

3 Move the cursor to the effect parameter that you want to edit, and turn the [DATA/JOG] dial to edit the value.

Depending on the effect type, this area may be used to show multiple parameter pages. In this case, repeatedly press the CURSOR [▼] key to access the parameter page that contains the parameter you want to edit.

For example, the illustration below shows the parameter pages for the STEREO DELAY effect type.

TYPE	STEREO DELAY	USED AS	EFF1
DELAY L	FB.G L	HI.RATIO	
250 .0ms +	40%	0.5	
DELAY R	FB.G R		
375 .0ms +	25%		LR

TYPE	STEREO DELAY	USED AS	EFF1
HPF	LPF		
Thru	10 .0kHz		
	MIX BAL.		
	100% LR		

MIX BAL. parameter



The parameter pages show the parameters that are specific to that effect type. However for all effect types, the lower right of the last parameter page will have a MIX BAL. parameter which sets the mix balance between the effect sound and the original sound.

4 To edit the mix parameters of the return channel, access the last parameter page, and then press the CURSOR [▼] key once again.

If the effect is internally connected to the mixer section via send/return, you can repeatedly press the CURSOR [▼] key to access the mix parameters of the return channel. The following pages are the same for all effect types.

TYPE	STEREO DELAY	USED AS	EFF1
EFF2SEND	AUX1SEND	AUX2SEND	
- 00 dB	- 00 dB	- 00 dB	
EFF2	AUX1	AUX2	
POST	PRE	PRE	LR

① **EFF2SEND**

Adjusts the level at which the signal is sent from the return channel to the other internal effect.



You cannot send the signal from return channel 1 to insert effect 1 (since this would mean sending the signal back to the same effect itself). For this reason, the EDIT page of the EFF1 screen has no send level to effect 1. For the same reason, the EDIT page of the EFF2 screen has no send level to effect 2.

② **AUX1SEND**

③ **AUX2SEND**

These adjust the send level of the signal that is sent from the return channel to AUX buses 1/2.

④ **EFF2 PRE/POST**

Switches the signal that is sent from the return channel to the other effect bus between pre-fader and post-fader.

⑤ **AUX1 PRE/POST**

⑥ **AUX2 PRE/POST**

These switch the signals that are sent from the return channel to AUX buses 1/2 between pre-fader and post-fader.

TYPE	STEREO DELAY	USED AS	EFF1
EQ HIGH	FREQ	Q	
00 .0dB	10 .0kHz	H-SHELF	
EQ H-MID	FREQ	Q	
00 .0dB	4 .00kHz	0.70	LR

① **EQ HIGH GAIN**

② **EQ HIGH FREQ**

③ **EQ HIGH Q**

④ **EQ H-MID GAIN**

⑤ **EQ H-MID FREQ**

⑥ **EQ H-MID Q**

These specify the gain, frequency, and Q for the HIGH and HI-MID bands of the return channel EQ. The range of each parameter is the same as in the EDIT page of the EQ screen.

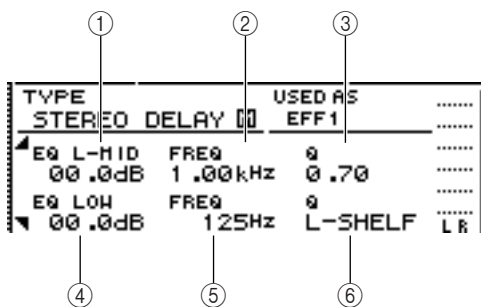

- ① EQ L-MID GAIN
- ② EQ L-MID FREQ
- ③ EQ L-MID Q
- ④ EQ LOW GAIN
- ⑤ EQ LOW FREQ
- ⑥ EQ LOW Q

These specify the gain, frequency, and Q for the LO-MID and LOW bands of the return channel EQ. The range of each parameter is the same as in the EDIT page of the EQ screen.

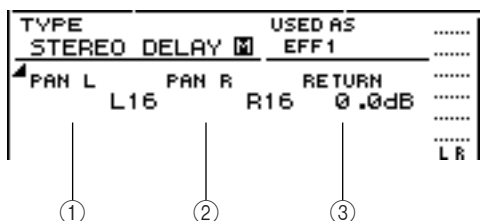

- ① PAN L
- ② PAN R

Independently specify the return channel panning for the L and R channels.

- ③ RETURN

Adjusts the input level for return channel 1.

5 Access the desired return channel page, move the cursor to a parameter, and turn the [DATA/JOG] dial.

6 To switch effect bypass on/off, press the [ENTER] key.

In the EDIT page, you can press the [ENTER] key to switch bypass on/off regardless of the current location.

Inserting an effect into a track channel

The chapter “Track recording” explained how to insert an internal effect into an input channel. In the same way, you can also insert an effect into a track channel or pad channel. As an example, here’s how to insert internal effect 1 into a track channel for use during mixdown or bouncing.

1 In the Selected Channel section, repeatedly press the [EFF1] knob or hold down the [EFF1] knob and use the CURSOR [▲]/[▼] keys to access the SEND page of the EFF1 screen.



Note

If the displayed page is different than shown above, make sure that a track channel is selected as the object of operations. (This is indicated in the upper left of the screen.) If an input channel/pad channel is selected, press any one of the [TRACK SEL] keys.

2 Move the cursor to the EFF INSERT field of the track channel into which you want to insert an effect, and press the [ENTER] key.

A popup window will appear, asking whether it is ok to release internal effect 1 from the send/return connection.



3 Move the cursor to the OK button and press the [ENTER] key.

4 Internal effect 1 will be inserted into the selected track channel.

5 Press the [EFF1] knob twice to access the LIBRARY page of the EFF1 screen.

6 Select the library that you want to use for that channel.

Note

If you insert an internal effect into a channel, the SEND page of the EFF1 screen will no longer show return channel pages 1–4. To adjust the balance between the original sound and the effect sound, use the MIX BAL. parameter that is shown in the last parameter page.

Tip!

You can also insert an effect by using the effect insert field in the CH VIEW page of the VIEW screen (→ p. 91).

Chapter 10

Creating an audio CD

This chapter explains how you can use the CD-RW drive to create an audio CD, and how to play back an audio CD.

Creating an audio CD

On the AW16G, you can select one or more songs on the hard disk, and write the audio data from the stereo track of each song to a CD-R/RW disc in CD-DA format. The CD-R/RW media to which you write this data can be played by the CD-RW drive or a conventional CD player in the same way as any audio CD.



Some CD players that do not support CD-R/RW media may not be able to play back a CD you create.

In order to create a CD, you must first register one or more songs in a “track list,” and then write the virtual track currently selected for the stereo track of each song (the “current track”) to the CD in the order specified by the track list.

A maximum of 99 tracks (areas on CD media to which audio data can be written individually) can be written to one volume of CD-R/RW media, and each track must be at least four seconds long. The maximum length of time that can be written is approximately 74 minutes for 650 MB media, or approximately 80 minutes for 700 MB media.

Types of media that you can use with the CD-RW drive

The CD-RW drive of the AW16G can use two types of media: “CD-R” which lets you record and add data, and “CD-RW” which lets you erase previously-recorded data and rewrite it. Each type of media has the following characteristics.

- **CD-R**
You can write data to this media, and add additional data later. You cannot erase and rewrite data that has already been written. Once you perform a process known as “finalizing the disc,” the audio data written to the CD-R can be played by the CD-RW drive or by most CD players.
- **CD-RW**
In addition to writing and adding data, this media lets you erase all recorded data and rewrite it. Audio data written to a CD-RW can be played back by the CD-RW or by CD players that support CD-RW media.

Methods of writing an audio CD

There are two ways in which you can write audio data to CD-R/RW media.

● Track At Once

This method writes the data in units of CD tracks. The advantage of this method is that you can add new data to media that already contains existing data.

With the Track At Once method, the data from the beginning to the end of the stereo track of a song is written to the CD as one track. (Even if there is a portion during the song that contains no data, it will be written as silent audio data.)

Since each track is written individually when you use this method, an interval of approximately two seconds will be created between each track.

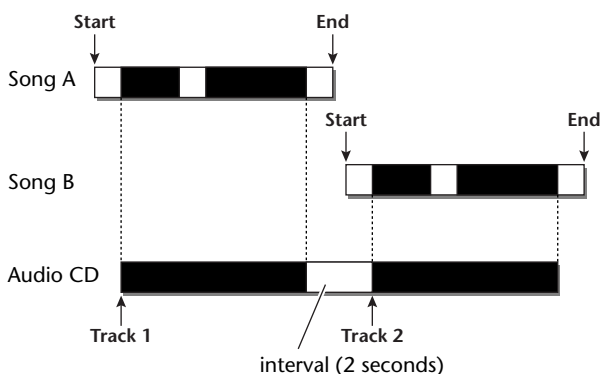

In order for a disc written using Track At Once to be playable by the CD-RW drive or a CD player, you must perform a process known as "finalizing" to write track information to the disc. Once you have finalized a disc, you cannot write any more data to it.

● Disc At Once

This method writes all tracks at once. Similarly to when using the Track At Once method, the data from the beginning to the end of the stereo track of each song is written to the CD as one track.

However since writing does not stop until all data has been written, there will be no gap between the tracks.

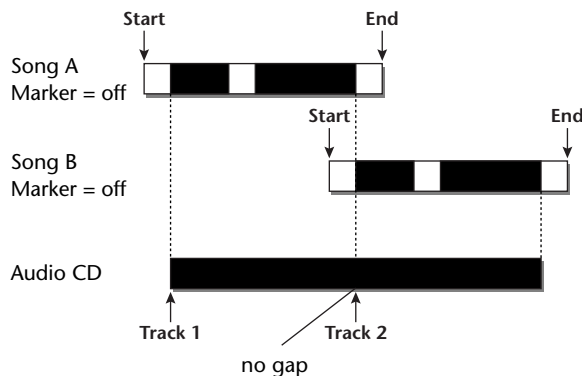

When using Disc At Once to write a CD, you can use the start point, end point and markers that were assigned within the AW16G song to divide a single continuous song into multiple tracks for writing.

For example, this is convenient when you have recorded a live performance as a single song, and want to assign track numbers while leaving the playback in continuous form.

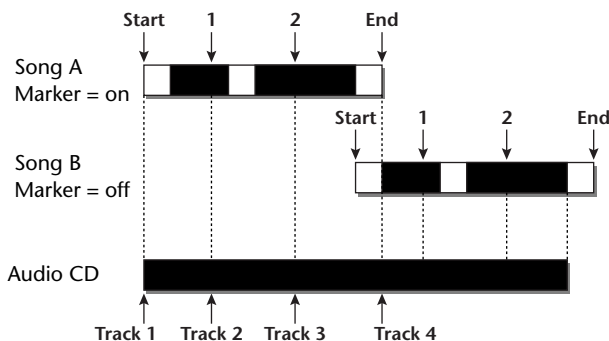

Note

- A track shorter than four seconds cannot be written to an audio CD. If you use start point/end point/markers to divide a song into multiple tracks, make sure that each track is at least four seconds long.
- If the length of the stereo track exceeds the writable length of the media, you can create an audio CD by adjusting the start point/end point so that the region is within the allowable length. (→ p. 102)

Media that you write using Disc At Once will be finalized automatically, and can be played back by a CD-RW drive or CD player that supports that type of media. However, no further data can be written to a disc that was written using Disc At Once.

Basic settings for the CD-RW drive

Before you actually write data to a CD, you will need to make basic settings for the CD-RW drive.

- 1 In the Work Navigate section, repeatedly press the [CD] key or hold down the [CD] key and use the CURSOR [▲]/[▼] keys to access the SETTING page of the CD screen.

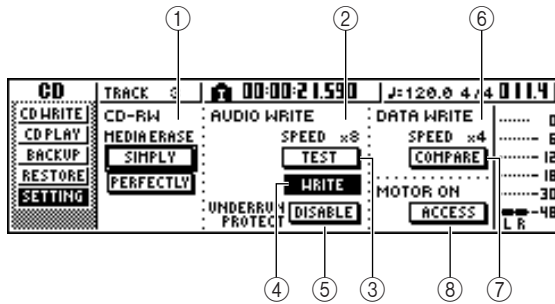

- 1 **CD-RW MEDIA ERASE**
Erases the data that was written to CD-RW media. For details, refer to "Erasing CD-RW media" (→ p. 105).
- 2 **AUDIO WRITE SPEED**
Selects the speed at which audio data will be written to CD-R/RW media.
- 3 **TEST button**
Specifies whether a writing test will be performed when you execute writing.
- 4 **WRITE button**
Specifies whether the actual writing operation will be performed.
- 5 **UNDERRUN PROTECT button**
Enables/disables the function that prevents buffer underrun (an error that can occur when data transfer cannot keep up with writing speed).
- 6 **DATA WRITE SPEED**
This indicates the speed at which data other than CD audio (e.g., backup data or WAV files) is written to CD-R/RW media. Normally this will indicate x8. This will indicate x4 if the media supports a maximum writing speed of x4. This field is for display only, and cannot be edited.
- 7 **COMPARE button**
If this button is on, the original data will be compared with the backed-up data or the exported WAV file after a backup or export operation is performed, to check whether any errors occurred while writing the data.
- 8 **MOTOR ON ACCESS/DISC IN button**
Selects one of the following two choices to specify how the drive will operate when CD-R/RW media is inserted.
ACCESS The drive will spin only when access is required.
DISC IN The drive will spin whenever media is inserted.

- 2 Move the cursor to the AUDIO WRITE SPEED field, and turn the [DATA/JOG] dial to select the writing speed.

You can select either x8 (eight times as fast as audio playback) or x4 (four times as fast as audio playback). Normally you should use x8, and drop down to x4 if errors occur during writing.

- 3 Use the TEST button and WRITE button to select the writing operation(s).

The TEST button and WRITE button specify whether a writing test and/or the actual writing operation will be performed. The combination of buttons that are on will determine the operation(s) that will occur, as follows.

Only the TEST button on Only a writing test will be performed.

Only the WRITE button on Writing will occur immediately.

Both the WRITE button and TEST button on First a writing test will be performed, and then the actual writing will be performed.

Depending on the media and the state of the hard disk, it is possible that an error may occur while the data is being written. (If you are using a CD-R, this will make the media unusable.) Thus, you can turn on the TEST button to check whether an error will occur before you actually write the disc. If an error occurs during the test, halt the procedure, and either lower the writing speed or set the UNDERRUN PROTECT button to ENABLE.

- 4 If desired, set the UNDERRUN PROTECT button to ENABLE.

The CD-RW drive of the AW16G has a function to prevent "buffer underrun" errors which can occur if data transfer cannot keep up with the writing speed. If you switch the UNDERRUN PROTECT button to the "ENABLE" setting, this function will be enabled, and buffer underruns will be prevented.



Note If this button is set to ENABLE, the TEST button will automatically be turned off. Also, if the TEST button is turned on, this button will automatically be set to DISABLE.

Writing audio data (Track At Once)

Here's how to use the Track At Once method to write stereo tracks from songs saved on the hard disk to CD-R/RW media. Use this method if you expect to be adding tracks to the disc later, or if you want a two-second gap between tracks.

1 Make sure that the appropriate virtual track is selected for the stereo track of the song(s) you want to write.

Only the virtual track that can be played by the stereo track (i.e., the "current track") will be written to disc. If the correct virtual track is not selected, load that song, use the ST.TRACK page of the MONITOR screen to switch to the correct virtual track, and then save the song.

2 Repeatedly press the [CD] key or hold down the [CD] key and use the CURSOR [▲]/[▼] keys to access the CD WRITE page of the CD screen.

Immediately after you access this page, the following two buttons will appear in the display.

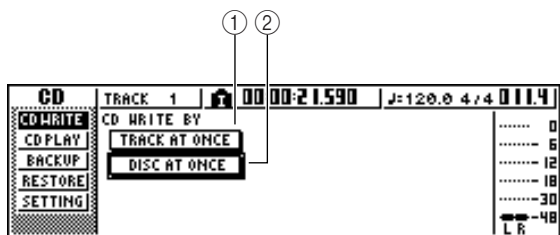

1 TRACK AT ONCE button

Creates an audio CD using the Track At Once method.

2 DISC AT ONCE button

Creates an audio CD using the Disc At Once method.

3 Insert CD-R/RW media in the drive, move the cursor to the TRACK AT ONCE button, and press the [ENTER] key.

A display like the following will appear.

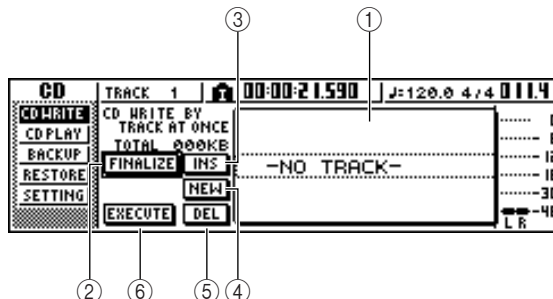

1 Song list

This is a list of the songs containing stereo tracks that will be written to the CD-R/RW media. The line enclosed by a dotted frame is currently selected for operations. If no songs have been registered, this will indicate "-NO TRACK-".

If audio data has already been written to the inserted CD-R/RW media but the media has not yet been finalized, a title of "--EXIST--" will be displayed for the already-written data.

2 FINALIZE button

Finalizes the inserted media by writing track information to it.

3 INS button

Inserts a new song in front of the song currently selected in the list.

4 NEW button

Adds a song at the end of the song list.

5 DEL button

Deletes the selected song from the list.

6 EXECUTE button

Executes writing to the CD media.



Tip! If you have inserted CD-RW media that contains data written using other than the Track At Once method, a popup window will appear immediately after step 3, asking whether you want to erase the data. If you want to erase the entire media, move the cursor to the OK button. If you want to cancel creation of an audio CD, move the cursor to the CANCEL button. Then press the [ENTER] key.

4 Move the cursor to the NEW button, and press the [ENTER] key.

The song list will show information (track number/song name/size of the stereo track) for the song that will be written to track 1 of the CD.

- 5 Move the cursor to the dotted frame in the song list, and turn the [DATA/JOG] dial to select the song that will be written to track 1.

Note

- When you turn the [DATA/JOG] dial, you will see only songs for which the current stereo track contains data.
- Songs with a stereo track shorter than four seconds will not be displayed.
- Songs with a stereo track longer than 324 minutes will not be displayed.

- 6 Repeat steps 4 and 5 to select the songs that will be written to track 2 and following.

Tip!

- When you move the cursor to the NEW button and press the [ENTER] key, a new song will be added at the end of the existing songs.
- By using the INS button instead of the NEW button, you can insert a new song immediately before the song that is selected in the list.
- You can use the DEL button to delete the currently selected song from the song list.

Note

When you add a song to the song list, the same song will always be initially selected. Change this as desired.

- 7 Move the cursor to the EXECUTE button and press the [ENTER] key.

A popup window will ask you to confirm.



- 8 To begin writing, move the cursor to the OK button and press the [ENTER] key.

While data is being written to the media, a popup window will indicate "CD Writing..." When writing is completed, a popup window will ask you whether you want to finalize.

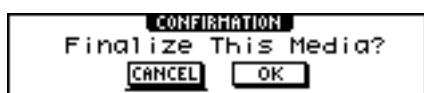

Note

- If an error message of "ATAPI Error!" appears while writing, it is possible that a buffer underrun has occurred. In this case, either decrease the writing speed to 4x or set the UNDERRUN PROTECT button to the ENABLE position. (→ p. 99)
- If you enabled the writing test in "Basic settings for the CD-RW drive" (→ p. 99), a writing test will be performed before the data is actually written. If a problem occurs during the writing test, an error message will appear.
- Copy-prohibit data will automatically be written into the CD that is created.

- 9 To finalize the disc, move the cursor to the OK button and press the [ENTER] key.

If you do not want to finalize the disc, move the cursor to the CANCEL button and press the [ENTER] key.

This completes the writing process.

Writing audio data (Disc At Once)

Here's how to use the Disc At Once method to write stereo tracks from songs saved on the hard disk to CD-R/RW media. Use this method if you do not want to create silence between each track of the CD, or if you want to write a single song divided into multiple tracks on the CD.

- 1 Make sure that the appropriate virtual track is selected for the stereo track of the song(s) you want to write.
- 2 If you want to divide the song into CD tracks at the marker locations specified within the song, check that markers have been set at the appropriate locations.
- 3 Repeatedly press the [CD] key or hold down the [CD] key and use the CURSOR [▲]/[▼] keys to access the CD WRITE page of the CD screen.

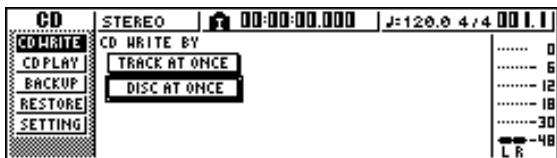

- 4 Move the cursor to DISC AT ONCE and press the [ENTER] key. The following screen will appear.

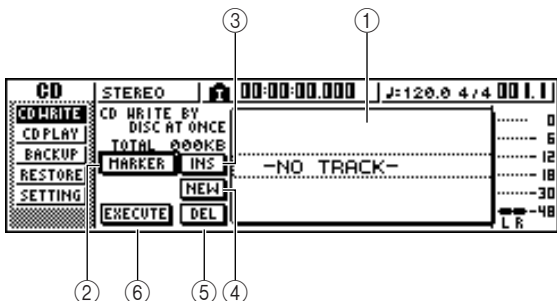

- 1 **Song list**
This is a list of the songs containing stereo tracks that will be written to the CD-R/RW media. The line enclosed by a dotted frame is currently selected for operations. If no songs have been registered, this will indicate "-NO TRACK-".
- 2 **MARKER button**
For each stereo track, this enables or disables the markers that have been set within that song. When you move the cursor to this button and press the [ENTER] key, the start point, end point and markers within the currently selected stereo track will be enabled. (A "flag" icon will appear at the left of the list.) If markers are enabled for a stereo track, a track number will be written to the CD at the location of each marker. Regardless of any areas of silence, the entire region from the Start point to the End point will be written.

- 3 **INS button**
Inserts a new song in front of the song currently selected in the list.
- 4 **NEW button**
Adds a song at the end of the song list.
- 5 **DEL button**
Deletes the selected song from the list.
- 6 **EXECUTE button**
Executes writing to the CD media.



Tip! If data has already been written on the CD-RW media that you insert, a popup window will appear immediately after step 3, asking whether you want to erase the data. Move the cursor to the OK button if you want to erase the entire media, or to the CANCEL button if you want to cancel execution. Then press the [ENTER] key.

- 5 Move the cursor to the NEW button, and press the [ENTER] key. The song list will show information (track number/song name/size of the stereo track) for the song that will be written to track 1 of the CD.
- 6 Move the cursor to the dotted frame in the song list, and turn the [DATA/JOG] dial to select the song that will be written to track 1.



- When you turn the [DATA/JOG] dial, you will see only songs for which the current stereo track contains data.
- Songs with a stereo track shorter than four seconds will not be displayed.
- Songs with a stereo track longer than 324 minutes will not be displayed.

- 7 If you want the stereo track of the selected song to be divided into CD tracks at the location of each marker, move the cursor to the MARKER button and press the [ENTER] key. Markers will be enabled for that song, and a "flag" icon will appear at the right of the list.



- Markers can be enabled/disabled independently for each song.
- When you use markers to divide a stereo track, the location of the divisions will be specified in units of 1/75 second.



- Note that if markers are enabled, the track numbers shown in the list will not match the number of tracks written to the CD.
- A maximum of 99 tracks can be written to an audio CD. If, for example, markers are enabled for the song you write to CD track 1, and this song contains 98 markers, it will not be possible to write any more songs to that CD-R/RW media.

8 Repeat steps 5–7 to select the songs that will be written to track 2 and following.



- When you move the cursor to the NEW button and press the [ENTER] key, a new song will be added at the end of the existing songs.
- By using the INS button instead of the NEW button, you can insert a new song immediately before the song that is selected in the list.
- You can use the DEL button to delete the currently selected song from the song list.



When you add a song to the song list, the same song will always be initially selected. Change this as desired.

9 Move the cursor to the EXECUTE button and press the [ENTER] key.

A popup window will ask you to confirm.



10 To begin writing, move the cursor to the OK button and press the [ENTER] key.

While data is being written to the media, a popup window will indicate “CD Writing...” When writing is completed, the CD-R/RW media will be ejected, and the following popup window will appear.

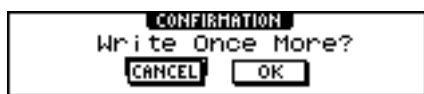

- If you enabled the writing test in “Basic settings for the CD-RW drive” (→ p. 99), a writing test will be performed before the data is actually written. If a problem occurs during the writing test, an error message will appear.
- Copy-prohibit data will automatically be written into the CD that is created.

11 If you want to create another CD with the identical contents, insert a new volume of media, and move the cursor to the OK button and press the [ENTER] key.

Writing will begin again.

Alternatively, you can move the cursor to the CANCEL button and press the [ENTER] key to exit the writing process.

Finalizing CD-R/RW media

Here's how to finalize CD-R/RW media that you wrote using Track At Once, so that the disc can be played by a CD-RW drive or a CD player.



CD-R/RW media written by the AW16G using Track At Once (and not yet finalized) cannot be played by another CD-RW drive or a CD player, but it can be played by the AW16G's CD Play function. (→ p. 106)

- 1 Insert the CD-R/RW media that you want to finalize into the CD-RW drive.
- 2 Repeatedly press the [CD] key or hold down the [CD] key and use the CURSOR [▲]/[▼] keys to access the CD WRITE page of the CD screen.
- 3 Move the cursor to the TRACK AT ONCE button, and press the [ENTER] key.
The following screen will appear, and the track list will show the content that has been written to that CD-R/RW media. Already-recorded tracks will be displayed as "--EXIST--".

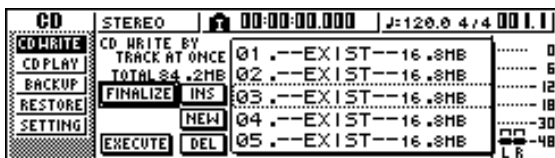

- 4 Move the cursor to the FINALIZE button, and press the [ENTER] key.
A popup window will ask you to confirm the finalize operation.



- 5 To finalize the disc, move the cursor to the OK button and press the [ENTER] key.
If you decide not to finalize the disc, move the cursor to the CANCEL button and press the [ENTER] key.



The finalize operation cannot be halted once it has been started. Perform this operation with care.

Erasing CD-RW media

Here's how to erase all data that has been written to CD-RW media, so that the CD-RW disc can be used as a blank disc. You will need to perform this operation on a disc that has been used to store computer data etc. if you want to use that disc on the AW16G.



Tip! Since data is erased as necessary when you back up AW16G data to CD-RW media or when you write audio data to CD-RW media, you do not need to perform the following procedure each time you re-use the disc.



Note The erased data cannot be recovered. Perform this operation with care.

- 1 In the Work Navigate section, repeatedly press the [CD] key or hold down the [CD] key and use the CURSOR [▲]/[▼] keys to access the SETTING page of the CD screen.



- 2 Move the cursor to the CD-RW MEDIA ERASE field, and press the [ENTER] key to select the desired erasure method.

Each button selects the following erasure method.

SIMPLY button Only the TOC (Table Of Contents) data written to the CD-RW media will be erased. If you select this method, it will take only a short time to erase the CD-RW media.

PERFECTLY button All data written to the CD-RW media will be erased completely. Since this method erases all data from the media, it will take a longer time than SIMPLY.

Move the cursor to the desired button, and press the [ENTER] key. A popup window will ask you to confirm the erasure.

- If you turn on the SIMPLY button



- If you turn on the PERFECTLY button



- 3 To execute the erasure, move the cursor to the OK button. If you decide not to erase the disc, move the cursor to the CANCEL button. Then press the [ENTER] key.

If you selected the OK button, erasure will begin. (This operation cannot be halted.)

Playing an audio CD

You can use the CD-RW drive to play back a conventional audio CD or CD-R/RW media to which audio data has been written. This is referred to as the CD Play function.



The CD Play function can also play audio data from a mixed-mode CD-ROM (only track 2 and following) or CD Extra (only the first session).

1 In the Work Navigate section, repeatedly press the [CD] key or hold down the [CD] key and use the CURSOR [▲]/[▼] keys to access the CD PLAY page of the CD screen.

In this page you can play back an audio CD inserted in the CD-RW drive.

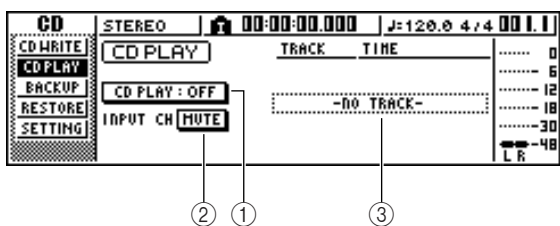

- ① CD PLAY button**
Switches the CD Play function on/off.
- ② INPUT CH MUTE/MIX button**
Use this button to specify whether the signals of input channels 1–8 will be output together with the CD playback (MIX button), or whether only the CD signal will be output (MUTE button).
- ③ List**
Displays the tracks of the audio CD that is inserted in the CD-RW drive.

2 Insert the audio CD that you want to play into the CD-RW drive.

3 Move the cursor to the CD PLAY button and press the [ENTER] key.
The CD Play function will be turned on, and the CD track data will be read.

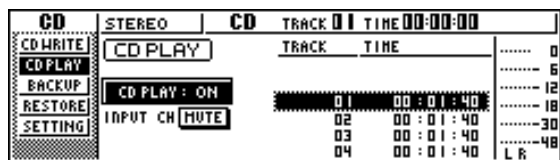

4 To play the CD tracks, press the PLAY [▶] key. To stop, press the STOP [■] key.

During playback, the audio output of the CD-RW drive will be sent directly to the stereo output channel. Use the STEREO fader to adjust the volume.

When the CD Play function is on, the keys of the transport section will have the following functions.

Key	Operation
PLAY [▶] key	Play
STOP [■] key	Stop
REW [◀◀] key/FF [▶▶] key	Rewind/Fast-forward
[DATA/JOG] dial	Select tracks
[◀] key/[▶] key	Select tracks



- When the cursor is located in the list, you can turn the [DATA/JOG] dial to select tracks.
- While an audio CD is playing, the access indicator in the display section will blink.

5 To exit the CD Play function, move the cursor to the CD PLAY button and press the [ENTER] key.



- The CD PLAY button can be switched on/off only while the CD is stopped.
- While the CD PLAY button is on, the CD-RW drive will be locked, and it will not be possible to eject the disc.

Chapter 11

Quick loop sampler

This chapter explains how to use the Quick Loop Sampler section.

About the quick loop sampler

The AW16G contains a quick loop sampler that lets you play stereo waveforms (samples) by striking the four pads.

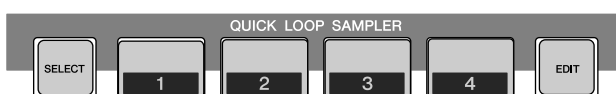

Each pad 1–4 has four sample banks (A–D) to which you can assign samples. By switching the sample bank for each pad, you can use up to sixteen different samples.

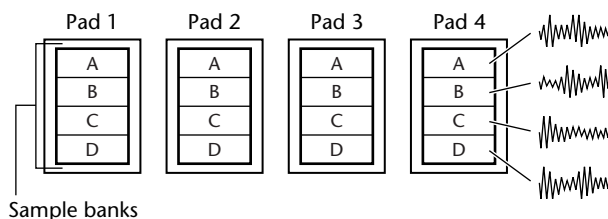

When you strike a pad 1–4, the assigned sample will be sent via pad channel 1–4 to the stereo bus. For each pad channel, you can adjust the EQ, dynamics, and effects 1/2 send levels just as you can for the track channels or input channels.

● Signal flow when using the Quick Loop Sampler

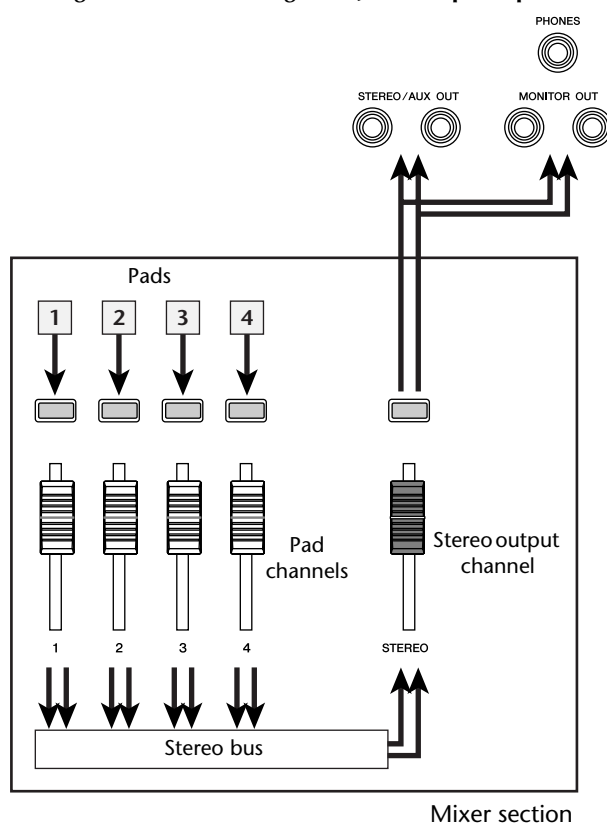

You can load samples into the pads from the sample library (a library for the Quick Loop Sampler), load a portion of an audio track or audio CD, or load a WAV file. You can also directly sample a signal from an instrument or mic connected to the AW16G's input jacks, and assign the sample to a pad.

A sample can be played back in one of two ways. "One shot mode" plays the sample once from start to end. "Loop mode" plays the sample repeatedly from start to end.

In addition, you can choose either "Gate mode" which plays the sample only while you continue holding down the pad, or "Trigger mode" which plays the sample all the way to the end when you press the pad once.

● Original sample

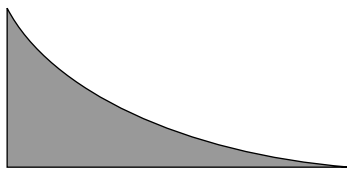

● ONE SHOT/GATE

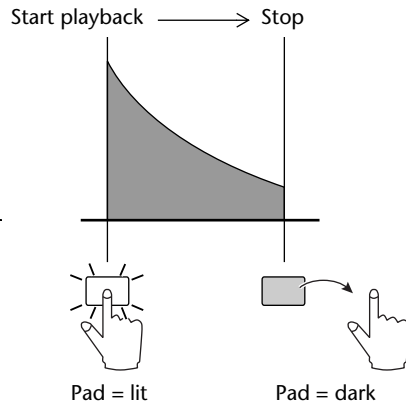

● ONE SHOT/TRIGGER

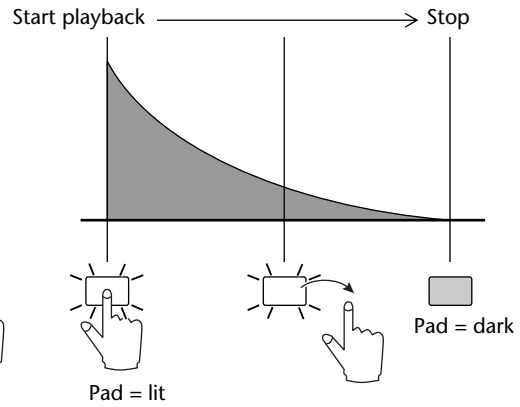

● Original sample

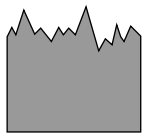

● LOOP/GATE

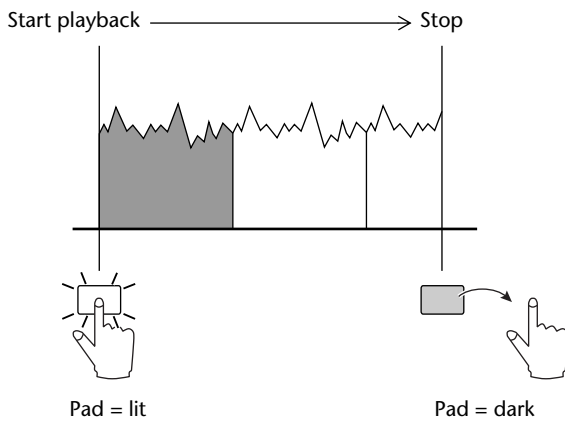

● LOOP/TRIGGER

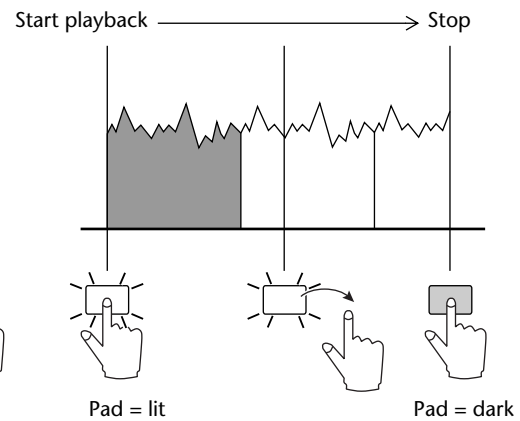

Your pad operations can be recorded in an area of memory called the Pad Tracks. The pad tracks always operates in synchronization with the recorder. By recording your pad operations in the pad tracks while you listen to the song play back, you can use the pad tracks as supplementary audio track.

Note

Be aware that the pad tracks do not record the sample or audio data itself, but merely the pad on/off data. (Each such piece of data is called a "pad event.") The playback produced by a pad track will change if you switch to other samples after recording pad events, or if you change the playback mode.

Pad events

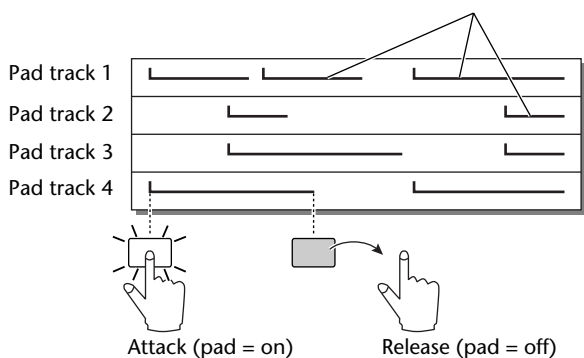

The AW16G also provides a "Slice function" that divides a sample into eight to sixteen segments, and adjusts the playback timing of each segment according to the tempo of the song.

By using the Slice function you can change only the tempo of a phrase without affecting its pitch.

For example, a sampled drum pattern can be played back at the tempo specified by the song's tempo map. (For details on using the Slice function → p. 120)

Tip!

The settings of the Quick Loop Sampler and the sample data assigned to each pad are saved as part of the song.

Using sample libraries

Sample libraries contain sets of up to sixteen different samples that can be used by the Quick Loop Sampler. When the AW16G is shipped from the factory, sets of samples such as drum loops and sounds effects are stored on the hard disk as sample libraries. When you load one of these libraries, samples will be assigned to each pad/sample bank, and you can use the pads to play the samples immediately. Here's how to load a sample library and try it out.

- 1 In the Quick Loop Sampler section, either repeatedly press the [SAMPLE EDIT] key or hold down the [SAMPLE EDIT] key and use the CURSOR [▲]/[▼] keys to access the LIBRARY page of the SAMPLE screen.

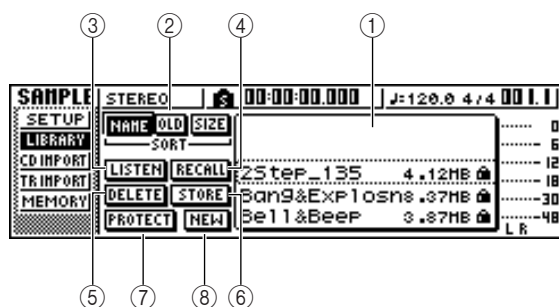

- 1 **List**
This area displays a list of the sample libraries saved on the hard disk.
- 2 **NAME/OLD/SIZE buttons**
These buttons sort the sample libraries shown in the list, either alphabetically (NAME), by when they were saved (OLD), or by their size (SIZE).
- 3 **LISTEN button**
When you move the cursor to this button and press the [ENTER] key, the button will be highlighted. If you now press a pad 1–4, the sample assigned to sample bank A of the currently selected sample library will play repeatedly. Playback will stop when you press the pad once again.
- 4 **RECALL button**
This button recalls the library that is selected in the list, and assigns the samples to each pad/sample bank.
- 5 **DELETE button**
This button deletes the library selected in the list from the hard disk.
- 6 **STORE button**
This button stores a library that you edited.
- 7 **PROTECT button**
Move the cursor to this button and press the [ENTER] key to switch the Protect setting on/off for the library selected in the list. A lock icon will be displayed to indicate a library that is protected, and it will not be possible to edit or delete this library.
- 8 **NEW button**
This button creates a new library on the hard disk.

- 2 Move the cursor into the list, and turn the [DATA/JOG] dial to select the library that you want to load.

By turning on the LISTEN button and pressing a pad 1–4, you can audition the samples that are assigned to sample bank A for each pad in that library. For details on the library contents, refer to “Appendix.”

- 3 Move the cursor to the RECALL button and press the [ENTER] key. A popup window will open. Move the cursor to the ALL button, and press the [ENTER] key.

When the library has been loaded, the popup window will automatically close.



Tip! When the popup window is open, you can move the cursor to the 1SAMPLE button and press the [ENTER] key to select and load just a single sample from the library.

- 4 Raise the [STEREO] fader to the 0 dB position.

- 5 Strike pads 1–4.

You can play the samples that are assigned to sample bank A of each pad.



Tip! Of the sample libraries saved on the hard disk when the AW16G is shipped, most drum pattern libraries that are set to Loop mode have the Slice function turned on. If you load this type of library, you only need to press the pad, and the tempo of the drum pattern will match the tempo of the song. This lets you use the Quick Loop Sampler similarly to a drum machine.



- If a sample is assigned to a pad, that pad will light while the sample plays when you press it. However if no sample is assigned, nothing will play and the pad will not light. You can either assign a sample to the pad, or switch the sample bank.
- If the pad lights when you strike a pad but you hear no sound, access the METER page of the VIEW screen, and check whether the meter of the corresponding pad channel (P1–P4) is moving (→ p. 90).
- If the meter moves when you strike a pad, make sure that the [STEREO] fader has not been lowered, and that your monitor system is connected correctly and that its volume is set appropriately.
- If you hear no sound even after raising the [STEREO] fader, access the INIT page of the MONITOR screen and press that pad. This will initialize the pad channel so that it will produce sound. (→ p. 91)

6 To switch the sample bank for each pad, repeatedly press the [SAMPLE EDIT] key to access the SETUP page of the SAMPLE screen.

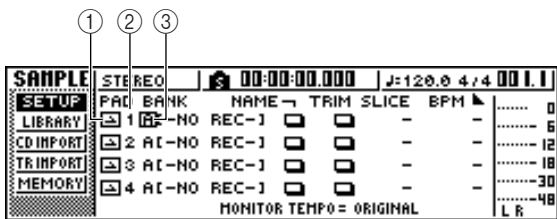

① One shot/loop mode

An icon indicates whether the sample assigned to the pad is set to One Shot mode (🔲) or Loop mode (🔲).

② Pad number

This indicates the pad number 1–4.

③ Bank

This selects the sample bank (A–D) used by each pad. The name of the sample assigned to that bank is displayed at the right.



If no sample is assigned to the selected bank, the sample name area will indicate [-NO REC-].

7 Move the cursor to the bank area for the desired pad, and turn the [DATA/JOG] dial.

The sample bank will change, and the sample name will change accordingly.

8 As desired, use the knobs and keys of the Selected Channel section to process the sound of pads 1–4.

EQ, dynamics, and effect send 1/2 levels can be adjusted for the pad channels in the same way as for the track channels or input channels. Press a pad 1–4 to select the pad channel that you want to control, and use the knobs and keys of the Selected Channel section.



- When you press a pad 1–4, the assigned sample will always sound. If you want to select a pad for operations without making it sound, hold down the [PAD SEL] key and press a pad 1–4.
- The playback sounds of pads 1–4 are sent via pad channels 1–4 to the stereo bus. By using the MIXDOWN page of the RECORD screen, you can record your pad performance on the stereo track (→ p. 89). A recording on the stereo track can also be moved to an audio track (→ p. 128).

Recording/playing a pad performance

Here's how you can record your pad performance (pad events) onto the pad tracks.

1 In the Quick Navigation section, repeatedly press the [RECORD] key or hold down the [RECORD] key and use the CURSOR [▲]/[▼] keys to access the PAD page of the RECORD screen.

In the PAD page you can record pad events on the pad tracks.

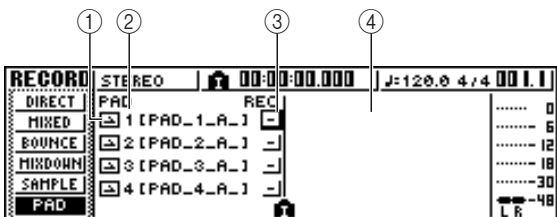

① One Shot/Loop mode

An icon indicates whether the sample assigned to the pad is set to One Shot mode (🔲) or Loop mode (🔲).

② Pad track number

This shows the pad track number 1–4. At the right is shown the name of the sample for the sample bank selected for that pad.

③ Track status button

This indicates the operating state of the track. If you move the cursor to this button and press the [ENTER] key, the following two displays will alternate.

- 🔲The pad track can be recorded.
- 🔲The pad track can be played.



Depending on the settings in the PAD page of the TRACK screen, this may also indicate 🚫 (muted).

④ Pad track view

In this area, the pad events recorded in the pad track are shown as a bar graph. Locator positions are shown as icons in the lower part of the screen.

2 Move the cursor to the track status button, and press the [ENTER] key several times to switch the button display to 🚫 (ready to record). (You may select more than one pad track.)



The track status button can be switched only when the recorder is stopped.

3 Use the track channel faders and the [STEREO] fader to set the audio tracks to an appropriate level for monitoring.

4 Locate the song to the point at which you want to begin recording.

5 To begin recording on the pad track, press the PLAY [▶] key.

The recording will begin running, and pad event recording will begin.

6 Play the pads while you listen to the audio tracks play back.

Pad events will be recorded on the pad tracks. The pad events that are recorded will appear in the pad track view in realtime.



Tip! Pad tracks record only the pad on/off status.

7 To stop recording, press the STOP [■] key. The recorder will stop.

8 To play back the events that were recorded on the pad tracks, move the cursor to the track status button and press the [ENTER] key several times to switch the display to .

9 Locate to the point from which you want to start playing back, and press the PLAY [▶] key.

The pad track(s) will play back in synchronization with the recorder. If you want to re-do the recording, repeat steps 6–9.

It is also possible to re-record just a specific region of a pad track. In this case, the newly recorded pad events will overwrite the previously-recorded events. However, you need to be careful, since this will also affect any overlapping pad events before or after the re-recorded region.



Tip! The contents of a recorded pad track can be edited in a variety of ways using editing commands. For details, refer to “What you can do using editing commands” (→ p. 123).

10 If you want to mute a specific pad track, press the Work Navigate section [TRACK] key repeatedly or hold down the [TRACK] key and use the CURSOR [▲]/[▼] keys to access the PAD page of the TRACK screen.

In the PAD page of the TRACK screen you can switch muting on/off for each pad track.

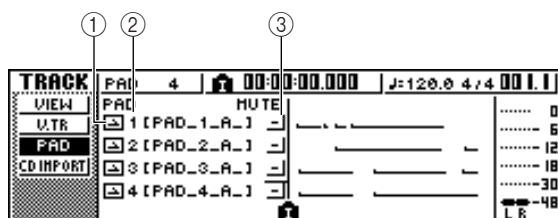

① One Shot/Loop mode

An icon indicates whether the sample assigned to the pad is set to One Shot mode () or Loop mode ().

② Pad track number

This indicates the pad track number 1–4. At the right is displayed the name of the sample assigned to the sample bank selected for that pad.

③ Track mute button

This button switches muting on/off for each track. Move the cursor to this button and press the [ENTER] key to switch between the following two settings.

..... The pad track can be played.

..... The pad track is muted.

11 Move the cursor to the track mute button for the track that you want to mute, and press the [ENTER] key to switch the button to (muted).

To cancel muting, move the cursor to the track mute button and press the [ENTER] key once again.



Tip! If a pad track is muted and the pad is set to LOOP/TRIGGER, the pad will play if you simply press the [PLAY] key to play back the recorder. This means that you can use this feature as a rhythm machine even without recording on a pad track.

Importing from an audio CD/WAV file to a pad

Here's how you can import CD audio data (CD-DA) or a WAV file from a CD-ROM/CD-R into a sample bank for pads 1–4.

1 Switch the internal settings of the AW16G to enable digital recording.

For details on digital recording settings, refer to page 160.

2 Insert a CD into the CD-RW drive.

You can load audio data (CD-DA) or WAV files from the following types of media.

● Audio data (CD-DA)

- Audio CD
- CD-Extra (only the first session of CD-DA)
- Mixed Mode CD (only CD-DA data of the second and later tracks)

● WAV files

- ISO9660 Level 1 format CD-ROM, CD-R, CD-RW*
- Mixed Mode CD

* The directory name and file name cannot use characters other than uppercase alphanumeric characters and the “_” (underscore) character. If you use the AW16G to export WAV files onto CD-R/RW media, the data will be in ISO9660 Level 1 format, but please be aware of this restriction if you use a computer to create WAV files.

3 In the Quick Loop Sampler section, repeatedly press the [SAMPLE EDIT] key or hold down the [SAMPLE EDIT] key and use the CURSOR [▲]/[▼] keys to access the CD IMPORT page of the SAMPLE screen.



4 Make sure that the cursor is located at the READ CD INFO button, and press the [ENTER] key.

The display will indicate “Read CD info...”, and the AW16G will begin reading the CD that is inserted in the CD-RW drive.

Depending on the source from which data is read, the screen will change as follows.

● When importing from an audio CD/CD-Extra

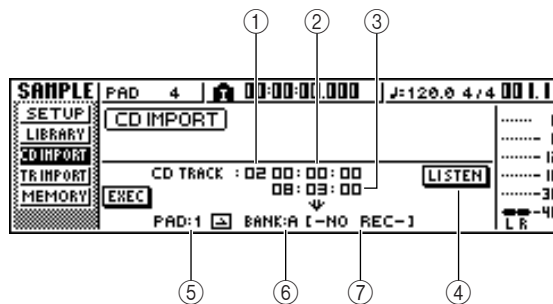

① From CD TRACK

Specifies the number (01–99) of the audio track that will be imported from the source CD.

② From Start

Specifies the starting location of the data that will be imported, in units of minutes/seconds/frames (1/75th of a second).

③ From End

Specifies the ending location of the data that will be imported, in units of minutes/seconds/frames (1/75th of a second).



Tip!

The “frames” here are the smallest unit of time used by a CD track. Do not confuse them with the frames used in MTC or SMPTE.

④ LISTEN button

If you move the cursor to this button and press the [ENTER] key, the specified region of the currently selected CD track will be played back repeatedly.

⑤ To PAD

Selects the pad number (1–4) to which the audio material will be imported.

⑥ To BANK

Selects the sample bank (A–D) to which the audio material will be imported.

⑦ To NAME

Indicates the name of the sample that is currently assigned to the import-destination sample bank. If nothing is assigned, this will indicate [-NO REC-]. This field is only for display, and cannot be edited.

● When importing from a WAV file

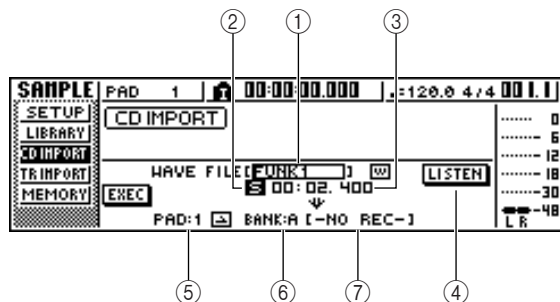

① From WAV File

Specifies the WAV file that will be imported. If the media contains folders (directories), move to the folder that contains the WAV file you want to import, and then specify the desired WAV file. The following icons will be displayed.

- Indicates that a WAV file is selected.
- Indicates that a folder in the same level is selected.
- Indicates that the folder for the next higher level is selected.

② Mono/Stereo

Indicates whether the WAV file selected for importing is monaural (M) or stereo (S). This field is only for display, and cannot be edited.

③ Size

Indicates the size (length in msec units) of the WAV file selected for importing. This field is only for display, and cannot be edited.

④ LISTEN/ENTER/UP buttons

The name and function of the button displayed here will depend on the item that you select for the From WAV File parameter.

● If WAV file () is selected

The LISTEN button will be displayed, allowing you to hear the WAV file repeatedly.

● If a folder in the same level is selected

The ENTER button will be displayed, allowing you to move into that folder.

● If the next higher folder () is selected

The UP button will be displayed, allowing you to move to the folder above.

⑤ To PAD

⑥ To BANK

⑦ To NAME

These have the same function as when importing from an audio CD/CD-Extra.



- If a mixed mode format CD-ROM is inserted in the CD-RW drive, a popup window will appear, allowing you to select AUDIO (CD-DA) or WAVE (WAV files) for importing. Move the cursor to the button for the type of data that you want to import, and press the [ENTER] key.
- The only type of WAV files that can be imported are 16 bit/44.1 kHz monaural or stereo files.
- If you import a monaural WAV file, the same sample will be assigned to the L and R channels.

- When you move the cursor to the LISTEN button and press the [ENTER] key, there will be a slight interval of time before you hear the sound, since the data is being read from CD.

5 If you are importing a WAV file, move the cursor to the From WAVE file field, and turn the [DATA/JOG] dial to select the WAV file that you want to import.

To move to a lower-level folder, display the () icon in this area, move the cursor to the ENTER button in the screen, and press the [ENTER] key.

To move to the folder above, display the () in this area, move the cursor to the UP button in the screen, and press the [ENTER] key.

6 If you are importing from an audio CD or CD-Extra, use the From Start/From End fields to specify the region that you want to import.

7 Use the To PAD and To BANK fields to specify the pad/sample bank into which the data will be imported.



If the import destination already contains data, the existing sample will be overwritten by the newly imported sample. Be careful that you do not accidentally erase a sample that you want to keep.

8 When you have finished specifying the data to be imported, move the cursor to the EXEC button and press the [ENTER] key.

A popup window will appear, asking you to confirm the operation.



9 To execute the import, move the cursor to the OK button and press the [ENTER] key.

Importing will begin. If you decide to cancel the import, move the cursor to the CANCEL button and press the [ENTER] key.



- When you import from CD-DA, a name of "PAD_x_y" (x= pad number, y= sample bank) will automatically be assigned to the sample. You are free to change this name later (→ p. 117).
- When you import a WAV file, the first eight characters (not including the extension) of that filename will be assigned as the name of the sample.
- The imported sample will be saved together with the current song.



It is not possible to import samples while the AW16G is running.

Importing from an audio track/stereo track to a pad

Here's how a region of an already-recorded track of the current song can be imported into a sample bank for pads 1–4.

- 1 Play back the song, and find the track and region that you want to import.
- 2 In the Quick Loop Sampler section, repeatedly press the [SAMPLE EDIT] key or hold down the [SAMPLE EDIT] key and use the CURSOR [▲]/[▼] keys to access the TR IMPORT page of the SAMPLE screen.

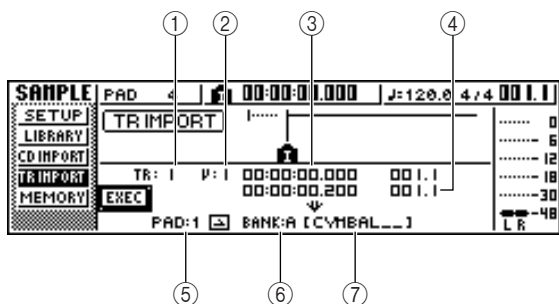

This page contains the following items.

- ① **From TRACK**
Specifies the track from which the data will be imported.
- ② **From V.TR**
Specifies the virtual track from which the data will be imported.
- ③ **From Start**
Specifies the beginning of the region that will be imported.
- ④ **From End**
Specifies the end of the region that will be imported.
- ⑤ **To PAD**
Selects the pad (1–4) to which the data will be imported.
- ⑥ **To BANK**
Selects the sample bank (A–D) to which the data will be imported.
- ⑦ **NAME**
Indicates the name of the sample that is currently assigned to the sample bank you specified as the import destination. If no sample is currently assigned, this will indicate [-NO REC-]. This item is for display only, and cannot be edited.

- 3 Move the cursor to the From TRACK field, and turn the [DATA/JOG] dial to select one of the following as the import source track.
 - 1–16..... Import monaural audio from a track 1–16.
 - 1/2–15/16..... Import stereo audio from tracks 1/2–15/16.

STEREO Import stereo audio from the stereo track.



If you import monaural audio from a track 1–16, the same sample will be assigned to the left and right channels.

- 4 Move the cursor to the V.TR field, and turn the [DATA/JOG] dial to select a virtual track 1–8 as the import destination.
- 5 Move the cursor to the From Start and From End fields, and turn the [DATA/JOG] dial to specify the start and end of the region that will be imported.
The units by which you specify the location will depend on the current counter display method. For details on the counter display, refer to page 139.
- 6 Move the cursor to the To PAD and To BANK fields, and turn the [DATA/JOG] dial to specify the pad number and sample bank into which the data will be imported.
- 7 When you have finished making the settings, move the cursor to the EXEC button and press the [ENTER] key.
A popup window will ask you to confirm the operation.
- 8 To execute the import, move the cursor to the OK button and press the [ENTER] key.
The data will begin being read from the track. If you decide to cancel the import operation, move the cursor to the CANCEL button and press the [ENTER] key.



- *The imported sample will be assigned the same name as the track from which the data was imported. You are free to edit this name later (→ p. 117).*
- *The imported sample is saved together with the current song.*



- *A total of up to 44 seconds (stereo) of samples can be imported into the Quick Loop Sampler. If you specify a region that exceeds this amount, an error message will be displayed, and the import operation cannot be executed.*
- *If you import once again into the same pad and sample bank, that sample will be overwritten by the newly imported data. If you want to keep the previously-imported sample, you must import the new data into a different pad or sample bank.*
- *It is not possible to import samples while the AW16G is running.*

Sampling an external input signal

You can directly sample (record) an input signal from the MIC/LINE INPUT jacks and assign it to a pad. There are two ways to do this; “manual record” in which you start and stop recording manually, and “auto record” in which recording will begin automatically when the signal reaches a specified level.

■ Prepare for sampling

- 1 Connect the instrument/mic that you want to sample to a MIC/LINE INPUT jack.
- 2 In the Quick Navigate section, repeatedly press the [RECORD] key or hold down the [RECORD] key and use the CURSOR [▲]/[▼] keys to access the SAMPLE page of the RECORD screen.

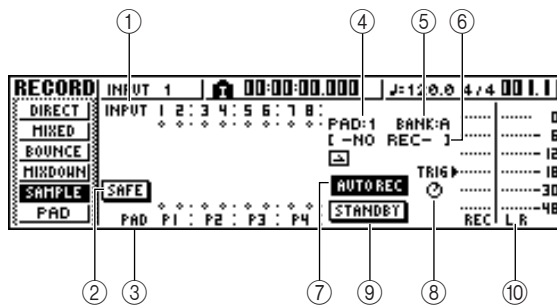

This page contains the following items.

- 1 **INPUT**
Indicates the connection status of input channels 1–8.
- 2 **SAFE button**
When you move the cursor to this button and press the [ENTER] key, all connections will be cancelled.
- 3 **P1–P4**
Indicates the connection status of pads 1–4.
- 4 **PAD**
Indicates the record-destination pad (1–4).
- 5 **BANK**
Indicates the record-destination sample bank (A–D).
- 6 **Sample name**
Indicates the sample that is currently assigned to the sample bank selected in the PAD/BANK fields.
- 7 **MANU REC/AUTO REC button**
This buttons selects either MANU REC (manual record) or AUTO REC (auto record) as the recording method.
- 8 **TRIG knob**
Adjusts the trigger level when using auto record.
- 9 **START/STANDBY/STOP button**
This button starts or stops sampling.
- 10 **Meter**
Indicates the input level of the signal that will be recorded.

- 3 Press the [INPUT SEL] key of the input channel to which you connected the instrument or mic, and then press the pad that you want to specify as the record-destination.

The input channel will be connected directly to the pad you specify. The PAD and NAME fields will change accordingly.

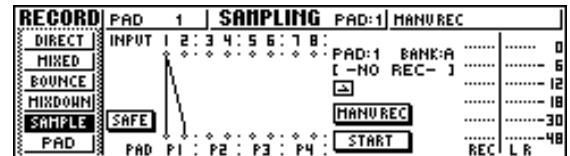

Normally, one input channel will be connected to channels L and R of the pad, as shown in the above diagram. However if the input channels are paired, the odd-numbered channel will be connected to channel L of the pad, and the even-numbered channel will be connected to channel R of the pad.

Note

When you connect an input channel and a pad, the counter display will change. In this state it will no longer be possible to sound the pad, nor to operate the keys of the transport section or the locate section.

When you move the cursor to the SAFE button and press the [ENTER] key to cancel the connection, operation will return to the normal state.

- 4 Adjust the input level of the instrument or mic.

For details on how to adjust the level, refer to page 34.

- 5 As necessary, load an input library to create the desired sound.

For details on using an input library to modify the sound, refer to page 50.

Note

The sample bank will be the one that is selected in the SETUP page of the SAMPLE screen. If you record into a sample bank to which samples have already been assigned, the previous samples will be overwritten by the new samples.

The procedure from this point will depend on whether you are using Manual Record or Auto Record.

Manual record

- 1 Make sure that the MANU REC/AUTO REC button indicates MANU REC.
If the button indicates AUTO REC, move the cursor to the button and press the [ENTER] key. When MANU REC is selected, the START/STANDBY button will function as the START button to start or stop sampling.
- 2 To begin sampling, move the cursor to the START button in the screen, and press the [ENTER] key. Then play your instrument.
During sampling, the button will be displayed as STOP, and will function as the sampling stop button.

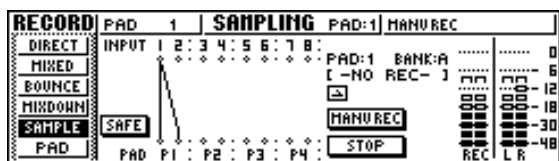

- 3 To stop sampling, move the cursor to the STOP button in the screen, and press the [ENTER] key.
Sampling will also end automatically when the available memory is used up.

Auto record

- 1 Move the cursor to the MANU REC/AUTO REC button and press the [ENTER] key to switch the button to AUTO REC.
The START/STANDBY button will function as the STANDBY button to standby or stop sampling.
- 2 Move the cursor to the TRIG button and turn the [DATA/JOG] dial to adjust the level at which sampling will begin. The setting is indicated by the ▮ symbol in the meter.
Sampling will begin automatically when the input signal exceeds the level you specify.

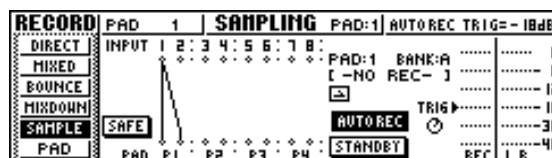

- 3 Move the cursor to the STANDBY button and press the [ENTER] key.
The STANDBY button display will change to START, and you will be in record-standby mode.



Tip! If you move the cursor to the START button and press the [ENTER] key, sampling will begin immediately even if the input signal has not reached the level specified by the TRIG knob.

- 4 Play your instrument.
Sampling will begin when the input signal reaches the level you specified in step 2.
During sampling, the STANDBY button will be displayed as STOP, and will function as the sampling stop button.
- 5 To stop sampling, move the cursor to the STOP button in the screen, and press the [ENTER] key.
Sampling will also end automatically when the available memory is used up.



- Immediately after sampling ends, a name of "PAD_x_y" (x= pad number/y= sample bank) will be automatically assigned to the sample. You are free to edit this name later (→ p. 117).
- You can adjust the region of a sample after recording it (→ p. 118). It is a good idea to leave some extra time before and after the sound you actually want, and adjust the playback region afterward.

Editing the sample name

Here's how you can edit the sample name that is assigned when you import from an audio CD or WAV file, or when you sample an external signal.

- 1 In the Quick Loop Sampler section, repeatedly press the [SAMPLE EDIT] key or hold down the [SAMPLE EDIT] key and use CURSOR [▲]/[▼] keys to access the SETUP page of the SAMPLE screen.

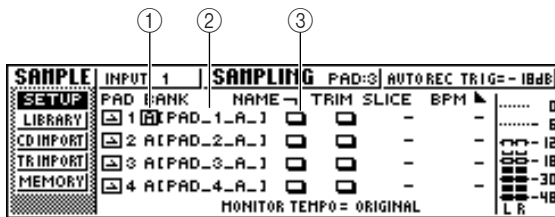

- 1 **Bank**
Selects the sample bank that will be used for each pad.
- 2 **Sample name**
Indicates the name of the sample that is assigned to the currently selected sample bank.
- 3 **NAME button**
Opens the TITLE EDIT popup window, where you can edit the name of the sample.

- 2 Move the cursor to the Bank field, and turn the [DATA/JOG] dial to select the sample bank whose name you want to edit.
The sample name is displayed at the right.

- 3 Move the cursor to the NAME button and press the [ENTER] key.
The TITLE EDIT popup window will appear.



You may use only capital letters, numerals, and the underscore “_” character.

- 4 When you have finished editing the name, move the cursor to the OK button and press the [ENTER] key.
The popup window will close, and the new name will be applied.

Trimming the playback region

Here's how you can view the waveform of the sample assigned to a sample bank, and adjust the playback start and end points.

- 1 In the Quick Sampler Section, repeatedly press the [SAMPLE EDIT] key or hold down the [SAMPLE EDIT] key and use the CURSOR [▲]/[▼] keys to access the SETUP page of the SAMPLE screen.

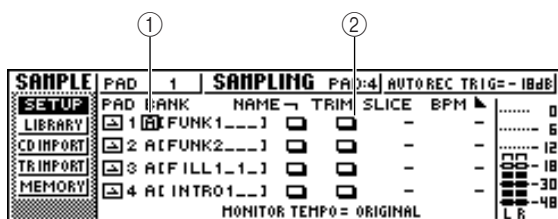

1 Bank

Selects the sample bank used for each pad.

2 TRIM button

Accesses a popup window that displays the waveform of the sample.

- 2 Move the cursor to the bank field for the pad whose playback region you want to adjust, and select the sample bank.

- 3 Move the cursor to the TRIM button for the pad whose playback region you want to adjust, and press the [ENTER] key.

The WAVE DISPLAY popup window will appear. In this popup window you can view the waveform of the selected sample, and specify the start point (playback start location) and end point (playback end location).

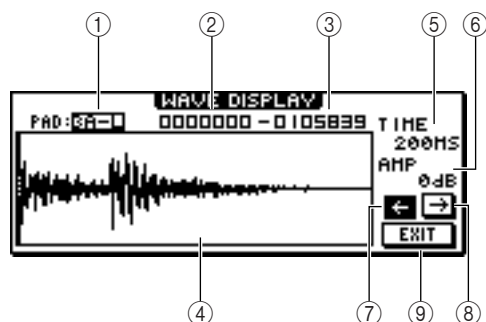

1 PAD

Indicates the currently selected pad and sample bank. Use the [DATA/JOG] dial to specify whether the L or the R channel will be displayed.

2 Start point

Specifies the start point of the sample.

3 End point

Specifies the end point of the sample.



In the WAVE DISPLAY popup window, the start point and end point are indicated by vertical dotted lines.

4 Waveform display

Displays the waveform of the selected sample.

5 TIME

Specifies the range of time that will be displayed for the waveform. If you select 1SEC, the distance from the left edge of the screen to the right edge will correspond to one second. If you select SAMPLE, the display will be at maximum magnification, and each pixel in the horizontal direction will correspond to one sample (1/44,100 second).

6 AMP

Specifies the range of levels that will be displayed for the waveform. If you select 0 dB, the top and bottom edges of the screen will be the maximum level.

7 ← button

Displays the area near the Start point of the waveform.

8 → button

Displays the area near the End point of the waveform.

9 EXIT button

Applies the settings and closes the popup window.

- 4 Move the cursor to the Start point, and turn the [DATA/JOG] dial to adjust the playback start point of the sample.

If you expand or shrink the time axis of the waveform display, the movement that occurs when you turn the [DATA/JOG] dial will change accordingly. It is a good idea to start with a lower magnification, set the location approximately, and then zoom in to a higher magnification and make detailed adjustments.

- 5 In the same way, move the cursor to the end point and adjust the playback end point of the sample.



The unused region before the Start point and after the End point can be deleted later if you wish. For details, refer to "Deleting an unwanted sample" (→ p. 122).

- 6 When you have finished making settings, move the cursor to the EXIT button and press the [ENTER] key.

The popup window will close.

Using the Slice function

Slice is a function that divides a sample (whose playback mode is set to Loop) into eight to sixteen segments, and adjusts the timing of each segment so that it can be played at a different tempo without affecting the pitch.

Here's how you can use the Slice function to play a sampled phrase at the tempo of the current song.



The Slice function always handles the playback region of the sample as one measure. Before using the Slice function, you must trim the playback region of the sample so that it is one measure long.

- 1 In the Quick Loop Sampler section, repeatedly press the [SAMPLE EDIT] key or hold down the [SAMPLE EDIT] key and use the CURSOR [▲]/[▼] keys to access the SETUP page of the SAMPLE screen.

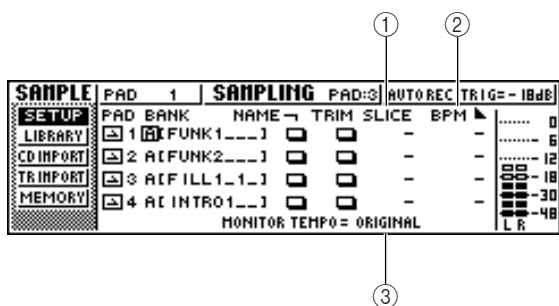

- 1 **SLICE**
Turns the Slice function on/off. If this is on, you can specify the number of segments into which the sample will be divided. If the playback mode is not set to Loop mode, this will be displayed as “-” and cannot be changed.
- 2 **BPM**
Indicates the tempo calculated by considering the playback region of the sample as one measure. This field is for display only, and cannot be edited.
- 3 **MONITOR TEMPO**
Selects the basic tempo that will be used for playing the phrase sample when the recorder is stopped. This item only affects a sample whose playback mode is set to LOOP. While the recorder is running, the tempo of the song will be used.

- 2 Move the cursor to the bank field of the pad for which you want to use the Slice function, and select the sample bank.

- 3 Move the cursor to the SLICE field of the pad for which you want to use the Slice function, and select one of the following as the slice setting.

- OFFThe Slice function will not be used.
- 8The playback region of the sample will be divided into eight equal segments.
- 12The playback region of the sample will be divided into twelve equal segments.
- 16The playback region of the sample will be divided into sixteen equal segments.



- Normally when you use the Slice function, you will select the number of segments based on the shortest note value in the original phrase. For example you would use a setting of 16 if the shortest note value in the original phrase is a sixteenth note, a setting of 12 for eighth note triplets, or a setting of 8 for eighth notes.
- If the Slice function is OFF, the waveform will play from the beginning of the measure without being divided. If the waveform is longer than one measure, it may not play completely.

- 4 Move the cursor to the MONITOR TEMPO field, and turn the [DATA/JOG] dial to select SONG.

The MONITOR TEMPO field selects one of the following as the basic tempo at which the phrase will be played if you play the sample while the recorder is stopped.

- ORIGINAL.....The original tempo of the sample, shown in the BPM field
 - SONG.....The tempo specified by the tempo map
 - 30-250The numerically specified tempo
- If you select SONG, the playback timing of each segment will be adjusted according to the tempo that is specified by the tempo map for the current location.

The following diagram shows how, for a sample with an original tempo of 100 BPM, the playback timing of each segment will change at a song tempo of 120 BPM or 80 BPM.

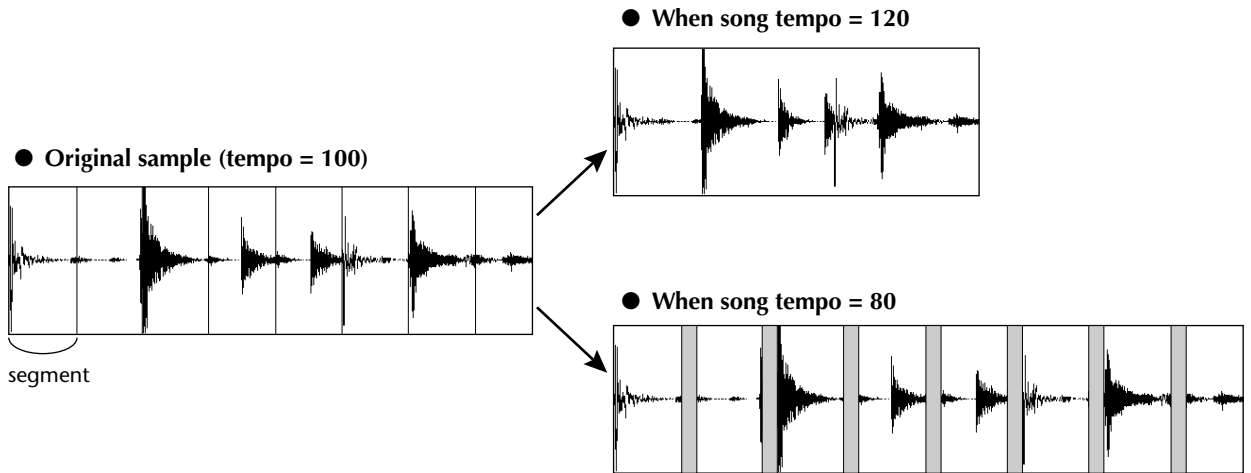

- 5** Strike the pad to hear the result.
If the playback of the sample is broken in an unnatural way, go back to step 3 and try changing the number of segments into which the sample is divided. However, this may not improve the result if there is too great a difference between the tempo of the sample and the tempo of the current song.
- 6** Repeatedly press the [TRACK] key or hold down the [TRACK] key and use the CURSOR [▲]/[▼] keys to access the VIEW page of the TRACK screen.
- 7** Play back the song, and press the pad for which you turned the Slice function on.
The phrase of the sample assigned to the pad will play in synchronization with the tempo of the current song. If you have input data in the tempo map to change the tempo during the song, the sample phrase will follow the change. (For details on tempo map settings → p. 142.)

Deleting an unwanted sample

Here's how you can delete unused data (before the start point and after the end point) from a specific sample, or completely erase an individual sample.

- 1 In the Quick Loop Sampler section, repeatedly press the [SAMPLE EDIT] key or hold down the [SAMPLE EDIT] key and use the CURSOR [▲]/[▼] keys to access the MEMORY page of the SAMPLE screen.

In this page you can delete the unused portion of a sample, or erase an unwanted sample.

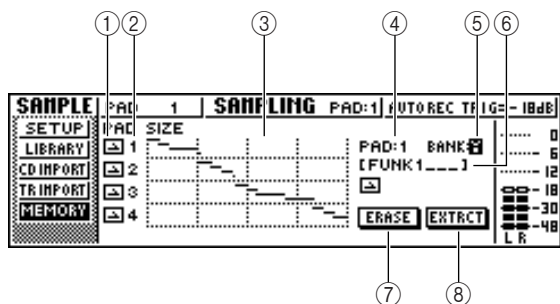

① One Shot/Loop mode

This icon indicates whether One Shot mode (☐) or Loop Mode (◻) is selected for the sample assigned to the pad.

② Pad number

Indicates the pad number 1–4.

③ Size

This area graphically indicates the memory size of each sample. The horizontal line indicates the amount of memory used by each pad.

④ PAD

⑤ BANK

These select the pad (1–4) and sample bank (A–D) to which the operation will apply.

⑥ Sample name

Indicates the name of the sample for the pad and sample selected in ④ and ⑤.

⑦ ERASE button

Erases the specified sample.

⑧ EXTRACT button

Discards the unused portions (before the start point and after the end point) of the specified sample.



Tip! For details on how to adjust the start point and end point of a sample, refer to page 118.

- 2 Move the cursor to the PAD/BANK fields, and turn the [DATA/JOG] dial to select the pad and sample bank.

The procedure after this point will depend on the function that you want to execute.

■ To erase the entire sample

- 1 To erase the entire selected sample, move the cursor to the ERASE button and press the [ENTER] key.

A popup window will ask you to confirm that you want to erase the sample.

- 2 To execute the erasure, move the cursor to the OK button and press the [ENTER] key.

If you decide to cancel, move the cursor to the CANCEL button and press the [ENTER] key.

■ To delete the unused portions of the selected sample

- 1 Move the cursor to the EXTRACT button and press the [ENTER] key.

A popup window will ask you to confirm that you want to delete the data.

- 2 To execute the deletion, move the cursor to the OK button and press the [ENTER] key.

If you decide to cancel, move the cursor to the CANCEL button and press the [ENTER] key.

Chapter 12

Track editing

This chapter explains how you can edit the audio data recorded in an audio track, and how to edit the pad events recorded in a pad track.

What you can do using editing commands

The AW16G provides various editing commands for editing the recorded audio tracks and pad tracks. Editing commands are functions that let you specify a track or region, and delete or move the data of that track or region. The AW16G provides the following editing commands.

- **ERASE**
Erases the data of the specified region.
- **DELETE**
Deletes the data of the specified region. Any data that follows the deleted region will be moved forward by the corresponding distance.
- **INSERT**
Inserts blank space into the specified region.
- **COPY**
Copies the data from the specified region to the desired location of the desired track.
- **MOVE**
Moves the data from the specified region to the desired location of the desired track. The move-source data will be erased.
- **EXCHANGE**
Exchanges data between the specified tracks.
- **TIME COMP/EXP (Time Compression/Expansion)**
Adjusts the length of the specified region of an audio track without affecting its pitch.
- **PITCH CHANGE**
Adjusts the pitch of the specified region of an audio track without affecting its length.
- **EXPORT**
Writes the specified region of an audio track (or a sample assigned to a pad) to a WAV file.



The EXCHANGE, TIME COMP/EXP, PITCH CHANGE, and EXPORT commands can only be used on audio tracks. The remaining commands can be used on either audio tracks or pad tracks.

Here are some ways in which you can use these editing commands.

- ① **Erase unwanted regions**
You can use the ERASE command to erase just a specific region of a specific track. For example, this provides a convenient way to erase a few wrong notes from a performance, or to eliminate noise that occurred while an instrument was not playing.
- ② **Change the structure of the tracks**
You can use the EXCHANGE command to exchange an entire track with another track. By using this command you can bring tracks of widely separated track numbers closer to each other for easier operation during mixdown.
You can use the COPY or MOVE commands to copy/move the specified region of a track to a different track. This is convenient when you have recorded a solo part among two or more virtual tracks, and want to assemble the best parts into a single track.
- ③ **Change the structure of the song**
You can use the DELETE or COPY commands to delete/copy entire tracks, changing the structure of the song itself. Even after all parts of the song have been recorded, you can use this method to adjust the length of the song, for example by shortening the number of measures or increasing the number of choruses.
- ④ **Create special effects**
You can also use editing commands to create special effects. For example, you can copy a guitar or vocal solo part to another track and use the PITCH CHANGE command to slightly detune one of these tracks, creating a chorus effect without using the internal effect processor. By applying the PITCH CHANGE command to a drum track to lower the pitch, you can create a unique lo-fi effect.

Basic procedure for track editing

Here is the basic procedure for using a track editing command. The procedure is essentially the same for all track editing commands.

■ Select the editing command

- 1** In the Work Navigate section, repeatedly press the [EDIT] key.

The EDIT screen will appear. This screen displays the following information.

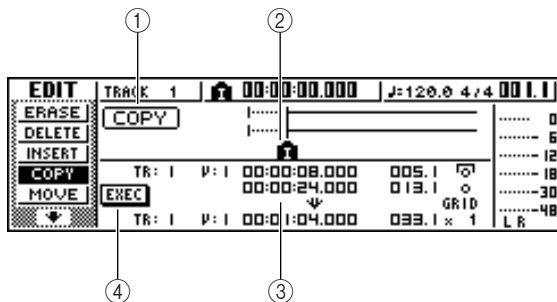

- ① Editing command**
Indicates the currently selected editing command.
- ② Locator/marker**
Indicates the approximate location of the currently set locate points and markers.
If the current track is selected as the virtual track to be edited, the approximate range(s) of recorded data will also be displayed.
- ③ Parameters**
Sets various parameters (track/virtual track number, editing region, etc.) required in order to execute the command. The type of parameters and the ranges of the settings will depend on the command that is selected.
- ④ EXEC button**
Move the cursor to this button and press the [ENTER] key to execute the editing command.

- 2** Repeatedly press the [EDIT] key or hold down the [EDIT] key and use the CURSOR [▲]/[▼] keys to select the desired editing command.

The EDIT screen is divided into pages for each editing command. For example, a screen like the one shown below will appear if you choose the ERASE command.

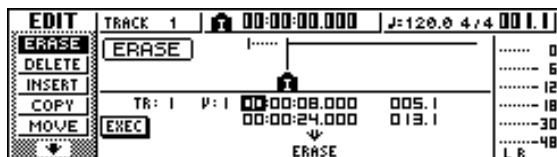

■ Select the track(s) to edit

After you choose an editing command, the next step is to specify the track(s) that will be edited.

- 3** To select the track for editing, move the cursor to the TR (Track) field in the lower left of the EDIT screen, and turn the [DATA/JOG] dial.

For any command, the TR (Track) field will appear in the lower left of the screen, allowing you to select the track(s).



In the TR field you can select the following types of data.

- CLIP** Sound clip
- 1-16** An audio track
- 1/2-15/16** A pair of adjacent odd-numbered/even-numbered audio tracks
- STEREO** The stereo track
- PAD** A pad track
- ALL** Audio tracks 1-16 and pad tracks 1-4
- SMPL** All samples of the quick loop sampler

Note

The data that can actually be selected will depend on the command.

- 4** Select the virtual track or pad that you want to edit.

If you selected an audio track (1-16, 1/2-15/16, STEREO) in step 3, the V (V.TRACK) field will appear at the right, allowing you to select the virtual track number. Move the cursor to this field and select a virtual track number 1-8.

Virtual track number



If you selected PAD in step 3, a field allowing you to select pad number will appear at the right. Move the cursor to this field and select a number 1-4.

Pad number



Note

For some commands, you will need to specify both source and destination tracks.

■ Specify the editing region

For most commands, you will need to set the Start (the beginning of the edited region) and End (the end of the edited region) parameters to specify the region that will be affected by the command.

- 5 To specify the beginning of the region to be edited, move the cursor to the desired digit of the Start field, and turn the [DATA/JOG] dial.

The Start/End parameters are displayed at the right of the TR field.

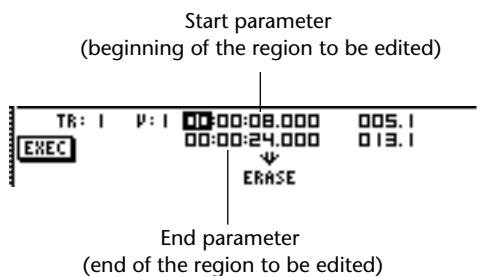

You can set the Start/End parameters in terms of the counter display format (the value at the left) or in units of measures/beats (the value at the right). Move the cursor to the digit that you want to change, and turn the [DATA/JOG] dial to set the value.

- 6 To specify the end of the region to be edited, move the cursor to the desired digit of the End field, and turn the [DATA/JOG] dial.



If you move the cursor to the Start or End parameter and press the [ENTER] key, the current counter location will be input. Alternatively, you can recall a locate point or marker to move to that location in the song, and then press the [ENTER] key to input that location as the value of the Start or End parameter.



For some commands, you will also need to specify a location in the editing-destination track. In the same way as described above, move the cursor to the counter display format field or the measure/beat field, and specify the location.

■ Execute the command

When you have finished setting parameters, execute the command.

- 7 Move the cursor to the EXEC button, and press the [ENTER] key.

A popup window will ask you to confirm the operation.



- 8 Move the cursor to the OK button to execute the command, or move the cursor to the CANCEL button to cancel without executing. Then press the [ENTER] key.



Even after you press the [ENTER] key to execute the command, you can press the [UNDO/REDO] key to return to the state prior to executing the command. You can use this function to compare the original data with the results produced by executing the command.



If as a result of executing a command, a track no longer contains any recorded data, the name of that track will change to "-NO REC-".

List of editing commands

This section lists all the commands that are provided in the EDIT screen, and explains their parameters.

ERASE

Erases the data in the specified region (between Start and End) of the specified track(s).

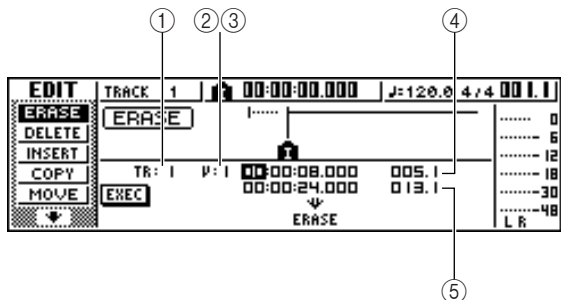

● For an audio track

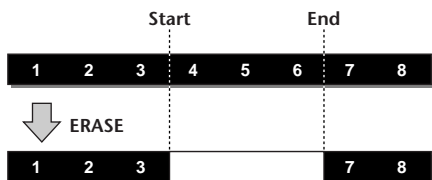

● For a pad track (loop)

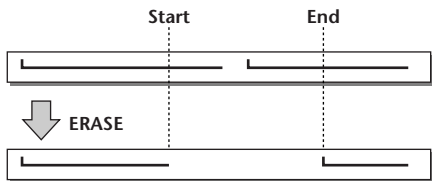

● For a pad track (one shot)

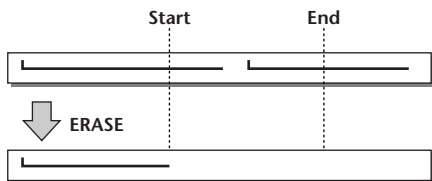

If you select the pad track of a pad that is set to one-shot mode, all pad events whose attack falls within the Start/End region will be erased.

■ Parameter list

Parameter	Range	Explanation
① TRACK	1-16	A single audio track
	7/2-15/16	A pair of adjacent odd-numbered/even-numbered audio tracks
	STEREO	The stereo track
	PAD	A single pad track
	ALL	Tracks 1-16 + Pad tracks 1-4
② V.TR ^{*1}	1-8	Virtual track number
③ PAD ^{*2}	1-4	Pad number
④ Start	Specify a point	Beginning of the edited region
⑤ End	Specify a point	End of the edited region

*1. ② V.TR can be selected only if TRACK=1-16, 1/2-15/16, or STEREO.

*2. ③ PAD can be selected only if TRACK=PAD.

DELETE

Deletes the data from the specified region of the specified track(s).

This command is similar to ERASE, but differs in that the data that follows the specified region will move forward to fill the gap.

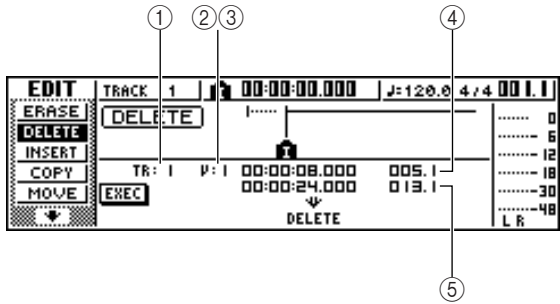

● For an audio track

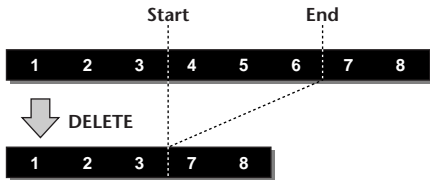

● For a pad track (loop)

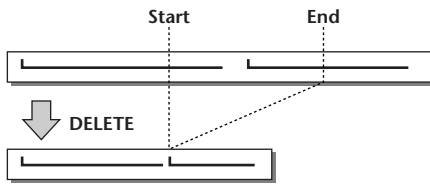

● For a pad track (one shot)

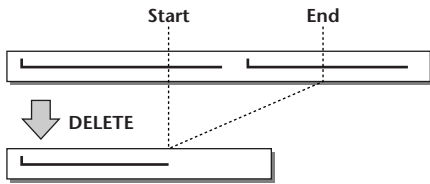

Note

If you select the pad track of a pad that is set to one-shot mode, all pad events whose attack falls within the Start/End region will be erased.

■ Parameter list

The parameters are the same as for the ERASE command.

INSERT

Inserts blank space into the specified region. Data following the location of the Start parameter will be moved backward to make room.

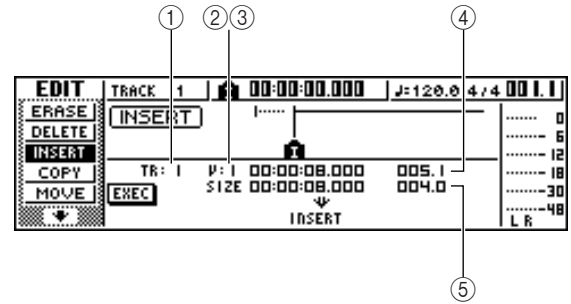

● For an audio track

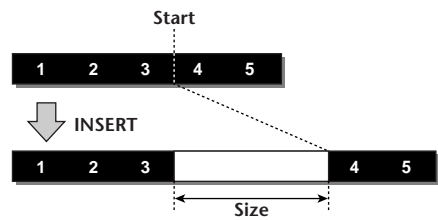

● For a pad track (loop)

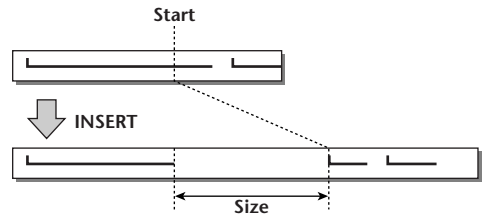

● For a pad track (one shot)

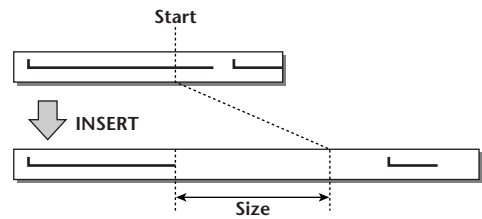

■ Parameter list

The parameters are the same as for the ERASE command. However instead of ⑤ End, use ⑤ Size to specify the region that will be inserted.

COPY

Copies the specified region of data to the specified location of the specified track.

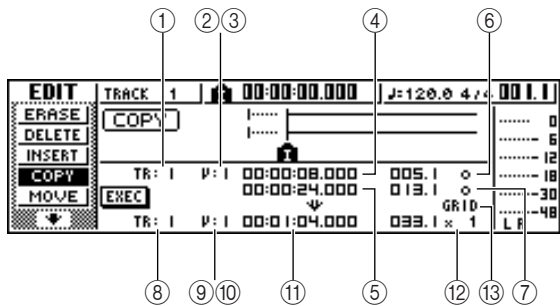

● For an audio track

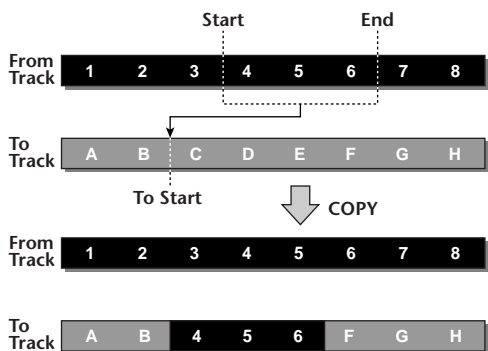

● For a pad track (loop)

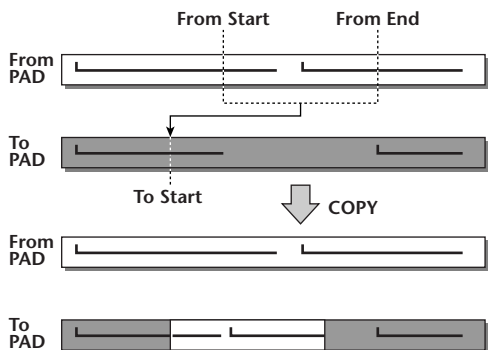

If you set ② From TRACK to other than ALL (INS), the copy-destination track will be overwritten, and the data that follows the copied region will not be moved backward.
 If you set ② From TRACK to ALL (INS), the copy-destination track will be moved backward by the size of the copied region. Note that this may cause the bar lines specified by the tempo map to change their location relative to the audio data.

● For a pad track (one shot)

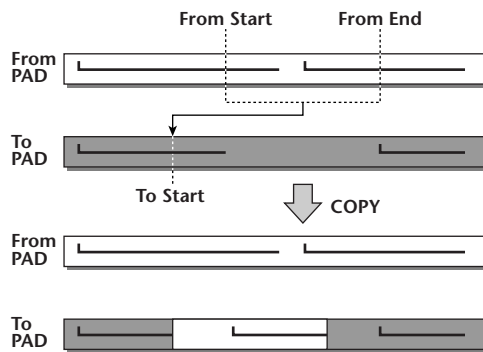

■ Parameter list

Parameter	Range	Explanation
① From TRACK	CLIP	Content recorded in a sound clip (the region specified by CLIP)
	1-16	A single audio track
	1/2-15/16	A pair of adjacent odd-numbered/even-numbered audio tracks
	STEREO	The stereo track
	PAD	A single pad track
	ALL (OVER)	Tracks 1-16 + Pad tracks 1-4 (overwrite onto the copy-destination)
	ALL (INS)	Tracks 1-16 + Pad tracks 1-4 (insert into the copy-destination)
② From V.TR ^{*1}	1-8	Copy-source virtual track number
③ From PAD ^{*2}	1-4	Copy-source pad number
④ From Start		Specify a point
⑤ From End		Specify a point
⑥ Start Measure Lock ^{*3}		On/off (indicated by "lock" icon)
⑦ End Measure Lock ^{*3}		
⑧ To TRACK ^{*4}	1-16	A single audio track
	1/2-15/16	A pair of adjacent odd-numbered/even-numbered audio tracks
	STEREO	The stereo track
	PAD	A single pad track
⑨ To V.TR ^{*1}	1-8	Copy-destination virtual track number
⑩ To PAD ^{*2}	1-4	Copy-destination pad number
⑪ To Start		Specify a point
⑫ To Times	1-99	Number of copies
⑬ GRID ^{*5}		ON/OFF (indicated by highlighted GRID text when on)

- *1. ② From V.TR and ⑨ To V.TR can be selected only if From TRACK=1-16, 1/2-15/16, or STEREO.
- *2. ③ From PAD and ⑩ To PAD can be selected only if TRACK=PAD.
- *3. Measure lock function (⑥ Start Measure Lock, ⑦ End Measure Lock)

"Measure lock" is a function that matches the beginning of the measure or beat included in the copy-source region with the desired location of the copy-destination.

To use the measure lock function, move the cursor to the measure display field of From Start or From End, specify the measure/beat location that

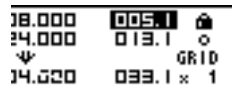

will be the reference point for the matching, and press the [ENTER] key. A "lock" icon will appear beside the value that you specified, and the measure lock function will be turned on for From Start or From End. (This can be turned on for either Start or End, not both.)

While the measure lock function is on, the value of that measure display format setting will be fixed, and cannot be modified. In this state if you use the counter display format field to specify the From Start and From End locations, and execute the copy, the location you specified in the measure display format field will be aligned with the copy-destination To Start setting.

● When measure lock = on

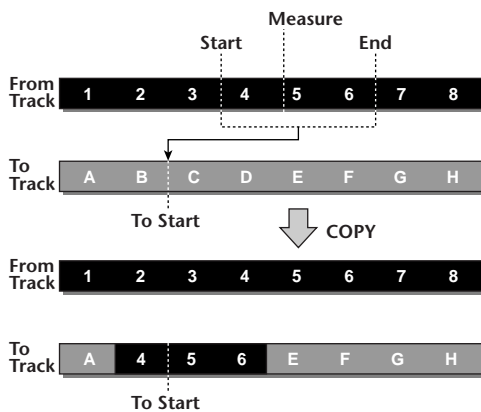

- *4. The possible choices for ⑧ To TRACK (copy-destination track) will depend on your selection for ① From TRACK (copy-source track).
 If ① From TRACK is a single audio track 1-16, you will be able to select only a single audio track 1-16.
 If ① From TRACK is CLIP, STEREO, 1/2-15/16 (a pair of adjacent audio tracks), you will be able to select only STEREO or 1/2-15/16 (a pair of adjacent audio tracks).
 If ① From TRACK is PAD, you will be able to select only PAD.
 If ① From TRACK is ALL (OVER) or ALL (INS), you cannot select TO TRACK.
- *5. Grid function (⑬ GRID)

When this function is on, the To Start location cannot be specified in counter-display format; it can be specified only in measure/beat units.

By using the Grid function in conjunction with the Measure Lock function, you can easily copy measure/beat-length segments of data whose divisions do not fall precisely on the measure or beat.

MOVE

Moves the specified region of data to the specified location of the specified track. This is similar to COPY, but differs in that the move-source data will be deleted.

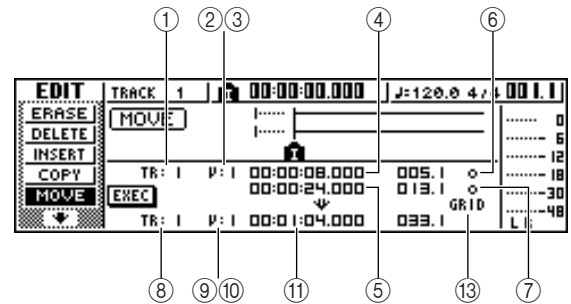

● For an audio track

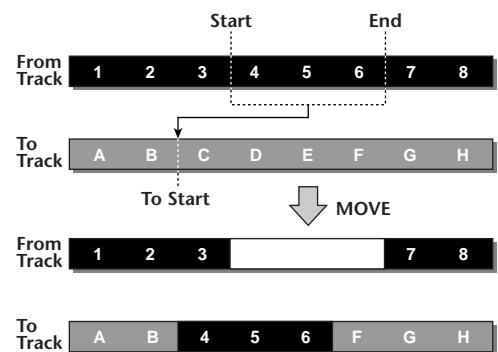

● For a pad track (loop)

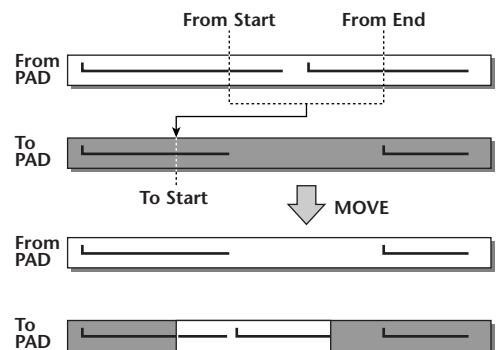

● For a pad track (one shot)

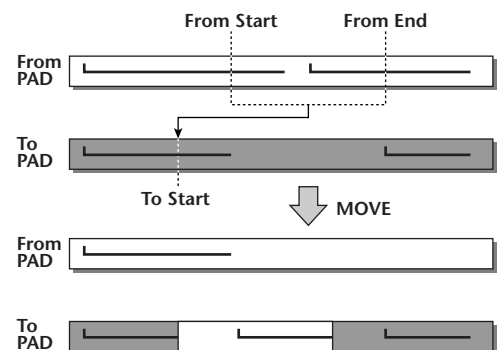

■ Parameter list

The parameters are the same as for the COPY command. However, you cannot select CLIP for ① From TRACK. Also, there is no ⑫ To Times setting.

EXCHANGE

Exchanges data between the specified tracks.

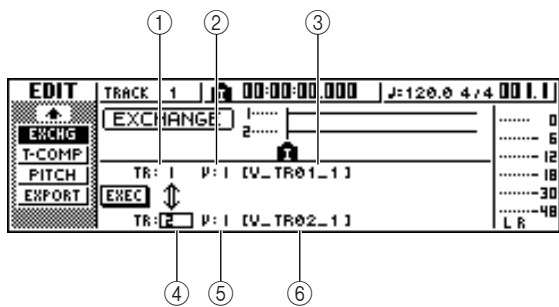

● For an audio track

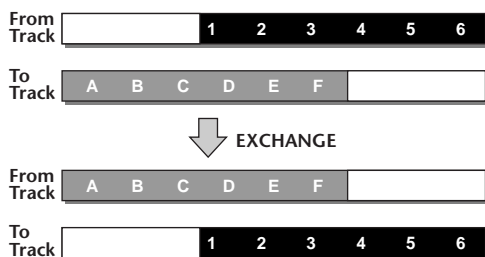

Parameter list

Parameter	Range	Explanation
① From TRACK	1-16	A single audio track
	1/2-15/16	A pair of adjacent odd-numbered/even-numbered audio tracks
	STEREO	The stereo track
② From V.TR	1-8	Exchange-source virtual track number
③ Name	Up to eight alphanumeric characters	Exchange-source virtual track name (display only)
④ To TRACK*1	1-16	A single audio track
	1/2-15/16	A pair of adjacent odd-numbered/even-numbered audio tracks
⑤ To V.TR	1-8	Exchange-destination virtual track number
⑥ Name	Up to eight alphanumeric characters	Exchange-destination virtual track name (display only)

*1. The items that you can select in ④ To TRACK (copy-destination track) will depend on the ① From TRACK (copy-source track) setting.
 If ① From TRACK is a single audio track 1-16, you can select only a single audio track 1-16.
 If ① From TRACK is STEREO or 1/2-15/16 (a pair of adjacent audio tracks), you can select only 1/2-15/16 (a pair of adjacent audio tracks).



The track names will not be exchanged.

TIME COMP/EXP (Time Compression/Expansion)

Adjusts the length of the specified region of an audio track, without changing the pitch.

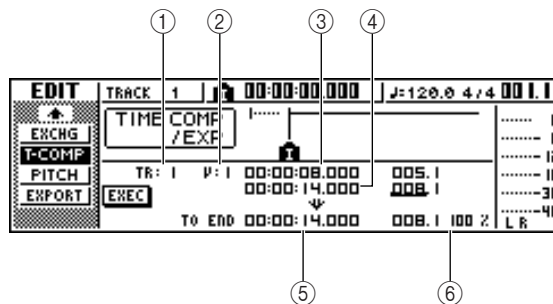

● If you set Ratio = 50%

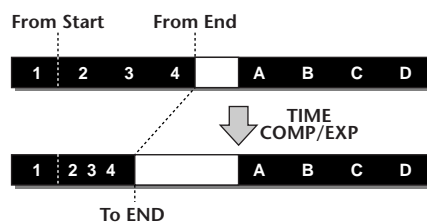

● If you set Ratio = 200%

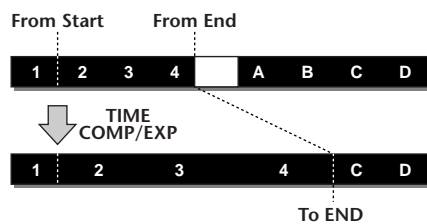

Parameter list

Parameter	Range	Explanation
① From TRACK	1-16	A single audio track
	1/2-15/16	A pair of adjacent odd-numbered/even-numbered audio tracks
	STEREO	The stereo track
② From V.TR	1-8	Virtual track number
③ From Start	Specify a point	Beginning of the edited region
④ From End	Specify a point	End of the edited region
⑤ To End	Specify a point	Specify the length to which the selected region will be compressed or expanded
⑥ To Ratio	50-200%	Specify the percentage by which the selected region will be compressed or expanded



- To End and To Ratio are linked, so that editing one field will cause the other field to change.
- You cannot set To End or To Ratio to a value that would cause the ratio to exceed 50-200 percent.
- From Start value and From End value must be at least 45 msec apart. These cannot be set to a shorter interval.

PITCH CHANGE

Adjusts the pitch of the specified region of an audio track, without changing the length.

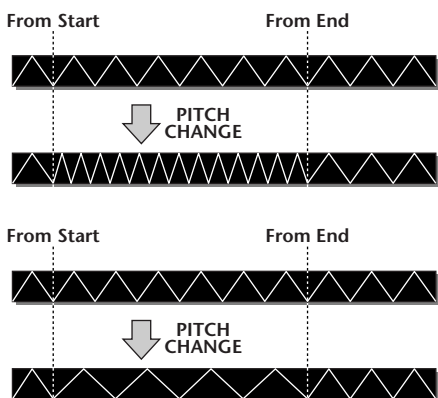
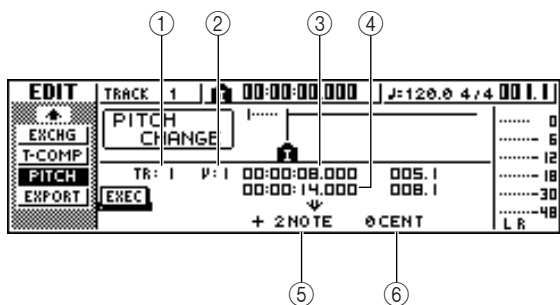

Parameter list

Parameter	Range	Explanation
① From TRACK	1-16	A single audio track
	1/2-15/16	A pair of adjacent odd-numbered/even-numbered audio tracks
	STEREO	The stereo track
② From V.TR	1-8	Virtual track number
③ From Start	Specify a point	Beginning of the edited region
④ From End	Specify a point	End of the edited region
⑤ Pitch	-12 to +12 semitones	Specify the amount of pitch change in semitone units
⑥ Fine	-50 to +50 cents	Specify the amount of pitch change in one-cent units (1/100th of a semitone)

EXPORT

Writes the specified region of an audio track or all samples assigned to a pad to a WAV file.

Use this when you want to transfer audio data to your computer so that you can edit the data using a waveform editing program.

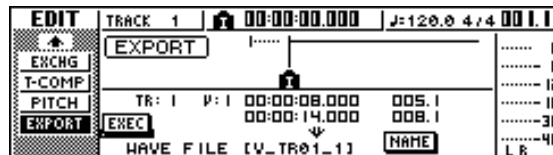

For details on the parameters and procedure for the Export command, refer to "Exporting WAV files" (→ p. 132).

Exporting WAV files and importing audio CD or WAV files

This section explains how data from an AW16G audio track or from a sample assigned to a pad can be written (exported) to external media as a WAV file, and how a WAV file or CD audio data from external media can be loaded (imported) into an AW16G audio track.

Exporting WAV files

Any audio track of the AW16G or all sample data from memory can be written as one or more WAV files onto CD-R/RW media inserted in the CD-RW drive. This is convenient when you want to send audio data to your computer, or use waveform editing software to edit it.



- In order to write WAV files, you must use CD-R/RW media to which no data has been written.
- You cannot add data to CD-RW media that already contains data. You must first erase the CD-RW media.
- You cannot write a single WAV file that is larger than the capacity of the media.

- 1 Insert CD-R/RW media into the CD-RW drive.
- 2 In the Work Navigate section, press the [EDIT] key.
The EDIT screen will appear.
- 3 Repeatedly press the [EDIT] key or hold down the [EDIT] key and use the CURSOR [▲]/[▼] keys to access the EXPORT page.
This page shows the following information.

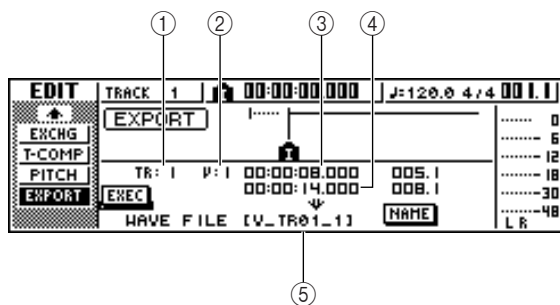

Parameter	Range	Explanation
① From TRACK	1-16	A single audio track
	1/2-15/16	A pair of adjacent odd-numbered/even-numbered audio tracks
	STEREO	The stereo track
	Tr1-16	The current track of tracks 1-16
	SMPL	All samples in memory
② From V.TR	1-8	Virtual track number
③ From Start	Specify a point	Beginning of the audio track region that will be written
④ From End	Specify a point	End of the audio track region that will be written
⑤ File Name*1	Up to eight alphanumeric characters	Displays the name of the file to which the data will be written

*1. The name of the individual source track (or odd-numbered track in the case of a pair) will be assigned by default.

- 4 Move the cursor to the From TRACK field, and select the source data (audio track or sample) that you want to write.
If you select "Tr1-16," the current tracks of tracks 1-16 will be written as separate monaural WAV files.
If you select "1-16," the single specified track will be written as a monaural WAV file.
If you select "1/2-15/16" or STEREO, the specified pair of tracks (or the STEREO track) will be written as a stereo WAV file.
If you select "SMPL," all samples in memory will be written as individual stereo WAV files.
- 5 If you selected 1-16, 1/2-15/16, or STEREO as the source for exporting, move the cursor to the From V.TR, From Start, and From End fields, and specify the virtual track number and region that will be exported.



If you selected Tr1-16 as the export-source, the current tracks for all sixteen tracks will be written automatically. It is not possible to specify the virtual track number for each.

6 If necessary, move the cursor to the NAME field, press the [ENTER] key, and input a file name in the TITLE EDIT popup window.

For details on how to input a name, refer to page 24.

Note

- If you selected Tr1-16 as the export-source, the first six characters of the song name + track number + “.WAV” will automatically become the file name. This name cannot be changed.
- In the file name you can use only uppercase alphabetical characters, numerals, and “_” (underscore). Lowercase alphabetical characters used in a song name will be converted to uppercase characters, and all symbols other than alphabetical characters and numerals will be converted to “_”.
- If you selected SMPL as the export-source, the filename will automatically be “SMPL” + pad number + “_” + bank number + “.WAV.” This name cannot be changed.

7 When you have finished setting the parameters, move the cursor to the EXEC button and press the [ENTER] key.

A popup window with “Execute EXPORT?” will appear, asking you to confirm the operation.



8 To execute the export, move the cursor to the OK button and press the [ENTER] key.

Exporting will begin. If you move the cursor to the CANCEL button (instead of the OK button) and press the [ENTER] key, the export operation will be cancelled. (However, it is not possible to abort the export process once it has been started.)

Only if you selected “Tr1-16” as the export-source, the maximum of sixteen WAV files can be distributed between multiple volumes of media as they are exported. (Even in this case, it is not possible to write a single WAV file that is larger than the capacity of the media.) When the “Exchange Next Media” popup window appears, exchange the media and press the [ENTER] key.

Tip!

- All WAV files will be written to the root directory.
- Since the AW16G does not have a concept of the real-world date and time, dummy values will be written as the file creation date and time of the WAV files.

Note

- If CD-R/RW media that contains no data is inserted, WAV file export will begin.
- If CD-RW media that contains data is inserted, a message of “Erase CD-RW media?” will appear, suggesting that you erase the media. Move the cursor to the OK button and press the [ENTER] key to erase the media, or exchange the media.
- If media other than the above is inserted, it will automatically be ejected, and a message of “Change Media, Please.” will appear. If this message appears, exchange the media.
- Tracks that do not contain data in the specified region will not be exported.

Importing from an audio CD or WAV file

CD audio data (CD-DA) or a WAV file from a CD-ROM or CD-R can be imported (loaded) into an AW16G audio track. After being imported, this data can be handled in the same way as any recorded audio track.

1 If you want to import from an audio CD, repeatedly press the Work Navigate section [UTILITY] key or hold down the [UTILITY] key and use the CURSOR [▲]/[▼] keys to access the D.IN • HDD page of the UTILITY screen.

Immediately after the AW16G is powered-on, it will be set to prohibit digital recording from an external source or importing from a CD. Before you can import, you will need to disable this prohibition in the D.IN - HDD page of the UTILITY screen.

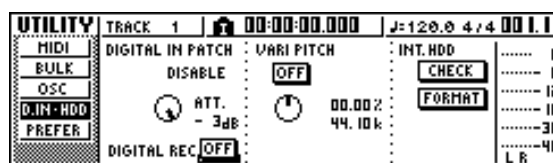

2 Move the cursor to the DIGITAL REC button, and press the [ENTER] key.

A message will ask you to confirm that you will observe the applicable copyright laws.



3 Carefully read “Copyright Notice” (→ p. 5), and if you accept these terms, move the cursor to the OK button and press the [ENTER] key.

The button display will change from OFF to ON, and digital recording and importing from a CD will be enabled.

Note

The DIGITAL REC button will return to the OFF setting each time you turn on the power.

4 Insert a CD into the CD-RW drive.

You can import data from the following types of media.

● Audio data (CD-DA)

- Audio CD
- CD-Extra (only the first session of CD-DA)
- Mixed Mode CD (only CD-DA data of the second and later tracks)

● WAV files

- ISO9660 Level 1 format CD-ROM, CD-R, CD-RW*
- Mixed Mode CD

*The directory name and file name cannot use characters other than uppercase alphanumeric characters and the “_” (underscore) character. If you use the AW16G to export WAV files onto CD-R/RW media, the data will be in ISO9660 Level 1 format, but please be aware of this restriction if you use a computer to create WAV files.

5 In the Work Navigate section, repeatedly press the [TRACK] key or hold down the [TRACK] key and use the CURSOR [▲]/[▼] keys to access the CD IMPORT page.

The READ CD INFO button will appear in the center of the display.

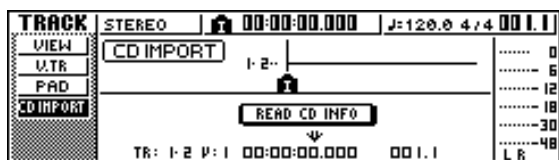

6 Press the [ENTER] key.

The display will indicate “Read CD Info...,” and information will be read from the CD inserted in the CD-RW drive.

Depending on the import-source data, the screen will change as follows.

● When importing from audio CD/CD-Extra

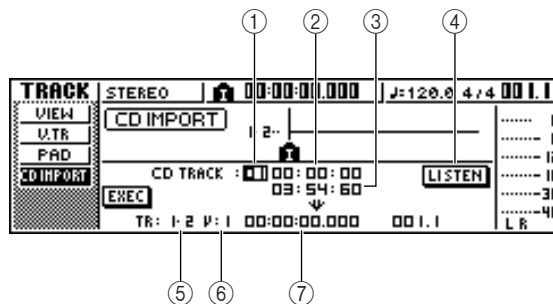

① From CD TRACK

Specifies the audio track number (01–99) of the import-source CD.

② From Start

Specifies the beginning of the data that will be imported, in minutes/seconds/frames (1/75 second).

③ From End

Specifies the end of the data that will be imported, in minutes/seconds/frames (1/75 second).



The “frames” referred to here are the minimum time-axis units used in CD-DA. Do not confuse them with the frames used in MTC or SMPTE.

④ LISTEN button

You can move the cursor to this button and press the [ENTER] key to repeatedly hear the currently selected region of the CD-DA.

⑤ To TRACK

Selects the track number into which the data will be imported. If the import-source is an audio CD or a stereo WAV file, you will only be able to select a pair of tracks 1/2–15/16.

⑥ To V.TR

Selects the virtual track number (1–8) into which the data will be imported.

⑦ To Start

Specifies the starting location (in counter-display format) of the import-destination to which the data will be imported.

● When importing a WAV file

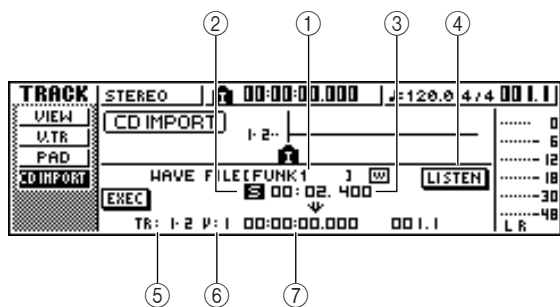

- ① **From WAVE file**
 Selects the WAV file that will be imported.
 If the media contains folders (directories), move to the folder that contains the WAV file you want to import, and then specify the desired WAV file.
 The icons shown here have the following meaning.

	Indicates that a WAV file is selected.
	Indicates that a folder in the same level is selected.
	Indicates that the folder in the next higher level is selected.
- ② **Mono/stereo**
 Indicates whether the WAV file selected for importing is monaural (M) or stereo (S). This field is for display only, and cannot be changed.
- ③ **Size**
 Indicates the playback length (in msec) of the WAV file selected for importing. This field is for display only, and cannot be changed.
- ④ **LISTEN/ENTER/UP button**
 The name and function of the button displayed here will change depending on the item that is selected by the From WAVE file parameter.
 - If a WAV file () is selected
 The LISTEN button will be displayed, allowing you to hear the WAV file repeatedly.
 - If a folder in the same level () is selected
 The ENTER button will be displayed, allowing you to move into that folder.
 - If the next higher folder () is selected
 The UP button will be displayed, allowing you to move to the next higher folder.
- ⑤ **To TRACK**
- ⑥ **To V.TR**
- ⑦ **To Start**
 These fields are the same as when you are importing from audio CD or CD-Extra.

Note

- If a Mixed Mode CD is inserted in the CD-RW drive, a popup window will appear, allowing you to select AUDIO (CD-DA) or WAVE (WAV files) to import. Move the cursor to the button for the data that you want to import, and press the [ENTER] key.
- You can import only monaural or stereo WAV files that are in 16-bit/44.1 kHz format.
- When you move the cursor to the LISTEN button and press the [ENTER] key, there will be a slight time lag while the data is read from the CD before you hear it.

7 If you are importing a WAV file, move the cursor to the From WAVE file field, and turn the [DATA/JOG] dial to select the WAV file that you want to import.

To move to a lower level, display the icon in this field, then move the cursor to the ENTER button in the screen and press the [ENTER] key.

To move to the next higher level, display the icon in this area, then move the cursor to the UP button and press the [ENTER] key.

8 If you are importing from audio CD or CD-Extra, use the From Start and From End fields to specify the region that will be imported.

9 Use the To TRACK, To V.TR, and To Start fields to specify the track number, virtual track number, and starting location into which the data will be imported.

Note

If the import-destination already contains data, it will be overwritten. Be careful not to accidentally overwrite important data.

10 When you have finished making settings, move the cursor to the EXEC button and press the [ENTER] key.
 A popup window will ask you to confirm the operation.



11 To execute the import operation, move the cursor to the OK button and press the [ENTER] key.

Importing will begin. If you move the cursor to the CANCEL button and press the [ENTER] key, importing will be cancelled.

Tip!

Even after you press the [ENTER] key, you can press the [UNDO/REDO] key to return to the state prior to importing, as long as you have not executed any editing or recording operation since the import.

Note

You cannot execute the Import operation while the AW16G is running.

Chapter 13

Song management

This chapter explains how to perform song management operations such as copying, deleting, backing up, and restoring songs.

About songs

On the AW16G, your recorded compositions are managed in units called “songs.” When you save a song on the hard disk, the audio data, the sample data used by the quick loop sampler, scene memories, and the data for each library are all stored together. By loading a saved song, you can return it to the original condition at any time.

You can store as many songs on the internal hard disk as its capacity allows. Each song can occupy a maximum of 6.4 GB. The songs stored on the hard disk consist of a setup area that stores various settings (fixed at approximately 4.3 MB) and a data area that stores the audio data (the size of this will depend on the amount of data that you recorded).

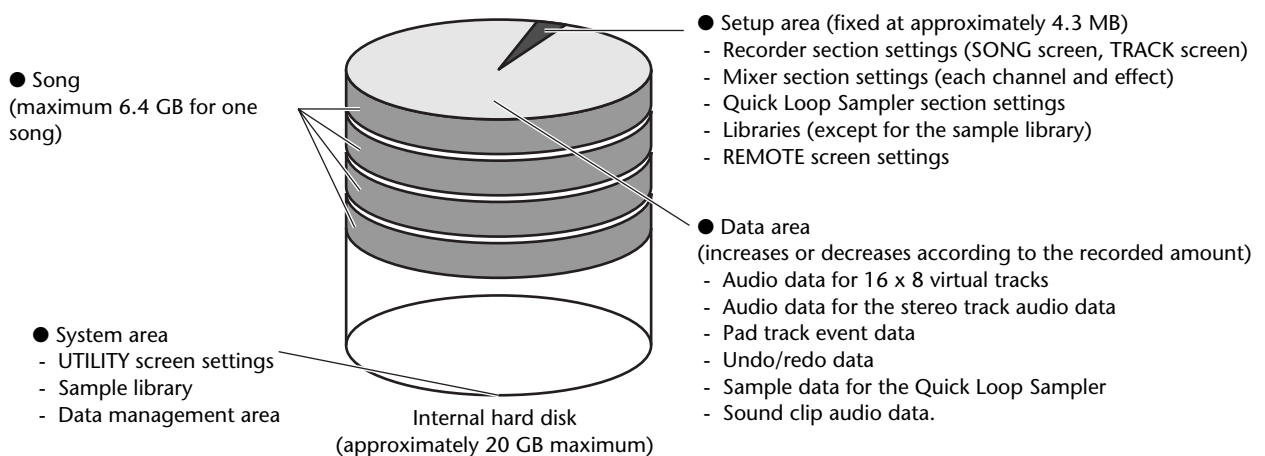

Note

- *The data area of a song also includes undo/redo data that is not used for normal playback. You can use the Optimize operation to delete this undo/redo data. (→ p. 141).*
- *The sound clip audio data area is allocated when you create a new song. This area is allocated according to the SOUND CLIP TIME setting in the PREFER page of the UTILITY screen (→ p. 162), and cannot be changed later.*

Editing the song name

Here's how to edit the song name that is assigned when you create a new song.



- *This setting applies only to the current song. Before you perform this procedure, load the song whose name you want to edit.*
- *The edited name will be saved with the song data when you save the song.*

1 In the Work Navigate section, press the [SONG] key.

The SONG screen will appear.

2 Repeatedly press the [SONG] key or hold down the [SONG] key and use the CURSOR [▲]/[▼] keys to access the SETUP page.

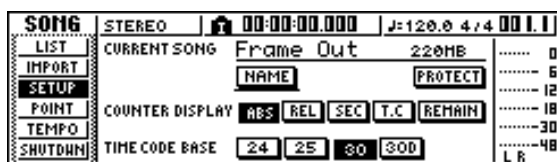

3 To edit the song name, move the cursor to the NAME button and press the [ENTER] key.

The TITLE EDIT popup window will appear, allowing you to edit the song name.



4 Input the new name. Then move the cursor to the OK button and press the [ENTER] key.

The new name will be applied, and the popup window will close. (For details on inputting a name → p. 24)

Editing various settings for the song

Here's how to make various settings for a song, such as switching protect on/off and selecting the counter display format and time code format.



- These settings apply only to the current song. Before you perform this procedure, load the song whose settings you want to edit.
- The edited settings will be saved with the song data when you save the song.

1 In the Work Navigate section, press the [SONG] key.

The SONG screen will appear.

2 Repeatedly press the [SONG] key or hold down the [SONG] key and use the CURSOR [▲]/[▼] keys to access the SETUP page.

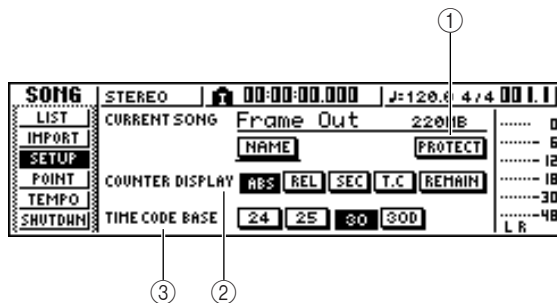

This page contains the following items.

- PROTECT button**
Switches protect on/off.
- COUNTER DISPLAY**
Selects the display format for the counter that appears in the center of the top line in the display.
- TIME CODE BASE**
Selects the format (the number of frames per second) for the time code used by the AW16G.

3 To switch the protect setting on/off, move the cursor to the PROTECT button and press the [ENTER] key.

Protect is a setting that prohibits any change to the song data. If protect is turned on, the PROTECT button will be highlighted, and it will not be possible to perform additional recording or editing, or to erase the song.



- We recommend that you turn protect on for important songs.
- Even if protect is on, you can still copy the song (→ p. 140) and adjust the mixer settings.

4 To change the counter display format, move the cursor to one of the buttons in the COUNTER DISPLAY area and press the [ENTER] key.

In the COUNTER DISPLAY area, use the following buttons to select the display format for the counter that is shown in the center of the top line in the display.

- ABS (absolute time)** Display the current location in hours/minutes/seconds/milliseconds, with the absolute time zero location as 0.
- REL (relative time)** Display the current location in hours/minutes/seconds/milliseconds, with the relative time zero location as 0.
- SEC** Display the current location in hours/minutes/seconds/milliseconds, with the Start point as 0.
- T.C** Display the current location in time code (hours/minutes/seconds/frames), with the Start point as 0.
- REMAIN** When this button is on, the remaining recordable time with the selected number of recording tracks will be displayed instead of the current location.



- The counter in the upper right of the display always shows the current location in measure/beat units, relative to the Start point.
- The measure/beat display will depend on the settings in the TEMPO page of the SONG screen. For details, refer to "Creating a tempo map" (→ p. 142).

5 To change the time code frame rate, move the cursor to one of the buttons in the TIME CODE BASE area, and press the [ENTER] key. In the TIME CODE BASE area you can choose one of the following frame rates to specify the minimum unit of time code.

- 24** 24 frames/second
- 25** 25 frames/second
- 30** 30 frames/second (30 non-drop frame)
- 30D** 29.97 frames/second (30 drop-frame)



This setting affects both the counter time code display and the MTC that the AW16G transmits and receives. If the AW16G is sending or receiving MTC to or from an external device, you must set both devices to the same frame rate.



With the exception of COUNTER DISPLAY, the settings in the SETUP page of the SONG screen cannot be changed while the AW16G is running.

Copying or deleting a song

Here's how to copy or delete a song in the hard disk.

Note

- You cannot copy or delete a song while the AW16G is running.
- A deleted song will be lost forever. Use great caution when deleting a song.
- You cannot delete a song for which protect is on, or delete the current song (the highlighted song). If you want to delete such a song, you must first turn off the protect setting or switch the current song.

1 In the Work Navigate section, press the [SONG] key

The SONG screen will appear.

2 Repeatedly press the [SONG] key or hold down the [SONG] key and use the CURSOR [▲]/[▼] keys to access the LIST page.

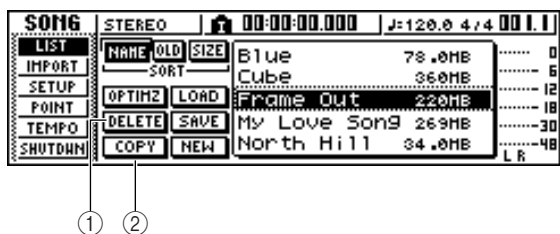

This page contains the following items.

- 1 DELETE button**
Displays a popup window that allows you to delete a song.
 - 2 COPY button**
Displays a popup window that allows you to copy a song.
- 3** Turn the [DATA/JOG] dial to select the song that you want to copy or delete.
The line that is enclosed by a dotted frame indicates the selected song.

To copy a song

4 Move the cursor to the COPY button and press the [ENTER] key.

A popup window will ask you to confirm the copy operation.



Tip!

If you have selected the current song as the song to be copied, a popup window will ask you whether you want to save the current song. Move the cursor to either the YES button (if you want to save) or the NO button (if you don't want to save), and then press the [ENTER] key.

5 To execute the copy, move the cursor to the OK button and press the [ENTER] key.

The song you selected in step 3 will be copied, and you will return to step 2. If you move the cursor to the CANCEL button and press the [ENTER] key, the copy operation will be cancelled.

Note

When you copy a song, the hard disk will contain two songs with the identical song name and size. To avoid confusion, we recommend that you rename the song after copying it.

To delete a song

6 Following step 3, move the cursor to the DELETE button and press the [ENTER] key.

A popup window will ask you to confirm the delete operation.



7 To delete the song, move the cursor to the OK button and press the [ENTER] key.

The song you selected in step 3 will be deleted, and you will return to step 2. If you move the cursor to the CANCEL button and press the [ENTER] key, the delete operation will be cancelled.

Note

If you have selected the current song as the song to be deleted, a popup window will warn you that it is not possible to delete the current song.

Optimizing a song

“Optimize” is an operation that deletes the undo/redo audio data maintained within the song. When you have finished recording and editing a song, you can execute the Optimize operation on that song to increase the amount of free space on the hard disk.



The deleted undo/redo audio data will be lost forever. Use this operation with caution.

- 1 In the Work Navigate section, repeatedly press the [SONG] key or hold down the [SONG] key and use the CURSOR [▲]/[▼] keys to access the LIST page of the SONG screen.

SONG	STEREO	00:00:00.000	J:120.0 474 001.1			
LIST	NAME	OLD	SIZE	My Love Song	263MB 0
IMPORT	SORT		North Hill	34.0MB 6	
SETUP	OPTIMZ	LOAD	Orange Cake	207MB 12	
POINT	DELETE		Ride with me	130MB 18	
TEMPO	SAVE		Song for me	90.5MB 30	
SHUTDOWN	COPY		NEW	 48	

- 2 Turn the [DATA/JOG] dial to select the song that you want to optimize.

The line enclosed by the dotted frame indicates the selected song.

- 3 Move the cursor to the OPTIMZ button, and press the [ENTER] key.

A popup window will ask you to confirm the optimize operation.



You may select the current song to be optimized. In this case, a popup window will ask you whether you want to save the current song. Move the cursor to the YES button (if you want to save) or the NO button (if you don't want to save), and press the [ENTER] key.

- 4 To execute the optimize operation, move the cursor to the OK button and press the [ENTER] key.

The undo/redo audio data of the song you selected in step 2 will be deleted, and you will return to step 1. If you decide not to execute the optimize operation, move the cursor to the CANCEL button and press the [ENTER] key.

Creating a tempo map

The “tempo map” contains data to change the tempo or time signature at the beginning of the song or at any measure or beat within the song. The measure/beat display counter, the Quick Loop Sampler, the internal metronome, and the MIDI clock data generated within the AW16G are all based on this tempo map.

The AW16G’s tempo map can also record data to switch scenes (→ p. 73) or Pad sample banks (→ p. 107). You can use this to switch scenes as the song progresses, or to switch the sounds that are played by the Quick Loop Sampler.



- The Start point of the song corresponds to the starting location of the tempo map.
- The data (“tempo map events”) recorded in the tempo map will continue to apply until the location at which the next event of the same type has been input.



If you modify the tempo map after recording on an audio track, the measure/beat counter display values will be affected. For this reason if you want to use MIDI clock to synchronize with an external MIDI device, or if you want to control the song in measure units, you should create the tempo map before you record. If you modify the tempo map after a track has already been recorded, a popup window will ask you for confirmation.

Editing a tempo map event

When you create a new song, the following tempo map event will be input at the beginning of the tempo map (the first beat of the first measure).

- Time signature: 4/4
- Tempo: 120.0
- Pad sample bank: Pad 1=A, Pad 2=A, Pad 3=A, Pad 4=A
- Scene number: not assigned

Here’s how to edit the values of this tempo map event.

- 1 In the Work Navigate section, press the [SONG] key. The SONG screen will appear.

- 2 Repeatedly press the [SONG] key or hold down the [SONG] key and use the CURSOR [▲]/[▼] keys to access the TEMPO page.

In this page you can input or edit tempo map events for the current song.

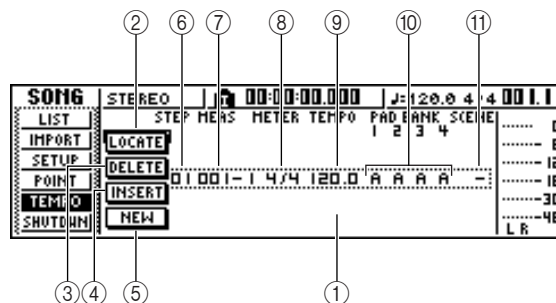

This page contains the following items.

- 1 **List**
This area lists the tempo map events that have been input for the current song. The line enclosed by a dotted frame is the currently selected tempo map event.
- 2 **LOCATE button**
By moving the cursor to this button and pressing the [ENTER] key, you can move the song to the location of the tempo map event currently selected in the list.
- 3 **DELETE button**
To delete the tempo map event currently selected in the list, move the cursor to this button and press the [ENTER] key.
- 4 **INSERT button**
To insert a blank event at the step preceding the tempo map event currently selected in the list, move the cursor to this button and press the [ENTER] key.
- 5 **NEW button**
To create an event at the beginning of the measure following the last step, move the cursor to this button and press the [ENTER] key.
- 6 **STEP**
Indicates the step number of the tempo map event.
- 7 **MEAS**
Indicates the location (measure/beat) at which the tempo map event is input.
- 8 **METER**
- 9 **TEMPO**
- 10 **PAD BANK 1–4**
- 11 **SCENE**
These fields show the time signature, tempo, pad sample bank, and scene number of each tempo map event.

3 Move the cursor to the item that you want to edit, and turn the [DATA/JOG] dial to edit the value.

If the METER, TEMPO, PAD BANK 1–4, or SCENE value is “–”, move the cursor to the item and press the [ENTER] key before you edit the value.

Note

- The METER, TEMPO, and PAD BANK 1–4 at the beginning of the song cannot be set to “–”.
- You cannot change the METER value to other than “–” for a step that is not located at beat 1.

The range for each item is as follows.

Event	Range	Content
METER	1/4 to 8/4, –	Specifies the time signature of the song.
TEMPO	30.0 to 250.0, –	Specifies the tempo of the song. You can set the tempo in units of 0.1 over a range of 30.0–250.0 BPM.
PAD BANK 1–4	A to D, –	Selects the sample bank that will be used for each pad 1–4.
SCENE	00 to 96, –	Switches the scene number used by the song.

Tip!

- You cannot delete the tempo map event located at the beginning of the song, or change its location. If you want to change the tempo or time signature during the song, you can insert a new event.
- If you set METER, TEMPO, PAD BANK 1–4, or SCENE to a value of “–”, that event will be disabled. For example if you want to specify only the time signature and tempo, you should set the pad bank and scene to “–”.

■ Adding a tempo map event

1 Access the TEMPO page, move the cursor to the NEW button, and press the [ENTER] key. A blank tempo map event will be created after the last step that is currently input.

Tip!

If you use the INSERT button instead of the NEW button, a blank tempo map event will be inserted before the currently selected step. However, you cannot insert an event before the tempo map event at the beginning of the song (i.e., the tempo map event that is input when you create the song).

2 Make sure that the cursor is outside the list, and turn the [DATA/JOG] dial to select a tempo map event that you created.

When the cursor is located outside the list, you can turn the [DATA/JOG] dial to scroll the contents of the list.

3 Move the cursor to the MEAS field of the event that is selected in the list, and turn the [DATA/JOG] dial to specify the location of the event.

You can adjust the location of a tempo map event in units of measures or beats. However, you cannot move an event past the preceding or following event.

4 Move the cursor to the item that you want to edit, and turn the [DATA/JOG] dial to adjust the value.

If necessary, you can play back the song to check that the tempo map event works as you expect.

5 In the same way, use the NEW or INSERT button to add new events, and set their parameters.

■ Deleting a tempo map event

Here’s how to delete an unwanted event from the tempo map. (However, you cannot delete the event that is located at the beginning of the song.)

1 Access the TEMPO page, and scroll the list to select the tempo map event that you want to delete.

2 Move the cursor to the DELETE button and press the [ENTER] key.

The selected event will be deleted.

Importing data from an existing song

Here's how selected items of data such as scenes, libraries, or individual tracks of audio data from a song saved on the hard disk can be imported into the current song.



When you execute this import operation, the previous data (for that item) in the current song will be lost. Use this procedure with caution.

■ Selecting the song from which you will import data

- 1 In the Work Navigate section, press the [SONG] key.
The SONG screen will appear.
- 2 Repeatedly press the [SONG] key or hold down the [SONG] key and use the CURSOR [▲]/[▼] keys to access the IMPORT page.

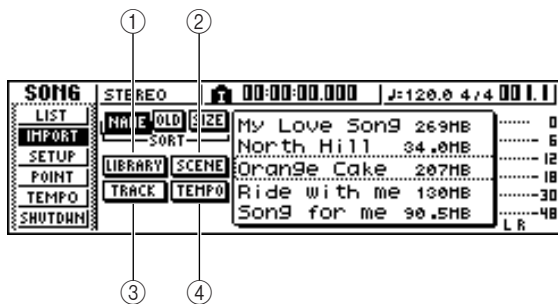

This page contains the following items.

- ① **LIBRARY button**
Imports all libraries into the current song.
 - ② **SCENE button**
Imports all scenes into the current song.
 - ③ **TRACK button**
Imports the audio data of a single track into the current song.
 - ④ **TEMPO MAP button**
Imports the tempo map into the current song.
- 3 Turn the [DATA/JOG] dial to select the song from which you want to import data.
The line enclosed by the dotted frame is the song you have selected as the import-source.

■ Importing library/scene/tempo map data

- 1 Move the cursor to either the LIBRARY, SCENE, or TEMPO MAP button, and press the [ENTER] key.
A popup window will ask you to confirm the import operation.



- 2 To execute the import, move the cursor to the OK button and press the [ENTER] key.
Importing will begin. When the data has been imported, you will return to the screen of step 2.

■ Importing a specific track

- 1 Move the cursor to the TRACK button and press the [ENTER] key.
A popup window will ask you to select the track to be imported.

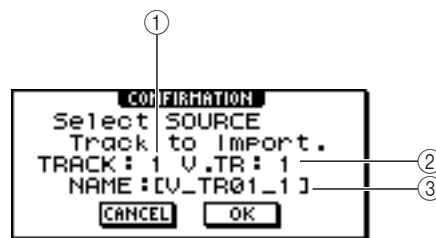

- ① **TRACK**
Specify the import-source track number.
 - ② **V.TR**
Specify the import-source virtual track number.
 - ③ **NAME**
Displays the name of the currently selected virtual track.
- 2 Move the cursor to the TRACK field and V.TR field, and turn the [DATA/JOG] dial to specify the track number and virtual track number.
The name of the selected import-source track will be displayed in the NAME field.



You can import only one track at a time.

3 Move the cursor to the OK button and press the [ENTER] key.

A popup window will ask you to select the import-destination track.

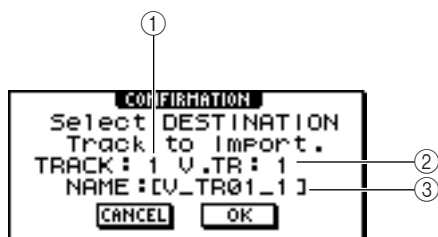

- ① **TRACK**
Specify the import-destination track number.
- ② **V.TR**
Specify the import-destination virtual track number.
- ③ **NAME**
Displays the name of the virtual track that you selected as the import-destination.

4 Move the cursor to the TRACK field and V.TR field, and turn the [DATA/JOG] dial to specify the track number and virtual track number for the import-destination.

5 To execute the import, move the cursor to the OK button and press the [ENTER] key. Importing will begin. When the track has been imported, you will return to the state of step 2.

Backing up songs and sample libraries

Here's how you can back up songs or sample libraries from the internal hard disk to CD-R/RW media.

1 Insert CD-R/RW media into the CD-RW drive.

2 In the Work Navigate section, press the [CD] key.

The CD screen will appear.

3 Repeatedly press the [CD] key or hold down the [CD] key and use the CURSOR [▲]/[▼] keys to access the BACKUP page.

In this page you can back up songs or sample libraries from the internal hard disk to CD-R/RW media.

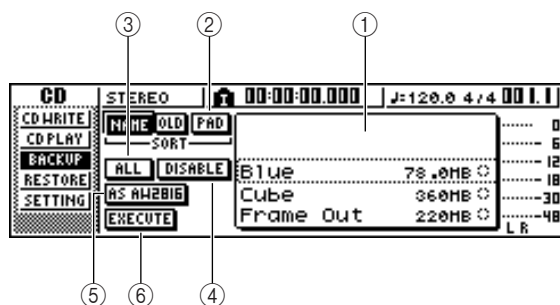

This page contains the following items.

- ① **List**
This area lists the songs or sample libraries that are saved on the hard disk. The symbols at the right of the list indicate whether an item of data has been selected (●) or disabled (○) for backup.
- ② **PAD button**
When this button is off, the list will show the songs that are saved on the hard disk. When this button is on, the list will show the sample libraries that are saved on the hard disk.
- ③ **ALL button**
If you turn this button on and then turn the ENABLE/DISABLE button on, all data displayed in the list will be selected for backup.
- ④ **ENABLE/DISABLE button**
Selects whether an item of data will be selected for backup (ENABLE) or not selected (DISABLE).
- ⑤ **AS AW2816 button**
Backs up the audio tracks within a song in the format of an AW2816 backup file.
If you turn this button on, you will be able to back up only one song at a time. The data selection symbol (●) will apply only to the selected song, and the ALL button and ENABLE/DISABLE button will be unavailable.
- ⑥ **EXECUTE button**
Executes the backup operation for the selected song(s) or sample library(ies).

- 4** Turn the [DATA/JOG] dial to select the song or sample library data that you want to back up. Then move the cursor to the ENABLE/DISABLE button and press the [ENTER] key.

The symbol for the selected data will change to the ● symbol, indicating that this data has been selected for backup. You can repeat this step to select multiple items of data for backup.

If you turn on the ALL button and then move the cursor to the ENABLE/DISABLE button and press the [ENTER] key, you can select all data in the list in one step.



Tip! If you turn on the NAME or OLD button, the data in the list will be sorted alphabetically or by the order in which it was saved.

- 5** To execute the backup, move the cursor to the EXECUTE button and press the [ENTER] key.

A popup window will ask you to confirm the operation.



- If previously-recorded CD-RW media is inserted in the CD-RW drive, a popup window will ask you if it is OK to erase the media first. Move the cursor to the OK button and press the [ENTER] key, and the media will be erased.
- If a CD-ROM or previously-recorded CD-R media is inserted in the CD-RW drive, a popup window with a message of "Change Media, Please" will appear, and the media will be ejected. Remove the media, and replace it with writable media.

- 6** Move the cursor to the OK button and press the [ENTER] key.

Writing to the CD-R/RW media will begin. If you decide to cancel the backup operation, move the cursor to the CANCEL button and press the [ENTER] key.

While the backup operation is being executed, a popup window will indicate the progress. When the backup has been completed, you will return to step 3.

If the backup data does not fit on a single volume of media, a message of "Note Label, Exchange Next" will appear, and the media will be ejected. Insert a new volume of media. Then move the cursor to the OK button and press the [ENTER] key.



- You cannot execute the backup operation without selecting data.
- If you execute the backup operation with the AS AW2816 button turned off, system data (the settings you make in the UTILITY screen) will be backed up on the media together with the selected data.
- If you execute the backup operation with the AS AW2816 button turned on, data other than audio tracks will not be backed up. All virtual tracks for tracks 1-16 will be backed up. For the stereo track, only the current track will be backed up.
- When you restore data that was backed up to more than one volume of media, you must insert the media in the order in which it was backed up. Be sure to make a note of the backup sequence on the label surface of each CD-R/RW media.

Restoring songs or sample libraries

Here's how data that you backed up to CD-R/RW media can be restored to the hard disk of the AW16G.

- 1** Insert the CD-R/RW media containing the backup data into the CD-RW drive.
If the backup data occupies more than one volume of media, insert the first volume.
- 2** In the Work Navigate section, press the [CD] key.
The CD screen will appear.
- 3** Repeatedly press the [CD] key or hold down the [CD] key and use the CURSOR [▲]/[▼] keys to access the RESTORE page.
In this page, data that you backed up to CD-R/RW media can be restored to the internal hard disk.
- 4** Make sure that the cursor is located at the READ CD INFO button, and press the [ENTER] key.
Information will be read from the inserted CD-R/RW media. When the information has been read, a display like the following will appear.

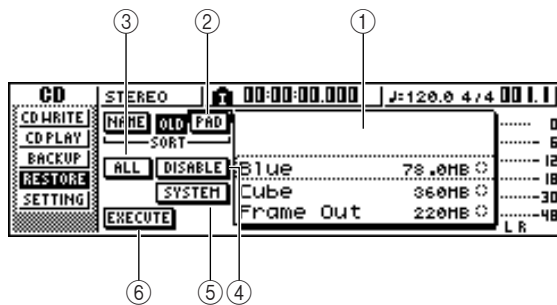

- 1 List**
This area lists the data that has been backed up on the CD-R/RW media. The symbols at the right of the list indicate whether an item of data has been selected (●) or disabled (○) for restore.
- 2 PAD button**
When this button is off, the list will show the songs that were backed up on the CD-R/RW media. When this button is on, the list will show the sample libraries that were backed up on the CD-R/RW media.
- 3 ALL button**
You can use this button to select all the data that appears in the list. If you turn this button on and then turn the ENABLE/DISABLE button on, all data displayed in the list will be selected for restore.
- 4 ENABLE/DISABLE button**
Selects whether an item of data will be selected for restore (ENABLE) or not selected (DISABLE).
- 5 SYSTEM button**
Selects the system data (AW16G settings you make in the UTILITY screen) for restoring.
- 6 EXECUTE button**
Executes the restore operation



You cannot operate the items in the RESTORE page until the inserted CD-R/RW media has been read.

- 5** Turn the [DATA/JOG] dial to select the data that you want to restore. Then move the cursor to the ENABLE/DISABLE button and press the [ENTER] key.
The symbol at the right will change to the ● symbol, indicating that this data has been selected for restoring.
If you turn on the ALL button and then move the cursor to the ENABLE/DISABLE button and press the [ENTER] key, all data shown in the list will be selected in one step.
- 6** If you want to restore the system data, move the cursor to the SYSTEM button and press the [ENTER] key.
The button will be turned on, and the system data will be selected for restoring.
- 7** To execute the restore operation, move the cursor to the EXECUTE button and press the [ENTER] key.

A popup window will ask you to confirm the operation.



- 8** Move the cursor to the OK button if you want to execute the restore operation (or to the CANCEL button if you decide not to restore), and press the [ENTER] key.
The current song will be saved automatically, and the restore operation will begin.
A popup window will indicate the progress of the restore operation. When the operation is finished, you will return to step 3.
If the backup occupied more than one volume of CD-R/RW media, a message of "Exchange Next Media #XXX" (where XXX is a number) will be displayed during the restore process. Exchange the CD-R/RW media for the media of the corresponding number. Then move the cursor to the OK button and press the [ENTER] key.

Exchanging song data with the AW4416/AW2816

You can back up an AW16G song in a format that is compatible with the AW4416/AW2816. Conversely, a song that was backed up by the AW4416/2816 can be restored into the AW16G.

Note

Only the audio data recorded in a song can be exchanged with the AW4416/2816. Mix parameters, libraries, and system data cannot be backed-up/restored in this way.

■ Backing up an AW16G song in a format compatible with the AW4416/AW2816

If you turn on the AS AW2816 button in the BACKUP page of the CD screen, the data will be saved in the AW2816 backup file format.

An AW2816 backup file can be restored into an AW2816 or an AW4416 (version 2.0 or later).

For the procedure, refer to "Backing up songs or sample libraries," earlier in this manual.

Note

- Backup in the AW2816 backup file format is limited to one song at a time.
- When you perform a backup in the AW2816 backup file format, data other than the audio tracks will not be backed up. All virtual tracks of tracks 1–16 will be backed up. For the stereo track, only the current track will be backed up.

■ Restoring AW4416/AW2816 songs

- 1 Insert CD-R/RW media containing the AW4416/AW2816 song backup into the AW16G.
- 2 In the Work Navigate section, press the [CD] key.
The CD screen will appear.
- 3 Repeatedly press the [CD] key or hold down the [CD] key and use the CURSOR [▲]/[▼] keys to access the RESTORE page.
- 4 Make sure that the cursor is located at the READ CD INFO button, and press the [ENTER] key.

Data will be read from the inserted CD-R/RW media. When the data has been read, a screen like the following will appear.

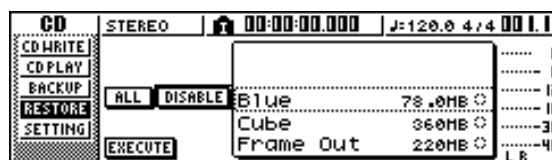

- 5 Turn the [DATA/JOG] dial to select a song that you want to restore.
- 6 Move the cursor to the ENABLE/DISABLE button and press the [ENTER] key.
The symbol at the right of the data will change to ●, and the data will be selected for restoring.

Note

The list will show all the songs that were backed up to CD-R/RW media, but you can execute the restore operation only for 44.1 kHz/16-bit songs.

- 7 Repeat steps 5 and 6 to select all of the AW4416/AW2816 songs that you want to restore.
- 8 To execute the restore operation, move the cursor to the EXECUTE button and press the [ENTER] key.
The restore operation will begin. While the song data is being loaded, a popup window will indicate the progress.

Chapter 14

MIDI and utility functions

This chapter explains basic MIDI-related settings, functions that use MIDI, and various utility functions.

What you can do using MIDI

On the AW16G, you can use MIDI to do the following things.

- **Synchronize operation with an external device**
You can synchronize an AW16G song with the playback of an external device (such as a MIDI sequencer) by exchanging synchronization messages such as MTC (MIDI Time Code) or MIDI Clock with the external device.
- **Remote control of the transport**
You can transmit MMC (MIDI Machine Control) messages from a MIDI sequencer or other external MIDI device to the AW16G to remotely control the AW16G's transport. Conversely, you can also transmit MMC from the AW16G to an external device to control its transport.

Example of using MTC/MMC to synchronize the operation of the AW16G and a MIDI sequencer (computer)

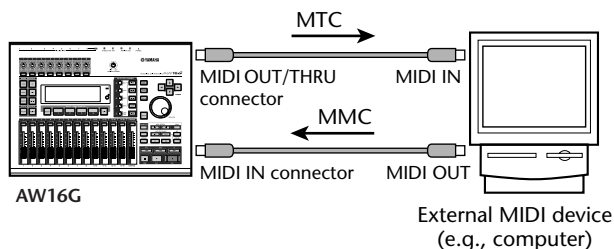

- **Automate scene changes and mix parameter operations**
When you recall a scene on the AW16G or operate its mix parameters, the corresponding messages (program changes or control changes) can be transmitted from the MIDI OUT/THRU connector to an external device.
If you record these messages on a MIDI sequencer that is synchronized to the AW16G song, these scene recall operations or realtime mix parameter operations can be reproduced whenever you want.

Example of recording/playing scene selections and mix parameter operations on a MIDI sequencer (computer)

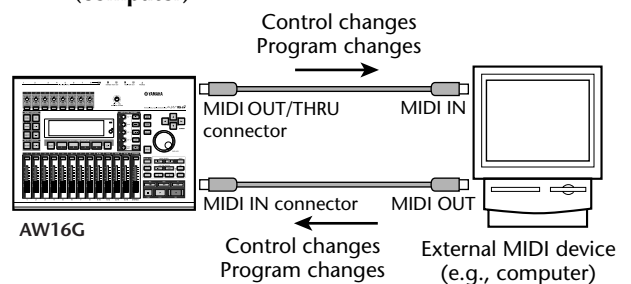

- **Bulk dump**
The AW16G's internal settings such as library data and scene memories can be transmitted as "bulk data" and recorded on a MIDI sequencer or other external MIDI device. The recorded bulk data can then be transmitted to the AW16G to restore its internal settings to their previous state. This can also be used to copy settings between two AW16G units.

Example of recording/playing bulk data on a MIDI sequencer (computer)

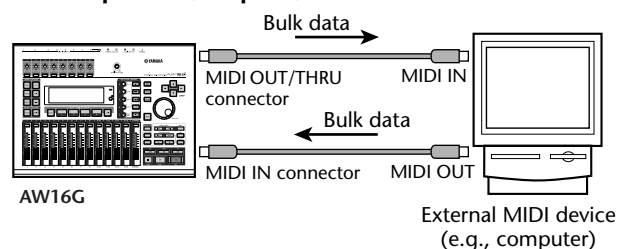

- **MIDI Remote**
"MIDI Remote" is a function that lets you use the AW16G as a physical controller for an external device. You can assign the desired MIDI messages to the faders and [TRACK SEL] keys of the top panel, and use them to remotely control a MIDI device or computer program.

Example of using the AW16G as a physical controller for a MIDI sound module

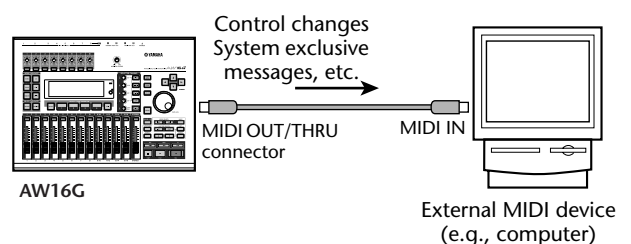

Basic MIDI settings

In the MIDI page of the UTILITY screen, you can make various MIDI-related settings such as selecting the MIDI messages that will be output from the MIDI OUT/THRU connector, and specifying MTC/MMC transmission and reception.

To access this page, repeatedly press the Work Navigation section [UTILITY] key or hold down the [UTILITY] key and use the CURSOR [▲]/[▼] keys.

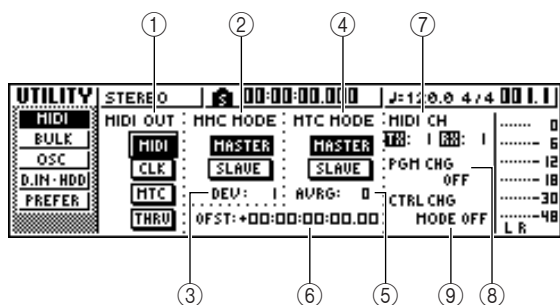

This page contains the following items.

① MIDI OUT

Selects the type of MIDI messages that will be output from the MIDI OUT/THRU connector.

MIDI button..... If this button is on, various MIDI messages generated within the AW16G (except for MIDI Clock and MTC) will be transmitted. If you turn this button on, the THRU button will be defeated.

CLK button..... If this button is on, MIDI Clock (and Start, Stop, Continue, and Song Position Pointer) messages will be transmitted while the recorder is running. If you turn this button on, the MTC button will be defeated.

MTC..... If this button is on, MTC (MIDI Time Code) will be transmit while the recorder is running. If you turn this button on, the CLK button will be defeated.

THRU button..... If this button is on, MIDI messages received at the MIDI IN connector will be re-transmitted without change from the MIDI OUT/THRU connector, and none of the MIDI messages generated within the AW16G itself will be transmitted. If you turn this button on, the MIDI/CLK/MTC buttons will be defeated.

② MMC MODE

Specifies how MMC will be transmitted/received.

MASTER button..... If this button is on, the AW16G will be the MMC master. When you operate the transport, the corresponding MMC command will be transmitted from the MIDI OUT/THRU connector. Use this setting when you want to remotely control an external MIDI device from the AW16G.

SLAVE button..... If this button is on, the AW16G will be the MTC slave, and will follow MMC commands that it receives at the MIDI IN connector. Use this setting when you want to remotely control the transport of the AW16G from an external MIDI device.



Tip! If you want to use the AW16G as the MMC master, make sure that the MIDI button is turned on in the MIDI OUT area.

③ DEV (device number)

Specifies the MMC device number (1–127) that the AW16G will receive.



Note The MMC device number is an identifying number used to distinguish devices that transmit and receive MMC commands. When using MMC, the AW16G and the external MIDI device must be set to the same MMC device number.

The MMC device number is displayed as a decimal number starting from one. Some devices display the MMC device number as a hexadecimal number starting from zero. In this case, the numbers will correspond as follows.

AW16W display → hexadecimal display

1 → 00h

127 → 7Eh

The AW16G always transmits MMC commands using the “All” device number (7Fh in hexadecimal).

④ MTC MODE

Specifies how the AW16G operate when synchronized with an external MIDI device using MTC (MIDI Time Code).

MASTER button..... If this button is on, the AW16G will be the MTC master. When you operate the transport of the AW16G, MTC will be transmitted from the MIDI OUT/THRU connector. Use this setting if you want to the external MIDI device to follow the AW16G, or if you are using the AW16G by itself.

SLAVE button..... If this button is on, the AW16G will be an MTC slave, and will follow MTC data it receives at the MIDI IN connector. Use this setting if you want to synchronize with a second AW16G unit, or if you want to synchronize the AW16G with an external MIDI device that can function only as the MTC master.



Tip! When using the AW16G as the MTC master, make sure that the MIDI button and MTC button in the MIDI OUT area are both turned on.

⑤ AVRG (Average)

Select one of the following to specify how closely the AW16G will follow the incoming MTC data when functioning as an MTC slave.

- 0 The AW16G will synchronize to the incoming MTC data at the highest precision. However if the incoming MTC has significant instability, synchronization may be interrupted or become unreliable.
- 1 This setting allows more tolerance of MTC instability than the "0" setting.
- 2 This setting allows the maximum tolerance. Use this setting if the MTC master is an external MIDI device that has significant instability.



When the AW16G is functioning as an MTC slave and is operating in synchronization to an external MIDI device, and the accuracy of the incoming MTC becomes unstable, the AW16G will make slight adjustments in its playback pitch in an attempt to follow. The AVR parameter specifies the range of MTC variance that will be tolerated.

⑥ OFST (Offset)

When using the AW16G as an MTC slave, this parameter shifts the absolute time within the AW16G forward or backward relative to the incoming MTC. The range is -24:00:00:00.00 to +24:00:00:00.00.

OFST = 00:00:00:00.00

Incoming time code	00:00:10:00.00	00:00:15:00.00	00:00:20:00.00
Time code display (ABS)	00:00:10:00.00	00:00:15:00.00	00:00:20:00.00
Song			

OFST = +00:00:05:00.00

Incoming time code	00:00:10:00.00	00:00:15:00.00	00:00:20:00.00
Time code display (ABS)	00:00:15:00.00	00:00:20:00.00	00:00:25:00.00
Song			

OFST = - 00:00:05:00.00

Incoming time code	00:00:10:00.00	00:00:15:00.00	00:00:20:00.00
Time code display (ABS)	00:00:05:00.00	00:00:10:00.00	00:00:15:00.00
Song			



The OFST setting has no effect on the MTC that is transmitted from the AW16G's MIDI OUT/THRU connector.

⑦ MIDI CH

Selects the MIDI channel that will be used to transmit and receive MIDI messages such as program changes and control changes. This area contains the following two items.

- TX Selects the transmit MIDI channel, in a range of 1–16. While MIDI messages are being transmitted, the characters "TX" will be highlighted.
- RX Selects the receive MIDI channel, in a range of 1–16 or ALL. If you select ALL, MIDI messages of all MIDI channels will be received (Omni mode). While MIDI messages are being received, the characters "RX" will be highlighted.

⑧ PGM CHG MODE

Switches program change transmission and reception on/off.

If program change reception is on, the AW16G will recall the corresponding scene when it receives a program change at the MIDI IN connector. If program change transmission is on, the AW16G will transmit the corresponding program change from the MIDI OUT/THRU connector when a scene is recalled on the AW16G.

You can select the following choices.

- OFF Program changes will not be transmitted or received.
- TX Program changes will only be transmitted.
- RX Program change will only be received.
- TX-RX Program changes will be transmitted and received.



In the SCENE screen PC TABLE page you can specify the scene number that will correspond to each program change number (→ p. 165).



In order to actually transmit program changes, the MIDI button of the MIDI OUT area must be turned on.

⑨ CTRL CHG MODE

Specifies how control changes will be transmitted and received.

If control change transmission and reception are enabled, the corresponding control change will be transmitted when you operate a mix parameter (fader, pan, effect send, etc.) for track channel 1–16 on the AW16G.

When a control change is received, the corresponding mix parameter will change.

You can select one of the following choices.

- OFF Control changes will not be transmitted or received.
- 1 Control changes will be transmitted and received on MIDI channels 1–16. (MIDI channels 1–16 will correspond to AW16G track channels 1–16.)
- 2 Control changes will be transmitted and received only on the MIDI channel that is selected in the MIDI CH field. (This mapping is compatible with the AW4416/AW2816.)
- 3 This is the same as 2 in that control changes of only one MIDI channel are received and transmitted, but the parameter mapping differs from 2. (A single MIDI channel will correspond to AW16G track channels 1–16.)



- For details on the mix parameters that correspond to each control change, refer to the tables that follow.
- When you operate a mix parameter of track channel 9/10–15/16 on the AW16G, two types of control changes will be transmitted.



In order to actually transmit control changes, the MIDI button of the MIDI OUT area must be turned on.

● When CTRL CHG MODE = 1

MIDI CH	CC#	PARAMETER	
1	7	TRACK CHANNEL 1	FADER
	10		PAN
	91		EFF1 SEND
	93		EFF2 SEND
2	7	TRACK CHANNEL 2	FADER
	10		PAN
	91		EFF1 SEND
	93		EFF2 SEND
3	7	TRACK CHANNEL 3	FADER
	10		PAN
	91		EFF1 SEND
	93		EFF2 SEND
4	7	TRACK CHANNEL 4	FADER
	10		PAN
	91		EFF1 SEND
	93		EFF2 SEND
5	7	TRACK CHANNEL 5	FADER
	10		PAN
	91		EFF1 SEND
	93		EFF2 SEND
6	7	TRACK CHANNEL 6	FADER
	10		PAN
	91		EFF1 SEND
	93		EFF2 SEND
7	7	TRACK CHANNEL 7	FADER
	10		PAN
	91		EFF1 SEND
	93		EFF2 SEND
8	7	TRACK CHANNEL 8	FADER
	10		PAN
	91		EFF1 SEND
	93		EFF2 SEND
9	7	TRACK CHANNEL 9	FADER
	10		PAN
	91		EFF1 SEND
	93		EFF2 SEND
10	7	TRACK CHANNEL 10	FADER
	10		PAN
	91		EFF1 SEND
	93		EFF2 SEND
11	7	TRACK CHANNEL 11	FADER
	10		PAN
	91		EFF1 SEND
	93		EFF2 SEND
12	7	TRACK CHANNEL 12	FADER
	10		PAN
	91		EFF1 SEND
	93		EFF2 SEND
13	7	TRACK CHANNEL 13	FADER
	10		PAN
	91		EFF1 SEND
	93		EFF2 SEND
14	7	TRACK CHANNEL 14	FADER
	10		PAN
	91		EFF1 SEND
	93		EFF2 SEND
15	7	TRACK CHANNEL 15	FADER
	10		PAN
	91		EFF1 SEND
	93		EFF2 SEND
16	7	TRACK CHANNEL 16	FADER
	10		PAN
	91		EFF1 SEND
	93		EFF2 SEND

● When CTRL CHG MODE = 2

CC#	PARAMETER	
0	NO ASSIGN	
1	FADER	CHANNEL INPUT 1
2	FADER	CHANNEL INPUT 2
3	FADER	CHANNEL INPUT 3
4	FADER	CHANNEL INPUT 4
5	FADER	CHANNEL INPUT 5
6	FADER	CHANNEL INPUT 6
7	FADER	CHANNEL INPUT 7
8	FADER	CHANNEL INPUT 8
9	FADER	CHANNEL PAD 1
10	NO ASSIGN	
11	FADER	CHANNEL PAD 2
12	NO ASSIGN	

CC#	PARAMETER	
13	FADER	CHANNEL PAD 3
14	NO ASSIGN	
15	FADER	CHANNEL PAD 4
16	NO ASSIGN	
17	NO ASSIGN	
18	NO ASSIGN	
19	NO ASSIGN	
20	NO ASSIGN	
21	FADER	CHANNEL RETURN 1
22	FADER	CHANNEL RETURN 2
23	FADER	MASTER STEREO OUT
24	FADER	MASTER AUX 1
25	FADER	MASTER AUX 2
26	FADER	MASTER EFF 1
27	FADER	MASTER EFF 2
28	NO ASSIGN	
29	NO ASSIGN	
30	NO ASSIGN	
31	NO ASSIGN	
32	NO ASSIGN	
33	FADER	MASTER BUS 1
34	FADER	MASTER BUS 2
35	NO ASSIGN	
36	NO ASSIGN	
37	NO ASSIGN	
38	NO ASSIGN	
39	NO ASSIGN	
40	NO ASSIGN	
41	ON	CHANNEL INPUT 1
42	ON	CHANNEL INPUT 2
43	ON	CHANNEL INPUT 3
44	ON	CHANNEL INPUT 4
45	ON	CHANNEL INPUT 5
46	ON	CHANNEL INPUT 6
47	ON	CHANNEL INPUT 7
48	ON	CHANNEL INPUT 8
49	ON	CHANNEL PAD 1
50	NO ASSIGN	
51	ON	CHANNEL PAD 2
52	NO ASSIGN	
53	ON	CHANNEL PAD 3
54	NO ASSIGN	
55	ON	CHANNEL PAD 4
56	NO ASSIGN	
57	NO ASSIGN	
58	NO ASSIGN	
59	NO ASSIGN	
60	NO ASSIGN	
61	NO ASSIGN	
62	NO ASSIGN	
63	ON	MASTER STEREO OUT
64	PAN	CHANNEL INPUT 1
65	PAN	CHANNEL INPUT 2
66	PAN	CHANNEL INPUT 3
67	PAN	CHANNEL INPUT 4
68	PAN	CHANNEL INPUT 5
69	PAN	CHANNEL INPUT 6
70	PAN	CHANNEL INPUT 7
71	PAN	CHANNEL INPUT 8
72	PAN	CHANNEL PAD 1 L
73	PAN	CHANNEL PAD 1 R
74	PAN	CHANNEL PAD 2 L
75	PAN	CHANNEL PAD 2 R
76	PAN	CHANNEL PAD 3 L
77	PAN	CHANNEL PAD 3 R
78	PAN	CHANNEL PAD 4 L
79	PAN	CHANNEL PAD 4 R
80	NO ASSIGN	
81	NO ASSIGN	
82	NO ASSIGN	
83	NO ASSIGN	
84	NO ASSIGN	
85	NO ASSIGN	
86	NO ASSIGN	
87	NO ASSIGN	
88	NO ASSIGN	
89	NO ASSIGN	
90	NO ASSIGN	
91	NO ASSIGN	
92	PAN	BALANCE STEREO OUT
93	NO ASSIGN	
94	NO ASSIGN	

CC#	PARAMETER		
95		NO ASSIGN	
96		NO ASSIGN	
97		NO ASSIGN	
98		NO ASSIGN	
99		NO ASSIGN	
100		NO ASSIGN	
101		NO ASSIGN	
102	FADER	EFF1 SEND	INPUT 1
103	FADER	EFF1 SEND	INPUT 2
104	FADER	EFF1 SEND	INPUT 3
105	FADER	EFF1 SEND	INPUT 4
106	FADER	EFF1 SEND	INPUT 5
107	FADER	EFF1 SEND	INPUT 6
108	FADER	EFF1 SEND	INPUT 7
109	FADER	EFF1 SEND	INPUT 8
110	FADER	EFF1 SEND	PAD 1
111		NO ASSIGN	
112	FADER	EFF1 SEND	PAD 2
113		NO ASSIGN	
114	FADER	EFF1 SEND	PAD 3
115		NO ASSIGN	
116	FADER	EFF1 SEND	PAD 4
117		NO ASSIGN	
118		NO ASSIGN	
119		NO ASSIGN	
120		NO ASSIGN	
121		NO ASSIGN	
122		NO ASSIGN	
123		NO ASSIGN	
124		NO ASSIGN	
125		NO ASSIGN	
126		NO ASSIGN	
127		NO ASSIGN	

● When CTRL CHG MODE = 3

CC#	PARAMETER		
0		NO ASSIGN	
1	FADER	CHANNEL	TRACK 1
2	FADER	CHANNEL	TRACK 2
3	FADER	CHANNEL	TRACK 3
4	FADER	CHANNEL	TRACK 4
5	FADER	CHANNEL	TRACK 5
6	FADER	CHANNEL	TRACK 6
7	FADER	CHANNEL	TRACK 7
8	FADER	CHANNEL	TRACK 8
9	FADER	CHANNEL	TRACK 9
10	FADER	CHANNEL	TRACK 10
11	FADER	CHANNEL	TRACK 11
12	FADER	CHANNEL	TRACK 12
13	FADER	CHANNEL	TRACK 13
14	FADER	CHANNEL	TRACK 14
15	FADER	CHANNEL	TRACK 15
16	FADER	CHANNEL	TRACK 16
17		NO ASSIGN	
18		NO ASSIGN	
19		NO ASSIGN	
20		NO ASSIGN	
21	FADER	CHANNEL	RETURN 1
22	FADER	CHANNEL	RETURN 2
23	FADER	MASTER	STEREO OUT
24	FADER	MASTER	AUX 1
25	FADER	MASTER	AUX 2
26	FADER	MASTER	EFF 1
27	FADER	MASTER	EFF 2
28		NO ASSIGN	
29		NO ASSIGN	
30		NO ASSIGN	
31		NO ASSIGN	
32		NO ASSIGN	
33	FADER	MASTER	BUS 1
34	FADER	MASTER	BUS 2
35		NO ASSIGN	
36		NO ASSIGN	
37		NO ASSIGN	
38		NO ASSIGN	
39		NO ASSIGN	
40		NO ASSIGN	
41	ON	CHANNEL	TRACK 1
42	ON	CHANNEL	TRACK 2
43	ON	CHANNEL	TRACK 3
44	ON	CHANNEL	TRACK 4
45	ON	CHANNEL	TRACK 5

CC#	PARAMETER		
46	ON	CHANNEL	TRACK 6
47	ON	CHANNEL	TRACK 7
48	ON	CHANNEL	TRACK 8
49	ON	CHANNEL	TRACK 9
50	ON	CHANNEL	TRACK 10
51	ON	CHANNEL	TRACK 11
52	ON	CHANNEL	TRACK 12
53	ON	CHANNEL	TRACK 13
54	ON	CHANNEL	TRACK 14
55	ON	CHANNEL	TRACK 15
56	ON	CHANNEL	TRACK 16
57		NO ASSIGN	
58		NO ASSIGN	
59		NO ASSIGN	
60		NO ASSIGN	
61		NO ASSIGN	
62		NO ASSIGN	
63	ON	MASTER	STEREO OUT
64	PAN	CHANNEL	TRACK 1
65	PAN	CHANNEL	TRACK 2
66	PAN	CHANNEL	TRACK 3
67	PAN	CHANNEL	TRACK 4
68	PAN	CHANNEL	TRACK 5
69	PAN	CHANNEL	TRACK 6
70	PAN	CHANNEL	TRACK 7
71	PAN	CHANNEL	TRACK 8
72	PAN	CHANNEL	TRACK 9
73	PAN	CHANNEL	TRACK 10
74	PAN	CHANNEL	TRACK 11
75	PAN	CHANNEL	TRACK 12
76	PAN	CHANNEL	TRACK 13
77	PAN	CHANNEL	TRACK 14
78	PAN	CHANNEL	TRACK 15
79	PAN	CHANNEL	TRACK 16
80		NO ASSIGN	
81		NO ASSIGN	
82		NO ASSIGN	
83		NO ASSIGN	
84		NO ASSIGN	
85		NO ASSIGN	
86		NO ASSIGN	
87		NO ASSIGN	
88		NO ASSIGN	
89		NO ASSIGN	
90		NO ASSIGN	
91		NO ASSIGN	
92	PAN	BALANCE	STEREO OUT
93		NO ASSIGN	
94		NO ASSIGN	
95		NO ASSIGN	
96		NO ASSIGN	
97		NO ASSIGN	
98		NO ASSIGN	
99		NO ASSIGN	
100		NO ASSIGN	
101		NO ASSIGN	
102	FADER	EFF1 SEND	TRACK 1
103	FADER	EFF1 SEND	TRACK 2
104	FADER	EFF1 SEND	TRACK 3
105	FADER	EFF1 SEND	TRACK 4
106	FADER	EFF1 SEND	TRACK 5
107	FADER	EFF1 SEND	TRACK 6
108	FADER	EFF1 SEND	TRACK 7
109	FADER	EFF1 SEND	TRACK 8
110	FADER	EFF1 SEND	TRACK 9
111	FADER	EFF1 SEND	TRACK 10
112	FADER	EFF1 SEND	TRACK 11
113	FADER	EFF1 SEND	TRACK 12
114	FADER	EFF1 SEND	TRACK 13
115	FADER	EFF1 SEND	TRACK 14
116	FADER	EFF1 SEND	TRACK 15
117	FADER	EFF1 SEND	TRACK 16
118		NO ASSIGN	
119		NO ASSIGN	
120		NO ASSIGN	
121		NO ASSIGN	
122		NO ASSIGN	
123		NO ASSIGN	
124		NO ASSIGN	
125		NO ASSIGN	
126		NO ASSIGN	
127		NO ASSIGN	

Transmitting the AW16G's settings via MIDI (Bulk Dump)

In the BULK page of the UTILITY screen, you can transmit various internal settings of the AW16G (scene memories, libraries, settings of the UTILITY screen, etc.) as bulk data from the MIDI OUT/THRU connector. If you record this bulk data on a MIDI sequencer or similar device, you will then be able to restore these settings whenever desired.

To access this page, repeatedly press the [UTILITY] key or hold down the [UTILITY] key and use the CURSOR [▲]/[▼] keys.

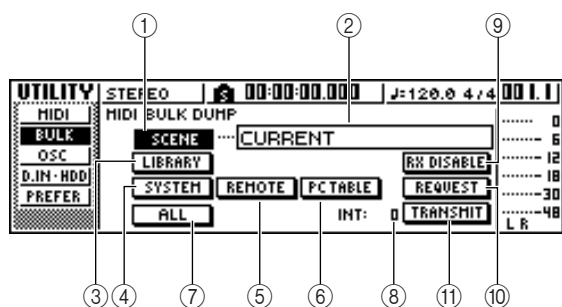

This page contains the following items.

① SCENE button

Selects scene memories for bulk dumping. Use the scene number field located at the right of the button to specify the scene(s) that will actually be transmitted.

② Scene number field

Here you can select the scene number(s) that will be transmitted. You can select from the following choices.

- CURRENT** The current mixing settings (the current scene)
- 01-96** A scene number 01-96
- ALL** Scene numbers 01-96 + current scene

③ LIBRARY button

Selects libraries for bulk dumping.

④ SYSTEM button

Selects the settings in each page of the UTILITY screen for bulk dumping.

⑤ REMOTE button

Selects the settings of the REMOTE screen (→ p. 155) for bulk dumping.

⑥ PC TABLE button

Selects the settings of the SCENE screen PC TABLE page (→ p. 165) for bulk dumping.

⑦ ALL button

Selects (in one step) all items that can be bulk dumped.

⑧ INT

Specifies the interval at which bulk data will be transmitted, in a range of 0-300 ms (10 ms steps).

⑨ RX DISABLE button

Selects whether bulk data sent from an external device will be received (button = on) or ignored (button = off).

⑩ REQUEST button

When you move the cursor to this button and press the [ENTER] key, a bulk dump request message will be transmitted from the MIDI OUT/THRU connector.

A bulk dump request message is a MIDI message that requests an AW16G to transmit the settings you selected in items ①-⑦.

When two AW16G units are connected, you can use this to copy data such as scene memories or libraries from the other AW16G.

● Bulk dump request message transmission

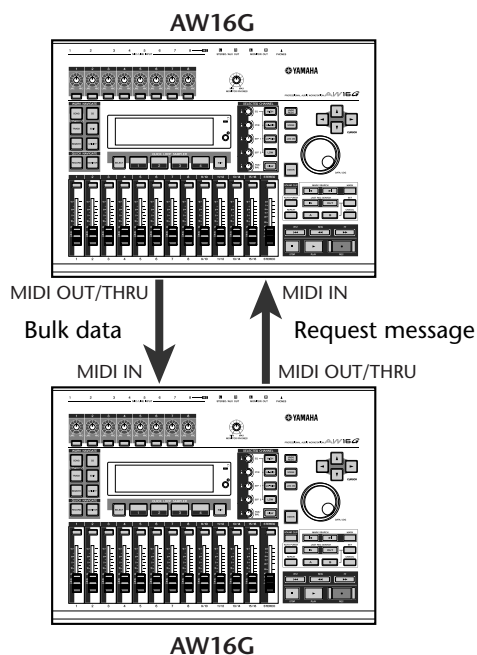

⑪ TRANSMIT button

Move the cursor to this button and press the [ENTER] key to execute the bulk dump.



- The time required for bulk data to be transmitted will depend on the type of data.
- An error may occur on the receiving device while bulk data is being transmitted. In this case, try increasing the INT setting. When transmitting and receiving bulk data between two AW16G units, leave the INT value at zero.



In order to actually perform a bulk dump, you must turn on the MIDI button located in the MIDI OUT area of the MIDI page in the UTILITY screen, so that MIDI messages can be transmitted from the MIDI OUT/THRU connector (→ p. 150).

Using the MIDI Remote function

About the MIDI Remote function

The AW16G provides a MIDI Remote function that lets you use the controls of the top panel to transmit the desired MIDI messages.

By using the MIDI Remote function, you can use the AW16G as a physical controller for a computer program or MIDI tone generator.

MIDI messages can be assigned to the following controls.

● Mixer section

- Faders 1–8, 9/10–15/16
- [TRACK SEL] keys 1–8, 9/10–15/16

● Transport section

- RTZ [◀◀] key
- FF [▶▶] key
- PLAY [▶] key
- REW [◀◀] key
- STOP [■] key
- REC [●] key

Of these, the MIDI messages assigned to the faders and [TRACK SEL] keys can be freely reassigned. You can assign the following types of message.

■ Messages that can be assigned to faders

A MIDI message whose value changes in a range of 0–127 can be assigned to each fader. For example if you assign control change #7 (volume) to a fader, you can move the fader to control the volume of a MIDI tone generator.

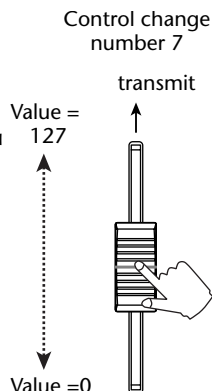

■ Messages that can be assigned to the [TRACK SEL] keys

A MIDI message whose value changes between the two states of 0 or 127 can be assigned to each [TRACK SEL] key. For example if you assign control change #64 (hold) to a [TRACK SEL] key and specify that the control change value alternates between 0 and 127, pressing the [TRACK SEL] key to turn it on (lit) will transmit control change #64 with a value of 127 (Hold on), and turning it off (dark) will transmit control change #64 with a value of 0 (Hold off).

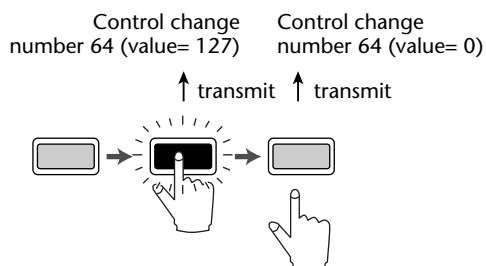

Alternatively, you can specify that a MIDI message with a fixed value is transmitted only when you press the [TRACK SEL] key to turn it on (lit). For example if you assign program change #1, the program change of that number will be transmitted each time you turn on the [TRACK SEL] key.

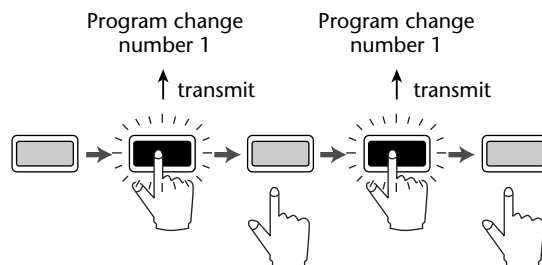

Using the MIDI Remote function presets

The PRESET page of the REMOTE screen provides ten different MIDI Remote presets. These presets have been created with specific devices and computer sequencer programs in mind, and assign the necessary messages to the AW16G's faders and [TRACK SEL] keys. You can use the MIDI Remote function immediately, just by selecting a preset in this page and connecting the appropriate external MIDI device.

Sequencer programs that are supported

● Windows

- Logic5 5.0.1 *1
- Logic Audio Platinum 4.6 *1
- Cubase VST/32 5.1r1
- Cakewalk ProAudio 9.02
- SONAR 1.01

● Macintosh

- Logic5 5.0.1 *1
- Logic Audio Platinum 4.6 *1
- Cubase VST/32 5.1r1 *2
- Cubase VST/32 5.0
- ProTools LE 5.11

*1. Use the setting file from the included CD-ROM to map the AW16G's faders/[TRACK SEL] keys/transport keys to the Logic key commands. Track assignments must be made within Logic as appropriate for your system.

*2. The [RTZ] key will not function.

To access the PRESET page of the REMOTE screen, repeatedly press the Work Navigate section [REMOTE] key or hold down the [REMOTE] key and use the CURSOR [▲/▼] keys.



Tip! The MIDI Remote function will automatically be on while this page is displayed. The track channel faders and [TRACK SEL] keys will not perform their usual functions, but will work as specified by the preset you have selected in the PRESET page.

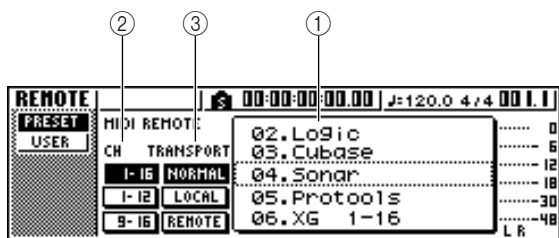

This page contains the following items.

① **List**

Select one of the ten presets shown in this list. The line enclosed in the dotted frame is the currently selected preset. When you turn the [DATA/JOG] dial to select another preset, the MIDI message assignments will be switched immediately.

The AW16G provides the following presets.

● **00 Volume/RecTr**

Use this preset to control the volume of an external tone generator or the recording tracks of an external recorder.

- [TRACK SEL] key operations will transmit MMC commands to select recording tracks.
- Fader operations will transmit Volume control changes (CC#=07).

● **01 Volume**

Use this preset to control the volume of an external tone generator.

- [TRACK SEL] key operations will transmit Volume control change messages (CC#=07).
- When you turn a [TRACK SEL] key off (dark), volume = 0 will be transmitted.
- When you turn a [TRACK SEL] key on (lit green), the volume value corresponding to the fader position will be transmitted.
- When a [TRACK SEL] key is on operating the fader will transmit Volume control change messages (CC#=07).

- **02 Logic**
- **03 Cubase**
- **04 Sonar**
- **05 ProTools**

These presets let you use the AW16G as a physical controller for various software sequencers.

- [TRACK SEL] key operations will control mute on/off operations on the sequencer software.
- Fader operations will control the volume of the sequencer software tracks.

You will need to install the appropriate setting file into your sequencer software, and make the necessary settings. For details, refer to the "Appendix" section "About the CD-ROM included with the AW16G" (→ p. 200).

- **06 XG 1-16**
- **07 XG 17-32**
- **08 XG 33-48**
- **09 XG 49-64**

These presets let you use the AW16G as a volume controller for an XG tone generator. Each preset will control the XG-compatible tone generator's parts 1-16, 17-32, 33-48, and 49-64 respectively.

- [TRACK SEL] key operations will switch the part on/off.
- Fader operations will control the volume of the part.

If you select preset 07-09, the button indications will change as follows.

● **Preset 07**

- 1-16 button → 17-32 button
- 1-12 button → 17-28 button
- 9-16 button → 25-32 button

● **Preset 08**

- 1-16 button → 33-48 button
- 1-12 button → 33-44 button
- 9-16 button → 41-48 button

● **Preset 09**

- 1-16 button → 49-64 button
- 1-12 button → 49-60 button
- 9-16 button → 57-64 button

② **CH**

Choose one of these buttons to select the MIDI channels that will be assigned to the faders and the [TRACK SEL] keys, as shown in the following tables.

● When the 1-16 button is selected

Faders/[TRACK SEL] keys	1	2	3	4	5	6	7	8	9/10	11/12	13/14	15/16
MIDI channel	1	2	3	4	5	6	7	8	9/10	11/12	13/14	15/16

● When the 1-12 button is selected

Faders/[TRACK SEL] keys	1	2	3	4	5	6	7	8	9/10	11/12	13/14	15/16
MIDI channel	1	2	3	4	5	6	7	8	9	10	11	12

● When the 9-16 button is selected

Faders/[TRACK SEL] keys	1	2	3	4	5	6	7	8	9/10	11/12	13/14	15/16
MIDI channel	9	10	11	12	13	14	15	16	—	—	—	—



When the 1-16 button is on, operating a fader 9/10–15/16 or a [TRACK SEL] key 9/10–15/16 will transmit two channels of MIDI messages.

③ TRANSPORT

Select one of the following to specify what will happen when you operate the keys of the transport section while using the MIDI Remote function.

NORMAL button..... The transport keys will perform the same operations as normally; play, stop, or locate etc. the current song. MTC/MMC/MIDI Clock messages will be transmitted and received as specified in the MIDI page of the UTILITY screen.

LOCAL button..... The transport keys will play, stop, or locate the current song. However, MTC/MMC/MIDI Clock messages will not be transmitted or received.

REMOTE button..... The transport keys will not operate the recorder, but will only transmit the MIDI messages that have been preset for each key.



These settings will also apply if you use a foot switch to operate the song transport.

Using the user-defined Remote function

The USER page of the REMOTE screen lets you assign your own MIDI messages to each fader and [TRACK SEL] key.

To access this page, repeatedly press the Work Navigate section [REMOTE] key or hold down the [REMOTE] key and use the CURSOR [▲]/[▼] keys.



The MIDI Remote function will automatically be on while this page is displayed. The track channel faders and [TRACK SEL] keys will not perform their usual functions, but will work as specified by the settings you have made in the USER page.

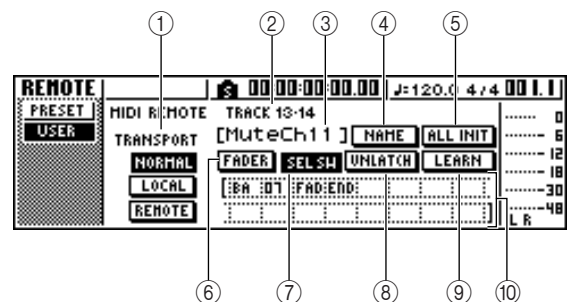

This page contains the following items.

① TRANSPORT

Selects what will happen when you operate the keys of the transport section while using the MIDI Remote function.

② Selected channel

Indicates the name of the channel that is currently selected for operations.



When you operate a fader 1–8 or 9/10–15/16 or a [TRACK SEL] key 1–8 or 9/10–15/16, the displayed contents of the page will change to the corresponding channel.

③ Fader/[TRACK SEL] key function name

Displays the name that is assigned to the currently displayed fader or [TRACK SEL] key.

④ NAME button

Edits the name that is assigned to the fader/[TRACK SEL] key. Move the cursor to the button and press the [ENTER] key, and the TITLE EDIT popup window will appear.

⑤ **ALL INIT button**

Resets all MIDI messages assigned to the faders/[TRACK SEL] keys to the initial settings. To initialize, move the cursor to this button and press the [ENTER] key.

⑥ **FADER button**

If you turn this button on, the MIDI message assigned to the fader of the currently selected channel will be displayed.

This button will automatically be turned on when you operate the fader of a track channel.

⑦ **SEL SW button**

If you turn this button on, the MIDI message assigned to the [TRACK SEL] key of the currently selected channel will be displayed.

This button will automatically be turned on when you operate the [TRACK SEL] key of a track channel.

⑧ **LATCH/UNLATCH button**

Selects how the [TRACK SEL] key of a track channel will operate when pressed.

LATCH The setting will alternate on/off each time you press the [TRACK SEL] key.

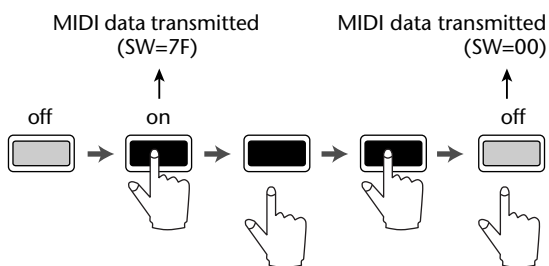

UNLATCH..... The setting will be on while you hold down the [TRACK SEL] key, and will turn off when you release the key.

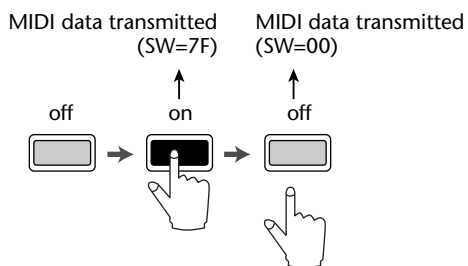

⑨ **LEARN button**

When this button is on, the MIDI message received from the MIDI IN connector will be assigned to the currently selected fader or [TRACK SEL] key. This is a convenient way to assign MIDI messages quickly.



- If two or more MIDI messages are received while the LEARN button is on, the last-received MIDI message will be input in the MIDI message field.
- If a system exclusive message longer than sixteen bytes is received, the first sixteen bytes will be displayed.

⑩ **MIDI message**

This area displays (in hexadecimal form) the MIDI message that is assigned to the currently selected fader or [TRACK SEL] key.

You can move the cursor to each numeric box and turn the [DATA/JOG] dial to edit the value of each byte (two-digit hexadecimal number). You can select the following values.

00–FF (hexadecimal) ..Corresponds to the actual value of the MIDI message that is transmitted.

END.....Indicates the end of the MIDI message. When you operate a fader or [TRACK SEL] key, the MIDI message starting with the first byte and ending with the byte that precedes END will be transmitted.

SW ([TRACK SEL] key only)Indicates the on/off status of the [TRACK SEL] key. The byte you specify as SW will be transmitted as 7F (hexadecimal) when the key is turned on, or 00 (hexadecimal) when the key is turned off.

FADIndicates the current position of the fader. If the message is assigned to a fader, the byte you specify as FAD will be transmitted as a value of 00–7F (hexadecimal) corresponding to the fader position when you operate the fader. If the message is assigned to a [TRACK SEL] key, this byte will be transmitted as a value corresponding to the current position of the fader when the [TRACK SEL] key is turned on, and will be transmitted as a value of 00 (hexadecimal) when the [TRACK SEL] key is turned off.



- The MIDI message assigned to a single fader or key cannot be longer than sixteen bytes.
- If a SW byte is not assigned to a [TRACK SEL] key, the MIDI message you input will be transmitted only when you turn the key on. (In this case you will normally use the UNLATCH setting.)
- When you use the LEARN button to assign a control change to a fader, the END byte will automatically be input at the end of the MIDI message.
- When you use the LEARN button to assign a control change to a fader, the FAD byte will be automatically input as the variable value.



- If you assign a MIDI message manually, be sure to input END at the end of the MIDI message.
- When you assign a MIDI message to a fader, FAD must be input for one of the bytes. If FAD is not input, operating the fader will not do anything.
- If you input the values manually, it is possible that an invalid MIDI message will be input. For this reason, you should use the ⑨ LEARN button to assign MIDI messages whenever possible.

Using the test tone oscillator

The OSC page of the UTILITY screen lets you send the signal of the AW16G's built-in test oscillator (the test tone oscillator) to the desired bus.

To access this page, repeatedly press the Work Navigate section [UTILITY] key or hold down the [UTILITY] key and use the CURSOR [▲]/[▼] keys.

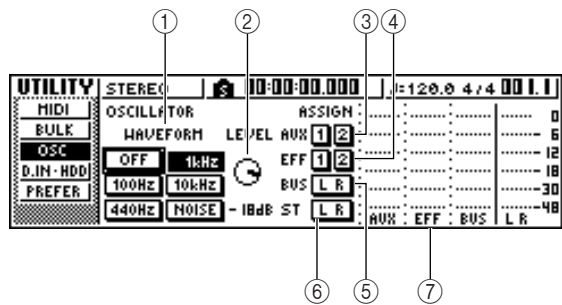

This page contains the following items.

- ① **WAVEFORM**
Selects one of the following signals for output from the oscillator.
OFF button Oscillator is off
100Hz button 100 Hz sine wave
440Hz button 440 Hz sine wave
1kHz button..... 1 kHz sine wave
10 kHz button..... 10 kHz sine wave
NOISE button White noise

When you turn on a button, the oscillator output will immediately be sent to the specified bus. Use the ③–⑥ buttons to specify the bus to which the signal will be sent.



Tip! If the LEVEL knob is raised when you output the oscillator signal, a high volume level may be produced suddenly. Be sure to lower the LEVEL knob before you switch on the oscillator.

- ② **LEVEL knob**
Adjusts the output level of the oscillator.
- ③ **AUX 1/2 buttons**
Send the oscillator output to AUX buses 1/2.
- ④ **EFF 1/2 buttons**
Send the oscillator output to effect buses 1/2.
- ⑤ **BUS L R button**
Sends the oscillator output to the L/R bus.
- ⑥ **STEREO L R button**
Sends the oscillator output to the stereo bus.
- ⑦ **Level meter**
Indicates the output level of AUX 1/2, effect bus 1/2, and the L/R bus.



Note Sine waves and white noise have a higher sound pressure than they perceptually appear. These signals may damage your speakers if played at a high volume, so please use caution.

Digital input settings/Checking and initializing the internal hard disk

In the D.IN HDD page of the UTILITY screen you can make settings for digital input, and check and initialize the internal hard disk.

To access this page, repeatedly press the Work Navigation section [UTILITY] key or hold down the [UTILITY] key and use the CURSOR [▲]/[▼] keys.

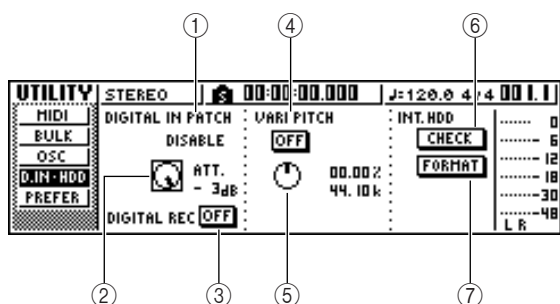

This page contains the following items.

① DIGITAL IN PATCH

Selects one of the following as the destination to which the signal from the DIGITAL IN jack will be sent.

DISABLE The DIGITAL STEREO IN jack will be disabled.

INPUT 1/2-7/8 The signal will be sent to input channels 1/2-7/8. If you select this setting, the MIC/LINE input jacks for the corresponding input channels will be disabled.

STEREO BUS The signal will be sent to the stereo bus.



*If you select **DISABLE**, the AW16G will operate using its own internal clock. If you select any other setting, the AW16G will synchronize to the clock contained in the input signal from the DIGITAL STEREO IN jack. However when playing an audio CD, the AW16G always operates using its own clock.*



- You cannot switch this setting while the recorder is running.
- If you select a setting other than **DISABLE**, a message of “(((WRONG WORD CLOCK!!!)))” will be displayed if appropriate clock data is not being sent to the DIGITAL STEREO IN jack. While this message is displayed, all channels will be muted and the recorder section will not operate. To make the AW16G operate, you must either input the correct clock signal or switch the DIGITAL IN PATCH setting to **DISABLE**.

② ATT knob

Adjusts the level of the signal that is sent from the DIGITAL STEREO IN jack to the stereo bus.



The ATT knob is meaningful only if DIGITAL IN PATCH is set to STEREO BUS.

③ DIGITAL REC ON/OFF button

Enables (ON) or disables (OFF) digital recording from the DIGITAL IN jack, and importing of digital audio data from an audio CD or WAV file inserted in the CD-RW drive.

When you switch this setting ON, the following message will be displayed.

OBSERVE Copyright Notice
Written in Owner's Manual?
[Cancel] [OK]

If you agree to the conditions described in “Copyright Notice” (→ p. 5), select [OK]. When you select [OK], recording and importing of digital audio data will be enabled.



The DIGITAL REC ON/OFF button is always set to OFF when you turn on the power.

④ VARI PITCH ON/OFF button

Selects whether the sampling frequency will be adjustable (Vari-pitch function) when DIGITAL IN PATCH is set to **DISABLE**. If you turn this button on, vari-pitch will be enabled, and you can use the VARI PITCH knob to adjust the sampling frequency.

⑤ VARI PITCH knob

Adjusts the sampling frequency of the current song in a range of -5.97 to +6.00%.



*Vari-pitch is not available if DIGITAL IN PATCH is set to other than **DISABLE**, or if you have selected MTC Slave in the MIDI page of the UTILITY screen.*

⑥ CHECK button

Checks the state of the internal hard disk. When you move the cursor to this button and press the [ENTER] key, a popup window will ask you for confirmation. If you move the cursor to the OK button and press the [ENTER] key, the current song will be saved automatically, and the check will be executed. A popup window will appear while checking is in progress, but you can abort the check by pressing the [ENTER] key.

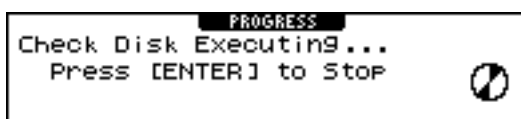

If no problems are found, a popup window indicating “No Error” will appear.

If a problem is found, one of the following messages will appear.

Read Error The display will indicate the number of locations for which data could not be read from the hard disk. It is possible that the hard disk has been physically damaged.

Data Error..... The display will indicate the number of locations for which there is an inconsistency in the data that was read from the hard disk. It is possible that song operations cannot be performed correctly.

Link Error..... The display will indicate the number of locations for which the data recorded on the hard disk is not connected correctly. It is possible that noise may be present in the song playback, or that song operations cannot be performed correctly.



This operation does not fix errors on the hard disk.

We recommend that you make backups of important song data.

If an error message is displayed when you execute this operation, please format the hard disk.

If the AW16G still does not function correctly after you have formatted the hard disk, please contact your dealer.

⑦ **FORMAT button**

Formats the internal hard disk. When you move the cursor to this button and press the [ENTER] key, the hard disk will be formatted. During execution, a popup window will indicate the progress. When formatting has been completed, the popup window will close automatically.



-
- ***Executing the Format operation will erase all data from the internal hard disk, and the data cannot be recovered. Use this operation with caution.***
 - ***You cannot abort the Format operation once it has been started.***
 - ***Never turn off or disconnect the power during formatting, since this may damage the hard disk and cause malfunctions.***

Overall settings for the AW16G

In the PREFER page of the UTILITY screen, you can make settings that affect the overall operation of the AW16G, such as specifying whether or not popup windows will appear, and switching copy protect on/off.

To access this page, repeatedly press the Work Navigate section [UTILITY] key or hold down the [UTILITY] key and use the CURSOR [▲/▼] keys.

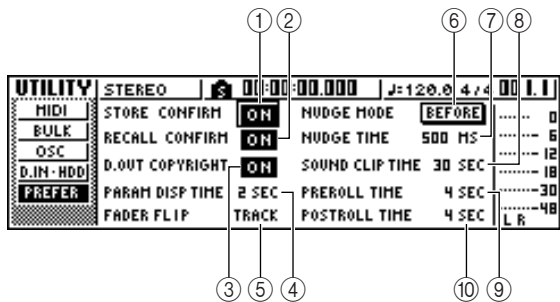

This page contains the following items.

- ① **STORE CONFIRM ON/OFF button**
Specifies whether the TITLE EDIT popup window (allowing you to assign a name) will appear when you store a scene/library.
- ② **RECALL CONFIRM ON/OFF button**
Specifies whether a popup window will ask you to confirm the operation when you recall a scene or library.
- ③ **D.OUT COPYRIGHT ON/OFF button**
Specifies whether SCMS (Serial Copy Management System) copy protect flags will be written into the digital signal that is output from the DIGITAL STEREO OUT jack. Protect is enabled if the button is on, and disabled if the button is off.
If copy protect is enabled, you will be able to copy the signal from the DIGITAL STEREO OUT jack on an MD or DAT recorder, but it will not be possible to make a second-generation digital copy from that data.

● **When copy protect is enabled**

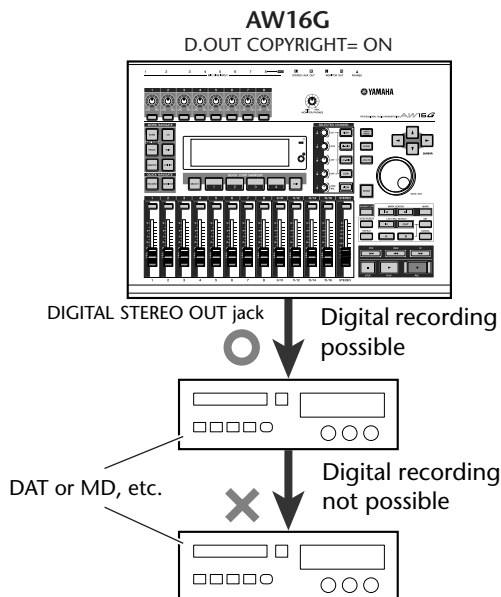

- ④ **PARAM DISP TIME**
Adjusts the duration for which the value will be displayed in the upper right of the screen when you use the knobs of the Selected Channel section to edit a parameter. This setting has a range of 0–9 (seconds).
- ⑤ **FADER FLIP**
Specifies whether faders 1–8 and 9/10–15/16 will adjust the track channel levels (TRACK) or the input channel/pad levels (INPUT). When the power is turned on, this setting will always return to TRACK.



Even if you select INPUT, the function of the [TRACK SEL] keys will not be affected.

- ⑥ **NUDGE MODE**
Selects the playback method that will be used by the Nudge function (a function that lets you use the [JOG ON] key and [JOG/DATA] dial to search for a location).
AFTER.....Play back repeatedly, starting at the current location, for the duration specified by the NUDGE TIME.
BEFORE.....Play back repeatedly, ending at the current location, for the duration specified by the NUDGE TIME.

NUDGE MODE: BEFORE

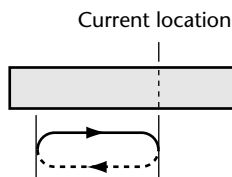

NUDGE MODE: AFTER

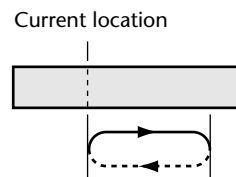

- ⑦ **NUDGE TIME**
Specifies the duration (Nudge Time) that will be played repeatedly by the Nudge function. The nudge time can be set in a range of 25–800 ms in 1 ms (millisecond) steps.
- ⑧ **SOUND CLIP TIME**
Selects the recording time for the Sound Clip function.
This can be set in a range of 30 sec–180 sec, in 30 sec (second) steps.



The SOUND CLIP TIME setting is used when you create a new song. You cannot change the recording time for the sound clip function after the song has been created.

- ⑨ **PREROLL TIME**
Specifies the duration (preroll time) that will be played back before the punch-in point when you use Auto Punch-in. This can be set in a range of 0–5 seconds.
- ⑩ **POSTROLL TIME**
Specifies the duration (postroll time) that will be played back after the punch-out point when you use Auto Punch-in. This can be set in a range of 0–5 seconds.

Chapter 15

Using the AW16G with external devices

This chapter describes various examples of how you can use the AW16G in conjunction with external devices.

Using the AW16G with a “workstation synth”

There are numerous ways in which you can use the AW16G together with a workstation synthesizer (a synthesizer that has a built-in sequencer).

Synchronizing the AW16G with the workstation’s sequencer

Here’s how you can use MTC to synchronize the AW16G song with the sequencer built into your workstation synth. In this example we will also use MMC to remotely control the transport of the AW16G from your workstation synth.

- 1 Refer to the following diagram, and connect the AW16G to your workstation synthesizer.

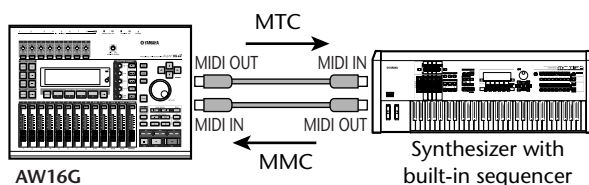

- 2 In the Work Navigate section, use the [UTILITY] key to access the MIDI page of the UTILITY screen. Turn on the SLAVE button in the MMC MODE field, and turn on the MASTER button in the MTC MODE field.

The AW16G will be set to function as MMC slave and MTC master.

- 3 Move the cursor to the DEV field, and set the value to match the device number of your workstation synthesizer.

When using MMC, you must set the AW16G and the external MIDI device to the same MMC device number. For details on the device numbers that your workstation synth can use, refer to its owner’s manual.

- 4 In the MIDI OUT field, turn on the MIDI button and MTC button.

Now when the AW16G runs, MTC will be transmitted from the MIDI OUT/THRU connector.

- Example settings for synchronization using MTC and MMC



- 5 In the Work Navigate section, use the [SONG] key to access the SETUP page of the SONG screen, and select a frame rate in the TIME CODE BASE area.



The frame rate you specify here will affect not only synchronization with the external device, but also the time code that is displayed in the counter, etc.

- 6 Set your workstation synth to function as MMC master and MTC slave, and set its MMC device number and MTC frame rate to the same settings as the AW16G.

For details on how to make these settings, refer to the manual for your workstation synth.

- 7 Play back the sequencer (of your workstation synth).

When you play back the sequencer of your workstation synth, the corresponding MMC commands will be sent to the AW16G, and the AW16G will begin running.

At the same time, the AW16G will transmit MTC to your workstation synth, and the sequencer will run in synchronization with it.



You can synchronize using MIDI Clock and Start/Stop/Continue messages instead of using MTC and MMC. For details on the settings in this case, refer to the section that follows, “Recording/playing AW16G mix operations on your sequencer.”

Recording/playing AW16G mix operations on the workstation's sequencer

Here's how you can synchronize the AW16G and the built-in sequencer of your workstation synth, and use the sequencer to record/play the fader and pan operations you perform on the AW16G.

Since operating the AW16G's mix parameters will cause a large number of control change messages to be transmitted, we will use MIDI Clock (which uses less data) as the synchronization signal rather than MTC.

- 1 Connect the AW16G and your workstation as shown in the following diagram.

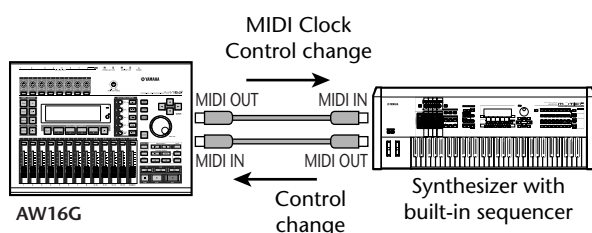

- 2 In the Work Navigate section, use the [UTILITY] key to access the MIDI page of the UTILITY screen. Turn on the MASTER button in the MTC MODE area, and turn on the MIDI button and CLK button in the MIDI OUT area.

With these settings, the AW16G will transmit MIDI Clock, Start/Stop/Continue, and Song Position Pointer messages from its MIDI OUT/THRU connector when it is running.

- Example settings for synchronization using MIDI Clock and Start/Stop/Continue



- 3 Move the cursor to the CTRL CHG MODE area, and turn the [DATA/JOG] dial to select 1 out of the possible range of 1–3.

The CTRL CHG MODE lets you choose one of three combinations (1–3) that specify how control changes will correspond to the mix parameters of the AW16G. (For details on the contents of each choice, refer to page 152.)

If you want to divide your operations into a separate MIDI channel for each of the AW16G's track channels, choose 1. If you want all track channels to be controlled on a single MIDI channel, choose 2 or 3. If you chose 2 or 3, you will also need to set the MIDI CH field to specify the MIDI channel that will be used to transmit and receive the control changes.

- 4 Make settings on your workstation synth so that its built-in sequencer will follow external MIDI Clock messages. Also set the sequencer to record-ready mode.

For details on how to make these settings, refer to the manual for your workstation synth.

Note

If your workstation synth has a function by which MIDI messages received at its MIDI IN connector are retransmitted from its MIDI OUT connector (a function called "MIDI Echo" or "MIDI Thru"), you must turn it off. If this function is turned on while you are recording, the control change messages transmitted when you operate the AW16G will be immediately returned to the AW16G, causing malfunctions.

- 5 Play back the AW16G song from the beginning.

When the AW16G begins playing, it will transmit a Start message and MIDI Clock messages to the sequencer, and the sequencer will begin running in synchronization with the AW16G.

- 6 Operate the AW16G's mix parameters such as fader and pan.

The control changes assigned to each parameter will be recorded on the sequencer.

The type of mix parameters that can be recorded will depend on the setting of the CTRL CHG MODE field (→ p. 151).

- 7 When you are finished recording, stop the AW16G song.

- 8 Switch the workstation's sequencer to playback-ready mode, and play back the AW16G song from the beginning.

The recorded control changes will be transmitted to the AW16G, and the corresponding mix parameters will change.

If necessary, you can use the editing functionality of your sequencer to edit the values and timing of the control changes that were recorded.

Note

If you set CTRL CHG MODE to 1, operating track channels 1–16 will transmit control changes on the corresponding MIDI channel 1–16. For this reason, you should normally record operations only for a single channel at a time, unless your sequencer is able to record multiple MIDI channels simultaneously.

Switching AW16G scenes from the workstation's sequencer

Here's how you can transmit program changes from the built-in sequencer of your workstation to switch scenes on the AW16G.

■ Assign scenes to program changes

1 In the Control section, use the [SCENE] key to access the PC TABLE page of the SCENE screen.

This page lets you assign a scene number to each program change.

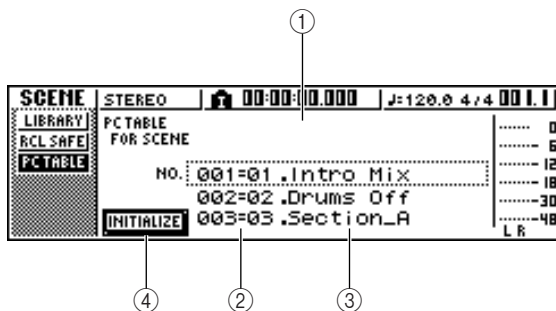

① List

This lists the scenes of the current song. The line enclosed by a dotted frame is the scene currently selected for operations.

② Program change number

This indicates the program change number 001–128. Move the cursor to this number and turn the [DATA/JOG] dial to scroll the list upward or downward.

③ Scene

Move the cursor to this area and turn the [DATA/JOG] dial to select the scene that you want to assign to the corresponding program number.

④ INITIALIZE button

Returns the program change assignments to the initial state.



With the initial settings, program changes 1–96 correspond to scenes 1–96, and program changes 97–128 are set to NO ASSIGN (no assignment).

2 Move the cursor to the program change number, and turn the [DATA/JOG] dial to select the program change number whose assignment you want to change.

3 Move the cursor to the scene in the list, and turn the [DATA/JOG] dial to select the scene that you want to assign to the corresponding program change number.

4 Repeat steps 3–4 to assign the desired scenes to other program change numbers.



If you want to reset the scene assignments to the initial setting, move the cursor to the INITIALIZE button and press the [ENTER] key.

■ Transmit program changes to switch scenes

1 Connect the AW16G and your workstation synth as shown in the diagram below.

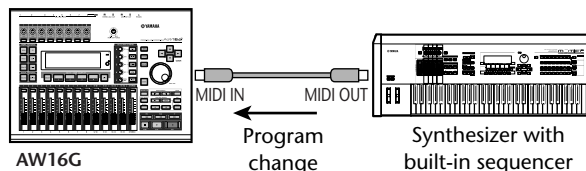

2 In the Work Navigate section, use the [UTILITY] key to access the MIDI page of the UTILITY screen.



3 Set the PGM CHG MODE field to RX.

With this setting, the AW16G will receive program changes.

4 Move the cursor to RX in the MIDI CH area, and select the MIDI channel on which MIDI messages will be received.

5 Transmit a program change message from your workstation synth to the AW16G on the MIDI channel that you selected.

The scene assigned to that program change number will be recalled.



If you insert program changes into the appropriate locations of your sequencer track, scenes will be recalled automatically as the AW16G and your sequencer run in synchronization.

Remotely controlling a tone generator module

Here's how you can use the AW16G's MIDI Remote function to remotely control a tone generator module.

- 1 Connect the AW16G to your tone generator module as shown in the following diagram.

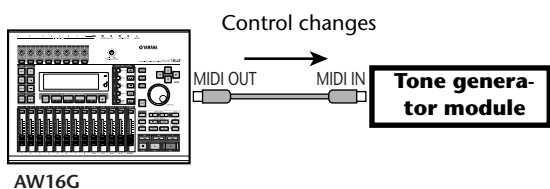

- 2 Use the Work Navigate section [REMOTE] key to access the PRESET page of the REMOTE screen.

The Remote function will be enabled.

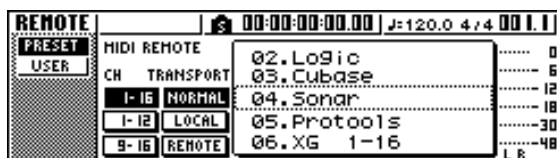

Tip!

- While the REMOTE screen is displayed, the functions of the faders and [TRACK SEL] keys will be disabled; the faders and keys will function as controllers that transmit MIDI messages.
- The MIDI Remote function is enabled whenever the REMOTE screen is displayed. However, MIDI messages will not be output if the MIDI button is turned off in the MIDI page (→ p. 150).

- 3 Turn the [DATA/JOG] dial to select the preset that you want to use.

For example if you select preset 06 (XG 1-16), the AW16G's faders will control the volume of parts 1–16 of your XG tone generator, and [TRACK SEL] keys 1–16 will control the on/off status of parts 1–16.

- 4 If necessary, use the buttons in the CH area to select the MIDI channels to which the faders and [TRACK SEL] keys will correspond.

The buttons in the CH area select the combination of MIDI channels that are assigned to the faders and [TRACK SEL] keys. For the combination of MIDI channels used when each button is on, refer to "MIDI and utility functions" (→ p. 149).

- 5 Operate the faders and [TRACK SEL] keys of the AW16G.

The messages assigned to the faders and [TRACK SEL] keys will be transmitted from the MIDI OUT/THRU connector, and the parameters of your tone generator module will change accordingly.



Tip!

It is also possible to assign your own MIDI messages to the AW16G's faders and [TRACK SEL] keys. For details, refer to "MIDI and utility functions" (→ p. 149).

Using external effects

As an alternative to using the internal effects, you can use an external effect processor connected to the STEREO/AUX OUT jacks. As an example, here's how you can use AUX bus 1 to apply a mono-in stereo-out reverb to the track channels during mixdown.

1 Lower the [STEREO] fader to the ∞ position.

2 In the Selected Channel section, repeatedly press the [PAN/BAL] knob or hold down the [PAN/BAL] knob and use the CURSOR [\blacktriangle]/ [\blacktriangledown] keys to access the AUX OUT page of the PAN screen.

In this page you can select one of the following as the signal that will be output from the STEREO/AUX OUT jacks.

STEREO Stereo bus (default)

AUX 1/2 AUX bus 1/2

3 Move the cursor to the AUX 1/2 button and press the [ENTER] key.

The AUX bus 1 signal will be output from the L channel of the STEREO/AUX OUT jacks, and the AUX bus 2 signal will be output from the R channel of the STEREO/AUX OUT jacks.

4 As shown in the following diagram, connect your external effect processor to the AW16G.

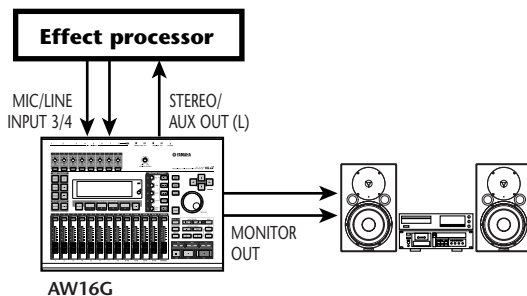

If you make the above connection with the [STEREO] fader raised before performing steps 2 and 3, oscillation may occur. Please use caution.

5 Press the [PAN/BAL] knob twice to access the AUX page of the PAN screen.

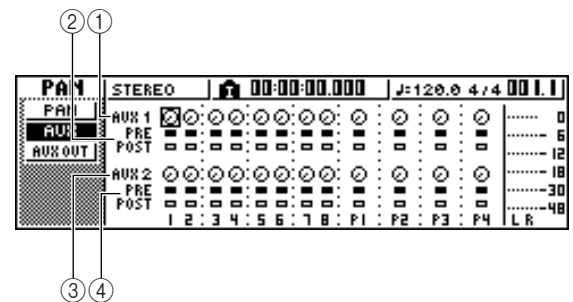

① AUX 1 knobs

Adjust the send level of the signals that are sent from each channel to AUX bus 1.

② PRE/POST (upper line)

Select the location from which the signal is sent from each channel to AUX bus 1. Move the cursor to the desired channel and press the [ENTER] key to switch between the following two settings.

PRE (pre-fader) The signal immediately before the fader will be sent.

POST (post-fader) The signal immediately after the fader will be sent.

③ AUX2 knobs

Adjust the send level of the signals that are sent from each channel to AUX bus 2.

④ PRE/POST (lower line)

Select the location from which the signal is sent from each channel to AUX bus 2. Move the cursor and press the [ENTER] key to switch between PRE and POST.

6 Raise the AUX knob 1 of each channel to an appropriate level, and switch the PRE/POST setting in the upper line as desired.

With the settings so far, the signal from the track channel will be sent from AUX bus 1 via the STEREO/AUX OUT jack to the internal effect.

7 Use the Quick Navigate section [RECORD] key to access the MIXDOWN page of the RECORD screen, and make the settings shown below.

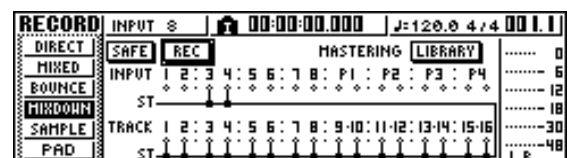

With these settings, the unprocessed sound of track channels 1–16 and the effect sound returned to input channels 3/4 will be sent to the stereo bus and mixed. You can monitor these signals via the MONITOR OUT jacks.

● Signal flow when using an external effect processor

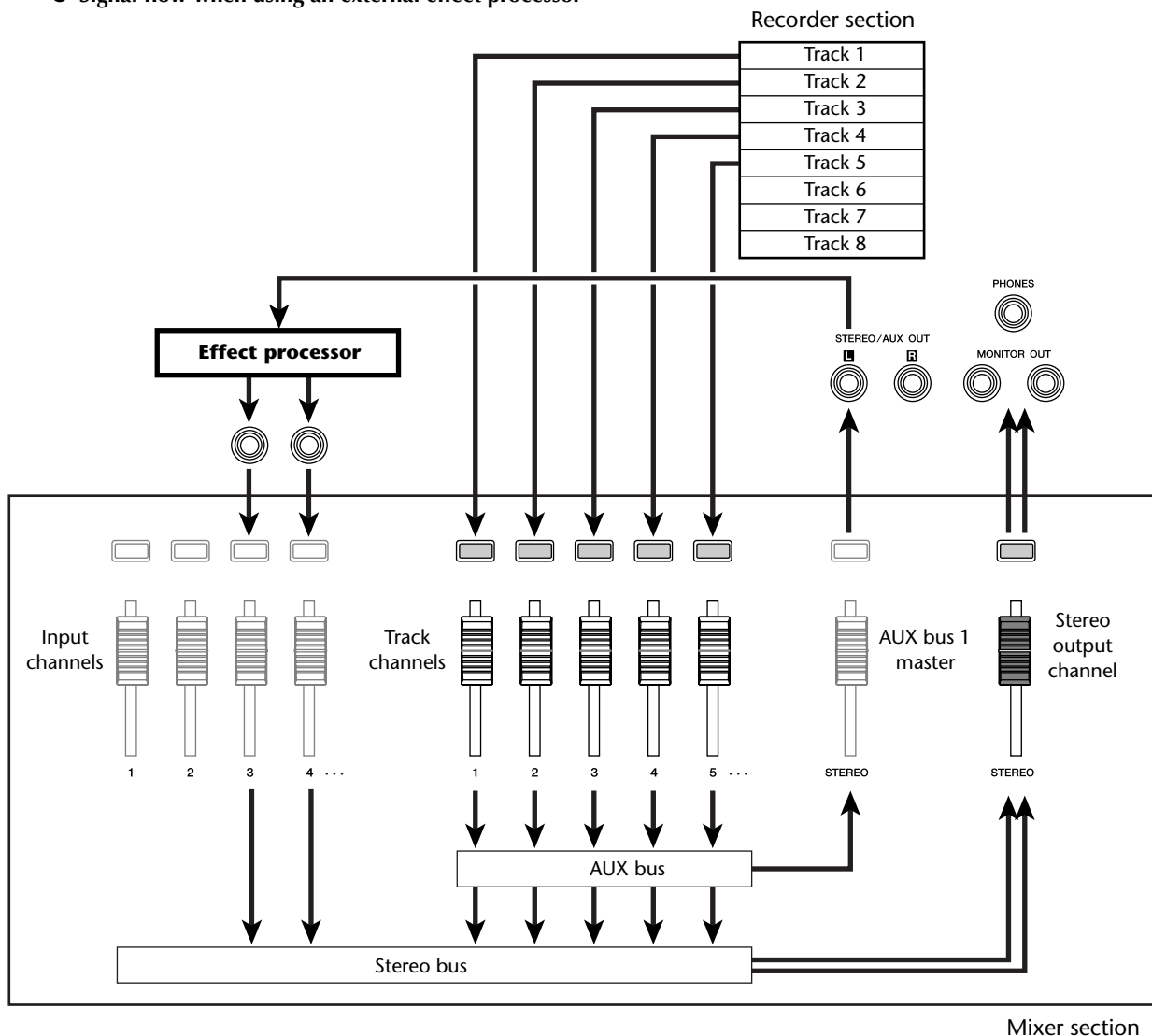

Mixer section

8 In the Selected Channel section, repeatedly press the [PAN/BAL] knob to access the PAN page of the PAN screen, and spread apart the pan settings of input channels 3/4.

The effect sound will be heard in stereo. If desired, you can specify input channels 3/4 as a pair.

Note

If you use these settings, leave the AUX 1 knob and AUX 2 knob of input channels 3/4 set all the way to the left (∞ dB). If you raise these levels, the signal will loop, creating oscillation.

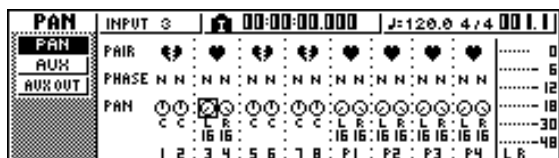

9 Raise the [STEREO] fader to the 0 dB position, and while playing back the song, adjust the input level of your external effect processor and use the [GAIN] knobs to adjust the input level of input channels 3/4.

If desired, return to step 5 and readjust the send level to AUX bus 1 for each track channel. If you want to adjust the AUX bus 1 master level, use the BUS page of the VIEW screen (or the AUX OUT page of the PAN screen).

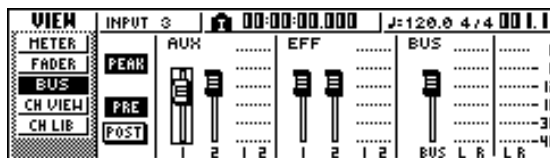

10 In the MIXDOWN page of the RECORD screen, switch the REC button on, and perform the mixdown.

Note

When you are finished with the mixdown, turn the PAN screen AUX OUT page setting back to its original setting of STEREO.

Connecting an MD recorder

By connecting an MD recorder to the AW16G's DIGITAL STEREO IN or DIGITAL STEREO OUT jack, you can mix down to the MD recorder while keeping the signal in the digital domain, or record an audio signal from the MD recorder into the AW16G.

Mixing down to an MD recorder

Here's how you can connect an MD recorder to the AW16G's DIGITAL STEREO OUT jack and mix down. The DIGITAL STEREO OUT jack always outputs the same signal as is recorded on the stereo track. This means that the procedure is essentially the same as for normal mixdown.

- 1 Lower the [STEREO] fader to the $-\infty$ position.
- 2 As shown in the diagram below, use an optical cable to connect the AW16G to your MD recorder.

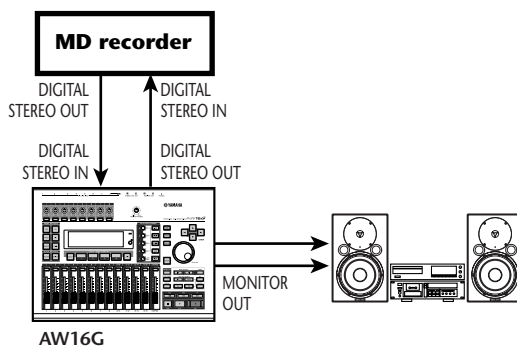

- 3 Use the Quick Navigation section [RECORD] key to access the MIXDOWN page of the RECORD screen, and select the channels that you want to send to the stereo bus.

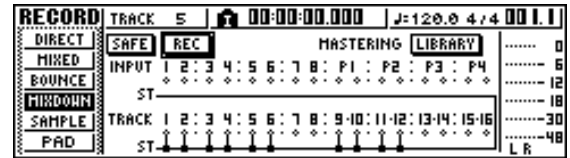

- 4 Raise the [STEREO] fader to the 0 dB position, and while you play back the song, adjust the level, pan, EQ, and dynamics for each track channel.

If desired, you can also use the mastering library.

- 5 When you have finished adjusting the sound and the levels, put your MD recorder in record mode, then play the AW16G from the beginning and perform the mixdown.

You do not need to turn on the REC button in the MIXDOWN page at this time.

- 6 When you have finished the mixdown, stop the AW16G and your MD recorder.

● Signal flow when mixing down to an MD recorder

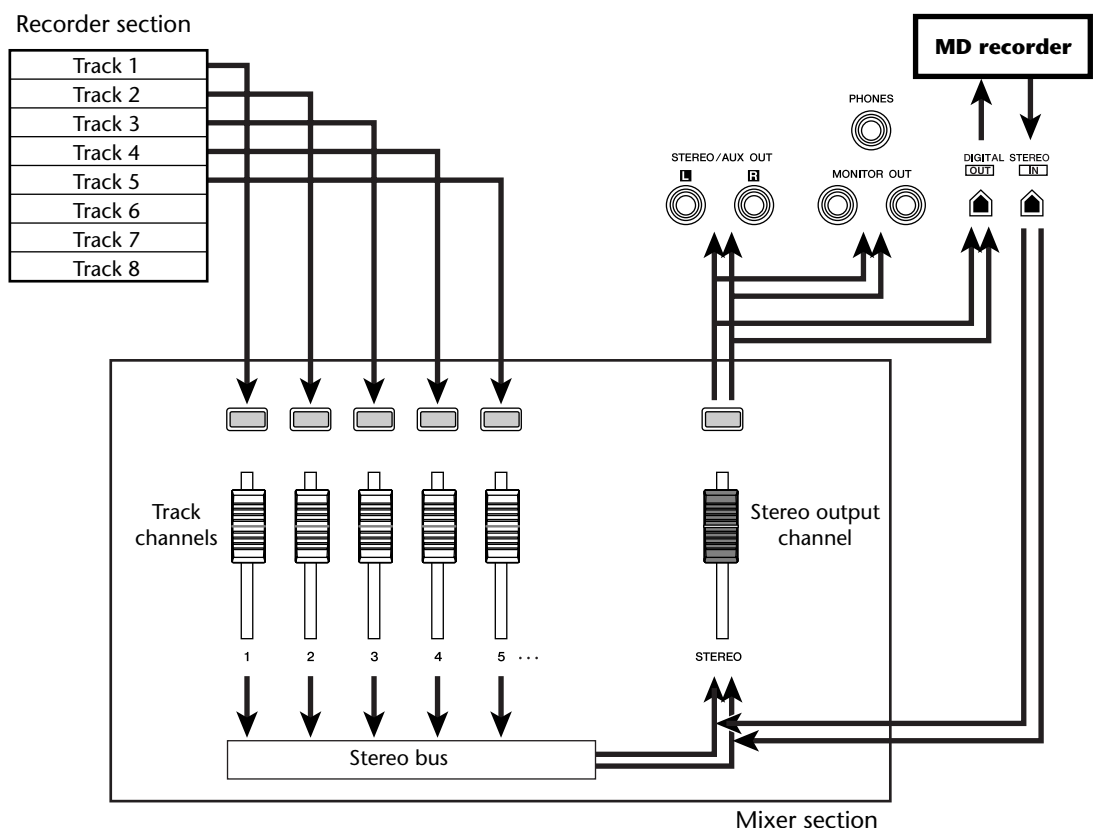

To play back your MD recorder and listen to the recorded result, connect the DIGITAL STEREO OUT jack of your MD recorder to the AW16G's DIGITAL STEREO IN jack, and perform the following steps.

- 7 If you want to hear the result that was recorded on the MD recorder, lower the [STEREO] fader to the $-\infty$ position, and use the [UTILITY] key to access the D.IN - HDD page of the UTILITY screen.

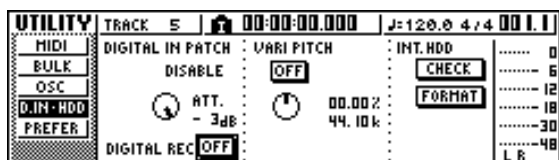

- 8 Move the cursor to the DIGITAL REC ON/OFF button, and press the [ENTER] key.

A message will ask you to confirm your observance of copyright laws. If you accept the conditions described in "Copyright Notice" (\rightarrow p. 5), move the cursor to the OK button and press the [ENTER] key. The DIGITAL REC ON/OFF button will be switched ON, and digital audio data input will be enabled.

- 9 Move the cursor to the DIGITAL PATCH IN field, and turn the [DATA/JOG] dial to select "STEREO BUS" as the destination for the input signal from the DIGITAL STEREO IN jack.

With this setting, the input signal from the DIGITAL STEREO IN jack will be connected directly to the stereo bus.

Note

Please note that the EQ and dynamics settings you made for the stereo output channel during mixdown are still valid at this point. If necessary, turn off EQ and dynamics.

- 10 Raise the [STEREO] fader to the 0 dB position, and play back your MD recorder.

Recording audio data from an MD recorder

Here's how the signal from an MD recorder connected to the DIGITAL STEREO IN jack can be recorded on an AW16G track while still in the digital domain.

- 1 Lower the [STEREO] fader to the $-\infty$ position.

- 2 As shown in the diagram below, connect your MD recorder to the AW16G.

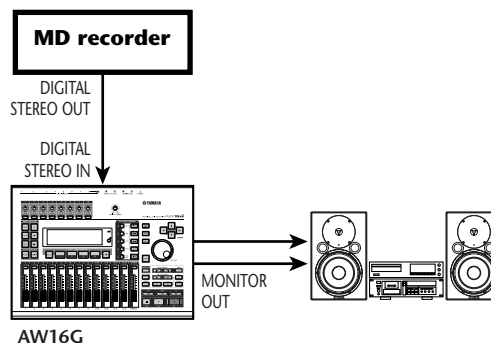

- 3 Use the [UTILITY] key to access the D.IN • HDD page of the UTILITY screen.

- 4 Move the cursor to the DIGITAL REC ON/OFF button, and press the [ENTER] key.

A message will ask you to confirm your observance of copyright laws. If you accept the conditions described in "Copyright Notice" (\rightarrow p. 5), move the cursor to the OK button and press the [ENTER] key. The DIGITAL REC ON/OFF button will be switched ON, and digital audio data input will be enabled.

- 5 Move the cursor to the DIGITAL PATCH IN field, and turn the [DATA/JOG] dial to select "1/2" (input channels 1/2) as the destination for the input signal from the DIGITAL STEREO IN jack.

Note

If necessary, use the INIT page of the MONITOR screen to initialize the input channels.

- 6 Use the Quick Navigation section [RECORD] key to access the DIRECT page of the RECORD screen, and connect input channels 1/2 directly to tracks 1/2.



- 7 Raise the [STEREO] fader, play back your MD recorder, and check the recording level and monitor level.

Note

If you want to lower the recording level, access the FADER page of the VIEW screen and lower the on-screen faders for input channels 1/2. (The [GAIN] knobs have no effect on input signals from the DIGITAL STEREO INPUT jack.)

- 8 When you are finished setting the levels, put the AW16G in record mode, and play back your MD recorder.

Input library list

No.	Name	Effect Type	Description
00	Initial Data		Initialize to a default state in which EQ, DYN, and EFFECT are not applied
EG: Electric guitar			
01	Multi Drive	AmpSimulate	Drive sound usable in a wide range of situations from backing to lead
02	Light Crunch	AmpSimulate	Light crunch sound suitable for chords (that are allowed to ring)
03	Studio Lead	Dist->Delay	Lead with delay sound, with an amp-like character
04	Clean Lead	Rev->Sympho	Clean and transparent sound
05	Hard Blues	AmpSimulate	Hard blues sound with rich distortion
06	Melody Drive	Dist->Delay	Long sustaining sound suitable for melodies or ballades
07	Pop Rythm	Mono Delay	Clean backing sound with doubling
08	Heavy Rock	AmpSimulate	Heavy rock sound with all frequency ranges distorted
09	Stack Lead	AmpSimulate	Sound that simulates an old amp stack
10	Funk Cut	Dyna.Phaser	Phase sound that adds an effect to the picking attack
11	Trad Blues	AmpSimulate	Simulation of a traditional blues guitar sound
12	NeoRockabilly	Dist->Delay	Rockabilly sound using a short delay, warped by adding distortion
13	Air Clean	Delay+Rev	Clean sound with a sense of air
14	City Lead	Mod.Delay	Combination sound with lightly applied modulation and delay
15	Pop Chorus	Chorus	Chorus sound suitable for a wide range of uses, from chording to arpeggios
16	Fuzzy Drive	AmpSimulate	A useful and original fuzz sound
17	Jazzy Night	Reverb Room	Comp sound that lets you express nuances by your picking dynamics
18	Retro Phase	Phaser	Simulation of a classic compact phaser
19	Mistic Chord	Dual Pitch	SFX sound that produces a mystical effect from chords or harmonics
20	Drive Amp	AmpSimulate	Natural-sounding overdrive that simulates overdriving a combo amp
21	Smooth Lead	AmpSimulate	Smooth distortion lead with a smooth playing feel
22	Crunch Box	AmpSimulate	Crunch sound with a nice amount of distortion, usable for anything from backing to lead
23	Double Drive	Dist->Delay	Heavy distortion with doubling
24	Comp Driver	AmpSimulate	Overdrive with compressor to bring out the nuances of your picking
25	Rotary	Rotary	The familiar rotary speaker sound, optimized for guitar
AG: Acoustic guitar			
26	Arpeggio	Rev+Sympho	Graceful arpeggio sound with good definition
27	Chorus	Chorus	Deep chorus sound usable in any situation
28	Lead	Mod.Delay	Light modulation sound, suitable for lead guitar
29	Finger Cut	ReverbRoom	Suitable for finger strumming or walking-bass phrases
30	Stroke	Symphonic	Symphonic sound effective on single-note melodic playing
BA: Bass			
31	Pick Drive	AmpSimulate	A sound ideal for root-note picking
32	Finger Pick	AmpSimulate	Sound suitable for finger-picking, with emphasis on response
33	Rock Boost	AmpSimulate	Heavy and solid distortion sound
34	Best Slap	AmpSimulate	Slap bass sound for everyone (reminiscent of when slap became fashionable)
35	Melody	Rev->Chorus	Sweet-toned sound for lead melodies
VO: Vocal			
36	Pop Vocal	ReverbPlate	Clear and transparent effect for vocal, that cuts the low range
37	Rock Vocal	MonoDelay	Effect for rock vocal that uses doubling to create depth
38	Delay Vocal	MonoDelay	Vocal effect that uses a basic delay
39	Ballad Vocal	Symphonic	Vocal effect with symphonic, effective on ballades etc.
40	ROBOT	RingMod	SFX sound for vocal and speech, also usable as a sound-effect
Speaker simulation			
01	SMALL TYPE	—	Small cabinet simulation
02	REAL FEEL	—	Creates realism (picking produces grit)
03	HIGH RANGE	—	Cabinet with boosted highs
04	STACK TYPE	—	Large cabinet simulation
05	MID RANGE	—	Simulation of a cabinet with distinctive mid-range

Mastering library list

No.	Name	Description
00	Initial Data	Initialize to a state in which EQ and DYN are not applied
01	VITAL MIX	Standard mastering effect that enhances the overall loudness, creating a mix with extended low and high ranges. Use on the two-track mix for any type of song.
02	SOFT COMP	Soft compressor that enhances the overall loudness without greatly changing the original nuances (dynamics). Ideal for songs in which the mid and low ranges are important.
03	HARD ATTACKY	Limiter that emphasizes the attacks and produces an overall "flattened" feel. Ideal for songs that emphasize the rhythm.
04	SOFT ATTACKY	Soft compressor that enhances the overall loudness and emphasizes the attacks without greatly changing the original nuances (dynamics). Ideal for songs in which the low and mid ranges are important, and that emphasize the rhythm.
05	LO-FI	Limiter that produces a "lo-fi" character.
06	DARK/SOFT	Soft limiter that produces the slightly flattened feel characteristic of the 60's and 70's. (Ideal for Beatles-type rock of the 60's and 70's, or more recently for a Vincent Gallo feel.)
07	DARK/HARD	Hard limiter that produces a strongly flattened feel characteristic of the 60's and 70's. (Ideal when you want to make the song sound like 60's or 70's rock such as the Beatles.)
08	BRIGHT	Compressor that produces a boosted high range.
09	LO BOOST	Compressor that produces a boosted low range.
10	HARD LIMIT	Limiter that produces an extremely flattened feel. Ideal for hard-edged songs.
11	LIMITER	Limiter without EQ. Ideal when you need only limiting.
12	NARROW	Limiter that produces a sound like that of a small AM radio.
13	DIST	Limiter that distorts the sound within the effect.

EQ library list

These are the preset equalizer settings provided by the library.

No	Name	Description
001	Bass Drum 1	Emphasizes the low range of the bass drum and the attack created by the beater.
002	Bass Drum 2	Creates a peak around 80Hz, producing a tight, stiff sound.
003	Snare Drum 1	Emphasizes snapping and rimshot sounds.
004	Snare Drum 2	Emphasizes the ranges of that classic rock snare drum sound.
005	Tom-tom 1	Emphasizes the attack of tom-toms, and creates a long, "leathery" decay.
006	Cymbal	Emphasizes the attack of crash cymbals, extending the "sparkling" decay.
007	High Hat	Use on a tight high-hat, emphasizing the mid to high range.
008	Percussion	Emphasizes the attack and clarifies the high-range of instruments, such as shakers, cabasas, and congas.
009	E.Bass 1	Makes a tight electric bass sound by cutting very low frequencies.
010	E.Bass 2	Unlike program 009, this emphasizes the low range of the electric bass.
011	Syn.Bass 1	Use on a synth bass with emphasized low range.
012	Syn.Bass 2	Emphasizes the attack that is peculiar to a synth bass.
013	Piano 1	This is used to make a piano sound brighter.
014	Piano 2	Emphasize the attack and low range of the piano sound by using a compressor.
015	E.G.Clean	Use for line-recording an electric guitar or semi-acoustic guitar to get a slightly hard sound.
016	E.G.Crunch 1	Adjusts the tonal quality of a slightly distorted guitar sound.
017	E.G.Crunch 2	This is a variation on program 016.
018	E.G.Dist 1	Makes a heavily distorted guitar sound clearer.
019	E.G.Dist 2	This is a variation on program 018.
020	A.G.Stroke 1	Emphasizes the bright tones of an acoustic guitar.
021	A.G.Stroke 2	This is a variation on program 020. You can also use it for the electric gut guitar.
022	A.G.Arpeg. 1	Corrects arpeggio technique of an acoustic guitar.
023	A.G.Arpeg. 2	This is a variation on program 022.
024	BrassSection	Use with trumpets, trombones, or sax. With one instrument, adjust the HIGH or H-MID frequency.

No	Name	Description
025	Male Vocal 1	Use as a template for male vocal. Adjust the HIGH or H-MID setting according to the voice quality.
026	Male Vocal 2	This is a variation on program 025.
027	Female Vo. 1	Use as a template for female vocal. Adjust the HIGH or H-MID setting according to the voice quality.
028	Female Vo. 2	This is a variation on program 027.
029	Chorus&Harmo	Use as a template for a chorus. It makes the entire chorus much brighter.
030	Total EQ 1	Use on the STEREO bus during mixdown. For more effect, try it with a compressor.
031	Total EQ 2	This is a variation on program 030.
032	Total EQ 3	This is a variation on program 030. Also use these programs for stereo inputs or external effect returns.
033	Bass Drum 3	This is a variation on program 001. The low and mid range is removed.
034	Snare Drum 3	This is a variation on program 003. It creates rather thick sound.
035	Tom-tom 2	This is a variation on program 005. Emphasizes the mid and high range.
036	Piano 3	This is a variation on program 013.
037	Piano Low	Use for the low range of the piano sound when it is recorded in stereo. Use with program 038.
038	Piano High	Use for the high range of the piano sound when it is recorded in stereo. Use with program 037.
039	Fine-EQ Cass	Use for recording to or from cassette tape to make the sound clearer.
040	Narrator	Use for recording a voice reading a text.
-128	[No Data!]	041-128 are the user area.



Tip! The EQ programs were programmed for recording acoustic musical instruments. If you are using them for a sampler, synthesizer, or rhythm machine, adjust the parameters accordingly.

Dynamics Parameters

Dynamics processors are generally used to correct or control signal levels. However, you can also use them creatively to shape the volume envelope of a sound. The AW16G features comprehensive dynamics processors for all the input channels, tape returns, and the bus and stereo outputs. These processors allow you to compress, expand, compress-expand (compond), gate, or duck the signals passing through the mixer, giving you unparalleled sonic quality and flexibility.

■ Compressor

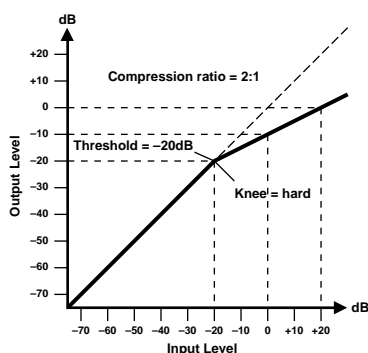

A compressor provides a form of automatic level control. By attenuating high levels, thus effectively reducing the dynamic range, the compressor makes it much easier to control signals and set appropriate fader levels. Reducing the dynamic range also means that recording levels can be set higher, therefore improving the signal-to-noise performance.

Compressor (CMP) parameters:

Parameter	Value
Threshold (dB)	-54 to 0 (55 points)
Ratio	1.0, 1.1, 1.3, 1.5, 1.7, 2.0, 2.5, 3.0, 3.5, 4.0, 5.0, 6.0, 8.0, 10, 20, ∞ (16 points)
Attack (ms)	0 to 120 (121 points)
Outgain (dB)	0 to +18 (36 points)
Knee	hard, 1, 2, 3, 4, 5 (6 points)
Release (ms)	6 ms to 46.1 sec (160 points)

Threshold determines the level of input signal required to trigger the compressor. Signals at a level below the threshold pass through unaffected. Signals at and above the threshold level are compressed by the amount specified using the Ratio parameter. The trigger signal is determined using the KEY IN parameter.

Ratio controls the amount of compression—the change in output signal level relative to change in input signal level. With a 2:1 ratio, for example, a 10 dB change in input level (above the threshold) results in a 5 dB change in output level. For a 5:1 ratio, a 10 dB change in input level (above the threshold) results in a 2 dB change in output level.

Attack controls how soon the signal is compressed once the compressor has been triggered. With a fast attack time, the signal is compressed almost immediately. With a slow attack time, the initial transient of a sound passes through unaffected.

Out Gain sets the compressor's output signal level. Compression tends to reduce the average signal level. Out Gain can be used to counter this level reduction and set an appropriate level for the next stage in the audio path.

Knee sets the transition of the signal at the threshold. With a hard knee, the transition between uncompressed and compressed signal is immediate. With the softest knee, knee5, the transition starts before the signal reaches the threshold and gradually ends above the threshold.

Release determines how soon the compressor returns to its normal gain once the trigger signal level drops below the threshold. If the release time is too short, the gain will recover too quickly causing level pumping—noticeable gain fluctuations. If it is set too long, the compressor may not have time to recover before the next high level signal appears, and it will be compressed incorrectly.

■ Expander

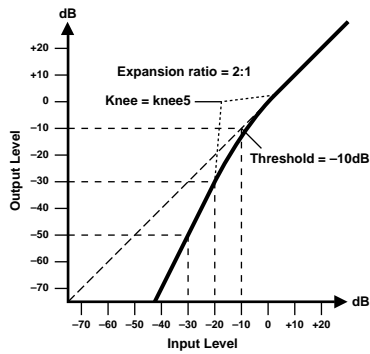

An expander is another form of automatic level control. By attenuating the signal below the threshold, the expander reduces low-level noise and effectively increases the dynamic range of the recorded material.

Expander (EXP) parameters:

Parameter	Value
Threshold (dB)	-54 to 0 (55 points)
Ratio	1.0, 1.1, 1.3, 1.5, 1.7, 2.0, 2.5, 3.0, 3.5, 4.0, 5.0, 6.0, 8.0, 10, 20, ∞ (16 points)
Attack (ms)	0 to 120 (121 points)
Outgain (dB)	0 to +18 (36 points)
Knee	hard,1,2,3,4,5 (6 points)
Release (ms)	6 ms to 46.1 sec (160 points)

Threshold determines the level of input signal required to trigger the expander. Signals above the threshold pass through unaffected. Signals at and below the threshold level are attenuated by the amount specified using the Ratio parameter. The trigger signal is determined using the KEY IN parameter.

Ratio controls the amount of expansion—the change in output signal level relative to change in input signal level. With a 1:2 ratio, for example, a 5 dB change in input level (below the threshold) results in a 10 dB change in output level. For a 1:5 ratio, a 2 dB change in input level (below the threshold) results in a 10 dB change in output level.

Attack controls how soon the signal is expanded once the expander has been triggered. With a fast attack time, the signal is expanded almost immediately. With a slow attack time, the initial transient of a sound passes through unaffected.

Out Gain sets the expander's output signal level.

Knee sets the transition of the signal at the threshold. With a hard knee, the transition between unexpanded and expanded signal is immediate. With the softest knee, knee5, the transition starts before the signal reaches the threshold and gradually ends above the threshold.

Release determines how soon the expander returns to its normal gain once the trigger signal level drops below the threshold.

■ Compressor

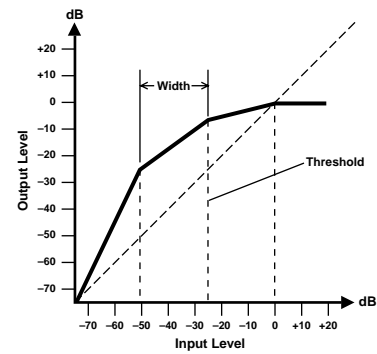

A compressor is a compressor-expander—a combination of signal compression and expansion. The compressor attenuates the input signal above the threshold as well as the level below the width. For very dynamic material, this program allows you to retain the dynamic range without having to be concerned with excessive output signal levels and clipping.

CompressorH (CPH) and CompressorS (CPS) parameters:

Parameter	Value
Threshold (dB)	-54 to 0 (55 points)
Ratio	1.0, 1.1, 1.3, 1.5, 1.7, 2.0, 2.5, 3.0, 3.5, 4.0, 5.0, 6.0, 8.0, 10, 20 (15 points)
Attack (ms)	0 to 120 (121 points)
Outgain (dB)	-18 to 0 (36 points)
Width (dB)	1 to 90 (90 points)
Release (ms)	6 ms to 46.1 sec (160 points)

Threshold determines the level of input signal required to trigger the compressor. Signals above the threshold pass through unaffected. Signals at and below the threshold level are attenuated by the amount specified using the Ratio parameter. The trigger signal is determined using the KEY IN parameter.

Ratio controls the amount of compressing—the change in output signal level relative to change in input signal level. With a 2:1 ratio, for example, a 10 dB change in input level (above the threshold) results in a 5 dB change in output level. The hard compressor (CPH) has a fixed ratio of 5:1 for compression and the soft compressor (CPS) has a fixed ratio of 1.5:1 for compression.

Attack controls how soon the signal is compressed once the compressor has been triggered. With a fast attack time, the signal is compressed almost immediately. With a slow attack time, the initial transient of a sound passes through unaffected.

Out Gain sets the compressor's output signal level.

Width is used to determine the distance, in decibels, between the compressor and the expander. With a width of 90 dB, the compressor is effectively switched off and the compressor is simply a compressor-limiter. With a smaller width (30dB) and a high threshold (0dB), the compressor is an expander-compressor-limiter.

Release determines how soon the compressor returns to its normal gain once the trigger signal level drops below the threshold.

Gate and Ducking

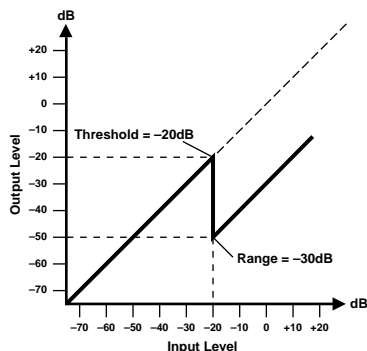
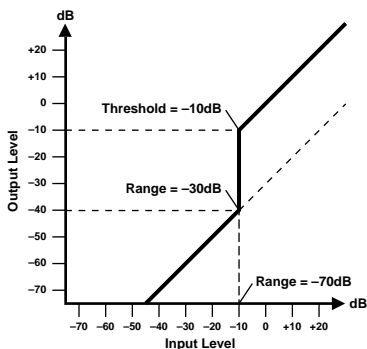

A gate, or noise gate is an audio switch used to mute signals below a set threshold level. It can be used to suppress background noise and hiss from valve (tube) amps, effects pedals, and microphones.

Ducking is used to automatically reduce the levels of one signal when the level of a source signal exceeds a specified threshold. It is used for voice-over applications where, for example, level of background music is automatically reduced, allowing an announcer to be heard clearly.

Gate (GAT) and Ducking (DUK) parameters:

Parameter	Value
Threshold (dB)	-54 to 0 (55 points)
Range (dB)	-70 to 0 (71 points)
Attack (ms)	0 to 120 (121 points)
Hold (ms)	0.02 ms to 2.14 sec (216 points)
Decay (ms)	6 ms to 46.1 sec (160 points)

Threshold sets the level at which the gate closes, cutting off the signal. Signals above the threshold level pass through unaffected. Signals at or below the threshold cause the gate to close.

For ducking, trigger signal levels at and above the threshold level activate ducking, and the signal level is reduced to a level set by the Range parameter.

The trigger signal is determined using the KEY IN parameter.

Range controls the level to which the gate closes. It can be used to reduce the signal level rather than cut it completely. At a setting of -70 dB, the gate closes completely when the input signal falls below the threshold. At a setting of -30 dB, the gate only closes so far allowing an attenuated signal through. At a setting of 0 dB, the gate has no effect. When signals are gated abruptly, the sudden cutoff can sound odd.

For ducking, a setting of -70 dB causes the signal to be virtually cutoff. At a setting of -30 dB the signal is ducked by 30 dB. At a setting of 0 dB, the duck has no effect.

Attack determines how fast the gate opens when the signal exceeds the threshold level. Slow attack times can be used to remove the initial transient edge of percussive sounds. Too slow an attack time makes some signals sound backwards.

For ducking, this controls how soon the signal is ducked once the duck has been triggered. With a fast attack time, the signal is ducked almost immediately. With a slow attack time, ducking fades the signal. Too fast an attack time may sound abrupt.

Hold sets how long the gate stays open or the ducking remains active once the trigger signal has fallen below the threshold level.

Decay controls how fast the gate closes once the hold time has expired. A longer decay time produces a more natural gating effect, allowing the natural decay of an instrument to pass through.

For ducking, this determines how soon the ducker returns to its normal gain after the hold time has expired.

Dynamics library list

These are the preset dynamics settings provided by the AW16G. For details on the function of each parameter, refer to page 174.

001 A.Dr.BD "CMP

002 A.Dr.BD "EXP

003 A.Dr.BD "GAT

004 A.Dr.BD "CPH

Use these presets to apply CMP, EXP, GAT, or CPH respectively to the bass drum of an acoustic drum kit.

005 A.Dr.SN "CMP

006 A.Dr.SN "EXP

007 A.Dr.SN "GAT

008 A.Dr.SN "CPS

These presets modify preset programs 1—4 for use with a snare drum.

009 A.Dr.Tom "EXP

Expander for acoustic toms automatically reduces the volume when the toms are not played, helping to differentiate the bass and snare drums clearly.

010 A.Dr.OverTop "CPS

Soft compander to emphasize the attack and ambience of cymbals using overhead microphones. It automatically reduces the volume when the cymbals are not played, helping differentiate the bass and snare drums clearly.

011 E.B.finger "CMP

Compressor to equalize the attack and volume level of a finger-picked electric bass guitar.

012 E.B.slapp "CMP

Compressor to equalize the attack and volume level of a slap electric bass guitar.

013 Syn.Bass "CMP

Compressor to adjust and/or emphasize the level of a synth bass.

014 Piano1 "CMP

015 Piano2 "CMP

Piano1 brightens the sound to make it stand out slightly. Piano2 uses a deeper threshold setting, producing a more consistent overall level and sense of attack.

016 E.Guitar "CMP

Suitable for electric guitar chording or arpeggios. Try various adjustments depending on your tone or playing style.

017 A.Guitar "CMP

Compressor intended for acoustic guitar playing rhythm chords or arpeggios.

018 Strings1 "CMP

019 Strings2 "CMP

020 Strings3 "CMP

Compressor suitable for strings. Numbers 19 and 20 can also be used on low-range instruments (cello, contra-bass).

021 BrassSection "CMP

Compressor intended for brass sounds with fast and strong attack.

022 Syn.Pad "CMP

This has a restraining effect on sounds that tend to become diffuse. For example, this is ideal for some rich-sounding synth pads that conversely lack definition.

023 SamplingPerc "CPS

024 Sampling BD "CMP

025 Sampling SN "CMP

026 Hip Comp "CPS

It is effective to apply these programs to sampled sounds (such as from a CD-ROM) that are used among acoustic instruments, so that they will not seem to lack power and clarity. Four variations are provided; for Perc, BD, SN, and for looped materials (Hip Comp).

027 Solo Vocal1 "CMP

028 Solo Vocal2 "CMP

These are variations that are suitable for solo vocal sources.

029 Chorus "CMP

This variation of Vocal is suitable for choruses.

030 Compander(H) "CPH

031 Compander(S) "CPS

A template for the compander program.

032 Click Erase "EXP

Expander to remove click track sounds that may bleed out of the monitor headphones the musicians are using.

033 Announcer "CPH

Hard compander reduces the level during the interval between the words, making the voice sound even.

034 Easy Gate "GAT

A template for the gate program.

035 BGM Ducking "DUK

Ducking background music for voiceovers, typically keyed from the announcer's channel.

036 Limiter1 "CMP

037 Limiter2 "CMP

A limiter template. 1 has a slow release, and 2 is a peak stopping type.

038 Total Comp1 "CMP

039 Total Comp2 "CMP

040 Total Comp3 "CMP

Since these presets are effective in restraining the overall level or improving the overall definition, it is useful to apply them to the stereo output during mixdown. You can apply these presets to a stereo source, and adjust them to create interesting effects.

Effects library list

The following table lists the preset effects programs. See “Effects Parameters” (→ p. 180) for detailed parameter information. Effects programs that use the HQ. PITCH effect can be used only with Effect 2.

■ Reverb-type Effects

#	Title	Type	Description
01	Reverb Hall	REVERB HALL	Reverb simulating a large space such as a concert hall.
02	Reverb Room	REVERB ROOM	Reverb simulating the acoustics of a smaller space (room) than REVERB HALL.
03	Reverb Stage	REVERB STAGE	Reverb designed with vocals in mind.
04	Reverb Plate	REVERB PLATE	Simulation of a metal-plate reverb unit, producing a feeling of hard-edged reverberation.
05	Early Ref.	EARLY REF.	An effect which isolates only the early reflection (ER) component from reverberation. A flashier effect than reverb is produced.
06	Gate Reverb	GATE REVERB	A type of ER designed for use as gated reverb.
07	Reverse Gate	REVERSE GATE	A reverse-playback type ER.

■ Delays

#	Title	Type	Description
08	Mono Delay	MONO DELAY	Mono delay with simple operation. Use when you don't need to use complex parameter settings.
09	Stereo Delay	STEREO DELAY	Stereo delay with independent left and right.
10	Mod.delay	MOD.DELAY	Mono delay with modulation.
11	Delay LCR	DELAY LCR	Three-tap delay (L, C, R).
12	Echo	ECHO	Stereo delay with additional parameters for more detailed control. The signal can be fed back from left to right, and right to left.

■ Modulation-type Effects

#	Title	Type	Description
13	Chorus	CHORUS	Three-phase stereo chorus.
14	Flange	FLANGE	The well-known flanging effect.
15	Symphonic	SYMPHONIC	A Yamaha proprietary effect that produces a richer and more complex modulation than chorus.
16	Phaser	PHASER	Stereo phaser with 2–16 stages of phase shift.
17	Auto Pan	AUTO PAN	An effect which cyclically moves the sound between left and right.
18	Tremolo	TREMOLO	Tremolo
19	HQ.Pitch	HQ.PITCH (Effect 2 only)	Only one note is pitch-shifted, but a stable effect is produced.
20	Dual Pitch	DUAL PITCH	Stereo pitch shift with left and right pitches set independently.
21	Rotary	ROTARY	Simulation of a rotary speaker.
22	Ring Mod.	RING MOD.	An effect that modifies the pitch by applying amplitude modulation to the frequency of the input. On the AW16G, even the modulation frequency can be controlled by modulation.
23	Mod.Filter	MOD.FILTER	An effect which uses an LFO to modulate the frequency of the filter.

■ Distortion-type Effects

#	Title	Type	Description
24	Distortion	DISTORTION	Distortion
25	Amp Simulate	AMP SIMULATE	Guitar Amp Simulator

■ Dynamic Effects

#	Title	Type	Description
26	Dyna.Filter	DYNA.FILTER	Dynamically controlled filter. Responds to MIDI Note On velocity when SOURCE set to MIDI.
27	Dyna.Flange	DYNA.FLANGE	Dynamically controlled flanger. Responds to MIDI Note On velocity when SOURCE set to MIDI.
28	Dyna.Phaser	DYNA.PHASER	Dynamically controlled phase shifter. Responds to MIDI Note On velocity when SOURCE set to MIDI.

■ Combined Effects

#	Title	Type	Description
29	Rev+Chorus	REV+CHORUS	Reverb and chorus in parallel
30	Rev->Chorus	REV->CHORUS	Reverb and chorus in series
31	Rev+Flange	REV+FLANGE	Reverb and flanger in parallel
32	Rev->Flange	REV->FLANGE	Reverb and flanger in series
33	Rev+Sympho.	REV+SYMPHO.	Reverb and symphonic in parallel
34	Rev->Sympho.	REV->SYMPHO.	Reverb and symphonic in series
35	Rev->Pan	REV->PAN	Reverb and auto-pan in parallel
36	Delay+ER.	DELAY+ER.	Delay and early reflections in parallel
37	Delay->ER.	DELAY->ER.	Delay and early reflections in series
38	Delay+Rev	DELAY+REV	Delay and reverb in parallel
39	Delay->Rev	DELAY->REV	Delay and reverb in series
40	Dist->Delay	DIST->DELAY	Distortion and delay in series

■ Other Effects

#	Title	Type	Description
41	Multi.Filter	MULTI.FILTER	Three-band parallel filter (24 dB/octave).

Effects Parameters

■ REVERB HALL, REVERB ROOM, REVERB STAGE, REVERB PLATE

Hall, room, stage, and plate simulations, all with gates.

Parameter	Range	Description
REV TIME	0.3–99.0 s	Reverb time
INI.DLY	0.0–500.0 ms	Initial delay before reverb begins
HI.RATIO	0.1–1.0	High-frequency reverb time ratio
LO.RATIO	0.1–2.4	Low-frequency reverb time ratio
DIFF.	0–10	Reverb diffusion (left–right reverb spread)
DENSITY	0–100%	Reverb density
E/R DLY	0.0–100.0 ms	Delay between early reflections and reverb
E/R BAL.	0–100%	Balance of early reflections and reverb (0% = ER, 100% = reverb)
HPF	Thru, 21.2 Hz–8.0 kHz	High-pass filter cutoff frequency
LPF	50 Hz–16.0 kHz, Thru	Low-pass filter cutoff frequency
GATE LVL	OFF, –60 to 0 dB	Level at which gate kicks in
ATTACK	0–120 ms	Gate opening speed
HOLD	0.02 ms–2.13 s	Gate open time
DECAY	6.0 ms–46.0 s	Gate closing speed
MIX BAL.	0–100 [%]	Mix balance of the effects and dry sounds

■ EARLY REF.

Early reflections.

Parameter	Range	Description
TYPE	S-Hall, L-Hall, Random, Revers, Plate, Spring	Type of early reflection simulation
ROOMSIZE	0.1–20.0	Reflection spacing
LIVENESS	0–10	Early reflections decay characteristics (0 = dead, 10 = live)
INI.DLY	0.0–500.0 ms	Initial delay before reverb begins
DIFF.	0–10	Reverb diffusion (left–right reverb spread)
DENSITY	0–100%	Reverb density
ER NUM.	1–19	Number of early reflections
FB.GAIN	–99 to +99%	Feedback gain
HI.RATIO	0.1–1.0	High-frequency feedback ratio
HPF	Thru, 21.2 Hz–8.0 kHz	High-pass filter cutoff frequency
LPF	50 Hz–16.0 kHz, Thru	Low-pass filter cutoff frequency
MIX BAL.	0–100 [%]	Mix balance of the effects and dry sounds

■ GATE REVERB, REVERSE GATE

Early reflections with gate, and early reflections with reverse gate.

Parameter	Range	Description
TYPE	Type-A, Type-B	Type of early reflection simulation
ROOMSIZE	0.1–20.0	Reflection spacing
LIVENESS	0–10	Early reflections decay characteristics (0 = dead, 10 = live)
INI.DLY	0.0–500.0 ms	Initial delay before reverb begins
DIFF.	0–10	Reverb diffusion (left–right reverb spread)
DENSITY	0–100%	Reverb density
ER NUM.	1–19	Number of early reflections
FB.GAIN	–99 to +99%	Feedback gain
HI.RATIO	0.1–1.0	High-frequency feedback ratio
HPF	Thru, 21.2 Hz–8.0 kHz	High-pass filter cutoff frequency
LPF	50 Hz–16.0 kHz, Thru	Low-pass filter cutoff frequency
MIX BAL.	0–100 [%]	Mix balance of the effects and dry sounds

■ MONO DELAY

Basic repeat delay.

Parameter	Range	Description
DELAY	0.0–2730.0 ms	Delay time
FB.GAIN	–99 to +99%	Feedback gain (plus values for normal-phase feedback, minus values for reverse-phase feedback)
HI.RATIO	0.1–1.0	High-frequency feedback ratio
HPF	Thru, 21.2 Hz–8.0 kHz	High-pass filter cutoff frequency
LPF	50 Hz–16.0 kHz, Thru	Low-pass filter cutoff frequency
MIX BAL.	0–100 [%]	Mix balance of the effects and dry sounds

■ STEREO DELAY

Basic stereo delay.

Parameter	Range	Description
DELAY L	0.0–1350.0 ms	Left channel delay time
FB.G L	–99 to +99%	Left channel feedback (plus values for normal-phase feedback, minus values for reverse-phase feedback)
DELAY R	0.0–1350.0 ms	Right channel delay time
FB.G R	–99 to +99%	Right channel feedback (plus values for normal-phase feedback, minus values for reverse-phase feedback)
HI.RATIO	0.1–1.0	High-frequency feedback ratio
HPF	Thru, 21.2 Hz–8.0 kHz	High-pass filter cutoff frequency
LPF	50 Hz–16.0 kHz, Thru	Low-pass filter cutoff frequency
MIX BAL.	0–100 [%]	Mix balance of the effects and dry sounds

■ MOD.DELAY

Basic repeat delay with modulation.

Parameter	Range	Description
DELAY	0.0–2725.0 ms	Delay time
FB.GAIN	–99 to +99%	Feedback gain (plus values for normal-phase feedback, minus values for reverse-phase feedback)
HI.RATIO	0.1–1.0	High-frequency feedback ratio
FREQ.	0.05–40.00 Hz	Modulation speed
DEPTH	0–100%	Modulation depth
WAVE	Sine, Tri	Modulation waveform
HPF	Thru, 21.2 Hz–8.0 kHz	High-pass filter cutoff frequency
LPF	50 Hz–16.0 kHz, Thru	Low-pass filter cutoff frequency
MIX BAL.	0–100 [%]	Mix balance of the effects and dry sounds

■ DELAY LCR

Three-tap delay (left, center, right).

Parameter	Range	Description
DELAY L	0.0–2730.0 ms	Left channel delay time
DELAY C	0.0–2730.0 ms	Center channel delay time
DELAY R	0.0–2730.0 ms	Right channel delay time
LEVEL L	–100 to +100%	Left channel delay level
LEVEL C	–100 to +100%	Center channel delay level
LEVEL R	–100 to +100%	Right channel delay level
FB.DLY	0.0–2730.0 ms	Feedback delay time
FB.GAIN	–99 to +99%	Feedback gain (plus values for normal-phase feedback, minus values for reverse-phase feedback)
HI.RATIO	0.1–1.0	High-frequency feedback ratio
HPF	Thru, 21.2 Hz–8.0 kHz	High-pass filter cutoff frequency
LPF	50 Hz–16.0 kHz, Thru	Low-pass filter cutoff frequency
MIX BAL.	0–100 [%]	Mix balance of the effects and dry sounds

■ ECHO

Stereo delay with crossed feedback loop.

Parameter	Range	Description
DELAY L	0.0–1350.0 ms	Left channel delay time
FB.DLY L	0.0–1350.0 ms	Left channel feedback delay time
FB.G L	–99 to +99%	Left channel feedback gain (plus values for normal-phase feedback, minus values for reverse-phase feedback)
DELAY R	0.0–1350.0 ms	Right channel delay time
FB.DLY R	0.0–1350.0 ms	Right channel feedback delay time
FB.G R	–99 to +99%	Right channel feedback gain (plus values for normal-phase feedback, minus values for reverse-phase feedback)
L->R FBG	–99 to +99%	Left to right channel feedback gain (plus values for normal-phase feedback, minus values for reverse-phase feedback)
R->L FBG	–99 to +99%	Right to left channel feedback gain (plus values for normal-phase feedback, minus values for reverse-phase feedback)
HI.RATIO	0.1–1.0	High-frequency feedback ratio
HPF	Thru, 21.2 Hz–8.0 kHz	High-pass filter cutoff frequency
LPF	50 Hz–16.0 kHz, Thru	Low-pass filter cutoff frequency
MIX BAL.	0–100 [%]	Mix balance of the effects and dry sounds

■ CHORUS

Chorus effect.

Parameter	Range	Description
FREQ.	0.05–40.00 Hz	Modulation speed
PM DEP.	0–100%	Pitch modulation depth
AM DEP.	0–100%	Amp modulation depth
MOD.DLY	0.0–500.0 ms	Modulation delay time
WAVE	Sine, Tri	Modulation waveform
LSH F	21.2–8.00 k [Hz]	Low-shelving filter frequency
LSH G	–12 to +12 [dB]	Low-shelving filter gain
EQ F	100–8.00 k [Hz]	Parametric equalizer center frequency
EQ G	–12 to +12 [dB]	Parametric equalizer gain
EQ Q	10–0.10	Parametric equalizer band width
HSH F	50.0–16.0 k [Hz]	High-shelving filter frequency
HSH G	–12 to +12 [dB]	High-shelving filter gain
MIX BAL.	0–100 [%]	Mix balance of the effects and dry sounds

■ FLANGE

Flange effect.

Parameter	Range	Description
FREQ.	0.05–40.00 Hz	Modulation speed
DEPTH	0–100%	Modulation depth
MOD.DLY	0.0–500.0 ms	Modulation delay time
FB.GAIN	–99 to +99%	Feedback gain (plus values for normal-phase feedback, minus values for reverse-phase feedback)
WAVE	Sine, Tri	Modulation waveform
LSH F	21.2–8.00 k [Hz]	Low-shelving filter frequency
LSH G	–12 to +12 [dB]	Low-shelving filter gain
EQ F	100–8.00 k [Hz]	Parametric equalizer center frequency
EQ G	–12 to +12 [dB]	Parametric equalizer gain
EQ Q	10–0.10	Parametric equalizer band width
HSH F	50.0–16.0 k [Hz]	High-shelving filter frequency
HSH G	–12 to +12 [dB]	High-shelving filter gain
MIX BAL.	0–100 [%]	Mix balance of the effects and dry sounds

■ SYMPHONIC

Symphonic effect.

Parameter	Range	Description
FREQ.	0.05–40.00 Hz	Modulation speed
DEPTH	0–100%	Modulation depth
MOD.DLY	0.0–500.0 ms	Modulation delay time
WAVE	Sine, Tri	Modulation waveform
LSH F	21.2–8.00 k [Hz]	Low-shelving filter frequency
LSH G	–12 to +12 [dB]	Low-shelving filter gain
EQ F	100–8.00 k [Hz]	Parametric equalizer center frequency
EQ G	–12 to +12 [dB]	Parametric equalizer gain
EQ Q	10–0.10	Parametric equalizer band width
HSH F	50.0–16.0 k [Hz]	High-shelving filter frequency
HSH G	–12 to +12 [dB]	High-shelving filter gain
MIX BAL.	0–100 [%]	Mix balance of the effects and dry sounds

■ PHASER

16-stage phaser.

Parameter	Range	Description
FREQ.	0.05–40.00 Hz	Modulation speed
DEPTH	0–100%	Modulation depth
FB.GAIN	–99 to +99%	Feedback gain (plus values for normal-phase feedback, minus values for reverse-phase feedback)
OFFSET	0–100	Lowest phase-shifted frequency offset
STAGE	2, 4, 6, 8, 10, 12, 14, 16	Number of phase shift stages
LSH F	21.2–8.00 k [Hz]	Low-shelving filter frequency
LSH G	–12 to +12 [dB]	Low-shelving filter gain
HSH F	50.0–16.0 k [Hz]	High-shelving filter frequency
HSH G	–12 to +12 [dB]	High-shelving filter gain
MIX BAL.	0–100 [%]	Mix balance of the effects and dry sounds

■ AUTOPAN

Auto-panner.

Parameter	Range	Description
FREQ.	0.05–40.00 Hz	Modulation speed
DEPTH	0–100%	Modulation depth
DIR.	*1	Panning direction
WAVE	Sine, Tri, Square	Modulation waveform
LSH F	21.2–8.00 k [Hz]	Low-shelving filter frequency
LSH G	–12 to +12 [dB]	Low-shelving filter gain
EQ F	100–8.00 k [Hz]	Parametric equalizer center frequency
EQ G	–12 to +12 [dB]	Parametric equalizer gain
EQ Q	10–0.10	Parametric equalizer band width
HSH F	50.0–16.0 k [Hz]	High-shelving filter frequency
HSH G	–12 to +12 [dB]	High-shelving filter gain
MIX BAL.	0–100 [%]	Mix balance of the effects and dry sounds

*1. L<->R, L->R, L<-R, Turn L, Turn R

■ TREMOLO

Tremolo effect.

Parameter	Range	Description
FREQ.	0.05–40.00 Hz	Modulation speed
DEPTH	0–100%	Modulation depth
WAVE	Sine, Tri, Square	Modulation waveform
LSH F	21.2–8.00 k [Hz]	Low-shelving filter frequency
LSH G	–12 to +12 [dB]	Low-shelving filter gain
EQ F	100–8.00 k [Hz]	Parametric equalizer center frequency
EQ G	–12 to +12 [dB]	Parametric equalizer gain
EQ Q	10–0.10	Parametric equalizer band width
HSH F	50.0–16.0 k [Hz]	High-shelving filter frequency
HSH G	–12 to +12 [dB]	High-shelving filter gain
MIX BAL.	0–100 [%]	Mix balance of the effects and dry sounds

■ HQ.PITCH (Effect 2 only)

High-quality pitch shifter.

Parameter	Range	Description
PITCH	–12 to +12 semitones	Pitch shift
FINE	–50 to +50 cents	Pitch shift fine
DELAY	0.0–1000.0 ms	Delay time
FB.GAIN	–99 to +99%	Feedback gain (plus values for normal-phase feedback, minus values for reverse-phase feedback)
MODE	1–10	Pitch shift precision
MIX BAL.	0–100 [%]	Mix balance of the effects and dry sounds

■ DUAL PITCH

Twin-voice pitch shifter.

Parameter	Range	Description
PITCH 1	–24 to +24 semitones	Channel 1 pitch shift
FINE 1	–50 to +50 cents	Channel 1 pitch shift fine
PAN 1	L16–1, C, R1–16	Channel 1 panpot
DELAY 1	0.0–1000.0 ms	Channel 1 delay time
FB.G 1	–99 to +99%	Channel 1 feedback gain (plus values for normal-phase feedback, minus values for reverse-phase feedback)
LEVEL 1	–100 to +100%	Channel 1 level (plus values for normal phase, minus values for reverse phase)
PITCH 2	–24 to +24 semitones	Channel 2 pitch shift
FINE 2	–50 to +50 cents	Channel 2 pitch shift fine
PAN 2	L16–1, C, R1–16	Channel 2 panpot
DELAY 2	0.0–1000.0 ms	Channel 2 delay time
FB.G 2	–99 to +99%	Channel 2 feedback gain (plus values for normal-phase feedback, minus values for reverse-phase feedback)
LEVEL 2	–100 to +100%	Channel 2 level (plus values for normal phase, minus values for reverse phase)
MODE	1–10	Pitch shift precision
MIX BAL.	0–100 [%]	Mix balance of the effects and dry sounds

■ ROTARY

Rotary speaker simulator.

Parameter	Range	Description
ROTATE	STOP, START	Rotation stop, start
SPEED	SLOW, FAST	Rotation speed (see SLOW and FAST parameters)
DRIVE	0-100	Overdrive level
ACCEL	0-10	Acceleration at speed changes
LOW	0-100	Low-frequency filter
HIGH	0-100	High-frequency filter
SLOW	0.05-10.00 Hz	SLOW rotation speed
FAST	0.05-10.00 Hz	FAST rotation speed
MIX BAL.	0-100 [%]	Mix balance of the effects and dry sounds

■ RING MOD.

Ring modulator.

Parameter	Range	Description
SOURCE	OSC, SELF	Modulation source: oscillator or input signal
OSC FREQ	0.0-5000.0 Hz	Oscillator frequency
FM FREQ	0.05-40.00 Hz	Oscillator frequency modulation speed
FM DEPTH	0-100%	Oscillator frequency modulation depth
MIX BAL.	0-100 [%]	Mix balance of the effects and dry sounds

■ MOD.FILTER

LFO modulation-type filter.

Parameter	Range	Description
FREQ.	0.05-40.00 Hz	Modulation speed
DEPTH	0-100%	Modulation depth
TYPE	LPF, HPF, BPF	Filter type: low pass, high pass, band pass
OFFSET	0-100	Filter frequency offset
RESO.	0-20	Filter resonance
PHASE	0.00-354.38°	Left-channel modulation and right-channel modulation phase difference
LEVEL	0-100	Output level
MIX BAL.	0-100 [%]	Mix balance of the effects and dry sounds

■ DISTORTION

Distortion effect.

Parameter	Range	Description
DST TYPE	DST1, DST2, OVD1, OVD2, CRUNCH	Distortion type (DST = distortion, OVD = overdrive)
DRIVE	0-100	Distortion drive
MASTER	0-100	Master volume
TONE	-10 to +10	Tone
N.GATE	0-20	Noise reduction
MIX BAL.	0-100 [%]	Mix balance of the effects and dry sounds

■ AMP SIMULATE

Guitar Amp Simulator.

Parameter	Range	Description
AMP TYPE	*1	Guitar amp simulation type
DST TYPE	DST1, DST2, OVD1, OVD2, CRUNCH	Distortion type (DST = distortion, OVD = overdrive)
N.GATE	0–20	Noise reduction
DRIVE	0–100	Distortion drive
MASTER	0–100	Master volume
CAB DEP	0–100%	Speaker cabinet simulation depth
BASS	0–100	Bass tone control
MIDDLE	0–100	Middle tone control
TREBLE	0–100	High tone control
EQ F	99–8.0 kHz	Parametric equalizer frequency
EQ G	–12 to +12 dB	Parametric equalizer gain
EQ Q	10.0–0.10	Parametric equalizer bandwidth
MIX BAL.	0–100 [%]	Mix balance of the effects and dry sounds

*1. STK-M1, STK-M2, THRASH, MIDBST, CMB-PG, CMB-VR, CMB-DX, CMB-TW, MINI, FLAT

■ DYNA.FILTER

Dynamically controlled filter.

Parameter	Range	Description
SOURCE	INPUT, MIDI	Control source: input signal or MIDI note on velocity
SENSE	0–100	Sensitivity
TYPE	LPF, HPF, BPF	Filter type
OFFSET	0–100	Filter frequency offset
RESO.	0–20	Filter resonance
DIR.	UP, DOWN	Upward or downward frequency change
DECAY	6.0 ms–46.0 s	Filter frequency change decay speed
LEVEL	0–100	Output Level
MIX BAL.	0–100 [%]	Mix balance of the effects and dry sounds

■ DYNA.FLANGE

Dynamically controlled flanger.

Parameter	Range	Description
SOURCE	INPUT, MIDI	Control source: input signal or MIDI note on velocity
SENSE	0–100	Sensitivity
FB.GAIN	–99 to +99%	Feedback gain (plus values for normal-phase feedback, minus values for reverse-phase feedback)
OFFSET	0–100	Delay time offset
DIR.	UP, DOWN	Upward or downward frequency change
DECAY	6.0 ms–46.0 s	Decay speed
LSH F	21.2–8.00 k [Hz]	Low-shelving filter frequency
LSH G	–12 to +12 [dB]	Low-shelving filter gain
EQ F	100–8.00 k [Hz]	Parametric equalizer center frequency
EQ G	–12 to +12 [dB]	Parametric equalizer gain
EQ Q	10–0.10	Parametric equalizer band width
HSH F	50.0–16.0 k [Hz]	High-shelving filter frequency
HSH G	–12 to +12 [dB]	High-shelving filter gain
MIX BAL.	0–100 [%]	Mix balance of the effects and dry sounds

■ DYNA.PHASER

Dynamically controlled phaser.

Parameter	Range	Description
SOURCE	INPUT, MIDI	Control source: input signal or MIDI note on velocity
SENSE	0–100	Sensitivity
FB.GAIN	–99 to +99%	Feedback gain (plus values for normal-phase feedback, minus values for reverse-phase feedback)
OFFSET	0–100	Lowest phase-shifted frequency offset
STAGE	2, 4, 6, 8, 10, 12, 14, 16	Number of phase shift stages
DIR.	UP, DOWN	Upward or downward frequency change
DECAY	6.0 ms–46.0 s	Decay speed
LSH F	21.2–8.00 k [Hz]	Low-shelving filter frequency
LSH G	–12 to +12 [dB]	Low-shelving filter gain
HSH F	50.0–16.0 k [Hz]	High-shelving filter frequency
HSH G	–12 to +12 [dB]	High-shelving filter gain
MIX BAL.	0–100 [%]	Mix balance of the effects and dry sounds

■ REV+CHORUS

Reverb and chorus effects in parallel.

Parameter	Range	Description
REV TIME	0.3–99.9 s	Reverb time
INI.DLY	0.0–500.0 ms	Initial delay before reverb begins
HI.RATIO	0.1–1.0	High-frequency reverb time ratio
DIFF.	0–10	Reverb diffusion (left-right reverb speed)
DENSITY	0–100%	Reverb density
HPF	Thru, 21.2 Hz–8.0 kHz	High-pass filter cutoff frequency
LPF	50 Hz–16.0 kHz, Thru	Low-pass filter cutoff frequency
FREQ.	0.05–40.00 Hz	Modulation speed
PM DEP.	0–100%	Pitch modulation depth
AM DEP.	0–100%	Amp modulation depth
MOD.DLY	0.0–500.0 ms	Modulation delay time
WAVE	Sine, Tri	Modulation waveform
REV/CHO	0–100%	Reverb and chorus balance (0% = chorus, 100% = reverb)
MIX BAL.	0–100 [%]	Mix balance of the effects and dry sounds

■ REV->CHORUS

Reverb and chorus effects in series.

Parameter	Range	Description
REV TIME	0.3–99.9 s	Reverb time
INI.DLY	0.0–500.0 ms	Initial delay before reverb begins
HI.RATIO	0.1–1.0	High-frequency reverb time ratio
DIFF.	0–10	Reverb diffusion (left-right reverb speed)
DENSITY	0–100%	Reverb density
HPF	Thru, 21.2 Hz–8.0 kHz	High-pass filter cutoff frequency
LPF	50 Hz–16.0 kHz, Thru	Low-pass filter cutoff frequency
FREQ.	0.05–40.00 Hz	Modulation speed
PM DEP.	0–100%	Pitch modulation depth
AM DEP.	0–100%	Amp modulation depth
MOD.DLY	0.0–500.0 ms	Modulation delay time
WAVE	Sine, Tri	Modulation waveform
REV.BAL	0–100%	Reverb and chorused reverb balance (0% = chorused reverb, 100% = reverb)
MIX BAL.	0–100 [%]	Mix balance of the effects and dry sounds

■ REV+FLANGE

Reverb and flanger effects in parallel.

Parameter	Range	Description
REV TIME	0.3–99.9 s	Reverb time
INI.DLY	0.0–500.0 ms	Initial delay before reverb begins
HI.RATIO	0.1–1.0	High-frequency reverb time ratio
DIFF.	0–10	Reverb diffusion (left-right reverb spread)
DENSITY	0–100%	Reverb density
HPF	Thru, 21.2 Hz–8.0 kHz	High-pass filter cutoff frequency
LPF	50 Hz–16.0 kHz, Thru	Low-pass filter cutoff frequency
FREQ.	0.05–40.00 Hz	Modulation speed
DEPTH	0–100%	Modulation depth
MOD.DLY	0.0–500.0 ms	Modulation delay time
FB.GAIN	–99 to +99%	Feedback gain (plus values for normal-phase feedback, minus values for reverse-phase feedback)
WAVE	Sine, Tri	Modulation waveform
REV/FLG	0–100%	Reverb and flange balance (0% = flange, 100% = reverb)
MIX BAL.	0–100 [%]	Mix balance of the effects and dry sounds

■ REV->FLANGE

Reverb and flanger effects in series.

Parameter	Range	Description
REV TIME	0.3–99.9 s	Reverb time
INI.DLY	0.0–500.0 ms	Initial delay before reverb begins
HI.RATIO	0.1–1.0	High-frequency reverb time ratio
DIFF.	0–10	Reverb diffusion (left-right reverb spread)
DENSITY	0–100%	Reverb density
HPF	Thru, 21.2 Hz–8.0 kHz	High-pass filter cutoff frequency
LPF	50 Hz–16.0 kHz, Thru	Low-pass filter cutoff frequency
FREQ.	0.05–40.00 Hz	Modulation speed
DEPTH	0–100%	Modulation depth
MOD.DLY	0.0–500.0 ms	Modulation delay time
FB.GAIN	–99 to +99%	Feedback gain (plus values for normal-phase feedback, minus values for reverse-phase feedback)
WAVE	Sine, Tri	Modulation waveform
REV.BAL	0–100%	Reverb and flanged reverb balance (0% = flanged reverb, 100% = reverb)
MIX BAL.	0–100 [%]	Mix balance of the effects and dry sounds

■ REV+SYMPHO.

Reverb and symphonic effects in parallel.

Parameter	Range	Description
REV TIME	0.3–99.9 s	Reverb time
INI.DLY	0.0–500.0 ms	Initial delay before reverb begins
HI.RATIO	0.1–1.0	High-frequency reverb time ratio
DIFF.	0–10	Reverb diffusion (left-right reverb spread)
DENSITY	0–100%	Reverb density
HPF	Thru, 21.2 Hz–8.0 kHz	High-pass filter cutoff frequency
LPF	50 Hz–16.0 kHz, Thru	Low-pass filter cutoff frequency
FREQ.	0.05–40.00 Hz	Modulation speed
DEPTH	0–100%	Modulation depth
MOD.DLY	0.0–500.0 ms	Modulation delay time
WAVE	Sine, Tri	Modulation waveform
REV/SYM	0–100%	Reverb and symphonic balance (0% = symphonic, 100% = reverb)
MIX BAL.	0–100 [%]	Mix balance of the effects and dry sounds

■ REV->SYMPHO.

Reverb and symphonic effects in series.

Parameter	Range	Description
REV TIME	0.3–99.9 s	Reverb time
INI.DLY	0.0–500.0 ms	Initial delay before reverb begins
HI.RATIO	0.1–1.0	High-frequency reverb time ratio
DIFF.	0–10	Reverb diffusion (left-right reverb spread)
DENSITY	0–100%	Reverb density
HPF	Thru, 21.2 Hz–8.0 kHz	High-pass filter cutoff frequency
LPF	50 Hz–16.0 kHz, Thru	Low-pass filter cutoff frequency
FREQ.	0.05–40.00 Hz	Modulation speed
DEPTH	0–100%	Modulation depth
MOD.DLY	0.0–500.0 ms	Modulation delay time
WAVE	Sine, Tri	Modulation waveform
REV.BAL	0–100%	Reverb and symphonic reverb balance (0% = symphonic reverb, 100% = reverb)
MIX BAL.	0–100 [%]	Mix balance of the effects and dry sounds

■ REV->PAN

Reverb and auto-pan effects in parallel.

Parameter	Range	Description
REV TIME	0.3–99.9 s	Reverb time
INI.DLY	0.0–500.0 ms	Initial delay before reverb begins
HI.RATIO	0.1–1.0	High-frequency reverb time ratio
DIFF.	0–10	Reverb diffusion (left-right reverb spread)
DENSITY	0–100%	Reverb density
HPF	Thru, 21.2 Hz–8.0 kHz	High-pass filter cutoff frequency
LPF	50 Hz–16.0 kHz, Thru	Low-pass filter cutoff frequency
FREQ.	0.05–40.00 Hz	Modulation speed
DEPTH	0–100%	Modulation depth
DIR.	*1	Panning direction
WAVE	Sine, Tri, Square	Modulation waveform
REV BAL.	0–100%	Reverb and panned reverb balance (0% = panned reverb, 100% = reverb)
MIX BAL.	0–100 [%]	Mix balance of the effects and dry sounds

*1. L<->R, L->R, L<-R, Turn L, Turn R

■ DELAY+ER.

Delay and early reflections effects in parallel.

Parameter	Range	Description
DELAY L	0.0–1000.0 ms	Left channel delay time
DELAY R	0.0–1000.0 ms	Right channel delay time
FB.DLY	0.0–1000.0 ms	Feedback delay time
FB.GAIN	-99 to +99%	Feedback gain (plus values for normal-phase feedback, minus values for reverse-phase feedback)
HI.RATIO	0.1–1.0	High-frequency feedback ratio
TYPE	S-Hall, L-Hall, Random, Revers, Plate, Spring	Type of early reflection simulation
ROOMSIZE	0.1–20.0	Reflection spacing
LIVENESS	0–10	Early reflections decay characteristics (0 = dead, 10 = live)
INI.DLY	0.0–500.0 ms	Initial delay before reverb begins
DIFF.	0–10	Reverb diffusion (left-right reverb spread)
DENSITY	0–100%	Reverb density
ER NUM.	1–19	Number of early reflections
HPF	Thru, 21.2 Hz–8.0 kHz	High-pass filter cutoff frequency
LPF	50 Hz–16.0 kHz, Thru	Low-pass filter cutoff frequency
DLY/ER	0–100%	Delay and early reflections balance (0% = early reflections, 100% = delay)
MIX BAL.	0–100 [%]	Mix balance of the effects and dry sounds

■ DELAY->ER.

Delay and early reflections effects in series.

Parameter	Range	Description
DELAY L	0.0–1000.0 ms	Left channel delay time
DELAY R	0.0–1000.0 ms	Right channel delay time
FB.DLY	0.0–1000.0 ms	Feedback delay time
FB.GAIN	–99 to +99%	Feedback gain (plus values for normal-phase feedback, minus values for reverse-phase feedback)
HI.RATIO	0.1–1.0	High-frequency feedback ratio
TYPE	S-Hall, L-Hall, Random, Revers, Plate, Spring	Type of early reflection simulation
ROOMSIZE	0.1–20.0	Reflection spacing
LIVENESS	0–10	Early reflections decay characteristics (0 = dead, 10 = live)
INI.DLY	0.0–500.0 ms	Initial delay before reverb begins
DIFF.	0–10	Reverb diffusion (left-right reverb spread)
DENSITY	0–100%	Reverb density
ER NUM.	1–19	Number of early reflections
HPF	Thru, 21.2 Hz–8.0 kHz	High-pass filter cutoff frequency
LPF	50 Hz–16.0 kHz, Thru	Low-pass filter cutoff frequency
DLY.BAL	0–100%	Delay and early reflected delay balance (0% = early reflected delay, 100% = delay)
MIX BAL.	0–100 [%]	Mix balance of the effects and dry sounds

■ DELAY+REV

Delay and reverb effects in parallel.

Parameter	Range	Description
DELAY L	0.0–1000.0 ms	Left channel delay time
DELAY R	0.0–1000.0 ms	Right channel delay time
FB.DLY	0.0–1000.0 ms	Feedback delay time
FB.GAIN	–99 to +99%	Feedback gain (plus values for normal-phase feedback, minus values for reverse-phase feedback)
DELAY HI	0.1–1.0	Delay high-frequency feedback ratio
REV TIME	0.3–99.9 s	Reverb time
INI.DLY	0.0–500.0 ms	Initial delay before reverb begins
REV HI	0.1–1.0	High-frequency reverb time ratio
DIFF.	0–10	Reverb diffusion (left-right reverb spread)
DENSITY	0–100%	Reverb density
HPF	Thru, 21.2 Hz–8.0 kHz	High-pass filter cutoff frequency
LPF	50 Hz–16.0 kHz, Thru	Low-pass filter cutoff frequency
DLY/REV	0–100%	Delay and reverb balance (0% = reverb, 100% = delay)
MIX BAL.	0–100 [%]	Mix balance of the effects and dry sounds

■ DELAY->REV

Delay and reverb effects in series.

Parameter	Range	Description
DELAY L	0.0–1000.0 ms	Left channel delay time
DELAY R	0.0–1000.0 ms	Right channel delay time
FB.DLY	0.0–1000.0 ms	Feedback delay time
FB.GAIN	–99 to +99%	Feedback gain (plus values for normal-phase feedback, minus values for reverse-phase feedback)
DELAY HI	0.1–1.0	Delay high-frequency feedback ratio
REV TIME	0.3–99.9 s	Reverb time
INI.DLY	0.0–500.0 ms	Initial delay before reverb begins
REV HI	0.1–1.0	High-frequency reverb time ratio
DIFF.	0–10	Reverb diffusion (left-right reverb spread)
DENSITY	0–100%	Reverb density
HPF	Thru, 21.2 Hz–8.0 kHz	High-pass filter cutoff frequency
LPF	50 Hz–16.0 kHz, Thru	Low-pass filter cutoff frequency
DLY.BAL	0–100%	Delay and delayed reverb balance (0% = delayed reverb, 100% = delay)
MIX BAL.	0–100 [%]	Mix balance of the effects and dry sounds

■ DIST->DELAY

Distortion and delay effects in series.

Parameter	Range	Description
DST TYPE	DST1, DST2, OVD1, OVD2, CRUNCH	Distortion type (DST = distortion, OVD = overdrive)
DRIVE	0–100	Distortion drive
MASTER	0–100	Master volume
TONE	–10 to +10	Tone control
N.GATE	0–20	Noise reduction
DELAY	0.0–2725.0 ms	Delay time
FB.GAIN	–99 to +99%	Feedback gain (plus values for normal-phase feedback, minus values for reverse-phase feedback)
HI.RATIO	0.1–1.0	High-frequency feedback ratio
FREQ.	0.05–40.00 Hz	Modulation speed
DEPTH	0–100%	Modulation depth
DLY BAL	0–100%	Distortion and delay balance (0% = distortion, 100% = delayed distortion)
MIX BAL.	0–100 [%]	Mix balance of the effects and dry sounds

■ MULTI FILTER

Three-band parallel filter (24 dB/octave)

Parameter	Range	Description
TYPE 1	HPF, LPF, BPF	Filter 1 type: low pass, high pass, band pass
TYPE 2	HPF, LPF, BPF	Filter 2 type: low pass, high pass, band pass
TYPE 3	HPF, LPF, BPF	Filter 3 type: low pass, high pass, band pass
FREQ. 1	28 Hz–16.0 kHz	Filter 1 frequency
FREQ. 2	28 Hz–16.0 kHz	Filter 2 frequency
FREQ. 3	28 Hz–16.0 kHz	Filter 3 frequency
LEVEL 1	0–100	Filter 1 level
LEVEL 2	0–100	Filter 2 level
LEVEL 3	0–100	Filter 3 level
RESO. 1	0–20	Filter 1 resonance
RESO. 2	0–20	Filter 2 resonance
RESO. 3	0–20	Filter 3 resonance
MIX BAL.	0–100 [%]	Mix balance of the effects and dry sounds

Sample library list

This is a list of the sample libraries that are installed on the internal hard disk when the AW16G is shipped from the factory.

The list is printed here in the order as sorted by the OLD button.

Name	PAD1				PAD2				PAD3				PAD4			
	A	B	C	D	A	B	C	D	A	B	C	D	A	B	C	D
Normal8_120	L	L	-	-	L	L	-	-	L	L	-	-	O	O	-	-
Normal8_60	L	L	-	-	L	L	-	-	L	L	-	-	O	O	-	-
Normal16_120	L	L	-	-	L	L	-	-	L	L	-	-	O	O	-	-
Normal16_60	L	L	-	-	L	L	-	-	L	L	-	-	O	O	-	-
NormShffl120	L	L	-	-	L	L	-	-	L	L	-	-	O	O	-	-
NormShffl_60	L	L	-	-	L	L	-	-	L	L	-	-	O	O	-	-
Med8_110	L	L	-	-	L	L	-	-	L	L	-	-	O	O	-	-
MedFast8_140	L	L	-	-	L	L	-	-	L	L	-	-	O	O	-	-
MedSlow8_90	L	L	-	-	L	L	-	-	L	L	-	-	O	O	-	-
Fast8_170	L	L	-	-	L	L	-	-	L	L	-	-	O	O	-	-
Simple8_125	L	L	-	-	L	L	-	-	L	L	-	-	O	O	-	-
Simple16_114	L	L	-	-	L	L	-	-	L	L	-	-	O	O	-	-
Bounce8_93	L	L	-	-	L	L	-	-	L	L	-	-	O	O	-	-
LatinRock126	L	L	-	-	L	L	-	-	L	L	-	-	O	O	-	-
Syncopatn_89	L	L	-	-	L	L	-	-	L	L	-	-	O	O	-	-
Triplet_65	L	L	-	-	L	L	-	-	L	L	-	-	O	O	-	-
Shuffle8_130	L	L	-	-	L	L	-	-	L	L	-	-	O	O	-	-
Shffle16_127	L	L	-	-	L	L	-	-	L	L	-	-	O	O	-	-
Southern_93	L	L	-	-	L	L	-	-	L	L	-	-	O	O	-	-
Funk1_108	L	L	-	-	L	L	-	-	L	L	-	-	O	O	-	-
Funk2_108	L	L	-	-	L	L	-	-	L	L	-	-	O	O	-	-
NJS_110	L	L	-	-	L	L	-	-	L	L	-	-	O	O	-	-
Hip_96	L	L	-	-	L	L	-	-	L	L	-	-	O	O	-	-
HipFunk_106	L	L	-	-	L	L	-	-	L	L	-	-	O	O	-	-
OldSkool_106	L	L	-	-	L	L	-	-	L	L	-	-	O	O	-	-
LoudFunk_118	L	L	-	-	L	L	-	-	L	L	-	-	O	O	-	-
Detoroit_129	L	L	-	-	L	L	-	-	L	L	-	-	O	-	-	-
BreakRock106	L	L	-	-	L	L	-	-	L	L	-	-	L	L	-	-
Gangsta_94	L	L	-	-	L	L	-	-	L	L	-	-	O	O	-	-
GarageHs_128	L	L	-	-	L	L	-	-	L	L	-	-	O	O	-	-
2Step_135	L	L	-	-	L	L	-	-	L	L	-	-	L	L	-	-
R&BSmooth_64	L	L	-	-	L	L	-	-	L	L	-	-	O	O	-	-
TrncHouse135	L	L	-	-	L	L	-	-	L	L	-	-	L	L	-	-
TecLectro134	L	L	-	-	L	L	-	-	L	L	-	-	L	L	-	-
OldSkol2_102	L	L	-	-	L	L	-	-	L	L	-	-	L	L	-	-
FlipHop_128	L	L	-	-	L	L	-	-	L	L	-	-	O	-	-	-
BigBeat_126	L	L	-	-	L	L	-	-	L	L	-	-	O	O	-	-
Drumn'Bs_147	L	L	-	-	L	L	-	-	L	L	-	-	L	L	-	-
Techno_140	L	L	-	-	L	L	-	-	L	L	-	-	O	O	-	-
Ibiza_135	L	L	-	-	L	L	-	-	L	L	-	-	L	L	-	-
SambaEns_137	L	L	-	-	L	L	-	-	L	L	-	-	L	L	-	-
Latin16_80	L	-	-	-	L	-	-	-	L	-	-	-	L	-	-	-
Latin8_130	L	L	-	-	L	L	-	-	L	L	-	-	O	O	-	-

Name	PAD1				PAD2				PAD3				PAD4			
	A	B	C	D	A	B	C	D	A	B	C	D	A	B	C	D
LatinSwng154	L	L	-	-	L	L	-	-	L	L	-	-	O	O	-	-
Scratch1	O	O	-	-	O	O	-	-	O	O	-	-	O	O	-	-
Scratch2	O	O	-	-	O	O	-	-	O	O	-	-	O	O	-	-
SE_Analog	O	O	-	-	O	O	-	-	O	O	-	-	O	O	-	-
SE_Beep	O	O	-	-	O	O	-	-	O	O	-	-	O	O	-	-
SE_SFX	O	O	-	-	O	O	-	-	O	O	-	-	O	O	-	-
Robot_Voice	O	O	-	-	O	O	-	-	O	O	-	-	O	O	-	-
Female_Wet	O	O	-	-	O	O	-	-	O	O	-	-	O	O	-	-
Female_Dry	O	O	-	-	O	O	-	-	O	O	-	-	O	O	-	-
Male_Dry	O	O	-	-	O	O	-	-	O	O	-	-	O	O	-	-
City_Noise	L	L	-	-	L	L	-	-	O	O	-	-	O	O	-	-
Car_Action	O	O	-	-	O	O	-	-	O	O	-	-	O	O	-	-
Other_Rides	O	O	-	-	O	O	-	-	O	O	-	-	O	O	-	-
Door_Action	O	O	-	-	O	O	-	-	O	O	-	-	O	O	-	-
Guns	O	O	-	-	O	O	-	-	O	O	-	-	O	O	-	-
Laser&Buzz	O	O	-	-	O	O	-	-	O	O	-	-	O	O	-	-
Bang&Explosn	O	O	-	-	O	O	-	-	O	O	-	-	O	O	-	-
Bell&Beep	O	O	-	-	O	O	-	-	O	O	-	-	O	O	-	-
Human_Action	O	O	-	-	O	O	-	-	O	O	-	-	O	O	-	-
Punch&Swish	O	O	-	-	O	O	-	-	O	O	-	-	O	O	-	-
Hit&Swish	O	O	-	-	O	O	-	-	O	O	-	-	O	O	-	-
Fire	L	-	-	-	L	-	-	-	L	-	-	-	L	-	-	-
Rain1	L	-	-	-	L	-	-	-	L	-	-	-	L	-	-	-
Rain2	L	-	-	-	L	-	-	-	L	-	-	-	O	-	-	-
Storm	L	L	-	-	L	L	-	-	L	L	-	-	L	L	-	-
River	L	L	-	-	L	L	-	-	L	L	-	-	L	L	-	-
Sea	O	O	-	-	L	L	-	-	O	O	-	-	L	L	-	-
Jungle_Amb	L	-	-	-	L	-	-	-	L	-	-	-	L	-	-	-
Night_Amb	O	O	-	-	L	L	-	-	L	-	-	-	L	-	-	-
Birds	L	L	-	-	L	L	-	-	O	O	-	-	O	O	-	-
Dog&Cat	O	O	-	-	O	O	-	-	O	O	-	-	O	O	-	-
Stock_Farm	O	O	-	-	O	O	-	-	O	O	-	-	O	O	-	-
For_Demo	L	L	-	-	L	L	-	-	L	L	-	-	O	O	-	-

L: LOOP

O: ONESHOT

-: No assigns

Troubleshooting

If the AW16G does not operate as you expect, or if you suspect a problem, please refer to the following points and take the appropriate action.

■ Power does not turn on

- Is the AC adaptor connected to an AC outlet of the correct voltage?
- Is the POWER switch turned ON?
- If the power still does not turn on, please contact your Yamaha dealer.

■ LCD display is dim or dark

- Use the contrast knob located at the lower right of the screen to adjust the contrast.

■ Can't use the [DATA/JOG] dial to control on-screen parameters

- The [JOG ON] key may be on.
- Some parameters cannot be operated in certain states, such as while the recorder is running.

No sound

■ No sound, or sound is too faint

- Are speakers or headphones connected correctly?
- Is your amp and other external devices turned on?
- Does the stereo output channel meter move?
- Is the stereo output channel fader raised? Is it turned on?
- The EQ gain may be set to an extremely low value.
- The dynamics processor may be set to an extreme threshold or ratio.
- If you are connecting an electric guitar, is it connected to the Hi-Z jack?
- Is the attenuator of the EQ screen or VIEW screen raised?
 - * Check the level (meter movement) in the METER page of the VIEW screen.
 - * If you press the [SEL] key in the MONITOR screen INIT page, that channel will be initialized to default values that allow sound to be output.
 - * If DIGITAL IN is set to other than DISABLE in the UTILITY screen D.IN HDD page, and no signal is being input to the DIGITAL INPUT jack, a message of "WRONG WORD CLOCK" will appear, and sound will not be output.

■ Input sound is not output

- Is the signal from the external device being input?
- The connection cable from the external device may be broken.
- Is the [GAIN] control set to an appropriate level?
- Is the input channel fader raised? Is it turned on?
- The input channel may have been set to DIGITAL IN.
- When recording, is the recording-destination track fader (which adjusts the monitor level) raised?
 - * If you are recording, the sound of that input channel will not be heard during playback.

■ Recorded sound is not output

- Has audio data been recorded on the recorder?
- Is the virtual track set to the track that was recorded?
- A recorded region shorter than 10 msec will not be played back.
- Tracks 1–16 will not play back if the AW16G is in Stereo Track, Sound Clip, or Audio CD playback mode.

■ Can't play back the STEREO track

- Is the stereo track turned on in the MONITOR screen ST.TRACK page?

■ Metronome cannot be heard

- The metronome sound is normally sent only to the MONITOR OUT and headphones.
- The metronome will not sound while the recorder is stopped.
- In Sound Clip mode, the metronome will sound only during recording.

Can't record, something is wrong with the recorded sound

■ Can't record

- Is there sufficient free space on the internal hard disk?
 - * You can check the remaining recordable time by setting the counter display to REMAIN in the SONG screen SETUP page.
- The song may be protected.
- The stereo track may be in playback mode.
- Is the input signal routed appropriately to the recorder?
- Check the recording-source and recording-destination in the QUICK NAVIGATE page RECORD screen?
- DIGITAL REC may have been turned OFF in the UTILITY screen PREFER page.
- Please read and understand the copyright warning (→ p. 5) before using digital input signals.

■ Can't record on the STEREO track

- It is not possible to record on the STEREO track while recording on other tracks.

■ Noise is present in the recorded signal

- The oscillator may be functioning.
- Does the word clock setting match for the AW16G and the external device(s)?
- Go to the QUICK NAVIGATE screen RECORD page and check the recording-source and recording-destination.

Something wrong with the sound

- **Signal from the INPUT 8 jack is too loud**
 - A conventional line-level signal may be connected to the Hi-Z jack.
- **Sound is distorted**
 - Is the [GAIN] control set correctly?
 - The connection cable from the external device may be broken.
 - The fader of the input channel or monitor channel may be raised excessively.
 - The stereo output channel fader may be raised excessively.
 - The stereo output channel attenuator may be raised excessively.
 - The EQ or dynamics processor may have been set to produce an extreme gain boost.
 - Did you record at an appropriate level?
 - Is the word clock setting correct for both the AW16G and the external device(s)?
 - An effect such as Distortion or Amp Simulate may be in use.
 - * Go to the VIEW screen METER page and check the level (meter movement).
- **The volume of a particular channel increases or decreases**
 - Are the dynamics processor settings appropriate?
 - A scene recall may be specified in the SONG screen TEMPO MAP.
- **Can't store a scene**
 - The store-destination scene may be protected.
 - A scene cannot be stored in scene number 00.
- **Can't reproduce a scene**
 - One or more channels may be set to Recall Safe.
- **Can't save to a library**
 - It is not possible to save to the factory-preset libraries.
- **Meters move even though the faders are lowered**
 - The meter display may be set to PRE FADER.
- **Moving a fader does not change the level**
 - In the [VIEW] screen FADER page, check whether the display moves in correspondence with fader operations.
 - * You cannot control the level until the panel fader position matches the position shown in the display.
 - In the UTILITY screen PREFER page, is FADER FLIP set appropriately?
 - * When the power is turned on, FADER FLIP will be set to TRACK.
 - The fader may be set to PRE FADE in AUX.
- **Pairing was specified, but the signal is monaural**
 - Is the odd-numbered channel panned far left and the even-numbered channel panned far right?
- **Pairing was specified, but the signal phase does not match**
 - Even when channels are paired, the phase setting is not linked.
- **Signal is delayed**
 - An effect such as delay may be inserted.

- **Can't use the internal effects**
 - Effect BYPASS may be turned ON.
 - The effect may have been inserted into a different channel.
 - Are the level of EFF.RTN 1, 2 faders raised?
 - 019. HQ. Pitch can be used only with EFFECT 2.
 - These do not affect the stereo track, sound clip, or audio CD playback.
- **Playback pitch is wrong**
 - VARI may be selected.
 - Is the synchronized external device operating on the same sampling frequency (44.1 kHz)?
 - Is the master device operating in a stable way?
 - You may have executed the EDIT screen PITCH command.
 - Is an effect such as HQ.Pitch or Dual Pitch selected for a monitor channel?

Recorder operations

- **When you press the [PLAY] key it blinks, and playback does not occur**
 - Is the AW16G set to MTC SLAVE?
 - * Access the UTILITY screen MIDI page, and check the setting.
- **Something goes wrong with the sound when you use the [FF] key or [REW] key**
 - Differences in the number of simultaneously played tracks will affect the way in which the sound is heard when these controls are operated.
- **Can't edit a recorded track**
 - The song may be protected.
 - Have you selected the virtual track that you recorded?
- **Editing results are not heard in the sound**
 - Have you selected the virtual track that you recorded?
 - Are you using the appropriate editing command? *
 - * For details on editing commands, refer to "EDIT screen."
- **Counter display is not 0 when you return to the beginning of the song**
 - The display mode may be set to REMAIN (remaining recording time).
 - If the display mode is set to REL (relative time), the start point may be specified.
 - * Go to the SONG screen SETUP, POINT page and check the settings.
- **Display indicates DISK FULL, MEMORY FULL, or TOO MANY REGIONS, and you cannot record or edit**
 - There is insufficient free space, or too many recording regions. Erase unneeded tracks and then perform the Optimize operation to obtain more free space.
- **The display indicates DISK BUSY during playback**
 - It is possible that the recorded data has become fragmented, so that it cannot be read fast enough. You can try measures such as re-recording, deleting tracks, or backing up the data and then formatting the hard disk.

Sampler operations

- **When you press a pad there is no sound, or the wrong bank is heard**
 - Have you selected a bank to which the waveform is assigned?
 - A bank change may have been specified in the SONG screen TEMPO MAP page.
- **The sound is not what you loaded, or the sound is different depending on whether you are stopped or playing**
 - If the playback mode is set to LOOP, the sound will play according to the monitor tempo specified in the SAMPLE screen SETUP page while the recorder is stopped, and will play according to the song tempo while the recorder is playing.
- **The sound you loaded only plays part of the way**
 - Have you made trim settings to shorten the Start–End region?
 - If the playback mode is set to GATE, the sample will play only while you continue pressing the pad.
 - If the playback mode is set to LOOP and Slice is turned off, the sample will play only for the length of a measure.
- **The display indicates MEMORY FULL, and you can't sample or import**
 - Access the SAMPLE screen MEMORY page, and check the amount of used memory. Execute ERASE or EXTRACT to increase the amount of free memory.

MIDI operations

- **Can't exchange MIDI data**
 - Are the MIDI cables connected correctly?
 - A MIDI cable may be broken.
 - Is the power turned on for the transmitting and receiving devices?
 - Do the channel settings match for the transmitted and receiving devices?
 - Have the appropriate settings been made in the UTILITY screen MIDI page?
 - * MIDI data cannot be transmitted or received unless the MIDI button is turned on.
 - Is a scene assigned to the program change number being transmitted?
- **MTC messages are not transmitted**
 - In the UTILITY screen MIDI page, has the MTC button been turned on?
 - Is MTC SYNC set to MASTER?
- **The AW16G does not synchronize to incoming MTC messages**
 - Is the MIDI cable connected to the MIDI IN connector?
 - In the UTILITY screen MIDI page, has MTC Sync been set to SLAVE?
 - * MIDI data cannot be transmitted or received unless the MIDI button is turned on.

- **MTC synchronization drifts**
 - Is a large amount of MIDI data (notes etc.) being received together with the MTC messages?
 - Does the frame rate match between the AW16G and the external device?
 - SYNC OFFSET may have been set.
 - If jumps occur in the synchronized time, change the SYNC AVE. setting in the UTILITY screen MIDI page, and try again.
- **MMC messages is not transmitted**
 - Is the MIDI cable connected to the MIDI OUT connector?
 - In the UTILITY screen MIDI page, has MMC been set to MASTER? Does the DEVICE NO. match?
- **Can't receive MMC messages**
 - Is the MIDI cable connected to the MIDI IN connector?
 - In the UTILITY screen MIDI page, has MMC been set to SLAVE? Does the DEVICE NO. match?
- **Can't use the preset remote settings.**
 - Depending on the sequencer that you want to control, you may need to make settings on the sequencer. For details, refer to page 200.
 - MIDI data cannot be transmitted unless the MIDI button is turned on in the MIDI page of the UTILITY screen.

Song operations

- **Can't save a file**
 - Is there sufficient space on the internal hard disk?
 - Did you perform the correct shut-down procedure when you last turned off the power? *
 - * Disconnecting the power without performing the shut-down operation will shorten the lifespan of the hard disk and CD-RW drive, may damage the hard disk and CD-RW drive and disc, and may result in loss of data.
- **Song file size is unnaturally large**
 - Even after you use recorder editing operations to erase a track or other data, that sound file will remain on the disk. Execute the Optimize command in the SONG screen LIST page.

CD operations

- **CD-RW drive is not recognized**
 - Is the CD-RW drive connected correctly?
- **Can't create an audio CD**
 - Is the CD-RW drive installed correctly? Have the attaching screws come loose?
 - Is CD-R/RW media inserted?
 - The inserted CD-R may have already been finalized.
 - Is a signal recorded on the stereo track?
 - The stereo track must be at least four seconds long.
 - Have you saved a song in which a stereo track has been recorded?
 - Does the display indicate DISK FULL?
 - Create sufficient space on the hard disk.
 - Erase unneeded tracks and then execute Optimize to increase the available space.

- **An audio CD you created does not play back on a conventional player**
 - An audio CD you created you not play back on a conventional player unless the disc has been finalized.
- **Audio recorded on CD-RW media does not play back on some players**
 - In order for audio data recorded on CD-RW media to be played back, the player must support CD-RW. Contact the manufacturer of the player regarding CD-RW support.
- **The sound skips while playing an audio CD that you created**
 - Depending on the CD-R media you use, there may be differences in the quality of the completed CD.

Display message list

■ Messages

A/B POINTS NOT FOUND	Repeat Playback cannot be performed because A/B points are not specified.
BULK: BYTE COUNT MISMATCH!	The data length specified within the received system exclusive data did not match the length of the data that was actually received.
BULK: CHECK SUM MISMATCH!	The check sum of the received system exclusive is incorrect.
BULK: MEMORY PROTECTED!	The scene memory you attempted to receive is protected.
CANNOT REDO	Redo (re-execution of an operation) is not possible.
CANNOT SET MARK	It is not possible to specify a mark at an already-specified position.
CANNOT UNDO	Undo (cancellation of an operation) is not possible.
CD PLAY MODE NOW	Since the AW16G is in CD Play mode, this operation is not possible.
CH. PARAMETER INITIALIZED	The mixer parameters of the channel have been initialized.
DIFFERENT TC FRAME TYPE	MTC of a different frame type than the internal setting is being received.
DIGITAL-ST-IN REC PROHIBIT.	Recording is prohibited for the signal being input from DIGITAL STEREO IN.
DISK BUSY!!	The reading speed of the internal hard disk is not fast enough, or the reading speed has slowed down because the recorded data has become fragmented.
DISK FULL!!	There is insufficient space on the internal hard disk.
IN/OUT POINTS NOT FOUND	Auto-punch recording cannot be performed because in/out points are not specified.
IN/OUT POINTS TOO CLOSE	The auto punch-in/out interval is too short. It cannot be set less than approximately 100 msec.
LOCATE POINT ERASED	The locate point has been erased.
LOCATE POINT SET	The locate point has been set.
MARK POINT ERASED	The mark has been erased.
MARK POINT SET	The mark has been set.
MEMORY FULL!!	The song has no more free space. One song can use a maximum of 6.4 GB.
MIDI BULK RECEIVED	A bulk data dump was received.
MIDI IN: DATA FRAMING ERROR!	Invalid data may have been received at the MIDI IN connector.
MIDI IN: DATA OVERRUN!	Invalid data may have been received at the MIDI IN connector.
MIDI: RX BUFFER FULL!	Receiving more MIDI data than it can handle.
MIDI: TX BUFFER FULL!	Attempting to transmit more MIDI data than it can handle.
MTC SLAVE MODE NOW	This operation cannot be performed because the AW16G is in MTC Slave mode.
NO MARK LEFT	The allowable number of marks has been exceeded.
NO MEDIA!!	Media has not been inserted.
RECORDER BUSY	The operation cannot be executed because the recorder is operating.
RECORDER RUNNING	The operation cannot be executed because the recorder is recording or playing.
RECORD TRACK NOT SELECTED	Recording cannot be performed because you have not selected a record track.
REDO COMPLETE	Redo (re-execution of the previous operation) has been completed.
REPEAT POINTS TOO CLOSE	The repeat interval is too short. It cannot be set to less than one second.
SOUND CLIP MODE NOW	Since you are in Sound Clip mode, this operation cannot be executed.
STEREO TRACK PLAYBACK MODE	Since you are in Stereo Track Playback mode, this operation cannot be executed.
SYSTEM ERROR!!	An internal system error has occurred.
THIS SONG IS PROTECTED.	This song is protected, and cannot be edited or recorded.
TOO MANY REGIONS!	There are too many recorded regions.
TRIGGER LIST RECORDING	A sampling pad trigger list is being recorded.
UNDO COMPLETE	Undo (cancellation of the previous operation) has been executed.
WRONG WORD CLOCK!!	An inappropriate word clock is being received from the connected device to which you are synchronizing.

■ Popup messages

ATAPI Error!	A problem occurred while communicating with the CD-RW drive.
Can't Select Current Song!	The current song cannot be selected.
CD Size Full!	Data exceeding the recordable length of the CD cannot be added.
CD Track Over!	The maximum number of tracks has been reached, and further addition is not possible.
CD-RW Drive Error!	A problem occurred with the CD-RW drive.
CD-RW Drive Not Found!	No CD-RW drive is installed.
CD Write Error!	The data could not be written correctly to the CD.
Change Media, Invalid Order.	Please exchange the media. The order of media volumes is incorrect.
Change Media, Not 1st Media.	Please exchange the media. This is not the first media volume.
Change Media, Please.	The media is an incorrect type. Please exchange it.
Compare Error!	The data was not written correctly.
Disk Full!	The disk has no free capacity.
End Range Over!	The operation could not be executed, since the end of the song would be later than 24 hours.
Exchange Next Media.	Please insert the next volume of media.
File Number Full!	No more songs can be created or restored, since this would exceed the maximum number of files.
File System Error!	An error has occurred in the file system of the internal hard disk.
For Effect2 Only!	This cannot be recalled because it is only for use with EFFECT 2.
HDD Error!	A problem occurred with the internal hard disk.
IDE Error!	A problem occurred while communicating with the internal hard disk.
Invalid Parameter!	The parameter setting exceeds the allowable range.
Media Error!	A problem has occurred on the media.
Media Full!	The media has no free space.
Memory Full!	The song has no more free space. One song can use a maximum of 6.4 GB.
Memory Full!	There is no more free space in sampling pad memory.
No Data to Backup!	You have not selected data to back up.
No Data to Restore!	You have not selected data to restore.
No Data!	The selected region does not contain data.
No Data!	Since no data has been saved, you cannot recall, erase, or edit the title.
No Media!	Media has not been inserted.
No Song to Write!	No songs to write to the CD have been selected.
No Stereo Track!	There is no song that includes a master track longer than four seconds.
Not 44.1kHz/16bit Song!	The song cannot be restored since it is not a 44.1 kHz/16-bit song.
Prohibit CD Import!	Can't import from a CD because DIGITAL REC is prohibited.
Protected!	Can't save, erase, or edit the title because the song is protected.
Read Only!	Can't save, erase, or edit the title because the song is read-only.
Recognized AW2816- Formatted Media!	This is AW2816 format media.
Recognized AW4416- Formatted Media!	This is AW4416 format media.
Song Number Full!	No more songs can be created or restored, since this would exceed the maximum number of songs.
System Error!	An internal system error has occurred.
Too Small File!	WAVE files shorter than 200 msec cannot be imported.
Too Small Region!	Time compression/expansion cannot be executed because the region is too short.
Track Length Too Short!	Since the song length divided by the markers would be less than four seconds, you cannot divide it with a marker.
Track Not Recorded!	The track you selected does not contain any recorded data.

About the CD-ROM included with the AW16G

Caution

- This disk is a CD-ROM. Do not attempt to play the disk on an audio CD player. Doing so may result in irreparable damage to your audio CD player.
- All copyrights to this software are the property of Yamaha Corporation.
- Copying or modification of this software in part or in whole is forbidden.
- Yamaha Corporation takes no responsibility for any results or damages that may result from your use of this software.
- Cubase VST is a trademark of Steinberg Media Technologies AG.
- Logic Audio is a trademark of Emagic Soft- und Hardware GmbH.
- Cakewalk is a registered trademark of Twelve Tone Systems, Inc.
- ProTools is a trademark or registered trademark of Avid Technology, Inc. or its related companies.
- Windows is a registered trademark of Microsoft Corporation USA in the United States and other countries.
- Macintosh is a registered trademark of Apple Computer, Inc. USA in the United States and other countries.
- Other company names and product names in this document are the trademarks or registered trademarks of their respective corporate owners.

Contents of the CD-ROM

The included CD-ROM contains a backup file that you can use to restore the AW16G to its factory-set condition, and setting files that let you use the AW16G's MIDI Remote function with various software sequencers.

Folder name	Software name	Contents
Remote	Cubase remote file	Setting file for remotely controlling the Cubase sequencer software from the AW16G.
	Logic remote file	Setting file for remotely controlling the Logic sequencer software from the AW16G.
	SONAR 2/CakewalkProAudio remote file (Windows only)	Setting file for remotely controlling the SONAR 2/CakewalkProAudio sequencer software from the AW16G.

When you view this CD-ROM in Windows, a file named Aw_00000.16g will appear in the root directory. This is a backup file of the demo song and sample library that is installed in the internal hard disk when the AW16G is shipped from the factory. This file cannot be opened from Windows or Macintosh.

Restoring the internal hard disk to the factory-set condition

In order to restore the internal hard disk to the factory-set condition, you will need to perform the following two procedures.

- 1) Initialize the internal hard disk
- 2) Load the demo song and sample library



Since this procedure will erase all data from the internal hard disk, be sure to create a backup of any important data before you perform this procedure.

■ Initializing the internal hard disk

Initialize the internal hard disk. (→ p. 160)

When you initialize the internal hard disk, the system settings will return to their factory-set state.

■ Loading the demo song and sample library

1 Insert the included CD-ROM into the CD-RW drive of the AW16G.

2 In the Work Navigate section, repeatedly press the [CD] key to access the RESTORE page.

3 Make sure that the cursor is located at the READ CD INFO button, and press the [ENTER] key.

Loading from the CD-ROM will begin. When loading is finished, the contents of the display will change as follows.



4 Move the cursor to the DISABLE button and press the [ENTER] key.

The DISABLE button will change to ENABLE, and the symbol at the right of the list will change to ●.

5 Move the cursor to the PAD button and press the [ENTER] key.

Once again, loading from the CD-ROM will begin. When loading is finished, the contents of the display will change as follows.



6 Move the cursor to the ALL button and press the [ENTER] key.

7 Move the cursor to the DISABLE button and press the [ENTER] key.

The DISPLAY button will change to ENABLE, and all symbols at the right of the list will change to ●.

This selects all songs and sample libraries.

8 Move the cursor to the EXECUTE button and press the [ENTER] key.

9 A popup window will ask you for confirmation, so move the cursor to the OK button or CANCEL button, and press the [ENTER] key.

While the Restore operation is being executed, the state of progress will be shown in a popup window. When this popup window closes, the operation has been completed.

Installing a remote file

Please be aware that the menu names and screens that appear in the explanation below may differ depending on the software you are using.

■ Windows users

In order to use a remote file, the corresponding software must be installed.

Installing the Cubase remote setup file

1 Start up Cubase.

2 In the menu bar, click [Option] → [Remote Setup] → [Setup].

3 The VST Remote window will appear. Make the following settings and click the [OK] button.

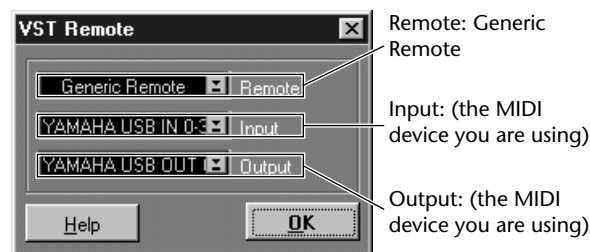

Note

The content that is shown for "Input" and "Output" will depend on the MIDI device(s) you are using. For details, refer to the owner's manual for the MIDI device(s) you are using.

4 The Generic Remote window will appear. Click the [EDIT] button.

5 The Generic Remote Setup window will appear. Click the [Import] button.

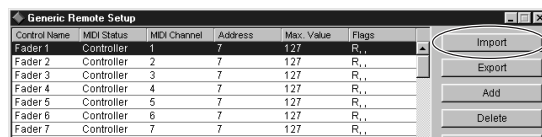

6 A dialog box like the following will appear. Select the Cubase remote setup file (Yamaha AW16G Remote.xml) from the included CD-ROM, and click the [Open] button.

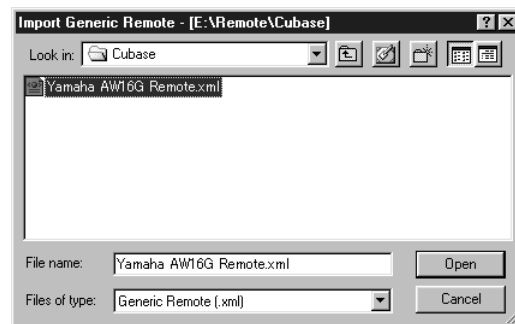

7 Close the Generic Remote Setup window.

Installing the Logic preference file

- 1 Start up Logic.
- 2 In the menu bar, click [Option] → [Settings] → [Key Commands...].
- 3 The Key Commands window will open. In the menu bar, click [Option] → [Import Key Commands...].
- 4 A dialog box will appear. Select the Logic preference file (Logic32.prf) from the included CD-ROM, and click the [Open] button.

When you import the file, the following settings will be made.

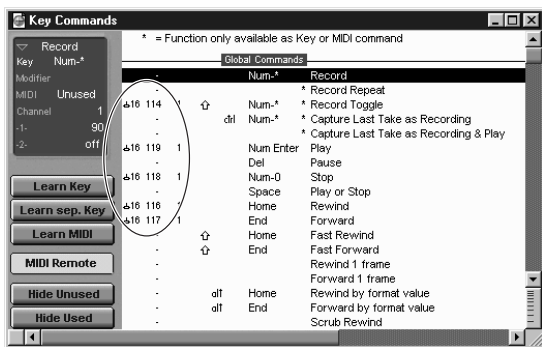

Please note that all the previously-specified key commands will be initialized. If you do not want to change your existing user key command settings, you can manually make the MIDI channel and CC# settings shown above.

SONAR 2/CakewalkProAudio template (Installation/settings)

- 1 Copy the template to the folder in which SONAR 2/CakewalkProAudio is installed.
- 2 Start up SONAR 2/CakewalkProAudio.
- 3 In the menu bar, click [Option] → [Audio].
- 4 The Cakewalk DirectShow Audio dialog box will appear. Change the “Number of Aux Busses” (from the default value of 2) to [3], and click the [OK] button.

This completes preparations for the template.

SONAR 2/CakewalkProAudio template (Loading the template)

- 1 Start up SONAR 2/CakewalkProAudio.
- 2 If you are using SONAR 2:
In the menu bar, click [File] → [Open].
If you are using Cakewalk:
In the menu bar, click [File] → [New].
- 3 If you are using SONAR 2:
The “Open file” dialog box will appear. Choose Cakewalk template files as the type of file to be loaded. From the list in the dialog box, choose Yamaha AW16G Remote and click the [OK] button.
If you are using Cakewalk:
The “New Project File” dialog box will appear. From the list in the dialog box, choose Yamaha AW16G Remote, and click the [OK] button.
The template will be loaded, and three windows will appear; the Track window, Control window, and Panel window.
- 4 In the menu bar, click [Option] → [MIDI Devices].
- 5 The MIDI Ports window will open. In the Input Ports field, assign the MIDI device that you are using.

This completes preparations for controlling SONAR 2/ CakewalkProAudio from the AW16G.

● If you changed the track structure from the default settings of the template ...

With the Yamaha AW16G Remote template started, click the [CONFIG] button in the panel window.

A cluster will open at the right.

Drag the [SET MIDI First Track] knob to the first track number of the MIDI tracks.

- * If you use this template, you will not be able to control the tracks correctly from the AW16G unless the MIDI tracks are continuous from 1—16.
- * If you set the value to an invalid track (an unused track), the panel knobs, buttons, or sliders may be shaded. If this occurs, set the value back to the correct track.

Pro Tools software

You can remotely control the Pro Tools software from the AW16G. No special setting file is required. The setting procedure is the same as for the Mac version.

Refer to “Macintosh users” → “Pro Tools software” (→ p. 203).

■ Macintosh users

In order to use a remote file, the corresponding software must be installed.

Installing the Cubase remote setup file

For Cubase, the procedure is the same as for the Windows version. Refer to "Windows users" → "Installing the Cubase remote setup file" (→ p. 201).

Installing the Logic preference file

- 1 Start up Logic.
- 2 Click [Option] → [Settings] → [Key Commands...].
- 3 The Key Commands window will open. In the Key Commands window, click [Option] → [Import Key Commands].
- 4 A dialog box will appear. Select the Logic preference file (Logic Preferences) from the included CD-ROM, and click the [Open] button.

When you import the file, the following settings will be made.

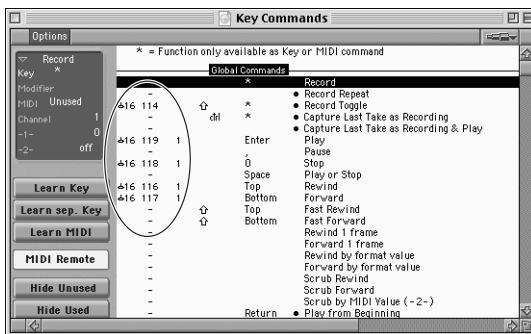

Please note that all the previously-specified key commands will be initialized. If you do not want to change your existing user key command settings, you can manually make the MIDI channel and CC# settings shown above.

Pro Tools softwares

You can remotely control the Pro Tools software from the AW16G. No special setting file is required. Use the following procedure to make settings.

- 1 In the menu bar, click [Setup] → [Peripherals...].
- 2 The Peripherals window will open. Click the [MIDI Controllers] button.

In the MIDI Controllers window, make the following settings.

In the Receive From field and the Send to field, specify the MIDI device you are using.

	Type	Receive From	Send to	#ch's
#1	CS-10	(the MIDI device you are using)	(the MIDI device you are using)	16

This completes preparations for using the AW16G's MIDI Remote function to control the Pro Tools software.

MIDI data format

1. Functions

1.1. Scene Change

The settings of the [MIDI PROGRAM CHANGE TABLE] specify the scene that is recalled when a Program Change message is received. The settings of the [MIDI PROGRAM CHANGE TABLE] specify the program number that is transmitted when a scene is recalled. If more than one program number has been assigned to that scene memory number, the lowest-numbered program number will be transmitted.

1.2. MMC Control

These messages allow basic recorder operations such as STOP/PLAY/REC/LOCATE.

If you select the MIDI SETUP menu item MMC MASTER, MMC commands will be transmitted according to the operation of the transport. If you select MMC SLAVE, the internal recorder will operate according to the received MMC commands.

1.3. Effect Control

Depending on the type of effect, note-on/off messages can be used for control.

These settings are made for the parameters of each effect.

1.4. MIDI Clock transmission

If you set MIDI OUT to MIDI CLOCK, MIDI clock messages can be transmitted during playback or recording.

In MIDI Clock transmission mode, Song Position Pointer and Start/Stop/Continue commands will also be issued, and during playback or recording, MIDI Clock will be transmitted according to the MIDI Tempo Map.

1.5. MTC transmission (MTC Master)

If you set MIDI OUT to MTC, MTC can be transmitted during playback or recording.

1.6. MTC reception (MTC Slave)

If you set MTC MODE to SLAVE, the internal recorder will operate in synchronization with MTC messages received from the MIDI IN connector.

1.7. Realtime control of parameters

Control changes can be used to send/receive internal parameters in realtime.

1.8. Transmission of scene memories or data

The bulk dump function can be used to send data to another device, or copy settings from another device to the AW16G.

1.9. MIDI Remote

The faders, SEL keys, and RTZ / FF / REW / STOP / PLAY / REC keys can be used to control an external MIDI device.

In PRESET mode, operating the above controllers will transmit MIDI data according to the preset settings of the AW16G.

In USER mode, operating the above controllers will transmit the MIDI data that you specify.

2. MIDI data flow diagram

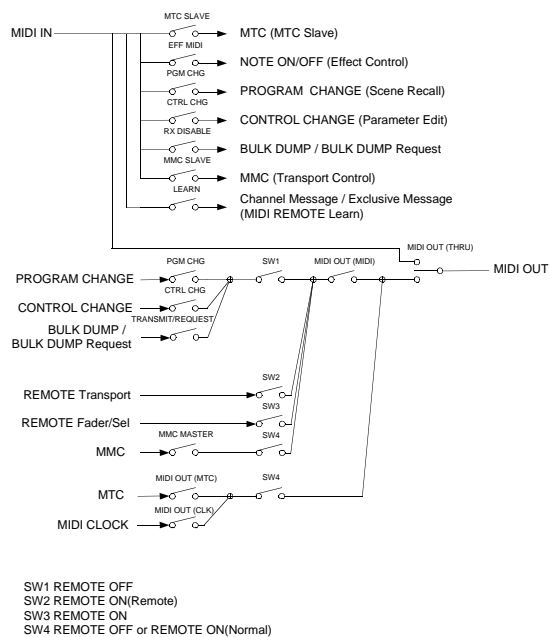

3. AW16G settings and operation

3.1. MIDI Setup

Set basic MIDI operation.

3.1.1. MIDI OUT

Specify the function of the MIDI OUT connector.

3.1.2. MMC MODE

Select whether the AW16G will be the MMC MASTER or SLAVE.

3.1.3. MMC Dev.

Specify the ID number that will be used when transmitting or receiving MMC commands.

3.1.4. MTC SYNC MODE

Select whether the AW16G will be the MTC MASTER or SLAVE.

3.1.5. MTC SYNC AVERAGE

When the AW16G is functioning as a MTC SLAVE, this setting specifies how it will follow the MTC data. Set this to 0 if the incoming MTC data has a highly accurate timing; set this to 1 or 2 if the timing of the incoming MTC data is not as accurate (such as when receiving MTC from a software sequencer).

3.1.6. MTC SYNC OFFSET

When the AW16G is functioning as a MTC SLAVE, this setting adds an offset to the received MTC data. The received time code value shifted by this amount will correspond to the location indicated by the internal time code of the AW16G.

3.1.7. MIDI Tx Ch

This sets the MIDI channel that will normally be used. However, transmission in response to a request will occur on the Receive Channel, in order to specify the device that transmitted the request.

3.1.8. MIDI Rx Ch

This sets the MIDI channel that will be used for reception. If this is set to ALL, data of all MIDI channels will be received.

3.1.9. Program Change Mode

Enable/disable reception and transmission. If MIDI Rx Ch is set to ALL, these messages will be received regardless of their MIDI channel.

3.1.10. Control Change Mode

If this is enabled, you can specify the correspondence between control numbers and operations of the mixer section. For mode 1, transmission and reception will occur without regard to the MIDI Tx Ch and MIDI Rx Ch settings. For modes 2 and 3, reception will occur without regard to MIDI channel if you set MIDI Rx Ch to ALL.

3.2. MIDI BULK DUMP

Controls transmission of Bulk Dump and Bulk Dump Request.

3.2.1. BULK DUMP Category

Selects the type of parameters for Dump or Dump Request.

3.2.1.1. SCENE

Mixer scene settings. E.BUF is the current state, 01-96 are stored scenes. ALL selects all scenes.

3.2.1.2. LIBRARY

All memory settings for all libraries (EQ / EFFECT / DYNAMICS / CHANNEL).

3.2.1.3. SYSTEM

Settings that apply to the entire AW16G.

3.2.1.4. REMOTE

Settings for the MIDI Remote function.

3.2.1.5. PROGRAM CHANGE TABLE

This is the Program Change Table.

3.2.1.6. ALL

All of the above settings.

3.2.2. INTERVAL

Specifies the interval at which consecutive Bulk Dump or Bulk Dump Request messages will be transmitted. Increase this setting if the receiving device fails to receive all of the bulk data.

3.2.3. RX DISABLE

If RX Disable is turned on, no Bulk Dump or Bulk Dump Request messages will be received.

3.2.4. REQUEST

Transmits the selected Bulk Dump Request.

3.2.5. TRANSMIT

Transmits the selected Bulk Dump.

3.3. MIDI PROGRAM CHANGE TABLE

This table allows you to freely specify the correspondence between Program Change No. and Scene No.

This table is used for conversion for both transmission and reception.

4. MIDI format list

4.1. CHANNEL MESSAGE

	Command	Rx/Tx	function
8n	NOTE OFF	Rx	Control the internal effect
9n	NOTE ON	Rx	Control the internal effect
Bn	CONTROL CHANGE	Rx/Tx	Edit parameters
Cn	PROGRAM CHANGE	Rx/Tx	Switch scene memories

4.2. SYSTEM COMMON MESSAGE

	Command	Rx/Tx	function
F1	MIDI TIME CODE	Rx/Tx	MTC transmission
F2	SONG POSITION POINTER	Tx	Song position transmission

4.3. SYSTEM REALTIME MESSAGE

	Command	Rx/Tx	function
F8	TIMING CLOCK	Tx	MIDI Clock transmission
FA	START	Tx	Start command transmission
FB	CONTINUE	Tx	Continue command transmission
FC	STOP	Tx	Stop command transmit
FE	ACTIVE SENSING	Rx	Check MIDI cable connections
FF	RESET	Rx	Clear running status

4.4. SYSTEM EXCLUSIVE MESSAGE

4.4.1. REALTIME SYSTEM EXCLUSIVE

4.4.1.1. MMC

	Command	Rx/Tx	function
01	STOP	Rx/Tx	Transport stop
02	PLAY	Rx	Transport play
03	DEFERRED PLAY	Rx/Tx	Transport play
04	FAST FORWARD	Rx/TX	Transport fast-forward
05	REWIND	Rx/Tx	Transport rewind
06	RECORD STROBE	Rx	Transport punch-in record
07	RECORD EXIT	Rx	Transport punch-out
0F	RESET	Rx/Tx	MMC reset
44	LOCATE	Rx/Tx	Transport locate

4.4.2. BULK DUMP / BULK DUMP REQUEST

Data Name	Rx/Tx	function
'M'	Rx/Tx	Scene Memory & Request
'S'	Rx/Tx	System Memory & Request
'R'	Rx/Tx	Remote Memory & Request
'Q'	Rx/Tx	Equalizer Library & Request
'Y'	Rx/Tx	Dynamics Library & Request
'E'	Rx/Tx	Effect Library & Request
'H'	Rx/Tx	Channel Library & Request
'P'	Rx/Tx	Program Change Table & Request

5. MIDI format details

5.1. NOTE OFF (8n)

< Reception >

Received when [Rx CH] matches.

Used to control effects. Refer NOTE ON for details.

```
STATUS      1000nnnn 8n Note Off Message
DATA        0nnnnnnn nn Note No.
            0vvvvvvvv vv Velocity ( ignored)
```

5.2. NOTE ON (9n)

< Reception >

Received when [Rx CH] matches.

Used to control effects. Refer below for details.

Velocity of 0x00 is equivalent to Note-Off.

```
STATUS      1001nnnn 9n Note On Message
DATA        0nnnnnnn nn Note No.
            0vvvvvvvv vv Velocity ( 1-127:On, 0:off)
```

* Effect control by Note

1: Dynamic Flange/Dynamic Phase/Dynamic Filter

When the SOURCE parameter is set to MIDI, the note velocity (both note-on and note-off) is used to control the Modulation frequency width.

5.3. CONTROL CHANGE (Bn)

< Reception >

Control change messages will be received if the [Control Change Mode] is RX or TX/RX and the [MIDI Rx Ch] matches. However if [MIDI Rx Ch] is ALL, this message is received regardless of the channel.

< Transmission >

If [Control Change Mode] is TX or TX/RX, control change messages will be transmitted on the [MIDI Tx Ch] channel when you operate a parameter.

```
STATUS      1011nnnn Bn Control Change
DATA        0ccccccc cc Control No. (0-95, 102-119)
            0vvvvvvvv vv Control Value (0-127)
```

The control value is converted into a parameter value according to the following equation.

$S = \text{total number of steps in the parameter's variable range}$

$128 / S = X \text{ remainder } Y$

$\text{INT}((Y+1)/2) = Z$

If $(\text{MIDI DATA} - Z) < 0$, then Value = 0

If $((\text{MIDI DATA} - Z)/X) > \text{MAX}$, then Value = MAX

Otherwise, Value = $\text{INT}((\text{MIDI DATA} - Z)/X)$

5.4. PROGRAM CHANGE (Cn)

< Reception >

Program change messages will be received if the [Program Change Mode] is RX or TX/RX and the [MIDI Rx Ch] matches. However if [MIDI Rx Ch] is ALL, this message is received regardless of the channel.

A scene memory will be recalled according to the [PROGRAM CHANGE TABLE] settings.

< Transmission >

If [Program Change Mode] is TX or TX/RX, a program change will be transmitted on the [MIDI Tx Ch] according to the [PROGRAM CHANGE TABLE] settings when you recall a memory number. If the recalled memory number has been assigned to more than one program number, the lowest-numbered program number will be transmitted.

```
STATUS      1100nnnn Cn Program Change
DATA        0nnnnnnn nn Program No. ( 0-127)
```

5.5. MIDI TIME CODE QUARTER FRAME (F1)

< Transmission >

If [MIDI OUT] is set to MTC, Quarter Frame messages will be transmitted according to the time code movements of the recorder when the recorder is playing or recording.

< Reception >

This message is received if [MTC SYNC MODE] is set to SLAVE.

Quarter Frame messages received in realtime are internally assembled into time code that controls the recorder.

```
STATUS      11110001 F1 Quarter Frame Message
DATA        0nnnrdddd dd nnn = message type (0-7) dddd = data
```

5.6. SONG POSITION POINTER (F2)

< Transmission >

If [MIDI OUT] is set to CLK, a song position message will be transmitted when STOP or LOCATE is performed on the recorder, to indicate the song position from which the song should start at the next START or CONTINUE message.

```
STATUS      11110010 F2 Song Position Pointer
DATA        0ddddddd dd0 data(H) high 7 bits of 14 bits data
            0ddddddd dd1 data(L) low 7 bits of 14 bits data
```

5.7. TIMING CLOCK (F8)

< Transmission >

If [MIDI CLK] is ON, this message is transmitted according to the MIDI Tempo Map from when the recorder begins playing or recording, until it stops.

```
STATUS      11111000 F8 Timing Clock
```

5.8. START (FA)

< Transmission >

If [MIDI CLK] is ON, this message is transmitted when the recorder begins playing or recording at a location other than the first measure.

```
STATUS      11111010 FA Start
```

5.9. CONTINUE (FB)

< Transmission >

If [MIDI CLK] is ON, this message is transmitted when the recorder begins playing or recording at a location other than the first measure.

```
STATUS      11111011 FB Continue
```

5.10. STOP (FC)

< Transmission >

If [MIDI CLK] is ON, this message is transmitted when the recorder stops.

```
STATUS      11111100 FC Stop
```

5.11. ACTIVE SENSING (FE)

< Reception >

Once this message is received, subsequent failure to receive any message for a period of 300 ms will cause Running Status to be cleared, and MIDI communications to be initialized.

```
STATUS      11111110 FE Active Sensing
```

5.12. RESET (FF)

< Reception >

When a Reset message is received, MIDI communications will be initialized by clearing Running Status etc.

```
STATUS      11111111 FF Reset
```

5.13. EXCLUSIVE MESSAGE (F0-F7)

5.13.1. MMC

5.13.1.1. MMC STOP

< Transmission >

When the STOP key is pressed, this message is transmitted with a device number of 7F.

< Reception >

If the AW16G is operating as an MMC Slave, the transport will stop when this message is received with a matching device number or a device number of 7F.

```
STATUS      11110000 F0 System Exclusive Message
ID No.      01111111 7F Real Time System Exclusive
Device ID   0ddddddd dd Destination (00-7E, 7F:all call)
Command     00000110 06 Machine Control Command(mcc) sub-id
            00000001 01 Stop(MCS)
EOX         11110111 F7 End Of Exclusive
```

5.13.1.2. MMC PLAY

< Reception >

If the AW16G is operating as an MMC Slave, the transport will begin playback when this message is received with a matching device number or a device number of 7F.

```
STATUS      11110000 F0 System Exclusive Message
ID No.      01111111 7F Real Time System Exclusive
Device ID   0ddddddd dd Destination (00-7E, 7F:all call)
Command     00000110 06 Machine Control Command(mcc) sub-id
            00000010 02 Play(MCS)
EOX         11110111 F7 End Of Exclusive
```

5.13.1.3. MMC DEFERED PLAY

< Transmission >

This message is transmitted with a device number of 7F when the PLAY key is pressed.

< Reception >

If the AW16G is operating as an MMC Slave, the transport will begin playback when this message is received with a matching device number or a device number of 7F.

```
STATUS      11110000 F0 System Exclusive Message
ID No.      01111111 7F Real Time System Exclusive
Device ID   0ddddddd dd Destination (00-7E, 7F:all call)
Command     00000110 06 Machine Control Command(mcc) sub-id
            00000011 03 Deferred play(MCS)
EOX         11110111 F7 End Of Exclusive
```

5.13.1.4. MMC FAST FORWARD

< Transmission >

This message is transmitted with a device number of 7F when the FF key is pressed or when the Shuttle is rotated toward the right to enter Cue mode.

< Reception >

If the AW16G is operating as an MMC Slave, the transport will begin fast-forward when this message is received with a matching device number or a device number of 7F.

```
STATUS      11110000 F0 System Exclusive Message
ID No.      01111111 7F Real Time System Exclusive
Device ID   0ddddddd dd Destination (00-7E, 7F:all call)
Command     00000110 06 Machine Control Command(mcc) sub-id
            00000110 04 Fast Forward(MCS)
EOX         11110111 F7 End Of Exclusive
```

5.13.1.5. MMC REWIND

< Transmission >

This message is transmitted with a device number of 7F when the REWIND key is pressed or when the Shuttle is rotated toward the left to enter Review mode.

< Reception >

If the AW16G is operating as an MMC Slave, the transport will begin rewind when this message is received with a matching device number or a device number of 7F.

```
STATUS      11110000 F0 System Exclusive Message
ID No.      01111111 7F Real Time System Exclusive
Device ID   0ddddddd dd Destination (00-7E, 7F:all call)
Command     00000110 06 Machine Control Command(mcc) sub-id
            00000101 05 Rewind(MCS)
EOX         11110111 F7 End Of Exclusive
```

5.13.1.6. MMC RECORD STROBE

< Reception >

This message is received if the AW16G is operating as an MMC Slave and the device number matches or is 7F. If the transport is stopped, then recording will begin. If the transport is playing, then punch-in will occur.

```
STATUS      11110000 F0 System Exclusive Message
ID No.      01111111 7F Real Time System Exclusive
Device ID   0ddddddd dd Destination (00-7E, 7F:all call)
Command     00000110 06 Machine Control Command(mcc) sub-id
            00000110 06 Record strobe
EOX         11110111 F7 End Of Exclusive
```

5.13.1.7. MMC RECORD EXIT

< Reception >

This message is received if the AW16G is operating as an MMC Slave and the device number matches or is 7F. If the transport is recording, then punch-out will occur.

```
STATUS      11110000 F0 System Exclusive Message
ID No.      01111111 7F Real Time System Exclusive
Device ID   0ddddddd dd Destination (00-7E, 7F:all call)
Command     00000110 06 Machine Control Command(mcc) sub-id
            00000111 07 Record Exit
EOX         11110111 F7 End Of Exclusive
```

5.13.1.8. MMC RESET

< Transmission >

This message is transmitted with a device number of 7F when song loading is finished.

< Reception >

This message is received if the AW16G is operating as an MMC Slave and the device number matches or is 7F. MMC-related internal settings will be reset to the power-on state.

```
STATUS      11110000 F0 System Exclusive Message
ID No.      01111111 7F Real Time System Exclusive
Device ID   0ddddddd dd Destination (00-7E, 7F:all call)
Command     00000110 06 Machine Control Command(mcc) sub-id
            00001101 0D Reset
EOX         11110111 F7 End Of Exclusive
```

5.13.1.9. MMC LOCATE (TARGET)

< Transmission >

This message is transmitted with a device number of 7F when a locate-related key such as MARK SEARCH/IN/OUT is pressed, a FF/REW/shuttle operation is performed, when the transport returns to the auto-punch pre-roll point, or when repeating.

< Reception >

This message is received if the AW16G is operating as an MMC Slave and the device number matches. The transport will locate to the time code position specified within the command data.

```
STATUS      11110000 F0 System Exclusive Message
ID No.      01111111 7F Real Time System Exclusive
Device ID   0ddddddd dd Destination (00-7E, 7F:all call)
Command     00000110 06 Machine Control Command(mcc) sub-id
            01000100 44 Locate
            00000110 06 byte count
            00000001 01 "target" sub command
            0hhhhhhh hh hour (Standard Time Code)
            0mmmmmmm mm minute
            0sssssss ss second
            0ffffff ff frame
            0sssssss ss sub-frame
EOX         11110111 F7 End Of Exclusive
```

5.13.2. BULK DUMP / BULK DUMP REQUEST

This message inputs/outputs the contents of various internal memories. The unique header is used to distinguish whether the data belongs to the AW16G.

The check sum is calculated by adding the bytes starting after BYTE COUNT (LOW) and ending before CHECK SUM, then inverting the bits and adding 1 (binary complement), and setting bit 7 to 0.

CHECK SUM = (-sum) & 0x7F

< Reception >

This message is received if [RX DISABLE] is off, and the [MIDI Rx Ch] matches the MIDI channel included in the Sub Status.

When a bulk dump is received, it is immediately written into the specified memory.

When a bulk dump request is received, a bulk dump will be transmitted immediately.

System Memory Bulk Dump is not received while the recorder is running.

< Transmission >

Bulk Dump messages are transmitted on the [Tx CH] in response to key operations in the [MIDI BULK DUMP] screen.

Bulk Dump messages are transmitted on the received MIDI channel in response to a Bulk Dump Request.

5.13.2.1. Scene Memory Bulk Dump Format

STATUS	11110000	F0	System Exclusive Message
ID No.	01000011	43	Manufacturer's ID No.(YAMAHA)
SUB STATUS	0000nnnn	0n	n=0-15(MIDI Channel No.1-16)
FORMAT No.	01111110	7E	Universal Bulk Dump
BYTE COUNT (HIGH)	00111111	3F	8126(8116+10)bytes
BYTE COUNT (LOW)	01111110	3E	
	01001100	4C	'L'
	01001101	4D	'M'
	00100000	20	''
	00100000	20	''
	00111000	38	'8'
	01000011	43	'C'
	00110011	37	'7'
	00110110	35	'5'
DATA NAME	01001101	4D	'M'
	0mmmmmmmm	mm	m=0-96,97(Scene Memory No.0-96, Current Scene)
			Receive is effective No.1-96,97
DATA	0ddddddd	ds	Scene Memory((4058*2) bytes)
			::
	0ddddddd	de	
CHECK SUM	0eeeeeee	ee	ee=(INVERT('L'+M'+...+ds+...+de)+1) AND 7Fh
EOX	11110111	F7	End Of Exclusive

All data is divided into 4 bit units.

5.13.2.2. Scene Memory Bulk Dump Request Format

STATUS	11110000	F0	System Exclusive Message
ID No.	01000011	43	Manufacturer's ID (YAMAHA)
SUB STATUS	0010nnnn	2n	n=0-15(MIDI Channel No.1-16)
FORMAT No.	01111110	7E	Universal Bulk Dump
	01001100	4C	'L'
	01001101	4D	'M'
	00100000	20	''
	00100000	20	''
	00111000	38	'8'
	01000011	43	'C'
	00110111	37	'7'
	00110101	35	'5'
DATA NAME	01001101	4D	'M'
	0mmmmmmmm	mm	m=0-96,97(Scene Memory No.0-96, Current Scene)
EOX	11110111	F7	End Of Exclusive

5.13.2.3. System Memory Bulk Dump Format

STATUS	11110000	F0	System Exclusive Message
ID No.	01000011	43	Manufacturer's ID No.(YAMAHA)
SUB STATUS	0000nnnn	0n	n=0-15(MIDI Channel No.1-16)
FORMAT No.	01111110	7E	Universal Bulk Dump
BYTE COUNT (HIGH)	00000001	01	128(118+10)bytes
BYTE COUNT (LOW)	00000000	00	
	01001100	4C	'L'
	01001101	4D	'M'
	00100000	20	''
	00100000	20	''
	00111000	38	'8'
	01000011	43	'C'
	00110111	37	'7'
	00110101	35	'5'
DATA NAME	01010011	53	'S'
	00100000	20	''
DATA	0ddddddd	ds	Setup Memory(59*2bytes)
			::
	0ddddddd	de	
CHECK SUM	0eeeeeee	ee	ee=(INVERT('L'+M'+...+ds+...+de)+1) AND 7Fh
EOX	11110111	F7	End Of Exclusive

All data is divided into 4 bit units.

5.13.2.4. System Memory Bulk Dump Request Format

STATUS	11110000	F0	System Exclusive Message
ID No.	01000011	43	Manufacturer's ID (YAMAHA)
SUB STATUS	0010nnnn	2n	n=0-15(MIDI Channel No.1-16)
FORMAT No.	01111110	7E	Universal Bulk Dump
	01001100	4C	'L'
	01001101	4D	'M'
	00100000	20	''
	00100000	20	''
	00111000	38	'8'
	01000011	43	'C'
	00110111	37	'7'
	00110101	35	'5'
DATA NAME	01010011	53	'S'
	00100000	20	''
EOX	11110111	F7	End Of Exclusive

5.13.2.5. Remote Memory Bulk Dump Format

STATUS	11110000	F0	System Exclusive Message
ID No.	01000011	43	Manufacturer's ID No.(YAMAHA)
SUB STATUS	0000nnnn	0n	n=0-15(MIDI Channel No.1-16)
FORMAT No.	01111110	7E	Universal Bulk Dump
BYTE COUNT (HIGH)	00001111	0F	1962(1952+10)bytes
BYTE COUNT (LOW)	00101010	2A	
	01001100	4C	'L'
	01001101	4D	'M'
	00100000	20	''
	00100000	20	''
	00111000	38	'8'
	01000011	43	'C'
	00110111	37	'7'
	00110101	35	'5'
DATA NAME	01010010	52	'R'
	00100000	20	''
DATA	0ddddddd	ds	Remote(Internal Parameter) Memory(976*2bytes)
			::
	0ddddddd	de	
CHECK SUM	0eeeeeee	ee	ee=(INVERT('L'+M'+...+ds+...+de)+1) AND 7Fh
EOX	11110111	F7	End Of Exclusive

All data is divided into 4 bit units.

5.13.2.6. Remote Memory Bulk Dump Request Format

```

STATUS      11110000 F0 System Exclusive Message
ID No.      01000011 43 Manufacturer's ID (YAMAHA)
SUB STATUS  0010nnnn 2n n=0-15(MIDI Channel No.1-16)
FORMAT No.  01111110 7E Universal Bulk Dump
             01001100 4C 'L'
             01001101 4D 'M'
             00100000 20 ''
             00100000 20 ''
             00111000 38 '8'
             01000011 43 'C'
             00110111 37 '7'
             00110101 35 '5'
DATA NAME   01010010 52 'R'
             00100000 20 ''
EOX         11110111 F7 End Of Exclusive
    
```

5.13.2.7. Equalizer Library Bulk Dump Format

```

STATUS      11110000 F0 System Exclusive Message
ID No.      01000011 43 Manufacturer's ID No.(YAMAHA)
SUB STATUS  0000nnnn 0n n=0-15(MIDI Channel No.1-16)
FORMAT No.  01111110 7E Universal Bulk Dump
BYTE COUNT  00000000 00 110(100+10)bytes
(HIGH)
BYTE COUNT  01101110 6E
(LOW)
             01001100 4C 'L'
             01001101 4D 'M'
             00100000 20 ''
             00100000 20 ''
             00111000 38 '8'
             01000011 43 'C'
             00110111 37 '7'
             00110101 35 '5'
DATA NAME   01010001 51 'Q'
             0mmmmmmmm mm m= 0-127 (Equalizer Library No.1-128)
             Receive is effective No.41-128
DATA        0dyyyyyy ds Equalizer Library Memory(48*2bytes)
             : :
             0dyyyyyy de
CHECK SUM   0eeeeeee ee ee=(INVERT('L'+M'+...+ds+...+de)+1) AND
             7Fh
EOX         11110111 F7 End Of Exclusive
    
```

All data is divided into 4 bit units.

5.13.2.8. Equalizer Library Bulk Dump Request Format

```

STATUS      11110000 F0 System Exclusive Message
ID No.      01000011 43 Manufacturer's ID (YAMAHA)
SUB STATUS  0010nnnn 2n n=0-15(MIDI Channel No.1-16)
FORMAT No.  01111110 7E Universal Bulk Dump
             01001100 4C 'L'
             01001101 4D 'M'
             00100000 20 ''
             00100000 20 ''
             00111000 38 '8'
             01000011 43 'C'
             00110111 37 '7'
             00110101 35 '5'
DATA NAME   01010001 51 'Q'
             0mmmmmmmm mm m= 0-127 (Equalizer Library No.1-128)
EOX         11110111 F7 End Of Exclusive
    
```

5.13.2.9. Dynamics Library Bulk Dump Format

```

STATUS      11110000 F0 System Exclusive Message
ID No.      01000011 43 Manufacturer's ID No.(YAMAHA)
SUB STATUS  0000nnnn 0n n=0-15(MIDI Channel No.1-16)
FORMAT No.  01111110 7E Universal Bulk Dump
BYTE COUNT  00000000 00 94(84+10)bytes
(HIGH)
BYTE COUNT  01011110 5E
(LOW)
             01001100 4C 'L'
             01001101 4D 'M'
             00100000 20 ''
             00100000 20 ''
             00111000 38 '8'
             01000011 43 'C'
             00110111 37 '7'
             00110101 35 '5'
DATA NAME   01011001 59 'Y'
             0mmmmmmmm mm m= 0-127 (Dynamics Library No.1-128)
             Receive is effective No.41-128
DATA        0dyyyyyy ds Dynamics Library Memory(42*2 bytes)
             : :
             0dyyyyyy de
CHECK SUM   0eeeeeee ee ee=(INVERT('L'+M'+...+ds+...+de)+1) AND
             7Fh
EOX         11110111 F7 End Of Exclusive
    
```

All data is divided into 4 bit units.

5.13.2.10. Dynamics Library Bulk Dump Request Format

```

STATUS      11110000 F0 System Exclusive Message
ID No.      01000011 43 Manufacturer's ID (YAMAHA)
SUB STATUS  0010nnnn 2n n=0-15(MIDI Channel No.1-16)
FORMAT No.  01111110 7E Universal Bulk Dump
             01001100 4C 'L'
             01001101 4D 'M'
             00100000 20 ''
             00100000 20 ''
             00111000 38 '8'
             01000011 43 'C'
             00110111 37 '7'
             00110101 35 '5'
DATA NAME   01011001 59 'Y'
             0mmmmmmmm mm m= 0-127 (Dynamics Library No.1-128)
EOX         11110111 F7 End Of Exclusive
    
```

5.13.2.11. Effect Library Bulk Dump Format

```

STATUS      11110000 F0 System Exclusive Message
ID No.      01000011 43 Manufacturer's ID No.(YAMAHA)
SUB STATUS  0000nnnn 0n n=0-15(MIDI Channel No.1-16)
FORMAT No.  01111110 7E Universal Bulk Dump
BYTE COUNT  00000001 01 142(132+10)bytes
(HIGH)
BYTE COUNT  00001110 0E
(LOW)
             01001100 4C 'L'
             01001101 4D 'M'
             00100000 20 ''
             00100000 20 ''
             00111000 38 '8'
             01000011 43 'C'
             00110111 37 '7'
             00110101 35 '5'
DATA NAME   01000101 45 'E'
             0mmmmmmmm mm m= 0-127 (Effect Library No.1-128)
             Receive is effective 42-128
DATA        0dyyyyyy ds Effect Library Memory(66*2bytes)
             : :
             0dyyyyyy de
CHECK SUM   0eeeeeee ee ee=(INVERT('L'+M'+...+ds+...+de)+1) AND
             7Fh
EOX         11110111 F7 End Of Exclusive
    
```

All data is divided into 4 bit units.

5.13.2.12. Effect Library Bulk Dump Request Format

```

STATUS      11110000 F0 System Exclusive Message
ID No.      01000011 43 Manufacturer's ID (YAMAHA)
SUB STATUS  0010nnnn 2n n=0-15(MIDI Channel No.1-16)
FORMAT No.  01111110 7E Universal Bulk Dump
            01001100 4C 'L'
            01001101 4D 'M'
            00100000 20 ''
            00100000 20 ''
            00111000 38 '8'
            01000011 43 'C'
            00110111 37 '7'
            00110101 35 '5'
DATA NAME   01000101 45 'E'
            0mmmmmmmm mm m= 0-127 (Effect Library No.1-128)
EOX         11110111 F7 End Of Exclusive

```

5.13.2.13. Channel Library Bulk Dump Format

```

STATUS      11110000 F0 System Exclusive Message
ID No.      01000011 43 Manufacturer's ID No.(YAMAHA)
SUB STATUS  0000nnnn 0n n=0-15(MIDI Channel No.1-16)
FORMAT No.  01111110 7E Universal Bulk Dump
BYTE COUNT (HIGH) 00000001 01 226(216+10)bytes
BYTE COUNT (LOW)  01100010 62
            01001100 4C 'L'
            01001101 4D 'M'
            00100000 20 ''
            00100000 20 ''
            00111000 38 '8'
            01000011 43 'C'
            00110111 37 '7'
            00110101 35 '5'
DATA NAME   01001000 48 'H'
            0mmmmmmmm mm m= 0-64 (Channel Library No.0-64)
            Receive is effective No.2-64
DATA        0dsdsdsds ds Effect Library Memory(108*2 bytes)
            : :
            0dsdsdsds ds
CHECK SUM   0eeeeeee ee ee=(INVERT('L'+M'+...+ds+...+de)+1) AND 7Fh
EOX         11110111 F7 End Of Exclusive

```

All data is divided into 4 bit units.

5.13.2.14. Channel Library Bulk Dump Request Format

```

STATUS      11110000 F0 System Exclusive Message
ID No.      01000011 43 Manufacturer's ID (YAMAHA)
SUB STATUS  0010nnnn 2n n=0-15(MIDI Channel No.1-16)
FORMAT No.  01111110 7E Universal Bulk Dump
            01001100 4C 'L'
            01001101 4D 'M'
            00100000 20 ''
            00100000 20 ''
            00111000 38 '8'
            01000011 43 'C'
            00110111 37 '7'
            00110101 35 '5'
DATA NAME   01001000 48 'H'
            0mmmmmmmm mm m= 0-64 (Channel Library No.0-64)
EOX         11110111 F7 End Of Exclusive

```

5.13.2.15. Program Change Table Bulk Dump Format

```

STATUS      11110000 F0 System Exclusive Message
ID No.      01000011 43 Manufacturer's ID No.(YAMAHA)
SUB STATUS  0000nnnn 0n n=0-15(MIDI Channel No.1-16)
FORMAT No.  01111110 7E Universal Bulk Dump
BYTE COUNT (HIGH) 00000001 01 138(128+10)bytes
BYTE COUNT (LOW)  00001010 0A
            01001100 4C 'L'
            01001101 4D 'M'
            00100000 20 ''
            00100000 20 ''
            00111000 38 '8'
            01000011 43 'C'
            00110111 37 '7'
            00110101 35 '5'
DATA NAME   01010000 50 'P'
            00100000 20 ''
DATA        0dsdsdsds ds Program Change Table(128bytes)
            : :
            0dsdsdsds ds
CHECK SUM   0eeeeeee ee ee=(INVERT('L'+M'+...+ds+...+de)+1) AND 7Fh
EOX         11110111 F7 End Of Exclusive

```

All data is divided into 7 bit units.

5.13.2.16. Program Change Table Bulk Dump Request Format

```

STATUS      11110000 F0 System Exclusive Message
ID No.      01000011 43 Manufacturer's ID (YAMAHA)
SUB STATUS  0010nnnn 2n n=0-15(MIDI Channel No.1-16)
FORMAT No.  01111110 7E Universal Bulk Dump
            01001100 4C 'L'
            01001101 4D 'M'
            00100000 20 ''
            00100000 20 ''
            00111000 38 '8'
            01000011 43 'C'
            00110111 37 '7'
            00110101 35 '5'
DATA NAME   01010000 50 'P'
            00100000 20 ''
EOX         11110111 F7 End Of Exclusive

```

MIDI Implementation Chart

Function...	Transmitted	Recognized	Remarks
Basic Channel	Default Changed	1-16 1-16	Memorized Memorized
Mode	Default Messages Altered	X X *****	OMNI off/OMNI on X X Memorized
Note Number	:True Voice	X *****	0-127 X
Velocity	Note On Note Off	X X	X X
After Touch	Key's Ch's	X X	X X
Pitch Bend		X	X
Control Change	0-95,102-119	0	0 Assignable
Prog Change	:True#	0-127 *****	0-127 0-96 Assignable
System Exclusive		0	0 *1
System Common	:Song Pos :Song Sel :Tune	0 X X	X X X *2
System Real Time	:Clock :Commands	0 0	X X *2 *2
Aux Messages	:Local ON/OFF :All Notes OFF :Active Sense :Reset	X X X X	X X 0 0
Notes	MTC quarter frame message is transmitted. MTC quarter frame message is recognized. (When MTC Sync mode) *1: Bulk Dump/Request, MMC *2: When MCLK Sync mode For MIDI remote, ALL messages canbe transmitted.		

Mode 1: OMNI ON, POLY
Mode 3: OMNI OFF, POLY

Mode 2: OMNI ON, MONO
Mode 4: OMNI OFF, MONO

0: Yes
X: No

Specifications

■ General Specifications

Frequency Response	0 +1/-3 dB, 20 Hz-20 kHz (MIC/LINE IN – STEREO OUT)
Total harmonic distortion (Nominal input/Output level) 20 kHz LPF	Less than 0.03% 1 kHz (LINE IN to STEREO OUT) Less than 0.2% 1 kHz (MIC IN to STEREO OUT)
Dynamic range (Maximum level to Noise level) IHF-A	109 dB typ. DA converter (STEREO OUT) 103 dB min. DA converter (STEREO OUT) 103 dB typ. AD + DA (LINE IN to STEREO OUT) 97 dB min. AD + DA (LINE IN to STEREO OUT)
AD converter	24-bit linear, 64-times oversampling
DA converter	24-bit linear, 128-times oversampling
Internal processing	32-bit
Sampling frequency	Internal 44.1 kHz (±6%) External 44.1 kHz (±6%)
Audio input section	
MIC/LINE	8 channels
DIGITAL IN	2 channels (optical stereo × 1)
Audio output section	
MONITOR OUT	2 channels (stereo × 1)
PHONES	2 channels (stereo × 1)
STEREO/AUX OUT	2 channels (stereo × 1)
DIGITAL OUT	2 channels (optical stereo × 1)
Mixer section	Total 36 channels
MIC/LINE INPUT	8 channels
Internal effect return	4 channels (stereo × 2)
Recorder monitor	16 channels
Quick loop sampler	8 channels (stereo × 4)
Internal effects section	
Multi-effects × 2	
Bus section	Total 8 buses
Bus	2 (L/R)
AUX	2 (1/2)
STEREO	2 (L/R)
Effect	2 (1/2)
Internal HDD	20 GB 2.5" IDE Maximum capacity per one song: 6.4 GB
Maximum songs	1,000 songs
Recorder resolution	16 bit linear (non-compressed)
Maximum tracks of recording/playback simultaneously	8 tracks, Recording & 16 tracks, playback

Number of tracks	144 tracks (16 tracks + stereo tracks) × 8 virtual
Fader	13 × 45 mm
MIDI	MTC (Master/Slave), MIDI Clock (Master), MMC (Master/Slave), Program Change, Control Change, Bulk Dump
Memory	Scene memory, EQ library, dynamics library, effect library, channel library, sample library
AC adaptor	PA-300
Power requirements	U.S.A. & Canada 110-120 V, 50/60 Hz Europe 220-240 V, 50/60 Hz
Dimensions (W × H × D)	425.0 × 98.8 × 321.5 mm (16.7 × 3.9 × 12.6 inches)
Weight	4.4 kg (9.7 lbs)
Operating temperature range	5° to 35° C
Options	Footswitch FC5, CD-RW Drive CDRW16G

■ Mixer section

● Input/output	
MIC/LINE input	channel 1, 2 (balanced, XLR-type) +48 V ±3 V DC phantom powering Input impedance 3 kΩ Nominal input level -46 dB to +4 dB Minimum input level -52 dB Maximum input level +18 dB
MIC/LINE input	channel 3-8 (balanced, TRS phone jack) Input impedance 3 kΩ Nominal input level -46 dB to +4 dB Minimum input level -52 dB Maximum input level +18 dB
MIC/LINE input (Hi-Z)	channel 8 (unbalanced, phone jack) Input impedance 500 kΩ Nominal input level -46 dB to +4 dB Minimum input level -52 dB Maximum input level +18 dB
STEREO/AUX OUT	L, R (unbalanced, phone jack) Output impedance 150Ω Nominal load impedance 10 kΩ Nominal output level -10 dBV Maximum output level +4 dBV
MONITOR OUT	L, R (unbalanced, TRS phone jack) Output impedance 150Ω Nominal load impedance 10 kΩ Nominal output level -10 dBV Maximum output level +4 dB

PHONES (unbalanced, TRS phone jack)
 Nominal load impedance 8–40Ω
 Maximum output level 100 mW + 100 mW
 (40 Ω load)

DIGITAL STEREO I/O Optical

* 0 dB= 0.775 Vrms, 0 dBV= 1.0 Vrms

● Digital mixer

Input channel (INPUT 1–8, TRACK 1–16, PAD 1–4)
 Attenuator, Phase (normal, reverse), EQ (4-band PEQ), Dynamics, On/Off, Pan

Internal effects return
 EQ (4-band PEQ), On/Off, Pan

Bus
 Stereo L, R Attenuator, EQ (4-band PEQ), Dynamics, On/Off, Balance
 Bus L, R
 Aux 1–2
 EFF 1–2

■ Recorder section

● Edit

Song edit Optimize, Delete, Copy, Import
 Track edit Erase, Delete, Insert, Copy, Move, Exchange, Time Compression/Expansion, Pitch Change, Export, CD import

● Others

Locate Quick locate: RTZ, A/B, Last REC In/Out
 Mark: 1–99

Punch I/O Manual Punch I/O, Auto Punch I/O

■ Quick loop sampler

POLYPHONY 4 voices (stereo)
 RECORDABLE TIME Total 44 seconds (stereo)

Edit function NAME, TRIM, PLAYBACK, MODE, ERASE, EXTRACT, CD IMPORT, TRACK IMPORT

■ Controls

ANALOG SECTION

INPUT [CH1-8] LINE/MIC VR
 INPUT [CH1-2] PHANTOM +48V SW ON/OFF
 OUTPUT LEVEL MONITOR/PHONES VR

MIXER SECTION

WORK NAVIGATE SONG/CD/TRACK/EDIT/UTILITY/REMOTE
 QUICK NAVIGATE RECORD/MONITOR
 CHANNEL SELECT INPUT1-8/TRACK 1-8/TRACK [9/10]-[15/16]/STEREO
 MIXER SCENE/VIEW/[PAN/BAL]/EFF1/EFF2
 EQ EQ/DYN/HIGH/HI-MID/LO-MID/LOW
 FADER TRACK 1-8/TRACK [9/10]-[15/16]/STEREO

SAMPLER SECTION

QUICK LOOP SAMPLER SELECT/PAD 1-4/EDIT

RECORDER SECTION

LOCATE ◀/▶/IN/OUT/A/B/RTZ/MARK/SET/CANCEL/AUTO PUNCH/REPEAT
 TRANSPORT REW/FF/STOP/PLAY/REC

COMMON SECTION

DATA ENTRY ▲/▼/◀/▶/ENTER
 UNDO/REDO
 SOUND CLIP
 JOG ON
 ENCODER DATA/JOG
 DISPLAYS 240 × 64 dot GRAPHIC LCD (contrast control pot.)

■ Control I/O

MIDI IN 5-pin DIN
 MIDI OUT/THRU 5-pin DIN
 Foot switch Phone jack

Dimensions

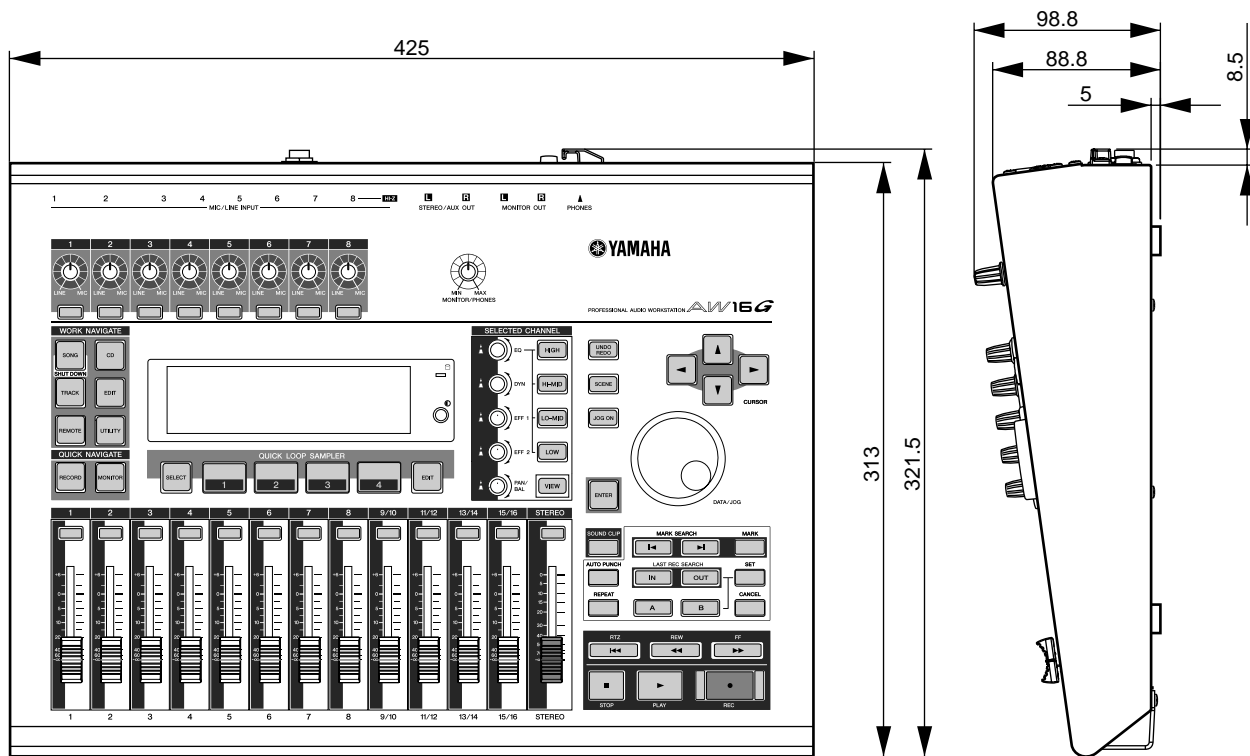

Unit: mm

Specifications and external appearance subject to change without notice.

For European Model

Purchaser/User Information specified in EN55103-1 and EN55103-2.

Inrush Current: 70A

Conformed Environment: E1, E2, E3 and E4

Index

A

- A/B key **20**
- A/B point **65**
- A-B Repeat **70**
- Access indicator **18, 22**
- Accessing a screen/page/channel **23**
- Adjusting the input level **34**
- AMP **72**
- Assigning input signals (Bus recording) **45**
- Assigning input signals (Direct recording) **42**
- ATT knob **160**
- audio CD **97**
 - Basic settings **99**
 - Disc At Once **98**
 - Erasing **105**
 - Finalizing **104**
 - Methods **98**
 - Playing **106**
 - Track At Once **98**
- AUDIO WRITE SPEED **99**
- AUTO PUNCH key **20**
- Auto punch-in/out **59**
 - rehearse **60**
- AVRG (Average) **150**

B

- Back up **145**
 - balance **57**
 - PAN/BALANCE knob **91**
- Basic operation **23**
 - Accessing a screen/page/channel **23**
 - Editing a value in the display **24**
 - Inputting text **24**
 - Switching a button on/off **24**
 - Using the Selected Channel section **25**
 - Viewing the display **23**
- Block diagram **218**
- bounce **81**
 - Convenient functions **89**
- bounce recording **87**
- BPM **120**
- buck up
 - Responsibility **9**
- Bulk dump **149, 154**
- Bus
 - terminology **16**
- Bus recording **41**

C

- CANCEL key **20**
- CD key **18**
- CD PLAY button **106**
- CD Play function **106**
- CD-R/RW drive
 - Cautions for handling **5**
 - Handling the media **4**
- CD-ROM included with the AW16G **200**
- CD-RW drive **10, 22**
 - Access indicator **22**
 - Basic settings **99**
 - Disc At Once **98**
 - Eject button **22**
 - Eject hole **22**
 - Handling **10**
 - Installing **10**
 - media **97**
 - Methods **98**
 - Removing **11**
 - Track At Once **98**
 - Using **11**
- CD-RW MEDIA ERASE **99**
- CH RECALL SAFE **80**
- Channel library **79**
 - Recall **79**
- Compander **175**
- COMPARE button **99**
- Compressor **174**
- Connect external devices **27**
- Connecting instrument or mic **33**
- Connecting the AC adaptor **12**
 - DC IN connector **22**
- control change **151**
- controlling a tone generator module **166**
- Copyright **9**
 - Notice **5**
- Counter **23**
 - COUNTER DISPLAY **139**
- COUNTER DISPLAY **139**
- Creating a new song **39**
- Current song **28**
- CURSOR key **20**

D

- D.OUT COPYRIGHT ON/OFF button **162**
- DATA WRITE SPEED **99**
- DATA/JOG dial **20**
- DC IN connector **22**

- demo song **28**
 - Loading **28**
 - Mixing **30**
 - Playing **29**
- DIGITAL IN jack
 - DIGITAL IN PATCH **160**
- DIGITAL IN PATCH **160**
- Digital input setting **160**
- DIGITAL REC ON/OFF button **160**
- DIGITAL STEREO IN/OUT jack **22**
- Dimensions **214**
- Direct recording **40**
- Disc At Once **98**
 - Writing **102**
- Display message list **198**
- Ducking **176**
- DYN button **53**
- DYN knob **19, 25**
- Dynamics **50**
- Dynamics library **53, 57, 78**
 - library list **177**
 - Recall **57, 78**
- Dynamics parameter **174**
- KEYIN SOURCE **93**

E

- Edit **92, 93, 94**
 - dynamics parameters **93**
 - EQ parameters **92**
 - parameters of an internal effect **94**
- Edit command
 - COPY **128**
 - DELETE **127**
 - ERASE **126**
 - EXCHANGE **130**
 - EXPORT **131**
 - INSERT **127**
 - MOVE **129**
 - PITCH CHANGE **131**
 - TIME COMP/EXP (Time Compression/Expansion) **130**
- EDIT key **18**
- Editing a value in the display **24**
- Editing command **123**
 - List **126**
- EFF 1 knob **19, 25**
- EFF 2 knob **19, 25**
- effect **96**
 - BYPASS **94**
 - USED AS **94**

- Effect library **78**
 - Effect Parameters **180**
 - library list **178**
 - Recall **78**
- Eject button **22**
- Eject hole **22**
- ENTER key **20**
- EQ **50**
- EQ button **52**
- EQ knob **19, 25**
- EQ library **52, 56, 77**
 - library list **173**
 - Recall **77**
- example of connections **27**
- Expander **175**
- Exporting WAV files and importing audio CD or WAV files **132**
- external devices **163**
 - external effects **167**
 - MD recorder **169**
 - tone generator module **166**
 - workstation synth **163**
- external effects **167**

F

- Fader **19**
- FADER FLIP **162**
- FADER RECALL SAFE **80**
- Features **13**
 - CD-RW drive **14**
 - Mixer section **13**
 - Quick Loop Sampler section **14**
 - Recorder section **14**
- FF key **21**
- Finalizing **98, 104**
- FOOT SW jack **22, 59**
- foot switch **59**
- FORMAT button **161**
- free space on the hard disk **141**
- Front panel **22**

G

- GAIN knob **18**
- Gate **176**
- Gate mode **108**
- Grounding terminal **22**

H

- HIGH key **19**
- HI-MID key **19**

I

IN/OUT key **20**
 In/out point **65**
 included items **9**
 Index **215**
 Initializing a channel **91**
 INPUT CH MUTE/MIX button **106**
 INPUT LEVEL knob **34**
 Input library **50, 77**
 library list **171**
 INPUT LIBRARY popup window **77**
 INPUT SEL key **18**
 INPUT SETTING popup window **34, 77**
 Inputting text **24**
 internal effect **50, 84**
 EFF **85**
 PRE/POST **85**

J

JOG ON key **20, 71**

L

LATCH button **158**
 LEARN button **158**
 Level meter **34, 90**
 PRE/POST buttons **90**
 library **73**
 Basic operation **74**
 Channel library **79**
 Delete **75**
 Details **77**
 Dynamics library **57, 78**
 Effect library **78**
 EQ library **56, 77**
 Input library **77**
 Mastering library **78**
 Naming **76**
 Recall **75**
 Sample library **78**
 Storing **74**
 terminology **16**
 LIBRARY button **50**
 LISTEN button **72**
 Loading a song **64**
 Locate points **68**
 locator **65**
 A/B point **65**
 Adjusting the position **68**
 Erasing **69**
 icon **66**
 In/out point **65**
 Locate points **68**
 LOCATOR button **68**
 Locator point/marker display area **68**
 marker **67**
 MARKER button **68**
 POSITION **68**
 Relative zero point **65**
 Start/end point **65**
 LOCATOR button **68**
 Locator point/marker display area **68**
 LO-MID key **19**
 Loop mode **108, 119**
 LOW key **19**

M

Manual punch-in/out **59**
 MARK key **20**
 MARK SEARCH key **20**
 marker **67**
 Adjusting the position **68**
 Erasing **69**
 icon **67**
 List **68**
 Locate points **68**
 LOCATOR button **68**
 Locator point/marker display area **68**
 MARKER **68**
 MARKER button **68**
 MEAS **69**
 POSITION **68**
 MARKER button **68**
 Mastering library **78**
 library list **172**
 Recall **78**
 MASTERING LIBRARY popup window **78**
 MD recorder **169**
 MEAS **68**
 media **97**
 Erasing **105**
 message list **198**
 metronome **47**
 Metronome button **36, 47**
 Metronome knob **36**
 MIC/LINE INPUT jack **21, 33**
 MIC/LINE INPUT jack (Hi-Z) **21, 33**
 MIDI **149**
 Basic **150**
 Bulk dump **154**
 CTRL CHG MODE **151**
 DEV (device number) **150**
 MIDI CH **151**
 MIDI data format **204**
 MIDI OUT **150**
 MIDI Remote **155**
 MMC MODE **150**
 MTC MODE **150**
 PGM CHG MODE **151**
 settings **150**
 MIDI data format **204**
 MIDI IN connector **22**
 MIDI OUT/THRU connector **22**

MIDI Remote **149, 155**
 user-defined Remote function **157**
 mix balance **57**
 mixdown **81**
 check the level **90**
 Convenient functions **89**
 Preparing **83**
 Recording **86**
 Viewing all parameters **90**
 MMC device number **150**
 MMC MODE **150**
 MONITOR key **18**
 MONITOR OUT jack **21**
 MONITOR TEMPO **120**
 MONITOR/PHONES knob **18**
 MOTOR ON ACCESS/DISC IN button **99**
 MTC MODE **150**
 AVRG (Average) **150**
 OFST (Offset) **151**

N

Nudge function **71**
 NUDGE MODE **71, 162**
 NUDGE TIME **71, 162**

O

OFST (Offset) **151**
 One shot mode **108, 119**
 OPTIMZ button **141**
 Overall setting **162**
 Overdubbing **55, 58**
 Assigning the input signal **56**
 Auto punch-in/out **59**
 Manual punch-in/out **59**
 Virtual track **62**

P

pad **107, 112**
 playback mode **119**
 PAD SEL key **18**
 Pad track **108**
 terminology **16**
 Pads 1-4 **18**
 Pair **49, 83**
 Paired channels terminology **16**
 Pan **57, 83**
 PAN/BAL knob **19, 25**
 PARAM DISP TIME **162**
 PERFECTLY button **105**
 PHANTOM +48V switch **22**
 PHASE **83**
 PHONES jack **21**

ping-pong recording **81, 87**
 PLAY key **21**
 playback **65**
 A-B Repeat **70**
 popup window
 INPUT LIBRARY popup window **77**
 INPUT SETTING popup window **77**
 POSITION **68**
 POSTROLL TIME **162**
 POWER switch **22**
 PRECAUTIONS **3**
 PREROLL TIME **162**
 program change **151**
 PROTECT button **139**
 Punch-in/out **59**

Q

Quick loop sampler **14, 107**
 an audio CD **112**
 Delete **122**
 Editing the sample name **117**
 Gate **119**
 Gate mode **108**
 Importing **112**
 Importing from an audio track/stereo track **114**
 Loop mode **108, 119**
 One shot mode **108, 119**
 Pad Track **108**
 Slice function **120**
 Switching the playback mode **119**
 Trigger **119**
 Trigger mode **108**
 WAV file **112**

R

Rear panel **21**
 REC key **21**
 RECALL CONFIRM ON/OFF button **162**
 Recall Safe **80**
 RECORD key **18**
 Recording on a track **48**
 Recording/playing a sound clip **35**
 Relative zero point **65**
 REMOTE key **18**
 REPEAT key **20**
 Responsibility for loss of data **4, 9**
 REW key **21**
 RTZ key **21**

S

Sample bank **107**
Sample bank and sample terminology **16**
SAMPLE EDIT key **18**
Sample library **78, 109**
 Back up **145**
 library list **192**
 Recall **79**
 Restoring **147**
Sampling **115**
 Editing the sample name **117**
 Trimming **118**
Sampling an external input signal **115**
Saving the current song **63**
scene
 Naming **76**
 PROTECT button **79**
 Recall Safe function **80**
SCENE key **20**
scene memory **73, 79**
 About **73**
 Basic operation **74**
 Details **77**
 Recall **79**
 Storing **74**
 terminology **16**
Selected channel **23**
Selected Channel section **25**
SET key **20**
shut down **12**
SHUTDOWN page **12**
SIMPLY button **105**
SLICE **120**
Slice function **120**
Song **137**
 AW2816 **148**
 AW4416 **148**
 Back up **145**
 Copy **140**
 Delete **140**
 Editing settings **139**
 Editing the song name **138**
 Importing data **144**
 management **137**
 Optimizing **141**
 Restoring **147**
 tempo map **142**
 terminology **16**
song
 Loading **64**
 Saving **63**
SONG key **18**
SORT field **28**
Sound Clip **14**
Sound clip **33**
 Recording/playing **35**
SOUND CLIP key **20**
SOUND CLIP TIME **162**

Specifications **212**
Start/end point **65**
Stereo bus assign switch **34**
STEREO fader **19**
STEREO SEL key **19**
STEREO/AUX OUT jack **21**
STOP key **21**
STORE CONFIRM ON/OFF button **162**
Switching a button on/off **24**
System data terminology **16**

T

Tempo map
 Tempo map event **47**
 terminology **16**
Tempo map event **47, 142**
terminology **15**
 Bus **16**
 Channel **15**
 Library **16**
 Locate point/marker **15**
 Pad track **16**
 Paired channels **16**
 Paired tracks **15**
 Sample bank and sample **16**
 Scene and scene memory **16**
 Song **16**
 System data **16**
 Tempo map **16**
 Tracks **15**
TEST button **99**
test tone **159**
Text input box **24**
Text palette **24**
TIME **72**
TIME CODE BASE **139**
tone generator module **166**
Top panel **17**
 Data entry/control section **20**
 Display **18**
 Input/output section **18**
 Locate section **20**
 Mixer section **19**
 Quick Loop Sampler section **18**
 Selected Channel section **19**
 Transport section **21**
 Work Navigate section **18**
Track At Once **98**
 Writing **100**
Track editing **123**
 Basic procedure **124**
TRACK field **48**

TRACK key **18**
Track recording **39**
 Bus recording **41**
 Creating a new song **39**
 Direct recording **40**
 NAME button **48**
 Pairing **49**
 TRACK field **48**
 Track name **48**
 Track view **48**
 V.TR field **48**
 WAVE button **48**
TRACK SEL key **19**
Trigger mode **108**
Troubleshooting **194**
Turning the power on/off **12**
 POWER switch **22**

U

UNDERRUN PROTECT button **99**
Undo function **61**
Undo List **61**
UNDO LIST popup window **61**
UNDO/REDO key **20**
UNLATCH button **158**
utility functions **149**
 Checking **160**
 D.OUT COPYRIGHT ON/OFF button **162**
 Digital input settings **160**
 FADER FLIP **162**
 initializing the internal hard disk **160**
 internal hard disk **160**
 NUDGE MODE **162**
 NUDGE TIME **162**
 PARAM DISP TIME **162**
 POSTROLL TIME **162**
 PREROLL TIME **162**
 RECALL CONFIRM ON/OFF button **162**
 SOUND CLIP TIME **162**
 STORE CONFIRM ON/OFF button **162**
 test tone **159**
UTILITY key **18**

V

VARI PITCH knob **160**
VARI PITCH ON/OFF button **160**
VIEW key **19**
Viewing the display **23**
Virtual track **62**
 Switching **62**
 terminology **15**

W

WAVE button **48**
WAVE DISPLAY popup window **72**
waveform **72**
website **9**
workstation synth **163**
WRITE button **99**

Block diagram

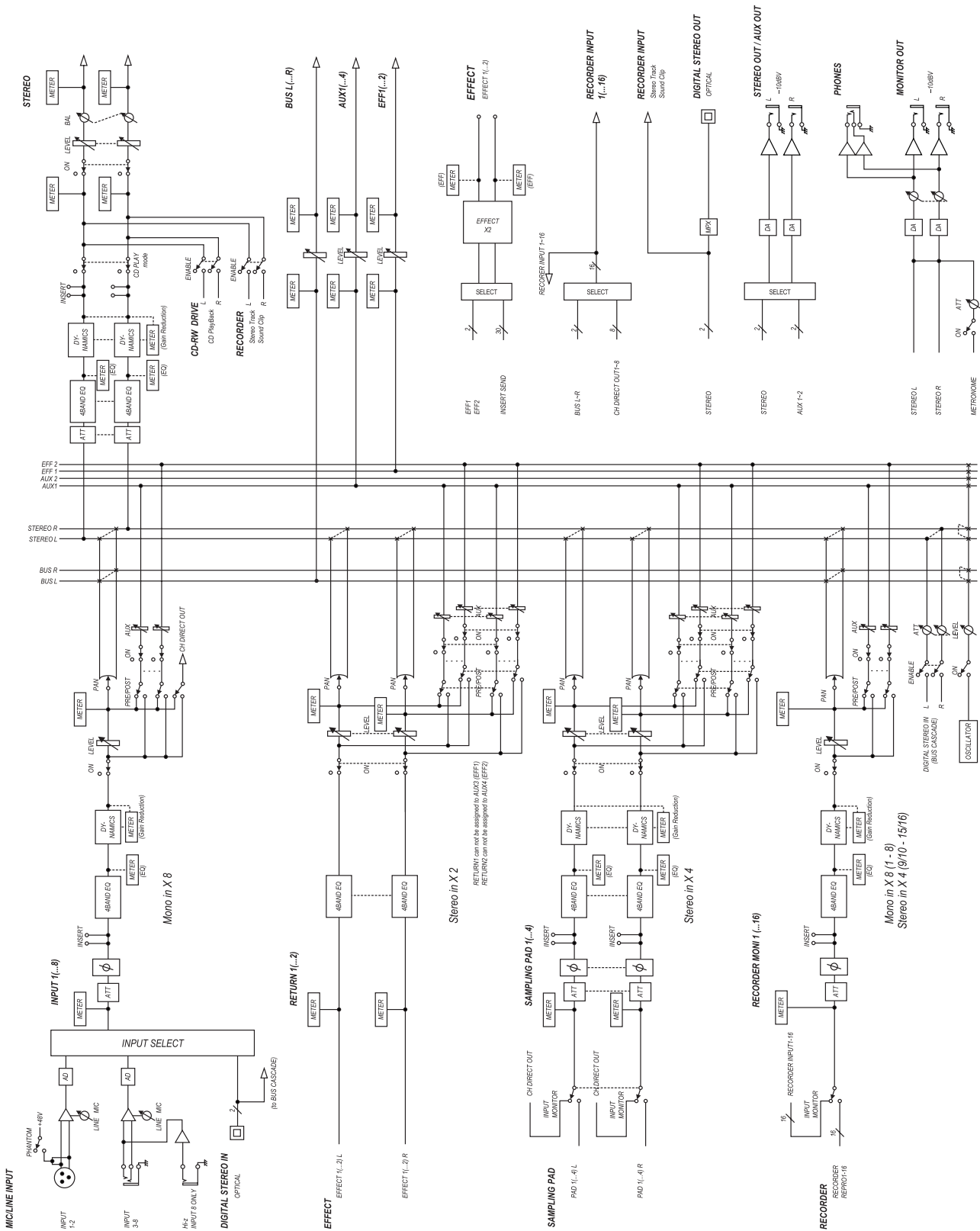



Free Manuals Download Website

<http://myh66.com>

<http://usermanuals.us>

<http://www.somanuals.com>

<http://www.4manuals.cc>

<http://www.manual-lib.com>

<http://www.404manual.com>

<http://www.luxmanual.com>

<http://aubethermostatmanual.com>

Golf course search by state

<http://golfingnear.com>

Email search by domain

<http://emailbydomain.com>

Auto manuals search

<http://auto.somanuals.com>

TV manuals search

<http://tv.somanuals.com>