

YAMAHA
Clavinova®

CLP-154S
CLP-155

Owner's Manual
Bedienungsanleitung
Mode d'emploi
Manual de instrucciones

SPECIAL MESSAGE SECTION

PRODUCT SAFETY MARKINGS: Yamaha electronic products may have either labels similar to the graphics shown below or molded/stamped facsimiles of these graphics on the enclosure. The explanation of these graphics appears on this page. Please observe all cautions indicated on this page and those indicated in the safety instruction section.

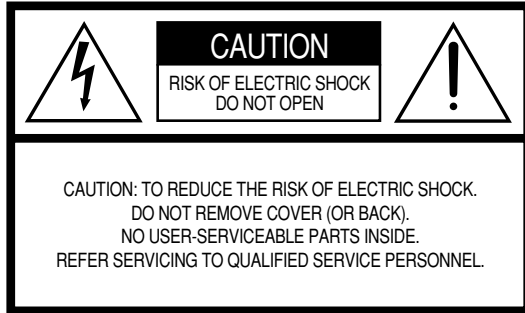

See bottom of Keyboard enclosure for graphic symbol markings



The exclamation point within the equilateral triangle is intended to alert the user to the presence of important operating and maintenance (servicing) instructions in the literature accompanying the product.

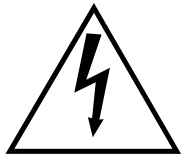

The lightning flash with arrowhead symbol, within the equilateral triangle, is intended to alert the user to the presence of uninsulated "dangerous voltage" within the product's enclosure that may be of sufficient magnitude to constitute a risk of electrical shock.

IMPORTANT NOTICE: All Yamaha electronic products are tested and approved by an independent safety testing laboratory in order that you may be sure that when it is properly installed and used in its normal and customary manner, all foreseeable risks have been eliminated. **DO NOT** modify this unit or commission others to do so unless specifically authorized by Yamaha. Product performance and/or safety standards may be diminished. Claims filed under the expressed warranty may be denied if the unit is/has been modified. Implied warranties may also be affected.

SPECIFICATIONS SUBJECT TO CHANGE: The information contained in this manual is believed to be correct at the time of printing. However, Yamaha reserves the right to change or modify any of the specifications without notice or obligation to update existing units.

ENVIRONMENTAL ISSUES: Yamaha strives to produce products that are both user safe and environmentally friendly. We sincerely believe that our products and the production methods used to produce them, meet these goals. In keeping with both the letter and the spirit of the law, we want you to be aware of the following:

Battery Notice: This product MAY contain a small non-rechargeable battery which (if applicable) is soldered in place. The average life span of this type of battery is approximately five years. When replacement becomes necessary, contact a qualified service representative to perform the replacement.

Warning: Do not attempt to recharge, disassemble, or incinerate this type of battery. Keep all batteries away from children. Dispose of used batteries promptly and as regulated by applicable laws. Note: In some areas, the servicer is required by law to return the defective parts. However, you do have the option of having the servicer dispose of these parts for you.

Disposal Notice: Should this product become damaged beyond repair, or for some reason its useful life is considered to be at an end, please observe all local, state, and federal regulations that relate to the disposal of products that contain lead, batteries, plastics, etc.

NOTICE: Service charges incurred due to lack of knowledge relating to how a function or effect works (when the unit is operating as designed) are not covered by the manufacturer's warranty, and are therefore the owners responsibility. Please study this manual carefully and consult your dealer before requesting service.

NAME PLATE LOCATION: The graphic below indicates the location of the name plate. The model number, serial number, power requirements, etc., are located on this plate. You should record the model number, serial number, and the date of purchase in the spaces provided below and retain this manual as a permanent record of your purchase.

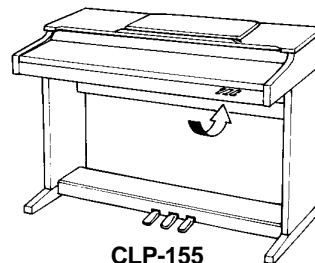

CLP-155

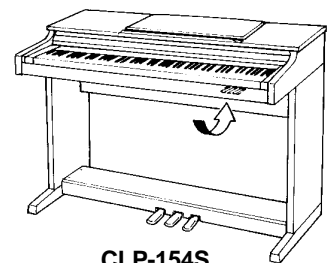

CLP-154S

Model _____

Serial No. _____

Purchase Date _____

Introduction

Thank you for choosing a Yamaha CLP-154S/155 Clavinova. Your Clavinova is a fine musical instrument that employs advanced Yamaha music technology. With the proper care, your Clavinova will give you many years of musical pleasure.

- Yamaha's AWM (Advanced Wave Memory) tone generator system offers rich, realistic voices. The CLP-155 additionally features stereo sampling of its PIANO 1 voice for unmatched realism and expressive power.
- Piano-like touch response — adjustable in 4 stages — provides extensive expressive control and outstanding playability.
- Dual play mode allows 2 voices to be played simultaneously.
- Unique Clavinova Tone voice provides a fresh sound for new musical expression.
- Damper pedal includes natural resonance effect for the piano voices, simulates the string and soundboard resonance of acoustic pianos.
- Metronome feature with variable tempo facilitates practice.
- 2-track digital recorder lets you record and play back anything you play on the keyboard (up to approximately 4,200 notes).
- MIDI compatibility and a range of MIDI functions make the Clavinova useful in a range of advanced MIDI music systems.

In order to make the most of your Clavinova's performance potential and features, we urge you to read this Owner's Manual thoroughly, and keep it in a safe place for later reference.

Taking Care Of Your Clavinova

Your Clavinova is a fine musical instrument, and deserves the most careful treatment. Observe the following points and your Clavinova will sound and look great for many years.

- 1** Never open the case and touch or tamper with the internal circuitry.
- 2** Always turn the POWER switch OFF after use, and close the key cover to protect the keyboard, or cover the keyboard with the dust cover provided.
- 3** Clean the cabinet and keys of your Clavinova only with a clean, slightly damp cloth. A neutral cleanser may be used if desired. Never use abrasive cleansers, waxes, solvents or chemical dust cloths since these can dull or damage the finish.
- 4** Never place any vinyl products on your Clavinova. Contact with vinyl can cause irreversible damage to the finish.
- 5** Install your Clavinova in a place that is away from direct sunlight, excessive humidity or heat.
- 6** Never apply excessive force to the controls, connectors or other parts of your Clavinova, and avoid scratching or bumping it with hard objects.

- **Name Plate Location**

The CLP-154S/155 name plate is located on the bottom panel.

Contents

| | | | |
|--|----|--|------|
| The Control Panel | 2 | Using the Recorder | 13 |
| Connections | 4 | ■ Recording | 13 |
| Selecting & Playing Voices | 5 | ● Changing the Initial Settings | 14 |
| ■ Playing the Demonstration Tunes | 6 | ● Erasing a Single Track | 14 |
| The Dual Mode | 7 | ■ Playback | 14 |
| ● Adjusting the Balance Between the Dual-mode Voices | 7 | ● Fast Forward Playback | 14 |
| ● Shifting a Dual-Mode Voice Up One Octave | 7 | MIDI Functions | 15 |
| ● Slow-attack Strings (CLP-155 only) | 7 | ● A Brief Introduction to MIDI | 15 |
| ● Memorizing the Balance, Strings Type (CLP-155), & Octave Shift Settings | 7 | ● MIDI "Messages" Transmitted & Received by the Clavinova | 15 |
| Reverb | 8 | ● MIDI Transmit & Receive Channel Selection | 16 |
| ● Adjusting Reverb Depth | 8 | ● MIDI Transmit Transpose | 16 |
| ● Memorizing the Reverb Type & Depth Settings | 8 | ■ Other MIDI Functions | 17 |
| Brilliance (CLP-155) | 9 | ● Local Control ON/OFF | 17 |
| ● Memorizing the Brilliance Setting | 9 | ● Program Change ON/OFF | 17 |
| The Pedals | 9 | ● Control Change ON/OFF | 18 |
| ● Soft (Left) Pedal | 9 | ● The Multi-Timbre Mode | 18 |
| ● Sostenuto (Center) Pedal | 9 | ● The MIDI Split & Left Local OFF Mode | 19 |
| ● Damper (Right) Pedal | 9 | ● The MIDI Split & Right Local Off Mode | 19 |
| Touch Sensitivity | 10 | ● Transmitting the Panel Settings (CLP-155 only) .. | 20 |
| ● Memorizing the Touch Sensitivity Setting | 10 | ● Bulk Data Dump | 20 |
| Transposition | 10 | Factory Preset Recall | 21 |
| Pitch Control | 11 | Troubleshooting | 21 |
| ● Tuning Up | 11 | Options & Expander Modules | 21 |
| ● Tuning Down | 11 | | |
| ● To Restore Standard Pitch | 11 | | |
| ● Memorizing the Pitch Control Setting | 11 | | |
| The Metronome & Tempo Control | 12 | | |
| ■ The Metronome | 12 | Keyboard Stand Assembly | i |
| ● Metronome Volume | 12 | MIDI Data Format | vii |
| ● Metronome Time Signature | 12 | Specifications | viii |
| ■ Tempo Control | 12 | MIDI Implementation Chart | ix |



The Control Panel

CLP-154S

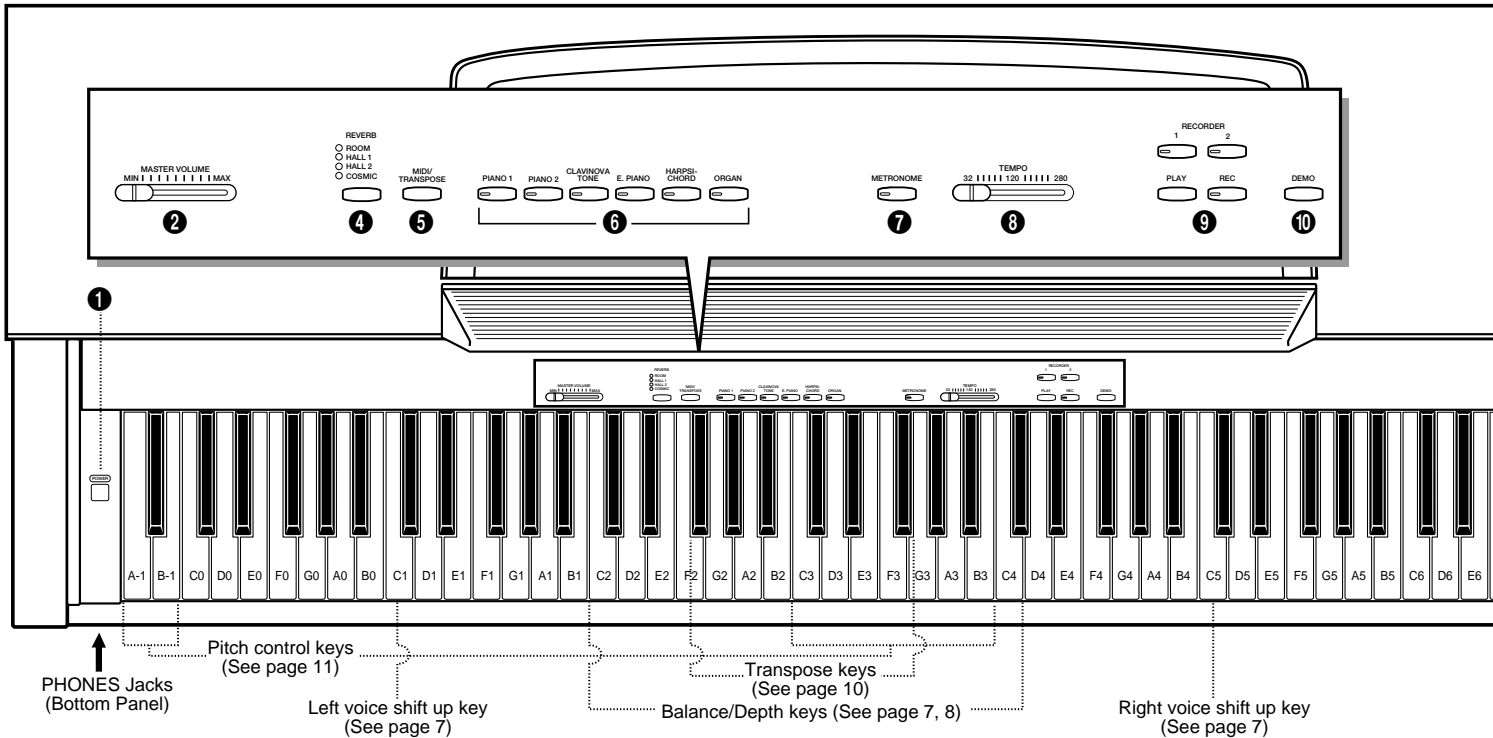

CLP-155

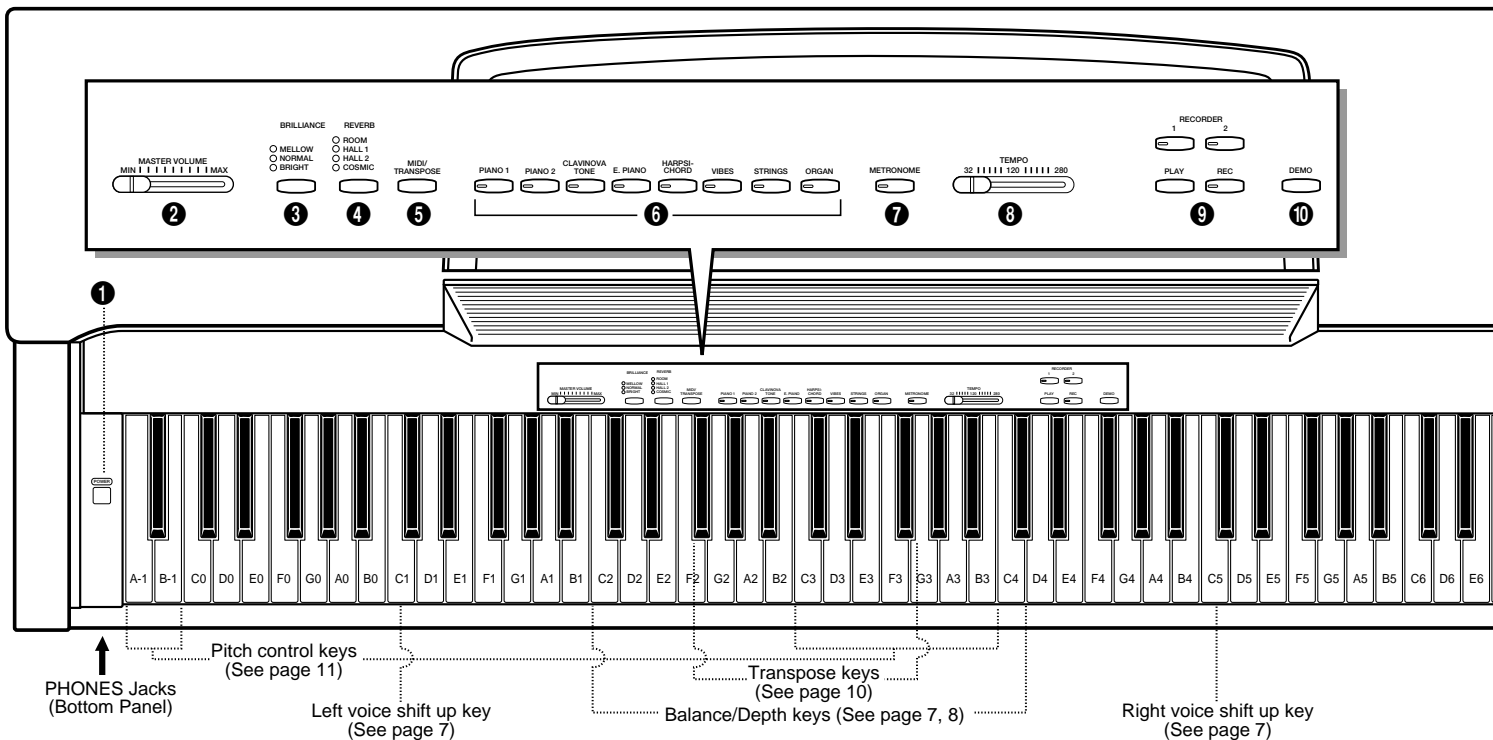

● The Music Stand

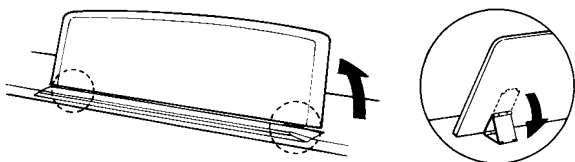

If you will be using sheet music with your Clavinova, raise the music stand built into its top panel by lifting the rear edge of the music stand, then flip down the music stand braces and engage them with the corresponding recesses.

The music stand can be lowered after slightly lifting it and folding the two brackets which support it against the back of the stand.

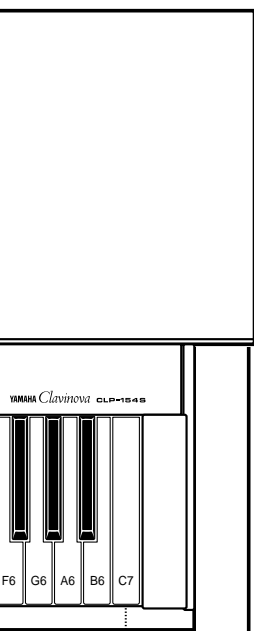

Memory key
(See page 7, 8, 10, 11)

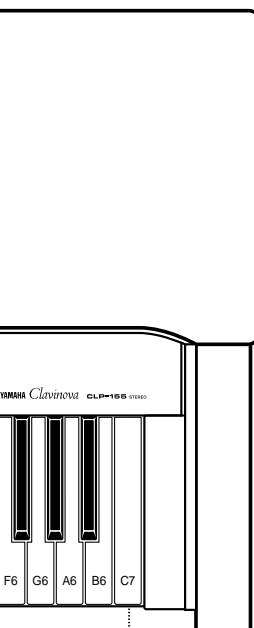

Memory key
(See page 7, 8, 10, 11)

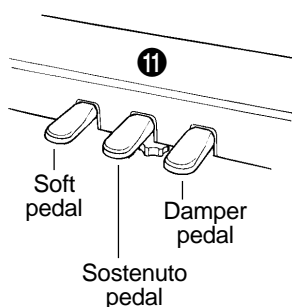

1 [POWER] Switch

Press the [POWER] switch once to turn the power ON, a second time to turn the power OFF. When the power is initially turned ON, the [PIANO 1] voice selector LED will light, and the power indicator located below the left end of the keyboard will light.

2 [MASTER VOLUME] Control

The [MASTER VOLUME] control adjusts the volume (level) of sound produced by the Clavinova's internal stereo sound system. The [MASTER VOLUME] control also adjusts headphone volume when a pair of headphones is plugged into the PHONES jack (page 4).

3 [BRILLIANCE] Button (CLP-155 only)

This button can be used to change the tonality or "timbre" of the selected voice. See page 9 for details.

4 [REVERB] Button

The [REVERB] button selects a number of digital reverb effects that you can use for extra depth and expressive power. See page 8 for details.

5 [MIDI/TRANPOSE] Button

The [MIDI/TRANPOSE] button allows access to the Clavinova's TRANSPOSE function (to shift the pitch of the entire keyboard up or down), keyboard touch sensitivity adjustment, and MIDI functions. For details refer to "TRANSPOSITION" on page 10, "TOUCH SENSITIVITY" on page 10, and "MIDI FUNCTIONS" on page 15.

6 Voice Selectors

The CLP-154S has six voice selectors and the CLP-155 has eight. Simply press any of the voice selectors to select the corresponding voice. The voice selector LED will light to indicate which voice is currently selected. The CLP-154S/155 also has a DUAL mode in which two voices can be played simultaneously across the full range of the keyboard — see page 7 for details.



NOTE

• The PIANO 1 voice is automatically selected whenever the [POWER] switch is initially turned ON.

7 [METRONOME] Button

Turns the metronome sound on and off. The [TEMPO] control, below, is used to set the tempo of the metronome sound. More precise tempo settings can be achieved by using the [METRONOME] button and the CLP-154S/155 keyboard as described on page 12.

8 [TEMPO] Control

This control adjusts the tempo of the CLP-154S/155 metronome function as well as the playback tempo of the recorder function. The tempo range is from 32 to 280 quarter-note beats per minute.

9 RECORDER [PLAY] and [REC] Buttons

These buttons control the CLP-154S/155 2-track recorder, letting you record and play back just about anything you play on the keyboard — up to a maximum of about 4,200 notes. See page 13 for details.

10 [DEMO] Button

Activates the demo playback mode in which you can select playback of different demonstration sequences for each of the Clavinova's voices. See page 6 for details.

11 Pedals

The CLP-154S/155's soft (left), sostenuto (center) and damper (right) pedals provide a range of expressive control capabilities similar to the pedal functions on an acoustic piano. See page 9 for details.

Connections

CLP-154S

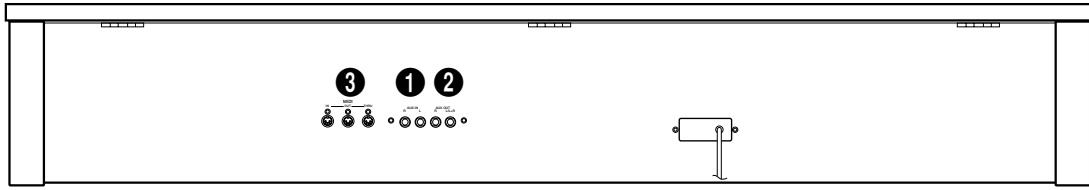

CLP-155

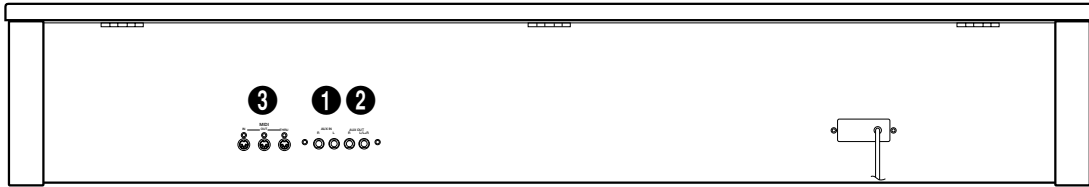

1 AUX IN L and R Jacks

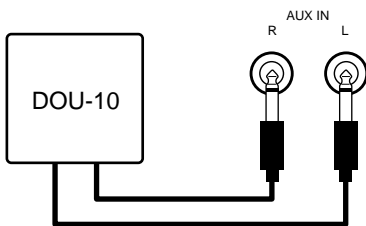

These jacks are intended for use with an external tone generator module such as the Yamaha DOU-10 Disk Orchestra Unit. The stereo outputs from the external tone generator module are connected to the AUX IN L and R jacks, allowing the sound of the tone generator to be reproduced via the Clavinova's internal sound system and speakers.



• The input signal from the AUX IN jacks is delivered to the AUX OUT jacks, but is not affected by the Clavinova's volume control or reverb effect.

2 AUX OUT L/L+R and R Jacks

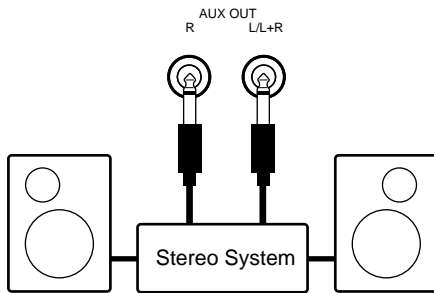

The AUX OUT L/L+R and R jacks deliver the output of the Clavinova for connection to an instrument amplifier, mixing console, PA system, or recording equipment. If you will be connecting the Clavinova to a monaural sound system, use only the L/L+R jack. When a plug is inserted into the L/L+R jack only, the left and right-channel signals are combined and delivered via the L/L+R jack so you don't lose any of the Clavinova's sound.

The Internal Amplifier & Speaker System

The CLP-154S and CLP-155 feature high-performance stereo amplifiers delivering 20 and 30 watts per channel, respectively. The CLP-155 features a bass-reflex type enclosure with two 13-cm and two 5-cm speakers, while the CLP-154S houses a pair of 13-cm speaker units in a sealed enclosure.



• The AUX OUT jack signal must never be returned to the AUX IN jacks, either directly or through external equipment.

3 MIDI IN, THRU and OUT Connectors

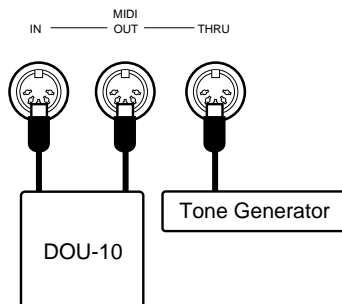

The MIDI IN connector receives MIDI data from an external MIDI device (such as the DOU-10 Disk Orchestra Unit) which can be used to control the Clavinova. The MIDI THRU connector re-transmits any data received at the MIDI IN connector, allowing "chaining" of several MIDI instruments or other devices. The MIDI OUT connector transmits MIDI data generated by the Clavinova (e.g. note and velocity data produced by playing the Clavinova keyboard).

More details on MIDI are given in "MIDI FUNCTIONS" on page 15.

PHONES Jacks (Bottom Panel)

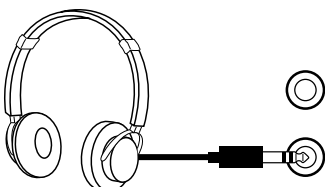

Two pairs of standard pair of stereo headphones can be plugged in here for private practice or late-night playing. The internal speaker system is automatically shut off when a pair of headphones is plugged into either of the PHONES jacks.



Selecting & Playing Voices

1 Turn Power On

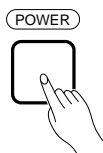

After making sure that the Clavinova's AC plug is properly inserted into a convenient AC wall outlet, press the **[POWER]** switch located to the left of the keyboard to turn the power ON.

When the power is turned ON, the **[PIANO 1]** voice selector LED will light (the PIANO 1 voice is automatically selected whenever the power is turned ON).

2 Set the Volume

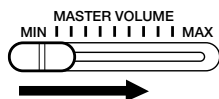

Initially set the **[MASTER VOLUME]** control about half way between the "MIN" and "MAX" settings. Then, when you start playing, re-adjust the **[MASTER VOLUME]** control for the most comfortable listening level.

3 Select a Voice

Select the desired voice by pressing one of the voice selectors.

CLP-154S

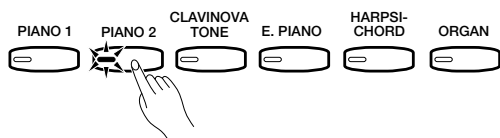

CLP-155

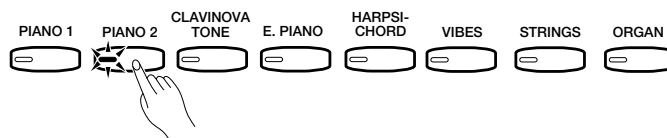

4 Play

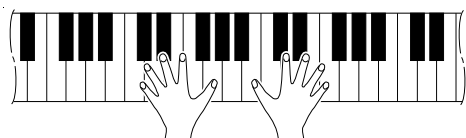

The Clavinova also offers keyboard touch response, so the volume and timbre of notes played can be controlled according to how "hard" you play the keys. The amount of variation available depends on the selected voice.

5 Adjust Tone & Add Effects As Required

CLP-154S

- REVERB
- ROOM
- HALL 1
- HALL 2
- COSMIC



CLP-155

- BRILLIANCE
- MELLOW
- NORMAL
- BRIGHT
- REVERB
- ROOM
- HALL 1
- HALL 2
- COSMIC



You can also change the overall tone or add reverb and/or effects as desired by using the **[REVERB]** button, and the **[BRILLIANCE]** button on the CLP-155 (see page 9 for **[BRILLIANCE]** button operation, "Reverb" on page 8).

Selecting & Playing Voices

Playing the Demonstration Tunes

The CLP-154S features 6 demonstration tunes and the CLP-155 has 8 demo tunes that effectively demonstrate their sound capabilities. Here's how you can select and play the demo tunes.

1 Engage the Demo Mode

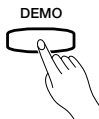

Press the [DEMO] button to engage the demo mode — the voice selectors will flash in sequence.

2 Select a Demo Tune

Press one of the flashing voice selectors to start playback of the corresponding demo tune — featuring the voice normally selected by that voice selector button. The demo tunes will play in sequence until stopped, starting with the selected tune. The voice selector indicator will flash during demo playback.

CLP-154S

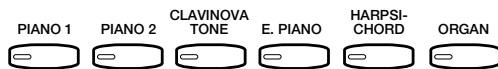

CLP-155

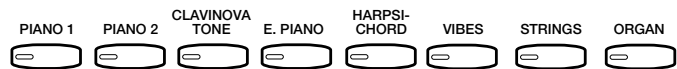

3 Set the Volume

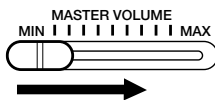

Use the [MASTER VOLUME] control to adjust the volume.



• The [TEMPO] control does not affect demo playback.

4 Play a Different Demo

You can start playback of any other demo tune during playback by simply pressing the corresponding voice selector. Playback will stop and the playback-ready mode described in step 2, above, will be re-engaged if you press the voice selector of the demo that is currently playing.

5 Stop the Demo



Press the [DEMO] button when you want to stop demo playback and return to the normal play mode.

The Demo Tunes

CLP-154S

- [PIANO 1] button: Etude op. 10-5 "Black Keys" by F. F. Chopin
- [PIANO 2] button: "Le Rhône" by K. Hattori
- [CLAVINOVA TONE] button: "Pavane pour une infante défunte" by M. J. Ravel
- [HARPSICHORD] button: "Le Coucou" by L. C. Daquin
- [ORGAN] button: "Jesu, Joy Of Man's Desiring" (Chorale from Cantata No. 147) by J. S. Bach

• The demonstration pieces listed above are short excerpts from the original compositions. The other demo song is original (© 1994 by YAMAHA CORPORATION).

CLP-155

- [PIANO 1] button: Etude op. 10-5 "Black Keys" by F. F. Chopin
- [PIANO 2] button: "Le Rhône" by K. Hattori
- [CLAVINOVA TONE] button: "Pavane pour une infante défunte" by M. J. Ravel
- [HARPSICHORD] button: "Le Coucou" by L. C. Daquin
- [VIBES] button: "Schmetterling (Papillons)" op. 43 by E. H. Grieg
- [STRINGS] button: "Charmaine" by L. Pollack
- [ORGAN] button: "Jesu, Joy Of Man's Desiring" (Chorale from Cantata No. 147) by J. S. Bach

• The demonstration pieces listed above are short excerpts from the original compositions. The other demo song is original (© 1994 by YAMAHA CORPORATION).



The Dual Mode

The DUAL mode makes it possible to play two voices simultaneously across the entire range of the keyboard. To activate the DUAL mode simply press two voice selectors at the same time (or press one voice selector while holding another). The voice indicators of both selected voices will light when the DUAL mode is active. To return to the normal single-voice play mode, press any single voice selector.

● Adjusting the Balance Between the Dual-mode Voices

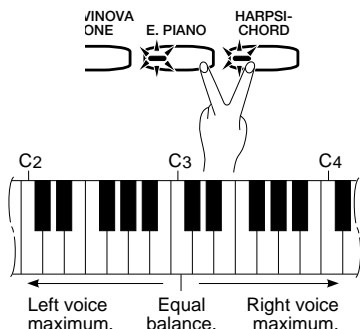

The volume levels of the two voices combined in the DUAL mode are normally set automatically to produce a pleasing balance (see “Default Settings” below). The balance can be adjusted manually by using the **C2** through **C4** keys on the keyboard while pressing the two voice selectors corresponding to the voices to be combined in the DUAL mode.

The **C3** key produces equal (50:50) balance between the two voices, while keys to the left of **C3** increase the volume of the left voice in relation to the right voice, and keys to the right of **C3** increase the volume of the right voice in relation to the left voice. By “left” and “right” voice we refer to the relative positions of the voice selectors — i.e. in a PIANO 2/CLAVINOVA TONE combination PIANO 2 is the left voice and CLAVINOVA TONE is the right voice.

● Shifting a Dual-Mode Voice Up One Octave

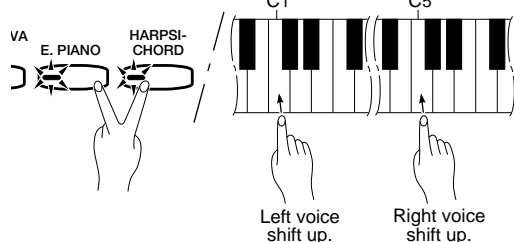

Depending on which voices you combine using the DUAL mode, the combination may sound better if one of the voices is shifted up an octave. To shift the right voice, press the **C5** key while pressing the two voice selectors corresponding to the voices to be combined in the DUAL mode. Press **C5** again to shift the voice back to its normal range. Use the **C1** key in the same way to shift the left voice.

Default octave settings are provided for all voice combinations, as listed in the “Default Settings” chart, below.

● Slow-attack Strings (CLP-155 only)

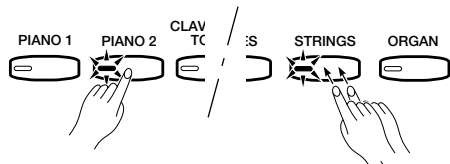

In a DUAL mode voice combination using STRINGS and any other voice, it is possible to switch the STRINGS voice to a slow-attack variation when initially selecting the voices by pressing the [**STRINGS**] selector twice while holding the other voice selector. Repeat this operation to return to the normal STRINGS voice attack.

● Memorizing the Balance, Strings Type (CLP-155), & Octave Shift Settings

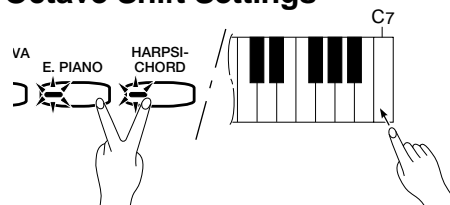

Press the **C7** key while holding any two voice selectors to memorize all balance, STRINGS voice attack variation (CLP-155), and octave shift settings made since the power was turned on. The memorized settings will be retained in memory for about one week after the power is turned off, then the default settings will be restored. To keep the memorized settings for longer periods, turn the power on briefly at least once a week.

If these settings are not memorized as described above, they are retained in memory only until the Clavinova is turned off.

Default Settings

| | | Balance | | | | | | | | |
|--------------|-------------------|---------|---------|----------------|----------|-------------|-----------------|-------------------|----------------------------|----|
| | | PIANO 1 | PIANO 2 | CLAVINOVA TONE | E. PIANO | HARPSICHORD | VIBES (CLP-155) | STRINGS (CLP-155) | ORGAN (CLP-154S) (CLP-155) | |
| Octave Shift | PIANO 1 | | C3 | C3 | C3 | C3 | C3 | F2 | F2 | E2 |
| | PIANO 2 | 0 | | C3 | C3 | C3 | C3 | F2 | F2 | E2 |
| | CLAVINOVA TONE | 0 | 0 | | C3 | C3 | C3 | F2 | F2 | F2 |
| | E. PIANO | 0 | 0 | 0 | | C3 | C3 | F2 | F2 | E2 |
| | HARPSICHORD | 0 | 0 | 0 | 0 | | C3 | F2 | G2 | G2 |
| | VIBES (CLP-155) | R | R | R | R | R | | B2 | | B2 |
| | STRINGS (CLP-155) | 0 | 0 | 0 | 0 | 0 | L | | | C3 |
| | ORGAN | 0 | 0 | 0 | 0 | 0 | L | 0 | | |

C2 ... C4: Balance keys 0: Normal octave L: Left voice up one octave R: Right voice up one octave

Reverb

The **[REVERB]** button selects a number of digital reverb effects that you can use for extra depth and expressive power.

To select a reverb type press the **[REVERB]** button a few times until the indicator corresponding to the desired type lights (the indicators light in sequence each time the **[REVERB]** button is pressed). No reverb is produced when all indicators are off.

OFF When no reverb effect is selected (no REVERB indicator is lit), a special natural damper effect is applied to the piano voices. This simulates the natural resonance of an acoustic piano's strings and sound board when the damper pedal is pressed.

ROOM This setting add a continuous reverb effect to the sound that is similar to the type of acoustic reverberation you would hear in a medium-size room.

HALL 1 For a "bigger" reverb sound, use the HALL 1 setting. This effect simulates the natural reverberation of a medium-size concert hall.

HALL 2 For a really spacious reverb sound, use the HALL 2 setting. This effect simulates the natural reverberation of a large concert hall.

COSMIC The COSMIC reverb effect produces an echo-plus-reverb sound that can add life and animation to your music.

● Adjusting Reverb Depth

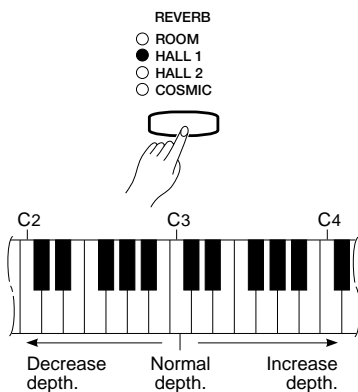

The depth of the selected reverb effect can be adjusted for the current voice by using the **C2** through **C4** keys on the keyboard while holding the **[REVERB]** button. The **C3** key sets the "normal" depth for the selected effect. Keys to the left of **C3** decrease the reverb depth, while keys to the right of the **C3** key increase the reverb depth. Separate reverb settings can be made for each effect and voice, and these settings are retained in memory until the power is turned off. The depth of the natural damper effect is fixed.

Default Settings

| | ROOM | HALL 1 | HALL 2 | COSMIC |
|--------------------------|------|--------|--------|--------|
| STRINGS (CLP-155), ORGAN | C3 | C3 | F3 | E3 |

* All effect types set to C3 for all other voices.

* The default reverb type is ROOM.

● Memorizing the Reverb Type & Depth Settings

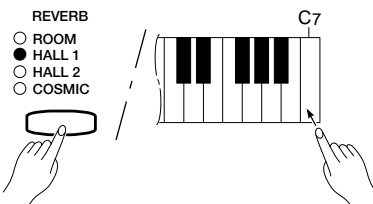

Press the **C7** key while holding the **[REVERB]** button to memorize the current effect type and all depth settings made since the power was turned on. The memorized settings will be retained in memory for about one week after the power is turned off, then the default settings will be restored. To keep the memorized settings for longer periods, turn the power on briefly at least once a week.

If these settings are not memorized as described above, they are retained in memory only until the Clavinova is turned off.

Brilliance (CLP-155)

The **[BRILLIANCE]** button makes it possible to change the tonality or “timbre” of the selected voice to suit your musical requirements. Three settings are provided: MELLOW, NORMAL, and BRIGHT. To select one of these settings, press the **[BRILLIANCE]** button a few times until the indicator corresponding to the desired setting lights.

NORMAL This setting produces the “normal” tone of the selected voice.

BRIGHT This setting creates a brighter, sharper tone.

MELLOW The MELLOW setting produces a rounder, softer tone.

● Memorizing the Brilliance Setting

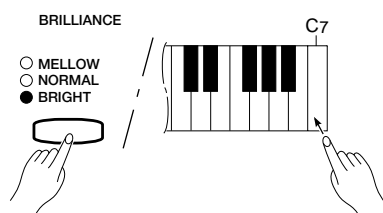

Press the C7 key while holding the **[BRILLIANCE]** button to memorize the current brilliance setting. The memorized setting will be retained in memory for about one week after the power is turned off, then the default setting (NORMAL) will be restored. To keep the memorized setting for longer periods, turn the power on briefly at least once a week.

If this setting is not memorized as described above, it is retained in memory only until the Clavinova is turned off.

The Pedals

The CLP-154S/155 has three foot pedals that produce a range of expressive effects similar to those produced by the pedals on an acoustic piano.

● Soft (Left) Pedal

Pressing the soft pedal reduces the volume and slightly changes the timbre of notes played.

● Sostenuto (Center) Pedal

If you play a note or chord on the keyboard and press the sostenuto pedal while the note(s) are held, those notes will be sustained as long as the pedal is held (as if the damper pedal had been pressed) but all subsequently played notes will not be sustained. This makes it possible to sustain a chord, for example, while other notes are played “staccato.”

● Damper (Right) Pedal

The damper pedal functions in the same way as a damper pedal on an acoustic piano. When the damper pedal is pressed notes played have a long sustain. When no REVERB effect is selected and a piano voice is selected, the damper pedal also produces a special “resonance” that simulates the ring of the strings and the sound board of an acoustic piano. Releasing the pedal immediately stops (damps) any sustained notes. The CLP-155 damper pedal additionally features continuous damping. This allows you to create shorter effects by pressing the damper pedal down only part of the way.

Touch Sensitivity

Four different types of keyboard touch sensitivity — HARD, MEDIUM, SOFT or FIXED — can be selected to match different playing styles and preferences. The different touch sensitivity settings are selected by using the [MIDI/TRANPOSE] and [REVERB] buttons.

- HARD** (ROOM indicator) The HARD setting requires the keys to be played quite hard to produce maximum loudness.
- MEDIUM** (HALL 1 indicator) The MEDIUM setting produces a fairly “standard” keyboard response. This is the initial factory default setting.
- SOFT** (HALL 2 indicator) The SOFT setting allows maximum loudness to be produced with relatively light key pressure.
- FIXED** (No indicator lit) All notes are produced at the same volume no matter how hard the keyboard is played. This is an ideal setting for voices which normally have no keyboard sensitivity (i.e. harpsichord and organ).

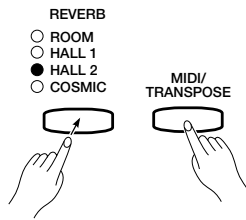

To select a touch sensitivity setting press the [REVERB] button a few times while holding the [MIDI/TRANPOSE] button until the indicator corresponding to the desired setting lights.

● Memorizing the Touch Sensitivity Setting

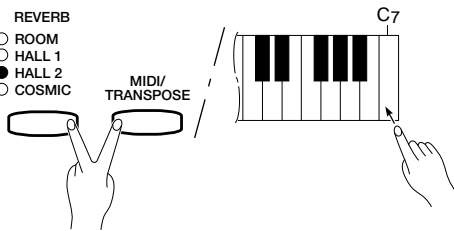

Press the C7 key while holding the [MIDI/TRANPOSE] and [REVERB] button to memorize the current touch sensitivity setting. The memorized setting will be retained in memory for about one week after the power is turned off, then the default setting (MEDIUM) will be restored. To keep the memorized setting for longer periods, turn the power on briefly at least once a week.

If this setting is not memorized as described above, it is retained in memory only until the Clavinova is turned off.

Transposition

The Clavinova’s TRANPOSE function makes it possible to shift the pitch of the entire keyboard up or down in semitone intervals up to a maximum of six semitones. “Transposing” the pitch of the Clavinova keyboard facilitates playing in difficult key signatures, and you can easily match the pitch of the keyboard to the range of a singer or other instrumentalist.

The [MIDI/TRANPOSE] button and keys F#2 through F#3 on the keyboard are used for transposition.

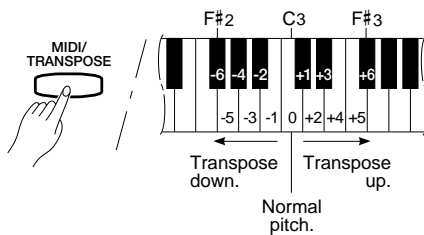

- 1** Press and hold the [MIDI/TRANPOSE] button.
- 2** Press a key between F#2 and F#3 according to the desired amount of transposition.*
- 3** Release the [MIDI/TRANPOSE] button.

* Pressing the C3 key produces normal keyboard pitch. Pressing the key to the left of C3 (B2) transposes the pitch of the keyboard down a semitone, the next key to the left (Bb2) transposes down a whole tone (two semitones), etc., down to the F#2 key which transposes down 6 semitones. Upward transposition is accomplished in the same way using the keys to the right of C3, up to F#3 which transposes up 6 semitones.



• Notes below and above the A-1 — C7 of the Clavinova sound one octave higher and lower, respectively.

Pitch Control

Pitch control makes it possible to tune the Clavinova over a ± 50 -cent range in approximately 1.2-cent intervals. A hundred "cents" equals one semitone, so the tuning range provided allows fine tuning of overall pitch over a range of approximately a semitone. Pitch control is useful for tuning the Clavinova to match other instruments or recorded music.

● Tuning Up

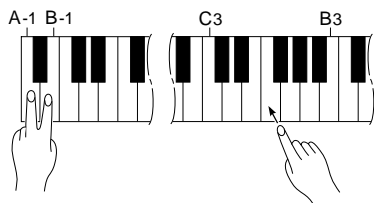

- 1** To tune up (raise pitch), hold the **A-1** and **B-1** keys simultaneously.
- 2** Press any key between **C3** and **B3**. Each time a key in this range is pressed the pitch is increased by approximately 1.2 cents, up to a maximum of 50 cents above standard pitch.
- 3** Release the **A-1** and **B-1** keys.

● Tuning Down

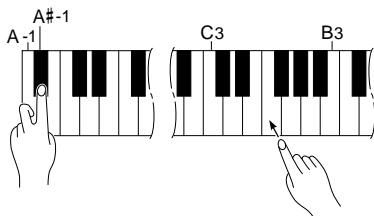

- 1** To tune down (lower pitch), hold the **A-1** and **A#-1** keys simultaneously.
- 2** Press any key between **C3** and **B3**. Each time a key in this range is pressed the pitch is decreased by approximately 1.2 cents, up to a maximum of 50 cents below standard pitch.
- 3** Release the **A-1** and **A#-1** keys.

● To Restore Standard Pitch*

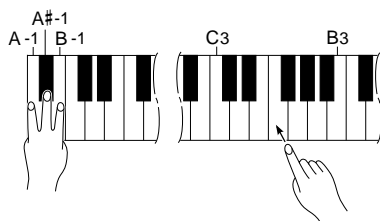

- 1** To restore the default pitch ($A_3 = 440$ Hz), hold the **A-1**, **A#-1** and **B-1** keys simultaneously.
- 2** Press any key between **C3** and **B3**.
- 3** Release the **A-1**, **A#-1** and **B-1** keys.



• The **PITCH CONTROL** function has no effect when **LOCAL OFF** is active (see "MIDI FUNCTIONS," page 17).

● Memorizing the Pitch Control Setting

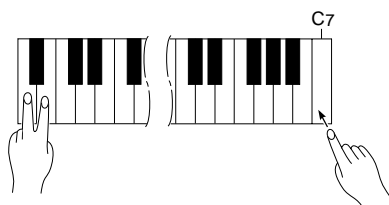

Press the **C7** key while holding the **A-1/B-1**, **A-1/A#-1**, or **A-1/A#-1/B-1** key combination to memorize the current pitch control setting. The memorized setting will be retained in memory for about one week after the power is turned off, then the standard pitch will be restored. To keep the memorized setting for longer periods, turn the power on briefly at least once a week.

If this setting is not memorized as described above, it is retained in memory only until the Clavinova is turned off.



The Metronome & Tempo Control

The CLP-154S/155 built-in metronome is a convenient feature for practice, and it can also provide a solid rhythmic guide when recording using the Recorder feature, described below.

The Metronome



The metronome sound is turned on and off via the [METRONOME] button. Press the [METRONOME] button so that its indicator lights to turn the metronome on, then again so the indicator goes out to turn the metronome off.

● Metronome Volume

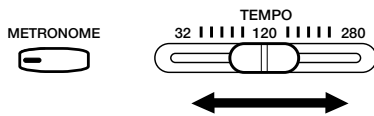

The volume of the metronome sound can be independently adjusted by using the [TEMPO] control while holding the [METRONOME] button. Sliding the control to the right increases the metronome volume.

● Metronome Time Signature

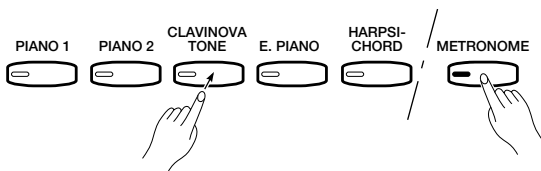

The time signature of the metronome sound can be set by pressing the appropriate voice selector button while holding the [METRONOME] button, as follows:

| | |
|--------------------------------|---------------------|
| [METRONOME] + [PIANO 1] | No accent (default) |
| [METRONOME] + [PIANO 2] | 2 time |
| [METRONOME] + [CLAVINOVA TONE] | 3 time |
| [METRONOME] + [E. PIANO] | 4 time |
| [METRONOME] + [HARPSICHORD] | 6 time |

Tempo Control

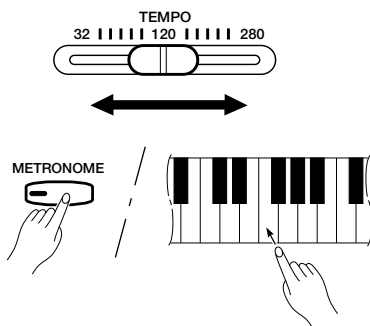

The tempo of the metronome and recorder playback can be controlled in two ways:

- Use the panel [TEMPO] control to set the required tempo from 32 to 280 quarter-note beats per minute.
- For more precise tempo settings press the appropriate key on the keyboard while holding the [METRONOME] button.

Tempo/Key Chart

| Key | Tempo | Key | Tempo | Key | Tempo | Key | Tempo | Key | Tempo | Key | Tempo | Key | Tempo | Key | Tempo |
|------|-------|-----|-------|-----|-------|-----|-------|-----|-------|-----|-------|-----|-------|-----|-------|
| A-1 | 32 | G#0 | 54 | G1 | 76 | F#2 | 98 | F3 | 120 | E4 | 142 | D#5 | 168 | D6 | 212 |
| A#-1 | 34 | A0 | 56 | G#1 | 78 | G2 | 100 | F#3 | 122 | F4 | 144 | E5 | 172 | D#6 | 216 |
| B-1 | 36 | A#0 | 58 | A1 | 80 | G#2 | 102 | G3 | 124 | F#4 | 146 | F5 | 176 | E6 | 220 |
| C0 | 38 | B0 | 60 | A#1 | 82 | A2 | 104 | G#3 | 126 | G4 | 148 | F#5 | 180 | F6 | 224 |
| C#0 | 40 | C1 | 62 | B1 | 84 | A#2 | 106 | A3 | 128 | G#4 | 150 | G5 | 184 | F#6 | 232 |
| D0 | 42 | C#1 | 64 | C2 | 86 | B2 | 108 | A#3 | 130 | A4 | 152 | G#5 | 188 | G6 | 240 |
| D#0 | 44 | D1 | 66 | C#2 | 88 | C3 | 110 | B3 | 132 | A#4 | 154 | A5 | 192 | G#6 | 248 |
| E0 | 46 | D#1 | 68 | D2 | 90 | C#3 | 112 | C4 | 134 | B4 | 156 | A#5 | 196 | A6 | 256 |
| F0 | 48 | E1 | 70 | D#2 | 92 | D3 | 114 | C#4 | 136 | C5 | 158 | B5 | 200 | A#6 | 264 |
| F#0 | 50 | F1 | 72 | E2 | 94 | D#3 | 116 | D4 | 138 | C#5 | 160 | C6 | 204 | B6 | 272 |
| G0 | 52 | F#1 | 74 | F2 | 96 | E3 | 118 | D#4 | 140 | D5 | 164 | C#6 | 208 | C7 | 280 |



Using the Recorder

The CLP-154S/155 features a two-track recorder that lets you record what you play on the keyboard and then play it back. Since you have two tracks, you can “overdub” one part on top of another, using a different voice if you like, to create complex, rich-sounding recordings. The recorder feature is a useful adjunct to any keyboard study program, since it lets you hear exactly how you sound from the listener’s perspective. It can also be just plain fun.

The recorder actually records the following data:

Parameters Recorded for Each track

- Notes played
- Voice selection
- Dual mode voices
- Dual balance
- Damper pedal
- Soft pedal
- Sostenuto pedal (not recorded as an initial setting)
- Brilliance (CLP-155 only)

Parameters Recorded for the Entire Song

- Reverb type
- Reverb depth
- Tempo (initial setting only)

Recording

1 Engage the Record Ready Mode

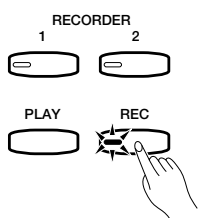

Press the **RECORDER [REC]** button to engage the record ready mode (recording does not actually start yet). The **[REC]** button indicator will light.

2 Select the Record Track

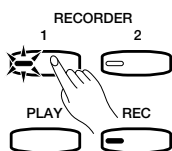

When the record mode is engaged in the previous step, the last-recorded track will automatically be selected for recording and its indicator — i.e. the **[1]** or **[2]** button indicator — will glow red. If you want to record on a different track, press the appropriate track button so that its indicator glows red.



- The track button indicators of tracks which contain previously recorded data will glow green (unless the track is turned off as described below). The previously-recorded data on the non-record track will normally be played back as you record, so you can play along with a previously-recorded track. If you don't want to hear the previously recorded track as you record, press the playback track button before pressing the **[REC]** button (step 1, above) so that its indicator goes out.
- Recording on a track which already contains data will erase all previous data on that track.

3 Make All Necessary Initial Settings

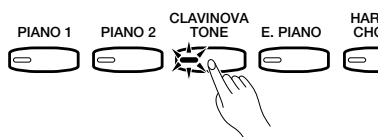

Before actually beginning to record, select the voice you want to record with (or voices if you will be using the dual mode). You might also want to set the volume and tempo controls.

4 Start Recording

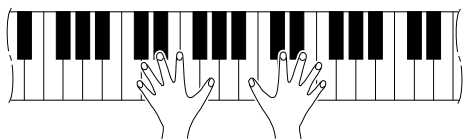

Recording will begin automatically as soon as you play a note on the keyboard or press the **[PLAY]** button.



- If the metronome was on when you started recording, you'll be able to keep time with the metronome while recording, but the metronome sound will not be recorded.
- You can record up to a maximum of about 4,200 notes, depending on pedal usage and other factors. The **[REC]** button and record track indicators will begin to flash when recorder memory is almost full, and recording will stop automatically.

Using the Recorder

5 Stop Recording

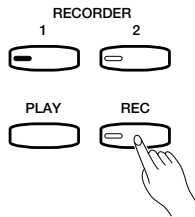

Press either the **RECORDER [REC]** or **[PLAY]** button to stop recording. The indicator of the recorded track will glow green to indicate that it now contains data.

● Changing the Initial Settings

The initial voice (including dual mode and dual balance setting), damper pedal, soft pedal, tempo, reverb type, reverb depth, and brilliance (CLP-155 only) settings made in step 3 of the recording procedure are actually recorded by the CLP-154S/155. These initial settings can be changed after the recording is finished by pressing the **[REC]** button to engage the record ready mode, pressing the appropriate track button, making the required changes, and then pressing the **[REC]** button again to exit from the record ready mode and register the changes. If you do this, be careful not to press the **[PLAY]** button or a key on the keyboard, either of which will start recording and erase all previous recorded data on the selected track. If you start this procedure but decide to cancel, simply select a different track then press the **[REC]** button a second time.

● Erasing a Single Track

All data can be erased from either of the recorder's tracks by engaging the record mode, selecting the track you want to erase, and then pressing the **[PLAY]** button twice without recording any data.

Playback

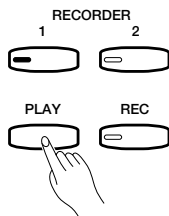

To play back what you've recorded, first make sure that the green track indicators of the tracks you want to play are lit. If not, press the corresponding track button(s) so that they are lit. Then press the **RECORDER [PLAY]** button. Playback starts from the beginning of the recorded data, and will stop automatically at the end of the recorded data. You can also stop playback at any time by pressing the **[PLAY]** button. To mute a track so that it doesn't play back, press the corresponding track button so that its indicator goes out (press again to turn the track back on).



- All recorder data will be retained in memory for about one week after the power is turned off. If you want to keep your recorded data for longer periods, turn the power on briefly at least once a week. It is also possible to store it to an external MIDI storage device such as the Yamaha DOU-10 Disk Orchestra Unit by using the Bulk Dump function described on page 20.
- The track indicators will not light automatically when the power is turned on even if the recorder contains data. It is therefore necessary to press the track buttons so that the corresponding green indicators light before starting **RECORDER** playback. It is also a good idea to press the track buttons to check if the tracks contain data before recording. If the green indicator lights when the corresponding track button is pressed, that track contains data which will be erased and replaced by the newly-recorded data.
- If the metronome is being used during playback, the metronome will stop when playback is stopped.
- The playback data is not transmitted via the **MIDI OUT** connector.

● Fast Forward Playback

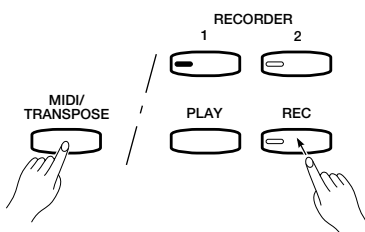

When you want to locate a specific point in a recording you can quickly move forward through the recording while monitoring the sound by pressing the **[REC]** button while holding the **[MIDI/TRANPOSE]** button.



MIDI Functions

● A Brief Introduction to MIDI

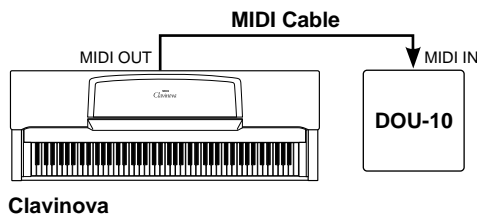

MIDI, the Musical Instrument Digital Interface, is a world-standard communication interface that allows MIDI-compatible musical instruments and equipment to share musical information and control one another. This makes it possible to create “systems” of MIDI instruments and equipment that offer far greater versatility and control than is available with isolated instruments. For example, most MIDI keyboards (including the Clavinova, of course) transmit note and velocity (touch response) information via the MIDI OUT connector whenever a note is played on the keyboard. If the MIDI OUT connector is connected to the MIDI IN connector of a second keyboard (synthesizer, etc.) or a tone generator (essentially a synthesizer with no keyboard), the second keyboard or tone generator will respond precisely to notes played on the original transmitting keyboard. The result is that you can effectively play two instruments at once, providing thick multi-instrument sounds.

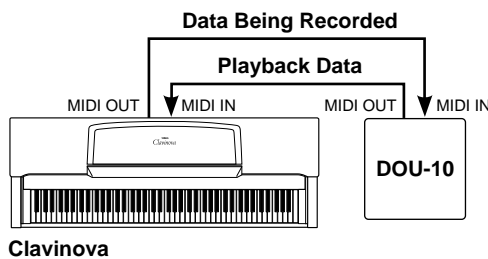

This same type of musical information transfer is used for MIDI sequence recording. A sequence recorder can be used to “record” MIDI data received from a Clavinova, for example. When the recorded data is played back, the Clavinova automatically “plays” the recorded performance in precise detail.

The examples given above really only scratch the surface. MIDI can do much, much more. The CLP-154S/155 offers a number of MIDI functions that allows it to be used in fairly sophisticated MIDI systems.



• Always use a high-quality MIDI cable to connect MIDI OUT to MIDI IN terminals. Never use MIDI cables longer than about 15 feet, since cables longer than this can pick up noise which can cause data errors.

● MIDI “Messages” Transmitted & Received by the Clavinova

The MIDI information (messages) transmitted and received by the Clavinova are as follows:

Note and Velocity Data

This information tells the receiving keyboard or tone generator to play a certain note (specified by the MIDI note number) at a certain dynamic level (specified by the MIDI velocity value). Note and velocity data is transmitted by the Clavinova whenever a key is pressed, and the Clavinova’s internal AWM tone generator will “play” the corresponding note(s) whenever note and velocity data is received from an external MIDI device.

Program Change Numbers

The CLP-154S transmits a MIDI program change number between 0 and 5, and the CLP-155 transmits a MIDI program change number between 0 and 7 when one of its voice selectors is pressed. This normally causes the correspondingly numbered voice to be selected on a receiving MIDI device. The Clavinova will respond in the same way, automatically selecting the appropriate voice when a MIDI program change number is received. See “Program Change ON/OFF” on page 17 for information on turning program change number reception and transmission ON or OFF.

Control Change Numbers

Control Change data representing Damper pedal operation is transmitted by the Clavinova whenever one of these pedals is used. If the receiving device is a tone generator or another keyboard, it will respond in the same way as the Clavinova’s internal tone generator when one of the pedals is used. The Clavinova also receives and responds to the appropriate control change data. See “Control Change ON/OFF” on page 18 for information on turning control change number reception and transmission ON or OFF.

MIDI Functions

● MIDI Transmit & Receive Channel Selection

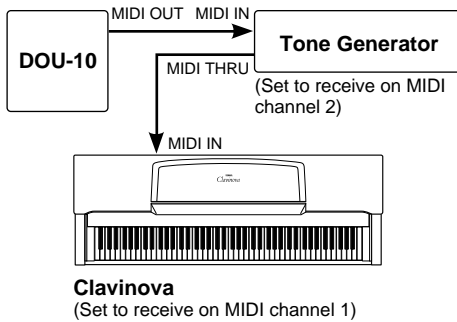

The MIDI system allows transmission and reception of MIDI data on 16 different channels. Multiple channels have been implemented to allow selective control of certain instruments or devices connected in series. For example, a single MIDI sequence recorder could be used to “play” two different instruments or tone generators. One of the instruments or tone generators could be set to receive only on channel 1, while the other is set to receive on channel 2. In this situation the first instrument or tone generator will respond only to channel-1 information transmitted by the sequence recorder, while the second instrument or tone generator will respond only to channel-2 information. This allows the sequence recorder to “play” two completely different parts on the receiving instruments or tone generators.

In any MIDI control setup, the MIDI channels of the transmitting and receiving equipment must be matched for proper data transfer. An “OMNI” receive mode is also available, which allows reception on all 16 MIDI channels. In the OMNI mode it is not necessary to match the receive channel of the receiving device to the transmit channel of the transmitting device (except when receiving mode messages).

Setting the Clavinova MIDI Channels

- 1** Press and hold the [MIDI/TRANPOSE] button.
- 2** Press the key on the keyboard corresponding to the desired MIDI transmit or receive channel.*
- 3** Release the [MIDI/TRANPOSE] button.

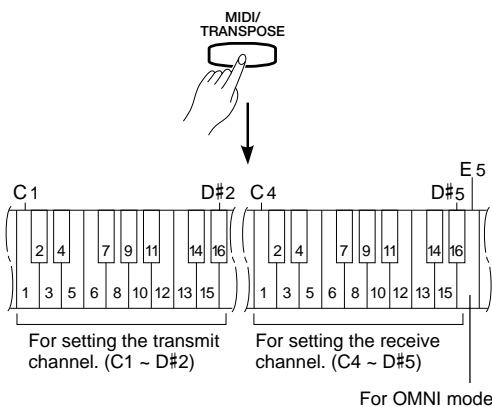

* Keys **C1** through **D#2** on the keyboard are used to set the MIDI transmit channel, and keys **C4** through **D#5** are used to turn the OMNI mode OFF and set the MIDI receive channel as shown in the illustration to the left. The **E5** key sets the OMNI receive mode and basic receive channel 1.

NOTE • When the power is initially turned ON, MIDI receive is set to the OMNI mode, the basic receive channel is set to 1, and the transmit channel is set to 1.

● MIDI Transmit Transpose

This function allows the MIDI note data transmitted by the Clavinova to be transposed up or down in semitone increments by up to plus or minus 6 semitones. The pitch of the Clavinova itself is not affected.

Setting the MIDI Transpose Function

- 1** Press and hold the [MIDI/TRANPOSE] button.
- 2** Press the key on the keyboard corresponding to the desired amount of transposition.*
- 3** Release the [MIDI/TRANPOSE] button.

* Keys **F#5** through **F#6** on the keyboard are used to set the MIDI transmit transpose function as shown in the illustration to the left.

NOTE • When the power is turned ON, MIDI transmit transpose is set to 0 (no transposition).

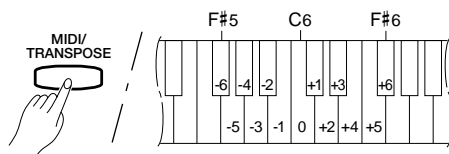

Other MIDI Functions

The MIDI functions listed to the right are engaged by holding down the **[MIDI/TRANSDPOSE]** button and pressing the corresponding voice selector. Full details are given in the following pages.

MIDI FUNCTION CHART

| Function | CLP-154S Voice Selector | CLP-155 Voice Selector |
|------------------------------|-------------------------|------------------------|
| Local Control ON/OFF | [PIANO 1] | [PIANO 1] |
| Program Change ON/OFF | [PIANO 2] | [PIANO 2] |
| Control Change ON/OFF | [CLAVINOVA TONE] | [CLAVINOVA TONE] |
| Multi-Timbre Mode | [E. PIANO] | [E. PIANO] |
| MIDI Split & Left Local OFF | [HARPSICHORD] | [HARPSICHORD] |
| MIDI Split & Right Local OFF | [ORGAN] | [VIBES] |
| Panel Data Transmit | - none - | [STRINGS] |

● Local Control ON/OFF

“Local Control” refers to the fact that, normally, the Clavinova keyboard controls its internal tone generator, allowing the internal voices to be played directly from the keyboard. This situation is “Local Control ON” since the internal tone generator is controlled locally by its own keyboard.

Local control can be turned OFF, however, so that the Clavinova keyboard does not play the internal voices, but the appropriate MIDI information is still transmitted via the MIDI OUT connector when notes are played on the keyboard. At the same time, the internal tone generator responds to MIDI information received via the MIDI IN connector.

When using the DOU-10 Disk Orchestra Unit with the Clavinova, for example, Local Control should be turned OFF when recording using the DOU-10 voices only, and ON when recording the Clavinova voices while listening to playback of the DOU-10 voices.

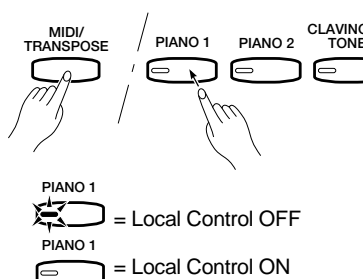

- 1** Hold down the **[MIDI/TRANSDPOSE]** button.
- 2** Press the **[PIANO 1]** voice selector. If the **PIANO 1** LED is lit when the **[PIANO 1]** voice selector is pressed, you have turned local control OFF. If the **PIANO 1** LED is not lit when the **[PIANO 1]** voice selector is pressed, you have turned local control ON.
- 3** Release the **[MIDI/TRANSDPOSE]** button.

● Program Change ON/OFF

Normally the Clavinova will respond to MIDI program change numbers received from an external keyboard or other MIDI device, causing the correspondingly numbered Clavinova voice to be selected. The Clavinova will normally also send a MIDI program change number whenever one of its voices is selected, causing the correspondingly numbered voice or program to be selected on the external MIDI device if the device is set up to receive and respond to MIDI program change numbers.

This function makes it possible to cancel program change number reception and transmission so that voices can be selected on the Clavinova without affecting the external MIDI device, and vice versa.

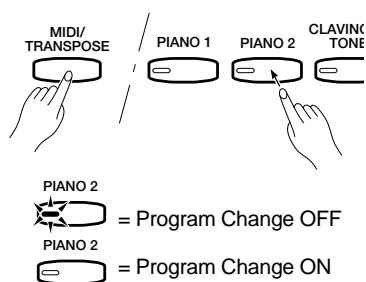

- 1** Hold down the **[MIDI/TRANSDPOSE]** button.
- 2** Press the **[PIANO 2]** voice selector. If the **PIANO 2** LED is lit when the **[PIANO 2]** voice selector is pressed, you have turned program change reception/transmission OFF. If the **PIANO 2** LED is not lit when the **[PIANO 2]** voice selector is pressed, you have turned program change reception/transmission ON.
- 3** Release the **[MIDI/TRANSDPOSE]** button.

MIDI Functions

● Control Change ON/OFF

Normally the Clavinova will respond to MIDI control change data received from an external MIDI device or keyboard, causing the selected Clavinova voice to be affected by pedal and other “control” settings received from the controlling device. The Clavinova also transmits MIDI control change information when one of its pedals are operated.

This function makes it possible to cancel control change data reception and transmission if you do not want the Clavinova voices to be affected by control change data received from an external device or vice versa.

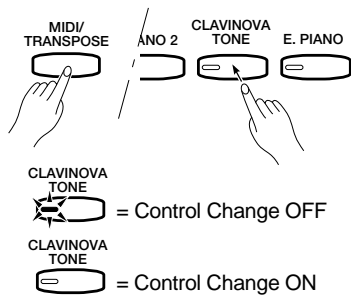

- 1** Hold down the [MIDI/TRANSPOSE] button.
- 2** Press the [CLAVINOVA TONE] voice selector. If the CLAVINOVA TONE LED is lit when the [CLAVINOVA TONE] voice selector is pressed, you have turned control change reception/transmission OFF. If the CLAVINOVA TONE LED is not lit when the [CLAVINOVA TONE] voice selector is pressed, you have turned control change reception/transmission ON.
- 3** Release the [MIDI/TRANSPOSE] button.

● The Multi-Timbre Mode

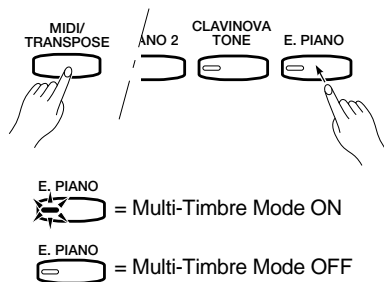

The Multi-Timbre mode is a special mode in which the Clavinova voices can be independently controlled on different MIDI channel numbers by an external MIDI device. The Multi-Timbre mode can be activated as follows:

- 1** Hold down the [MIDI/TRANSPOSE] button.
- 2** Press the [E. PIANO] voice selector. If the E. PIANO LED is lit when the [E. PIANO] voice selector is pressed, you have turned the Multi-Timbre mode ON. If the E. PIANO LED is not lit when the [E. PIANO] voice selector is pressed, you have turned the Multi-Timbre mode OFF.
- 3** Release the [MIDI/TRANSPOSE] button.

● The MIDI Split & Left Local OFF Mode

In the MIDI split mode one section of the Clavinova keyboard is used to play a Clavinova voice in the normal way, while the remaining section is used to play a second MIDI keyboard or tone generator such as the Yamaha DOU-10 Disk Orchestra Unit. In this mode the right-hand section of the keyboard is used to play an internal Clavinova voice, while the left-hand section of the keyboard plays the external keyboard or tone generator. Playing the left-hand section of the keyboard produces no sound from the Clavinova. The “split point,” or the key that divides the left- and right-hand sections of the keyboard can be set at any desired key.

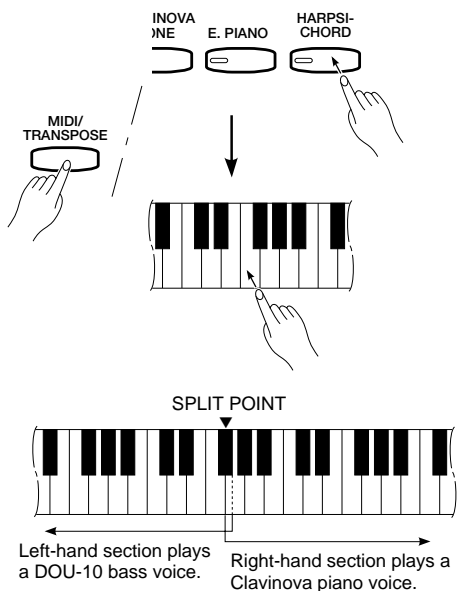
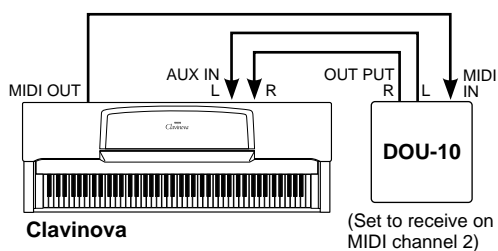

The MIDI split mode is useful if, for example, you want to play a piano (Clavinova) voice with the right hand while playing a synthesizer bass line or string section with the left hand.

When the MIDI split mode is activated, notes played on the left-hand section are transmitted via the Clavinova MIDI OUT connector on MIDI channel 2. Notes played on the right-hand section are transmitted on the “basic channel” (i.e. the channel set using the MIDI channel selection function described previously).

- 1** Press the [**HARPSICHORD**] voice selector while holding down the [**MIDI/TRANSCOPE**] button. The HARPSICHORD LED will flash.
- 2** While still holding the [**MIDI/TRANSCOPE**] button, press the key on the keyboard at which you want to set the split point. The HARPSICHORD LED will light continuously. The split-point becomes the first key of the left-hand section.
- 3** Release the [**MIDI/TRANSCOPE**] button.
- 4** To return to the normal full-keyboard mode, hold the [**MIDI/TRANSCOPE**] button and press the [**HARPSICHORD**] voice selector, then release both buttons.



• When the power is turned ON the default split point key — F#2 — will be automatically selected. If a new split point is selected it remains active until the power is turned OFF or a different split point is selected.

● The MIDI Split & Right Local Off Mode

In the CLP-154S/155 either the right- or left-hand section of the keyboard can be assigned to control an external keyboard or tone generator. Assigning the left-hand section to external tone generator control was described in the previous section. To assign the right-hand section to external tone generator control while playing the Clavinova voices with the left hand, press the [**ORGAN**] voice selector on the CLP-154S or the [**VIBES**] voice selector on the CLP-155 instead of the [**HARPSICHORD**] voice selector when activating the Split mode (see the preceding section). All other operations are exactly the same as described in the previous section.

MIDI Functions

● Transmitting the Panel Settings (CLP-155 only)

This function causes all the current Clavinova control settings (selected voice, etc.) to be transmitted via the MIDI OUT terminal. This is particularly useful if you will be recording performances to a MIDI sequence recorder which will be used to control the Clavinova on playback. By transmitting the Clavinova panel settings and recording them on the MIDI sequence recorder prior to the actual performance data, the Clavinova will be automatically restored to the same settings when the performance is played back.

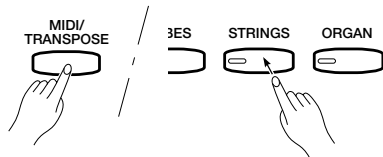

- 1** Hold down the [MIDI/TRANPOSE] button.
- 2** Press the [STRINGS] voice selector.
- 3** Release the [MIDI/TRANPOSE] button.



• See page viii for list of the panel settings transmitted by this function.

● Bulk Data Dump

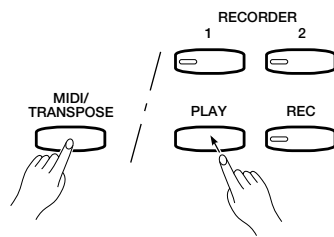

This function is used to transmit all data stored in the Recorder memory to a MIDI data storage device such as the Yamaha DOU-10 Disk Orchestra Unit, other sequence recorders, or MIDI compatible computers.

- 1** Hold [MIDI/TRANPOSE] and press the [PLAY] button. Transmission will begin.
- 2** Release the buttons.



• Bulk dump will not function when the metronome is on or when the recorder is in operation.

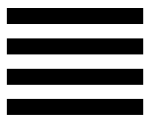

Factory Preset Recall

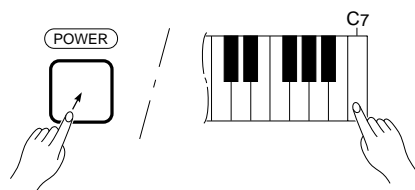

All dual mode, reverb, brilliance (CLP-155), touch sensitivity, and pitch control settings can be restored to their original factory preset values by holding the **C7** key while turning the [**POWER**] switch ON. This also erases all recorder data.

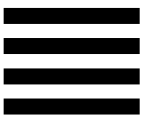

Troubleshooting

If you encounter what appears to be a malfunction, please check the following points before assuming that your Clavinova is faulty.

1. No Sound When the Power is Turned ON

Is the AC plug properly connected to an AC wall outlet? Check the AC connection carefully. Is the MASTER VOLUME control turned up to a reasonable listening level?

2. The Clavinova Reproduces Radio or TV Sound

This can occur if there is a high-power transmitter in your vicinity. Contact your Yamaha dealer.

3. Intermittent Static Noise

This is usually due to turning ON or OFF a household appliance or other electronic equipment which is fed by the same AC mains line as your Clavinova.

4. Interference Appears On Radio or TV Sets Located Near the Clavinova

The Clavinova contains digital circuitry which can generate radio-frequency noise. The solution is to move the Clavinova further away from the affected equipment, or vice versa.

5. Distorted Sound When the Clavinova is Connected to An External Amplifier/Speaker System

If the Clavinova is connected to a stereo system or instrument amplifier and the sound is distorted, reduce the setting of the Clavinova volume control to a level at which the distortion ceases.

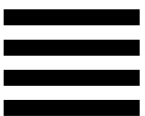

Options & Expander Modules

● Options

BC-8 Bench

A comfortable bench styled to match your Yamaha Clavinova.

HPE-160 Stereo Headphones

High-performance lightweight dynamic headphones with extra-soft ear pads.

KC-883 Key Cover (CLP-154S)

A convenient way to keep your keyboard clean and dust-free.

● Expander Modules

DOU-10 Disk Orchestra Unit

A range of MIDI recording and playback functions, plus Yamaha Disk Orchestra Collection, Disklavier PianoSoft™, General MIDI, and Standard MIDI File disk playback capability.

1

CLP-155

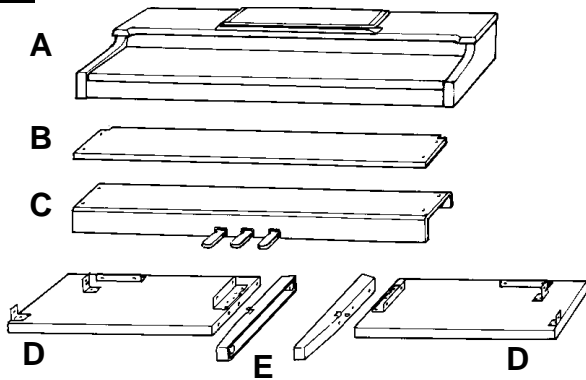

5 x 40 mm long gold screws
Lange goldene Schrauben (5 x 40 mm)
Vis longues dorées de 5 x 40 mm
Tornillos dorados largo de 5 x 40 mm } x 6 ①

6 x 18 mm round-head screws
Halbrundschauben (6 x 18 mm)
Vis à tête ronde de 6 x 18 mm
Tornillos de cabeza redonda de 6 x 18 mm } x 4 ②

CLP-154S

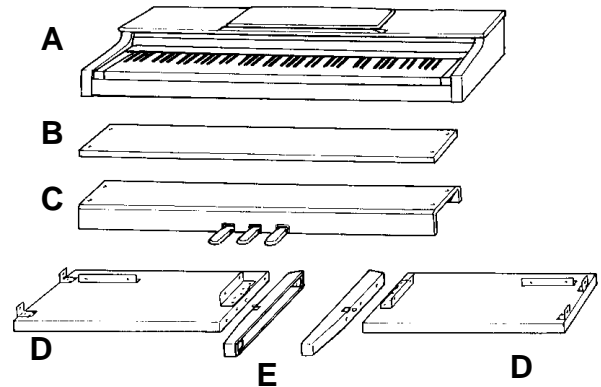

4 x 25 mm round-head screws
Halbrundschauben (4 x 25 mm)
Vis à tête ronde de 4 x 25 mm
Tornillos de cabeza redonda de 4 x 25 mm } x 4 ③

6 x 16 mm flat-head screws
Senkschrauben (6 x 16 mm)
Vis à tête plate de 6 x 16 mm
Tornillos de cabeza plana de 6 x 16 mm } x 4 ④

Keyboard Stand Assembly



- We do not recommend attempting to assemble the Clavinova alone. The job can be easily accomplished, however, with only two people.
- Use only the screws provided or replacements of exactly the specified size. Using screws of the wrong size can result in damage to the instrument.

1 Open the box and remove all the parts.

On opening the box you should find the parts shown in the illustration above. Check to make sure that all the required parts are provided.

2 Assemble the side panels (D) and feet (E).

Secure the feet (E) to the side panels (D) with the 5 x 40 millimeter long gold-colored screws ① (3 each), making sure that the cutouts on the feet face the bracket side of the side panels.

3 Attach the side panels (D) to the pedal box (C).

Before installing the pedal box, untie and straighten out the bundled cord attached to the bottom of the pedal box.

Place the pedal box on top of the brackets attached to the side panels (D), and attach using the four 6 x 18 millimeter round-head screws ② — two screws on each side. Make sure the pedals extend in the same direction as the feet.

Zusammenbau und Aufstellung



- Wir raten davon ab, das Clavinova alleine zusammenzubauen und aufzustellen. Zwei Personen können diese Arbeit jedoch problemlos ausführen.
- Verwenden Sie ausschließlich die mitgelieferten Schrauben oder Ersatzschrauben identischer Größe. Die Verwendung von Schrauben mit abweichenden Maßen kann eine Beschädigung des Instruments zur Folge haben.

1 Öffnen Sie den Karton und nehmen Sie alle Teile heraus.

Im Karton sollten die oben abgebildeten Teile enthalten sein. Prüfen Sie zunächst bitte, ob alle Teile vollständig vorhanden sind.

2 Schrauben Sie die Seitenwände (D) und die Füße (E) zusammen.

Machen Sie die Füße (E) mit den vier langen goldenen Schrauben (5 x 40 mm) ① (jeweils 3 Schrauben) so an den Seitenwänden fest, daß der Ausschnitt am jeweiligen Fuß unter dem Winkelblech an der Seitenwand zu liegen kommt.

3 Schrauben Sie den Pedalkasten (C) an den Seitenwänden (D) fest.

Bevor Sie den Pedalkasten montieren, nehmen Sie zunächst das gebündelte Kabel aus dem Pedalkasten, entfernen den Kabelbinder und ziehen das Kabel dann gerade aus.

Setzen Sie den Pedalkasten auf die Winkelbleche der beiden Seitenwänden (D), und schrauben Sie ihn dann mit den vier Halbrundschauben (6 x 18 mm) ② fest (jeweils zwei Schrauben links und rechts). Achten Sie dabei darauf, daß die Pedale in dieselbe Richtung weisen wie die vorspringenden Teile der Füße.

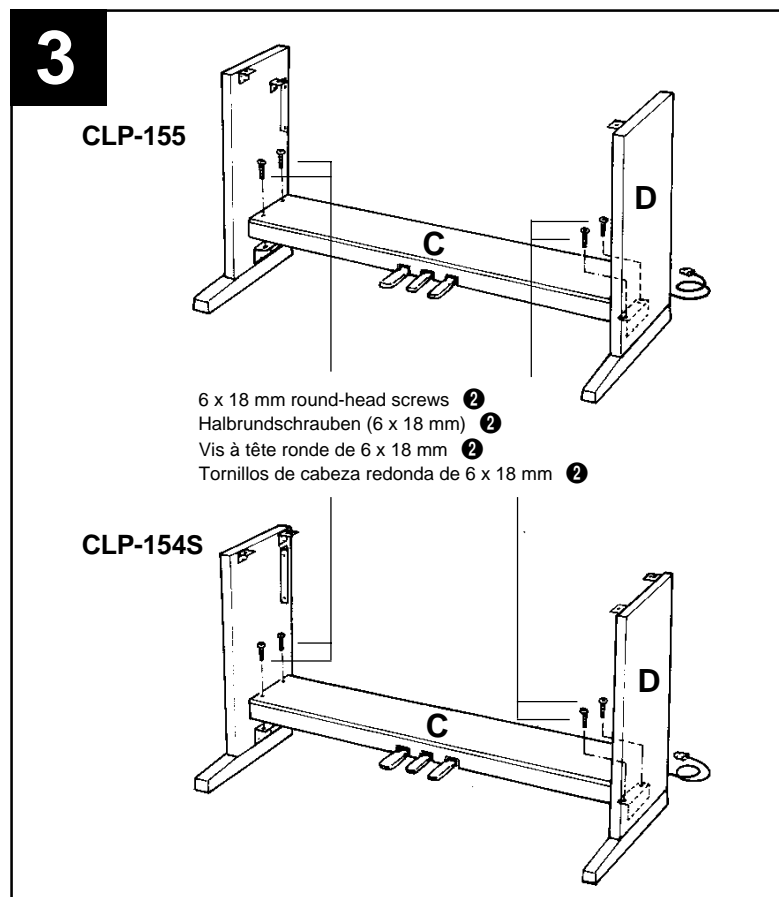
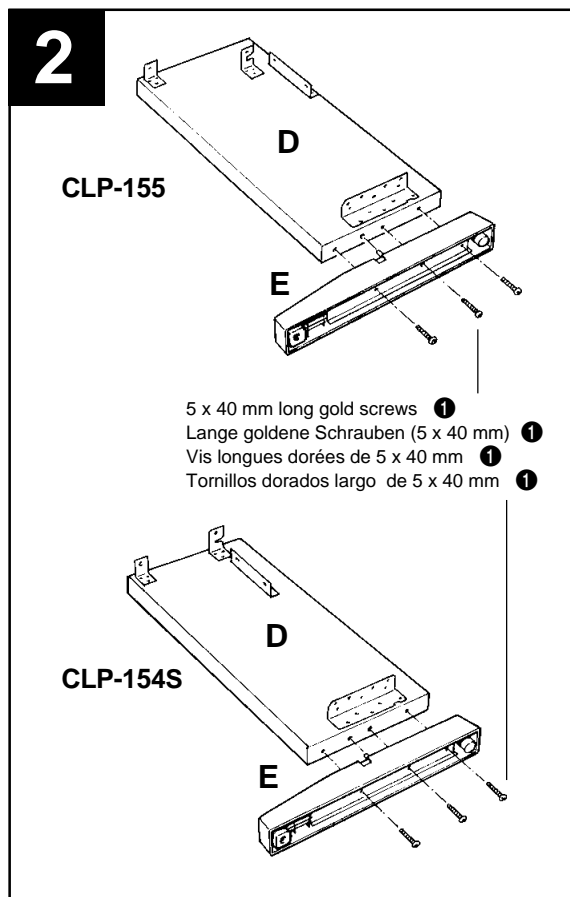

Assemblage du support de clavier



REMARQUE

- Nous ne vous conseillons pas d'essayer d'assembler le Clavinova seul. Toutefois, ce travail peut être facilement exécuté par deux personnes.
- N'utilisez que les vis fournies ou des vis ayant exactement les mêmes dimensions. L'utilisation de vis de dimensions incorrectes pourrait endommager l'instrument.

1 Ouvrez le carton et retirez toutes les pièces

Les pièces indiquées sur l'illustration devraient toutes se trouver dans le carton. Vérifiez qu'il n'en manque aucune.

2 Montez les panneaux latéraux (D) sur les supports inférieurs (E)

Fixez les supports inférieurs (E) aux panneaux latéraux (D) à l'aide des vis longues dorées de 5 x 40 millimètres ① (3 chacun) et veillez à ce que le bord découpé de chaque support soit dirigé vers le côté ferrure des panneaux latéraux.

3 Fixez les panneaux latéraux (D) au pédalier (C)

Avant de poser le pédalier, détacher le cordon de la partie inférieure du pédalier et le dérouler.

Placez le pédalier sur les ferrures fixées aux panneaux latéraux (D) et fixez-le à l'aide des quatre vis à tête ronde de 6 x 18 millimètres ② : deux vis de chaque côté. Veillez à ce que les pédales soient dirigées dans le même sens que les supports inférieurs.

Conjunto del soporte del teclado



NOTA

- No le recomendamos que intente montar la Clavinova usted solo. El trabajo puede ser realizado fácilmente entre dos personas.
- Utilice sólo los tornillos suministrados o reemplazos del exacto tamaño especificado. El empleo de tornillos de un tamaño erróneo puede dañar el instrumento.

1 Abra la caja y extraiga todas las partes.

Al abrir la caja deberá encontrar todas las partes mostradas en la ilustración. Compruebe para asegurarse que se proporcionan todas las partes necesarias.

2 Monte los paneles laterales (D) y las patas (E).

Asegure las patas (E) en los paneles laterales (D) con los tornillos dorados largos de 5 x 40 mm ① (3 cada uno), asegurándose de que los cortes de las patas quedan encarados con el lado de la ménsula de los paneles laterales.

3 Acople los paneles laterales (D) en la caja de pedales (C).

Antes de instalar la caja de pedales, desate y enderezca el cable plegado unido a la parte inferior de la caja de pedales.

Ponga la caja de pedales en la parte superior de las ménsulas acopladas a los paneles laterales (D), y acople empleando los cuatro tornillos de cabeza redonda de 6 x 18 mm ②; dos tornillos en cada lado. Asegúrese de que el pedal se extiende en la misma dirección que la pata.

4

CLP-155

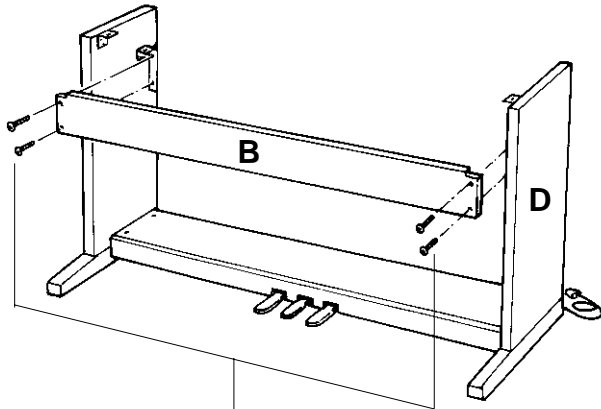

4 x 25 mm round-head screws ③
Halbrundsrauben (4 x 25 mm) ③
Vis à tête ronde de 4 x 25 mm ③
Tornillos de cabeza redonda de 4 x 25 mm ③

CLP-154S

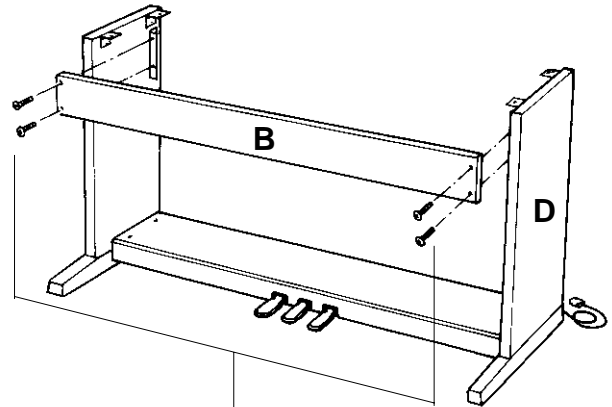

4 x 25 mm round-head screws ③
Halbrundsrauben (4 x 25 mm) ③
Vis à tête ronde de 4 x 25 mm ③
Tornillos de cabeza redonda de 4 x 25 mm ③

4 Attach the center panel (B) to the side panels (D).

The center panel (B) should be screwed to the brackets on the side panels (D) using the four 4 x 25 millimeter round-head screws ③, as shown in the illustration. Make sure the center panel is attached to the side of the brackets facing the pedals. The corner cutouts in the CLP-155 center panel are on the top edge of the panel.

5 Install the main unit (A).

Place the main unit (A) on the side panels (D) with the screws on its bottom panel (toward the rear of the main unit) just behind the grooves in the brackets located at the top of the side panels. Then slide the main unit forward until it stops. **WATCH YOUR FINGERS WHEN DOING THIS!!**

Align the holes on the bottom panel of the main unit with the holes in the brackets on the side panels (also center the main unit to produce equal clearance on the left and right sides, as shown in the illustration), then screw in and securely tighten the four 6 x 16 millimeter flat-head screws ④.

4 Schrauben Sie die Rückwand (B) an die beiden Seitenwände (D).

Die Rückwand (B) wird mit den vier Halbrundsrauben (4 x 25 mm) ③ an den Winkelblechen der Seitenwände (D) festgeschraubt, wie in der Abbildung gezeigt. Achten Sie bitte darauf, daß die Rückwand an den pedalseitigen Flächen der Winkelbleche angebracht wird. Beim CLP-155 müssen die Ausschnitte in den Ecken der Rückwand oben zu liegen kommen.

5 Montieren Sie die Tastatureinheit (A).

Setzen Sie die Tastatureinheit (A) so auf den fertigen Ständer, daß die beiden Schrauben an ihrer Unterseite hinter den Winkelblechen mit Führungsschlitz an der Hinterseite des Ständers zu liegen kommen. Schieben Sie die Tastatureinheit dann bis zum Anschlag in die Schlitz. **KLEMMEN SIE IHRE FINGER DABEI NICHT EIN!!**

Richten Sie die Schraubenbohrungen an der Unterseite der Tastatureinheit mit den Bohrungen der Winkelbleche aus (achten Sie auch darauf, daß sie mittig auf dem Ständer steht, wie in der Abbildung gezeigt). Schrauben Sie die Tastatureinheit dann mit den vier Senkschrauben (6 x 16 mm) ④ am Ständer fest.

5

CLP-155

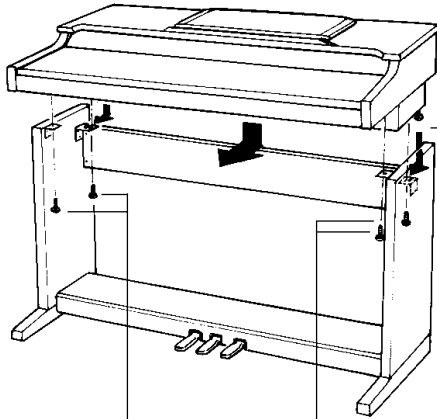
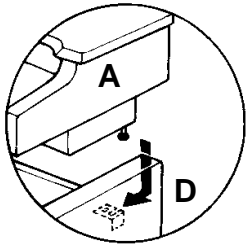

6 x 16 mm flat-head screws ④
 Senkschrauben (6 x 16 mm) ④
 Vis à tête plate de 6 x 16 mm ④
 Tornillos de cabeza plana de 6 x 16 mm ④

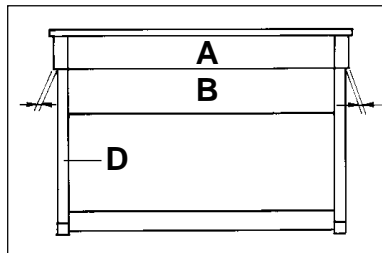

CLP-154S

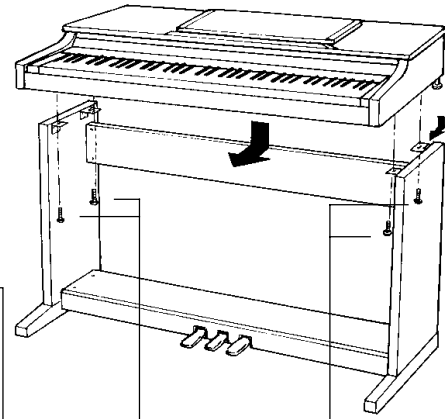
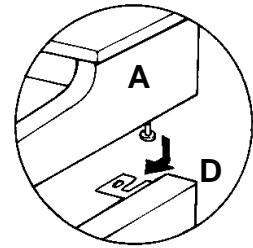

6 x 16 mm flat-head screws ④
 Senkschrauben (6 x 16 mm) ④
 Vis à tête plate de 6 x 16 mm ④
 Tornillos de cabeza plana de 6 x 16 mm ④

4 Fixez le panneau central (B) aux panneaux latéraux (D)

Le panneau central (B) doit être fixé aux ferrures des panneaux latéraux (D) de la manière illustrée à l'aide des quatre vis à tête ronde de 4 x 25 millimètres ③. Veillez à ce que le panneau central soit fixé aux ferrures côté pédale. Les découpes aux deux extrémités du panneau central du CLP-155 doivent être dirigées vers le haut.

5 Posez le clavier (A)

Placez le clavier sur les panneaux latéraux (D), avec les vis de son panneau inférieur (situées vers l'arrière du clavier) placées immédiatement derrière les rainures des ferrures situées à la partie supérieure des panneaux latéraux (D), puis faites glisser le clavier vers l'avant jusqu'à ce qu'il vienne en butée. **FAITES ATTENTION A VOS DOIGTS EN EXECUTANT CETTE OPERATION!!**

Alignez les trous du panneau inférieur du clavier sur les trous des ferrures des panneaux latéraux (centrez également le clavier de manière à avoir un jeu identique de chaque côté) puis posez et serrez à fond les quatre vis à tête plate de 6 x 16 millimètres ④.

4 Acople el panel central (B) a los paneles laterales (D).

EL panel central (B) debe enroscarse a las ménsulas de los paneles laterales (D) usando los cuatro tornillos de cabeza redonda de 4 x 25 mm ③ como se muestra en la ilustración. Asegúrese de que el panel central se monta al lado de las ménsulas encarado a los pedales. Los cortes de las esquinas del panel central de la CLP-155 están en el borde superior del panel.

5 Instale la unidad principal (A).

Coloque la unidad principal en los paneles laterales (D) con los tornillos de su panel inferior (hacia la parte posterior de la unidad principal) justo detrás de las ranuras de la ménsula ubicada en la parte superior de los paneles laterales (D), después deslice el teclado hacia adelante hasta que se pare. **¡TENGA CUIDADO CON SUS DEDOS MIENTRAS LO HACE!**

Alinee los orificios del panel inferior de la unidad principal con los orificios de las ménsulas de los paneles laterales (también centre la unidad principal para producir una holgura igual en los lados derecho e izquierdo, como se muestra en la ilustración), después enrosque y apriete bien los cuatro tornillos de cabeza plana de 6 x 16 mm ④.

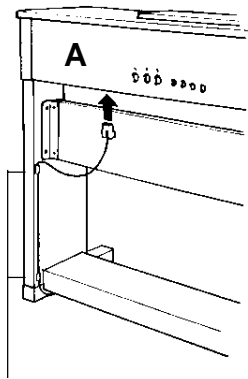
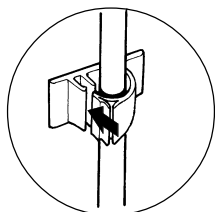
6**CLP-155**

Cord holder
Kabelhalter
Support de cordon
Soporte del cable

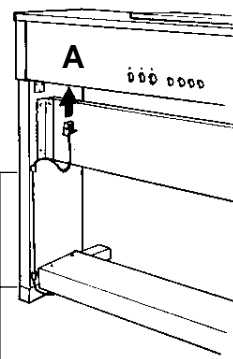
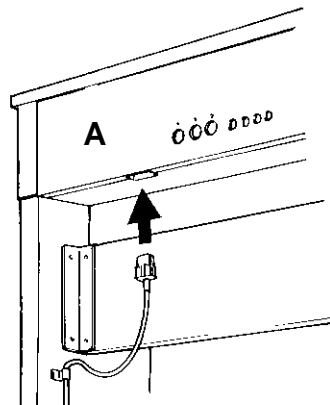
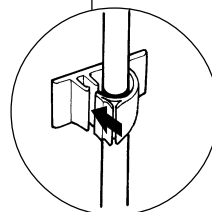
**CLP-154S**

Cord holder
Kabelhalter
Support de cordon
Soporte del cable

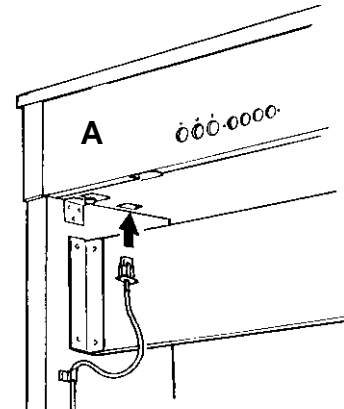

6 Connect the pedal cord.

Pass the pedal cord through the two cord holders on the side panel. Plug the free end of the cord into the connector on the bottom of the main unit (A). The plug only goes in one way (the lug on the CLP-155 connector should face the rear of the main unit, while that on the CLP-154S connector should face the opposite leg, as shown in the illustrations) — don't try to force it in the wrong way around.

7 Set the adjuster.

For stability, an adjuster is provided on the bottom of the pedal box (C). Rotate the adjuster until it comes in firm contact with the floor surface. The adjuster ensures stable pedal operation and facilitates pedal effect control. If the adjuster is not in firm contact with the floor surface, distorted sound may result.

**IMPORTANT**

- After assembling the Clavinova, check once more to make sure that all screws have been securely fastened.
- If the stand leans to the side, makes unusual noises, or otherwise seems unstable during use, check and tighten all screws while following the assembly instructions given above.

6 Schließen Sie das Pedalkabel an.

Sichern Sie das Pedalkabel in den beiden Kabelhaltern an den Seitenwänden. Der Stecker wird an die zugehörige Buchse an der Unterseite der Tastatureinheit (A) angeschlossen. Der Stecker paßt nur in einer Richtung in die Buchse (beim CLP-155 muß die Führungsnase nach hinten weisen und beim CLP-154S in Richtung der gegenüberliegenden Seitenwand — siehe Abbildung). Versuchen Sie nicht, den Stecker falsch herum mit Gewalt in die Buchse zu drücken!

7 Justieren Sie schließlich noch den Höhenversteller.

Zur Stabilisierung ist an der Unterseite des Pedalkastens (C) ein Höhenversteller vorgesehen. Schrauben Sie den Höhenversteller heraus, bis er fest auf dem Fußboden steht. Der Höhenversteller sorgt für stabile Pedalbetätigung und ermöglicht eine präzise Regelung des Betätigungshubs. Wenn er nicht fest auf dem Boden steht, können beim Treten der Pedale Klangverzerrungen auftreten.

**WICHTIG**

- Vergewissern Sie sich nach Zusammenbau und Aufstellung des Clavinova noch einmal davon, daß alle Schrauben fest angezogen sind.
- Wenn der Ständer schief steht, komische Geräusch erzeugt oder sich beim Spielen wackelig anfühlt, prüfen Sie gemäß den unter "Zusammenbau und Aufstellung" gegebenen Anweisungen, ob der Ständer richtig zusammengebaut wurde, und ziehen dabei die einzelnen Schrauben noch einmal nach.

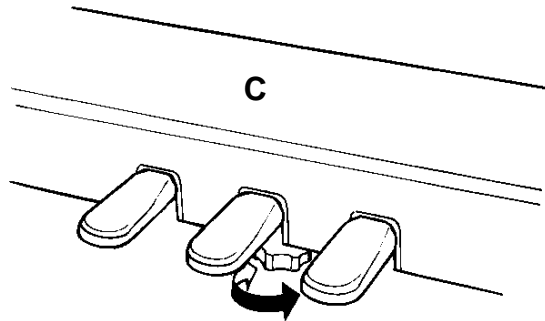

6 Connectez le cordon du pédalier

Faites passer le cordon du pédalier dans les deux supports de cordon situés sur le panneau latéral. La prise doit être branchée au connecteur correspondant situé à la partie inférieure du clavier (A). La prise ne peut être branchée que dans un seul sens (la languette de la prise du CLP-155 doit être dirigée vers l'arrière du clavier, alors que celle de la prise du CLP-154S doit être dirigée vers l'autre pied, comme montré sur les illustrations) et n'essayez donc pas de la forcer pour la mettre en place du mauvais côté.

7 N'oubliez pas de régler la hauteur du pédalier

Pour assurer la stabilité du pédalier (C), un dispositif de réglage a été prévu à sa partie inférieure. Tournez ce dispositif jusqu'à ce qu'il soit en contact ferme avec la surface du sol. Ce dispositif assure la stabilité du pédalier lors de son utilisation et facilite la commande au pied des effets. Si ce dispositif n'est pas en contact ferme avec le sol, il pourra se produire une distorsion du son.



- Après avoir assemblé le Clavinova, vérifiez une fois de plus que toutes les vis sont bien serrées.
- Si le support du clavier penche d'un côté, fait du bruit ou semble instable lorsque vous utilisez l'instrument, vérifiez de nouveau et resserrez toutes les vis en suivant les instructions d'assemblage données ci-dessus.

6 Conecte el cable de los pedales.

Pase el cable de los pedales a través de los dos soportes de cable del panel lateral. La clavija puede enchufarse en el conector correspondiente de la parte inferior de la unidad principal (A). La clavija se enchufa sólo en una dirección (la lengüeta del conector de la CLP-155 debe quedar encarada a la parte posterior de la unidad principal, mientras que en el conector de la CLP-154S debe quedar encarada a la pata opuesta, como se muestra en las ilustraciones), por eso no la fuerce en la dirección errónea.

7 Asegúrese de ajustar el ajustador.

Para la estabilidad del aparato, se proporciona un ajustador en la parte inferior de la caja de pedales (C). Gire el ajustador hasta que contacte firmemente con el suelo. El ajustador asegura una operación estable de los pedales y facilita el control del efecto de los pedales. Si el ajustador no contacta firmemente con el suelo, puede resultar en sonido distorsionado.



- Después de montar la Clavinova, compruebe otra vez para asegurarse de que todos los tornillos se han apretado bien.
- Si el soporte se inclina hacia un lado, hace ruidos anormales, o parece inestable durante la utilización, compruebe y apriete todos los tornillos mientras sigue las instrucciones de montaje de arriba.

MIDI Data Format/MIDI-Datenformat/Format des données MIDI/Formato de datos MIDI

If you're already very familiar with MIDI, or are using a computer to control your music hardware with computer-generated MIDI messages, the data provided in this section can help you to control the Clavinova.

Falls Sie bereits mit MIDI vertraut sind oder einen Computer zur Erzeugung von MIDI-Steuermeldungen für die Instrumente verwenden, können Sie sich zur Steuerung des Clavinovas nach den im folgenden Abschnitt aufgeführten Spezifikationen richten.

Si vous êtes très familier avec l'interface MIDI ou si vous utilisez un ordinateur pour commander votre matériel de musique au moyen de messages MIDI générés par ordinateur, les données suivantes vous seront utiles et vous aideront à commander le Clavinova.

Si usted está ya familiarizado con MIDI, o si emplea una computadora para controlar sus aparatos musicales con mensajes MIDI generados por computadora, los datos proporcionados en esta sección le ayudarán a controlar la Clavinova.

1. NOTE ON/OFF

Data format: [9nH] -> [kk] -> [vv]

9nH = Note ON/OFF event (n = channel number)
 kk = Note number (Transmit: 15 ~ 114 = D#-1 ~ F#7 /
 Receive: 21 ~ 108 = A-1 ~ C7)
 vv = Velocity (Key ON = 1 ~ 127. Key OFF = 0)

Data format: [8nH] -> [kk] -> [vv]

8nH = Note OFF event (n = channel number)
 kk = Note number (Transmit: 15 ~ 114 = D#-1 ~ F#7 /
 Receive: 21 ~ 108 = A-1 ~ C7)
 vv = Velocity (Key OFF = 0 ~ 127)

* Note OFF event format [8nH] -> [kk] also recognized (reception only).

2. CONTROL CHANGE & MODE MESSAGES

Data format: [BnH] -> [cc] -> [vv]

BnH = Control event (n = channel number)
 cc = Control number
 vv = Control value

| cc | CONTROL | VALUE [vv] |
|-----|--|--|
| 07H | Volume (reception only) | 00000000 : -∞ 01101111 : -3dB 01111111 : ±0dB |
| 0AH | Pan Pot (reception only) | 00H ~ 17H LEFT 6 18H ~ 1FH 5 20H ~ 27H 4 28H ~ 2FH 3 30H ~ 37H 2 38H ~ 3FH 1 40H ~ 47H CENTER 48H ~ 4FH SCALING PAN 50H ~ 57H RIGHT 1 58H ~ 5FH 2 60H ~ 67H 3 68H ~ 6FH 4 70H ~ 77H 5 78H ~ 7FH 6 |
| 0BH | Expression (reception only) | 00000000 : -∞ 01101111 : -3dB 01111111 : ±0dB |
| 40H | Damper Pedal | 00H ~ 7FH : eight levels (CLP-155) 00H ~ 3FH : OFF } (CLP-154S) 40H ~ 7FH : ON } |
| 42H | Sostenuto Pedal | 00H ~ 3FH : OFF 40H ~ 7FH : ON |
| 43H | Soft Pedal | 00H ~ 3FH : OFF 40H ~ 7FH : ON |
| 5BH | Reverb Depth | 00H ~ 7FH |
| 78H | All Sound OFF (reception only) | 00H |
| 79H | Reset AllController | 00H |
| 7AH | Local Control ON/OFF (reception only) | 00H : OFF 7FH : ON |
| 7BH | All Notes OFF (reception only) | 00H |
| 7CH | Omni OFF/All Notes OFF (reception only) | 00H |
| 7DH | Omni ON/All Notes OFF (reception only) | 00H |

3. PROGRAM CHANGE

Data format: [CnH] -> [pp]

CnH = program event (n = channel number)
 pp = Program number

| pp | CLP-155 VOICE | CLP-154S VOICE |
|----|--------------------------------------|----------------|
| 00 | PIANO 1 | PIANO 1 |
| 01 | PIANO 2 | PIANO 2 |
| 02 | CLAVINOVA TONE | CLAVINOVA TONE |
| 03 | E. PIANO | E. PIANO |
| 04 | HARPSICHORD | HARPSICHORD |
| 05 | VIBES | ORGAN |
| 06 | STRINGS | |
| 07 | ORGAN | |
| 08 | STRINGS SLOW ATTACK (reception only) | |

4. SYSTEM REALTIME MESSAGES

[rrH]
 F8H: Timing clock
 FAH: Start
 FCH: Stop
 FEH: Active sensing

| Data | Transmission | Reception |
|------|------------------------------------|--|
| F8H | Transmitted every 96 clocks | Received as 96-clock tempo timing when MIDI clock is set to External |
| FAH | Recorder start | Recorder start |
| FCH | Recorder stop | Recorder stop |
| FEH | Transmitted every 200 milliseconds | All notes are turned off if no data is received for more than 400 milliseconds |

* **Caution:** If an overrun framing error occurs the Damper, Sostenuto, and Soft effects for all channels are turned off and an All Note Off occurs.

5. SYSTEM EXCLUSIVE MESSAGES

(1) YAMAHA MIDI Format

Data format: [F0H] -> [43H] -> [xn] -> [ff] . . . [F7H]

43H : Yamaha
 xn : Substatus + channel number.
 ff : Format number.

x ff Information
 0 7CH Panel data receive.
 2 7CH Panel Data Send occurs when this data received.
 2 7DH Name Data Send occurs when this data received.

(2) Clavinova MIDI Format

Data format: [F0H] -> [43H] -> [73H] -> [xx] -> [yy] -> [F7H]

43H : Yamaha ID
 73H : Clavinova ID
 xx : 38H (CLP-154S ID), 38H (CLP-155 ID)
 yy : Substatus

yy Information
 02H Internal MIDI clock.
 03H External MIDI clock.
 13H Multi-timbre mode OFF.
 15H Multi-timbre mode ON.
 61H MIDI FA cancel ON.
 62H MIDI FA cancel OFF.
 7cH All notes OFF; receive channel = c+1; omni OFF.

(3) Special Control

Data format: [F0H] -> [43H] -> [73H] -> [xxH] -> [11H] -> [0nH] -> [ccH] -> [vvH] -> [F7H]

43H : Yamaha ID
 73H : Clavinova ID
 xx : 38H (CLP-154S ID), 38H (CLP-155 ID)
 11H : Clavinova special control
 0nH : Control MIDI change + channel number
 cc : Control number
 vv : Value

| cc | Control | Value [vv] |
|-----|----------------------|---|
| 08H | Dual Balance | 00H : Left Voice Max. 7FH : Right Voice Max. |
| 1BH | Metronome | 00H : Off 01H : On |
| 26H | Touch Sensitivity | 00H : Medium 01H : Soft 02H : Hard 03H : Off |
| 58H | Brilliance (CLP-155) | 00H : Normal 01H : Mellow 02H : Bright |
| 59H | Reverb | 00H : Off 01H : Room 02H : Hall-1 03H : Hall-2 04H : Cosmic |
| 5AH | Dual Mode | 00H : Dual Off 01H : Dual On (Normal) 02H : Dual On (Left voice 1 octave up) 03H : Dual On (Right voice 1 octave up) |
| 5CH | Dual Voice | [vvH] : Dual Voice |

(4) Absolute Tempo

Data format: [F0H] -> [43H] -> [73H] -> [xx] -> [11H] -> [1nH] -> [cc] -> [dd] -> [F7H]

43H : Yamaha ID
 73H : Clavinova ID
 xx : 38H (CLP-154S ID), 38H (CLP-155S ID)
 11H : Clavinova special control
 1nH : Control MIDI change
 (Transmit: n=control channel number)
 (Receive: any channel OK)
 ccH : Absolute tempo low byte
 ddH : Absolute tempo high byte Tempo=dd*128+cc

PANEL DATA FORMAT

F0H, 43H, 0nH, 7CH, 00H, 1BH (n: channel number)
 53H, 4BH, 20H, 20H (SK)
 43H, 4CH, 50H, 27H, 39H, 34H (CLP '94)
 3xH, 3yH (x, y: version number)
 [PANEL DATA]
 [CHECK SUM (1byte)] = 0-(53H+4BH+20H+.....+Data end)
 F7H

• Panel Data Contents

- (1) VOICE
- (2) DUAL VOICE
- (3) DUAL ON/OFF
- (4) DUAL BALANCE
- (5) 0 (CLP-154S)/BRILLIANCE (CLP-155)
- (6) 0
- (7) 0
- (8) REVERB NUMBER
- (9) REVERB DEPTH
- (10) TOUCH SENSITIVITY
- (11) 0
- (12) SPLIT POINT
- (13) 0
- (14) Absolute tempo low byte
- (15) Absolute tempo high byte

NAME DATA SEND FORMAT

F0H, 43H, 0nH, 7DH, 00H, 10H (n: channel number)
 53H, 4BH, 20H, 20H (SK)
 43H, 4CH, 50H, 27H, 39H, 34H (CLP '94)
 3xH, 3yH, 20H, 20H, 20H, 20H (x, y: version number)
 [CHECK SUM (1byte)] = 0-(53H+4BH+20H+.....+20H)
 F7H

BULK DUMP FORMAT

F0H, 43H, 73H
 38H (Product ID: CLP-154S/CLP-155)
 06H (Bulk ID)
 02H (Bulk number)
 0DH, 00H, 07H, 0CH (Data length= wxyzH 0x683e*2 bytes)
 [BULK DATA] (Sequence data)
 [CHECK SUM (1byte)] = 0-sum (BULK DATA)
 F7H

Specifications/Technische Daten/Caractéristiques techniques/Especificaciones

| | | CLP-154S | CLP-155 |
|---|------------------|---|---|
| KEYBOARD | | 88 KEYS (A-1 ~ C7) | |
| POLYPHONY | | 32 NOTES MAX. | |
| VOICE SELECTORS | | PIANO1, PIANO2, CLAVINOVA TONE, | PIANO1, PIANO2, CLAVINOVATONE, E. |
| PIANO, | | E. PIANO, HARPSICHORD, ORGAN | HARPSICHORD, VIBES, STRINGS, ORGAN |
| BRILLIANCE | | — | MELLOW, NORMAL, BRIGHT |
| REVERB | | ROOM, HALL 1, HALL 2, COSMIC | |
| TOUCH SENSITIVITY | | HARD, MEDIUM, SOFT, FIXED | |
| RECORDER | | 1, 2, PLAY, REC | |
| PEDAL CONTROLS | | SOFT, SOSTENUTO, DAMPER | |
| OTHER CONTROLS | | MASTER VOLUME, MIDI/TRANPOSE, METRONOME, TEMPO, DEMO | |
| JACKS/CONNECTORS | | PHONES x 2, AUX OUT R & L/L+R, AUX IN R & L, MIDI IN/OUT/THRU | |
| INPUT & OUTPUT LEVEL/IMPEDANCE | | AUX OUT: Output impedance 600Ω AUX IN: Input impedance 10 kΩ/Input sensitivity -10 dBm | |
| MAIN AMPLIFIERS | | 20W x 2 | 30W x 2 |
| SPEAKERS | | 13 cm x 2 | 13 cm x 2, 5 cm x 2 |
| DIMENSIONS (W x D x H) | Music stand down | 1414.0 x 500.0 x 890.8 mm (55-5/8" x 19-5/8" x 35") | 1414.0 x 500.0 x 890.8 mm (55-5/8" x 19-5/8" x 35") |
| | Music stand up | 1414.0 x 500.0 x 1060.9 mm (55-5/8" x 19-5/8" x 41-3/4") | 1414.0 x 500.0 x 1060.9 mm (55-5/8" x 19-5/8" x 41-3/4") |

Specifications subject to change without notice. 54.0 kPa output reserve de modification des caractéristiques sans préavis.
 * Änderungen ohne Vorankündigung vorbehalten. * Especificaciones sujetas a cambios sin previo aviso.

IMPORTANT SAFETY INSTRUCTIONS

INFORMATION RELATING TO PERSONAL INJURY, ELECTRICAL SHOCK, AND FIRE HAZARD POSSIBILITIES HAS BEEN INCLUDED IN THIS LIST.

WARNING- When using any electrical or electronic product, basic precautions should always be followed. These precautions include, but are not limited to, the following:

- 1.** Read all Safety Instructions, Installation Instructions, Special Message Section items, and any Assembly Instructions found in this manual BEFORE making any connections, including connection to the main supply.
- 2.** Main Power Supply Verification: Yamaha products are manufactured specifically for the supply voltage in the area where they are to be sold. If you should move, or if any doubt exists about the supply voltage in your area, please contact your dealer for supply voltage verification and (if applicable) instructions. The required supply voltage is printed on the name plate. For name plate location, please refer to the graphic found in the Special Message Section of this manual.
- 3.** This product may be equipped with a polarized plug (one blade wider than the other). If you are unable to insert the plug into the outlet, turn the plug over and try again. If the problem persists, contact an electrician to have the obsolete outlet replaced. Do NOT defeat the safety purpose of the plug.
- 4.** Some electronic products utilize external power supplies or adapters. Do NOT connect this type of product to any power supply or adapter other than one described in the owners manual, on the name plate, or specifically recommended by Yamaha.
- 5.** **WARNING:** Do not place this product or any other objects on the power cord or place it in a position where anyone could walk on, trip over, or roll anything over power or connecting cords of any kind. The use of an extension cord is not recommended! If you must use an extension cord, the minimum wire size for a 25' cord (or less) is 18 AWG. **NOTE:** The smaller the AWG number, the larger the current handling capacity. For longer extension cords, consult a local electrician.
- 6.** Ventilation: Electronic products, unless specifically designed for enclosed installations, should be placed in locations that do not interfere with proper ventilation. If instructions for enclosed installations are not provided, it must be assumed that unobstructed ventilation is required.
- 7.** Temperature considerations: Electronic products should be installed in locations that do not significantly contribute to their operating temperature. Placement of this product close to heat sources such as; radiators, heat registers and other devices that produce heat should be avoided.
- 8.** This product was NOT designed for use in wet/damp locations and should not be used near water or exposed to rain. Examples of wet/damp locations are; near a swimming pool, spa, tub, sink, or wet basement.
- 9.** This product should be used only with the components supplied or; a cart, rack, or stand that is recommended by the manufacturer. If a cart, rack, or stand is used, please observe all safety markings and instructions that accompany the accessory product.
- 10.** The power supply cord (plug) should be disconnected from the outlet when electronic products are to be left unused for extended periods of time. Cords should also be disconnected when there is a high probability of lightning and/or electrical storm activity.
- 11.** Care should be taken that objects do not fall and liquids are not spilled into the enclosure through any openings that may exist.
- 12.** Electrical/electronic products should be serviced by a qualified service person when:
 - a. The power supply cord has been damaged; or
 - b. Objects have fallen, been inserted, or liquids have been spilled into the enclosure through openings; or
 - c. The product has been exposed to rain; or
 - d. The product does not operate, exhibits a marked change in performance; or
 - e. The product has been dropped, or the enclosure of the product has been damaged.
- 13.** Do not attempt to service this product beyond that described in the user-maintenance instructions. All other servicing should be referred to qualified service personnel.
- 14.** This product, either alone or in combination with an amplifier and headphones or speaker/s, may be capable of producing sound levels that could cause permanent hearing loss. DO NOT operate for a long period of time at a high volume level or at a level that is uncomfortable. If you experience any hearing loss or ringing in the ears, you should consult an audiologist. **IMPORTANT:** The louder the sound, the shorter the time period before damage occurs.
- 15.** Some Yamaha products may have benches and/or accessory mounting fixtures that are either supplied as a part of the product or as optional accessories. Some of these items are designed to be dealer assembled or installed. Please make sure that benches are stable and any optional fixtures (where applicable) are well secured BEFORE using. Benches supplied by Yamaha are designed for seating only. No other uses are recommended.

PLEASE KEEP THIS MANUAL

FCC INFORMATION (U.S.A.)

1. IMPORTANT NOTICE: DO NOT MODIFY THIS UNIT!

This product, when installed as indicated in the instructions contained in this manual, meets FCC requirements. Modifications not expressly approved by Yamaha may void your authority, granted by the FCC, to use the product.

2. IMPORTANT: When connecting this product to accessories and/or another product use only high quality shielded cables. Cable/s supplied with this product MUST be used. Follow all installation instructions. Failure to follow instructions could void your FCC authorization to use this product in the USA.

3. NOTE: This product has been tested and found to comply with the requirements listed in FCC Regulations, Part 15 for Class "B" digital devices. Compliance with these requirements provides a reasonable level of assurance that your use of this product in a residential environment will not result in harmful interference with other electronic devices. This equipment generates/uses radio frequencies and, if not installed and used according to the instructions found in the users manual, may cause interference harmful to the operation of other electronic devices. Compliance

with FCC regulations does not guarantee that interference will not occur in all installations. If this product is found to be the source of interference, which can be determined by turning the unit "OFF" and "ON", please try to eliminate the problem by using one of the following measures:

Relocate either this product or the device that is being affected by the interference.

Utilize power outlets that are on different branch (circuit breaker or fuse) circuits or install AC line filter/s.

In the case of radio or TV interference, relocate/reorient the antenna. If the antenna lead-in is 300 ohm ribbon lead, change the lead-in to co-axial type cable.

If these corrective measures do not produce satisfactory results, please contact the local retailer authorized to distribute this type of product. If you can not locate the appropriate retailer, please contact Yamaha Corporation of America, Electronic Service Division, 6600 Orangethorpe Ave, Buena Park, CA90620

The above statements apply ONLY to those products distributed by Yamaha Corporation of America or its subsidiaries.

* This applies only to products distributed by YAMAHA CORPORATION OF AMERICA.

Wichtiger Hinweis für die Benutzung in der Bundesrepublik Deutschland.

Bescheinigung des Importeurs

Hiermit wird bescheinigt, daß der/die/das
Electronic Piano Typ: CLP-154S

(Gerät, Typ, Bezeichnung)
in Übereinstimmung mit den Bestimmungen der
VERFÜGUNG 1046/84

(Amtsblattverfügung)
funk-entstört ist.

Der Deutschen Bundespost wurde das Inverkehrbringen dieses Gerätes angezeigt und die Berechtigung zur Überprüfung der Serie auf Einhaltung der Bestimmungen eingeräumt.

Yamaha Europa GmbH

Name des Importeurs

Wichtiger Hinweis für die Benutzung in der Bundesrepublik Deutschland.

Bescheinigung des Importeurs

Hiermit wird bescheinigt, daß der/die/das
Electronic Piano Typ: CLP-155

(Gerät, Typ, Bezeichnung)
in Übereinstimmung mit den Bestimmungen der
VERFÜGUNG 1046/84

(Amtsblattverfügung)
funk-entstört ist.

Der Deutschen Bundespost wurde das Inverkehrbringen dieses Gerätes angezeigt und die Berechtigung zur Überprüfung der Serie auf Einhaltung der Bestimmungen eingeräumt.

Yamaha Europa GmbH

Name des Importeurs

• Dies bezieht sich nur auf die von der Yamaha Europa GmbH vertriebenen Produkte.

• Dies bezieht sich nur auf die von der Yamaha Europa GmbH vertriebenen Produkte.

CANADA

THIS DIGITAL APPARATUS DOES NOT EXCEED THE "CLASS B" LIMITS FOR RADIO NOISE EMISSIONS FROM DIGITAL APPARATUS SET OUT IN THE RADIO INTERFERENCE REGULATION OF THE CANADIAN DEPARTMENT OF COMMUNICATIONS.

LE PRESENT APPAREIL NUMERIQUE N'EMET PAS DE BRUITS RADIOELECTRIQUES DEPASSANT LES LIMITES APPLICABLES AUX APPAREILS NUMERIQUES DE LA "CLASSE B" PRESCRITES DANS LE REGLEMENT SUR LE BROUILLAGE RADIOELECTRIQUE EDICTE PAR LE MINISTERE DES COMMUNICATIONS DU CANADA.

CAUTION: TO PREVENT ELECTRIC SHOCK, MATCH WIDE BLADE OF PLUG TO WIDE SLOT, FULLY INSERT.

ATTENTION: POUR ÉVITER LES CHOCS ÉLECTRIQUES, INTRODUIRE LA LAME LA PLUS LARGE DE LA FICHE DANS LA BORNE CORRESPONDANTE DE LA PRISE ET POUSSER JUSQU'AU FOND.

• This applies only to products distributed by Yamaha Canada Music Ltd.
• Ceci ne s'applique qu'aux produits distribués par Yamaha Canada Musique Ltée.

Dit produkt is gefabriceerd in overeenstemming met de radiostoringsvoorschriften van de Richtlijn van de Raad (82/499/EEG).

ΑΥΤΗ Η ΣΥΣΚΕΥΗ ΑΝΤΑΠΟΚΡΙΝΕΤΑΙ ΣΤΙΣ ΑΠΑΙΤΗΣΕΙΣ ΤΩΝ ΟΔΗΓΙΩΝ ΤΗΣ ΕΥΡΩΠΑΙΚΗΣ ΟΙΚΟΝΟΜΙΚΗΣ ΚΟΙΝΟΤΗΤΑΣ 82/499/Ε.Ο.Κ..

Este produto está de acordo com o radio de interferencia frequente requeridos do Conselho Diretivo 82/499/EEC.

Dette apparat overholder det gældende EF-direktiv vedrørende radiostøj.

Cet appareil est conforme aux prescriptions de la directive communautaire 87/308/CEE.

Diese Geräte entsprechen der EG-Richtlinie 82/499/EWG und/oder 87/308/EWG.

This product complies with the radio frequency interference requirements of the Council Directive 82/499/EEC and/or 87/308/EEC.

Questo apparecchio è conforme al D.M.13 aprile 1989 (Direttiva CEE/87/308) sulla soppressione dei radiodisturbi.

Este producto está de acuerdo con los requisitos sobre interferencias de radio frecuencia fijados por el Consejo Directivo 87/308/CEE.

YAMAHA CORPORATION

IMPORTANT NOTICE FOR THE UNITED KINGDOM

Connecting the Plug and Cord

IMPORTANT. The wires in this mains lead are coloured in accordance with the following code:

BLUE : NEUTRAL
BROWN : LIVE

As the colours of the wires in the mains lead of this apparatus may not correspond with the coloured markings identifying the terminals in your plug proceed as follows:

The wire which is coloured BLUE must be connected to the terminal which is marked with the letter N or coloured BLACK.

The wire which is coloured BROWN must be connected to the terminal which is marked with the letter L or coloured RED.

Making sure that neither core is connected to the earth terminal of the three pin plug.

• This applies only to products distributed by Yamaha-Kemble Music (U.K.) Ltd.



Free Manuals Download Website

<http://myh66.com>

<http://usermanuals.us>

<http://www.somanuals.com>

<http://www.4manuals.cc>

<http://www.manual-lib.com>

<http://www.404manual.com>

<http://www.luxmanual.com>

<http://aubethermostatmanual.com>

Golf course search by state

<http://golfingnear.com>

Email search by domain

<http://emailbydomain.com>

Auto manuals search

<http://auto.somanuals.com>

TV manuals search

<http://tv.somanuals.com>