

YAMAHA Clavinova®

CLP-555

Owner's Manual Bedienungsanleitung Mode d'emploi Manual de instrucciones

IMPORTANT

Check Your Power Supply

Make sure that your local AC mains voltage matches the voltage specified on the name plate on the bottom panel. In some areas a voltage selector may be provided on the bottom panel of the main keyboard unit near the power cord. Make sure that the voltage selector is set for the voltage in your area. The voltage selector is set at 240V when the unit is initially shipped. To change the setting use a "minus" screwdriver to rotate the selector dial so that the correct voltage appears next to the pointer on the panel.

IMPORTANT

Contrôler la source d'alimentation

Vérifiez que la tension spécifiée sur le panneau arrière correspond à la tension du secteur. Dans certaines régions, l'instrument peut être équipé d'un sélecteur de tension situé sur le panneau inférieur du clavier à proximité du cordon d'alimentation. Vérifiez que ce sélecteur est bien réglé en fonction de la tension secteur de votre région. Le sélecteur de tension est réglé sur 240 V au départ d'usine. Pour modifier ce réglage, utilisez un tournevis à lame plate pour tourner le sélecteur afin de mettre l'indication correspondant à la tension de votre région vis à vis du repère triangulaire situé sur le panneau.

WICHTIG

Überprüfung der Stromversorgung

Vergewissern Sie sich vor dem Anschließen an das Stromnetz, daß die örtliche Netzspannung den Betriebsspannungswerten auf dem Typenschild an der Unterseite des Instruments entspricht. In bestimmten Verkaufsgebieten ist das Instrument mit einem Spannungswähler an der Unterseite neben der Netzkabeldurchführung ausgestattet. Falls vorhanden, muß der Spannungswähler auf die örtliche Netzspannung eingestellt werden. Der Spannungswähler wurde werkseitig auf 240 V voreingestellt. Zum Verstellen drehen Sie den Spannungsregler mit einem Schlitzschraubendreher, bis der Zeiger auf den korrekten Spannungswert weist.

IMPORTANTE

Verifique la alimentación de corriente

Asegúrese de que tensión de alimentación de CA de su área corresponde con la tensión especificada en la placa de características del panel inferior de la unidad del teclado principal, cerca del cable de alimentación. Asegúrese de que el selector de tensión esté ajustado a la tensión de su área. El selector de tensión se ajusta a 240V cuando la unidad sale de fábrica. Para cambiar el ajuste, emplee un destornillador de cabeza "recta" para girar el selector de modo que aparezca la tensión correcta al lado del indicador del panel.

SPECIAL MESSAGE SECTION

PRODUCT SAFETY MARKINGS: Yamaha electronic products may have either labels similar to the graphics shown below or molded/stamped facsimiles of these graphics on the enclosure. The explanation of these graphics appears on this page. Please observe all cautions indicated on this page and those indicated in the safety instruction section.

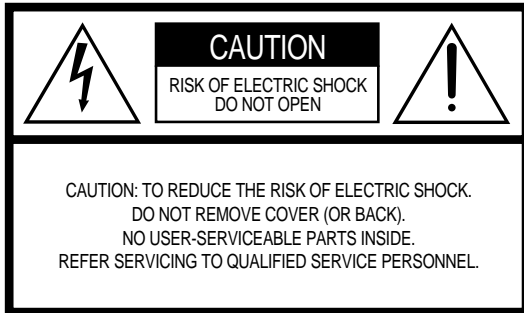

See bottom of Keyboard enclosure for graphic symbol markings



The exclamation point within the equilateral triangle is intended to alert the user to the presence of important operating and maintenance (servicing) instructions in the literature accompanying the product.

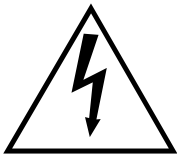

The lightning flash with arrowhead symbol, within the equilateral triangle, is intended to alert the user to the presence of uninsulated "dangerous voltage" within the product's enclosure that may be of sufficient magnitude to constitute a risk of electrical shock.

IMPORTANT NOTICE: All Yamaha electronic products are tested and approved by an independent safety testing laboratory in order that you may be sure that when it is properly installed and used in its normal and customary manner, all foreseeable risks have been eliminated. **DO NOT** modify this unit or commission others to do so unless specifically authorized by Yamaha. Product performance and/or safety standards may be diminished. Claims filed under the expressed warranty may be denied if the unit is/has been modified. Implied warranties may also be affected.

SPECIFICATIONS SUBJECT TO CHANGE: The information contained in this manual is believed to be correct at the time of printing. However, Yamaha reserves the right to change or modify any of the specifications without notice or obligation to update existing units.

ENVIRONMENTAL ISSUES: Yamaha strives to produce products that are both user safe and environmentally friendly. We sincerely believe that our products and the production methods used to produce them, meet these goals. In keeping with both the letter and the spirit of the law, we want you to be aware of the following:

Battery Notice: This product MAY contain a small non-rechargeable battery which (if applicable) is soldered in place. The average life span of this type of battery is approximately five years. When replacement becomes necessary, contact a qualified service representative to perform the replacement.

Warning: Do not attempt to recharge, disassemble, or incinerate this type of battery. Keep all batteries away from children. Dispose of used batteries promptly and as regulated by applicable laws. Note: In some areas, the servicer is required by law to return the defective parts. However, you do have the option of having the servicer dispose of these parts for you.

Disposal Notice: Should this product become damaged beyond repair, or for some reason its useful life is considered to be at an end, please observe all local, state, and federal regulations that relate to the disposal of products that contain lead, batteries, plastics, etc.

NOTICE: Service charges incurred due to lack of knowledge relating to how a function or effect works (when the unit is operating as designed) are not covered by the manufacturer's warranty, and are therefore the owners responsibility. Please study this manual carefully and consult your dealer before requesting service.

NAME PLATE LOCATION: The graphic below indicates the location of the name plate. The model number, serial number, power requirements, etc., are located on this plate. You should record the model number, serial number, and the date of purchase in the spaces provided below and retain this manual as a permanent record of your purchase.

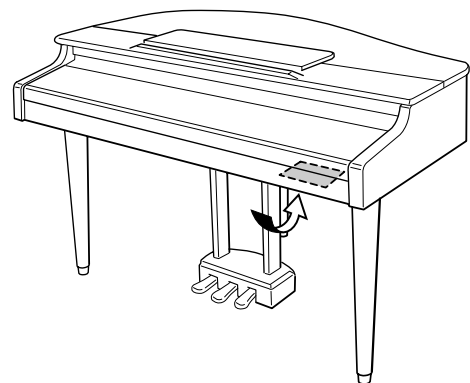

Model _____

Serial No. _____

Purchase Date _____

PRECAUTIONS

PLEASE READ CAREFULLY BEFORE PROCEEDING

* Please keep these precautions in a safe place for future reference.



WARNING

Always follow the basic precautions listed below to avoid the possibility of serious injury or even death from electrical shock, short-circuiting, damages, fire or other hazards. These precautions include, but are not limited to, the following:

- Do not open the instrument or attempt to disassemble the internal parts or modify them in any way. The instrument contains no user-serviceable parts. If it should appear to be malfunctioning, discontinue use immediately and have it inspected by qualified Yamaha service personnel.
- Do not expose the instrument to rain, use it near water or in damp or wet conditions, or place containers on it containing liquids which might spill into any openings.
- If the power cord or plug becomes frayed or damaged, or if there is a sudden loss of sound during use of the instrument, or if any unusual smells or smoke should appear to be caused by it, immediately turn off the power switch, disconnect the electric plug from the outlet, and have the instrument inspected by qualified Yamaha service personnel.
- Only use the voltage specified as correct for the instrument. The required voltage is printed on the name plate of the instrument.
- Before cleaning the instrument, always remove the electric plug from the outlet. Never insert or remove an electric plug with wet hands.
- Check the electric plug periodically and remove any dirt or dust which may have accumulated on it.



CAUTION

Always follow the basic precautions listed below to avoid the possibility of physical injury to you or others, or damage to the instrument or other property. These precautions include, but are not limited to, the following:

- Do not place the power cord near heat sources such as heaters or radiators, and do not excessively bend or otherwise damage the cord, place heavy objects on it, or place it in a position where anyone could walk on, trip over, or roll anything over it.
 - When removing the electric plug from an outlet, always hold the plug itself and not the cord. Pulling by the cord can damage it.
 - Do not connect the instrument to an electrical outlet using a multiple-connector. Doing so can result in lower sound quality, or possibly cause overheating in the outlet.
 - Remove the electric plug from the outlet when the instrument is not to be used for extended periods of time, or during electrical storms.
 - Before connecting the instrument to other electronic components, turn off the power for all components. Before turning the power on or off for all components, set all volume levels to minimum.
 - Do not expose the instrument to excessive dust or vibrations, or extreme cold or heat (such as in direct sunlight, near a heater, or in a car during the day) to prevent the possibility of panel disfiguration or damage to the internal components.
 - Do not use the instrument near other electrical products such as televisions, radios, or speakers, since this might cause interference which can affect proper operation of the other products.
 - Do not place the instrument in an unstable position where it might accidentally fall over.
 - Before moving the instrument, remove all connected cables.
 - When cleaning the instrument, use a soft, dry cloth. Do not use paint thinners, solvents, cleaning fluids, or chemical-impregnated wiping cloths. Also, do not place vinyl or plastic objects on the instrument, since this might discolor the panel or keyboard.
 - Gently remove dust and dirt with a soft cloth. Do not wipe too hard since small particles of dirt can scratch the instrument's finish.
 - Bumping the surface of the instrument with metal, porcelain, or other hard objects can cause the finish to crack or peel. Use caution.
 - Do not rest your weight on, or place heavy objects on the instrument, and do not use excessive force on the buttons, switches or connectors.
 - Take care that the key cover does not pinch your fingers, and do not insert a finger or hand in the key cover gap.
 - Never insert or drop paper or metallic or other objects between the slits of the key cover and the keyboard. If this happens, immediately turn off the power and remove the electric plug from the outlet and have the instrument inspected by qualified Yamaha service personnel.
 - Do not place the instrument against a wall (allow at least 3 cm/one-inch from the wall), since this can cause inadequate air circulation, and possibly result in the instrument overheating.
 - Read carefully the attached documentation explaining the assembly process. Failure to assemble the instrument in the proper sequence might result in damage to the instrument or even injury.
 - Do not operate the instrument for a long period of time at a high or uncomfortable volume level, since this can cause permanent hearing loss. If you experience any hearing loss or ringing in the ears, consult a physician.
- **USING THE BENCH (if included)**
- Do not play carelessly with or stand on the bench. Using it as a tool or step-ladder or for any other purpose might result in accident or injury.
 - Only one person should sit on the bench at a time, in order to prevent the possibility of accident or injury.
 - Do not attempt to adjust the bench height while sitting on the bench, since this can cause excessive force to be imposed on the adjustment mechanism, possibly resulting in damage to the mechanism or even injury.
 - If the bench screws become loose due to extensive long-term use, tighten them periodically using the included tool.
- **SAVING USER DATA**
- Save all data to an external device such as the Yamaha DOU-10 Disk Orchestra Unit in order to help prevent the loss of important data due to a malfunction or user operating error.
- Yamaha cannot be held responsible for damage caused by improper use or modifications to the instrument, or data that is lost or destroyed.

Always turn the power off when the instrument is not in use.

Introduction

Thank you for choosing a Yamaha CLP-555 Clavinova. Your Clavinova is a fine musical instrument that employs advanced Yamaha music technology. With the proper care, your Clavinova will give you many years of musical pleasure.

- Yamaha's AWM (Advanced Wave Memory) tone generator system offers rich, realistic voices. Both models feature stereo sampling of the piano voices for unmatched realism and expressive power.
- Piano-like touch response — adjustable in 4 stages — provides extensive expressive control and outstanding playability.
- Dual mode allows 2 voices to be played simultaneously.
- Split mode allows different voices to be played by the left and right hands.
- Unique Clavinova Tone voice provides a fresh sound for new musical expression.
- Metronome feature with variable tempo facilitates practice.
- Digital recorder lets you record and play back anything you play on the keyboard (up to approximately 4,200 notes).
- MIDI compatibility and a range of MIDI functions make the Clavinova useful in a range of advanced MIDI music systems.
- Built-in computer interface for direct connection to personal computers running advanced music software.

In order to make the most of your Clavinova's performance potential and features, we urge you to read this Owner's Manual thoroughly, and keep it in a safe place for later reference.

The Control Panel	4
Preparation	6
■ The Music Stand	6
■ The Key Cover	6
■ Opening and Closing the Lid	6
Connections	7
Selecting & Playing Voices	8
Playing the Demonstration Tunes	9
■ Piano Song A-B Repeat	10
■ Piano Song Part Cancel	11
• Synchro Start	11
• Left Pedal Start/Stop	11
The Dual Mode	12
• Other Dual Mode Functions	12
The Split Mode	13
• Selecting the Left-hand Voice	13
• Setting the Split Point	13
• Other Split Mode Functions	13
Reverb	14
• Adjusting Reverb Depth	14
The Chorus Effect	15
• Adjusting Effect Depth	15
The Pedals	15
• Soft (Left) Pedal	15
• Sostenuto (Center) Pedal	15
• Damper (Right) Pedal	15
Touch Sensitivity	16
Transposition	16

Contents

Tuning	17
• Tuning Up	17
• Tuning Down	17
• To Restore Standard Pitch	17
The Metronome & Tempo Control	18
■ The Metronome	18
• Metronome Volume	18
• Other Metronome Functions	18
■ Tempo Control	18
Using the Recorder	19
■ Recording	19
• Changing the Initial Settings	20
• Erasing a Single Track	20
■ Playback	21
• Synchro Start	21
• Left Pedal Start/Stop	21
The Function Mode	22
• To Select a Function	22
■ F1: Tuning	23
■ F2: Scale	23
■ F3: Dual Mode Functions	24
F3.1: Dual Balance	24
F3.2: Dual Detune	24
F3.3: 1st Voice Octave Shift	24
F3.4: 2nd Voice Octave Shift	24
F3.5: 1st Voice Effect Depth	25
F3.6: 2nd Voice Effect Depth	25
F3.7: Slow-attack Strings	25
F3.8: Reset	25
■ F4: Split Mode Functions	25
F4.1: Split Point	25
F4.2: Split Balance	26
F4.3: Right Voice Octave Shift	26
F4.4: Left Voice Octave Shift	26
F4.5: Right Voice Effect Depth	26
F4.6: Left Voice Effect Depth	26
F4.7: Damper Mode	26
F4.8: Reset	26
■ F5: Metronome Functions	27
F5.1: Beat	27
F5.2: Volume	27
■ F6: Left Pedal Mode	27
■ F7: Piano Song Part Cancel Volume	27
■ F8: MIDI Functions	28
• A Brief Introduction to MIDI	28
F8.1: MIDI Transmit Channel Selection	28
F8.2: MIDI Receive Channel Selection	28
F8.3: Local Control ON/OFF	29
F8.4: Program Change ON/OFF	29
F8.5: Control Change ON/OFF	30
F8.6: MIDI Transmit Transpose	30
F8.7: Panel/Status Transmit	30
F8.8: Bulk Data Dump	30
■ F9: Backup Functions	31
F9.1: Voice	31
F9.2: MIDI	31
F9.3: Tuning	31
F9.4: Pedal	31
Connecting to a Personal Computer	32
• Connecting to an Apple Macintosh Series Computer	32
• Connecting to an IBM-PC/AT Series Computer	33
• Connecting to an NEC PC-9801/9821 Series Computer	33
Troubleshooting	34
Factory Preset Recall	34
Options & Expander Modules	34
MIDI Data Format	35
MIDI Implementation Chart	39
Keyboard Stand Assembly	40
Demo Song List	48
Default Setting List	48
Specifications	49

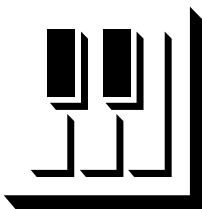

The Control Panel

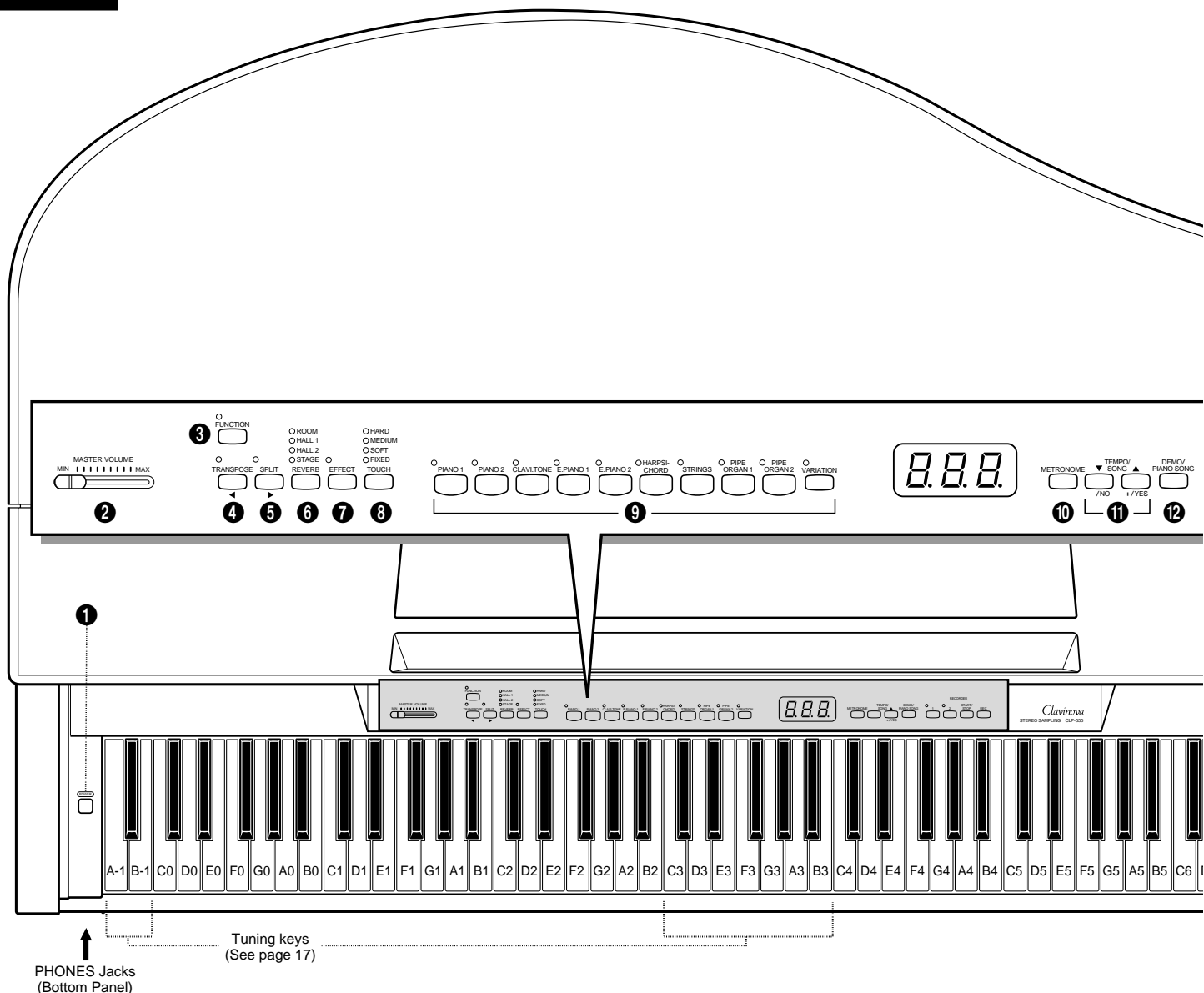

1 [POWER] Switch

Press the [POWER] switch once to turn the power ON, a second time to turn the power OFF. When the power is initially turned ON, a voice selector LED will light, and the power indicator located below the left end of the keyboard will light.

2 [MASTER VOLUME] Control

The [MASTER VOLUME] control adjusts the volume (level) of sound produced by the Clavinova's internal stereo sound system. The [MASTER VOLUME] control also adjusts headphone volume when a pair of headphones is plugged into the PHONES jack (page 7).

3 [FUNCTION] Button

This button accesses a range of utility functions — including the MIDI functions — that significantly enhance versatility and playability. See page 22 for details.

4 [TRANSPOSE] Button

The [TRANSPOSE] button allows access to the Clavinova's TRANSPOSE function (to shift the pitch of the entire keyboard up or down in semitone intervals).

5 [SPLIT] Button

Engages the split mode, in which different voices can be played on the left- and right-hand sections of the keyboard. See page 13 for details.

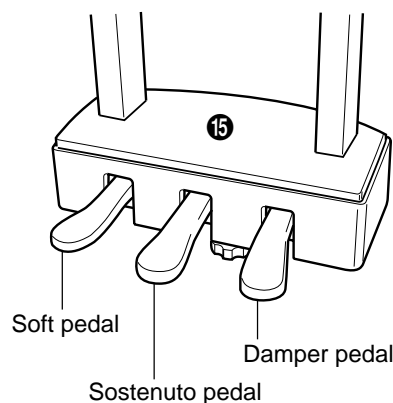
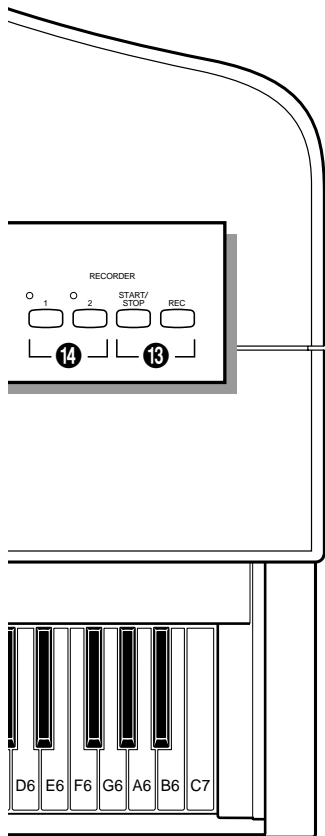

6 [REVERB] Button

The [REVERB] button selects a number of digital reverb effects that you can use for extra depth and expressive power. See page 14 for details.

7 [EFFECT] Button

This button engages a chorus effect which can give your sound greater depth and animation.

8 [TOUCH] Button

The [TOUCH] button makes it easy to adjust the touch response of the Clavinova to match your playing style. See page 16 for details.

9 Voice Selectors & [VARIATION] Button

The CLP-555 has nine voice selectors and a [VARIATION] button. Simply press any of the voice

selectors to select the corresponding voice. The voice selector LED will light to indicate which voice is currently selected. Press the [VARIATION] button so that its indicator lights to select a variation of the currently selected voice.

There is also a dual mode in which two voices can be played simultaneously across the full range of the keyboard (see page 12 for details), and a split mode which allows different voices to be played by the left and right hands (see page 13 for details).

10 [METRONOME] Button

Turns the metronome sound on and off. The [TEMPO/SONG] buttons, below, are used to set the tempo of the metronome sound, and the volume of the metronome sound if used while the [METRONOME] button is held — page 18.

11 [TEMPO/SONG] (-/NO, +/YES) Buttons

These buttons adjust the tempo of the metronome function as well as the playback tempo of the recorder function. The tempo range is from 32 to 280 beats per minute — page 18. These same buttons are also used to select a piano song number for playback — page 9. The [TEMPO/SONG] buttons are also used to adjust a range of other parameters (i.e. their “-/NO” and “+/YES” functions).

12 [DEMO/PIANO SONG] Button

Activates the demo playback mode in which you can select playback of different demonstration sequences for each of the Clavinova’s voices, and a range of 30 piano songs. See page 9 for details.

13 RECORDER [START/STOP] and [REC] Buttons

These buttons control the Clavinova’s recorder, letting you record and play back just about anything you play on the keyboard — up to a maximum of about 4,200 notes. See page 19 for details.

14 RECORDER [1] and [2] Buttons

The CLP-555 has a 2-track recorder, and these buttons are used to select the track(s) to be recorded or played back. See page 19 for details.

15 Pedals

The soft (left), sostenuto (center) and damper (right) pedals provide a range of expressive control capabilities similar to the pedal functions on an acoustic piano. See page 15 for details.

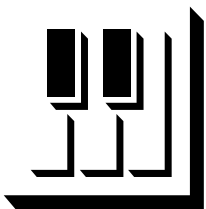

Preparation

The Music Stand

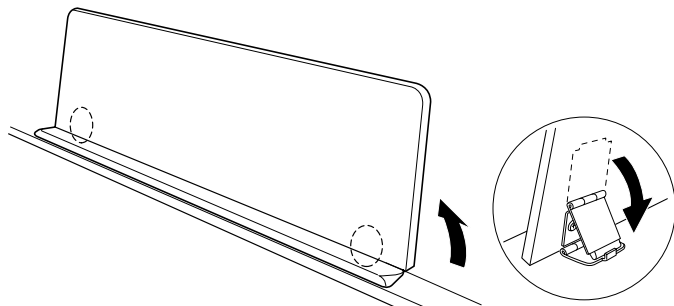

If you will be using sheet music with your Clavinova, raise the music stand built into its top panel by lifting the rear edge of the music stand, then flip down the music stand braces and engage them with the corresponding recesses.

The music stand can be lowered after slightly lifting it and folding the two brackets which support it against the back of the stand.

The Key Cover

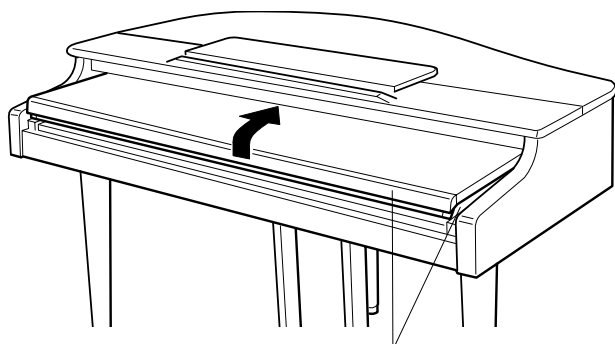

Be careful of fingers when opening or closing.

To open the CLP-555 key cover lift it just enough to clear the keys (do not lift excessively) then slide the cover back into the main unit. To close the cover slide it forward all the way and then lower it gently until it closes completely.



- Hold the cover with both hands when moving it, and do not release it until it is fully opened or closed. Be careful to avoid catching fingers (yours or others) between the cover and main unit.
- Do not place objects on top of the key cover. Small objects placed on the key cover may fall inside the main unit when the cover is opened.

Opening and Closing the Lid

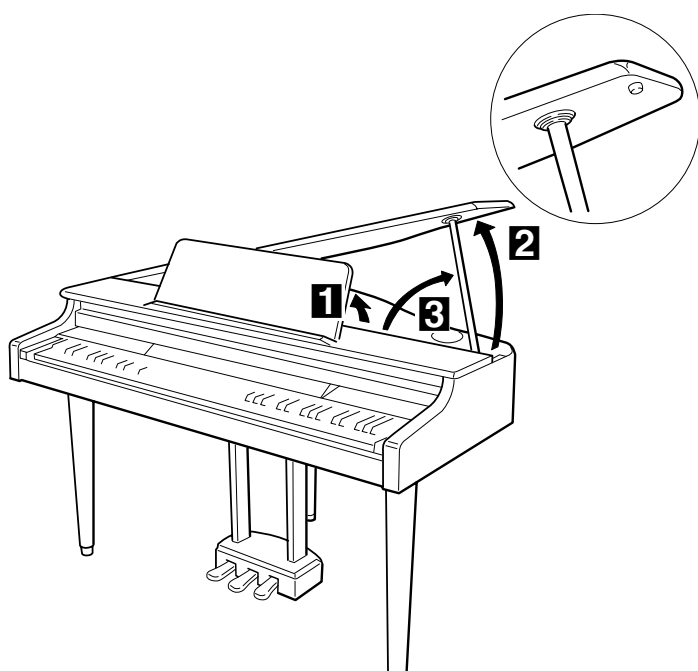

1 Raise the music stand as described in “The Music Stand”, above.

2 Raise and hold the right side of the lid (viewed from the keyboard end of the instrument).

3 Raise the lid stay and carefully lower the lid so that the end of the stay fits into the recess in the lid.



- Make sure that the end of the stay fits securely in the lid recess. If the stay is not properly seated in the recess the lid may fall causing damage or injury.
- Be careful that you or others do not bump the stay while the lid is raised. The stay may be bumped out of the lid recess causing the lid to fall.
- Be careful not to catch your fingers when raising or lowering the lid.

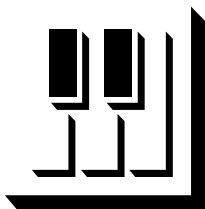

Connections

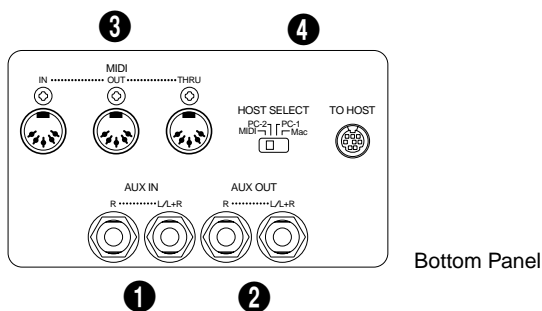

Bottom Panel

1 AUX IN L/L+R and R Jacks

These jacks are intended for use with an external tone generator module such as the Yamaha DOU-10 Disk Orchestra Unit. The stereo outputs from the external tone generator module are connected to the AUX IN L/L+R and R jacks, allowing the sound of the tone generator to be reproduced via the Clavinova's internal sound system and speakers. A line-level mono source can be connected to the L/L+R jack.



The input signal from the AUX IN jacks is delivered to the AUX OUT jacks, but is not affected by the Clavinova's volume control or reverb effect.

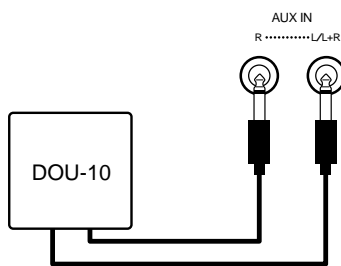

2 AUX OUT L/L+R and R Jacks

The AUX OUT L/L+R and R jacks deliver the output of the Clavinova for connection to an instrument amplifier, mixing console, PA system, or recording equipment. If you will be connecting the Clavinova to a monaural sound system, use only the L/L+R jack. When a plug is inserted into the L/L+R jack only, the left- and right-channel signals are combined and delivered via the L/L+R jack so you don't lose any of the Clavinova's sound.



The AUX OUT jack signal must never be returned to the AUX IN jacks, either directly or through external equipment.

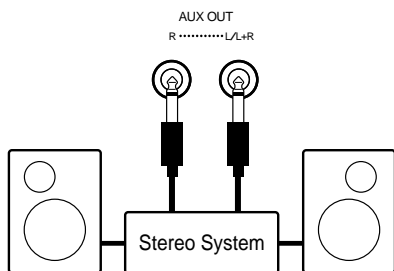

3 MIDI IN, THRU and OUT Connectors

The MIDI IN connector receives MIDI data from an external MIDI device (such as the DOU-10 Disk Orchestra Unit) which can be used to control the Clavinova. The MIDI THRU connector re-transmits any data received at the MIDI IN connector, allowing "chaining" of several MIDI instruments or other devices. The MIDI OUT connector transmits MIDI data generated by the Clavinova (e.g. note and velocity data produced by playing the Clavinova keyboard).

More details on MIDI are given in "MIDI FUNCTIONS" on page 28.

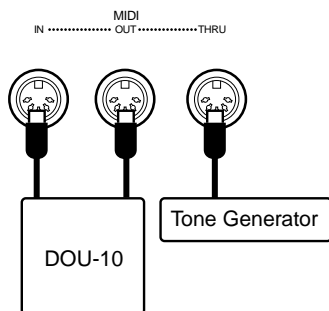

4 TO HOST Connector & HOST SELECT Switch

This jack and selector switch allow direct connection to a personal computer for sequencing and other music applications — without the need for a separate MIDI interface. See page 32 for details.

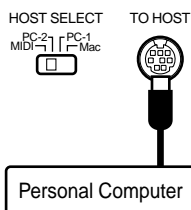

PHONES Jacks (Bottom Panel)

Two pairs of standard pair of stereo headphones can be plugged in here for private practice or late-night playing. The internal speaker system is automatically shut off when a pair of headphones is plugged into either of the PHONES jacks.

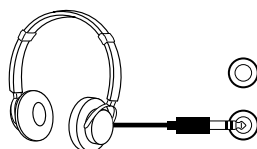

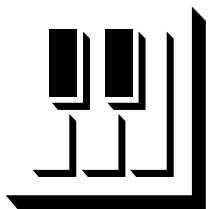

Selecting & Playing Voices

1 Turn Power On

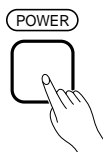

After making sure that the Clavinova's AC cord is properly plugged into the Clavinova itself and plugged into a convenient AC wall outlet, press the **[POWER]** switch located to the left of the keyboard to turn the power ON.

When the power is turned ON, one of the voice selector LEDs will light.

2 Set the Volume

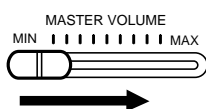

Initially set the **[MASTER VOLUME]** control about half way between the "MIN" and "MAX" settings. Then, when you start playing, re-adjust the **[MASTER VOLUME]** control for the most comfortable listening level.

3 Select a Voice

Select the desired voice by pressing one of the voice selectors. Use the **[VARIATION]** button to select a variation of the current voice, as required.

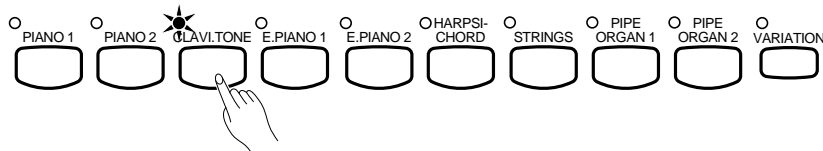

4 Play

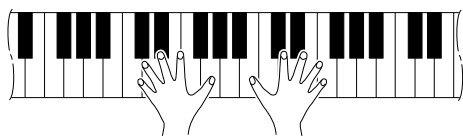

The Clavinova also offers keyboard touch response, so the volume and timbre of notes played can be controlled according to how "hard" you play the keys. The amount of variation available depends on the selected voice.

5 Add Effects As Required

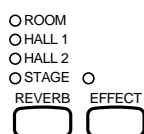

You can also change add reverb and/or a chorus effect as desired by using the **[REVERB]** and **[EFFECT]** buttons (see page 14 for **[REVERB]** button operation, and page 15 for **[EFFECT]** button operation).

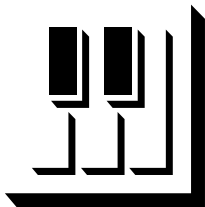

Playing the Demonstration Tunes

Demonstration tunes are provided that effectively demonstrate each of the Clavinova's voices. There are also 30 piano songs that you can play individually, all in sequence, or in random order. Here's how you can select and play the demo tunes.



1) Engage the Demo Mode

Press the [DEMO/PIANO SONG] button to engage the demo mode — the voice selector indicators will flash in sequence.



2) Play a Voice Demo or Piano Song

● Voice Demo Playback

Press one of the voice selectors to start playback of the corresponding voice demo tune — featuring the voice normally selected by that voice selector button. The indicator of the selected voice selector button will flash during playback, and “- - -” (relative tempo) will appear on the LED display. You can start playback of any other voice demo tune during playback by simply pressing the corresponding voice selector. You can stop playback at any time by pressing the [START/STOP] button, the voice selector of the currently playing demo.

● Piano Song Playback

To play any of the 30 piano songs provided, use the [TEMPO/SONG] buttons to select the number of the tune you want to play (the number will appear on the LED display), then press the [START/STOP] button. Playback will stop automatically when playback of the selected piano song has finished. To randomly select and play one of the piano songs press the [VARIATION] button while playback is stopped.

Select “ALL” instead of a number to play all piano songs and voice demo tunes in sequence, or select “rand” to continuously play all piano songs and voice demo tunes in random order. The [VARIATION] button indicator will flash during playback. Press the [START/STOP] button to stop playback. If a voice selector is pressed while “ALL” is showing on the display, playback will begin from the corresponding song.

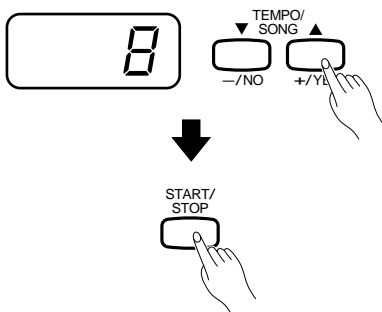

NOTE

- While a voice demo or piano song is playing, you can use the [TEMPO/SONG] buttons to adjust the playback tempo as required. This produces a relative tempo variation, with a range from “-99” through “- - -” to “99”.
- Use the [MASTER VOLUME] control to adjust the volume.
- The demo mode cannot be engaged while the recorder (page 19) is in use.
- The default tempo is automatically selected whenever a new song is selected, or playback of a new song begins during “ALL” or “rand” playback.
- No MIDI reception occurs in the demo mode.
- The demo/piano song data is not transmitted via the MIDI connectors.

* See page 48 for a complete listing of the demo tunes.



3) Exit From the Demo Mode

After stopping demo playback, press the [DEMO/PIANO SONG] button to exit from the demo mode and return to the normal play mode.

Piano Song A-B Repeat

The A-B Repeat function can be used to continuously repeat a specified phrase within a piano song. Combined with the Part Cancel function described below, this provides an excellent way to practice difficult phrases.

1 Specify the Beginning (A) of the Phrase

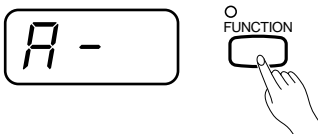

Select and play a piano song, then press the [FUNCTION] button at the beginning of the phrase you want to repeat. This sets the "A" point ("A -" will appear on the display).

To set the "A" point at the very beginning of the song, press the [FUNCTION] button before starting playback.

2 Specify the End (B) of the Phrase

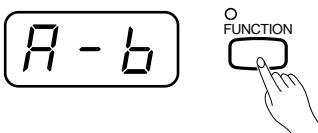

Press the [FUNCTION] button a second time at the end of the phrase. This sets the "B" point ("A - b" will appear on the display). At this point repeat playback will begin between the specified A and B points.

3 Stop Playback

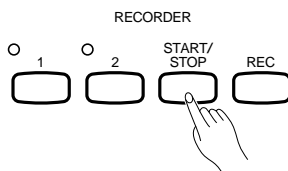

Press the [START/STOP] button to stop playback while retaining the specified A and B points. A-B repeat playback will resume if the [START/STOP] button is then pressed again.

To cancel the A and B points press the [FUNCTION] button once.



- The A and B points are automatically canceled when a new song is selected.
- The A-B Repeat function cannot be used during "RL L" or "r n d" playback.

Piano Song Part Cancel

The 30 piano songs have separate left- and right-hand parts that can be turned on and off as required so you can practice the corresponding part on the keyboard. The right-hand part is played by the recorder's [1] track, and the left-hand part is played by recorder's [2] track.

1 Turn the Desired Part Off

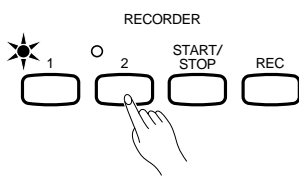

Press the **RECORDER** [1] or [2] button to turn the corresponding part off — the corresponding indicator will go out (these buttons alternately toggle the corresponding part on and off).



- The parts can be turned on or off even during playback.
- The Piano Song Part Cancel function cannot be used during "RL" or "rd" playback.
- The "Piano Song Part Cancel Volume" function described on page 27 can be used to set the canceled part so that it plays at a volume from "0" (no sound) to "20". The default setting is "5".
- Both parts are automatically turned ON whenever a new song is selected.

2 Start/Stop Playback

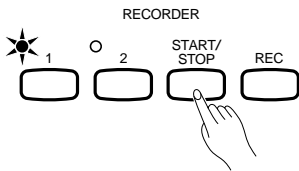

Press the [START/STOP] button to start and stop playback as required.

3 Synchro Start

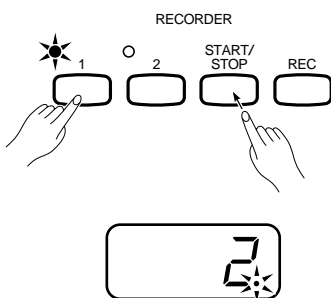

When the Synchro Start function is engaged, playback of the selected piano song will begin automatically as soon as you start playing on the keyboard.

To engage the Synchro Start function press the [START/STOP] button while holding the part button corresponding to the part which is ON. The rightmost dot on the display will light. Playback will then start as soon as you begin playing on the keyboard.



- If you hold a track button which is OFF while pressing the [START/STOP] button, that track will be turned ON and the Synchro Start mode will be engaged.

4 Left Pedal Start/Stop

The left pedal can be assigned to start and stop piano song playback via the "Left Pedal Mode" function described on page 27.

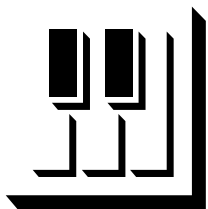

The Dual Mode

The dual mode makes it possible to play two voices simultaneously across the entire range of the keyboard.

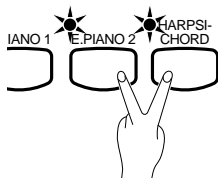

To activate the dual mode simply press two voice selectors at the same time (or press one voice selector while holding another). The voice indicators of both selected voices will light when the dual mode is active. To return to the normal single-voice play mode, press any single voice selector.



- The dual and split modes cannot be engaged at the same time.
- The [VARIATION] button indicator will light if the variation is engaged for either or both of the dual-mode voices. While the dual mode is engaged the [VARIATION] button can be used to turn the variation for both voices on or off. To use the variation for only one of the voices the setting must be made prior to engaging the dual mode.
- The chorus effect will apply to both the dual mode voices as specified after engaging the dual mode (the default effect on/off and depth settings are different for each voice combination). The effect depth for the dual mode voices can be individually set via the Dual Mode "1st Voice Effect Depth" and "2nd Voice Effect Depth" functions described on page 25.



Other Dual Mode Functions

The CLP-555 Function mode provides access to a number of other dual-mode functions, listed below. See the corresponding pages for details.

- Dual Balance 24
- Dual Detune 24
- 1st Voice Octave Shift 24
- 2nd Voice Octave Shift 24
- 1st Voice Effect Depth 25
- 2nd Voice Effect Depth 25
- Slow-attack Strings 25
- Reset 25

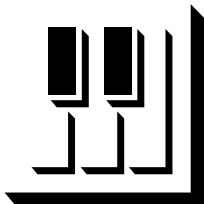

The Split Mode

The split mode makes it possible to play two different voices on the keyboard — one with the left hand and another with the right hand. The left-hand voice is played on all keys to the left of (and including) a specified “split point” key, while the right-hand voice is played on all keys to the right of the split point key.

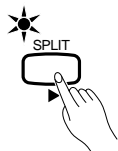

To activate the split mode simply press the [SPLIT] button so that its indicator lights. The split mode can be turned off at any time by pressing the [SPLIT] button again so that its indicator goes out.



• The dual and split modes cannot be engaged at the same time.

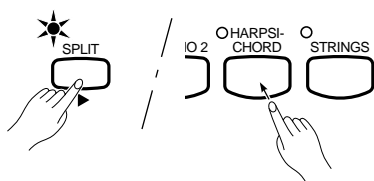

Selecting the Left-hand Voice

The voice that was selected before the split mode was engaged becomes the right-hand voice in the split mode. To select a left-hand voice press the corresponding voice selector while holding the [SPLIT] button. The indicator of the left-hand voice selector will light while it is pressed, then only the right-hand voice selector and [SPLIT] button indicators will remain lit.



- The variation can be individually turned on and off for the split mode voices. Normally the voice indicator of the right-hand voice lights in the split mode. The [VARIATION] can be used to turn the variation for the right-hand voice on or off as required. While the [SPLIT] button is held, however, the voice indicator of the left-hand voice lights, and in this state the [VARIATION] button can be used to turn the variation for the left-hand voice on or off as required.
- The chorus effect will apply to both the split mode voices as specified after engaging the split mode (the default effect on/off and depth settings are different for each voice combination). The effect depth for the split mode voices can be individually set via the Split Mode “Left Voice Effect Depth” and “Right Voice Effect Depth” functions described on page 26.

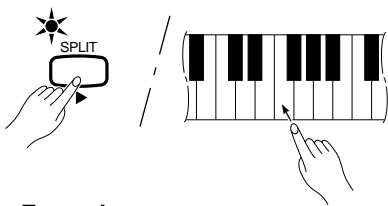

Example:

A-1	B-1	C2	F#2
A-1	B \flat -1	C2	F#2

Setting the Split Point

The split point is initially set at the F#2 key by default. You can reset the split point to any other key by pressing the key while holding the [SPLIT] button (the name of the current split-point key appears on the LED display while the [SPLIT] button is held). The split point can also be set via the Function mode (see below).

Other Split Mode Functions

The CLP-555 Function mode provides access to a number of other split-mode functions, listed below. See the corresponding pages for details.

- Split Point 25
- Split Balance 26
- Right Voice Octave Shift 26
- Left Voice Octave Shift 26
- Right Voice Effect Depth 26
- Left Voice Effect Depth 26
- Damper Mode 26
- Reset 26

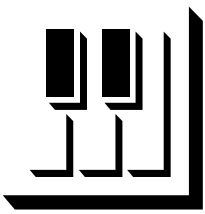

Reverb

The **[REVERB]** button selects a number of digital reverb effects that you can use for extra depth and expressive power.



To select a reverb type press the **[REVERB]** button a few times until the indicator corresponding to the desired type lights (the indicators light in sequence each time the **[REVERB]** button is pressed). No reverb is produced when all indicators are off.

OFF

No reverb effect is selected when no REVERB indicator is lit.

ROOM

This setting add a continuous reverb effect to the sound that is similar to the type of acoustic reverberation you would hear in a medium-size room. This is the default reverb setting.

HALL 1

For a "bigger" reverb sound, use the HALL 1 setting. This effect simulates the natural reverberation of a medium-size concert hall.

HALL 2

For a really spacious reverb sound, use the HALL 2 setting. This effect simulates the natural reverberation of a large concert hall.

STAGE

A simulation of the type of reverb produced in a stage environment.

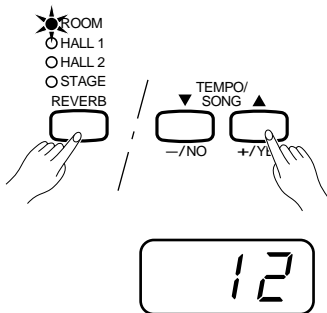

Adjusting Reverb Depth

The depth of the selected reverb effect can be adjusted for the current voice by using the **[-/NO]** and **[+/YES]** buttons while holding the **[REVERB]** button. The depth range is from 0 through 20 (the current depth setting appears on the LED display while the **[REVERB]** button is held). A setting of "0" produces no effect, while a setting of "20" produces maximum reverb depth. Press the **[-/NO]** and **[+/YES]** buttons simultaneously while holding the **[REVERB]** button to recall the default setting: "10".



• The reverb type and depth settings affect all voices.

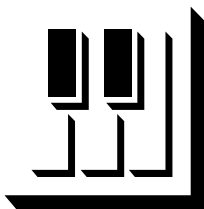

The Chorus Effect

The **[EFFECT]** button engages a chorus effect that can give your sound greater depth and animation.

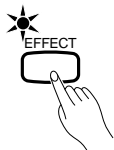

The **[EFFECT]** button turns the chorus effect on (indicator lit) and off (indicator off).



• The default effect on/off settings are different for each voice.

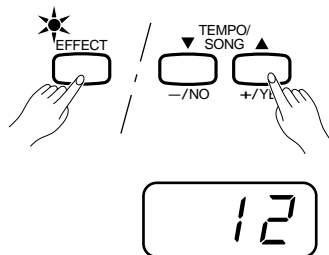

Adjusting Effect Depth

While the chorus effect is on the effect depth can be individually adjusted for the selected voice by using the **[-/NO]** and **[+/YES]** buttons while holding the **[EFFECT]** button. The depth range is from 0 through 20 (the current depth setting appears on the LED display while the **[EFFECT]** button is held). A setting of “0” produces no effect, while a setting of “20” produces maximum effect depth. Press the **[-/NO]** and **[+/YES]** buttons simultaneously while holding the **[EFFECT]** button to recall the default setting for the current voice (the default depth settings are different for each voice).



The Pedals

The CLP-555 has three foot pedals that produce a range of expressive effects similar to those produced by the pedals on an acoustic piano.

Soft (Left) Pedal

The soft pedal reduces the volume and slightly changes the timbre of notes played while the pedal is pressed. The soft pedal will not affect notes which are already playing when it is pressed.

The left pedal can also be assigned to song start/stop operation via the “Left Pedal Mode” described on page 27.

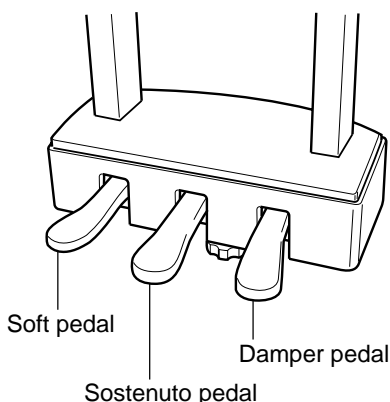

Sostenuto (Center) Pedal

If you play a note or chord on the keyboard and press the sostenuto pedal while the note(s) are held, those notes will be sustained as long as the pedal is held (as if the damper pedal had been pressed) but all subsequently played notes will not be sustained. This makes it possible to sustain a chord, for example, while other notes are played “staccato.”

Damper (Right) Pedal

The damper pedal functions in the same way as a damper pedal on an acoustic piano. When the damper pedal is pressed notes played have a long sustain. Releasing the pedal immediately stops (damps) any sustained notes.

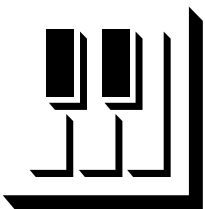

Touch Sensitivity

Four different types of keyboard touch sensitivity — HARD, MEDIUM, SOFT or FIXED — can be selected to match different playing styles and preferences.

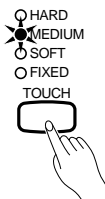

To select a touch sensitivity type press the [TOUCH] button a few times until the indicator corresponding to the desired type lights (the indicators light in sequence each time the [TOUCH] button is pressed).

HARD

The HARD setting requires the keys to be played quite hard to produce maximum loudness.

MEDIUM

The MEDIUM setting produces a fairly “standard” keyboard response. This is the initial factory default setting.

SOFT

The SOFT setting allows maximum loudness to be produced with relatively light key pressure.

FIXED

All notes are produced at the same volume no matter how hard the keyboard is played. This is an ideal setting for voices which normally have no keyboard sensitivity (i.e. harpsichord and organ). The volume of notes played in the FIXED mode can be set by using the [–/NO] and [+ /YES] buttons while the [TOUCH] button is held (the current volume level appears on the display). The volume range is from 1 through 127. The default setting is 64.

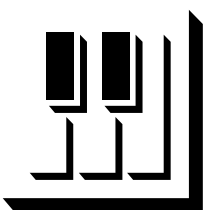

Transposition

The Clavinova’s TRANSPOSE function makes it possible to shift the pitch of the entire keyboard up or down in semitone intervals up to a maximum of 12 semitones (i.e. a maximum of one octave up or down). “Transposing” the pitch of the Clavinova keyboard facilitates playing in difficult key signatures, and you can easily match the pitch of the keyboard to the range of a singer or other instrumentalist.

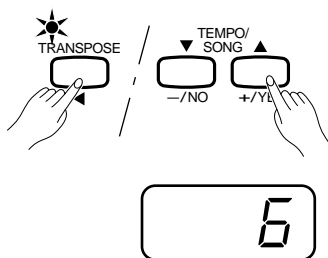

Use the [–/NO] or [+ /YES] button while holding the [TRANSPOSE] button to transpose down or up as required. The transposition range is from “–12” (down one octave) through “0” (normal pitch) to “12” (up one octave). The amount of transposition appears on the LED display while the [TRANSPOSE] button is held. The default transpose setting is “0”.



- The [TRANSPOSE] button indicator remains lit when a transpose setting other than “0” is selected.
- Notes below and above the A-1 ... C7 range of the Clavinova sound one octave higher and lower, respectively.

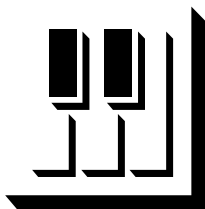

Tuning

Tuning makes it possible to adjust the pitch of the Clavinova over a 427.0 Hz ... 453.0 Hz (corresponding to the A3 note's Hz) range in approximately 0.2 Hertz intervals. Pitch control is useful for tuning the Clavinova to match other instruments or recorded music.

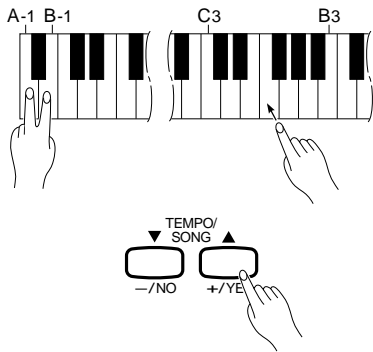

Tuning Up

- 1** To tune up (raise pitch), hold the A-1 and B-1 keys simultaneously.
- 2** Press any key between C3 and B3. Each time a key in this range is pressed the pitch is increased by approximately 0.2 Hz. The [-/NO] and [+ /YES] buttons can also be used to tune down or up, respectively, in 1 Hz increments. Press the [-/NO] and [+ /YES] buttons simultaneously to recall standard tuning (A3 = 440 Hz).
- 3** Release the A-1 and B-1 keys.

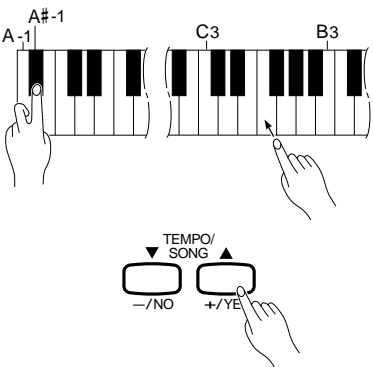

Tuning Down

- 1** To tune down (lower pitch), hold the A-1 and A#-1 keys simultaneously.
- 2** Press any key between C3 and B3. Each time a key in this range is pressed the pitch is decreased by approximately 0.2 Hz. The [-/NO] and [+ /YES] buttons can also be used to tune down or up, respectively, in 1 Hz increments. Press the [-/NO] and [+ /YES] buttons simultaneously to recall standard tuning (A3 = 440 Hz).
- 3** Release the A-1 and A#-1 keys.

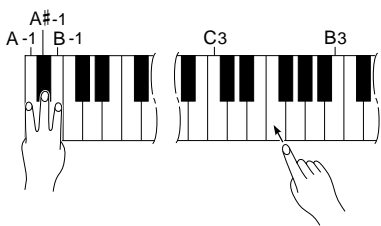

To Restore Standard Pitch

- 1** To restore the default pitch (A3 = 440 Hz), hold the A-1, A#-1 and B-1 keys simultaneously.
- 2** Press any key between C3 and B3.
- 3** Release the A-1, A#-1 and B-1 keys.

In terms of "Hertz", the overall tuning range is from 427.0 Hz to 453.0 Hz. The current tuning setting is shown on the LED display while the tuning is being adjusted. Tenths of a Hertz are indicated on the LED display by the appearance and position of one or two dots, as in the following example:

Display	Value
440	440.0
440.	440.2
440.	440.4
440.	440.6
440.	440.8



- An alternative tuning method is available in the Function mode — page 23.
- The keyboard method of pitch control, described above, has no effect when LOCAL OFF is active (see "MIDI FUNCTIONS," page 28).

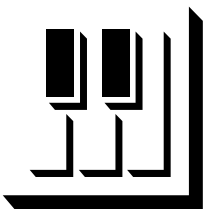

The Metronome & Tempo Control

The CLP-555 built-in metronome is a convenient feature for practice, and it can also provide a solid rhythmic guide when recording using the Recorder feature, described below.

The Metronome

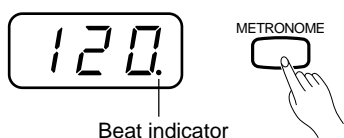

The metronome sound is alternately turned on and off by pressing the [METRONOME] button. When on, the beat indicator flashes at the current tempo.

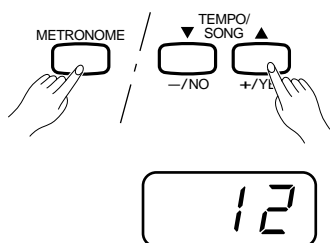

Metronome Volume

The volume of the metronome sound can be adjusted by using the [-/NO] and [+ /YES] buttons while holding the [METRONOME] button. The volume range is from 1 through 20 (the current volume setting appears on the LED display while the [METRONOME] button is held). A setting of “1” produces minimum sound, while a setting of “20” produces maximum metronome volume. Press the [-/NO] and [+ /YES] buttons simultaneously while holding the [METRONOME] button to recall the default setting: “10”.

Other Metronome Functions

The time signature (“beat”) of the metronome can be changed via the metronome “Beat” function in the Function mode — page 27. The Function mode also has an alternative method for adjusting the metronome volume — page 27.

Tempo Control

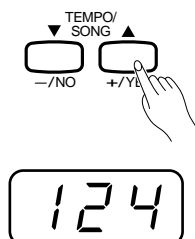

The tempo of the metronome and recorder playback (the recorder is described in the next section) can be set from 32 to 280 beats per minute by using the [TEMPO/SONG ▼/▲] buttons. The [▼] button decreases the tempo and the [▲] button increases the tempo. The selected tempo appears on the LED display in the normal play mode and while the [TEMPO/SONG ▼/▲] buttons are being used to adjust the tempo. The default tempo (120 or the recorded song tempo when the recorder contains data and the playback track lamp is lit) can be recalled by simultaneously pressing the [▼] and [▲] buttons.

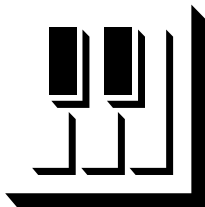

Using the Recorder

The CLP-555 features a two-track recorder that let you record what you play on the keyboard and then play it back. Two tracks mean that you can “overdub” one part on top of another, using a different voice if you like. The recorder feature is a useful adjunct to any keyboard study program, since it lets you hear exactly how you sound from the listener’s perspective. It can also be just plain fun.

The recorder actually records the following data:

■ Entire Song

- Tempo
- Reverb type & depth
- Effect type

■ Individual Tracks

- Notes played
- Dual mode voices
- Damper pedal
- Sostenuto pedal (not recorded as an initial setting)
- Effect depth
- Split mode functions (F3)
- Split mode functions (F4)
- Voice selection
- Split mode voices
- Soft pedal
- Voice variation

Recording

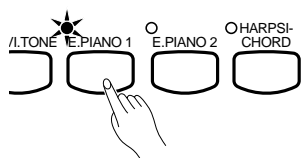

1) Make All Necessary Initial Settings

Before actually beginning to record, select the voice you want to record with (or voices if you will be using the dual or split mode). You might also want to set the volume and tempo controls.

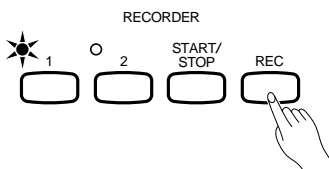

2) Engage the Record Ready Mode

Press the **RECORDER** [REC] button to engage the record ready mode (recording does not actually start yet). The record ready mode can be disengaged before recording by pressing the [REC] button a second time.



- The record ready mode cannot be engaged while the demo/piano song mode is engaged.

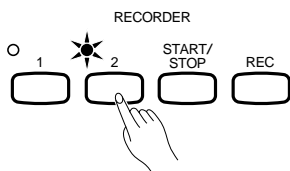

3) Select the Record Track

When the record mode is engaged in the previous step, the last-recorded track will automatically be selected for recording and its indicator — i.e. the [1] or [2] button indicator — will glow red. If you want to record on a different track, press the appropriate track button so that its indicator glows red.



- The track button indicators of tracks which contain previously recorded data will glow green (unless the track is turned off as described below). The previously-recorded data on the non-record track will normally be played back as you record, so you can play along with a previously-recorded track. If you don't want to hear the previously recorded track as you record, press the playback track button before pressing the [REC] button (step 1, above) so that its indicator goes out.
- Recording on a track which already contains data will erase all previous data on that track.
- When the record mode is engaged the amount of memory available for recording will be shown on the LED display in approximate kilobytes (starting at “21”), and the rightmost dot on the LED display will flash at the current METRONOME tempo setting.

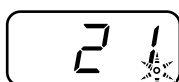

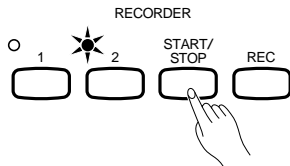
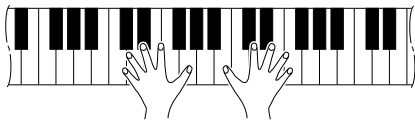

4 Start Recording

Recording will begin automatically as soon as you play a note on the keyboard or press the **[START/STOP]** button. The current measure number will appear on the display while recording.



- The left pedal can be assigned to start and stop recording via the "Left Pedal Mode" function described on page 27.
- If the metronome was on when you started recording, you'll be able to keep time with the metronome while recording, but the metronome sound will not be recorded.
- You can record up to a maximum of about 4,200 notes, depending on pedal usage and other factors. The record track indicators will begin to flash when recorder memory is almost full. If the memory becomes full during recording, "FUL" will appear on the display and recording will stop automatically.

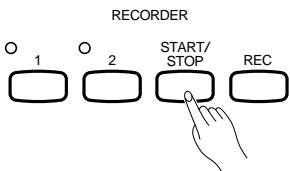

5 Stop Recording

Press either the **RECORDER [REC]** or **[START/STOP]** button to stop recording.

The indicator of the recorded track will glow green to indicate that it now contains data.

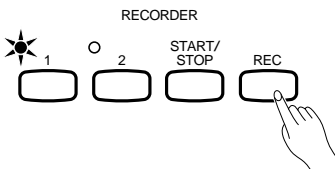

Changing the Initial Settings

The initial voice (including dual mode), damper pedal, soft pedal, tempo, reverb type, reverb depth, and effect settings made in step 1 of the recording procedure are actually recorded by the CLP-555. These initial settings can be changed after the recording is finished by pressing the **[REC]** button to engage the record ready mode, pressing the appropriate track button, making the required changes, and then pressing the **[REC]** button again to exit from the record ready mode and register the changes. If you do this, be careful not to press the **[START/STOP]** button or a key on the keyboard, either of which will start recording and erase all previous recorded data on the selected track. It is possible to cancel the operation even after changes have been made: change tracks and then press the **[REC]** button to exit from the record mode (this also cancels data for the entire song).



- The initial data of the "Dual mode functions (F3)" or "Split mode functions (F4)" cannot be changed.

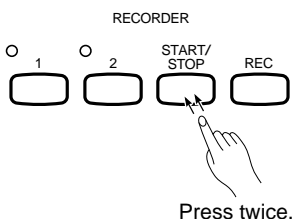

Erasing a Single Track

All data can be erased from either of the recorder's tracks by engaging the record mode, selecting the track you want to erase, and then pressing the **[START/STOP]** button twice without recording any data.

Playback

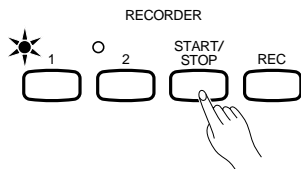

To play back what you've recorded, first make sure that the green track indicators of the tracks you want to play are lit. If not, press the corresponding track button(s) so that they are lit. Then press the RECORDER [START/STOP] button. Playback starts from the beginning of the recorded data, and will stop automatically at the end of the recorded data. You can also stop playback at any time by pressing the [START/STOP] button. To mute a track so that it doesn't play back, press the corresponding track button so that its indicator goes out (press again to turn the track back on).

The current measure number appears on the display during playback.

NOTE

- It is possible to play along on the keyboard during playback.
- The playback volume and tempo can be adjusted by using the [MASTER VOLUME] control and [TEMPO/SONG] buttons (press both [TEMPO/SONG] buttons simultaneously to recall the default tempo).
- All recorder data will be retained in memory for about one week after the power is turned off. If you want to keep your recorded data for longer periods, turn the power on for a few minutes at least once a week. It is also possible to store it to an external MIDI storage device such as the Yamaha DOU-10 Disk Orchestra Unit by using the Bulk Dump function described on page 30.
- The track indicators will not light automatically when the power is turned on even if the recorder contains data. It is therefore necessary to press the track buttons so that the corresponding green indicators light before starting RECORDER playback. It is also a good idea to press the track buttons to check if the tracks contain data before recording. If the green indicator lights when the corresponding track button is pressed, that track contains data which will be erased and replaced by the newly-recorded data.
- If the metronome is being used during playback, the metronome will stop when playback is stopped.
- During recorder playback, the volume of a track which is turned off will always be "0" (i.e. the "Piano Song Part Cancel Volume" function — page 27 — only affects piano song playback).
- The playback data is not transmitted via the MIDI OUT connector.
- Playback cannot be started when the demo/piano song mode or function mode is engaged. Playback can be started from the function mode, however, after one of the track buttons — [1] or [2] — is pressed.
- Playback cannot be started when the recorder contains no data, or when both track buttons are off.

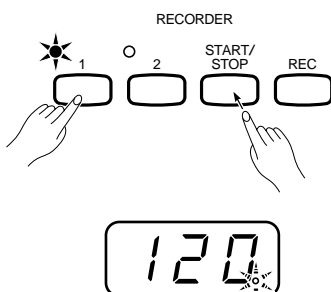

Synchro Start

When the Synchro Start function is engaged, recorder playback will begin automatically as soon as you start playing on the keyboard.

To engage the Synchro Start function press the [START/STOP] button while holding a track button which is ON. The rightmost dot on the display will flash at the current tempo. Playback will then start as soon as you begin playing on the keyboard.

If you hold a track button which is OFF while pressing the [START/STOP] button, that track will be turned ON and the Synchro Start mode will be engaged.

Left Pedal Start/Stop

The left pedal can be assigned to start and stop recorder playback via the "Left Pedal Mode" function described on page 27.

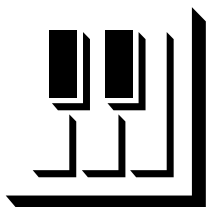

The Function Mode

The [FUNCTION] button provides access to a range of functions that give the CLP-555 extraordinary versatility. The functions are categorized in groups as follows:

F1	Tuning	23
F2	Scale	23
F3	Dual Mode Functions	24
F4	Split Mode Functions	24
F5	Metronome Functions	27
F6	Left Pedal Mode	27
F7	Piano Song Part Cancel Volume	27
F8	MIDI Functions	28
F9	Backup Functions	31

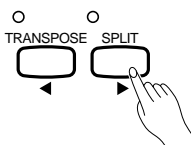
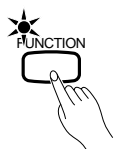

● Operation Example

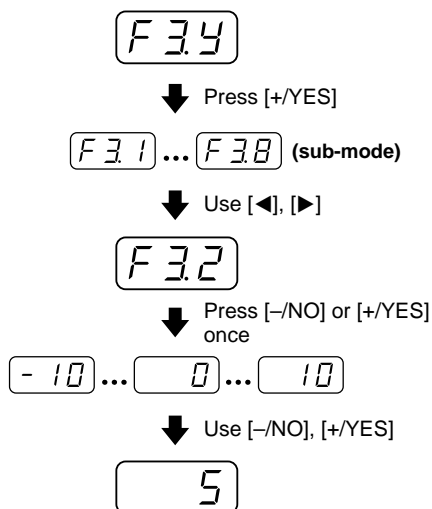

To Select a Function ...

1 Press the [FUNCTION] button so that its indicator lights.



• Functions cannot be selected during demo/piano song playback or when the recorder is in operation.

2 Use the [◀] and [▶] buttons (i.e. the [TRANSPOSE] and [SPLIT] buttons) to select the desired function: F1 through F9.

3 In the case of the Dual Mode (F3), Split Mode (F4), Metronome (F5), MIDI (F8), and Backup (F9) functions, you will have to press the [+ / YES] button once to enter the respective sub-mode after the function has been selected, and then use the [◀] and [▶] buttons again to select the desired sub-function.



• The Dual or Split mode must be engaged before the F3 and F4 functions can be selected, respectively. If the corresponding mode is not engaged, "F3-" or "F4-" will appear on the display and the corresponding sub-mode will not be available.

• The Dual mode can be engaged while in the Function mode, but the Function mode must be exited before the Split mode can be engaged.

4 Set the function as required by using the [- / NO] and [+ / YES] buttons (see the individual function descriptions, below).

5 Press the [FUNCTION] button so that its indicator goes out to exit from the function mode.

F1 Tuning

In addition to the tuning method described on page 17, overall tuning can also be accomplished via the F1 function.

After selecting “F1”, use the [–/NO] and [+ /YES] buttons to lower or raise the pitch in 0.2 Hz increments (the first time the [–/NO] or [+ /YES] button is pressed simply switches to the tuning value display without actually changing the tuning). The overall tuning range is from 427.0 Hz to 453.0 Hz (corresponding to the A3 note’s Hz). Press the [–/NO] and [+ /YES] buttons simultaneously to recall the default value: 440 Hz.

Tenths of a Hertz are indicated on the LED display by the appearance and position of one or two dots, as in the following example:

Display	Value
440	440.0
440.	440.2
440.	440.4
440.	440.6
440.	440.8

F2 Scale

In addition to the standard Equal Temperament tuning, the CLP-555 includes 6 classic tunings that you can select and use to play music of the corresponding period, or experiment with in a more modern context. The tunings are:

- 1: Equal Temperament
- 2: Pure Major
- 3: Pure Minor
- 4: Pythagorean
- 5: Mean Tone
- 6: Werckmeister
- 7: Kirnberger

After selecting “F2”, use the [–/NO] and [+ /YES] buttons to select the number of the desired tuning, then press the key corresponding to the key on which you want the selected tuning to be based (unlike the Equal Temperament tuning, the classic tunings must be tuned to a specific key). The selected key will appear on the display, followed by a low bar if flat (e.g. “ $\tilde{c}d$ ”) or a high bar if sharp (e.g. “ $\tilde{c}F$ ”).

Press the [–/NO] and [+ /YES] buttons simultaneously to recall the default settings (Equal Temperament tuning).



• No base key can be set for the 1: Equal Temperament tuning.

F3 Dual Mode Functions

After selecting “F 3.4”, press the [+/**YES**] button to engage the dual-mode function sub-mode, then use the [◀] and [▶] buttons to select the desired dual mode function, as listed below.

If the Dual mode is not engaged “F 3.-” will appear instead of “F 3.4” and the Dual mode functions cannot be selected. If this happens engage the Dual mode and proceed.

■ **SHORTCUT:** You can jump directly to the dual-mode functions (F3) by pressing the [**FUNCTION**] button while holding the two dual-mode voice selectors corresponding to the voices you want to combine in the dual mode.

F3.1: Dual Balance

The volume levels of the two voices combined in the dual mode can be adjusted as required by using this function. Use the [-/**NO**] and [+/**YES**] buttons to adjust the balance as required. The balance range is from 0 through 20. A setting of “10” produces equal balance between the two dual-mode voices. Settings below “10” increase the volume of the 2nd voice in relation to the 1st voice, and settings above “10” increase the volume of the 1st voice in relation to the 2nd voice (“1st” and “2nd” refer to the left and right voice selectors, respectively). Press the [-/**NO**] and [+/**YES**] buttons simultaneously to recall the default setting (different for each voice combination).

F3.2: Dual Detune

This function makes it possible to detune the 1st and 2nd dual-mode voices to create a thicker sound. Use the [-/**NO**] and [+/**YES**] buttons to set the amount of detuning as required. The detune range is from -10 through 10. A setting of “0” sets both voices to the same pitch. Settings below “0” increase the pitch of the 2nd voice in relation to the 1st voice, and settings above “0” increase the pitch of the 1st voice in relation to the 2nd voice (“1st” and “2nd” refer to the left and right voice selectors, respectively). Press the [-/**NO**] and [+/**YES**] buttons simultaneously to recall the default setting (different for each voice combination).

F3.3: 1st Voice Octave Shift

F3.4: 2nd Voice Octave Shift

Depending on which voices you combine using the dual mode, the combination may sound better if one of the voices is shifted up or down an octave. Use the [-/**NO**] and [+/**YES**] buttons to set the octave of the 1st or 2nd voice as required (“1st” and “2nd” refer to the left and right voice selectors, respectively). The available settings are “0” for normal pitch, “-1” to shift the pitch down one octave, and “1” to shift the pitch up one octave. Press the [-/**NO**] and [+/**YES**] buttons simultaneously to recall the default setting (different for each combination).

F3.5: 1st Voice Effect Depth

F3.6: 2nd Voice Effect Depth

These functions make it possible to individually set the depth of the chorus effect for the 1st and 2nd dual-mode voices (“1st” and “2nd” refer to the left and right voice selectors, respectively). Use the [–/NO] and [+ /YES] buttons to set the effect depth for the corresponding voice as required. The depth range is from 0 through 20. A setting of “0” produces no effect, while a setting of “20” produces maximum effect depth. Press the [–/NO] and [+ /YES] buttons simultaneously to recall the default setting (the default effect depth setting is different for each voice).



• *The effect depth settings cannot be changed unless the EFFECT is ON. The Function mode must be exited before EFFECT can be turned ON.*

F3.7: Slow-attack Strings

In a dual mode voice combination using a strings voice and any other voice, a better “blend” can sometimes be produced by switching the strings voice to a slow-attack variation. Use the [–/NO] and [+ /YES] buttons to turn the slow-attack variation “On” or “OFF”, as required. Press the [–/NO] and [+ /YES] buttons simultaneously to recall the default setting: “OFF”.

F3.8: Reset

This function resets all dual-mode functions to their default values. Press the [+ /YES] button to reset the values. “END” will appear on the display when all functions have been reset.

F4 Split Mode Functions

After selecting “F 4.5”, press the [+ /YES] button to engage the split-mode function sub-mode, then use the [◀] and [▶] buttons to select the desired split mode function, as listed below.

If the Split mode is not engaged “F 4.-” will appear instead of “F 4.5” and the Split mode functions cannot be selected. Also note that you must exit from the Function mode before the Split mode can be engaged.

■ **SHORTCUT:** You can jump directly to the split-mode functions (F4) by pressing the [FUNCTION] button while holding the [SPLIT] button.

F4.1: Split Point

In addition to the split point setting method described on page 13, the split point can be set via this function. Use the [–/NO] and [+ /YES] buttons to set the split point as required, or simply press the appropriate key on the keyboard: from “A-1” to “C7”. Press the [–/NO] and [+ /YES] buttons simultaneously to recall the default setting: “F#2”.

F4.2: Split Balance

The volume levels of the two voices combined in the split mode can be adjusted as required by using this function. Use the [–/NO] and [+ /YES] buttons to adjust the balance as required. The balance range is from 0 through 20. A setting of “10” produces equal balance between the two split-mode voices. Settings below “10” increase the volume of the left-hand voice in relation to the right-hand voice, and settings above “10” increase the volume of the right-hand voice in relation to the left-hand voice. Press the [–/NO] and [+ /YES] buttons simultaneously to recall the default setting (different for each voice combination).

F4.3: Right Voice Octave Shift

F4.4: Left Voice Octave Shift

Depending on which voices you combine using the split mode, the combination may sound better if one of the voices is shifted up or down an octave. Use the [–/NO] and [+ /YES] buttons to set the octave of the left-hand or right-hand voice as required. The available settings are “0” for normal pitch, “–1” to shift the pitch down one octave, and “1” to shift the pitch up one octave. Press the [–/NO] and [+ /YES] buttons simultaneously to recall the default setting (different for each voice combination).

F4.5: Right Voice Effect Depth

F4.6: Left Voice Effect Depth

These functions make it possible to individually set the depth of the chorus effect for the left-hand and right-hand split-mode voices. Use the [–/NO] and [+ /YES] buttons to set the effect depth for the corresponding voice as required. The depth range is from 0 through 20. A setting of “0” produces no effect, while a setting of “20” produces maximum effect depth. Press the [–/NO] and [+ /YES] buttons simultaneously to recall the default setting (the default effect depth setting is different for each voice).

 **NOTE** • The effect depth settings cannot be changed unless the EFFECT is ON. The Function mode must be exited before EFFECT can be turned ON.

F4.7: Damper Mode

The Damper Mode function determines whether the damper pedal affects the right voice, the left voice, or both the left and right voices in the split mode. Use the [–/NO] and [+ /YES] buttons to select “2” for the left voice, “1” for the right voice, or “ALL” for both voices. Press the [–/NO] and [+ /YES] buttons simultaneously to recall the default setting: “ALL”.

F4.8: Reset

This function resets all dual-mode functions to their default values. Press the [+ /YES] button to reset the values. “END” will appear on the display when all functions have been reset.

F5 Metronome Functions

After selecting “F 5.5”, press the [+/**YES**] button to engage the metronome function sub-mode, then use the [◀] and [▶] buttons to select the desired metronome function, as listed below.

■ **SHORTCUT:** You can jump directly to the metronome functions by pressing the [**FUNCTION**] button while holding the [**METRONOME**] button.

F5.1: Beat

Use this function to set the time signature of the metronome as required (i.e. the number of unaccented beats that occur between each accented beat). Use the [–/**NO**] and [+/**YES**] buttons to set the time signature to “0” (no accent), or a value between “2” and “6”, as required. Press the [–/**NO**] and [+/**YES**] buttons simultaneously to recall the default setting: “0”.

F5.2: Volume

Use the [–/**NO**] and [+/**YES**] buttons to set the metronome volume as required. The volume range is from 1 through 20. A setting of “1” produces minimum sound, while a setting of “20” produces maximum metronome volume. Press the [–/**NO**] and [+/**YES**] buttons simultaneously to recall the default setting: “10”.

F6 Left Pedal Mode

This function sets the left pedal for normal soft-pedal operation, or for song start/stop operation. Use the [–/**NO**] and [+/**YES**] buttons to select the desired left-pedal mode. “1” is the normal soft-pedal mode, and “2” is the start/stop mode. When the start/stop mode is selected, the left-pedal functions in the same way as the panel [**START/STOP**] button.

F7 Piano Song Part Cancel Volume

This functions sets the volume at which a “canceled” part is played during piano song playback (see page 11 for information on the “part-cancel” function). Use the [–/**NO**] and [+/**YES**] buttons to set the volume as required. The volume range is from 0 through 20. A setting of “0” produces no sound, while a setting of “20” produces maximum volume. Press the [–/**NO**] and [+/**YES**] buttons simultaneously to recall the default setting: “5”.

F8 MIDI Functions

● A Brief Introduction to MIDI

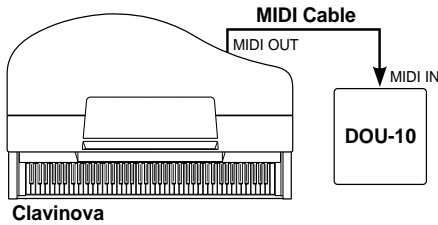

Clavinova

MIDI, the Musical Instrument Digital Interface, is a world-standard communication interface that allows MIDI-compatible musical instruments and equipment to share musical information and control one another. This makes it possible to create “systems” of MIDI instruments and equipment that offer far greater versatility and control than is available with isolated instruments. For example, most MIDI keyboards (including the Clavinova, of course) transmit note

and velocity (touch response) information via the MIDI OUT connector whenever a note is played on the keyboard. If the MIDI OUT connector is connected to the MIDI IN connector of a second keyboard (synthesizer, etc.) or a tone generator (essentially a synthesizer with no keyboard), the second keyboard or tone generator will respond precisely to notes played on the original transmitting keyboard. The result is that you can effectively play two instruments at once, providing thick multi-instrument sounds.

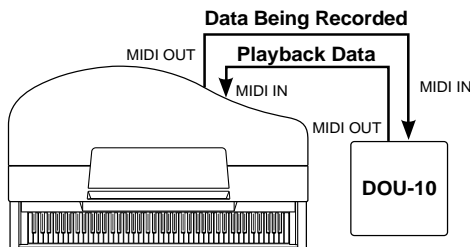

Clavinova

This same type of musical information transfer is used for MIDI sequence recording. A sequence recorder can be used to “record” MIDI data received from a Clavinova, for example. When the recorded data is played back, the Clavinova automatically “plays” the recorded performance in precise detail.

The examples given above really only scratch the surface. MIDI can do much, much more. The CLP-555 MIDI functions allow it to be used in fairly sophisticated MIDI systems.

After selecting “F8.5”, press the [+ / YES] button to engage the MIDI function sub-mode, then use the [◀] and [▶] buttons to select the desired MIDI function, as listed below.



- The rear-panel HOST SELECT switch must be set to “MIDI” in order to use the MIDI connectors.
- Always use a high-quality MIDI cable to connect MIDI OUT to MIDI IN terminals. Never use MIDI cables longer than about 15 meters, since cables longer than this can pick up noise which can cause data errors.

- F8.1: MIDI Transmit Channel Selection
- F8.2: MIDI Receive Channel Selection

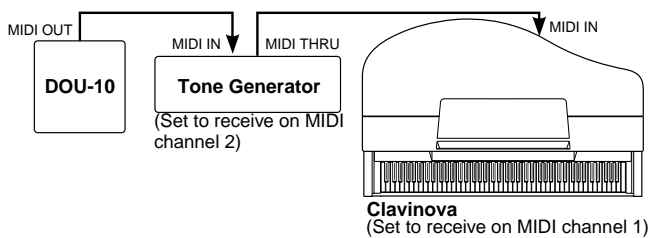

generators. One of the instruments or tone generators could be set to receive only on channel 1, while the other is set to receive on channel 2. In this situation the first instrument or tone generator will respond only to channel-1 information transmitted by the sequence recorder, while the second instrument or tone generator will respond only to channel-2 information. This allows the sequence recorder to “play” two completely different parts on the receiving instruments or tone generators.

The MIDI system allows transmission and reception of MIDI data on 16 different channels. Multiple channels have been implemented to allow selective control of certain instruments or devices connected in series. For example, a single MIDI sequence recorder could be used to “play” two different instruments or tone

In any MIDI control setup, the MIDI channels of the transmitting and receiving equipment must be matched for proper data transfer. A “Multi-timbre” receive mode is also available, which allows simultaneous reception of different parts on all 16 MIDI channels, allowing the Clavinova to play multi-channel song data received from a music computer or sequencer. There’s also a “1-2” mode which allows simultaneous reception on channels 1 and 2.

Use the [–/NO] and [+ /YES] buttons to select the desired transmit or receive channel. The transmit channel parameter can also be turned “OFF” if you don’t want the Clavinova to transmit any MIDI data. To select the multi-timbre receive mode, set the receive channel to “ALL”. Select “1-2” for multi-timbre reception on channels 1 and 2 only.

Press the [–/NO] and [+ /YES] buttons simultaneously to recall the default setting: transmit = “1”; receive = “ALL”.

NOTE

- In the dual mode the second voice data is transmitted on channel 2, and in the split mode the left-voice data is transmitted on channel 2. In either mode, no data is transmitted if the transmit channel parameter is set to “OFF”.
- Demo/piano song data and recorder playback data are not transmitted via MIDI.
- No MIDI reception occurs when the demo/piano song mode is engaged.
- Received MIDI data will not affect the Clavinova’s panel settings or what is being played on the keyboard — except for reverb type, reverb depth, and effect on/off data which will affect the Clavinova settings.

F8.3: Local Control ON/OFF

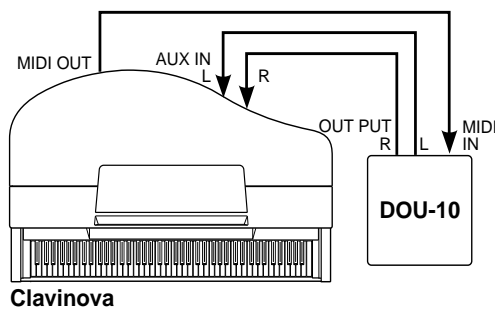

“Local Control” refers to the fact that, normally, the Clavinova keyboard controls its internal tone generator, allowing the internal voices to be played directly from the keyboard. This situation is “Local Control On” since the internal tone generator is controlled locally by its own keyboard.

Local control can be turned OFF, however, so that the Clavinova keyboard does not play the internal voices, but the appropriate MIDI information is still

transmitted via the MIDI OUT connector when notes are played on the keyboard. At the same time, the internal tone generator responds to MIDI information received via the MIDI IN connector.

When using the DOU-10 Disk Orchestra Unit with the Clavinova, for example, Local Control should be turned OFF when recording using the DOU-10 voices only, and ON when recording the Clavinova voices while listening to playback of the DOU-10 voices.

Use the [–/NO] and [+ /YES] buttons to turn local control “On” or “OFF”.

Press the [–/NO] and [+ /YES] buttons simultaneously to recall the default setting: “On”.

F8.4: Program Change ON/OFF

Normally the Clavinova will respond to MIDI program change numbers received from an external keyboard or other MIDI device, causing the correspondingly numbered voice to be selected on the corresponding channel (the keyboard voice does not change). The Clavinova will normally also send a MIDI program change number whenever one of its voices is selected, causing the correspondingly numbered voice or program to be selected on the external MIDI device if the device is set up to receive and respond to MIDI program change numbers.

This function makes it possible to cancel program change number reception and transmission so that voices can be selected on the Clavinova without affecting the external MIDI device.

Use the [–/NO] and [+ /YES] buttons to turn program change transmission and reception “On” or “OFF”.

Press the [–/NO] and [+ /YES] buttons simultaneously to recall the default setting: “On”.

F8.5: Control Change ON/OFF

Normally the Clavinova will respond to MIDI control change data received from an external MIDI device or keyboard, causing the voice on the corresponding channel to be affected by pedal and other “control” settings received from the controlling device (the keyboard voice is not affected, but reverb depth data will affect the Clavinova settings). The Clavinova also transmits MIDI control change information when one of its pedals or other appropriate controls are operated.

This function makes it possible to cancel control change data reception and transmission so that, for example, the Clavinova pedals and other controls can be operated without affecting an external MIDI device.

Use the [–/NO] and [+ /YES] buttons to turn control change transmission and reception “On” or “OFF”.

Press the [–/NO] and [+ /YES] buttons simultaneously to recall the default setting: “On”.

F8.6: MIDI Transmit Transpose

This function allows the MIDI note data transmitted by the Clavinova to be transposed up or down in semitone increments by up to plus or minus 12 semitones. The pitch of the Clavinova itself is not affected

Use the [–/NO] and [+ /YES] buttons to set the desired amount of MIDI transmit transposition. The range is from “–12” (down one octave) through “0” (no transposition) to “12” (up one octave)

Press the [–/NO] and [+ /YES] buttons simultaneously to recall the default setting: “0”

F8.7: Panel/Status Transmit

This function causes all the current Clavinova control settings (selected voice, etc.) to be transmitted via the MIDI OUT terminal. This is particularly useful if you will be recording performances to a MIDI sequence recorder such as the Yamaha DOU-10 Disk Orchestra Unit which will be used to control the Clavinova on playback. By transmitting the Clavinova panel settings and recording them on the MIDI sequence recorder prior to the actual performance data, the Clavinova will be automatically restored to the same settings when the performance is played back.

Press the [+ /YES] button to transmit the panel/status data. “E n d” will appear on the LED display when the data has been successfully transmitted.



- See page 36 for list of the “Panel Data Contents” transmitted by this function.
- Panel setting data can only be transferred between the same models (data cannot, for example, be transferred between a CLP-555 and CLP-411).

F8.8: Bulk Data Dump

This function is used to transmit all data stored in the Recorder memory to a MIDI data storage device such as the Yamaha DOU-10 Disk Orchestra Unit, other sequence recorders, or MIDI compatible computers.

Press the [+ /YES] button to begin bulk transmission. “E n d” will appear on the LED display when the data has been successfully transmitted.



- Bulk dump will not function when the recorder is in operation.
- Recorder data can only be transferred between the same models (data cannot, for example, be transferred between a CLP-555 and CLP-411).
- No MIDI note/panel data transmission or data reception occurs during a bulk dump transmit operation.

F9 Backup Functions

After selecting “F 9.9”, press the [+/**YES**] button to engage the backup function sub-mode, then use the [◀] and [▶] buttons to select the desired backup function, as listed below.



• *The backup settings themselves, and the contents of the recorder memory, are always backed up.*

Even if backup is turned on via one of the functions described below, the data will only be retained in memory for about 1 week if the power is not turned on during this time. If the backup period is exceeded, all settings will be reset to their default values. If you want to retain the backup settings for longer periods, be sure to turn the power switch on for a few minutes at least once a week.



F9.1: Voice

Turns backup of the voice functions listed below on or off. Use the [–/**NO**] and [+/**YES**] buttons to turn backup “On” or “OFF”.

The default backup mode is “OFF”.

- Voice (Keyboard, Dual, Split)
- Dual (Voice, Dual Functions)
- Split (Voice, Split Functions)
- Reverb (Type, Depth)
- Effect (ON/OFF, Depth)
- Variation
- Touch Sensitivity
- Metronome (Beat, Volume)



F9.2: MIDI

Turns backup of the MIDI functions listed below on or off. Use the [–/**NO**] and [+/**YES**] buttons to turn backup “On” or “OFF”.

The default backup mode is “OFF”.

- Channel (Transmit, Receive)
- Local ON/OFF
- Program Change ON/OFF
- Control Change ON/OFF
- MIDI Transmit Transpose



F9.3: Tuning

Turns backup of the tuning functions listed below on or off. Use the [–/**NO**] and [+/**YES**] buttons to turn backup “On” or “OFF”.

The default backup mode is “OFF”.

- Transpose
- Tuning
- Scale



F9.4: Pedal

Turns backup of the left pedal function on or off. Use the [–/**NO**] and [+/**YES**] buttons to turn backup “On” or “OFF”.

The default backup mode is “OFF”.

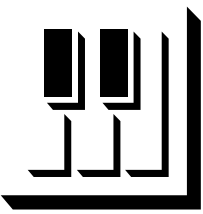

Connecting to a Personal Computer

Although the CLP-555 can be connected to a personal computer via the MIDI IN/OUT connectors and a MIDI interface, the TO HOST connector and HOST SELECT switch allow direct connection to Apple Macintosh or IBM-PC/AT personal computers for sequencing and other music applications without the need for a separate MIDI interface.

Connecting to an Apple Macintosh Series Computer

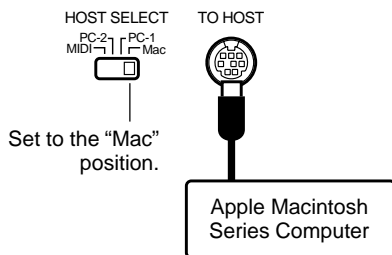

Connect the TO HOST connector of the Clavinova to the modem or printer port on your Macintosh, depending on which port your MIDI software is using for MIDI data communication, using a standard Macintosh 8-pin system peripheral cable. Set the HOST SELECT switch to the "Mac" position.

You may also have to make other MIDI interface settings on the computer side, depending on the type of software you use (refer to your software owner's manual). In any case the clock speed should be set to 1 MHz.

● "Mac" Cable Connections

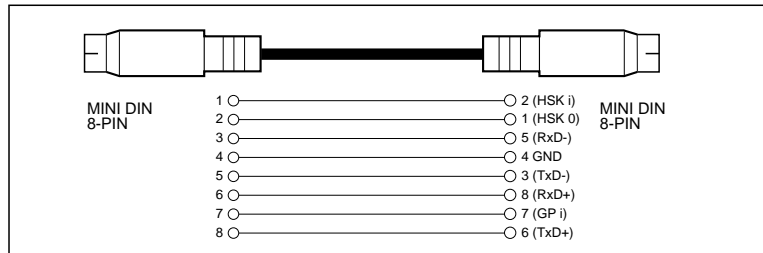

- 8-pin system peripheral cable.
- Data transfer rate: 31,250 bps.

NOTE

- When using the [TO HOST] terminal of the CLP-555, first turn the power off on both the CLP-555 and the computer before connecting the cable. After connecting the cable, turn the power of the computer on first, then the CLP-555.
- When not using the [TO HOST] terminal of the CLP-555, make sure the cable is disconnected from the [TO HOST] terminal. If the cable is left connected, the CLP-555 may not function properly.
- When the HOST SELECT switch is set to "Mac", "PC-1", or "PC-2", no data transfer occurs via the MIDI connectors. To use the MIDI connectors for connection via a standard MIDI interface, set the HOST SELECT switch to "MIDI".

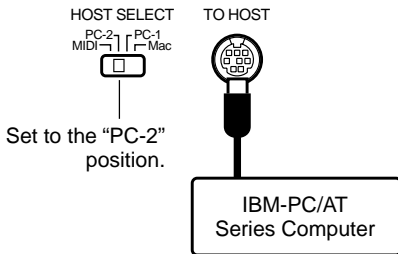

Connecting to an IBM-PC/AT Series Computer

Connect the TO HOST connector of the Clavinova to the RS-232C port on your IBM computer, using a standard 8-pin MINI DIN → 9-pin D-SUB cross cable. Set the HOST SELECT switch to the “PC-2” position.

Refer to your software owner’s manual for information on any settings you might have to make on the computer side.

● “PC-2” Cable Connections

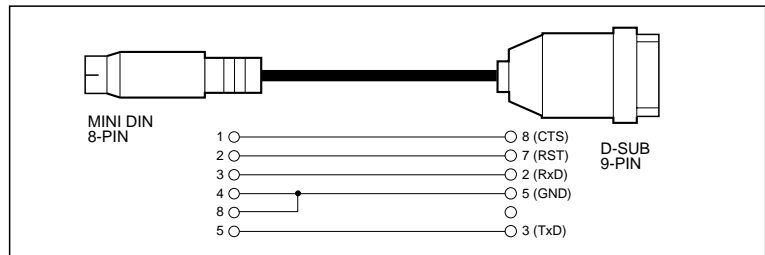

- 8-pin mini DIN → 9-pin D-SUB cable.
- Data transfer rate: 38,400 bps.

NOTE

- If your system doesn’t work properly with the connections and settings listed above, your software may require different settings. Check your software operation manual and if it requires a 31,250 bps. data transfer rate, set the HOST SELECT switch to “PC-1”.
- When using the TO HOST terminal to connect to a personal computer using Windows, a Yamaha MIDI driver must be installed in the personal computer. The Yamaha MIDI driver can be obtained at Yamaha’s home page on the World Wide Web, <<http://www.yamaha.co.jp/english/xg/>>.

● Connector Pin Numbers

MINI DIN 8-PIN



D-SUB 9-PIN

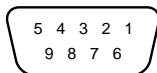

■ Trademarks

- Apple and Macintosh are trademarks of Apple Computer, Inc.
- IBM-PC/AT is a trademark of International Business Machines Corporation.
- Windows is the registered trademark of Microsoft® Corporation.

All other trademarks are the property of their respective holders.

Troubleshooting

If you encounter what appears to be a malfunction, please check the following points before assuming that your Clavinova is faulty.

1. No Sound When the Power is Turned ON

Is the AC plug properly connected to the Clavinova and an AC wall outlet? Check the AC connection carefully. Is the MASTER VOLUME control turned up to a reasonable listening level?

Also make sure that a pair of headphones is not plugged into the PHONES jack, and that the Local Control (page 29) is ON.

2. The Damper Pedal Doesn't Work

If the damper pedal doesn't work, or notes are sustained even when the pedal is not pressed, make sure that the pedal cord is properly plugged into the main unit (page 46).

3. The Clavinova Reproduces Radio or TV Sound

This can occur if there is a high-power transmitter in your vicinity. Contact your Yamaha dealer.

4. Intermittent Static Noise

This is usually due to turning ON or OFF a household appliance or other electronic equipment which is fed by the same AC mains line as your Clavinova.

5. Interference Appears On Radio or TV Sets Located Near the Clavinova

The Clavinova contains digital circuitry which can generate radio-frequency noise. The solution is to move the Clavinova further away from the affected equipment, or vice versa.

6. Distorted Sound When the Clavinova is Connected to An External Amplifier/Speaker System

If the Clavinova is connected to a stereo system or instrument amplifier and the sound is distorted, reduce the setting of the Clavinova volume control to a level at which the distortion ceases.

- If "5c n" appears on the display an internal malfunction has occurred. In this case, contact your Yamaha dealer.

Factory Preset Recall

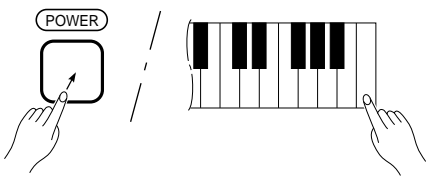

All dual mode, split mode, reverb, effect, touch sensitivity, tuning settings, and the settings affected by the Backup Functions can be restored to their original factory preset values by holding the C7 key while turning the [POWER] switch ON. This also erases all recorder data, and sets all Backup on/off settings (F9) to "OFF".

Options & Expander Modules

● Options

HPE-160 Stereo Headphones

High-performance lightweight dynamic headphones with extra-soft ear pads.

● Expander Modules

DOU-10 Disk Orchestra Unit

A range of MIDI recording and playback functions, plus Yamaha Disk Orchestra Collection, Disklavier PianoSoft™, General MIDI, and Standard MIDI File disk playback capability.

MIDI Data Format/MIDI-Datenformat/Format des données MIDI/ Formato de datos MIDI

If you're already very familiar with MIDI, or are using a computer to control your music hardware with computer-generated MIDI messages, the data provided in this section can help you to control the Clavinova.

Falls Sie bereits mit MIDI vertraut sind oder einen Computer zur Erzeugung von MIDI-Steuermeldungen für die Instrumente verwenden, können Sie sich zur Steuerung des Clavinovas nach den im folgenden Abschnitt aufgeführten Spezifikationen richten.

1. NOTE ON/OFF

Data format: [9nH] -> [kk] -> [vv]

9nH = Note ON/OFF event (n = channel number)
kk = Note number (Transmit: 09H ~ 78H = A-2 ~ C8 /
Receive: 00H ~ 7FH = C-2 ~ G8)
vv = Velocity (Key ON = 1 ~ 127. Key OFF = 0)

Data format: [8nH] -> [kk] -> [vv]

8nH = Note OFF event (n = channel number)
kk = Note number: 00H ~ 7FH = C-2 ~ G8
vv = Velocity (Key OFF = 0 ~ 127)

* 8nH (note off) is receive only.
9nH (vvH=00H) used for transmission.

2. CONTROL CHANGE & MODE MESSAGES

Data format: [BnH] -> [cc] -> [vv]

BnH = Control event (n = channel number)
cc = Control number
vv = Data Range

2.1 Control Change

2.1.(1) Bank Select

Cntrl#	Parameter	Data Range
0	Bank Select MSB	0:Normal
32	Bank Select LSB	0...127
	112	Variation Off
	113	Variation On

A new bank selection does not become effective until receipt of the next Program Change message.

2.1.(2) Main Volume (reception only)

Cntrl#	Parameter	Data Range
7	Volume MSB	0...127

2.1.(3) Expression

Cntrl#	Parameter	Data Range
11	Expression MSB	0...127

2.1.(4) Damper

Cntrl#	Parameter	Data Range
64	Damper MSB	0...127

Half pedal continuous data is received and accepted.

2.1.(5) Sostenuto

Cntrl#	Parameter	Data Range
66	Sostenuto	0...127 (0-63:off, 64-127:on)

2.1.(6) Soft Pedal

Cntrl#	Parameter	Data Range
67	Soft Pedal	0...127 (0-63:off, 64-127:on)

2.1.(7) Attack Time

Cntrl#	Parameter	Data Range
73	Attack Time	0...127

2.1.(8) Effect1 Depth (Reverb Send Level)

Cntrl#	Parameter	Data Range
91	Effect1 Depth	0...127

Adjusts the reverb send level.

Si vous êtes très familier avec l'interface MIDI ou si vous utilisez un ordinateur pour commander votre matériel de musique au moyen de messages MIDI générés par ordinateur, les données suivantes vous seront utiles et vous aideront à commander le Clavinova.

Si usted está ya familiarizado con MIDI, o si emplea una computadora para controlar sus aparatos musicales con mensajes MIDI generados por computadora, los datos proporcionados en esta sección le ayudarán a controlar la Clavinova.

2.1.(9) Effect4 Depth (Variation Effect Send Level)

Cntrl#	Parameter	Data Range
94	Effect4 Depth	0...127

2.2 Mode Messages

The following Channel Mode messages are supported. (But the actual mode is fixed to Poly and can not be changed.)

Cntrl#	Parameter	Data Range
120	All Sound Off	0
121	Reset All Controllers	0
123	All Notes Off	0
124	Omni Off	0
125	Omni On	0
126	Mono	0 ~ 16
127	Poly	0

2.2.(1) All Sound Off

Switches off all sound from the channel. Does not reset Note On and Hold On conditions established by Channel Messages.

2.2.(2) Reset All Controllers

Resets controllers as follows.

Controller	Value
Expression	127 (max)
Damper Pedal	0 (off)
Sostenuto	0 (off)
Soft Pedal	0 (off)

2.2.(3) All Notes Off

Switches off all of the channel's "on" notes. Any notes being held by DAMPER or SOSTENUTO continue to sound until DAMPER/SOSTENUTO goes off.

2.2.(4) Omni Off (reception only)

Same processing as for All Notes Off.

2.2.(5) Omni On (reception only)

Same processing as for All Notes Off.

2.2.(6) Mono (reception only)

Same processing as for All Sound Off.

2.2.(7) Poly (reception only)

Same processing as for All Sound Off.

- * When control change reception is turned OFF in the Function mode, no control change data is transmitted or received.
- * Local on/off, OMNI on/off are not transmitted. (The appropriate note off number is supplied with "All Note Off" transmission).
- * When a voice bank MSB/LSB is received, the number is stored in the internal buffer regardless of the received order, then the stored value is used to select the appropriate voice when a program change message is received.
- * The Multi-timbre and Poly modes are always active. No change occurs when OMNI ON, OMNI OFF, MONO, or POLY mode messages are received.

3. PROGRAM CHANGE

Data format: [CnH] -> [pp]

CnH = program event (n = channel number)
pp = Program number

pp	VOICE NAME
00	PIANO 1
01	PIANO 2
88	CLAVINOVA TONE
05	E. PIANO 1
04	E. PIANO 2
06	HARPSICHORD
48	STRINGS
19	PIPE ORGAN 1
16	PIPE ORGAN 2

* When program change reception is turned OFF in the Function mode, no program change data is transmitted or received.

4. SYSTEM REALTIME MESSAGES

[rrH]
F8H: Timing clock
FAH: Start
FCH: Stop
FEH: Active sensing

Data	Transmission	Reception
F8H	Transmitted every 96 clocks	Received as 96-clock tempo timing when MIDI clock is set to External
FAH	Recorder start	Recorder start
FCH	Recorder stop	Recorder stop
FEH	Transmitted every 200 milliseconds	All notes are turned off if no data is received for more than 400 milliseconds

* Caution: If an error occurs during MIDI reception, the Damper, Sostenuto, and Soft effects for all channels are turned off and an All Note Off occurs.

5. SYSTEM EXCLUSIVE MESSAGES

(1) Panel Data Transmit

Data format: [F0H] -> [43H] -> [0nH] -> [7CH] -> ... -> [F7H]

F0H, 43H, 0nH, 7CH (n: channel number)
00H, 2EH (data length)
43H, 4CH, 20H, 20H (CL)
43H, 4CH, 50H, 27H, 39H, 36H (CLP '96)
30H, 30H (version x, y)
[PANEL DATA]
[CHECK SUM (1byte)] = 0-(43H+4CH+20H+.....+Data end)
F7H

• Panel Data Contents

- (1) Voice
- (2) Dual On/Off
- (3) Dual Voice
- (4) Dual Balance
- (5) Dual Detune
- (6) Dual Voice1 Octave
- (7) Dual Voice2 Octave
- (8) Dual Voice1 Effect Depth
- (9) Dual Voice2 Effect Depth
- (10) Dual Slow-attack Strings On/Off
- (11) Split On/Off
- (12) Split Voice
- (13) Split Point
- (14) Split Balance
- (15) Split Voice1 Octave
- (16) Split Voice2 Octave
- (17) Split Voice1 Effect Depth
- (18) Split Voice2 Effect Depth
- (19) Split Damper Mode
- (20) Reverb Type 1
- (21) Reverb Depth 1
- (22) Effect Type 1

- (23) Effect Type 2
- (24) Effect Depth
- (25) - - -
- (26) Variation 1 On/Off
- (27) Variation 2 On/Off
- (28) Touch Sensitivity
- (29) Touch Volume in the FIXED Mode
- (30) Left Pedal (Soft/Start)
- (31) - - -
- (32) Absolute tempo low byte
- (33) Absolute tempo high byte
- (34) - - -

(2) Universal Realtime Message

Master Volume

Data format: [F0H] -> [7FH] -> [XnH] -> [04H] -> [01H] -> [//] -> [mm] -> [F7H]

- F0 = Exclusive status
7F = Universal Realtime
7F = ID of target device
04 = Sub-ID #1=Device Control Message
01 = Sub-ID #2=Master Volume
// = Volume LSB
mm = Volume MSB
F7 = End of Exclusive
- or
- F0 = Exclusive status
7F = Universal Realtime
XN = When N is received N=0~F, whichever is received.
x = don't care
04 = Sub-ID #1=Device Control Message
01 = Sub-ID #2=Master Volume
// = Volume LSB
mm = Volume MSB
F7 = End of Exclusive

(3) Universal Non-Realtime Message

General MIDI Mode On

Data format: [F0H] -> [7EH] -> [XnH] -> [09H] -> [01H] -> [F7H]

- F0 = Exclusive status
7E = Universal Non-Realtime
7F = ID of target device
09 = Sub-ID #1=General MIDI Message
01 = Sub-ID #2=General MIDI On
F7 = End of Exclusive
- or
- F0 = Exclusive status
7E = Universal Non-Realtime
XN = When N is received N=0~F, whichever is received.
X = don't care
09 = Sub-ID #1=General MIDI Message
01 = Sub-ID #2=General MIDI On
F7 = End of Exclusive

When the General MIDI mode ON message is received, the MIDI system will be reset to its default settings.

This message requires approximately 50ms to execute, so sufficient time should be allowed before the next message is sent.

(4) XG Native Parameter Change

Data format: [F0H] -> [43H] -> [1nH] -> [4CH] -> [hh] -> [mm] -> [//] -> [dd] -> [F7H]

- F0 = Exclusive status
43 = YAMAHA ID
1n = When n is received n=0~F, whichever is received.
When n is transmitted n always=0.
4C = Model ID of XG
hh = Address High
mm = Address Mid
// = Address Low
dd = Data
|
F7 = End of Exclusive

Data size must match parameter size (2 or 4 bytes).

When the XG System On message is received, the MIDI system will be reset to its default settings.

The message requires approximately 50ms to execute, so sufficient time should be allowed before the next message is sent.

(5) XG Native Bulk Data (reception only)

Data format: [F0H] -> [43H] -> [0nH] -> [4CH] -> [aa] -> [bb] -> [hh] -> [mm] -> [ll] -> [dd] ->...-> [cc] -> [F7H]

F0	Exclusive status
43	YAMAHA ID
0n	When n is received n=0-F, whichever is received. When n is transmitted n always=0.
4C	Model ID of XG
aa	ByteCount
bb	ByteCount
hh	Address High
mm	Address Mid
ll	Address Low
dd	Data
cc	Check sum
F7	End of Exclusive

For information about "Address" and "Byte Count" fields, refer to attached tables.

In the attached tables "TOTAL SIZE" partitions a data series into single bulk dumps. The "address" is the first byte of the bulk data. The checksum value is set such that the sum of Byte Count, Address, Data, and Checksum has value zero in its seven least significant bits.

If too much bulk data is received at a time there is a chance of error. The total data for a bulk dump should not exceed 512 bytes, it is recommended that data be kept under 512 bytes with an interval time of 120msec or more between 512 byte bulk.

(6) Clavinova MIDI Format

Data format: [F0H] -> [43H] -> [73H] -> [3BH] -> [yy] -> [F7H]

F0	= Exclusive status
43H	= Yamaha ID
73H	= Clavinova ID
3BH	= CLP-555 ID
yy	= Substatus

yy	Information
02H	Internal MIDI clock
03H	External MIDI clock
06H	Bulk Data

* The bulk data follows 06H.

* When yy=2, 3 or Clavinova common ID (01H) is recognized as well as 3BH.

BULK DUMP FORMAT

F0H, 43H, 73H
nnH (Product ID: CLP-555=4F)
06H (Bulk ID)
05H (Sequence data, Bulk Dump Format)
0xH, 0xH, 0xH, 0xH (Data length= xxxx bytes)
[BULK DATA] (low, high.....low, high)
[CHECK SUM (1byte)] = 0-sum (BULK DATA)
F7H

(7) Special Control

Data format: [F0H] -> [43H] -> [73H] -> [3BH] -> [11H] -> [0nH] -> [cc] -> [vv] -> [F7H]

43H	= Yamaha ID
73H	= Clavinova ID
3BH	= CLP-555 ID
11H	= Clavinova special control
0nH	= Control MIDI change + channel number
cc	= Control number
vv	= Value

Control	0nH	ccH	dd
Split Point	Always 00	14H	14H : Split Key Number
Metronome	Always 00	1BH	00H : off 01H : - 02H : 2/4 03H : 3/4 04H : 4/4 05H : 5/4 06H : 6/4 07H : No accent
Channel Detune	ch: 00-0F	43H	00H-7FH
Voice Reserve	ch: 00-0F	45H	00H : Reserve off 7FH : on *1

*1 When Volume, Expression is received for Reserve On, they will be effective from the next Key On. Reserve Off is normal.

(8) Others

Data format: [F0H] -> [43H] -> [1nH] -> [27H] -> [30H] -> [00H] -> [00H] -> [mmH] -> [llH] -> [ccH] -> [F7H]

Master Tuning (XG and last message priority) simultaneously changes the pitch of all channels.

F0H	= Exclusive Status
43H	= Yamaha ID
1nH	= Transmission from n=CLP is always 0. 0-F is received.
27H	= Model ID of TG100
30H	= Sub ID
00H	=
00H	=
mmH	= Master Tune MSB
llH	= Master Tune LSB
ccH	= don't care (under 7FH)
F7H	= End of Exclusive

MIDI Data Format/MIDI-Datenformat/Format des données MIDI/Formato de datos MIDI

<Table 1-1>

MIDI Parameter Change table (SYSTEM)

Address (H)	Size (H)	Data (H)	Parameter	Description	Default value (H)
00 00 00	4	020C - 05F4(*1)	MASTER TUNE	-50 - +50[cent] 1st bit 3 - 0 → bit 15 - 12	00 04 00 00
01				2nd bit 3 - 0 → bit 11 - 8	400
02				3rd bit 3 - 0 → bit 7 - 4	
03				4th bit 3 - 0 → bit 3 - 0	
04	1	00 - 7F	MASTER VOLUME	0 - 127	7F
05	1	—	—	—	—
06	1	34 - 4C(*2)	TRANSPOSE	-12 - +12[semitones]	40
7E		00	XG SYSTEM ON	00=XG sytem ON	
7F		00	RESET ALL PARAMETERS	00=ON (receive only)	
TOTAL SIZE	07				

*1: Values lower than 020CH select -50 cents. Values higher than 05F4H select +50 cents.

*2: Values from 28 through 33 are interpreted as -12 through -1. Values from 4D through 58 are interpreted as +1 through +12.

<Table 1-2>

MIDI Parameter Change table (EFFECT 1)

Refer to the "Effect MIDI Map" for a complete list of Reverb, Chorus and Variation type numbers.

Address (H)	Size (H)	Data (H)	Parameter	Description	Default value (H)
02 01 00	2	00-7F	REVERB TYPE MSB	Refer to Effect MIDI Map	01(=HALL1)
		00-7F	REVERB TYPE LSB	00 : basic type	00
0C	1	00-7F	REVERB RETURN	-∞dB...0dB...+6dB(0...64...127)	40
TOTAL SIZE	0E				
02 01 40	2	00-7F	VARIATION TYPE MSB	Refer to Effect MIDI Map	00(=Effect off)
		00-7F	VARIATION TYPE LSB	00 : basic type	00
TOTAL SIZE	21				

* "VARIATION" refers to the EFFECT on the panel.

<Table 1-3>

MIDI Parameter Change table (MULTI PART)

Address (H)	Size (H)	Data (H)	Parameter	Description	Default value (H)
08 nn 11	1	00 - 7F	DRY LEVEL	0 - 127	7F

nn = PartNumber

● Effect MIDI Map

REVERB TYPE

TYPE MSB		TYPE LSB			
DEC	HEX	00	01	02	03~
000	0	Effect Off	<—	<—	<—
001	1	Hall1	Hall2	Hall1	<—
002	2	Room1	<—	<—	<—
003	3	Stage1	<—	<—	<—
004	4	No Effect	<—	<—	<—
:	:	:			

<— Same as Basic Effect (LSB=0)

VARIATION TYPE

TYPE MSB		TYPE LSB			
DEC	HEX	00	01	02	03~
000	0	Effect Off	<—	<—	<—
:	:	No Effect	<—	<—	<—
065	41	Chorus1	<—	<—	<—
:	:	No Effect	<—	<—	<—

<— Same as Basic Effect (LSB=0)

MIDI Implementation Chart

Function	Transmitted	Recognized	Remarks
Basic Default Channel Changed	1 1~16	1 1~16	
Mode Default Messages	3 × *****	1 × × *1	Poly Mode only
Note Number : True voice	9~120 *****	0~127 21~108	
Velocity Note on Note off	○ 9nH, v=1~127 × 9nH, v=0	○ v=1~127 ×	
After key's Touch Ch's	× ×	× ×	
Pitch Bender	×	×	
Control Change	0, 32 ○ 07 × 11 × 64 ○ 66 ○ 67 ○ 91 ○ 94 ○ 120 × 121 ×	○ ○ ○ ○ ○ ○ ○ ○ ○ ○ ○	Bank Select Volume Expression Damper Sostenuto Soft pedal Reverb Depth Effect Depth All sounds off Reset All Controllers
Program Change : True #	○ *****	○	
System Exclusive	○	○	
System : Song Position : Song Select Common : Tune	× × ×	× × ×	
System : Clock Real Time : Commands	○ ○	○ ○	
Aux : Local ON/OFF : All Notes Off Messages : Active Sense : Reset	× ○ ○ ×	× ○ (123~127) ○ ×	
Notes : *1 = Recieve Mode is always multi timbre and Poly mode.			

Mode 1: OMNI ON, POLY
Mode 3: OMNI OFF, POLY

Mode 2: OMNI ON, MONO
Mode 4: OMNI OFF, MONO

○: Yes
×: No

1

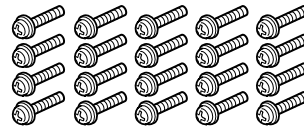
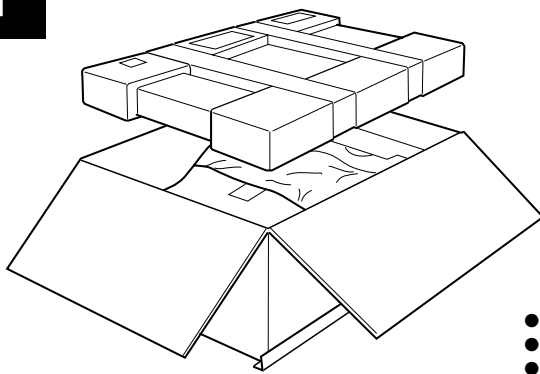

5 x 20 mm long screws
Lange Schrauben
(5 x 20 mm)
Vis longue 5 x 20 mm
Tornillos largos de 5 x 20 mm

x 20



● Cord holders
● Kabelhalter
● Serre-câble
● Soportes de cable

x 2

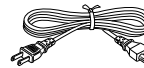

● AC power cord
● Netzkabel
● Cordon d'alimentation
● Cable de alimentación de CA

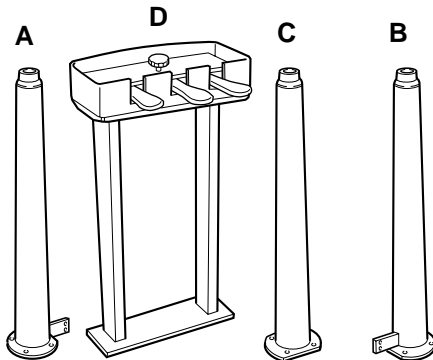

● Front leg A
● Vorderes Standbein A
● Pied avant A
● Pata frontal A

● Front leg B
● Vorderes Standbein B
● Pied avant B
● Pata frontal B

● Rear leg C
● Hinteres Standbein C
● Pied arrière C
● Pata trasera C

● Pedal box D
● Pedalkasten D
● Pédalier D
● Caja de pedales D

Keyboard Stand Assembly

- NOTE**
- Be careful not to confuse parts, and be sure to install all parts in the correct direction. Please assemble in accordance with the sequence given below.
 - Assembly should be carried out by at least two persons.
 - Be sure to use the correct screw size, as indicated above. Use of incorrect screws can cause damage.
 - Be sure to tighten up all screws upon completing assembly of each unit.
 - The entire package must be turned over during assembly, so select an area that is large enough for the unpacking and assembly operation.

1 Open the carton and remove the parts from the upper level.

Referring to the illustration, make sure that you have all the required parts.

- NOTE**
- A bench may be supplied or optional, depending on the location in which the instrument was purchased.

2 Attach the three legs (A, B, C).

Use scissors or a cutter to remove the packing material in which the main unit is wrapped. Then attach the legs to the bottom of the main unit using four 5 x 20 mm long screws per leg. Please refer to the illustration carefully when attaching the legs, to ensure that the positions of the (A) and (B) legs are not reversed. Also make sure that there is minimum space between the (A) and (B) leg flanges and the metal frame on the bottom of the main unit (the screws which attach the legs to this frame will be installed later, in step 6).

Zusammenbau und Aufstellung

- HINWEISE**
- Achten Sie darauf, die Teile nicht zu verwechseln, und installieren Sie alle Teile in der richtigen Ausrichtung. Gehen Sie beim Zusammenbau bitte in der angegebenen Reihenfolge vor.
 - Die Montage sollte von mindestens zwei Personen vorgenommen werden.
 - Achten Sie darauf, die richtige Schraubengröße zu verwenden, wie es oben gezeigt ist. Die Verwendung der falschen Schrauben kann zu Schäden führen.
 - Achten Sie während der Montage darauf, bei jedem Arbeitsgang alle Schrauben festzuziehen.
 - Das Instrument wird im Karton zusammengebaut und muß abschließend zum Aufstellen umgedreht werden. Achten Sie darauf, daß ausreichend Platz zum Auspacken und Aufstellen vorhanden ist.

1 Den Karton öffnen und die Teile der obersten Lage herausnehmen.

Prüfen Sie anhand der Abbildung, ob die Teile vollständig vorhanden sind.

- HINWEIS**
- Je nach Vertriebsland wird eine Sitzbank entweder standardmäßig mitgeliefert oder ist als Sonderzubehör erhältlich.

2 Die drei Standbeine (A, B und C) montieren.

Entfernen Sie das Verpackungsmaterial an der Unterseite des Instruments mit einer Schere oder einem anderen Schneidwerkzeug. Schrauben Sie dann die drei Standbeine mit jeweils vier langen Schrauben (5 x 20 mm) an das Instrument. Richten Sie sich bei der Montage der Standbeine bitte nach der Abbildung — die vorderen Standbeine (A und B) dürfen nicht vertauscht werden. Achten Sie auch darauf, daß zwischen den Ansätzen an den vorderen Standbeinen (A und B) und dem Metallrahmen an der Unterseite des Instruments ein möglichst kleiner Zwischenraum verbleibt (die Standbeine werden an späterer Stelle, in Schritt 6, mit diesem Rahmen verschraubt).

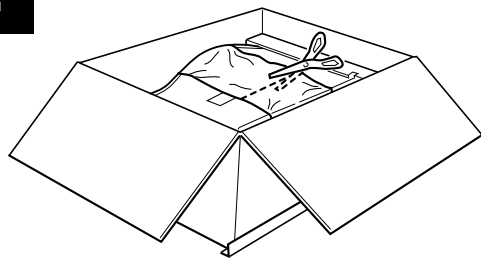
2

5 x 20 mm long screws
Lange Schrauben (5 x 20 mm)
Vis longue 5 x 20 mm
Tornillos largos de 5 x 20 mm

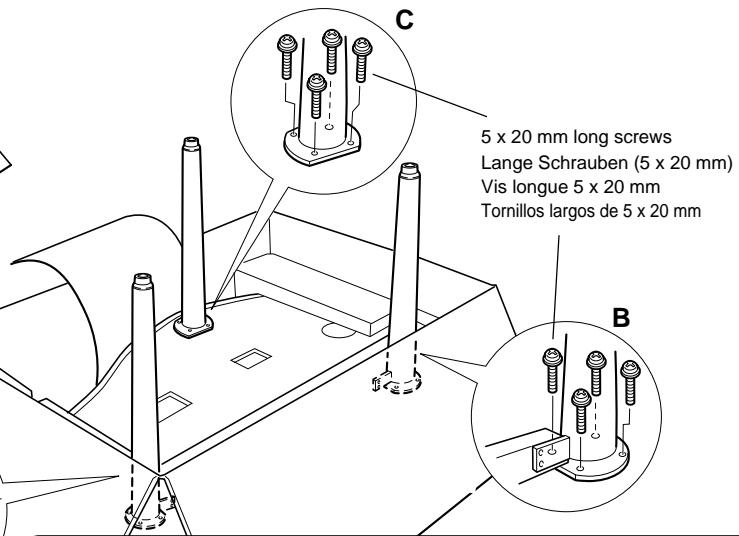
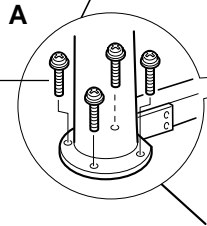

5 x 20 mm long screws
Lange Schrauben (5 x 20 mm)
Vis longue 5 x 20 mm
Tornillos largos de 5 x 20 mm

B

Minimum space between the leg flanges and the metal frame.

Minimaler Zwischenraum zwischen Ansatz und Metallrahmen.

Espace minimum entre les collerettes de pieds et le châssis métallique.

Espacio mínimo entre las bridas de las patas y el bastidor metálico.

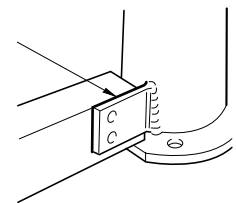

Assemblage du support de clavier



- Veiller à ne pas mélanger les pièces et à les installer dans le sens correct. Veuillez assembler l'instrument dans l'ordre indiqué ci-dessous.
- La présence de deux personnes minimum est nécessaire pour procéder au montage.
- Toujours utiliser des vis aux dimensions correctes, comme indiqué cidessus. l'utilisation de vis aux dimensions incorrectes pourrait en effet endommager l'instrument.
- Resserrer convenablement toutes les vis après le montage de chaque élément.
- L'ensemble du carton d'emballage doit être retourné pendant le montage aussi, choisir un endroit suffisamment spacieux pour les opérations de déballage et de montage.

1 Ouvrir le carton et retirer les pièces du niveau supérieur.

Vérifier que toutes les pièces figurant sur l'illustration se trouvent bien dans le carton.



- Un banc peut être fourni ou en option, selon l'endroit où l'instrument a été acheté.

2 Monter les trois pieds (A, B, C).

Utiliser une paire de ciseaux ou un cutter pour retirer les matériaux dans lesquels l'instrument est emballé. Puis, monter les pieds au-dessous de l'instrument avec quatre vis longues 5 x 20 mm par pied. Pour le montage des pieds, se référer soigneusement à l'illustration afin de garantir que la position des pieds (A) et (B) n'est pas inversée. S'assurer aussi qu'il y a un espace minimum entre les collerettes de pieds (A) et (B) et le châssis métallique sous l'instrument (les vis qui fixent les pieds sur ce châssis seront installées ultérieurement, à l'étape 6).

Conjunto del soporte del teclado



- Observe cuidado para no confundir las piezas, y asegúrese de montar todas ellas en el sentido correcto. Proceda al montaje en el orden indicado a continuación.
- El montaje deberá realizarse al menos por dos personas.
- Procure utilizar los tornillos del tamaño adecuado, según se indica arriba. El empleo de tornillos inadecuados puede ocasionar daños en el instrumento.
- Asegúrese de apretar bien todos los tornillos después de montar cada unidad.
- Deberá dar la vuelta a todo el paquete durante el montaje, por lo que es mejor que seleccione un lugar espacioso para efectuar el desembalaje y el montaje.

1 Abra el cartón y extraiga las partes del nivel superior.

Consultando la ilustración, asegúrese de que dispone de todas las partes necesarias.



- Es posible que se suministre un banco o que sea opcional, dependiendo del lugar de venta del instrumento.

2 Coloque las tres patas (A, B, C).

Emplee unas tijeras o un cortador para sacar el material de embalaje en el que está envuelta la unidad principal. Luego, monte las patas en la parte inferior de la unidad principal empleando cuatro tornillos largos de 5 x 20 mm por pata. Consulte con cuidado la ilustración para asegurarse de que las posiciones de las patas (A) y (B) no se invierten. Asegúrese también que existe un espacio mínimo entre las bridas de las patas (A) y (B) y el bastidor metálico en la parte inferior de la unidad principal (los tornillos que se unen las patas a este bastidor se instalarán después, en el paso 6).

3

5 x 20 mm long screws
 Lange Schrauben (5 x 20 mm)
 Vis longue 5 x 20 mm
 Tornillos largos de 5 x 20 mm

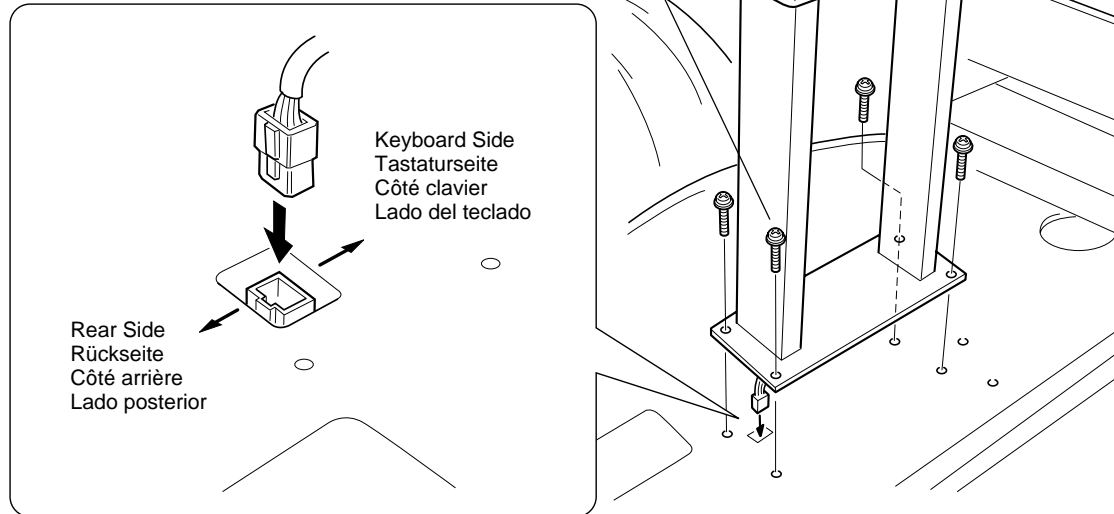

3 Attach the pedal box (D).

Before attaching the pedal box, connect the pedal cord. Pull the pedal plug out from the hole in the base plate and plug it into the socket in the bottom of the main unit with the lug on the plug facing the rear of the main unit (refer to the illustration). If the plug won't go in properly, don't force it ... check the plug orientation and try again.

Making sure that the pedal cord doesn't get caught between the base plate and main unit, carefully lower the pedal box assembly onto the bottom of the main unit and line up the screw holes. Finally, attach the pedal box with four 5 x 20 mm long screws.

4 Turn over the instrument and packing.

Make sure that the three legs are firmly attached, then using the front legs (A) and (B) for support, turn over the instrument and packing so that the carton is on top of the instrument.

3 Den Pedalkasten (D) montieren.

Schließen Sie vor der Montage des Pedalkastens zunächst das Pedalkabel an. Führen Sie den Kabelstecker durch das Loch in der Grundplatte, um ihn dann, mit der Führungsnase zur Rückseite des Instruments weisend, an die Buchse an der Unterseite anzuschließen (siehe Abbildung). Wenn der Stecker nicht in die Buchse paßt, bitte nicht mit Gewalt hineinstecken ... prüfen Sie seine Ausrichtung, und versuchen Sie es dann noch einmal.

Setzen Sie den Pedalkasten nun so auf der Unterseite des Instruments an, daß das Pedalkabel nicht zwischen Grundplatte und Instrument eingeklemmt wird und die Schraubenbohrungen zur Deckung kommen. Schrauben Sie den Pedalkasten dann mit vier langen Schrauben (5 x 20 mm) fest.

4 Das Instrument mit dem Karton aufstellen.

Prüfen Sie noch einmal, ob die drei Standbeine fest montiert sind, und stellen Sie das Instrument dann über die vorderen Standbeine (A und B) so aufrecht, daß der Karton oben ist.

4

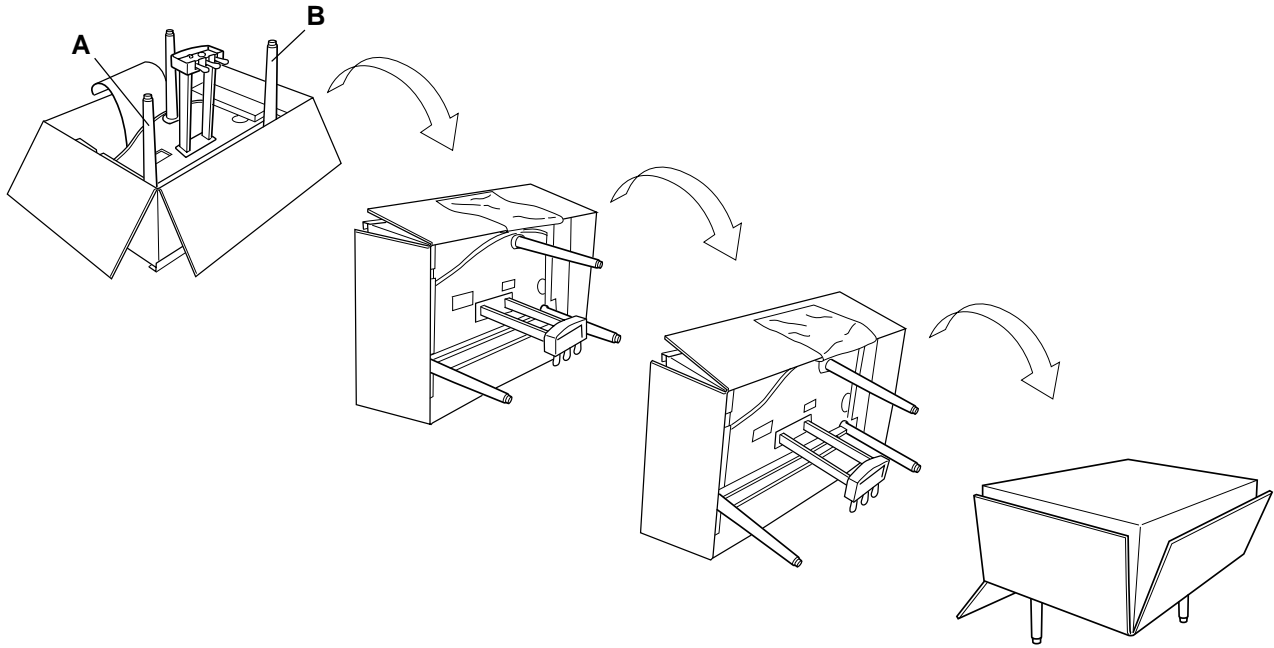

3 Monter le pédalier (D).

Avant de monter le pédalier, raccordez son cordon. Sortir le connecteur de pédalier de l'orifice de l'embase et le brancher dans la prise sous de l'instrument, la cosse du connecteur orienté vers l'arrière de l'instrument (comme indiqué sur l'illustration). Si la prise est difficile à enclencher, ne pas forcer... vérifier l'orientation de la prise et essayer à nouveau.

En vérifiant que le cordon du pédalier n'est pas pincé entre l'embase et l'instrument, abaisser soigneusement l'ensemble de pédalier en place au bas de l'instrument et l'aligner sur les trous de vis. Pour finir, monter le pédalier avec quatre vis longues 5 x 20 mm.

4 Retourner l'instrument et l'emballage.

Vérifier que les trois pieds sont fermement fixés, puis, en utilisant les pieds avant (A) et (B) comme support, retourner l'instrument et l'emballage, de manière à ce que le carton se trouve sur l'instrument.

3 Coloque la caja de pedales (D).

Antes de montar la caja de pedales, conecte el cable de los pedales. Tire de la clavija de pedales desde el orificio de la placa de la base y enchúfelo a la toma de la parte inferior de la unidad principal con el apéndice de la clavija encarado a la parte posterior de la unidad principal (consulte la ilustración). Si la clavija no entra correctamente, no la fuerza ... compruebe la orientación de la clavija e inténtelo de nuevo.

Teniendo cuidado de que el cable de los pedales no queda pillado entre la placa de la base y la unidad principal, baje con cuidado el conjunto de la caja de pedales a la parte inferior de la unidad principal y alinee los orificios de los tornillos. Finalmente, monte la caja de pedales con cuatro tornillos largos de 5 x 20 mm.

4 Dé la vuelta al instrumentos y al embalaje.

Asegúrese de que las tres patas estén firmemente unidas, y empleando las patas frontales (A) y (B) como soporte, dé la vuelta al instrumento y al embalaje de modo que el cartón quede en la parte superior del instrumento.

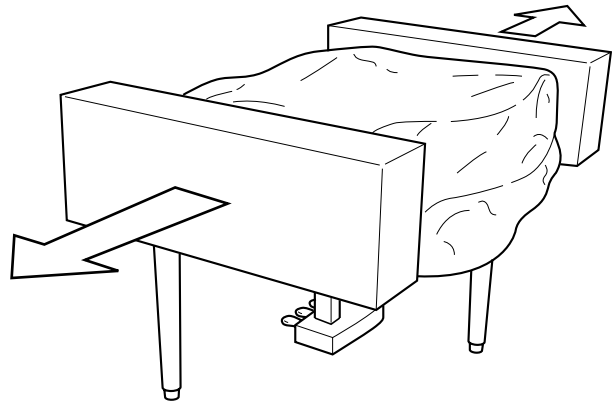
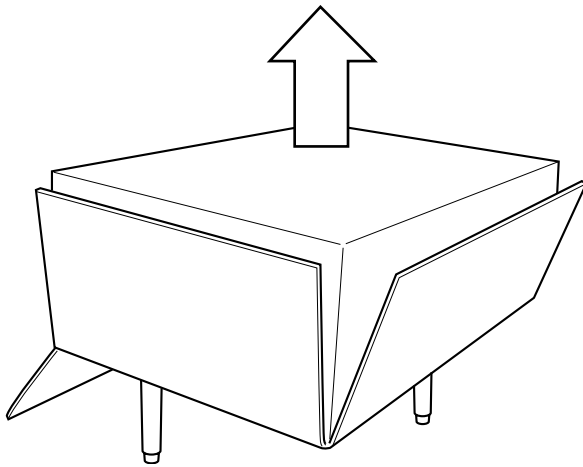
5**5 Remove the carton and packing material.**

Lift and remove the carton, then remove the remaining packing material from the main unit.

6 Attach the front leg/frame screws.

Firmly attach the front legs (A) and (B) to the frame on the bottom of the main unit using two 5 x 20 mm long screws for each leg.

7 Voltage Selector

Check the setting of the voltage selector which is provided in some areas. To set the selector for 110V, 127V, 220V or 240V main voltages, use a "minus" screwdriver to rotate the selector dial so that the correct voltage for your region appears next to the pointer on the panel. The voltage selector is set at 240V when the unit is initially shipped.

5 Den Karton und das Verpackungsmaterial entfernen.

Heben Sie zunächst den Karton weg, und entfernen Sie dann die beiden Formstücke und das übrige Verpackungsmaterial.

6 Die vorderen Standbeine mit dem Rahmen verschrauben.

Schrauben Sie die vorderen Standbeine (A und B) mit jeweils zwei langen Schrauben (5 x 20 mm) gut am Rahmen an der Unterseite des Instruments fest.

7 Den Spannungswähler einstellen.

Stellen Sie den Spannungswähler (falls vorhanden) auf die örtliche Netzspannung ein. Zum Verstellen drehen Sie den Spannungswähler mit einem Schlitzschraubendreher, bis der richtige Spannungswert (110, 127, 220 oder 240) an der Pfeilmarkierung steht. Bei der Auslieferung werden alle Instrumente mit Spannungswähler auf "240" voreingestellt.

6

5 x 20 mm long screws
Lange Schrauben (5 x 20 mm)
Vis longue 5 x 20 mm
Tornillos largos de 5 x 20 mm

5 x 20 mm long screws
Lange Schrauben (5 x 20 mm)
Vis longue 5 x 20 mm
Tornillos largos de 5 x 20 mm

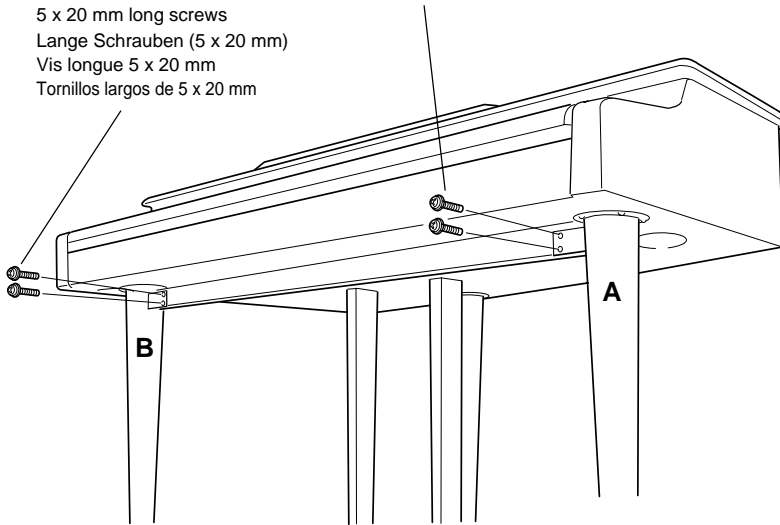
**7**

- A voltage selector is provided in some areas.
- Spannungswähler (nur in bestimmten Verkaufsgebieten)
- Un sélecteur de tension est prévu pour certaines régions
- El selector de tensión está provisto para ciertos destinos.

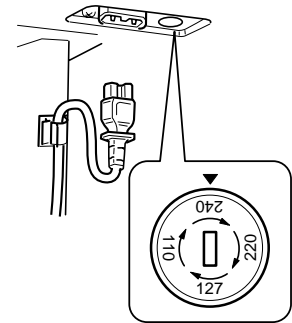

5 Retirer le carton et les matériaux de garniture.

Soulever le carton et le retirer, puis retirer les matériaux d'emballage qui restaient sur l'instrument.

6 Fixer les vis pieds avant/châssis.

Fixer fermement, sous l'instrument, les pieds avant (A) et (B) au châssis avec deux vis longues 5 x 20 mm par pied.

7 Sélecteur de tension.

Vérifiez le réglage du sélecteur de tension qui est prévu pour certaines régions. Pour régler le sélecteur sur 110 V, 127 V, 220 V ou 240 V, utilisez un tournevis à lame plate pour tourner le cadran du sélecteur afin de mettre l'indication correspondant à la tension de votre région vis à vis du repère triangulaire situé sur le panneau. Le sélecteur de tension est réglé sur 240 V au départ d'usine.

5 Extraiga el cartón y el material de embalaje.

Levante y extraiga el cartón, y saque entonces el material de embalaje restante de la unidad principal.

6 Monte los tornillos de las patas frontales/bastidor.

Coloque firmemente las patas frontales (A) y (B) en el bastidor en la parte inferior de la unidad principal empleando dos tornillos largos de 5 x 20 mm para cada pata.

7 Selector de tensión.

Compruebe el ajuste del selector de tensión que se incorpora para ciertos destinos. Para ajustar el selector a 110V, 127V, 220V ó 240V de la red de alimentación, emplee un destornillador de cabeza recta "-" para girar el selector de modo que la tensión correcta de su zona aparezca al lado del indicador del panel. El selector de tensión se ajusta a 240V cuando la unidad sale de fábrica.

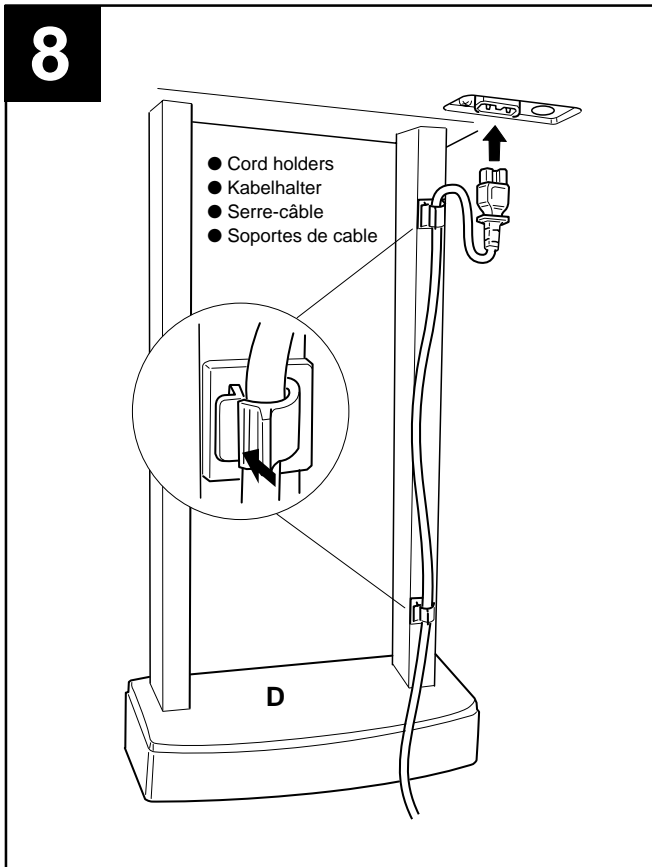

8 Attach the cord holders and plug in the AC cord.

Remove the protective backing from the adhesive surface of the cord holders, and attach at approximately the locations shown in the illustration. Plug the main-unit end of the AC cord into the corresponding socket on the bottom of the main unit, then secure the cord with the cord holders.

A plug adaptor may be also provided in some areas to match the pin configuration of the AC wall outlets in your area.

9 Set the adjuster.

For stability, an adjuster is provided on the bottom of the pedal box (D). Rotate the adjuster until it comes in firm contact with the floor surface. The adjuster ensures stable pedal operation and facilitates pedal effect control. If the adjuster is not in firm contact with the floor surface, distorted sound may result.

■ After completing the assembly, please check the following.

- Are there any parts left over?
→ Review the assembly procedure and correct any errors.
- Is the Clavinova clear of doors and other movable fixtures?
→ Move the Clavinova to an appropriate location.
- Does the Clavinova make a rattling noise when you shake it?
→ Tighten all screws.
- Does the pedal box rattle or give way when you step on the pedals?
→ Turn the adjuster so that it is set firmly against the floor.
- Are the pedal and power cords inserted securely into the sockets?
→ Check the connection.
- If the main unit creaks or is otherwise unsteady when you play on the keyboard, refer to the assembly diagrams and retighten all screws.

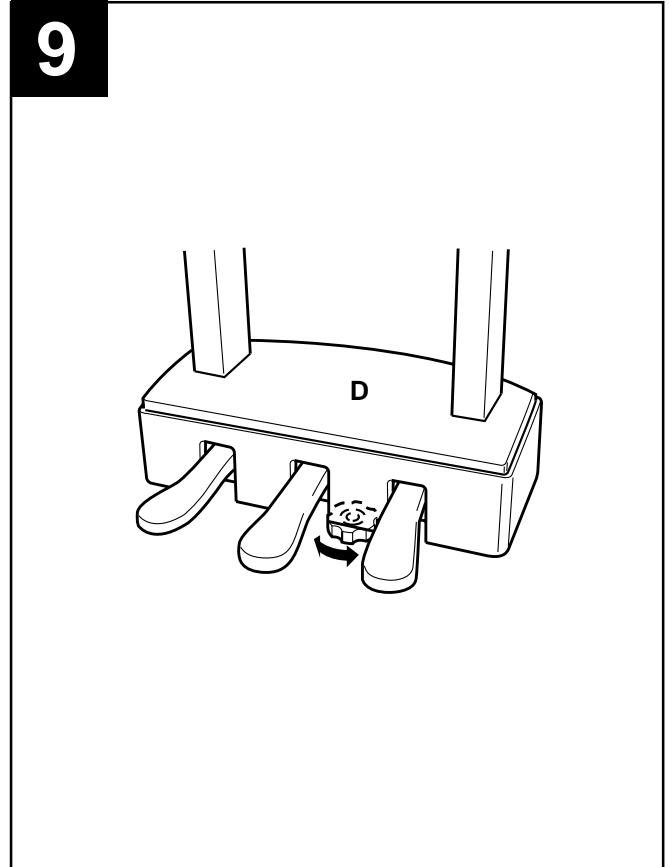

8 Die Kabelhalter anbringen und das Netzkabel anschließen.

Ziehen Sie das Schutzpapier von der Klebefläche der Kabelhalter ab, und bringen Sie die Halter ungefähr an den in der Abbildung gezeigten Stellen an. Stecken Sie den kleineren Stecker des Netzkabels in die entsprechende Buchse an der Unterseite des Instruments, um das Kabel dann in die Kabelhalter zu legen.

In manchen Gebieten wird ein Steckeradapter mitgeliefert, um den Anschluß an die evtl. unterschiedlich geformte Steckdose zu ermöglichen.

9 Den Pedalfuß einstellen.

Um dem Pedalkasten (D) mehr Standfestigkeit zu geben, ist er mit einem verstellbaren Pedalfuß ausgestattet. Drehen Sie diesen Fuß heraus, bis er fest auf der Bodenfläche steht. Der Pedalfuß stabilisiert den Pedalkasten und ermöglicht eine präzise Pedalbetätigung. Wenn der Pedalfuß nicht fest auf dem Boden steht, können Klangverzerrungen auftreten.

■ Wenn der Zusammenbau beendet ist, prüfen Sie bitte folgende Dinge:

- Sind Teile übrig geblieben?
→ Gehen Sie den Vorgang des Zusammenbaus noch einmal durch und korrigieren Sie eventuelle Fehler.
- Befindet sich das Clavinova weit genug von Türen und anderen beweglichen Vorrichtungen entfernt?
→ Bewegen Sie das Clavinova an einen entsprechend sicheren Ort.
- Macht das Clavinova Klappergeräusche, wenn Sie es schütteln?
→ Ziehen Sie alle Schrauben fest.
- Klappert der Pedalkasten oder gibt er nach, wenn Sie das Pedal treten?
→ Drehen Sie den Höhenversteller, bis er fest auf dem Fußboden steht.
- Sind Pedal- und Netzkabel richtig an den Buchsen angeschlossen?
→ Prüfen Sie die Verbindung.
- Wenn die Haupteinheit knarrt oder beim Spielen wackelt, betrachten Sie die Abbildungen und ziehen Sie alle Schrauben noch einmal nach.

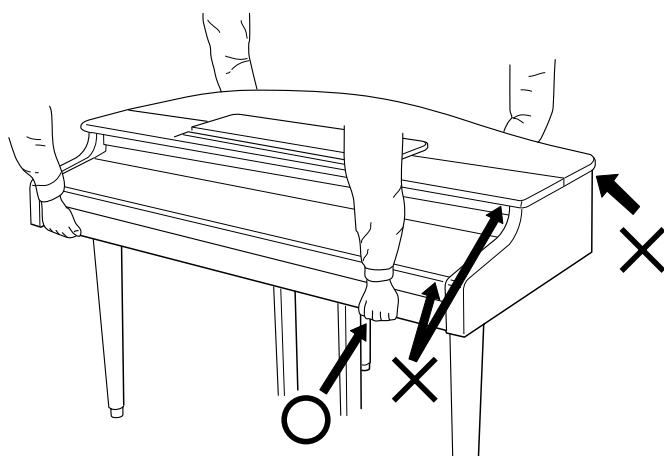

CAUTION • When moving the instrument after assembly, always hold the lower surface of the main unit, NEVER the lid or keyboard cover. Improper handling can result in damage to the instrument or personal injury.

ACHTUNG • Fassen Sie zum Umstellen des Instruments nach dem Zusammenbau stets unter das Gehäuse; heben Sie es niemals am Gehäuse- oder Tastaturdeckel. Bei Nichtbeachtung dieses Punkts kann das Instrument beschädigt und im Extremfall eine Verletzung hervorgerufen werden.

ATTENTION • Pour déplacer l'instrument après le montage, toujours tenir l'instrument par la surface inférieure, JAMAIS par le couvercle ou le protège-clavier. Une mauvaise manipulation peut provoquer des dommages ou des blessures.

PRECAUCION • Cuando mueva el instrumento después del montaje, sostenga siempre la superficie inferior de la unidad principal. NUNCA por la tapa ni cubierta del teclado. La manipulación indebida puede causar daños en el instrumento o personales.

8 Fixer les serre-fils et brancher le cordon de l'alimentation secteur.

Retirer le film protecteur des surfaces adhésives aux serre-fils et les fixer approximativement aux emplacements indiqués sur l'illustration. Brancher l'extrémité instrument du cordon secteur dans la prise correspondante au bas de l'instrument et fixer le cordon avec les serre-fils.

Un adaptateur de prise peut également être fourni dans certaines régions pour pouvoir brancher le cordon à la prise secteur murale.

9 Régler la hauteur du pédalier

Pour assurer la stabilité, un dispositif de réglage du pédalier (D) est équipé. Tourner ce dispositif jusqu'à ce qu'il soit en contact ferme avec le sol. Ce dispositif assure la stabilité du pédalier pendant son utilisation et facilite la commande au pied des effets. Si ce dispositif n'est pas fermement en contact avec le sol, le son pourra être déformé.

■ Lorsque le montage est terminé, veuillez mener à bien les vérifications suivantes.

- Reste-t-il des pièces non utilisées?
→ Passer en revue la procédure de montage et corriger toute erreur éventuelle.
- Le Clavinova est-il placé à l'écart des portes et de toute autre structure mobile?
→ Déplacer le Clavinova vers un emplacement approprié.
- Lorsque vous secouez quelque peu le Clavinova, entendez-vous un cliquetis?
→ Serrer convenablement toutes les vis.
- Le pédalier fait-il du bruit ou s'écarte-t-il lorsque vous appuyez sur les pédales?
→ Tourner le stabilisateur de sorte qu'il repose fermement sur le sol.
- Les cordons des pédales et d'alimentation sont-ils bien enfoncés dans les prises?
→ Vérifier toutes les connexions.
- Si la partie principale de l'appareil craque ou est instable lorsque vous jouez sur le clavier, consulter les diagrammes de montage et resserrer toutes les vis.

8 Monte los soportes de cable y enchufe el cable de CA

Extraiga el dorso protector de la superficie adhesiva de los soportes de cable, y colóquelos aproximadamente en los lugares mostrados en la ilustración. Enchufe e extremo de la unidad principal del cable de CA en la toma correspondiente de la parte inferior de la unidad principal, y fije el cable con los soportes de cables.

En algunas zonas puede suministrarse también un adaptador para adaptar la configuración de las patillas de los tomacorrientes de CA de su localidad.

9 Ajuste el ajustador.

Para mayor estabilidad, se proporciona un ajustador en la parte inferior de la caja de pedales (D). Gire el ajustador hasta que se ponga firmemente en contacto con la superficie del suelo. El ajustador asegura la operación estable de los pedales y facilita el control de efectos de los pedales. Si el ajustador no está firmemente en contacto con la superficie del suelo, puede producirse sonido distorsionado.

■ Cuando haya concluido el montaje, compruebe los siguientes puntos:

- ¿Ha quedado alguna pieza sin instalar?
→ Revise el procedimiento de montaje y corrija cualquier error que se haya podido cometer.
- ¿Está el Clavinova alejado del recorrido de puertas y muebles?
→ Traslade el Clavinova a una posición adecuada.
- ¿Suena algún ruido de holgura cuando se mueve el Clavinova?
→ Apriete con firmeza todos los tornillos.
- ¿Vibra o cede la caja de pedales cuando se pisan los pedales?
→ Gire el ajustador hasta que se apoye firmemente sobre el suelo.
- ¿Están perfectamente insertados los cables de pedal y alimentación en los conectores?
→ Revise las conexiones.
- Si la unidad principal cruje o presenta algún signo de inestabilidad cuando se toca el teclado, consulte los esquemas de montaje y vuelva a apretar todos los tornillos.

Demo Song List/Verzeichnis der Demo-Songs/ Liste des morceaux de démonstration/Lista de canciones de demostración

Voice Demo Tune Titles

Voice Name	Title	Composer
PIANO 1	Ballad No. 1 G minor op. 23	F. F. Chopin
PIANO 2	Lake Louise	Y. Kuramoto
CLAVINOVA TONE	Consolation No. 3	F. Liszt
HARPSICHOARD	"Allemande" from French Suite No. 5 BWV816	J. S. Bach
STRINGS	Salut d'amour op.12	E. Elgar
PIPE OPRGAN 1	"Prelude No.1 C major" from 8 Short Prelude and Fugues BWV553 — 560	J. S. Bach
PIPE ORGAN 2	Hymn "Allein Gott in der Höh' sei Ehr"	F. W. Zachow

* The demonstration pieces listed above are short excerpts from the original compositions. All other demo tunes are original (© 1997 by YAMAHA CORPORATION).

* Bei den oben aufgeführten Demo-Stücken handelt es sich um kurze Auszüge aus den Originalkompositionen. Die anderen Demo-Stücke sind geschützt (© 1997 by YAMAHA CORPORATION).

* Les morceaux de démonstration énumérés ci-dessus sont de courts extraits des compositions originales. Les autres morceaux de démonstration sont des morceaux originaux (© 1997 par YAMAHA CORPORATION).

* Las piezas de demostración arriba mencionadas son pasajes cortos de las composiciones originales. Todas las demás canciones son originales (© 1997 por YAMAHA CORPORATION).

Piano Song Titles

No.	Title	Composer	No.	Title	Composer
1	Für Elise	L. v. Beethoven	16	The Harvest Time	G. Lange
2	Dolly's Dreaming and Awakening	T. Oesten	17	Impromptu op.90-2	F. P. Schubert
3	Blumenlied	G. Lange	18	Waltz op.64-2	F. F. Chopin
4	"Marche Turke" from Sonata A major K.331"	W. A. Mozart	19	Nocturne op.9-2	F. F. Chopin
5	Waltz "Petit Chien" op.64-1	F. F. Chopin	20	Sonata C major K.545 1st Mov.	W. A. Mozart
6	Türkischer Marsch	L. v. Beethoven	21	1ère Arabesque	C. A. Debussy
7	Spinnerlied	A. Ellmenreich	22	La Prière d'une Vierge	T. Badarzewska
8	Alpenabendröte	T. Oesten	23	Frühlingslied	J. L. F. Mendelssohn
9	Sonatine Anh.6	L. v. Beethoven	24	La Violette	L. Streabbog
10	Melodie op.68-1	R. A. Schumann	25	Ecossaise G major	L. v. Beethoven
11	Heidenröslein	G. Lange	26	Arabesque	J. F. F. Burgmüller
12	La chevaleresque	J. F. F. Burgmüller	27	The Entertainer	S. Joplin
13	Minuet G major BWV Anh.114	J. S. Bach	28	Gavotte	G. P. Telemann
14	Ronde alla Turca	J. F. F. Burgmüller	29	Little Serenade	J. Haydn
15	Minuet G minor K.1e	W. A. Mozart	30	Allegro B major K.3	W. A. Mozart

Default Setting List/Liste der Vorgabeeinstellungen/ Liste des réglages par défaut/Lista de ajustes de fábrica

	Default
Voice	PIANO 1
Dual Mode	OFF
Split Mode	OFF
Split Mode Left-hand Voice	STRINGS
Reverb Type	ROOM
Reverb Depth	10
Effect	OFF
Effect Depth	Preset for each voice
Transpose	0
Touch Sensitivity	MEDIUM
Touch Volume in the FIXED Mode	64
Metronome	OFF
Metronome Volume	10
Tempo	120

Function

Function	Default
F1 : Tuning	A3=440Hz
F2 : Scale	1 (Equal Temperament)
F3.1 : Dual Balance	Preset for each voice combination
F3.2 : Dual Detune	Preset for each voice combination
F3.3/F3.4 : Dual Octave Shift	Preset for each voice combination
F3.5/F3.6 : Dual Effect Depth	Preset for each voice combination
F3.7 : Slow-attack Strings	OFF
F4.1 : Split Point	F#2
F4.2 : Split Balance	Preset for each voice combination
F4.3/F4.4 : Split Octave Shift	Preset for each voice combination
F4.5/F4.6 : Split Effect Depth	Preset for each voice combination
F4.7 : Damper Mode	ALL
F5.1 : Metronome Beat	0 (no accent)
F5.2 : Metronome Volume	10
F6 : Left Pedal Mode	1 (soft pedal)
F7 : Piano Song Part Cancel Volume	5
F8.1 : MIDI Transmit Channel	1
F8.2 : MIDI Receive Channel	ALL
F8.3 : Local Control	ON
F8.4 : Program Change Send & Receive	ON
F8.5 : Control Change Send & Receive	ON
F8.6 : MIDI Transmit Transpose	0
F9 : Backup	All OFF

Specifications/Technische Daten/Caractéristiques techniques/Especificaciones

		CLP-555
KEYBOARD		88 KEYS (A-1 ~ C7)
POLYPHONY		32 NOTES MAX.
VOICE SELECTORS		PIANO 1, PIANO 2, CLAVINOVA TONE, E. PIANO 1, E. PIANO 2, HARPSICHORD, STRINGS, PIPE ORGAN 1, PIPE ORGAN 2, VARIATION
REVERB		ROOM, HALL 1, HALL 2, STAGE
TOUCH SENSITIVITY		HARD, MEDIUM, SOFT, FIXED
RECORDER		1, 2, START/STOP, REC
PEDAL CONTROLS		SOFT, SOSTENUTO, DAMPER
OTHER CONTROLS		MASTER VOLUME, FUNCTION, TRANSPOSE, SPLIT, EFFECT, METRONOME, TEMPO/SONG [▲]/[▼], LED Display, DEMO/PIANO SONG
JACKS/CONNECTORS		PHONES x 2, AUX OUT L/L+R & R, AUX IN L/L+R & R, MIDI IN/OUT/THRU, HOST SELECT, TO HOST
INPUT & OUTPUT LEVEL/IMPEDANCE		AUX OUT: Output impedance 600 Ω AUX IN: Input impedance 10 kΩ / Input sensitivity -10 dBm
MAIN AMPLIFIERS		30W x 2
SPEAKERS		14 cm x 2 , 5 cm x 2
DIMENSIONS (W x D x H)	Lid down	1417 x 870 x 884.4 mm (55-3/4" x 34-1/4" x 34-13/16")
	Lid up	1417 x 870 x 1228.9 mm (55-3/4" x 34-1/4" x 48-3/8")
WEIGHT		72 kg (158.7 lbs.)

* Specifications subject to change without notice.

* Änderungen ohne Vorankündigung vorbehalten.

* Sous toute réserve de modification des caractéristiques sans préavis.

* Especificaciones sujetas a cambios sin previo aviso.

IMPORTANT SAFETY INSTRUCTIONS

INFORMATION RELATING TO PERSONAL INJURY, ELECTRICAL SHOCK, AND FIRE HAZARD POSSIBILITIES HAS BEEN INCLUDED IN THIS LIST.

WARNING- When using any electrical or electronic product, basic precautions should always be followed. These precautions include, but are not limited to, the following:

- 1.** Read all Safety Instructions, Installation Instructions, Special Message Section items, and any Assembly Instructions found in this manual BEFORE marking any connections, including connection to the main supply.
- 2.** Main Power Supply Verification: Yamaha products are manufactured specifically for the supply voltage in the area where they are to be sold. If you should move, or if any doubt exists about the supply voltage in your area, please contact your dealer for supply voltage verification and (if applicable) instructions. The required supply voltage is printed on the name plate. For name plate location, please refer to the graphic found in the Special Message Section of this manual.
- 3.** This product may be equipped with a polarized plug (one blade wider than the other). If you are unable to insert the plug into the outlet, turn the plug over and try again. If the problem persists, contact an electrician to have the obsolete outlet replaced. Do NOT defeat the safety purpose of the plug.
- 4.** Some electronic products utilize external power supplies or adapters. Do NOT connect this type of product to any power supply or adapter other than one described in the owners manual, on the name plate, or specifically recommended by Yamaha.
- 5.** **WARNING:** Do not place this product or any other objects on the power cord or place it in a position where anyone could walk on, trip over, or roll anything over power or connecting cords of any kind. The use of an extension cord is not recommended! If you must use an extension cord, the minimum wire size for a 25' cord (or less) is 18 AWG. NOTE: The smaller the AWG number, the larger the current handling capacity. For longer extension cords, consult a local electrician.
- 6.** Ventilation: Electronic products, unless specifically designed for enclosed installations, should be placed in locations that do not interfere with proper ventilation. If instructions for enclosed installations are not provided, it must be assumed that unobstructed ventilation is required.
- 7.** Temperature considerations: Electronic products should be installed in locations that do not significantly contribute to their operating temperature. Placement of this product close to heat sources such as; radiators, heat registers and other devices that produce heat should be avoided.
- 8.** This product was NOT designed for use in wet/damp locations and should not be used near water or exposed to rain. Examples of wet/damp locations are; near a swimming pool, spa, tub, sink, or wet basement.
- 9.** This product should be used only with the components supplied or; a cart, rack, or stand that is recommended by the manufacturer. If a cart, rack, or stand is used, please observe all safety markings and instructions that accompany the accessory product.
- 10.** The power supply cord (plug) should be disconnected from the outlet when electronic products are to be left unused for extended periods of time. Cords should also be disconnected when there is a high probability of lightening and/or electrical storm activity.
- 11.** Care should be taken that objects do not fall and liquids are not spilled into the enclosure through any openings that may exist.
- 12.** Electrical/electronic products should be serviced by a qualified service person when:
 - a. The power supply cord has been damaged; or
 - b. Objects have fallen, been inserted, or liquids have been spilled into the enclosure through openings; or
 - c. The product has been exposed to rain; or
 - d. The product does not operate, exhibits a marked change in performance; or
 - e. The product has been dropped, or the enclosure of the product has been damaged.
- 13.** Do not attempt to service this product beyond that described in the user-maintenance instructions. All other servicing should be referred to qualified service personnel.
- 14.** This product, either alone or in combination with an amplifier and headphones or speaker/s, may be capable of producing sound levels that could cause permanent hearing loss. DO NOT operate for a long period of time at a high volume level or at a level that is uncomfortable. If you experience any hearing loss or ringing in the ears, you should consult an audiologist. IMPORTANT: The louder the sound, the shorter the time period before damage occurs.
- 15.** Some Yamaha products may have benches and/or accessory mounting fixtures that are either supplied as a part of the product or as optional accessories. Some of these items are designed to be dealer assembled or installed. Please make sure that benches are stable and any optional fixtures (where applicable) are well secured BEFORE using. Benches supplied by Yamaha are designed for seating only. No other uses are recommended.

PLEASE KEEP THIS MANUAL

For details of products, please contact your nearest Yamaha or the authorized distributor listed below.

Pour plus de détails sur les produits, veuillez-vous adresser à Yamaha ou au distributeur le plus proche de vous figurant dans la liste suivante.

Die Einzelheiten zu Produkten sind bei Ihrer unten aufgeführten Niederlassung und bei Yamaha Vertragshändlern in den jeweiligen Bestimmungsländern erhältlich.

Para detalles sobre productos, contacte su tienda Yamaha más cercana o el distribuidor autorizado que se lista debajo.

NORTH AMERICA

CANADA

Yamaha Canada Music Ltd.
135 Milner Avenue, Scarborough, Ontario,
M1S 3R1, Canada
Tel: 416-298-1311

U.S.A.

**Yamaha Corporation of America,
Keyboard Division**
6600 Orangethorpe Ave., Buena Park, Calif. 90620,
U.S.A.
Tel: 714-522-9011

MIDDLE & SOUTH AMERICA

MEXICO

**Yamaha De Mexico S.A. De C.V.,
Departamento de ventas**
Javier Rojo Gomez No.1149, Col. Gpe Del
Moral, Deleg. Iztapalapa, 09300 Mexico, D.F.
Tel: 686-00-33

BRASIL

Yamaha Musical Do Brasil LTDA.
Ave. Reboucas 2636, São Paulo, Brasil
Tel: 011-853-1377

PANAMA

Yamaha De Panama S.A.
Edificio Interseco, Calle Elvira Mendez no.10,
Piso 3, Oficina #105, Ciudad de Panama, Panama
Tel: 507-69-5311

OTHER LATIN AMERICAN COUNTRIES AND CARIBBEAN COUNTRIES

Yamaha Music Latin America Corp.
6101 Blue Lagoon Drive, Miami, Florida 33126,
U.S.A.
Tel: 305-261-4111

EUROPE

THE UNITED KINGDOM

Yamaha-Kemble Music (U.K.) Ltd.
Sherbourne Drive, Tilbrook, Milton Keynes,
MK7 8BL, England
Tel: 01908-366700

IRELAND

Danfay Ltd.
61D, Sallynoggin Road, Dun Laoghaire, Co. Dublin
Tel: 01-2859177

GERMANY/SWITZERLAND

Yamaha Europa GmbH.
Siemensstraße 22-34, 25462 Rellingen,
F.R. of Germany
Tel: 04101-3030

AUSTRIA

Yamaha Music Austria
Schleiergasse 20, A-1100 Wien Austria
Tel: 0222-60203900

THE NETHERLANDS

Yamaha Music Nederland
Kanaalweg 18G, 3526KL, Utrecht, The Netherlands
Tel: 030-2828411

BELGIUM

Yamaha Music Belgium
Keiberg Imperiastraat 8, 1930 Zaventem, Belgium
Tel: 02-7258220

FRANCE

**Yamaha Musique France,
Division Claviers**
BP 70-77312 Marne-la-Vallée Cedex 2, France
Tel: 01-64-61-4000

ITALY

**Yamaha Musica Italia S.P.A.,
Home Keyboard Division**
Viale Italia 88, 20020 Lainate (Milano), Italy
Tel: 02-935-771

SPAIN

Yamaha-Hazen Electronica Musical, S.A.
Jorge Juan 30, 28001, Madrid, Spain
Tel: 91-577-7270

PORTUGAL

Valentim de Carvalho CI SA
Estrada de Porto Salvo, Paço de Arcos 2780 Oeiras,
Portugal
Tel: 01-443-3398/4030/1823

GREECE

Philippe Nakas S.A.
Navarinou Street 13, P.Code 10680, Athens, Greece
Tel: 01-364-7111

SWEDEN

Yamaha Scandinavia AB
J. A. Wettergrens Gata 1
Box 30053
S-400 43 Göteborg, Sweden
Tel: 031 89 34 00

DENMARK

YS Copenhagen Liaison Office
Generatorvej 8B
DK-2730 Herlev, Denmark
Tel: 44 92 49 00

FINLAND

Warner Music Finland OY/Fazer Music
Aleksanterinkatu 11, P.O. Box 260
SF-00101 Helsinki, Finland
Tel: 0435 011

NORWAY

Narud Yamaha AS
Grini Næringspark 17
N-1345 Østerås, Norway
Tel: 67 14 47 90

ICELAND

Skifan HF
Skeifan 17 P.O. Box 8120
IS-128 Reykjavik, Iceland
Tel: 525 5000

OTHER EUROPEAN COUNTRIES

Yamaha Europa GmbH.
Siemensstraße 22-34, 25462 Rellingen, F.R. of
Germany
Tel: 04101-3030

AFRICA

**Yamaha Corporation,
International Marketing Division**
Nakazawa-cho 10-1, Hamamatsu, Japan 430
Tel: 053-460-2312

MIDDLE EAST

TURKEY/CYPRUS

Yamaha Europa GmbH.
Siemensstraße 22-34, 25462 Rellingen,
F.R. of Germany
Tel: 04101-3030

OTHER COUNTRIES

**Yamaha Corporation,
International Marketing Division**
Nakazawa-cho 10-1, Hamamatsu, Japan 430
Tel: 053-460-2312

ASIA

HONG KONG

Tom Lee Music Co., Ltd.
11/F., Silvercord Tower 1, 30 Canton Road,
Tsimshatsui, Kowloon, Hong Kong
Tel: 730-1098

INDONESIA

**PT. Yamaha Music Indonesia (Distributor)
PT. Nusantik**
Gedung Yamaha Music Center, Jalan Jend. Gatot
Subroto Kav. 4, Jakarta 12930, Indonesia
Tel: 21-520-2577

MALAYSIA

Yamaha Music Malaysia, Sdn., Bhd.
16-28, Jalan SS 2/72, Petaling Jaya, Selangor,
Malaysia
Tel: 3-717-8977

PHILIPPINES

Yupango Music Corporation
339 Gil J. Puyat Avenue, P.O. Box 885 MCPO,
Makati, Metro Manila, Philippines
Tel: 819-7551

SINGAPORE

Yamaha Music Asia Pte., Ltd.
Blk 17A Toa Payoh #01-190 Lorong 7
Singapore 1231
Tel: 354-0133

TAIWAN

Kung Hsue She Trading Co., Ltd.
No. 322, Section 1, Fu Hsing S. Road,
Taipei 106, Taiwan. R.O.C.
Tel: 02-709-1266

THAILAND

Siam Music Yamaha Co., Ltd.
865 Phornprapha Building, Rama I Road,
Patumwan, Bangkok 10330, Thailand
Tel: 2-215-3443

THE PEOPLE'S REPUBLIC OF CHINA AND OTHER ASIAN COUNTRIES

**Yamaha Corporation,
International Marketing Division**
Nakazawa-cho 10-1, Hamamatsu, Japan 430
Tel: 053-460-2317

OCEANIA

AUSTRALIA

Yamaha Music Australia Pty. Ltd.
17-33 Market Street, South Melbourne, Vic. 3205,
Australia
Tel: 3-699-2388

NEW ZEALAND

Music Houses of N.Z. Ltd.
146/148 Captain Springs Road, Te Papapa,
Auckland, New Zealand
Tel: 9-634-0099

COUNTRIES AND TRUST TERRITORIES IN PACIFIC OCEAN

**Yamaha Corporation,
International Marketing Division**
Nakazawa-cho 10-1, Hamamatsu, Japan 430
Tel: 053-460-2317

HEAD OFFICE Yamaha Corporation, Electronic Musical Instrument Division
Nakazawa-cho 10-1, Hamamatsu, Japan 430
Tel: 053-460-3255

FCC INFORMATION (U.S.A.)

1. IMPORTANT NOTICE: DO NOT MODIFY THIS UNIT!

This product, when installed as indicated in the instructions contained in this manual, meets FCC requirements. Modifications not expressly approved by Yamaha may void your authority, granted by the FCC, to use the product.

2. IMPORTANT:

When connecting this product to accessories and/or another product use only high quality shielded cables. Cable/s supplied with this product MUST be used. Follow all installation instructions. Failure to follow instructions could void your FCC authorization to use this product in the USA.

3. NOTE:

This product has been tested and found to comply with the requirements listed in FCC Regulations, Part 15 for Class "B" digital devices. Compliance with these requirements provides a reasonable level of assurance that your use of this product in a residential environment will not result in harmful interference with other electronic devices. This equipment generates/uses radio frequencies and, if not installed and used according to the instructions found in the users manual, may cause interference harmful to the operation of other electronic devices. Compliance with FCC regulations does not guarantee that interference will not occur in all installations. If this product is found to be the source of interference, which can be determined by turning the unit "OFF" and "ON", please try to eliminate the problem by using one of the following measures:

Relocate either this product or the device that is being affected by the interference.

Utilize power outlets that are on different branch (circuit breaker or fuse) circuits or install AC line filter/s.

In the case of radio or TV interference, relocate/reorient the antenna. If the antenna lead-in is 300 ohm ribbon lead, change the lead-in to co-axial type cable.

If these corrective measures do not produce satisfactory results, please contact the local retailer authorized to distribute this type of product. If you can not locate the appropriate retailer, please contact Yamaha Corporation of America, Electronic Service Division, 6600 Orangethorpe Ave, Buena Park, CA90620

The above statements apply ONLY to those products distributed by Yamaha Corporation of America or its subsidiaries.

* This applies only to products distributed by YAMAHA CORPORATION OF AMERICA.

IMPORTANT NOTICE FOR THE UNITED KINGDOM

Connecting the Plug and Cord

IMPORTANT. The wires in this mains lead are coloured in accordance with the following code:

BLUE : NEUTRAL
BROWN : LIVE

As the colours of the wires in the mains lead of this apparatus may not correspond with the coloured markings identifying the terminals in your plug proceed as follows:

The wire which is coloured BLUE must be connected to the terminal which is marked with the letter N or coloured BLACK.

The wire which is coloured BROWN must be connected to the terminal which is marked with the letter L or coloured RED.

Making sure that neither core is connected to the earth terminal of the three pin plug.

• This applies only to products distributed by Yamaha-Kemble Music (U.K.) Ltd.

CAUTION: TO PREVENT ELECTRIC SHOCK, MATCH WIDE BLADE OF PLUG TO WIDE SLOT, FULLY INSERT.

ATTENTION: POUR ÉVITER LES CHOCS ÉLECTRIQUES, INTRODUIRE LA LAME LA PLUS LARGE DE LA FICHE DANS LA BORNE CORRESPONDANTE DE LA PRISE ET POUSSER JUSQU'AU FOND.

• This applies only to products distributed by Yamaha Canada Music Ltd.

• Ceci ne s'applique qu'aux produits distribués par Yamaha Canada Musique Ltée.

YAMAHA
YAMAHA CORPORATION

Free Manuals Download Website

<http://myh66.com>

<http://usermanuals.us>

<http://www.somanuals.com>

<http://www.4manuals.cc>

<http://www.manual-lib.com>

<http://www.404manual.com>

<http://www.luxmanual.com>

<http://aubethermostatmanual.com>

Golf course search by state

<http://golfingnear.com>

Email search by domain

<http://emailbydomain.com>

Auto manuals search

<http://auto.somanuals.com>

TV manuals search

<http://tv.somanuals.com>