

YAMAHA

Clavinova®

CLP-611

CLP-811

Owner's Manual
Bedienungsanleitung
Mode d'emploi
Manual de instrucciones

IMPORTANT

Check your power supply

Make sure that your local AC mains voltage matches the voltage specified on the name plate on the bottom panel. In some areas a voltage selector may be provided on the bottom panel of the main keyboard unit near the power cord. Make sure that the voltage selector is set for the voltage in your area. The voltage selector is set at 240V when the unit is initially shipped. To change the setting use a "minus" screwdriver to rotate the selector dial so that the correct voltage appears next to the pointer on the panel.

WICHTIG

Überprüfung der Stromversorgung

Vergewissern Sie sich vor dem Anschließen an das Stromnetz, daß die örtliche Netzspannung den Betriebsspannungswerten auf dem Typenschild an der Unterseite des Instruments entspricht. In bestimmten Verkaufsgebieten ist das Instrument mit einem Spannungswähler an der Unterseite neben der Netzkabeldurchführung ausgestattet. Falls vorhanden, muß der Spannungswähler auf die örtliche Netzspannung eingestellt werden. Der Spannungswähler wurde werkseitig auf 240 V voreingestellt. Zum Verstellen drehen Sie den Spannungsregler mit einem Schlitzschraubendreher, bis der Zeiger auf den korrekten Spannungswert weist.

IMPORTANT

Contrôler la source d'alimentation

Vérifiez que la tension spécifiée sur le panneau arrière correspond à la tension du secteur. Dans certaines régions, l'instrument peut être équipé d'un sélecteur de tension situé sur le panneau inférieur du clavier à proximité du cordon d'alimentation. Vérifiez que ce sélecteur est bien réglé en fonction de la tension secteur de votre région. Le sélecteur de tension est réglé sur 240 V au départ d'usine. Pour modifier ce réglage, utilisez un tournevis à lame plate pour tourner le sélecteur afin de mettre l'indication correspondant à la tension de votre région vis à vis du repère triangulaire situé sur le panneau.

IMPORTANTE

Verifique la alimentación de corriente

Asegúrese de que tensión de alimentación de CA de su área corresponde con la tensión especificada en la placa de características del panel inferior de la unidad del teclado principal, cerca del cable de alimentación. Asegúrese de que el selector de tensión esté ajustado a la tensión de su área. El selector de tensión se ajusta a 240V cuando la unidad sale de fábrica. Para cambiar el ajuste, emplee un destornillador de cabeza "recta" para girar el selector de modo que aparezca la tensión correcta al lado del indicador del panel.

SPECIAL MESSAGE SECTION

PRODUCT SAFETY MARKINGS: Yamaha electronic products may have either labels similar to the graphics shown below or molded/stamped facsimiles of these graphics on the enclosure. The explanation of these graphics appears on this page. Please observe all cautions indicated on this page and those indicated in the safety instruction section.

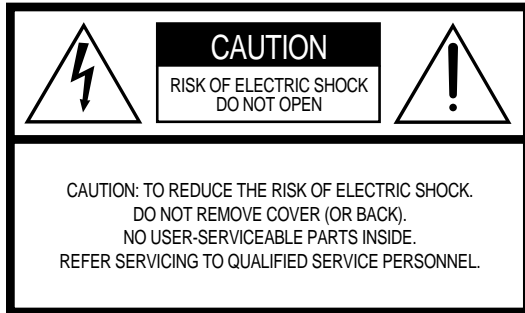

See bottom of Keyboard enclosure for graphic symbol markings



The exclamation point within the equilateral triangle is intended to alert the user to the presence of important operating and maintenance (servicing) instructions in the literature accompanying the product.

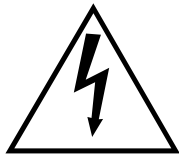

The lightning flash with arrowhead symbol, within the equilateral triangle, is intended to alert the user to the presence of uninsulated "dangerous voltage" within the product's enclosure that may be of sufficient magnitude to constitute a risk of electrical shock.

IMPORTANT NOTICE: All Yamaha electronic products are tested and approved by an independent safety testing laboratory in order that you may be sure that when it is properly installed and used in its normal and customary manner, all foreseeable risks have been eliminated. DO NOT modify this unit or commission others to do so unless specifically authorized by Yamaha. Product performance and/or safety standards may be diminished. Claims filed under the expressed warranty may be denied if the unit is/has been modified. Implied warranties may also be affected.

SPECIFICATIONS SUBJECT TO CHANGE: The information contained in this manual is believed to be correct at the time of printing. However, Yamaha reserves the right to change or modify any of the specifications without notice or obligation to update existing units.

ENVIRONMENTAL ISSUES: Yamaha strives to produce products that are both user safe and environmentally friendly. We sincerely believe that our products and the production methods used to produce them, meet these goals. In keeping with both the letter and the spirit of the law, we want you to be aware of the following:

Battery Notice: This product MAY contain a small non-rechargeable battery which (if applicable) is soldered in place. The average life span of this type of battery is approximately five years. When replacement becomes necessary, contact a qualified service representative to perform the replacement.

Warning: Do not attempt to recharge, disassemble, or incinerate this type of battery. Keep all batteries away from children. Dispose of used batteries promptly and as regulated by applicable laws. Note: In some areas, the servicer is required by law to return the defective parts. However, you do have the option of having the servicer dispose of these parts for you.

Disposal Notice: Should this product become damaged beyond repair, or for some reason its useful life is considered to be at an end, please observe all local, state, and federal regulations that relate to the disposal of products that contain lead, batteries, plastics, etc.

NOTICE: Service charges incurred due to lack of knowledge relating to how a function or effect works (when the unit is operating as designed) are not covered by the manufacturer's warranty, and are therefore the owners responsibility. Please study this manual carefully and consult your dealer before requesting service.

NAME PLATE LOCATION: The graphic below indicates the location of the name plate. The model number, serial number, power requirements, etc., are located on this plate. You should record the model number, serial number, and the date of purchase in the spaces provided below and retain this manual as a permanent record of your purchase.

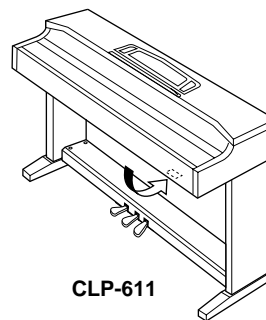

CLP-611

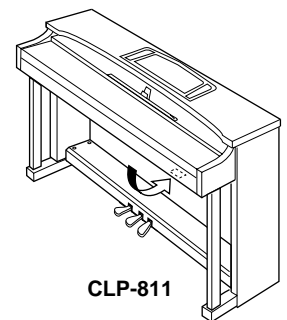

CLP-811

Model _____

Serial No. _____

Purchase Date _____

Clavinova®

CLP-811

CLP-611

Owner's Manual

English

Bedienungsanleitung

Deutsch

Mode d'emploi

Français

Manual de instrucciones

Español

Introduction

Thank you for choosing a Yamaha CLP-811/611 Clavinova. Your Clavinova is a fine musical instrument employing advanced Yamaha music technology. With proper care, your Clavinova will provide you with many years of musical pleasure.

- Yamaha's AWM (Advanced Wave Memory) sound generation provides extremely rich, realistic voices. Piano voices are especially true and powerful.
- The damper pedal produces natural piano resonances, obtained from direct sampling of string and soundboard resonance characteristics.
- Piano-like touch response offers great control and playability. Responsiveness can be set to any of four levels.
- **Dual mode** lets you play any two voices in unison.
- **Split mode** divides the keyboard into two zones, so that you can play a different voice with each hand.
- Special **Organ Combination** voice can be freely edited.
- Unique **Clavinova Tone** voice provides a new and versatile sound.
- Built-in metronome function facilitates effective practice.
- Digital recording function can record and replay your keyboard input (up to about 4,200 notes).
- With MIDI compatibility and a solid range of MIDI functions, the Clavinova can serve well within a wide variety of advanced MIDI setups.
- Built-in computer interface allows for direct connection to personal computers running advanced music software.
- Large LCD provides an effective and friendly interface. Well-designed displays make setup and control operations extremely easy.

To ensure that you can take full advantage of your Clavinova's many outstanding features, please read through this manual carefully, and store in a safe place for future reference.

Taking Care Of Your Clavinova

Your Clavinova is a fine musical instrument, and deserves the most careful treatment. Observe the following points and your Clavinova will sound and look great for many years.

- 1 Never open the case and touch or tamper with the internal circuitry.
 - 2 Always turn the POWER switch OFF after use, and close the key cover to protect the keyboard.
 - 3 Clean the cabinet and keys of your Clavinova only with a clean, slightly damp cloth. A neutral cleanser may be used if desired. Never use abrasive cleansers, waxes, solvents, or chemical dust cloths as these can dull or damage the finish.
 - 4 Never place any vinyl products on your Clavinova. Contact with vinyl can cause irreversible damage to the finish.
 - 5 Install your Clavinova in a place that is away from direct sunlight, excessive humidity and heat.
 - 6 Never apply excessive force to the controls, connectors or other parts of your Clavinova, and avoid scratching or bumping it with hard objects.
 - 7 Make sure that your local AC voltage matches the voltage specified on the Clavinova's nameplate (located on the bottom panel, under the keyboard). Note that some Clavinovas are equipped with a voltage selector dial located next to the power-cord inlet. If your unit includes a selector, turn it as necessary (with a screwdriver) to select the correct voltage.
- **Nameplate Location**
The CLP-811/611 nameplate is located on the bottom panel.

Contents

Getting Ready	2	F6. OrganEdit (ORGAN COMBINATION settings)	30
Music Stand	2	F7. Metronome (Metronome settings)	32
Key Cover	2	F8. Display (Display mode)	32
Powering Up	3	F9. L.Pedal (Function of left pedal)	33
Adjusting the Volume	3	F10. DamperDpt (Damper-pedal depth)	33
Using Headphones	3	F11. Damper (Number of damper-pedal levels)	34
Panel Controls and Connectors	4	F12. CancelVol (Volume of muted piano-song track)	34
Basic Controls and Functions	6	F13. MIDIFunc. (MIDI settings)	34
Controlling the Clavinova	6	CLP-811	
Frequently Used Buttons	6	F14. MicRevDpt (Microphone reverb depth)	36
Playing the Demos and Piano Songs	8	F15. Backup (Backup ON/OFF settings)	36
Playing the Demos	9	CLP-611	
Playing the Piano Songs	10	F14. Backup (Backup ON/OFF settings)	36
One-Hand Practice with Piano Songs	11	The Clavinova's Device Connectors	38
Repetition Practice with Piano Songs	12	Connecting to a Personal Computer	40
Selecting and Playing Voices	13	Troubleshooting	42
Selecting a Voice	13	Options	43
Using the Pedals	14	Index	44
Changing the Sound [VARIATION], [BRILLIANCE], [REVERB], [EFFECT]	14	Demo and Piano Songs Lists	46
TOUCH	16	Factory Defaults	47
TRANSPOSE	17	MIDI Data Format	48
DUAL Mode (Mixing two voices together) ..	17	Specifications	53
SPLIT Mode (Dividing the keyboard)	18	CLP-811 Assembly Procedure	54
Using the METRONOME	19	CLP-611 Assembly Procedure	60
Using the Recorder	20	MIDI Implementation Chart	66
Recording	20		
Playback	22		
Configuration Functions (FUNCTION mode)	24		
Basic Procedure	26		
Function descriptions	27		
F1. Tune (Keyboard fine tuning)	27		
F2. KTune (Key-by-key fine tuning)	27		
F3. Scale (Temperament selection)	28		
F4. DualFunc. (Settings for DUAL mode.)	29		
F5. SplitFunc. (Settings for SPLIT mode.)	29		

- Within this manual, a white arrow (⇨) indicates how the Clavinova responds to an action that you have taken.
- All front panel illustrations are from the CLP-811.
- Screen illustrations show examples only. Actual screen content will vary according to operational settings.

Getting Ready

Music Stand

CLP-811

To raise the stand:

1. Using two hands, take hold of the left and right sides of the music stand. Lift the stand upwards while at the same time rotating the top of the stand toward you.
2. Push the stand down into place so that the opening on the base of the stand fits onto the small notch on the plastic hook.

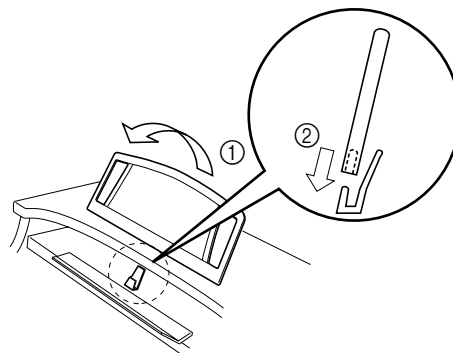

To retract the stand:

Lift the stand straight up off the notch, then rotate it backwards and return it to its original position.

CLP-611

To raise the stand:

1. Lift the stand forward as far as it will go.
2. Flip down the two metal supports at the bottom rear of the stand.
3. Lower the stand downward slightly so that it comes to rest on the metal supports.

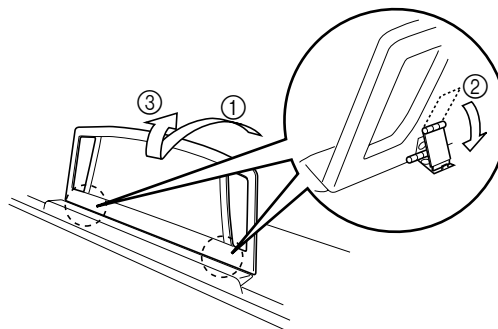

To lower the stand:

1. Lean the stand forward as far as it will go.
2. Raise the two metal supports (at the back of the stand) so that they are flush with the stand.
3. Gently lower the stand backward until it is all the way down.



NOTE Please do not try to use the stand in half-raised position. When raising or lowering the stand, always hold on to it until it is securely in place.

Key Cover

To open the cover:

1. Lift the cover slightly (not too much).
2. Gently slide the cover open.

To close the cover:

1. Slide the cover all the way forward, holding it firmly so that it can't drop down.
2. Gently lower the cover over the keys.

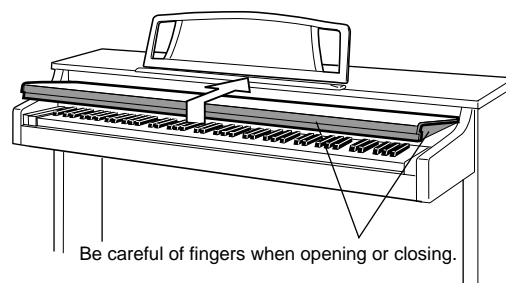

Hold the cover with both hands when moving it, and do not release it until it is fully opened or closed. Be careful to avoid catching fingers (your and others',) between the cover and the main unit.

Powering Up

1. Connect the power cord.

Insert one end of the power cord into the power connector on the Clavinova, and the other end into a standard wall outlet. (If your unit comes with a plug adaptor and its use is required, please connect it to the end of the cord before plugging in.)

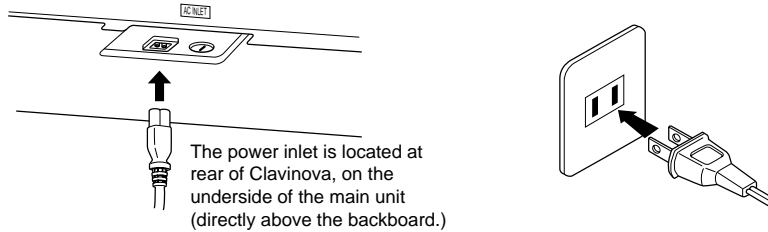

2. Switch on the power.

The **[POWER]** button is located to the left of the keyboard. Press it once to switch the power on.

⇒ The display comes on, and the power indicator on the front left of the instrument lights up. One or more panel indicators also light up.

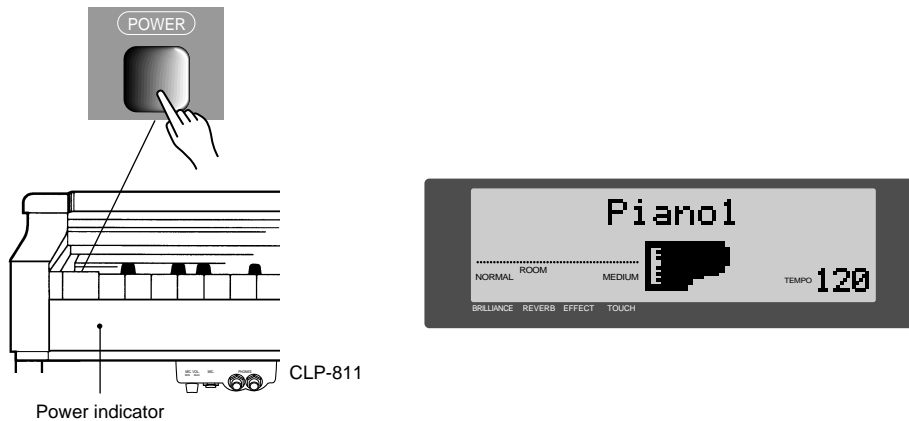

The power indicator is located on the front side, so that you can tell if power is on even with the key cover closed.

To switch the power off, press **[POWER]** once again.

⇒ The display and indicators all go off.

Adjusting the Volume

You adjust the volume by moving the **[MASTER VOLUME]** slider up or back. Adjust as necessary while playing on the keyboard.

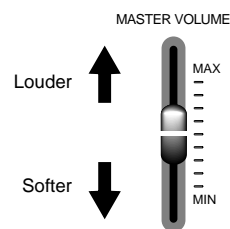

The **[MASTER VOLUME]** slider also controls the output level to the **PHONES** and **AUX OUT** jacks.

Using Headphones

You can connect headphones to either or both of the **PHONES** jacks. The connection automatically cuts off output from the Clavinova's speakers. Two jacks are provided so that two people can listen at the same time. (Headphones must be purchased separately.)

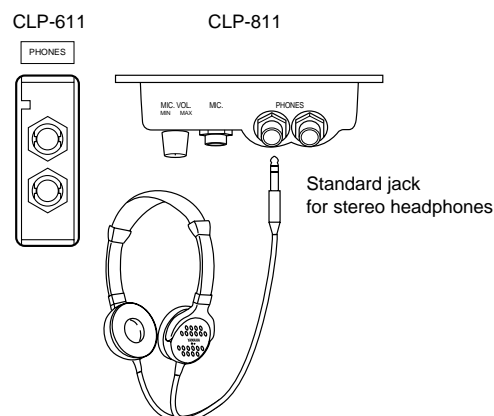

Recommended headphones:
Yamaha HPE-160

Panel Controls and Connectors

Front Panel

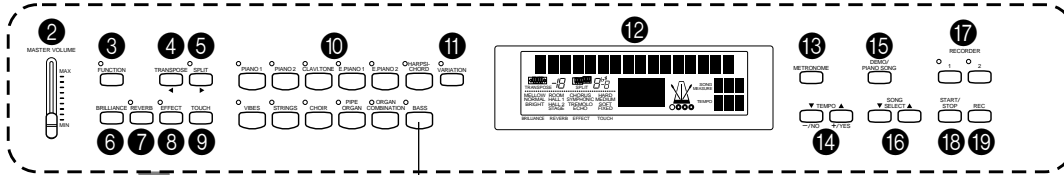

This button exists on the CLP-811 but not on the CLP-611.
All other panel buttons are common to both models.

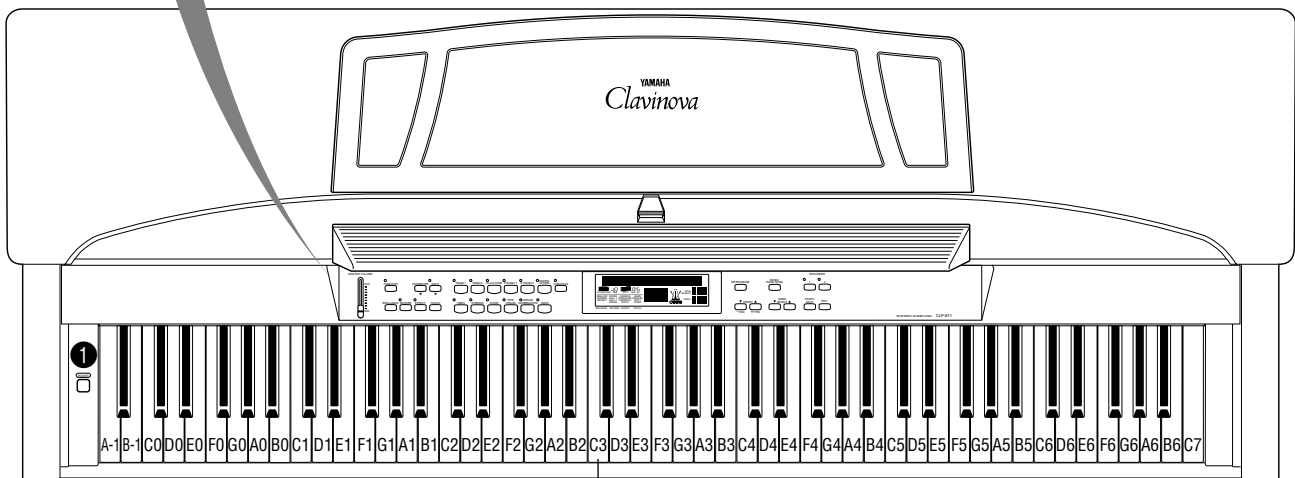

Middle C

(CLP-811)

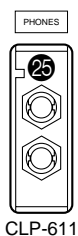

CLP-611

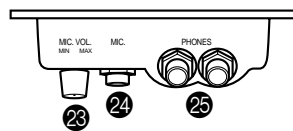

CLP-811

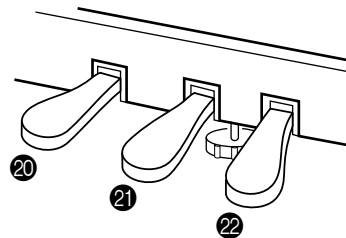

① [POWER]	page 3	⑪ [VARIATION]	14
② [MASTER VOLUME]	3	⑫ Display (LCD)	6
③ [FUNCTION]	24	⑬ [METRONOME]	19
④ [TRANSPOSE] / [◀]	17	⑭ Tempo [▲] [▼] [-/NO] [+ /YES]	6,19,26
⑤ [SPLIT] / [▶]	18	⑮ [DEMO/PIANO SONG]	8
⑥ [BRILLIANCE]	15	⑯ Song select [▲] [▼]	26
⑦ [REVERB]	15	⑰ RECORDER [1] [2]	20
⑧ [EFFECT]	15		
⑨ [TOUCH]	16		
⑩ Voice selectors	13		

Rear Panel

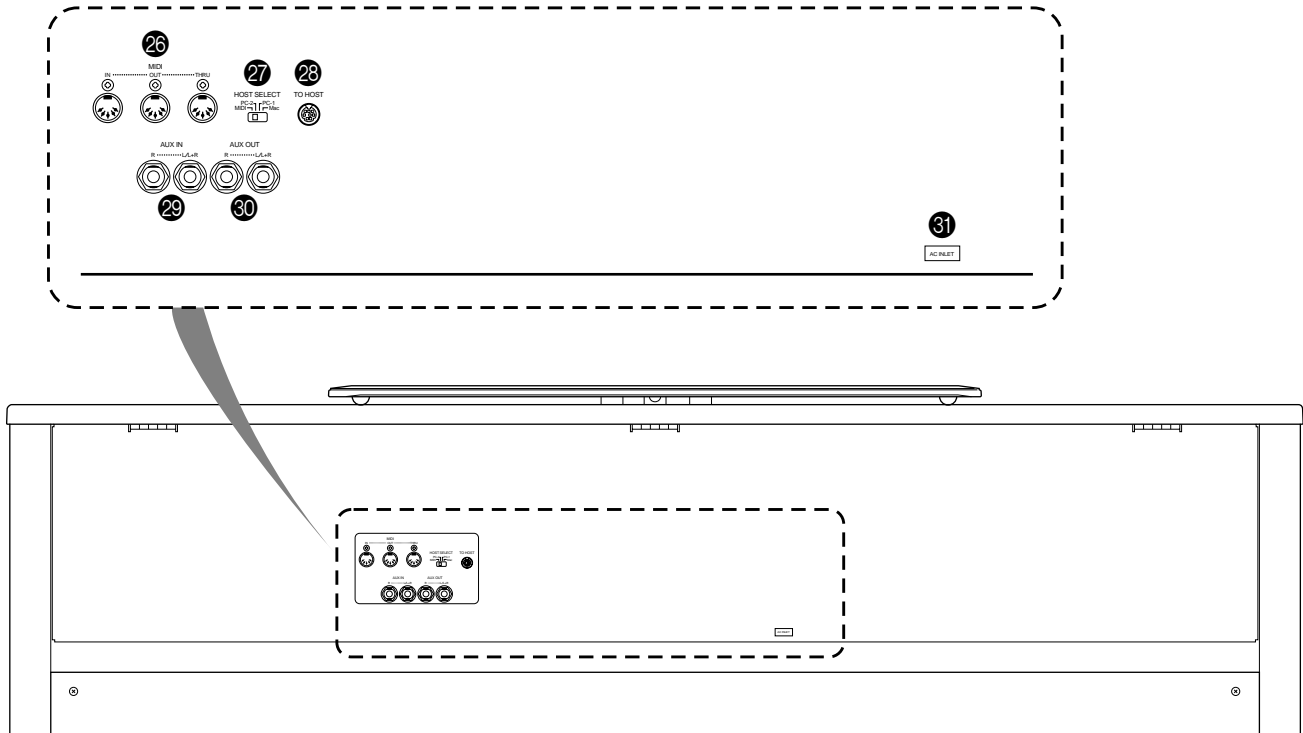

(CLP-811)

- | | | | |
|-----------------------------------|-------------|---------------------------------|---------|
| 18 [START/STOP] | pages 10,21 | 26 MIDI [IN] [OUT] [THRU] | 39,48 |
| 19 [REC] | 21 | 27 HOST SELECT [MIDI] [PC-2] | |
| 20 Soft pedal | 14 | [PC-1] [MAC] | 39,40 |
| 21 Sostenuto pedal | 14 | 28 [TO HOST] | 39,40 |
| 22 Damper pedal | 14 | 29 AUX IN [R] [L/L+R] | 39 |
| 23 [MIC.VOL] (CLP-811 only) | 38 | 30 AUX OUT [R] [L/L+R] | 39 |
| 24 [MIC.] (CLP-811 only) | 38 | 31 [AC INLET] | 3,58,64 |
| 25 [PHONES] | 3,38 | | |

Basic Controls and Functions

This section describes the basic controls and operational features of your Clavinova. Please read through this information carefully.

Controlling the Clavinova

You control the Clavinova functions by pressing the buttons on the panel. The display indicates the results of each operation and keeps you informed of the current status.

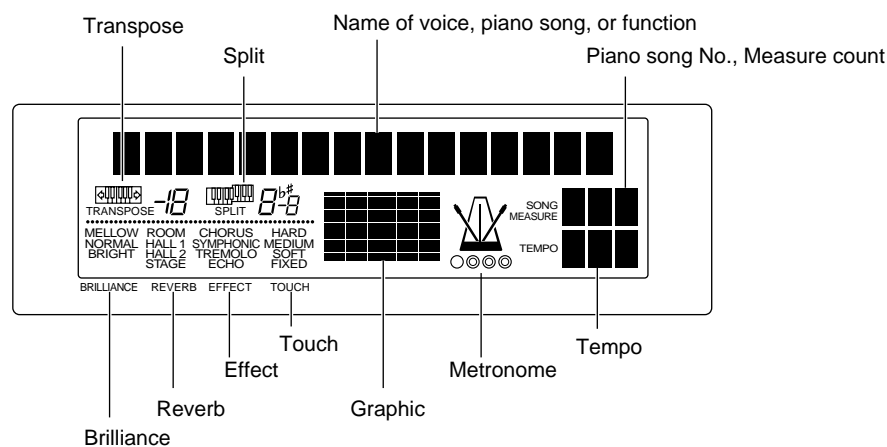

Frequently Used Buttons

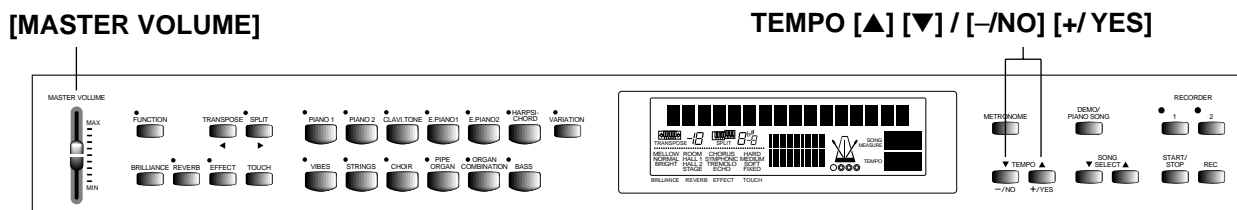

[MASTER VOLUME]

Adjusts the output level to the speakers, headphones, and AUX OUT jacks.

TEMPO [▼] [▲]

Adjust the playback tempo for demo songs and piano songs. Also adjust the metronome tempo.

You can set the tempo to any value between 32 and 280. Pressing [▼] and [▲] at the same time resets the value to its standard setting (either 120 or else as set within the currently selected song).

- Holding down the appropriate increment/decrement button (TEMPO [▼][▲]/[-/NO][+ /YES] or SONG SELECT [▼][▲]) causes the corresponding value to change continuously. In most cases the setting will stop upon reaching the maximum or minimum limit. In some cases, however, the setting will continue to loop through the available values.
- You can return any value to its factory default by pressing [-/NO] and [-/YES] at the same time.

Memory Backup

The Clavinova includes a memory-backup feature that can retain settings while power is off and restore them when you resume play. Although all backup is set to OFF at time of shipping, you can use the FUNCTION mode's **Backup** setting (F15 on the CLP-811, F14 on the CLP-611) to selectively set backup on or off for different groups of settings.

If backup for a group is set OFF, all settings within that group return to their factory defaults each time power comes on. (A listing of factory defaults appears on page 47.) Note that the Clavinova unconditionally backs up and restores the **Backup** settings themselves, as well as any keyboard input that you have recorded.

Memory backup remains effective for about a week, after which all settings will return to their factory defaults. If you wish to retain your settings for a long period of time, please be sure to switch the Clavinova on for at least a few minutes each week.

CLP-811/611 function groups

CLP-811/611 functions can be broadly divided into three groups, as follows.

Voice and performance functions (p.13-p.19)
Recording and playback functions (p.20-p.23)
FUNCTION-mode settings (p.24-p.37)

FUNCTION mode...

You can use **FUNCTION** mode to set a wide variety of system and utility parameters. All parameters are originally set to standard default values (factory defaults), but you are free to change them to suit your particular needs.

Memory...

The Clavinova stores the various settings you have made within its internal memory.

Backup...

Use the memory backup feature to retain memory settings while power is off, so that they will be restored when you switch the power back on.

Playing the Demos and Piano Songs

Your CLP-811/611 includes thirty built-in piano songs, together with demo songs for each of the different voices (one demo per voice). Let's try playing some of these songs now. When playing piano songs you are free to turn off the left-hand or right-hand part so that you can practice along. You can also pick out a specific phrase for repetition-type practice.

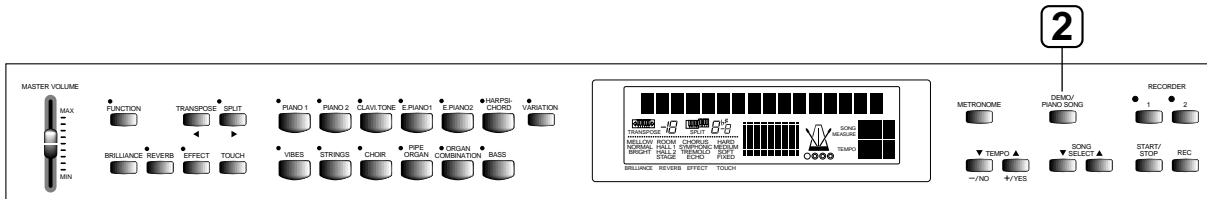

Procedure

1 Switch on the power.

(If power is not yet on)

Press the **[POWER]** button.

⇒ The power comes on.

We'll adjust the output volume while playing the songs. For now, please set the **[MASTER VOLUME]** slider to approximately middle position.

2 Select the DEMO/PIANO SONG mode.

Press the **[DEMO/PIANO SONG]** button on the right side of the panel.

⇒ The voice indicators begin cycling on and off. The screen indicates the new mode and prompts you for a song selection.

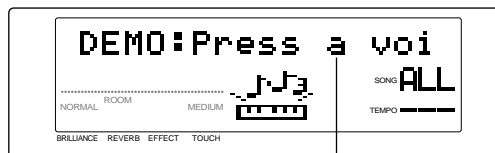

Press a voice selector or SONG SELECT button.

We'll begin by playing some demos. Then we'll proceed to play some of the piano songs and try out the special practice features.

For a listing of the internal demos and piano songs...

See page 46.

The Clavinova does not receive MIDI signals while DEMO/PIANO SONG mode is active. It is not possible to transmit demo and piano song data to other devices over MIDI.

DEMO/PIANO SONG mode cannot be selected if the Clavinova is in RECORDING mode or if it is playing back a recorded performance.

The word **song**, as used here, refers to any stored sequence of performance data. Demo songs and piano songs both exist as stored performance data.

Playing the Demos

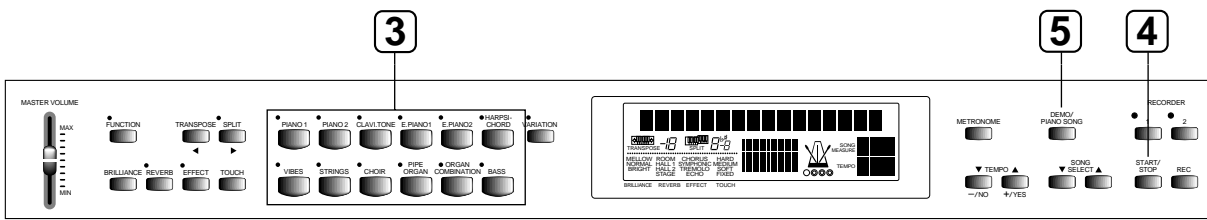

(After completing steps [1] and [2] above...)

3 Begin playback by selecting a voice.

Press the voice selector corresponding to the demo that you want to hear.

- ➡ The voice indicator begins flashing and the Clavinova starts playing the demo.

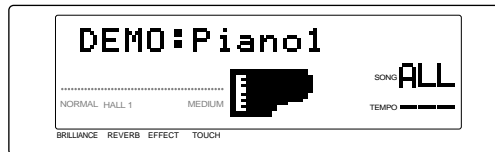

Adjusting the volume

Move the [MASTER VOLUME] up or down to adjust the volume while listening to the playback.

Adjusting the tempo

Although each demo song includes its own tempo setting, you are free to adjust the playback tempo by pressing TEMPO [▼] or [▲]. To return the playback tempo to its original setting, press both TEMPO buttons ([▼] + [▲]) at the same time.

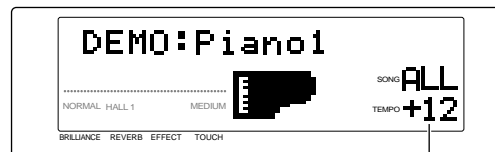

Displays playback tempo as an offset (-99 to +99) from the demo song's internal tempo setting. A TEMPO indication of "--" means that playback is at the song's preset tempo.

4 Stopping the playback

You can stop playback of the ongoing song by pressing either the [START/STOP] button or else the flashing voice selector.

5 Terminating DEMO/PIANO SONG mode

Press the [DEMO/PIANO SONG] button.
➡ The screen returns to the previous display.

Continuous playback...

You can choose to have demos and piano songs play out one after another, in either numerical or random order. For details, see "Playing the Piano Songs" on the next page.

Using [VARIATION]...

If you press [VARIATION] while in DEMO/PIANO SONG mode, the Clavinova will begin playback of a randomly selected piano song.

Tempo reset...

Selecting a different song for playback automatically resets the tempo (so that the new song will replay at its internal tempo setting). During continuous playback, the tempo automatically resets each time the song changes.

Unlike piano songs, demo songs cannot be used for one-handed and repetition-type practice. (See page 11, 12)

Playing the Piano Songs

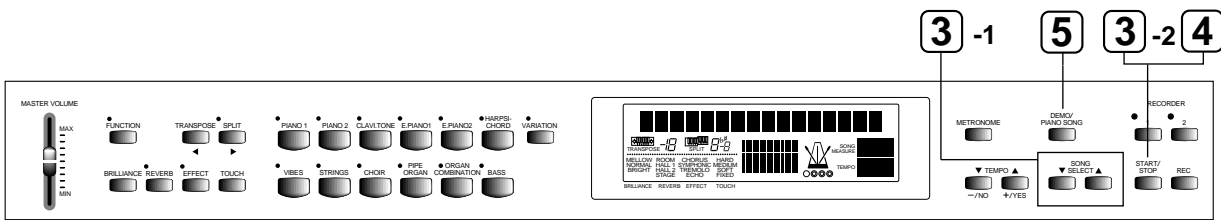

(After completing steps [1] and [2] on page 8...)

3 Select song(s) and begin playback.

3-1 Press **SONG SELECT** (\blacktriangledown) or (\blacktriangle) as necessary to make your selection. You can select a single song (by song number), or you can choose continuous playback of all songs. The "SONG" indication on the screen indicates the selection.

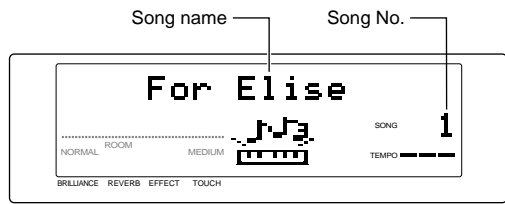

- 1,,,30** Selects playback of one piano song, by its song number.
- ALL** Selects sequential continuous play of all demo and piano songs.
- RND** Selects continuous play of the demo and piano songs, in random order.

(Alternative: You can select a random song by pressing [VARIATION]. In this case, playback will begin immediately.)

3-2 After making your selection, press [START/STOP] to begin playback.

Adjusting the volume

Move the [MASTER VOLUME] up or down to adjust the volume while listening to the playback.

Adjusting the tempo

Each piano song includes its own tempo setting. Once you have selected a song, however, you are free to change the setting (either before playback starts or while it in progress) by pressing TEMPO (\blacktriangledown) or (\blacktriangle). To return playback to its original setting, press both TEMPO buttons (\blacktriangledown + \blacktriangle) at the same time.



Displays playback tempo as an offset (-99 to +99) from the piano song's internal tempo setting. A TEMPO indication of "---" means that playback is at the song's preset tempo.

4 Stopping the playback

The Clavinova automatically prompts for new song selection when playback is finished. You can stop the song while playback is in progress by pressing the [START/STOP] button. You can then select another song as described in Step [3] above.

5 Terminating DEMO/PIANO SONG mode

Press the [DEMO/PIANO SONG] button.
 ⇨ The screen returns to the display shown just before you entered this mode.

Next we will see how to switch off either the left-hand or right-hand part of a piano song so that you can practice the part yourself (one-hand practice). We will also see how to repeatedly play a single selected song phrase (to facilitate repetition-type practice).

If you select ALL and then press a voice selector
 The Clavinova will begin sequential playback beginning with the demo song for the selected voice.

Reset of playback tempo...
 Selecting a different song for playback automatically resets the tempo (so that the new song will replay at its internal tempo setting). During continuous playback, the tempo automatically resets each time the song changes.

One-Hand Practice with Piano Songs

Each piano song has its left-hand and right-hand parts recorded on separate tracks: the right-hand part in Track [1], and the left-hand part in Track [2]. This makes it possible for you to switch off either part at any time. This feature is ideal for one-handed practice: just switch off one of the parts, then play the missing notes yourself in accompaniment with the other part.

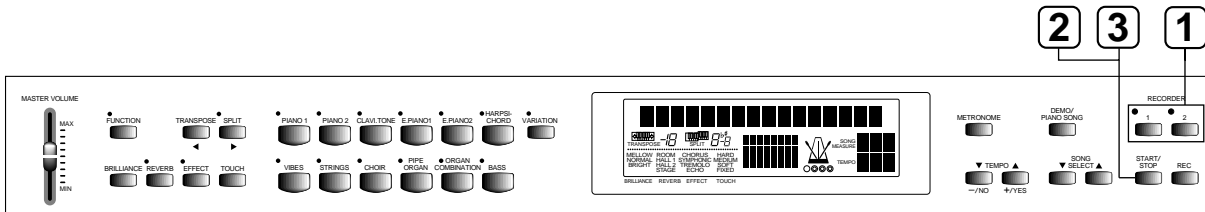

Procedure

1 Switch off the part that you want to play by yourself.

After selecting a piano song as described above, simply press [1] or [2] to mute (switch off) the right or left part.

- ⇒ When you switch off the track, the indicator above the track button goes off. (When you first select the song, both indicators will be on.)
- You can toggle each part OFF and ON by pressing the track button as needed.

Parts cannot be switched off during continuous ("ALL" or "RND") playback.

2 Start playback and begin practice.

Press [START/STOP] to begin playback. Play the muted part yourself, for practice.

Switching parts ON/OFF during playback...

The [1] and [2] buttons can be used to switch tracks on and off even while playback is in progress.

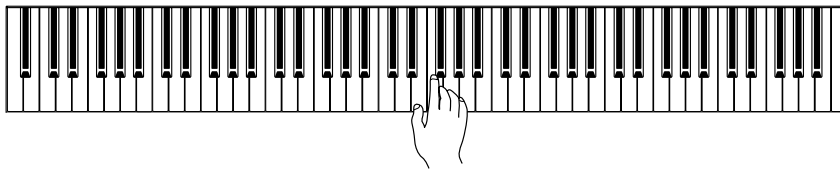

Adjusting the volume of the muted part...

After switching off a part, you may notice that you can still hear it sounding in the background at low volume. This sound is intentionally left to provide a timing guide for your practice. You are free to adjust its volume, or to switch it off entirely, by using function F12. See page 34 for details.

Synchronous start

You can set up one-part playback so that it begins precisely when you strike the keyboard. To select this feature, hold down the track button that you have set ON (either [1] or [2]) and press [START/STOP]. This sets the instrument into SYNCHRO START mode. Playback of the selected part will then begin when you hit a key on the keyboard.

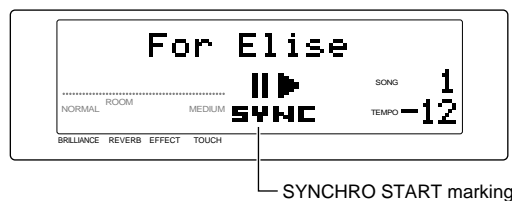

- ⇒ When you select SYNCHRO START, a corresponding marking appears at the center of the display.

If you hold down an unlit track button and press [START/STOP]...

The track button comes on and the Clavinova enters SYNCHRO START. The track will start playing back when you hit a key on the keyboard.

Using the left pedal as a START/STOP switch.

You can set the left pedal to operate in the same way as the [START/STOP] button, so that you can start and stop playback without using your hands. Left-pedal operation is determined by function F9; see page 33 for details.

3 Stopping the playback

The Clavinova automatically prompts for new song selection when playback is finished. You can stop the song while playback is in progress by pressing the [START/STOP] button.

Reset of part selection...

The Clavinova automatically sets both tracks ON when you select another song.

Repetition Practice with Piano Songs

This feature lets you extract a phrase from any piano song and play it repeatedly. By combining this function with the “one-hand practice” feature described above, you can select and then practice a specific passage as many times as you like.

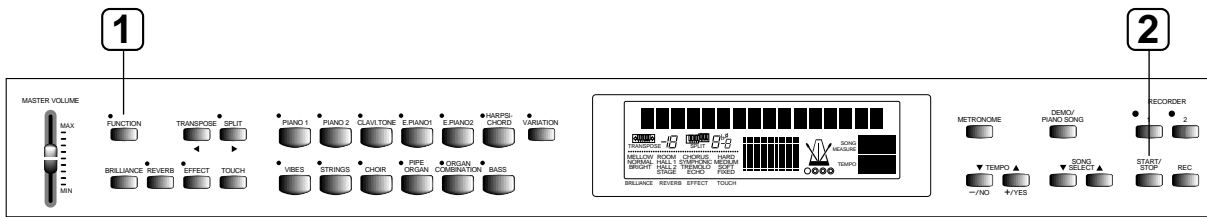

Procedure

1 Set the phrase start and end points (“A” and “B”), and then begin practice.

Select a piano song (by song number), then begin playback and listen for the desired start point. When playback reaches the beginning of the phrase you want to repeat, press [FUNCTION].

- ⇒ The Clavinova marks this point as Point A. The screen displays “A-”.

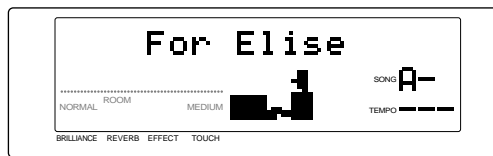

Continue listening for the end point of the phrase you want to repeat. When playback reaches the end point, press [FUNCTION] once again.

- ⇒ The Clavinova marks this point as Point B. The screen now displays “A-B”.

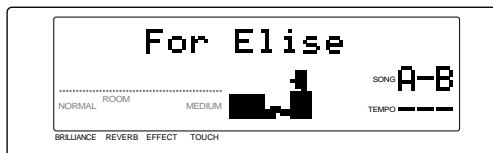

Playback now automatically jumps back to the start point and the selected sequence begins repeating. You can now practice the passage as many times as you like.

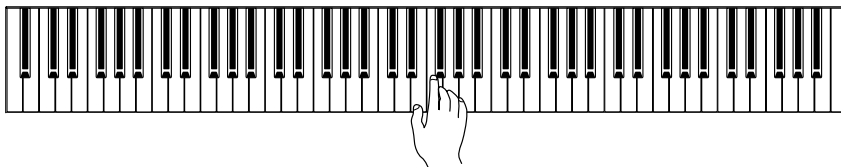

2 Stopping the playback

To interrupt repeat play temporarily while retaining the Point A and B settings, press [START/STOP] once. You can then resume the repeat playback by pressing [START/STOP] once again.

To clear the A and B settings, press [FUNCTION].

This feature is not available with continuous (“ALL” or “RND”) playback.

If you want the phrase to start at the beginning of the song... Press [FUNCTION] before you begin the playback.

If you select a different song... The A and B settings are automatically cleared.

Selecting and Playing Voices

Your Clavinova offers you an excellent selection of great-sounding voices (11 voices on model CLP-611, 12 voices on model CLP-811). You can use the VARIATION, BRILLIANCE, REVERB, and EFFECT features to vary the sound and feel of each voice.

The Clavinova also allows you to mix any two voices together ("DUAL mode"), and to select different voices for the right and left ranges of the keyboard ("SPLIT mode"). A built-in metronome is also provided.

Selecting a Voice

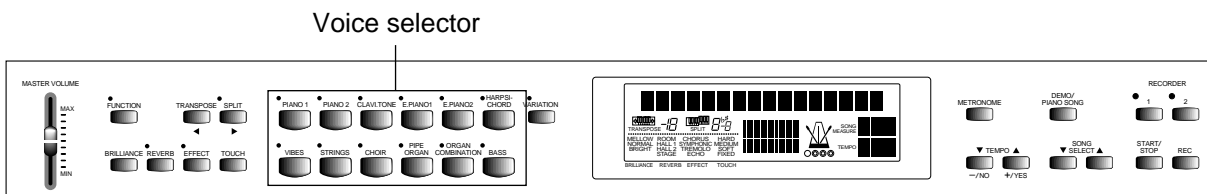

Procedure

To select a voice, press the corresponding voice selector.

⇒ The voice indicator lights up.

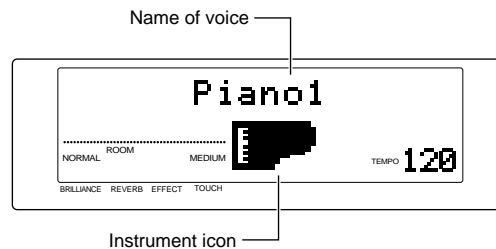

Try playing the voice. Adjust the volume as necessary by moving the [MASTER VOLUME] slider.

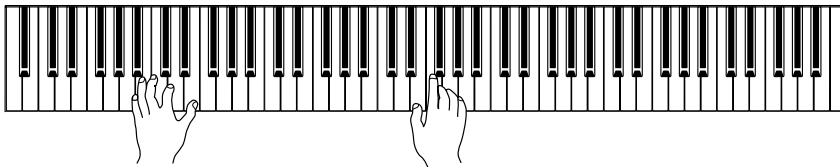

To familiarize yourself with the features of each voice...

You can get a good feel for each voice by listening to its built-in demo (see page 46 of this manual).

About the EFFECT settings...

Each voice is set to its standard (default) effect at time of shipping. For information about effects settings and how to change them, see page 15.

The ORGAN COMBINATION voice...

...can be set to any of eight built-in organ types. You can edit each of these types to produce your own customized sounds. You use function F6 to set the voice up; see page 30 for details.

Using the Pedals

This section explains the use of the instrument's three pedals.

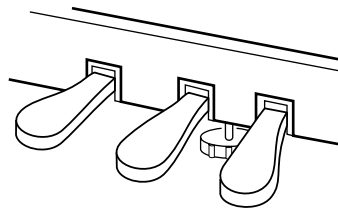

Damper (Right) Pedal

The damper pedal functions in the same way as a damper pedal on an acoustic piano. While the damper pedal is pressed notes played have a long sustain. Releasing the pedal immediately stops (damps) any sustained notes.



If you step down on the damper pedal here, the note already in play and the three subsequent notes will continue to sound after their keys are released.

Variable damper-pedal action...
The sustain length produced by the damper pedal varies according to how far you press the pedal down. The pedal is factory-set for 8-level action, but you can change this setting using function F11 (see page 34).

Sostenuto (Center) Pedal

This pedal sustains only those notes whose keys are being pressed when the pedal first goes down. Keys that you strike after the pedal is already down are not held. This makes it possible to sustain a chord, for example, while at the same time playing other notes staccato.



If you step down on the sostenuto pedal here, only the first note will be held.

Changing the function of the left pedal...
You can switch the function of the left pedal so that it operates as a second [START/STOP] button rather than as a soft pedal. To change the operation, use function F9 (see page 33).

Soft (Left) Pedal

This pedal reduces the volume and slightly changes the timbre of the notes you play. The pedal has no affect on notes that are already playing when the pedal is first pressed.

Changing the Sound ... [VARIATION], [BRILLIANCE], [REVERB], [EFFECT]

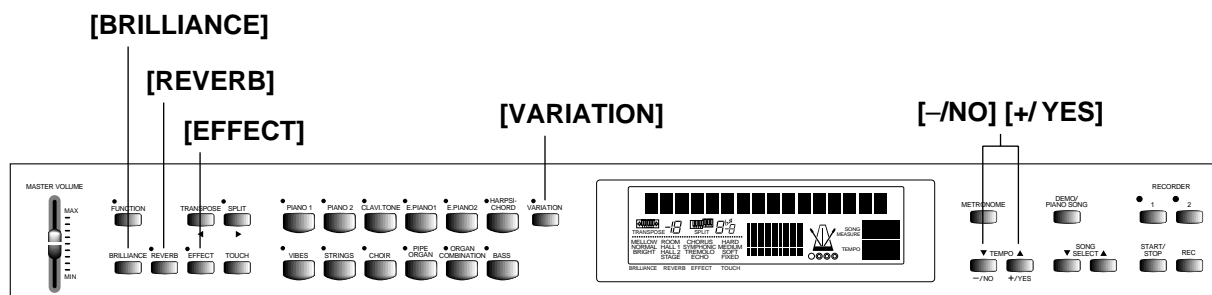

[VARIATION]

You use this feature to select a variation on the standard voice.

Procedure

Press [VARIATION] to toggle the variation voice on and off.
⇒ The indicator lights up if the variation is selected.

Default setting = OFF.

[BRILLIANCE]

Use this feature to set the brightness of the output sound. You can select from three levels.

- MELLOW** *Light, mellow tone*
- NORMAL** *Standard brightness (=default setting)*
- BRIGHT** *Clear and penetrating sound*

Procedure

Press **[BRILLIANCE]** as necessary to select the desired setting, while watching the screen.

⇒ The screen displays the current setting.

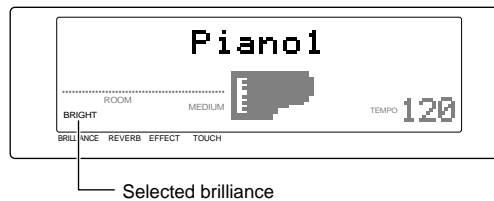

[REVERB]

This feature sets the reverb type applied to the Clavinova's sound. Each setting produces reverb acoustics similar to a particular performance environment. You are also free to adjust the "reverb depth."

- OFF** *No reverb applied.*
- ROOM** *Acoustics of midsize room*
- HALL 1** *Sound of small concert hall*
- HALL 2** *Sound of large concert hall*
- STAGE** *Stage-performance acoustics (=default setting)*

Procedure

Press **[REVERB]** as necessary to select the desired setting, while watching the screen.

⇒ The screen shows the current setting. (Nothing is shown if reverb is set to OFF.)

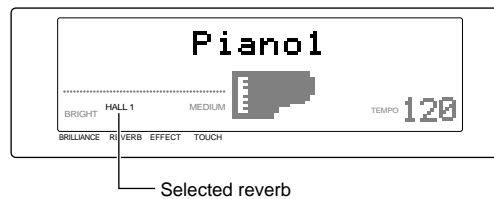

Changing the reverb depth

Hold down the **[REVERB]** button to display the current depth setting. To change the depth setting: continue to hold down **[REVERB]** while pressing **[-/NO]** or **[+/YES]**. You can set to any value between 0 and 20. The default setting is 8.

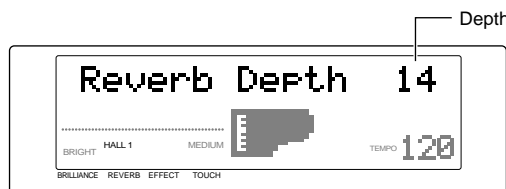

[EFFECT]

Use this button to select an effect for the voice. You can set a separate effect for each voice. Within each voice you can also set separate depth levels for each of the four effects.

- OFF** *No effect*
- CHORUS** *Shimmering, broadening effect*
- SYMPHONIC** *Adds a deep, symphonic backdrop*
- TREMOLO** *Tremolo effect*
- ECHO** *Reverberating echo effect*

The **BRILLIANCE** setting does not apply to the **ORGAN COMBINATION** voice. Instead, you can use function F6 (see page 30) to edit this voice.

The reverb type and depth settings are common to all voices.

"Depth" refers to the amount of reverb applied.
Depth = 0: No reverb
Depth = 20: Maximum reverb

Default settings...

A standard (default) effect is set for each voice prior to shipping.

Procedure

Press [EFFECT] as necessary to select the desired setting, while watching the screen.

⇒ The screen shows the current setting. (Nothing is shown if the effect is set to OFF.)

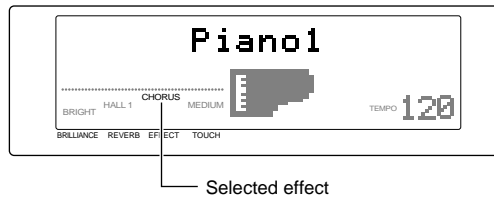

Selected effect

Changing the effect depth

Hold down the [EFFECT] button to display the depth setting for the currently selected effect. (No value will be shown if the effect is set to OFF.) To change the depth setting: continue to hold down [EFFECT] while pressing [-/NO] or [+/YES]. You can set to any value between 0 and 20.

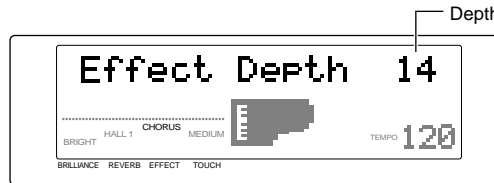

Depth

Depth setting...

Depth = 0: No effect
Depth = 20: Maximum effect

Default depths...

Standard default depths are set up for each effect type within each voice.

TOUCH

You use this feature to set the relationship between key striking force and the resulting sound volume. Select from among four settings in accordance with personal preference, voice type, and performance goal.

- HARD:** Considerable force is required to produce maximum loudness.
- MEDIUM:** Standard keyboard action (=default setting)
- SOFT:** Allows maximum loudness to be produced with relatively light key pressure.
- FIXED:** All notes are produced at uniform volume, regardless of striking force. You can select the volume by setting the velocity value, as described below.

This setting does not affect the physical action of the keyboard.

The TOUCH setting applies to all voices.

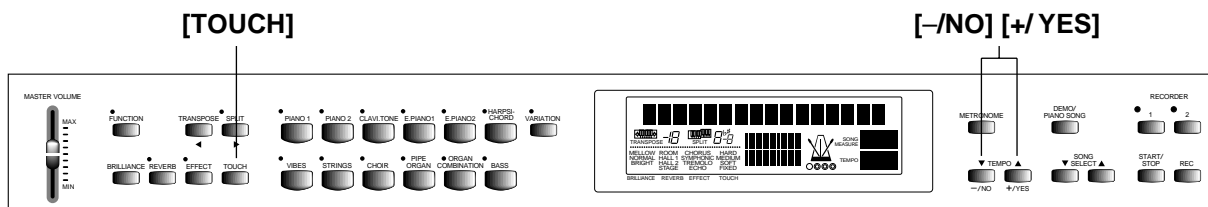

Procedure

Press [TOUCH] to change the setting.

⇒ The display indicates the current selection.

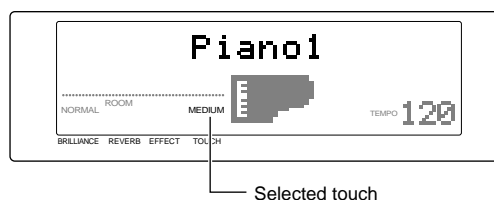

Selected touch

Volume adjustment for FIXED setting

If FIXED touch is selected, you can hold down the [TOUCH] button to display and change the velocity (volume) setting. To change the setting, hold down [TOUCH] and press [-/NO] or [+/YES]. You can set to any value between 1 and 127; the default setting is 64.

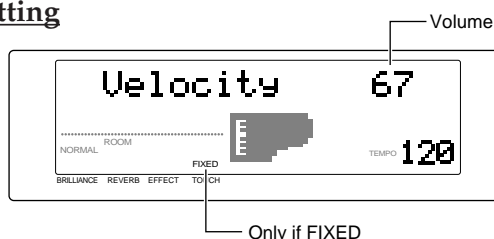

Volume

Only if FIXED

The clavivola measures keyboard striking force by monitoring the velocity at which the key moves downward when hit. If touch is HARD, MEDIUM, or SOFT, this physical velocity determines the volume.

Velocity = 1: Minimum volume
Velocity = 127: Maximum volume

The FIXED-touch velocity setting applies to all voices.

TRANSPOSE

This feature allows you to shift the pitch of the entire keyboard, so that you can continue to play in a signature that you are comfortable with while at the same time "transposing" to match the key of a singer or of another instrument. You can set the transposition in semitone increments. If you set it to 5, for example, then each keyboard C will produce the sound of F, and any song played in key of C will be produced in key of F.

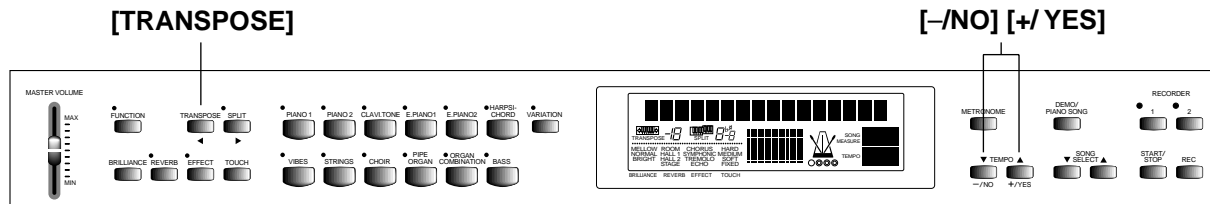

Procedure

Hold down [TRANSPOSE] and press [-/NO] or [+ /YES] to set the transposition interval, in semitone increments. You can set to any value from -12 to +12; the default setting is 0.

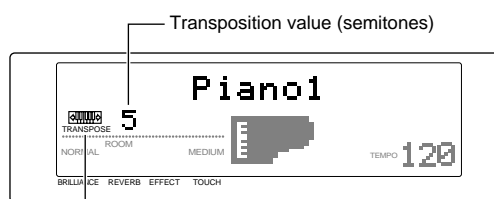

If transposition is set to nonzero, these indications and the numerical setting will remain on the screen.

Transposition settings...

- 12: Down by twelve semitones (one octave)
- 0: No transposition; notes produce their standard pitch
- +12: Up by twelve semitones (one octave)

High and low pitch limitations

The CLP-811/611 does not produce pitches above C7 (the highest note on an 88-key keyboard) or below A-1 (the lowest note). If you transpose up by n semitones, the highest n keys on the keyboard are automatically sounded one octave lower than the expected tone. If you transpose down, the lowest keys are automatically raised.

DUAL Mode (Mixing two voices together)

This feature selects simultaneous play of any two voices. You can combine dissimilar voices for a duet-like sound, or try working with similar voices to create a complex, layered type of sound.

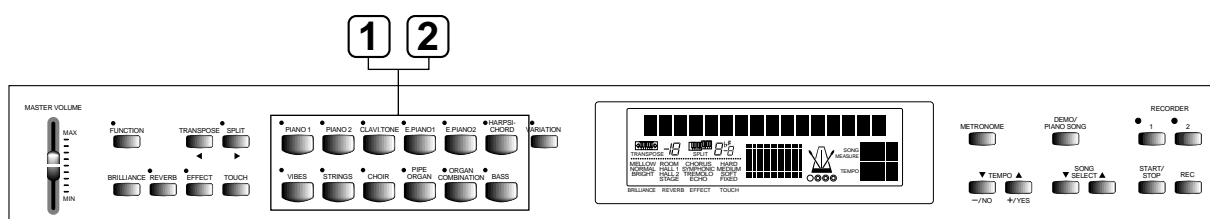

Procedure

1 Entering DUAL mode

Simply press the two appropriate voice selectors at the same time (hold one down and then press the other).

⇒ The voice indicators for both voices will come on.

* The screen shows the name for both voices, with the lowest-numbered voice first (in accordance with the voice numbering shown at right).

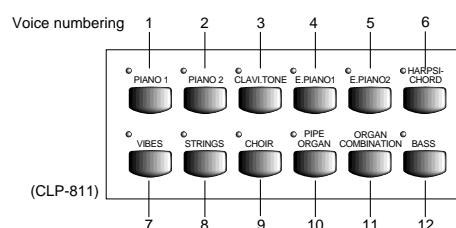
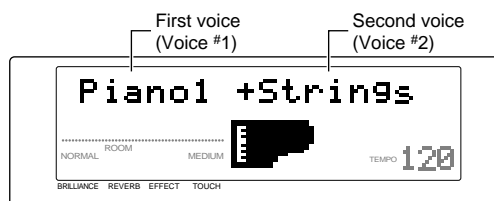

DUAL or SPLIT...

It is not possible to use the DUAL and SPLIT features at the same time.

Handling of VARIATION

The current VARIATION setting for each voice remains in effect when you first enter DUAL mode; the VARIATION indicator will be lit if VARIATION is selected for either or both voices. Once you have entered the mode, each press of [VARIATION] switches variation ON or OFF for both voices together. If you need to set variation ON for one voice only, you must do so before entering DUAL mode.

You can use function F4 to make various settings related to dual play — see page 29 for details.

If you select [STRINGS] as one of the voices, you can use function F4 to select a slower string attack.

2 Terminating DUAL mode...

Pressing any one of the voice selectors will select the corresponding voice and return you to normal mode.

Handling of effects

If both voices are set to their standard effects at the time you enter DUAL mode, the Clavinova will automatically select the effect and depth to be applied for the combination. In all other cases, the Clavinova will set the effect as follows.

[Type]

- If both voices are set to the same effect...
Each voice retains its original effect.
- If effect for one voice only is OFF...
Each voice retains its original effect settings. One voice receives no effect; the other receives the effect set up prior to entry into DUAL mode.
- If the two voices are set to different effects ...
The effect setting for Voice #1 is used for both voices. The effect setting for Voice #2 is forced off until DUAL mode terminates.
- If you change the EFFECT type while DUAL mode is in progress, the Clavinova will apply the newly selected effect to both voices.

[Depth]

You can set the depth to any level using function F4.

SPLIT Mode (Dividing the keyboard)

This feature allows you to divide the keyboard into left and right zones. You can select the split point, and assign a different voice to each zone.

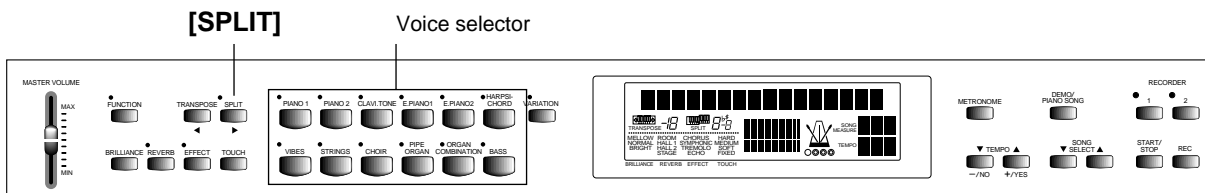

Procedure

1 Enter SPLIT mode.

Press [SPLIT].

⇒ The SPLIT indicator lights up.

⇒ The Clavinova automatically selects the default voice (BASS if CLP-811; STRINGS if CLP-611) for the left zone.

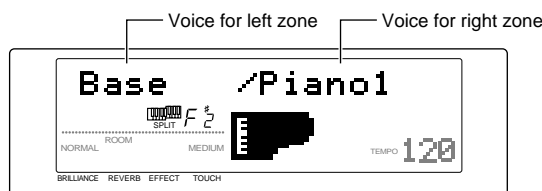

You can use function F5 to make various settings related to split play — see page 29 for details.

2 Select the split point.

Hold down [SPLIT] and hit the key at which you want to split the keyboard. If you omit this operation, the Clavinova automatically sets the split point to F#2.

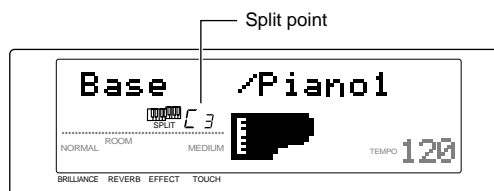

SPLIT or DUAL...

It is not possible to use the DUAL and SPLIT features at the same time.

The "split point" is the highest note in the left zone.

Handling of VARIATION

You can select VARIATION independently for each of the two voices. During SPLIT mode, the VARIATION lamp and voice indicator show the status of the right-zone voice only. While you are holding the [SPLIT] button down, however, the lamps change to show the status for the left-zone voice.

You can also use function F5 to set the split point (see page 29).

3 **Select the voice for the right zone.**
Press a voice selector to select the voice for the right zone.

4 **Select the voice for the left zone.**
Hold down [SPLIT] and press a voice selector to select the voice. (The voice indicator for the currently selected left-zone voice lights up while [SPLIT] is held down.)

5 **Terminating SPLIT mode...**
Press and release the [SPLIT] button.
⇒ The SPLIT indicator goes off.

Handling of EFFECTS

If both voices are set to their standard effects at the time you enter SPLIT mode, the Clavinova will automatically select the effect and depth to be applied for the combination. In all other cases, the Clavinova will set the effect as follows.

[Type]

- a) If both voices are set to the same effect...
Each voice retains its original effect.
- b) If effect for one voice only is OFF...
Each voice retains its original effect settings. One voice receives no effect; the other receives the effect set up prior to entry into SPLIT mode.
- c) If the two voices are set to different effects...
The effect setting for the right-hand voice is used for both voices. The effect setting for the left voice is forced off until SPLIT mode terminates.
- d) If you change the EFFECT type while SPLIT mode is in progress, the Clavinova will apply the newly selected effect to both voices.

[Depth]

You can set the depth to any level using function F5.

Using the METRONOME

The CLP-811/611 includes a built-in metronome with adjustable tempo, volume and beat.

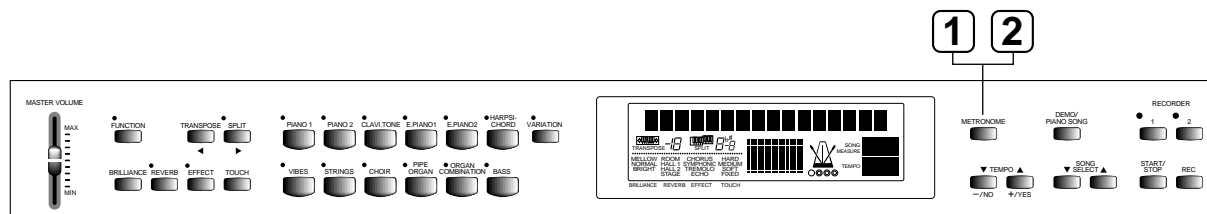

Procedure

1 **Switch on the metronome and set the tempo.**
Press the [METRONOME] button.
⇒ The metronome comes on and begins tapping.

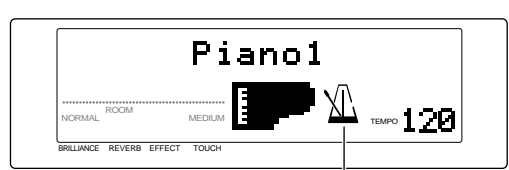

Animated metronome icon

Adjust the tempo.

Press TEMPO [▼][▲] as necessary to set the tempo. You can set to any value between 32 and 280. The default setting is 120.

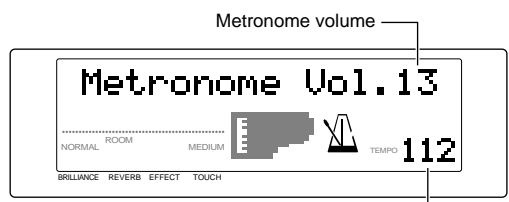

Metronome volume

Tempo

Adjust the metronome volume.

Hold down [METRONOME] and press [-/NO] or [+ /YES] to adjust the metronome volume. The screen continues to display the volume setting while the button is held down. You can set to any value between 1 and 20; the default is 10.

2 **Switching off the metronome...**
Press and release the [METRONOME] button.
⇒ The metronome goes off.

You can also use function F7 to set up the metronome. In addition to volume setting, F7 also allows you to select a beat. The metronome will generate the corresponding beat pulse, and a flashing beat display will appear under the metronome icon. (See page 32.)

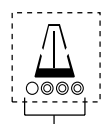

Beat marker

Using the Recorder

Your Clavinova includes a two-track recorder that lets you record and play back a keyboard performance. If you like, you can build a two-track song by recording separate performances (and separate voices) onto each track.

The recording function is a useful adjunct to any keyboard study program, since it lets you hear exactly how you sound from the listener's perspective. It can also be just plain fun.

The recorder registers the following data.

■ Common to Both Tracks

- Tempo
- Reverb type & depth
- Effect type

■ Independent for Each Track

- Notes played
- Voice selection
- Voice variation
- Dual-mode voices
- Split-mode voices
- Damper pedal
- Soft pedal
- Sostenuto pedal
- Brilliance level
- Effect depth
- DUAL-mode settings (F4)
- SPLIT-mode settings (F5)

 **NOTE** DUAL-and SPLIT-mode settings cannot be changed while recording is in progress.

Recording

Procedure

- 1 Make initial settings.**
Select the voice you want to use. (If you are using SPLIT or DUAL mode, select both voices.) You may also want to set the volume and tempo values.
- 2 If you have already recorded to one track and wish to listen to it while recording on the other, check that the indicator for the track you want to hear is lit up green. If the lamp is off, press the track button ([1] or [2]) once to set it on.**
- 3 Enter RECORDING-mode standby.**
Press the [REC] button once to enter recording standby. The track-indicator over one of the track buttons will light up red.

The lamp will come on only if the track contains recorded data.

Before beginning a recording...

You may find it convenient to press both buttons to check whether data already exists. If either lamp comes on, then the corresponding track contains data that will be lost when you begin recording to it.

If you have not recorded anything since power-on, the lamp above button [1] will come on. **If you have already recorded,** then the lamp above the most recently recorded track will come on.

You cannot enter RECORDING mode while the Clavinova is in DEMO/PIANO SONG mode.

To release RECORDING-mode standby...

Press the [REC] button a second time.

4 Select the track you want to record.

The red indicator shows the currently selected track. If you wish to change the selection, press the appropriate track button ([1] or [2]).

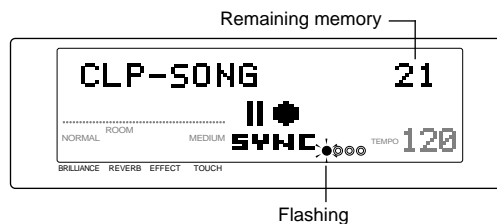

5 Start the recording.

Recording begins automatically when you play a note at the keyboard. As an alternative, you can begin the recording by pressing the [START/STOP] button.

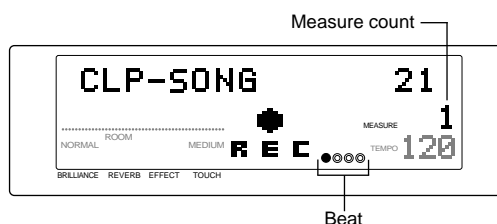

6 Stop the recording.

You can stop the recording by pressing either [REC] or [START/STOP]. The indicator above the recorded track will change to green, to indicate that the track contains data.

If the selected track already contains recorded data...

That data will be lost when you begin actual recording as described in Step 5 below.

The approximate amount of remaining memory...

appears at the upper right of the screen (in kilobytes). The starting value (with both tracks empty) is 21.

The first metronome dot flashes in time with the current tempo setting.

Using the left pedal as a START/STOP switch...

You can set the left pedal to operate in the same way as the [START/STOP] button, so that you can start and stop recording without using your hands. Left-pedal operation is determined by function F9; see page 33 for details.

The screen counts the measures (in accordance with the TEMPO setting) as recording proceeds. The metronome dot display keeps track of the beat.

You are free to switch the metronome sound on or off. The metronome sound is not included in the recording.

Maximum recording capacity...

*is approximately 4,200 notes, but varies somewhat according to pedal usage and other such factors. The recording indicator begins flash when memory is almost full. If memory becomes completely full, recording stops and the **Memory Full!** message appears.*

Changing initial settings

After recording is completed, it remains possible to modify the initial settings that you selected at Step 1 above. (It is not possible, however, to modify SPLIT or DUAL settings.)

When making such a change, BE CAREFUL! DO NOT hit any keys on the keyboard and do not press the [START/STOP] button, as doing so will cause erasure of all your data.

To make a change, proceed as follows.

- Press [REC] to enter RECORDING mode.
- If necessary, press the track button for the track you want to change (so that the indicator is red).
- Make the changes. To change the voice selection, for example, you would press the appropriate voice selector.
- Press [REC] again to exit RECORDING mode.

If you begin making a change at Step (c) but then wish to cancel it, you can do so by pressing the other track button and then pressing [REC].

Tempo, reverb type/depth, and effect type settings...

apply to both tracks. If you change the value for one track, the change automatically applies to both.

Erasing a track

To erase a track, proceed as follows:

- (a) Press [REC] to enter RECORDING mode.
- (b) Select the track you want to erase (so that the indicator is red).
- (c) Press [START/STOP] twice.

Playback

To select a track for playback, press the corresponding track button so that the indicator comes on green. You can then start the playback by pressing [START/STOP]. Note that you are free to select either or both tracks. (If a track is empty, its indicator will not come on.)

Playback always begins from the start of the recorded data, and stops automatically at the end of the recorded data. The LCD displays the measure count as playback progresses. You can stop playback at any time by pressing the [START/STOP] button.

If both tracks contain data, then once you have started playback you can toggle sound for either track ON or OFF by pressing the corresponding track button.

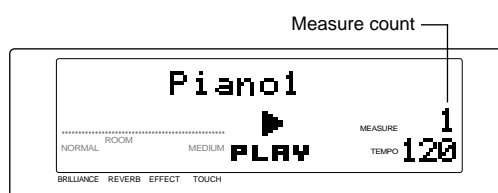

You cannot start playback while the Clavinova is in DEMO/PIANO SONG mode or FUNCTION mode. (But note that FUNCTION mode is automatically released when you press either of the track buttons.)

It is possible to play along on the keyboard during playback.

To adjust the playback volume and tempo...

Use the [MASTER VOLUME] slider and the [TEMPO] buttons. To restore the initial TEMPO setting, press both TEMPO buttons at the same time.

The Clavinova retains the recording even after power goes off, and will hold it for about a week without power. If you wish to maintain the data for a long period of time, be sure to switch the power on at least a few minutes each week.

You can use the **MIDI Bulk Dump** function to save your recording to an external storage device (such as a Yamaha DOU-10 Disk Orchestra Unit). See page 34 for details.

If you use the metronome during playback...

It will automatically switch off when playback is finished.

A track will not produce any sound if its indicator is off. This is in contrast to built-in piano songs, where even a deselected track may play back at low volume as a practice aid (see page 11).

Playback data is not transmitted through the MIDI OUT connector.

Synchro Start

The Synchro Start feature lets you set recorder playback so that it begins automatically when you play on the keyboard.

To select this feature simply hold down one of the recorded track buttons and press **[START/STOP]**.

A “SYNC” indication will appear on the screen to indicate that the Clavinova is in Synchro Start standby, and the first metronome dot will flash in time with the current tempo setting.

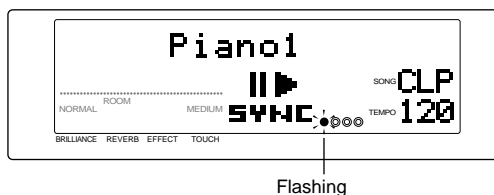

Function of Left Pedal

You can set the left pedal so that it functions as a second **[START/STOP]** button. This makes it possible for you to use your foot to start and stop playback and recording, so that your hand does not have to jump from the panel to the keyboard. Left-pedal operation is selected by function F9; see page 33 for details.

Configuration Functions (FUNCTION mode)

The Clavinova's FUNCTION mode provides a variety of configuration functions that you can use to customize the operating environment. When you first receive the Clavinova, all parameters are preset to their factory defaults. The configuration functions give you the freedom to adjust the settings to suit your needs.

FUNCTION mode consists of 15 or 16 main functions (F1 to F15 on CLP-811, F1 to F14 on CLP-611). Six of these are further divided into subfunctions. The table below illustrates the structure.

Function Table

Main Functions	Subfunctions	Page
[F1.Tune] (Keyboard fine tuning)		27
[F2.KTune] (Key-by-key fine tuning)		27
[F3.Scale] (Temperament selection)		28
[F4.DualFunc.] (DUAL-mode settings)	4.1 D.Balance (Voice volume balance)	29
	4.2 D.Detune (Voice tuning divergence)	29
	4.3 Vc1.Octave (Octave shift for Voice #1)	29
	4.4 Vc2.Octave (Octave shift for Voice #2)	29
	4.5 Vc1.EffDpt (Effect depth for Voice #1)	29
	4.6 Vc2.EffDpt (Effect depth for Voice #2)	29
	4.7 Str.Atk (Attack speed for STRINGS voice)	29
	4.8 ResetOK? (Return to factory defaults.)	29
[F5.SplitFunc.] (SPLIT-mode settings)	5.1 SplitPoint (Split point)	29
	5.2 S.Balance (Voice volume balance)	30
	5.3 VcR.Octave (Octave shift for right zone)	30
	5.4 VcL.Octave (Octave shift for left zone)	30
	5.5 VcR.EffDpt (Effect depth for right zone)	30
	5.6 VcL.EffDpt (Effect depth for left zone)	30
	5.7 Sus.Pedal (Effective range of damper pedal)	30
	5.8 ResetOK? (Return to factory defaults.)	30
[F6.OrganEdit] (ORGAN COMBINATION settings)	6.1 ***** (Organ type) [Where "*****" is replaced by type name, such as "JAZZ ORGAN1".]	31
	6.2 VoiceEdit (Voice edit settings)	31
	6.3 AtkMode (Attack mode)	31
	6.4 RotSP.Spд (Speed of rotary-speaker effect)	31
	6.5 RotSP.Dpt (Depth of rotary-speaker effect)	31
	6.6 ResetOK? (Return to factory defaults.)	31
	[F7.Metronome] (Metronome settings)	7.1 Beat
	7.2 Volume	32

Attack: Initial, sharp segment of sound produced immediately following key strike.

Rotary-speaker effect: Shimmering sound effect obtained by rotating the speaker.

Main Functions	Subfunctions	Page
[F8.Display] (Display mode)		32
[F9.L.Pedal] (Function of left pedal)		33
[F10.DamperDpt] (Damper-pedal depth)		33
[F11.Damper] (Number of damper-pedal levels)		34
[F12.CancelVol] (Volume of muted piano-song track)		34
[F13.MIDIFunc.] (MIDI settings)	13.1 TxCh. (MIDI transmitting channel)	34
	13.2 RxCH. (MIDI receiving channel)	34
	13.3 Local (Local control ON/OFF)	35
	13.4 PrgChg (Program Change enable/disable)	35
	13.5 CtrChg (Control Change enable/disable)	35
	13.6 MIDITran (Transposition of outgoing MIDI data)	35
	13.7 SetupSnd (Transmit Panel setup file)	35
	13.8 BulkDump (Bulk data dump)	35
CLP-811 only: [F14.MicRevDpt] (Microphone reverb depth)		36
[F14/F15.Backup] (Backup ON/OFF settings) * F14 on CLP-611 F15 on CLP-811	14.1/15.1 Voice (Voice settings)	36
	14.2/15.2 MIDI (MIDI settings)	36
	14.3/15.3 Tune (Tuning and temperament settings)	36
	14.4/15.4 Pedal (Pedal settings)	36
	14.5/15.5 Display (Display mode)	36

Basic Procedure

This section explains the procedure for viewing and changing the function settings.

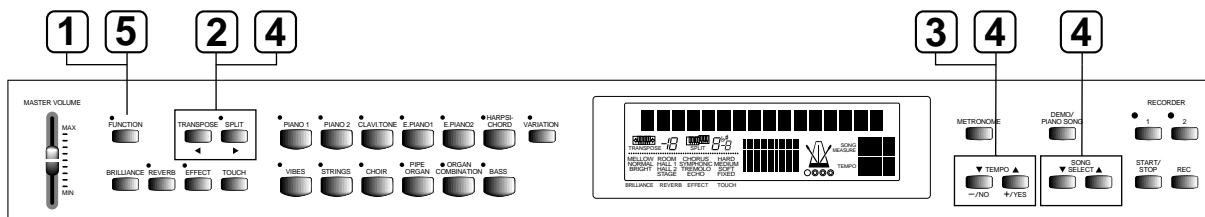

Procedure

1 Enter FUNCTION mode.

Press [FUNCTION].
 ⇒ The FUNCTION indicator lights up.

2 Select the main function.

Select the main function using the [◀] and [▶] buttons directly to the right of the [FUNCTION] button. (The arrow markings are printed under the buttons.) Main functions run from F1 to F15 (on the CLP-811) or F14 (on the CLP-611).

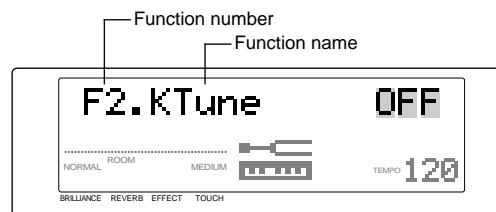

3 Change the setting or select the subfunction using the [-/NO] and [+ /YES] buttons.

If there are no subfunctions: Pressing the button changes the value.
If there are subfunctions: Press [+ /YES] to move to a subfunction.

4 Proceed using the following three sets of buttons.

- Use the [◀] and [▶] buttons to cycle through subfunctions and main functions.
- Use the [-/NO] and [+ /YES] buttons to set the value for the item marked by the blinking cursor on the screen. Press both buttons at the same time to return the value to its factory default.
- If you are working at a screen with multiple settings, use SONG SELECT [▼], [▲] to select the item you want to set. The selected item will blink on the screen. (This operation is effective only with screens that present more than one value.)

5 To terminate FUNCTION mode...

Press the [FUNCTION] button.
 ⇒ The FUNCTION indicator goes off, and the screen return to the previous display.

It is not possible to enter FUNCTION mode directly from DEMO/PIANO SONG mode or RECORDING or playback is in progress.

Function descriptions

F1.Tune (Keyboard fine tuning)

You use this function to fine-tune the pitch over the entire keyboard. This function is useful, for example, when you need to adjust tuning when playing with other instruments.

- 1 To access this item, enter FUNCTION mode and select main function F1.

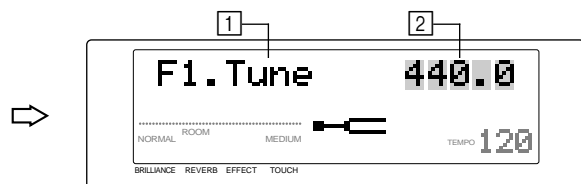

- 2 The screen shows the current pitch (in hertz) for key A3. You can adjust the pitch (in increments of about 0.2 hertz) by pressing [-/NO] or [+ /YES]. The adjustment automatically carries over to all keys on the keyboard.

Values: 427.0 to 453.0 (hertz)

Default: 440.0 (hertz)

- **Hertz:** Frequency, in cycles per second; abbreviated as “Hz”. The frequency of a sound wave determines its pitch, with higher frequencies producing higher pitches.

NOTE You can make the same adjustment directly from the keyboard without entering [FUNCTION] mode, as follows.

To raise the pitch (by about 0.2 Hz)...

Hold down the two lowest white keys (A-1 and B-1) and hit any key from C3 to B3.

To lower the pitch (by about 0.2 Hz)...

Hold down the two lowest keys (A-1 and A#-1) and hit any key from C3 to B3.

To reset to standard pitch...

Hold down the three lowest keys (A-1, A#-1, B-1) and hit any key from C3 to B3.

NOTE You can also adjust pitch in increments of about 1 Hz (without entering FUNCTION mode) as follows.

To raise or lower the pitch...

Hold down keys A-1 and B-1 (the two lowest white keys) or else A-1 and A#-1 (the two lowest keys), and press [-/NO] or [+ /YES].

To reset to standard pitch...

Hold down keys A-1 and B-1 or else A-1 and A#-1 and press [-/NO] and [+ /YES] at the same time.

(Note that the screen will show the TUNE display when you hold down keys A-1 and either A#-1 or B-1, and will then return to normal display when these keys are released.)

F2.KTune (Key-by-key fine tuning)

This function lets you adjust the pitch of individual keys, so that you can set up your own customized scaling system (temperament). The function also allows you to switch this customized scaling system OFF or ON at any time.

- 1 To access this item, enter FUNCTION mode and proceed to main function F2.

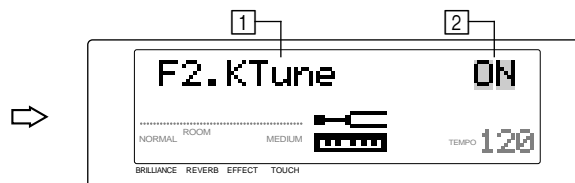

- 2 The screen indicates whether the function is ON or OFF. You can toggle the setting by pressing either [-/NO] or [+ /YES]. You must set the function ON if you wish to adjust the tuning.

Values: ON, OFF

Default: OFF

- The ON/OFF setting determines whether this customized tuning is used during play. Set ON to use the tuning, or OFF to use standard tuning.

- 3 After setting the function ON, hit the key that you want to tune.

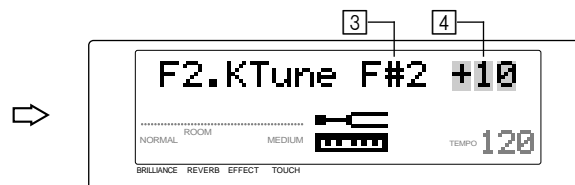

The screen displays the name of the struck key.

- 4 You can now adjust the pitch for that key by pressing [-/NO] or [+ /YES]. Adjustment is in 1-cent increments, and is indicated as a relative value (“0” produces standard pitch).

Values: -50,...,+50 (cents)

Default: 0 (standard pitch) for all keys

You can repeat this procedure (3) and (4) to adjust pitch for as many keys as you like.

Cent: One-hundredth of a semitone. (100 cents = 1 semitone)

To reset fine tuning of all keys to “0”...

- 1 Press down the three lowest keys on the keyboard (A-1, A#-1, and B-1) at the same time. The screen will display the following.

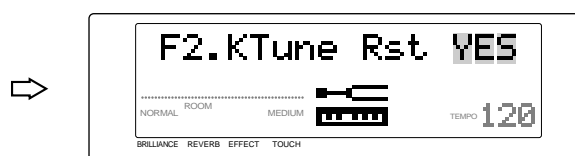

- 2 Press [+ /YES] to reset.

F3.Scale (Temperament selection)

This function selects the tuning system, or *temperament*.

The *equal temperament* now standard on present-day pianos was preceded by a series of other temperaments. These various temperaments had an important influence on music composition and instrument development in their day. Selecting one of these other temperaments allows you to experience the original sound of older musical pieces.

The Clavinova lets you to select from seven different temperaments, as follows.

Equal

Pure Major

Pure minor

Pythagorean

Mean Tone

Werckmeister

Kirnberger

- 1 To view or change the temperament setting, enter FUNCTION mode and proceed to main function F3. The screen displays the current temperament value and key (if applicable).

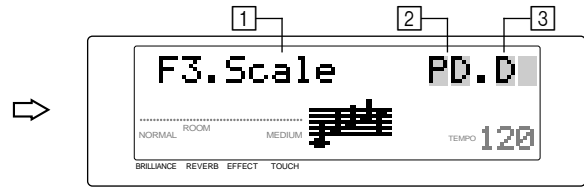

- 2 To change the temperament: Be sure that the blinking cursor is located over the temperament value. (If necessary, press SONG SELECT [▼] to move the cursor.) Then press [-/NO] or [+ /YES] to change the setting.

Values: EQ. Equal
PM. Pure major
Pm. Pure minor
PY. Pythagorean
ME. Mean tone
WE. Werckmeister
KI. Kirnberger

Default: EQ. Equal

- 3 If you select a non-equal temperament, you must also select the key you want to play it in. (Tuning is different for each key.) To do this, press SONG SELECT [▲] to move the cursor to the key-selection area, and then press [-/NO] or [+ /YES] to change the setting.

Values: C, D \flat , D, E \flat , E, F, F \sharp , G, A \flat , A, B \flat , B

Default: C



You use the SONG SELECT arrows to select the parameter you want to set (so that the parameter is marked by a blinking cursor). You then use the [-/NO] or [+ /YES] button to set the value.

F4.DualFunc. (Settings for DUAL mode.)

You use this function to set various parameters for DUAL-mode play.

- 1 To access this function: first activate DUAL mode (by pressing two voice selectors at the same time), then press [FUNCTION], and then press [◀] or [▶] to proceed to F4.

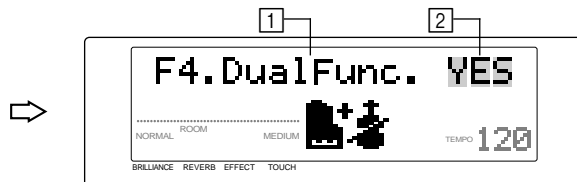

- 2 Next, press [+ / YES] to enter the subfunction group. Then use [◀], [▶] to move among the different subfunctions, and [- / NO], [+ / YES] to set the values.

NOTE If you are not working in DUAL mode... The top right of the screen will display a triple dash (---) and you will not be able to enter the subfunction group. To enable entry, activate DUAL mode by pressing two voice selectors at the same time. (You can do this without leaving FUNCTION mode.)

Subfunctions

4.1 D.Balance (Voice volume balance)

Settings: 0,...,20 [10 = equal balance]
[Above 10, Voice 1 is louder.]

Default: Varies according to voice combination
Sets the relative volumes for the two voices. This function is useful when you want to highlight one voice while playing the other as a backdrop.

4.2 D.Detune (Voice tuning divergence)

Introduces slight pitch difference between the two voices, producing a somewhat fatter sound.

Values: -10,...,+10 [0: No detuning]
[0 → +10: Voice #1 pitch rises]
[0 → -10: Voice #2 pitch rises]

Default: Varies according to voice combination

4.3 Vc1.Octave (Octave shift for Voice #1)

4.4 Vc2.Octave (Octave shift for Voice #2)

Values: -1, 0, +1

Default: Varies according to voice combination
These subfunctions allow you to shift each voice up or down an octave. Each combination produces its own distinctive sound and acoustics.

4.5 Vc1.EffDpt (Effect depth for Voice #1)

4.6 Vc2.EffDpt (Effect depth for Voice #2)

Values: 0,...,20

Default: Varies according to voice combination
These subfunctions allow you to set the depth for each voice's effect. Setting is not available if the effect is set OFF. Note that you cannot change a voice's effect selection while working in FUNCTION mode; you must first return to normal mode.

NOTE "Voice #1" is identified by the first (left-side) voice name on the screen. For information about how the Clavinova selects the voice order, see page 17.

4.7 Str.Atk (Attack speed for STRINGS voice)

Values: SLOW, FAST

Default: FAST

Sets the attack speed (the initial rise speed) for the STRINGS voice. A SLOW attack can create an interesting ambience for certain types of songs. (Note that this setting is effective only if STRINGS is selected as one of the voices.)

4.8 ResetOK? (Return to factory defaults.)

Press [+ / YES] to return all of the DUAL-mode subfunction settings to the factory defaults. (Factory defaults are different for each voice combination.)

NOTE As a shortcut, you can switch directly into FUNCTION mode's F4.DualFunc. area by holding down the two appropriate voice selectors and pressing [FUNCTION]. Once you have changed the settings, press [FUNCTION] again to quit the mode.

F5.SplitFunc. (Settings for SPLIT mode.)

You use this function to set various parameters for SPLIT-mode play.

- 1 To access this function: first enter SPLIT mode, then press [FUNCTION], and then press [◀] or [▶] to proceed to F5.

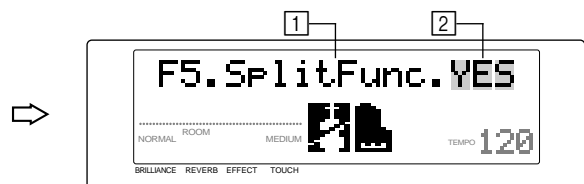

- 2 Next, press [+ / YES] to enter the subfunction group. Then use [◀], [▶] to move among the different subfunctions, and [- / NO], [+ / YES] to set the values.

NOTE If you are not working in SPLIT mode when you enter the main F5 screen... The top right of the screen will display a triple dash (---) and you will not be able to enter the subfunction group. To enable entry, you must first quit FUNCTION mode and press the [SPLIT] button.

Subfunctions

5.1 SplitPoint (Split point)

Values: Any key on keyboard

Default: F#2

Selects the split point. The selected key becomes the top note of the left zone.

- Once you are at this screen, you can select the split point simply by pressing the appropriate key.
- To set the split point without entering FUNCTION mode: Hold down [SPLIT] and press the appropriate key, see page 18.

5.2 S.Balance (Voice volume balance)

Values: 0,...,20 [10 = equal balance]
[Right voice gets louder as value increases.]

Default: Varies according to voice combination
Sets the relative volumes for the two voices.

5.3 VcR.Octave (Octave shift for right zone)

5.4 VcL.Octave (Octave shift for left zone)

Values: -1, 0, +1

Default: Varies according to voice combination
These subfunctions allow you to shift each voice up or down an octave. Set the values in accordance with the range of the music you are playing.

5.5 VcR.EffDpt (Effect depth for right zone)

5.6 VcL.EffDpt (Effect depth for left zone)

Values: 0,...,20

Default: Varies according to voice combination
These subfunctions allow you to set separate effect depths for each zone. Setting is not available if the effect is OFF. Note that you cannot change a voice's effect selection while working in FUNCTION mode; you must first exit the mode.

5.7 Sus.Pedal (Effective range of damper pedal)

Values: L, L+R, R

Default: L+R
Selects whether the damper pedal operates on both zones (L+R), on the left zone only (L), or on the right zone only (R).

5.8 ResetOK? (Return to factory defaults.)

Press [+ / YES] to reset all of the SPLIT-mode subfunction settings to their factory-default values. (Factory defaults are different for each voice combination.)

NOTE As a shortcut, you can switch directly into FUNCTION mode's **F5.SplitFunc.** area by holding down [SPLIT] and pressing the [FUNCTION] button. Once you have changed the settings, press [FUNCTION] again to return to normal mode.

F6.OrganEdit (ORGAN COMBINATION settings)

The CLP-811/611 offers you eight different editable organ types. You use the OrganEdit function to edit these types, and to select the type to be played.

- You can use the Backup function (F15 on the CLP-811, F14 on the CLP-611) to select whether editing results are retained after power goes off. See page 36.

You edit an organ voice by adjusting its various *stops* — each represented as a separate bar that appears on the display — and by setting a variety of other edit parameters. Specifically, you can edit the following items for each of the eight organ types.

- Volume levels for each of eight continuous tones
- Response time for continuous tones
- Volume levels for each of three decay (attack) tones
- Attack length for the three decay tones
- Attack mode (**EACH** or **FIRST**)
- Rotary speaker effect (depth and speed)

As an example, you can build a very realistic percussive organ sound by applying appropriate decay volumes and attack length. Or you might create a pipe-organ sound by combining slow response with a weak attack.

- To access this function: first select the ORGAN COMBINATION voice, then enter FUNCTION mode and go to main function F6.

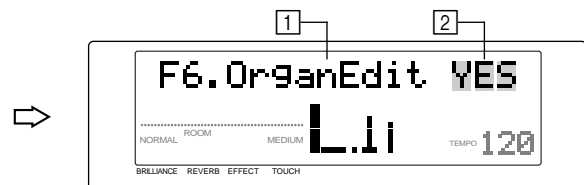

- Next, press [+ / YES] to enter the subfunction group. Then use [◀], [▶] to move among the different subfunctions, and [- / NO], [+ / YES] to set the values. (But see additional information below regarding operation of the VoiceEdit subfunction.)

NOTE If the ORGAN COMBINATION voice is not yet selected when you move to the main F6 screen... The top right of the screen will display a triple dash (---), and you will not be able to enter the subfunction group. To enable entry, you must first select the ORGAN COMBINATION voice. (You can do this without leaving FUNCTION mode.)

Subfunctions

6.1 *** (Organ type)** [Where "*****" is replaced by the type name, such as "JAZZ ORGAN1". If the selected type has been edited, a "*" appears after the name.]

Values: JAZZ ORGAN1, JAZZ ORGAN2, JAZZ ORGAN3, JAZZ 16 '1', BASIC 16 '8', THEATER 16', OLD ORGAN, WONDERFUL

Default: JAZZ ORGAN1

6.2 VoiceEdit (Voice edit settings)

Each voice allows you to set independent volumes for eight continuous tones and three decaying attack tones. You can also set a response time (for the continuous tones) and an attack length (for the decay tones).

Tones and Volumes

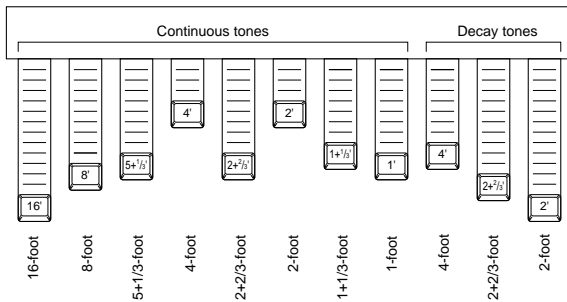

- The 8-foot stop sets the volume for the fundamental tone. The 4-foot, 2-foot, and 1-foot stops respectively set volumes for the overtones that are one octave, two octaves, and three octaves up. The 16-foot stop sets the volume for the tone that is one octave lower than the fundamental tone.

Response Time and Attack Length

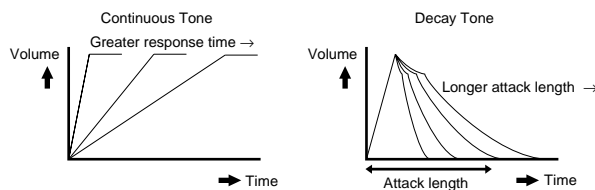

Procedure

- Go to the [6.2 VoiceEdit] screen, and then press SONG SELECT [▼] or [▲] to move into the editing component.
 - The screen displays a bar graph. Each bar corresponds to a different parameter, and can be set to any of eight levels.
- You can now use SONG SELECT [▼], [▲] to move from bar to bar, and the [+YES] and [-NO] buttons to change the bar levels. The currently selected bar is displayed in blinking mode.
- When you are finished editing, you can press [◀] or [▶] to move to another subfunction.

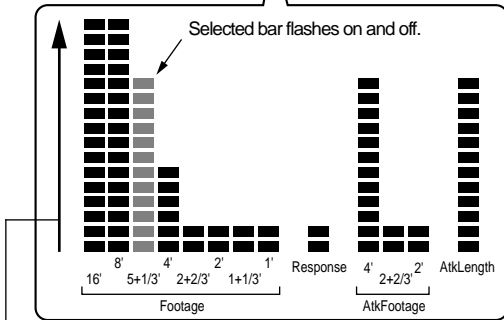
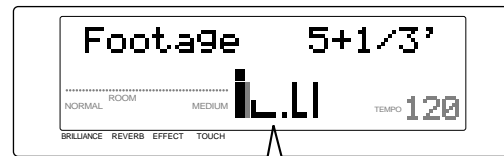

Each parameter (each bar on the graphic) can be set to any of eight levels.

Edit parameters are as follows.

- Footage 16' (Continuous-tone volume)
- Footage 8' (Continuous-tone volume)
- Footage 5+1/3' (Continuous-tone volume)
- Footage 4' (Continuous-tone volume)
- Footage 2+2/3' (Continuous-tone volume)
- Footage 2' (Continuous-tone volume)
- Footage 1+1/3' (Continuous-tone volume)
- Footage 1' (Continuous-tone volume)
- Response (Response time for continuous tones)
- AtkFootage 4' (Decay-tone)
- AtkFootage 2+2/3' (Decay-tone)
- AtkFootage 2' (Decay-tone)
- AtkLength (Length of decay tones)

6.3 AtkMode (Attack mode)

This parameter sets the attack mode for the organ voice selected by subfunction 6.1. Choose either of the following.

EACH: Apply attack tones to all notes. (This is the default.)

FIRST: Apply attack tones only to the first held note of any note combination (legato sequence). If at least one key is down, all subsequent keys are produced without attack tones.

6.4 RotSP.Spd (Speed of rotary-speaker effect)

6.5 RotSP.Dpt (Depth of rotary-speaker effect)

Values: 0,...,20

Default: Varies according to organ type

These parameters set up the rotary-speaker effect. The speed setting selects the speaker's rotation speed. The depth setting selects the intensity of the effect.

6.6 ResetOK? (Return to factory defaults.)

Press [+YES] to return all of the edit settings for the selected voice type to their factory defaults.

NOTE As a shortcut, you can switch directly into FUNCTION mode's **F6.OrganEdit** area by holding down the [ORGAN COMBINATION] button and pressing [FUNCTION]. When you are ready to exit from FUNCTION mode, press [FUNCTION] once again.

F7.Metronome (Metronome settings)

This function sets the beat and volume for the metronome.

- To access these settings, enter FUNCTION mode and go to main function F7.

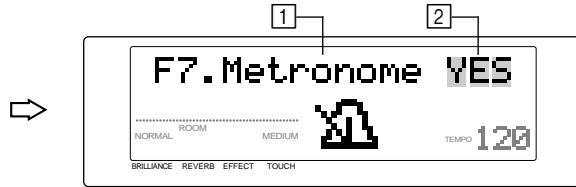

- Next, press [+ / YES] to enter the subfunction group. If necessary, use [◀] or [▶] to select the subfunction (either "Beat" or "Volume"), and then use [+ / YES] or [- / NO] to set the value.

Subfunctions

7.1 Beat

Values: NORMAL (no beat), 2, 3, 4, 5, 6
Default: NORMAL

7.2 Volume

Values: 1,...,20
Default: 10

NOTE You can also set the metronome volume without entering FUNCTION mode. Simply hold down the [METRONOME] button and press [- / NO] or [+ / YES] to change the setting.

NOTE As a shortcut, you can switch directly into the metronome setup function by holding down [METRONOME] and pressing [FUNCTION]. Once you have changed the settings, press [FUNCTION] again to return to normal mode.

F8.Display (Display mode)

This function selects the type of information displayed in the screen areas indicated below.

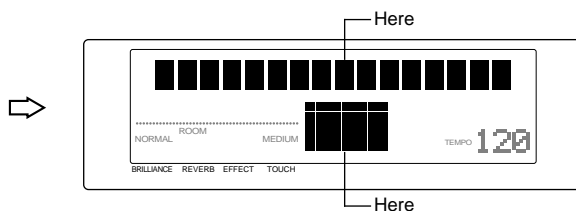

- To access this item, enter FUNCTION mode and go to main function F8.

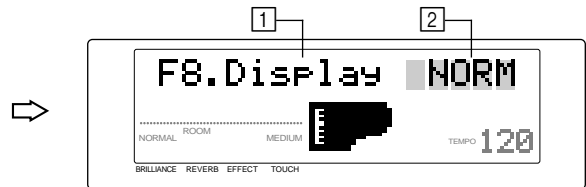

- Press [- / NO] or [+ / YES] to change the setting.
Values: NORM, CHORD, VELO, MIDI
Default: NORM

Explanation

NORM (normal)

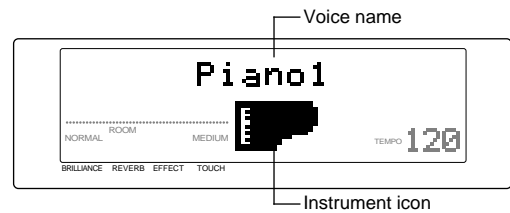

CHORD

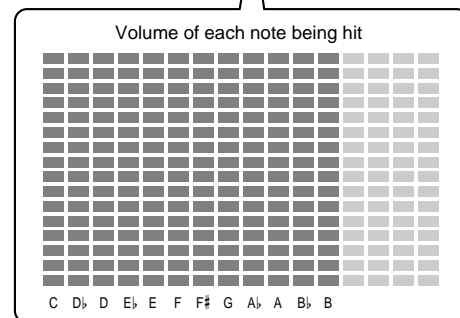
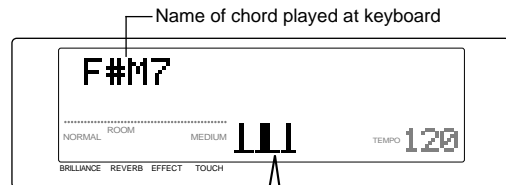

- The bar graph shows the volume of each note being hit, where the leftmost bar indicates note C (of any octave) and the rightmost bar shows note B (of any octave). If you hit two or more like-named notes (for example, C1 and C3), the graph indicates the volume for the loudest of these.

VELO (velocity)

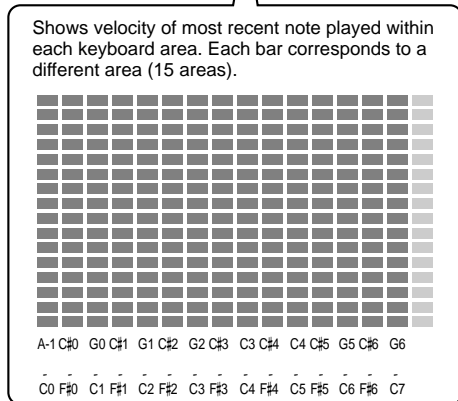
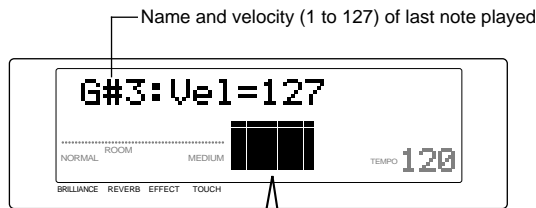

MIDI

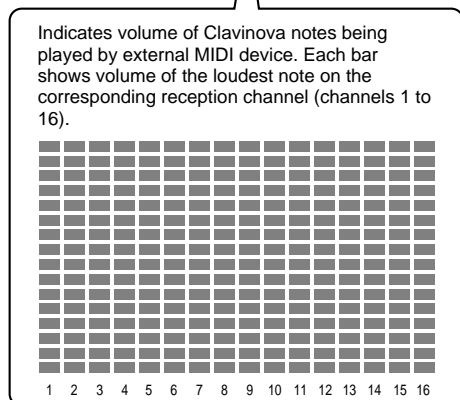
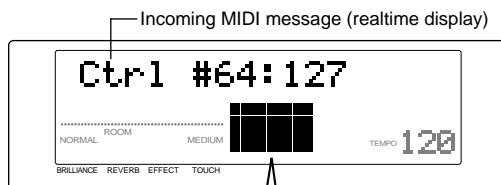

- The display format for incoming messages is as follows.

Message Type	Indication
Note on/off	xxx:Vel:yyy (where xxx = note name yyy = velocity)
Program Change	Prog #zzz
Control Change	Ctrl #zzz:zzz
Exclusive	Ex.Data

The screen does not report Aftertouch and Pitchbend messages.

F9.L.Pedal (Function of left pedal)

This setting determines whether the left pedal operates as a soft pedal (its normal function) or as a second, foot-driven START/STOP switch.

- To access this item, enter FUNCTION mode and go to main function F9.

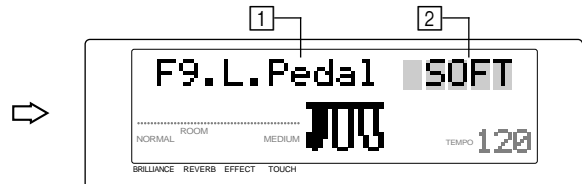

- Press [-/NO] or [+ /YES] to change the setting.

Values: SOFT, START

Default: SOFT

F10.DamperDpt (Damper-pedal depth)

Selects the amount of resonance applied by the damper pedal to the PIANO 1 acoustic piano voice.

- To access this item, enter FUNCTION mode and go to main function F10.

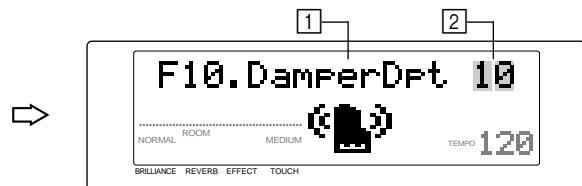

- Press [-/NO] or [+ /YES] to change the setting.

Values: 0,...,20

Default: 10

NOTE This setting is effective for the PIANO 1 voice only.

F11.Damper (Number of damper-pedal levels)

Under normal settings, the length of the damper pedal's sustain effect varies according to how far you displace the pedal — the harder you step down, the longer the notes are held. You use function F11 to set the number of discrete displacement levels recognized by the Clavinova. You may find this feature useful during recording: setting the value to "2" (pedal ON/OFF only) can reduce the amount of data generated by pedal action, allowing you to record a longer series of notes.

- 1 To access this item, enter FUNCTION mode and go to main function F11.

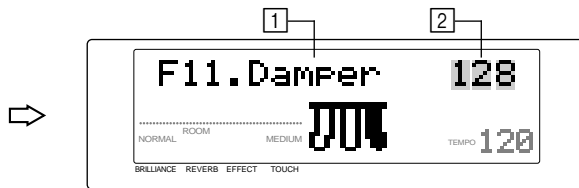

- 2 Press [-/NO] or [+YES] to change the setting.
Values: 2, 8, 128 (levels)
Default: 8

F12.CancelVol (Volume of muted piano-song track)

When playing one of the Clavinova's 30 built-in piano songs, you can elect to switch off either part (left-hand or right-hand) so that you can practice along. Under default settings, the Clavinova continues to play back the deselected part at a low volume to serve as a practice guide. You can use the F12 setting to make this playback louder or softer, or to switch it off entirely.

- 1 To access this setting, enter FUNCTION mode and go to main function F12.

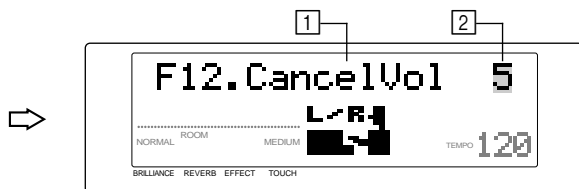

- 2 Press [-/NO] or [+YES] to change the setting.
Values: 0,...,20
Default: 5

F13.MIDIFunc. (MIDI settings)

This function sets up the various MIDI parameters. For general information about your Clavinova's MIDI support, refer to "MIDI Data Format" on page 48.

- 1 To access these settings, enter [FUNCTION] mode and go to main function F13.

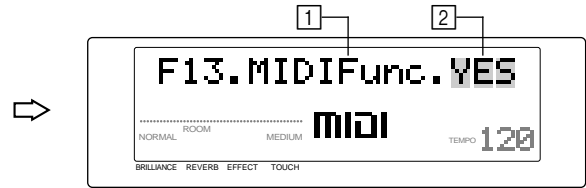

- 2 Next, press [+YES] to enter the subfunction group. Then use [◀], [▶] to move among the different subfunctions, and [-/NO], [+YES] to set the values.

Subfunctions

13.1 TxCh. (MIDI transmitting channel)

Values: 1,...,16; OFF

Default: 1

Selects the channel the Clavinova uses to transmit performance-related messages to external MIDI devices. (Only devices set to receive on this channel will respond to these messages.)

- **For DUAL and SPLIT mode play...**

If **TxCh** is set to any value other than **OFF**, the Clavinova will always use Channel 2 to transmit data from Voice 2 (in DUAL mode) or from the left zone (in SPLIT mode). If the setting is **OFF**, the Clavinova will not transmit any data for either voice.

- The Clavinova does not transmit data for demo songs, piano songs, and recorded performances.

13.2 RxCH. (MIDI receiving channel)

Values: ALL; 1&2; 1,...,16

Default: ALL

Selects the channel the Clavinova uses to receive performance-related messages from external MIDI devices. The Clavinova will not recognize any messages received over non-selected channels.

- **If setting is ALL**

The Clavinova operates as a multitimbral playback device, responding independently to messages over all channels. This setting is ideal when you want to use a sequencer to drive a multivoice arrangement.

- **If setting is 1&2**

The Clavinova responds to messages received over channels 1 and 2 only.

- Panel settings and keyboard play are not affected by received MIDI data (with the exception of MIDI data for reverb type, reverb depth, and effect type).
- The Clavinova does not receive MIDI messages when operating in DEMO/PIANO SONG mode.

13.3 Local (Local control ON/OFF)

Values: ON, OFF

Default: ON

Selects whether the Clavinova keyboard produces sound from the Clavinova. More precisely, determines whether the Clavinova's keyboard drives the Clavinova's internal tone-generator system.

Under normal circumstances this setting is left **ON**, so that the Clavinova keyboard produces sound from the Clavinova's tone generator. If you want to use the keyboard to control an external MIDI device only, however, you would set this value to **OFF**. This setting makes it possible, for example, to use the keyboard to play an external device, while at the same time using another external device to play the Clavinova.

13.4 PrgChg (Program Change enable/disable)

Values: ON, OFF

Default: ON

A MIDI *Program Change* message instructs the receiving device to switch voices.

If you are using the Clavinova to control an external device, for example, then each time you change the voice selection (by pressing a different voice selector), the Clavinova will issue a Program Change message telling the external device to switch to the same-numbered voice. (Each voice is associated with a unique program-change number.)

Similarly, if the Clavinova is playing MIDI data received from an external device, then receipt of a Program Change message will cause the Clavinova to change the voice used to reproduce this data. (Note that this change applies only to the MIDI data; the voice produced by the Clavinova keyboard does not change.)

There are times when you may want to disable the use of Program Change messages, so that voice switching at both sides must be handled locally. You can do this by setting the **PrgChg** value to **OFF**. In this case, the Clavinova will not generate messages when voice selectors are pressed, and will not respond to any Program Change messages that it receives.

• Program-change numbers on the CLP-811/611

Program-change number assignments on the CLP-811/611 are in conformance with the XG standard. Refer to "MIDI Data Format" (page 48) for specific information.

13.5 CtrlChg (Control Change enable/disable)

Values: ON, OFF

Default: ON

Control Change messages transfer performance-related control information from one MIDI device to another. Such information includes pedal actions and volume settings.

If you are using the Clavinova to control an external device, for example, then each time you step on the damper pedal a corresponding Control Change message is issued to that device.

If you are using an external device to control the Clavinova, then Control Change messages received from that device will cause appropriate changes at the Clavinova side. These changes apply only to incoming MIDI data; panel settings and keyboard sound do not change. (But note that reverb-depth control change is an exception, since it affects both MIDI and local sound.)

There are times when you may want to disable the use of Control Change messages. You can do this by setting the **CtrlChg** value to **OFF**, so that the Clavinova will not generate these messages, and will not respond to any such messages that it receives.

• Control Change implementation on the CLP-811/611...

Refer to "MIDI Data Format" (page 48) for details.

13.6 MIDITrans (Transposition of outgoing MIDI data)

Values: -12,...,12 (in semitones)

Default: 0 (no transposition)

Use this function to set transposition of note data being sent out from the Clavinova. Note that this operation has no relation to the keyboard transposition set up by the [TRANPOSE] button.

13.7 SetupSnd (Transmit Panel setup file.)

This operation transmits the Clavinova's current panel configuration to an external MIDI sequencer such as the YAMAHA DOU-10 Disk Orchestra Unit, so that it can be restored to the Clavinova at a later time.

For example, assume that you want to record a performance to a sequencer so that you can later play it back at the Clavinova while at the same time playing along locally at the keyboard. In this case you might find it convenient to first record the panel configuration you will want to use for local play. The panel will then set itself automatically just before playback begins.

Procedure

- ① Set the panel to the configuration that you want to record.
- ② Run a MIDI cable from the MIDI OUT connector on the Clavinova to the MIDI IN connector on the sequencer.
- ③ Enter FUNCTION mode and move to subfunction **13.7 SetupSnd**.
- ④ Press [+/**YES**] to transmit the setup.
➡ The screen displays **Completed** briefly to indicate that transfer is completed.

• Transmitted data...

In addition to the Panel data indicated on page 50 of the "MIDI Data Format" section, the Clavinova also transmits the key-by-key fine tuning data set up within the **F2.KTune** function.

• To reload the data from the external device...

1. Run a MIDI cable from the MIDI OUT on the sequencer to the MIDI IN at the Clavinova.
2. Begin transmission from the sequencer. (Refer to the sequencer's operation manual.)
➡ The Clavinova automatically receives and loads the data.



It is not possible to reload the setup data into a different Clavinova model. If you stored setup data for a CLP-811, for example, then you can reload the data to any CLP-811, but not to a CLP-611.

13.8 BulkDump (Bulk data dump.)

This feature lets you permanently save recordings you have made with the Clavinova's RECORDER. The Bulk Dump operation sends the performance data from both RECORDER tracks to an external MIDI storage device such as the Yamaha DOU-10 Disk Orchestra Unit. (Note that this information is sent in the form of bulk data, rather than as sequence data.) The saved data can later be restored by retransmission.

Procedure

- ① Run a MIDI cable from the MIDI OUT connector on the Clavinova to the MIDI IN connector on the storage device.
- ② Set the storage device into the appropriate receiving mode. (Refer to the device's operating manual for instructions.)

- ③ At the Clavinova, select function F13 and move to subfunction **13-8 BulkDump**.
- ④ Press **[+/YES]** to begin the dump.
 - ➡ The screen displays **Working** while transmission is in progress, and then **Completed** to indicate that the operation is finished. It then returns to the original Bulk Dump screen.
- ⑤ When transfer is finished, you can terminate FUNCTION mode and resume normal play.

To reload the saved data:

1. Run a MIDI cable from MIDI OUT on the storage device to MIDI IN at the Clavinova.
2. Start transmission from the storage device. (Refer to the device's operation manual.)
 - ➡ The Clavinova automatically receives and restores the incoming data. The restored data is then available for normal playback.

NOTE

- It is not possible to reload data into a different Clavinova model. Data from a CLP-811, for example, can be loaded into another CLP-811, but not into a CLP-611.
- You cannot send or receive bulk data while the Clavinova is in RECORDING mode or while it is playing back recorded data.
- You cannot receive bulk data while the Clavinova is in FUNCTION mode.
- When transmitting bulk data, the Clavinova will not transmit other types of MIDI data and will not recognize incoming MIDI messages.

(On CLP-811 only:)

F14.MicRevDpt (Microphone reverb depth)

This function sets the reverb depth (intensity of reverb effect) applied to microphone input. (Note that this function is not available on the CLP-611.)

- ① To access this setting, enter FUNCTION mode and go to main function F14.

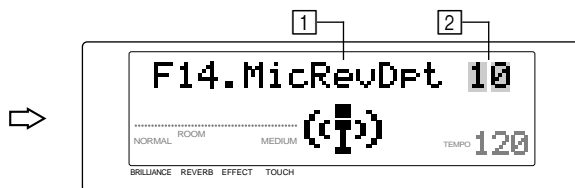

- ② Press **[-/NO]** or **[+/YES]** to change the setting.

Values: 0,...,20
Default: 10

F14/F15.Backup (Backup ON/OFF settings)

(F14 on the CLP-611; F15 on the CLP-811.)

The Clavinova's backup feature allows you to retain selected settings while power is off so that they can be restored when power comes back ON. Each BACKUP subfunction sets backup ON or OFF for a specific group of settings.

- If backup for a group is set OFF, all settings within that group return to their factory defaults each time power comes on. (A listing of factory defaults appears on page 47.) If backup is set ON, then existing settings are automatically restored.
- Memory backup remains effective for about a week, after which all settings will return to their factory defaults. If you wish to retain your settings for a long period of time, please be sure to switch the Clavinova on for at least a few minutes each week.

- ① To access this setting, enter FUNCTION mode and go to the main function F14 (CLP-611) or F15 (CLP-811).

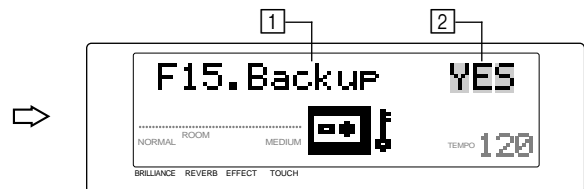

- ② Next, press **[+/YES]** to enter the subfunction group. Then use **[◀]**, **[▶]** to move among the different subfunctions, and **[-/NO]**, **[+/YES]** to set the values.

Subfunctions

14.1/15.1 Voice (Voice settings)

14.2/15.2 MIDI (MIDI settings)

14.3/15.3 Tune (Tuning and temperament settings)

14.4/15.4 Pedal (Pedal settings)

14.5/15.5 Display (Display mode)

Values: ON, OFF

Default: OFF*

* But note that the Backup ON/OFF settings themselves, as well as recorded performance data, are always backed up.

Parameters in Each Group

14.1/15.1 Voice (Voice settings)

- Voice selection
- DUAL mode ON/OFF status and voice combination
- The [F4.DualFunc.] settings (for each voice combination)
- SPLIT mode ON/OFF status and voice combination
- The [F5.SplitFunc.] settings (for each voice combination)
- REVERB type and depth
- EFFECT type and depth (for each voice)
- BRILLIANCE setting
- VARIATION ON/OFF status (for each voice)
- TOUCH setting
- All [F6.OrganEdit] settings
- All [F7.Metronome] settings
- The [F14.MicRevDpt] setting (CLP-811 only)

14.2/15.2 MIDI (MIDI settings)

All MIDI settings ([F13.MIDIFunc.] settings 13-1 to 13-6)

14.3/15.3 Tune (Tuning and temperament settings)

- Current TRANSPOSE setting
- Keyboard fine tuning ([F1.Tune] setting)
- Key-by-key fine tuning ([F2.KTune] settings)
- Temperament selection ([F3.Scale] settings)

14.4/15.4 Pedal (Pedal settings)

- Left-pedal function ([F9.L.Pedal] setting)
- Damper-pedal depth ([F10.DamperDpt] setting)
- Number of damper-pedal levels ([F11.Damper] setting)

14.5/15.5 Display (Display mode)

Display mode ([F8.Display] setting)

- **To reset all values to their factory defaults...**

Switch the power OFF, then hold down the highest key on the keyboard (key C7) and switch the power back on. Note that this operation will also delete all recorded performance data.

For a listing of the factory default values, see page 47.

The Clavinova's Device Connectors

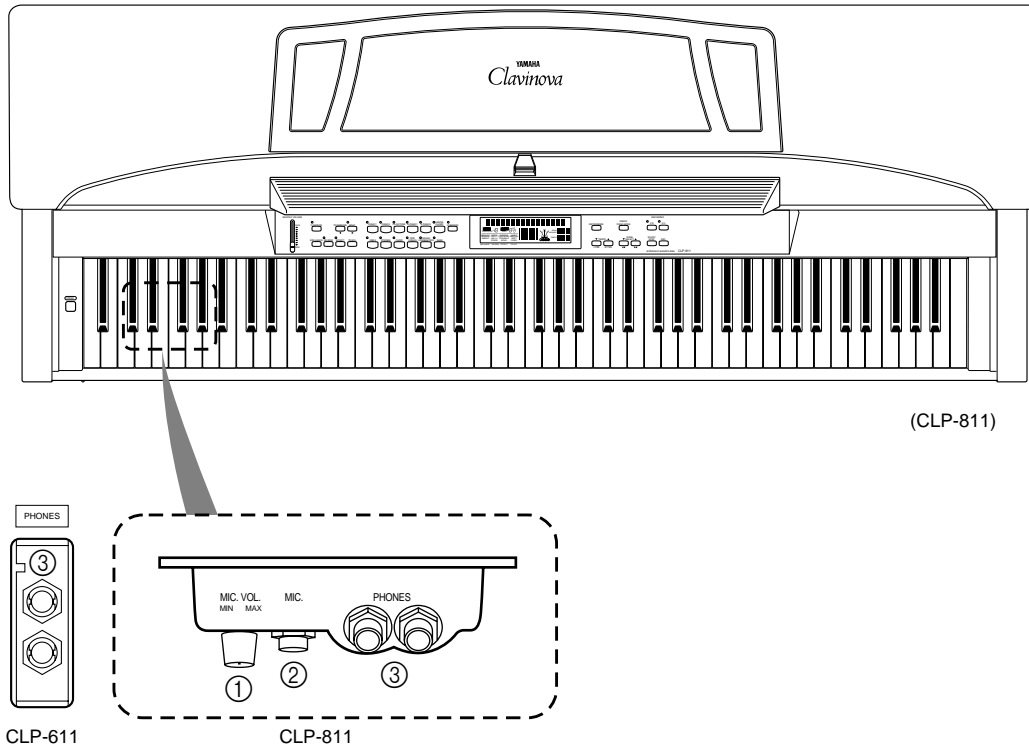

① MIC. VOL. dial, and ② MIC. jack (CLP-811)

Connecting a microphone to the **MIC** jack (a standard phone jack) lets you sing along. The input from the microphone is mixed with the keyboard sound and produced at the Clavinova's speakers.

• MIC. VOL. dial

Use the dial to adjust the input volume from the microphone.



NOTE Microphone reverb depth...

Although the reverb type setting is always the same for both keyboard and microphone, the CLP-811 allows you to set an independent reverb depth for the microphone input. (You make this setting using function F14; see page 36.)

③ PHONES jacks

The Clavinova provides two headphone jacks (standard phone jacks), so that two people can listen in at the same time. Connecting a headphone set to either jack automatically cuts off the internal speakers.

Recommended headphones:
Yamaha HPE-160

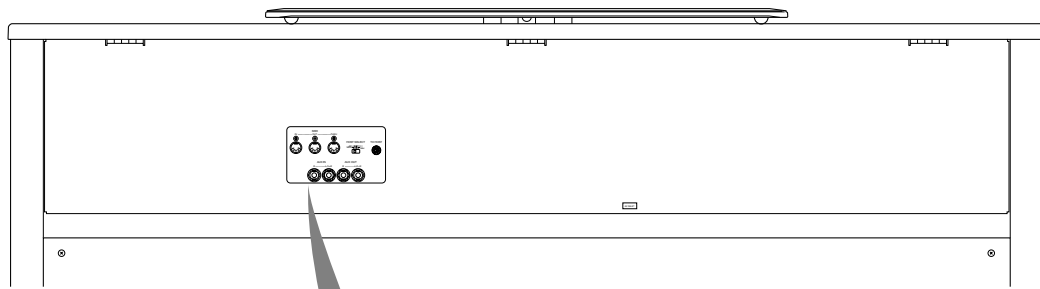

(CLP-811)

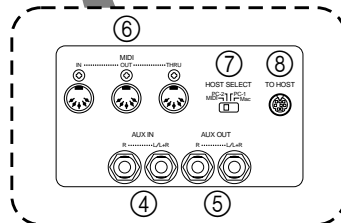

- ④ **AUX IN jacks (R and L/L+R)**
- ⑤ **AUX OUT jacks (R and L/L+R)**

- **AUX IN R and L/L+R**

These standard phone jacks accept connection from a synthesizer, tone-generator module (such as the YAMAHA DOU-10 Disk Orchestra Unit), or other such playback device. Sound transmitted from the external device is produced by the Clavinova's internal speakers. Make the connection (using standard audio cord) as illustrated at right.

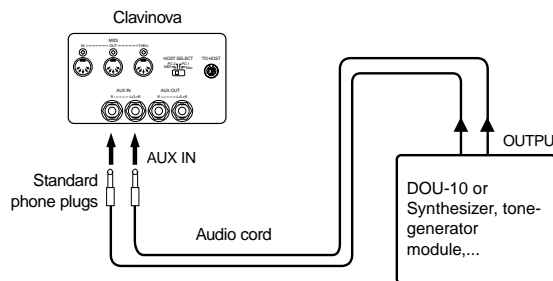

NOTE A line-level mono source can be connected to the L/L+R jack.

- **AUX OUT R and L/L+R**

You use these standard phone jacks to feed Clavinova output to an external stereo recorder, amplifier, or other such device. This makes it possible, for example, to record the sound to a tape recorder or cassette, or to produce it through external speakers. Make the connection (using standard audio cord) as shown above.

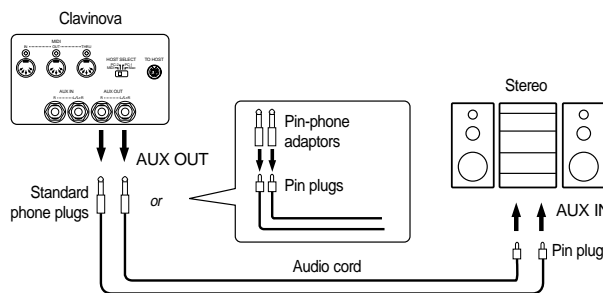

When connecting to a stereo unit, set the [MASTER VOLUME] slider to center position and adjust the volume at the recording side.

NOTE If a line is inserted into the L/L+R jack only, the Clavinova mixes left- and right-channel signals and outputs them over this line. This ensures that you don't lose any of the Clavinova's sound.

- ⑥ **MIDI IN, OUT, and THRU connectors**

These are used to connect to external MIDI devices. Note that you must set the HOST SELECT switch (described below) to **MIDI** in order to enable use of these connectors. For basic information about MIDI connections and operation, refer to page 48.

- ⑦ **HOST SELECT switch, and** ⑧ **TO HOST connector**

TO HOST connector....

Allows direct connection to a personal computer.

HOST SELECT switch...

Sets the connection type. If connecting directly to a personal computer, you use this switch to select the computer type. If connecting via MIDI, set this switch to the MIDI position. Refer to "Connecting to a Personal Computer" (page 40) for detail.

Never feed AUX OUT output back into the AUX IN jacks. When using AUX OUT to connect to an external device, do not connect that device back to the AUX IN at the Clavinova side. Since the AUX OUT signal always includes all sound received at the AUX IN jacks, interconnection will create a feedback loop that will distort the sound and may cause damage to your equipment.

Audio cord (and adaptors, if required) should be non-resistance type.

The Clavinova's [MASTER VOLUME] slider and REVERB setting do not affect the sound received at the AUX IN jacks.

■ Connecting to a Personal Computer

Although the CLP-811/611 can be connected to a personal computer via the MIDI IN/OUT connectors and a MIDI interface, the TO HOST connector and HOST SELECT switch allow direct connection to Apple Macintosh, IBM-PC/AT, or NEC PC-9801/9821 series personal computers for sequencing and other music applications without the need for a separate MIDI interface.

1. Connecting to an Apple Macintosh Series

Connect the TO HOST connector of the Clavinova to the modem or printer port on your Macintosh, depending on which port your MIDI software is using for MIDI data communication, using a standard Macintosh 8-pin system peripheral cable. Set the HOST SELECT switch to the "Mac" position.

You may also have to make other MIDI interface settings on the computer side, depending on the type of software you use (refer to your software owner's manual). In any case the clock speed should be set to 1 MHz.

● "Mac" Cable Connections

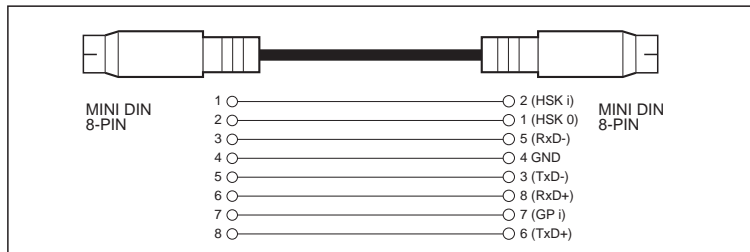

- 8-pin system peripheral cable.
- Data transfer rate: 31,250 bps.

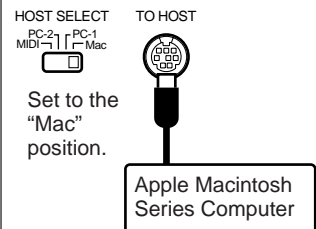

■ Trademarks

- Apple and Macintosh are trademarks of Apple Computer, Inc.
- IBM-PC/AT is a trademark of International Business Machines Corporation.

All other trademarks are the property of their respective holders.

2. Connecting to an IBM-PC/AT Series Computer

Connect the TO HOST connector of the Clavinova to the RS-232C port on your IBM computer, using a standard 8-pin MINI DIN → 9-pin D-SUB cross cable. Set the HOST SELECT switch to the “PC-2” position.

Refer to your software owner’s manual for information on any settings you might have to make on the computer side.

● “PC-2” Cable Connections

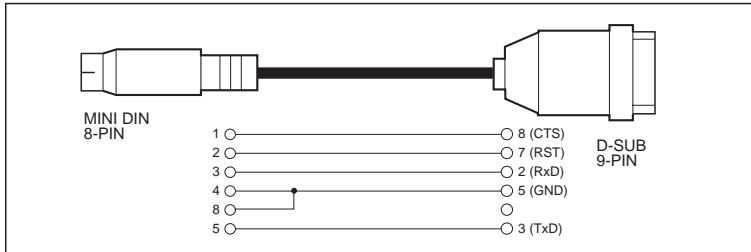

- 8-pin mini DIN → 9-pin D-SUB cable. Use a “PC-1” type cable if your computer uses a 25-pin serial port.
- Data transfer rate: 38,400 bps.

● “PC-1” Cable Connections

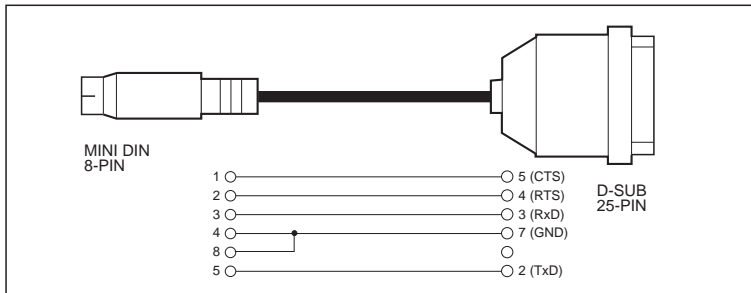

- 8-pin mini DIN → 25-pin D-SUB cable.

NOTE

- When using the [TO HOST] terminal of the CLP-811/611, first turn the power off on both the CLP-811/611 and the computer before connecting the cable. After connecting the cable, turn the power of the computer on first, then the CLP-811/611.
- When not using the [TO HOST] terminal of the CLP-811/611, make sure the cable is disconnected from the [TO HOST] terminal. If the cable is left connected, the CLP-811/611 may not function properly.
- When the HOST SELECT switch is set to “Mac”, “PC-1”, or “PC-2, no data transfer occurs via the MIDI connectors. To use the MIDI connectors for connection via a standard MIDI interface, set the HOST SELECT switch to “MIDI”.
- If your system doesn’t work properly with the connections and settings listed above, your software may require different settings. Check your software operation manual and set the HOST SELECT switch to the position that provides the appropriate data transfer rate.

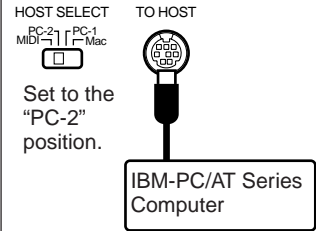

Set to the “PC-2” position.

● Connector Pin Numbers

MINI DIN 8-PIN



D-SUB 25-PIN

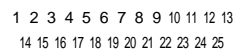

D-SUB 9-PIN

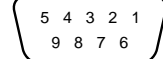

Troubleshooting

If you encounter what appears to be a malfunction, please check the following points before assuming that your Clavinova is faulty.

1. No Sound When the Power is Turned ON

Is the AC plug properly connected to the Clavinova and an AC wall outlet? Check the AC connection carefully. Is the MASTER VOLUME control turned up to a reasonable listening level? Also make sure that a pair of headphones is not plugged into the PHONES jack, and that Local Control (see page 35) is ON.

2. The Damper Pedal Doesn't Work

If the damper pedal doesn't function, or if notes are sustained even when the pedal is not pressed, check that the pedal cord is properly plugged into the main unit (see page 58:CLP-811, see page 64:CLP-611).

3. The Clavinova Reproduces Radio or TV Sound

This can occur if there is a high-power transmitter in your vicinity. Contact your Yamaha dealer.

4. Intermittent Static Noise

This is usually due to turning ON or OFF a household appliance or other electronic equipment which is fed by the same AC line as your Clavinova.

5. Interference Appears On Radio or TV Sets Located Near the Clavinova

The Clavinova contains digital circuitry which can generate radio-frequency noise. The solution is to move the Clavinova further away from the affected equipment, or vice versa.

6. Distorted Sound When the Clavinova is Connected to An External Amplifier/ Speaker System

If the Clavinova is connected to a stereo system or instrument amplifier and the sound is distorted, reduce the setting of the Clavinova volume control to a level at which the distortion ceases.

7. KSN NG error message appears on the screen.

This message indicates that there is an internal problem. Please contact your dealer for assistance.

Options

- **BC-8 Bench**

A comfortable bench styled to match your Yamaha Clavinova.

- **HPE-160 Stereo Headphones**

High-performance lightweight dynamic headphones with extra-soft ear pads.

- **DOU-10 Disk Orchestra Unit**

Offers a range of MIDI recording and playback functions, plus the Yamaha Disk Orchestra Collection, Disklavier PianoSoft™, General MIDI, and Standard MIDI File disk playback capability.

Index

- For a full overview of the contents of this manual: Refer to Contents on page 1.
- To locate information about specific buttons and connectors: Refer to Panel Controls and Connectors on pages 4 and 5.
- To locate information about FUNCTION-mode parameters: See the Function Table on pages 24 to 25.

This index is intended to help you locate information not covered by the sections mentioned above. Note that an asterisk (*) after a page number indicates that the information is in the page's sidebar (to the right of the main text).

C

Computer, connection to 40-41
Configuration functions 24-37
Connectors 38-39

D

Damper pedal 14
 number of levels 14*, 34
DEMO/PIANO SONG mode 8-12
Demo songs 8,9
 listing of 46
Depth
 Damper pedal 33
 EFFECT depth 16
 REVERB depth 15
Display 6
DUAL mode 17-18

F

Factory defaults 7
 listing of 47
 Resetting to 37
FUNCTION mode 7*, 24-37

H

Headphones 3

K

Key cover 2

L

Left pedal, function 14*,33

M

Main functions, list of 24-25
Memory backup 7
 setting ON or OFF 36
Microphone reverb 36
MIDI 34-36
Music stand 2
Muted-part volume adjustment 11*, 34

P

Parts, left- and right-hand 11
 Muting a part 11*, 34
Pedals 14
 changing function of left pedal 14*, 33
Piano songs 8, 10
 one-hand practice 11
 repetition practice 12
Power 3
Power indicator 3

R

Recording (Recorder feature) 20-23
 Changing initial settings 21
 Initial settings 20

S

Setup File	35
Shortcuts to FUNCTION mode	
To [F4.DualFunc.]	29
To [F5.SplitFunc.]	29-30
To [F6.OrganEdit]	30-31
To [F7.Metronome]	32
Soft pedal	14
changing function of	14*, 33
Songs	8-12
listing of	46
Sostenuto pedal	14
SPLIT mode	18-19
Split point	18
Subfunctions, list of	24-25
SYNCHRO Start	
For recorder playback	23
For song playback	11

T

Temperament	28
Scale	28
Tracks, recorder	20-21
erasing a track	22
(See also Parts)	

V

Volume adjustment	3
-------------------------	---

Demo and Piano Songs Lists

Listen der Demo-Songs und der Piano-Songs

Liste des morceaux de démonstration et des morceaux de piano

Listas de canciones de demostración y piano

Demo Songs / Demo-Songs / Morceaux de démonstration / Canciones de demostración

Voice Name	Title	Composer
Piano1	Ballad No. 1 G minor op. 23	F.F. Chopin
Piano2	Lake Louise	Y. Kuramoto
Clavinova Tone	Consolation No. 3	F. Liszt
E.Piano1	<i>original</i> (© 1996 by YAMAHA CORPORATION)	-
E.Piano2	<i>original</i> (© 1996 by YAMAHA CORPORATION)	-
Harpsichord	“Allemande” from French Suite No. 5 BWV816	J.S. Bach
Vibes	Study in A minor op.70	G. Pfeiffer
Strings	Salut D’amour op.12	E. Elgar
Choir	My Old Kentucky Home	S.C. Foster
Pipe Organ	“Prelude No.1 C Major” from Eight Short Preludes and Fugues, BWV553 - 560	J.S. Bach
Organ Combination	<i>original</i> (© 1996 by YAMAHA CORPORATION)	-
Bass (CLP-811)	Greensleeves	Traditional

Some demo pieces are excerpts from or rearrangements of the original work.

Einige Demo-Songs sind Auszüge aus oder Arrangements von Originalwerken.

Certains morceaux de démonstration sont des extraits ou des réarrangements de l’oeuvre originale.

Algunas canciones de demostración son extractos del trabajo original o arreglos del mismo.

Piano Songs / Piano-Songs / Morceaux de piano / Canciones de piano

No.	Title	Composer
1	Für Elise	L.v.Beethoven
2	Dolly’s Dreaming and Awakening	T.Oesten
3	Blumenlied	G.Lange
4	“Marche Turke” from Sonata A major K.331	W.A.Mozart
5	Waltz “Petit Chien” op.64-1	F.F.Chopin
6	Türkischer Marsch	L.v.Beethoven
7	SpinnerLied	A.Ellmenreich
8	Alpenabendröte	T.Oesten
9	Sonatine Anh.6	L. v. Beethoven
10	Melodie op.68-1	R. A. Schumann
11	Heidenröslen	G.Lange
12	La chevaleresque	J.F.F.Burgmüller
13	Minuet G major BWV Anh.114	J.S.Bach
14	Ronde alla Turca	J.F.F.Burgmüller
15	Minuet G minor K.1e	W. A. Mozart

No.	Title	Composer
16	The Harvest Time	G. Lange
17	Impromptu op.90-2	F.P.Schubert
18	Waltz op.64-2	F.F.Chopin
19	Nocturne op.9-2	F.F.Chopin
20	Sonata C major K.545 1st Mov.	W.A.Mozart
21	Iére Arabesque	C.A.Debussy
22	La Prière d’une Vierge	T.Badarzewska
23	Frühlingslied	J.L.F.Mendelssohn
24	La Violette	L.Streabbog
25	Ecosse G major	L. v. Beethoven
26	Arabesque	J.F.F.Burgmüller
27	The Entertainer	S.Joplin
28	Gavotte	G. P. Telemann
29	Little Serenade	J. Haydn
30	Allegro B major K.3	W. A. Mozart

Factory Defaults / Werksvoreinstellungen

Réglages d'usine par défaut / Ajustes de fábrica

The following is a listing of the Clavinova's factory defaults.

Die folgende Liste ist eine Zusammenstellung der werkseitigen Voreinstellungen des Clavinova.

Vous trouverez ci-dessous une liste des réglages par défaut du Clavinova.

La siguiente es una relación de los ajustes de fábrica del Clavinova.

Voice selection	PIANO1
DUAL mode	OFF
SPLIT mode	OFF
SPLIT mode Voice #2	BASS (on CLP-811) STRINGS (on CLP-611)
REVERB type	STAGE
REVERB depth	8
EFFECT type	Varies by voice

EFFECT depth	Varies by effect type and voice
BRILLIANCE	NORMAL
TRANPOSE	0
TOUCH setting	MEDIUM
Fixed-touch velocity	64
Metronome	OFF
Metronome volume	10
TEMPO	120

FUNCTION-mode settings / Einstellungen des FUNCTION-Modus' /

Réglages du mode FONCTION / Ajustes del modo FUNCTION

F1	Tuning	A3=440Hz
F2	Key-by-key tuning	OFF
	Tuning values	All values = 0
F3	Scale (temperament)	EQ (equal)
F4-1	DUAL/Voice volume balance	Varies by voice combination
F4-2	DUAL/Detuning	Varies by voice combination
F4-3,F4-4	DUAL/Octave shift	Varies by voice combination
F4-5,F4-6	DUAL/Effect depth	Varies by voice combination
F4-7	DUAL/STRING attack	FAST
F5-1	SPLIT/Split point	F#2
F5-2	SPLIT/Voice volume balance	Varies by voice combination
F5-3,F5-4	SPLIT/Octave shift	Varies by voice combination
F5-5,F5-6	SPLIT/Effect depth	Varies by voice combination
F5-7	SPLIT/Damper-pedal range	L+R
F6-1	Organ Type	JAZZ ORGAN1
F6-2-5	Organ Edit settings	Varies by organ type
F7-1	Metronome beat	Normal (No beat)

F7-2	Metronome volume	10
F8	Display mode	NORMAL
F9	Left-pedal function	SOFT pedal
F10	Damper-pedal depth	10
F11	Damper-pedal levels	8
F12	Volume of muted part	5
F13-1	MIDI/Transmitting channel	1
F13-2	MIDI/Receiving channel	ALL
F13-3	MIDI/Local control	ON
F13-4	MIDI/Program Change enable	ON
F13-5	MIDI/Control Change enable	ON
F13-6	MIDI/Transposition	0
If CLP-811		
F14	Microphone reverb depth	10
F15	Backup settings	All OFF
If CLP-611		
F14	Backup settings	All OFF

Factory Reset

You can return all settings to their factory defaults by holding down key C7 (the highest key) while switching on the power. Note that this reset covers all settings—dual mode, split mode, reverb, effect, touch, and so on. Note also that the reset will erase the contents of the recorder, and will return all Backup settings to OFF.

Zurücksetzen aller Parameter

Sie können alle Einstellungen zurück auf die Werksvoreinstellungen bringen, indem Sie während des Einschaltens Taste C7 (die höchste Taste) gedrückt halten. Beachten Sie, daß diese Funktion alle Einstellungen betrifft - den Dual-Modus, den Split-Modus, den Hall, die Effekte, die Anschlagsdynamik usw. Bedenken Sie auch, daß der gesamte Inhalt des Rekorders gelöscht wird, und daß alle Einstellungen der Backup-Funktion auf OFF gestellt werden.

Réinitialisation d'usine

Vous pouvez réinitialiser tous les réglages à leurs valeurs par défaut en maintenant enfoncée la touche C7 (Do7 - la touche la plus haute) à la mise sous tension. Cette réinitialisation couvre alors tous les réglages - mode double, mode partagé, réverbération, effet, toucher, etc. Elle effacera également tout le contenu de l'enregistreur et tous les réglages de copie de sauvegarde seront désactivés (remis sur OFF).

Reposición de los ajustes de fábrica

Es posible restablecer todos los ajustes a sus valores originales de fábrica manteniendo pulsada la tecla C7 (la nota más alta) mientras se enciende el instrumento. Adverta que esta operación de reposición afecta a todos los ajustes del modo dual, dividido, reverberación, efectos, pulsación, etc. Tenga también presente que la reposición borrará los contenidos de la grabadora y volverá a desactivar todos los ajustes de memoria de seguridad.

MIDI Data Format

Introduction to MIDI

MIDI (for “Musical Instrument Digital Interface”) is an internationally recognized standard for communication of musical performance and control data among supporting devices. Such devices include electronic musical instruments, computers, and sequencers. MIDI communication is carried out through standard MIDI connectors and cables.

MIDI makes it possible for you to use your Clavinova to control playback at remote devices, and to use remote devices to control playback at your Clavinova.

- MIDI operates on digital data. All data is converted to appropriate digital format prior to transmission.
- Different MIDI devices offer differing levels of MIDI support. The level of available support is given in the device’s “MIDI Implementation Chart.” (The Implementation Chart for your Clavinova appears on page 66.) In general, you will want to avoid transmission of MIDI communications that are not supported at the receiving side.

MIDI Connectors

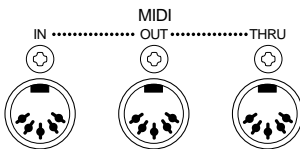

- MIDI IN** Receives incoming MIDI data.
MIDI OUT Transmits outgoing MIDI data.
MIDI THRU Relays all data received at the MIDI IN connector.

MIDI Cable

MIDI connection requires use of dedicated MIDI cables.

- You set up the Clavinova’s MIDI parameters using Function F13 (**MIDIFunc.**). See page 34.
- Information about MIDI can be found in a wide variety of readily available magazines and books.

MIDI-Datenformat

Einführung zu MIDI

MIDI (Akronym für “Musical Instrument Digital Interface”) ist ein international anerkannter Standard für den Austausch musikalischer Spiel- und Steuerdaten zwischen Geräten, die dieses Format unterstützen. Diese Geräte sind unter anderen elektronische Musikinstrumente, Computer, Sequenzer und Effektgeräte. Die MIDI-Kommunikation findet über standardisierte MIDI-Buchsen und -Kabel statt.

MIDI ermöglicht es Ihnen, mit Ihrem Clavinova die Wiedergabe und den Klang anderer Geräte zu steuern, und umgekehrt von anderen Geräten aus die Wiedergabe und den Klang Ihres Clavinova zu beeinflussen.

- MIDI funktioniert mittels digitaler Daten. Alle Daten werden vor der Übertragung in das entsprechende, digitale Format konvertiert.
- Die verschiedenen MIDI-Geräte bieten verschiedene Ebenen der MIDI-Kommunikation. Die kommunizierbaren Parameter werden in der sog. “MIDI-Implementations-tabelle” jedes Gerätes angegeben (Die Implementations-tabelle des Clavinova befindet sich auf Seite 66.) Im allgemeinen ist es sinnvoll, die Übertragung von MIDI-Daten zu vermeiden, die empfangsseitig nicht verarbeitet werden.

MIDI-Buchsen

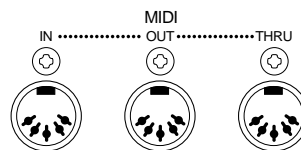

- MIDI IN** Empfängt ankommende MIDI-Daten.
MIDI OUT Sendet abgehende MIDI-Daten.
MIDI THRU Leitet alle am MIDI IN empfangenen Daten unverändert weiter.

MIDI-Kabel

MIDI-Verbindungen erfordern spezielle MIDI-Kabel.

- Die MIDI-Parameter des Clavinova stellen Sie mit Funktion F13 (**MIDIFunc.**) ein. Siehe Seite 34.
- Informationen über MIDI sind in vielen Musikmagazinen und Büchern verfügbar.

Format de données MIDI

Introduction au système MIDI

Le système MIDI, de l'anglais "Musical Instrument Digital Interface" (interface pour instruments de musique numériques) est une interface de communication utilisée de par le monde qui permet le partage de données musicales entre divers instruments ou équipements musicaux MIDI et la commande mutuelle de ces équipements. Les instruments impliqués sont notamment les instruments de musique électroniques, des ordinateurs et des séquenceurs. Les communications MIDI s'effectuent par le biais de connecteurs et de câbles MIDI standards.

Le système MIDI permet d'utiliser le Clavinova pour contrôler la reproduction sur des appareils éloignés ou d'utiliser des appareils distants pour contrôler la reproduction sur le Clavinova.

- Le système MIDI concerne les données numériques. Toutes les données sont converties dans le format approprié avant la transmission.
- Différents appareils MIDI peuvent offrir un niveau différent de compatibilité MIDI. Le niveau de compatibilité disponible est repris dans le "tableau d'implémentation MIDI" de l'appareil. (Le tableau d'implémentation MIDI du Clavinova se trouve à la page 66). En règle générale, il convient d'éviter la transmission de communications MIDI qui ne sont pas supportées du côté récepteur.

Connecteurs MIDI

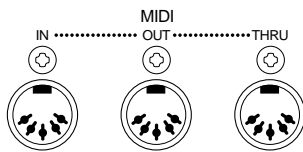

- MIDI IN** Reçoit les données MIDI entrantes.
MIDI OUT Transmet les données MIDI sortantes.
MIDI THRU Sert de relais pour toutes les données reçues à la borne MIDI IN.

Câble MIDI

La connexion MIDI demande l'utilisation de câbles MIDI appropriés.

- Vous pouvez configurer les paramètres MIDI du Clavinova à l'aide de la fonction F13 (**MIDIFunc.**). Voir page 34.
- Vous trouverez de plus amples informations concernant le système MIDI dans toute une série d'ouvrages et de magazines de lecture aisée.

Formato de datos MIDI

Introducción a MIDI

El sistema MIDI ("Musical Instrument Digital Interface" = intercomunicación digital entre instrumentos musicales) es una norma internacionalmente aceptada para el intercambio de datos de control y de interpretaciones musicales entre dispositivos de soporte. Entre tales dispositivos se encuentran los instrumentos musicales electrónicos, los ordenadores y los secuenciadores. La comunicación MIDI se realiza a través de conectores y cables MIDI normalizados.

El sistema MIDI le permite utilizar el Clavinova para controlar la reproducción en dispositivos remotos, así como utilizar los dispositivos remotos para controlar la reproducción del Clavinova.

- MIDI opera con datos digitales. Todos los datos son convertidos al formato digital adecuado antes de la transmisión.
- Los dispositivos MIDI diferentes ofrecen niveles distintos de soporte MIDI. El nivel de soporte disponible se facilita en la "Tabla de Implementación MIDI" del equipo (la del Clavinova se ofrece en la página 66). Por lo general, intentará evitar la transmisión de comunicaciones MIDI que no sean soportadas por el equipo receptor.

Conectores MIDI

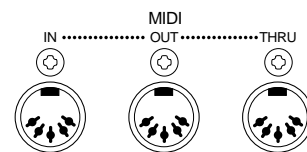

- MIDI IN** Recibe los datos MIDI entrantes.
MIDI OUT Transmite los datos MIDI salientes.
MIDI THRU Reenvía todos los datos recibidos a la entrada MIDI IN.

Cable MIDI

Las conexiones MIDI requieren el uso de cables MIDI específicos.

- Los parámetros MIDI del Clavinova se configuran con la función F13 (**MIDIFunc.**). Véase página 34.
- Existe información sobre MIDI en una amplia variedad de revistas y libros de difusión pública.

1. NOTE ON/OFF

[9nH] → [kkH] → [vvH]

9nH = Note ON/OFF event (n = Channel No.)

kkH = Note No.

(Sending: 09H~78H = A-2~C8)

(Receiving: 00H~7FH = C-2~G8) *1

vvH = velocity

(Note ON = 01H~7FH. Note OFF = 00H.)

[8nH] → [kkH] → [vvH]

8nH = Note OFF (n = Channel No.)

kkH = Note No. (00H~7FH = C-2~G8)

vvH = velocity

*1: If received value exceeds the supported range for the selected voice, the note is adjusted by the necessary number of octaves.

2. Control Change

[BnH] → [ccH] → [vvH]

BnH = Control Change (n = Channel No.)

ccH = Control No.

vvH = Control value

1) Bank Select

ccH	Parameter	Value (vvH)
00H	Bank select MSB 01H: Normal	00H~7FH: Incorrect sounding
20H	Bank select LSB 00H~7FH	
70H	Brilliance: Normal Variation:	OFF
71H	Normal	ON
72H	Bright	OFF
73H	Bright	ON
74H	Mellow	OFF
75H	Mellow	ON

* Bank selection processing does not occur until receipt of next Program Change message.

* Bank Select messages are not effective on the Organ Combination voice.

2) Main Volume (Receive only)

ccH	Parameter	Value (vvH)
07H	Volume	00H~7FH

3) Expression

ccH	Parameter	Value (vvH)
0BH	Expression	00H~7FH

4) Damper Pedal

ccH	Parameter	Value (vvH)
40H	Damper	00H~7FH

5) Sostenuto Pedal

ccH	Parameter	Value (vvH)
42H	Sostenuto	00H-3FH:OFF 40H-7FH:ON

6) Soft Pedal

ccH	Parameter	Value (vvH)
43H	Soft pedal	00H-3FH:OFF 40H-7FH:ON

7) Attack Time

ccH	Parameter	Value (vvH)
49H	Attack time	00H~7FH

8) Effect-1 Depth (Reverb Send Level)

ccH	Parameter	Value (vvH)
5BH	Effect-1 depth	00H~7FH

* Adjusts the send level for the reverb effect.

9) Effect-4 Depth (Variation-Effect Send Level)

ccH	Parameter	Value (vvH)
5EH	Effect-4 depth	00H~7FH

3. Mode Messages

[BnH] → [ccH] → [vvH]

BnH = Control Event (n = Channel No.)

ccH = Mode Message No.

vvH = Mode Message value

1) All Sound Off

ccH	Controller	Value (vvH)
78H	All Sound Off	00H

* Turns off all sound on the specified channel. Does not reset Note On and Hold On conditions established by Channel Messages.

2) Reset All Controllers

ccH	Controller	Value (vvH)
79H	Reset All Controllers	00H

* Resets controllers as follows.

Controller	Reset Value
Expression	127 (Max.)
Damper Pedal	0 (OFF)
Sostenuto	0 (OFF)
Soft Pedal	0 (OFF)

3) All Notes Off

ccH	Controller	Value (vvH)
7BH	All Notes Off	00H

* Switches OFF all the notes that are currently ON on the specified channel. Any notes being held by the damper or sostenuto pedal will continue to sound until the pedal is released.

4) Omni Off (Receive only)

ccH	Controller	Value (vvH)
7CH	Omni Off	00H

* Same processing as All Notes Off.

5) Omni On (Receive only)

ccH	Controller	Value (vvH)
7DH	Omni On	00H

* Same processing as All Notes Off.

6) Mono (Receive only)

ccH	Controller	Value (vvH)
7EH	Mono	00H

* Same processing as All Sound Off.

7) Poly (Receive only)

ccH	Controller	Value (vvH)
7FH	Poly	00H

* Same processing as All Sound Off.

● Remarks

- The Clavinova will not send or accept Control Change messages if the FUNCTION-mode Control Change setting is OFF.
- The Clavinova does not transmit Local ON/OFF and Omni ON/OFF messages. (All Notes Off is transmitted as a series of Note Off messages.)
- The Clavinova saves the bank select value (MSB and LSB; receivable in any order) to its internal buffer. This value is then used to determine the voice selection upon receipt of the next Program Change message.
- The Clavinova always operates in multitimbral polyphonic mode. The mode does not change in response to Omni ON/OFF, Mono, and Poly messages.

4. Program Change

[CnH] → [ppH]

CnH = Program Change (n = Channel No.)

ppH = Program Change No.

* The Clavinova will not send or accept Program Change messages if the FUNCTION-mode Program Change setting is OFF.

* Program number assignments are as follows.

Voice	Program Change No.
PIANO 1	00H
PIANO 2	01H
CLAVI. TONE	58H
E. PIANO 1	05H
E. PIANO 2	04H
HARPSICHORD	06H
VIBES	0BH
STRINGS	30H

CHOIR	34H
PIPE ORGAN	13H
ORGAN COMBINATION	10H
BASS (CLP-811)	20H

5. System Realtime Messages

1) Active Sensing

[FEH]

* Transmitted every 200 msec.

* If the Clavinova receives no MIDI signals for 400 msec. following receipt of an FEH, it will execute processing equivalent to All Sound Off → All Notes Off → Reset All Controllers.

2) Clock

[F8H]

* Clock signal is issued 96 times per whole note.
* If Exclusive Message specifies use of an external clock, the Clavinova counts 96 clock signals as one whole note.

3) Start

[FAH]

* Transmitted at rhythm start.
* Receipt causes song to start.

4) Stop

[FCH]

* Transmitted at rhythm stop.
* Receipt causes song to stop.

* If error occurs during MIDI reception, the Clavinova switches off damper, sostenuto, and soft effects and then executes All Notes Off processing (for all channels).

6. System Exclusive Message (Yamaha MIDI Format)

[F0H] → [43H] → [0nH] → [7CH] → ... → [F7H]

F0H,43H,0nH,7CH: n = Channel No.

01H,36H: Data length

43H,4CH,20H,20H: CL

43H,4CH,50H,27H,39H,36H: CLP'96

30H,30H: (Version x,y)

[Panel Data]

[Checksum (1 byte)]=0-(43H+4CH+20H+..... data end)

F7H: End of Exclusive

[Panel-data content]

- Voice
- DUAL ON/OFF
- DUAL voice
- DUAL balance
- DUAL detuning
- DUAL Voice#1 octave shift
- DUAL Voice#2 octave shift
- DUAL Voice#1 effect depth
- DUAL Voice#2 effect depth
- DUAL/STRINGS slow attack ON/OFF
- SPLIT ON/OFF
- SPLIT voice
- SPLIT point
- SPLIT balance
- SPLIT Voice#1 octave shift
- SPLIT Voice#2 octave shift
- SPLIT Voice#1 effect depth
- SPLIT Voice#2 effect depth
- SPLIT damper mode
- Reverb type
- Reverb depth
- Effect type 1
- Effect type 2
- Effect depth
- Brilliance
- Variation #1 ON/OFF
- Variation #2 ON/OFF
- Touch sensitivity
- FIXED-touch velocity
- Left pedal function (Soft/Start)
- Key-specific tuning ON/OFF
- Tempo (absolute value; LSB)
- Tempo (absolute value; MSB)
- Organ Combination voice No.
- (35)~(51) Organ Combination data 1

- (52)~(68) Organ Combination data 2
- (69)~(85) Organ Combination data 3
- (86)~(102) Organ Combination data 4
- (103)~(119) Organ Combination data 5
- (120)~(136) Organ Combination data 6
- (137)~(153) Organ Combination data 7
- (154)~(170) Organ Combination data 8

* The Clavinova does not accept requests to transfer panel data.

7. System Exclusive Messages (Universal System Exclusives)

1) Universal Realtime Message

[F0H] → [7FH] → [XnH] → [04H] → [01H] → [!!H] → [mmH] → [F7H]

MIDI Master Volume

- * This message changes the volume for all channels at the same time.
- * Receipt of this message affects the volume on the MIDI receiving channel(s) only. Panel volume does not change.

F0H: Exclusive status
 7FH: Universal realtime
 7FH: ID of target device
 04H: Sub-ID #1 (Device control message)
 01H: Sub-ID #2 (Master Volume)
 !!H: Volume LSB
 mmH: Volume MSB
 F7H: End of Exclusive

-or-

F0H: Exclusive status
 7FH: Universal realtime
 XnH: X is ignored; n=0~F
 04H: Sub-ID #1 (Device control message)
 01H: Sub-ID #2 (Master Volume)
 !!H: Volume LSB
 mmH: Volume MSB
 F7H: End of Exclusive

2) Universal Non-Realtime Message (GM ON)

[F0H] → [7EH] → [XnH] → [09H] → [01H] → [F7H]

GM (General MIDI) Mode ON

F0H: Exclusive status
 7EH: Universal non-realtime
 7FH: ID of target device
 09H: Sub-ID #1 (General MIDI message)
 01H: Sub-ID #2 (General MIDI ON)
 F7H: End of Exclusive

-or-

F0H: Exclusive status
 7EH: Universal non-realtime
 XnH: X is ignored; n=0~F
 09H: Sub-ID #1 (General MIDI message)
 01H: Sub-ID #2 (General MIDI ON)
 F7H: End of Exclusive

- * Receipt of the GM ON message causes MIDI parameters to reinitialize. Allow sufficient time for processing to execute (about 50 msec) before sending the Clavinova another message.

8. System Exclusive Messages (XG Standard)

1) XG Native Parameter Change

[F0H] → [43H] → [1nH] → [4CH] → [hhH] → [mmH] → [!!H] → [ddH] ... → [F7H]

F0H: Exclusive status
 43H: Yamaha
 1nH: Device No.
 (If transmission, n=0. If reception, n=0~F.)
 4CH: XG model ID
 hhH: Address High
 mmH: Address Mid
 !!H: Address Low

ddH: Data
 :
 :
 F7H: End Of Exclusive

2) Bulk Dump (Receive only)

[F0H] → [43H] → [0nH] → [4CH] → [aaH] → [bbH] → [hhH] → [mmH] → [!!H] → [ddH] → ... → [ccH] → [F7H]

F0H: Exclusive status
 43H: Yamaha
 0nH: Device No. (n=0~F.)
 4CH: XG model ID
 aaH: Byte count
 bbH: Byte count
 hhH: Address High
 mmH: Address Mid
 !!H: Address Low
 ddH: Data
 :
 :
 ccH: Checksum
 F7H: End Of Exclusive

- * Receipt of this message causes reinitialization of relevant parameters and Control Change values. Allow sufficient time for processing to execute (about 50 msec) before sending the Clavinova another message.
- * XG Native Parameter Change message may contain two or four bytes of parameter data (depending on the parameter size).
- * For information about the Address and Byte Count values, refer to Table 1 below. Note that the table's Total Size value gives the size of a bulk block. Only the top address of the block (00H, 00H, 00H) is valid as a bulk data address.
- * Transmission of excessive bulk-data length may cause error at the receiving side. Keep message length within 512 bytes. If you need to send more than 512 bytes, break the transmission into multiple parts and allow at least 120 msec between each transmission.

<Table 1>
MIDI Parameter Change (SYSTEM)

Address (H)	Size (H)	Data (H)	Parameter	Description	Default (H)	
00 00 00	4	020C~05F4	MASTER TUNING	-50~+50 [cents]	00 04 00 00	* Value below 020CH selects -50 cents. Value above 05F4H selects +50 cent.
01				1st byte bits (3~0) → Bits 15~12	400	
02				2nd byte bits (3~0) → Bits 11~8		
03				3rd byte bits (3~0) → Bits 7~4		
				4th byte bits (3~0) → Bits 3~0		
04	1	00~7F	MASTER VOLUME	0~127	7F	
05	1					
06	1	34~4C	TRANSPOSE	-12~+12 [semitones]	40	* Values 28H to 33H select -12 to -1, respectively.
7E		0	XG SYSTEM ON	00=XG System ON		Values 4DH to 58H select +1 to +12, respectively.
7F		0	RESET ALL PARAMETERS	00= ON (Receive only)		
Total Size	7					

<Table 2>
MIDI Parameter Change (EFFECT 1)

* For a listing of REVERB, CHORUS, and VARIATION type numbers, refer to the Effect MIDI maps.

Address (H)	Size (H)	Data (H)	Parameter	Description	Default (H)
02 01 00	2	00~7F	REVERB TYPE MSB	Refer to the Effect MIDI Map.	01 (=HALL 1)
		00~7F	REVERB TYPE LSB	00: Basic Type	00
0C	1	00~7F	REVERB RETURN	~∞dB...0dB...+6dB (0...64...127)	40
02 01 40	2	00~7F	VARIATION TYPE MSB	Refer to the Effect MIDI Map.	00 (No effect)
		00~07F	VARIATION TYPE LSB	00: Basic Type	00

Note: "VARIATION TYPE" corresponds to the Clavinova's panel-set effect type.

<Table 3>
MIDI Parameter Change (Multipart)

Address (H)	Size (H)	Data (H)	Parameter	Description	Default (H)
08 nn 11	1	00~7F	DRY LEVEL	0~127	7F
nn= Part number					

<Table 4>

Effect MIDI Map (REVERB)

Table with 4 columns: MSB, LSB, 00H-03H, and arrows indicating effect status for REVERB.

<Table 5>

Effect MIDI Map (VARIATION)

Table with 4 columns: MSB, LSB, 00H-06H, and arrows indicating effect status for VARIATION.

9. System Exclusive Messages (Clavinova MIDI compliance)

[F0H] -> [43H] -> [73H] -> [xxH] -> [nnH] -> [F7H]

- F0H: Exclusive status
43H: Yamaha
73H: Clavinova
xxH: Device ID (CLP*96:3BH; CLP common:01H)
nnH: Substatus
Control nn
Internal clock 02H
External clock 03H
Bulk data: 06H (followed by bulk data)
F7H: End Of Exclusive

* Substatuses 02H and 03H can be received by Device ID 01H as well as by 3BH.

1) Bulk Dump Format for Key-by-Key Tuning Data

- F0H,43H,73H
3BH: Device ID (CLP*96:3BH)
06H: Bulk ID
00H: Bulk No.
(00H,00H,0BH,00H: Data length
[Bulk data]: low(A-1), high (A-1) ... low (C7), high (C7)
[Checksum (1 byte)] = 0 - sum(bulk data)
F7H: End Of Exclusive

2) Bulk Dump Format for Sequence Data

- F0H,43H,73H
nnH: Device ID (CLP-811:40H; CLP-611:3EH)
06H: Bulk ID
05H: Bulk No.
(Sequence-data bulk dump format)
0xH,0xH,0xH,0xH: Data length = xxxx bytes
[Bulk data]: low,high,....,low,high
[Checksum (1 byte)] = 0 - sum(bulk data)
F7H: End Of Exclusive

3) Bulk Data Format for Organ Combination

- F0H,43H,73H
3BH: Device ID
06H: Bulk ID
06H: Bulk data format for organ combination
Data length = 11H bytes
n = Channel No.
00H,00H,01H,01H:
0nH:
[16]
[8]
[5+1/3']
[4]
[2+2/3']
[2]
[1+1/3']
[1]
[Response]
[Attack 4']
[Attack 2+2/3']
[Attack 2']
[Attack length]
[Attack mode] (00H=FIRST; 01H=EACH)
[Rotary-speaker speed]
[Rotary-speaker depth]
[Checksum (1 byte)] = 0 - sum(bulk data)
F7H: End Of Exclusive

10. System Exclusive Message (Special operators)

- [F0H] -> [43H] -> [73H] -> [xxH] -> [!!H] -> [0nH] -> [ccH] -> [vvH] -> [F7H]
F0H: Exclusive status
43H: Yamaha
73H: Clavinova
3BH: Device ID (CLP*96n:3BH)
!!H: SK special operator

- 0nH: Control MIDI Change (n = Special Operator Channel No.)
cc: Control No.
dd: Value
F7H: End Of Exclusive

Table with columns: Control, ON, ccH, ddH, and descriptions for SPLIT POINT, METRONOME, DAMPER LEVEL, CHANNEL DETUNING, and VOICE RESERVE.

*1 When RESERVE=ON, received volume and expression data becomes effective at next Key ON. RESERVE=OFF is the normal setting.

11. Additional System Exclusive Message

[F0H] -> [43H] -> [1nH] -> [27H] -> [30H] -> [00H] -> [00H] -> [!!H] -> [ccH] -> [F7H]

* This message changes master tuning for all channels. (If this and XG master-tuning message are both received then last received becomes effective.)

1) Master tuning

- [00H] -> [mmH] -> [!!H] -> [ccH]
F0H: Exclusive status
43H: Yamaha
1nH: (If transmission, n=0. If reception, n=0~F.)
27H: TG100 Device ID
30H: Sub-ID
00H:
00H:
mmH: Master Tuning MSB
!!H: Master Tuning LSB
ccH: Any value up to 7FH.
F7H: End Of Exclusive

Specifications / Technische Daten

Spécifications techniques / Especificaciones

		CLP-811	CLP-611
Keyboard		88 keys (A-1 to C7)	
Tone Generator		AWM (Advanced Wave Memory)	
Polyphony		64 notes max.	32 notes max.
Voices		PIANO 1, PIANO 2 CLAVINOVA TONE, ELECTRIC PIANO 1, ELECTRIC PIANO 2, HARPSICHORD, VIBES, STRINGS, CHOIR, PIPE ORGAN, ORGAN COMBINATION, BASS (CLP-811 only), and voice variations.	
Reverb		ROOM, HALL 1, HALL 2, STAGE	
Effects		CHORUS, SYMPHONIC, TREMOLO, ECHO	
Brilliance		MELLOW, NORMAL, BRIGHT	
Controls		DUAL, SPLIT, METRONOME, TRANSPOSE, TOUCH (HARD, MEDIUM, SOFT, FIXED), MICROPHONE VOLUME (CLP-811 only), MICROPHONE REVERB (CLP-811 only), various functions.	
Display		Large liquid-crystal display	
Recorder		2-TRACK RECORDING/PLAYBACK; adjustable TEMPO	
Pedals		DAMPER, SOSTENUTO, SOFT	
Demos		12 demo songs and 30 piano songs	11 demo songs and 30 piano songs
Connectors		AUX OUT R & L/L+R (output impedance 600Ω); AUX IN R & L/L+R (input impedance 10kΩ, input sensitivity -10dBm); MIC jack (CLP-811 only); two PHONES jacks; TO HOST; MIDI IN/OUT/THRU	
Main Amplifiers		120W (60W × 2)	
Speakers		14cm × 2, 5cm × 2, elliptical (5 × 9cm) × 2	14cm × 2, 5cm × 2
Dimensions (W × D × H)	Music stand down	1436mm × 513mm × 906mm (56-9/16 × 20-3/16 × 35-11/16)	1418mm × 511mm × 879mm (55-13/16 × 20-1/8 × 34-5/8)
	Music stand up	1436mm × 513mm × 1014mm (56-9/16 × 20-3/16 × 39-15/16)	1418mm × 511mm × 1051mm (55-13/16 × 20-1/8 × 41-3/8)
Weight		67.0kg (147 lbs 9 oz)	60.0kg (132 lbs 3 oz)

Specifications and appearance are subject to change without notice for purpose of product improvement.

Die Technischen Daten und das Äußere können sich mit dem Ziel der Weiterentwicklung des Produktes jederzeit ohne Ankündigung ändern.

Les spécifications techniques et l'aspect du Clavinova peuvent être sujets à modifications sans avis préalable, dans un but d'amélioration continue du produit.

Las especificaciones técnicas y las características físicas están sujetas a modificaciones para fines de mejora de producto sin previo aviso.

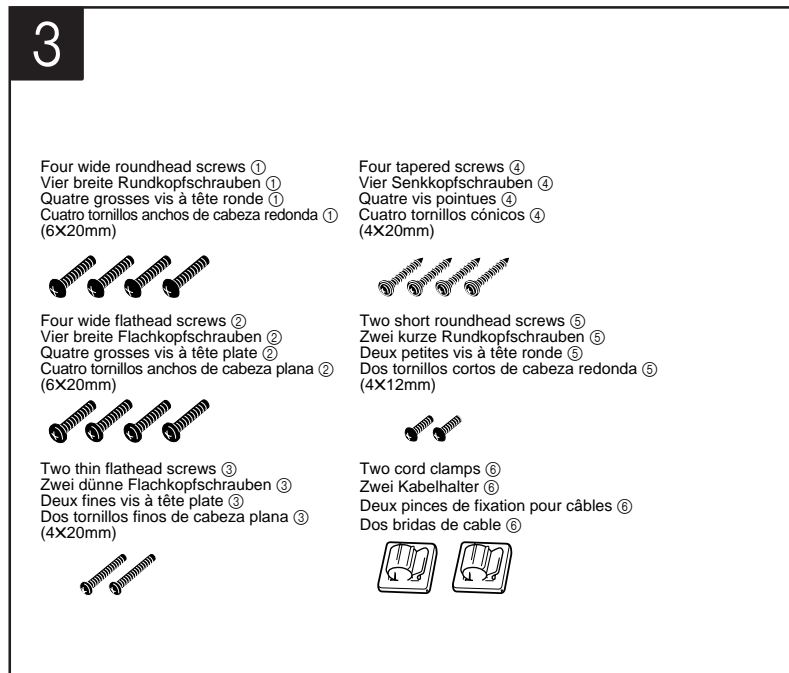
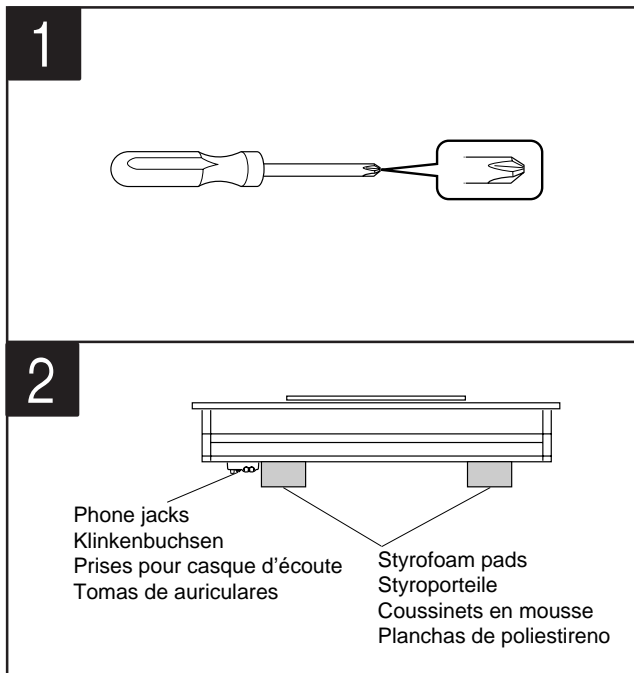

CLP-811 Assembly Procedure

NOTE

- Be careful not to confuse parts, and be sure to install all parts in the correct direction. Please assemble in accordance with the sequence given below.
- Assembly should be carried out by at least two persons.
- Be sure to use the correct screw size, as indicated above. Use of incorrect screws can cause damage.
- Be sure to tighten up all screws upon completing assembly of each unit.
- To disassemble, reverse the assembly sequence given below.

1 Have a Phillips-head screwdriver ready.

2 Open the box. Take out the two styrofoam pads and place them on the floor. Then take out main unit (A) and place it on top of the pads.

NOTE

Position the pads so as to protect the phone jacks on the base of the unit.

3 Remove all parts from the box. Confirm that all of the parts indicated above are present.

4 Fasten lower board (E) to the left and right sideboards.

First, unravel the pedal cord bundled to the bottom of lower board (E). Then align the ends of lower board (E) with the right sideboard (C) and left sideboard (B). Finally, fasten in place with the four wide roundhead screws ①.

Montage des CLP-811

HINWEIS

- Achten Sie darauf, die Teile nicht zu verwechseln, und installieren Sie alle Teile in der richtigen Ausrichtung. Gehen Sie beim Zusammenbau bitte in der angegebenen Reihenfolge vor.
- Die Montage sollte von mindestens zwei Personen vorgenommen werden.
- Achten Sie darauf, die richtige Schraubengröße zu verwenden, wie es oben gezeigt ist. Die Verwendung der falschen Schrauben kann zu Schäden führen.
- Achten Sie während der Montage darauf, bei jedem Arbeitsgang alle Schrauben festzuziehen.
- Für die Demontage muß die angegebene Reihenfolge umgekehrt befolgt werden.

1 Halten Sie einen Kreuzschlitzschraubendreher bereit.

2 Öffnen Sie den Karton. Nehmen Sie die beiden Styroporteile heraus und legen Sie sie auf den Boden. Nehmen Sie dann die Haupteinheit (A) heraus, und legen Sie es auf die Styroporteile.

HINWEIS

Positionieren Sie die Styroporteile so, daß die Klinkenbuchsen am Boden des Gerätes geschützt sind.

3 Nehmen Sie alle Teile aus dem Karton. Sehen Sie nach, ob alle oben gezeigten Teile vorhanden sind.

4 Bringen Sie die Unterseite (E) an den linken und rechten Seitenteilen an.

Lösen Sie dazu zunächst das Pedalkabel auf, das unten an der Unterseite zusammengebündelt ist (E). Richten Sie dann die Enden der Unterseite (E) mit dem rechten Seitenteil (C) und dem linken Seitenteil (B) aus. Schrauben Sie die Unterseite schließlich mit den vier breiten Rundkopfschrauben ① fest.

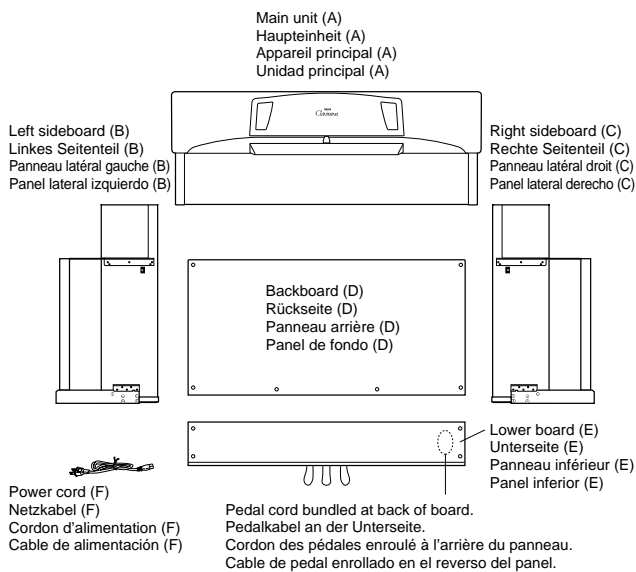

4

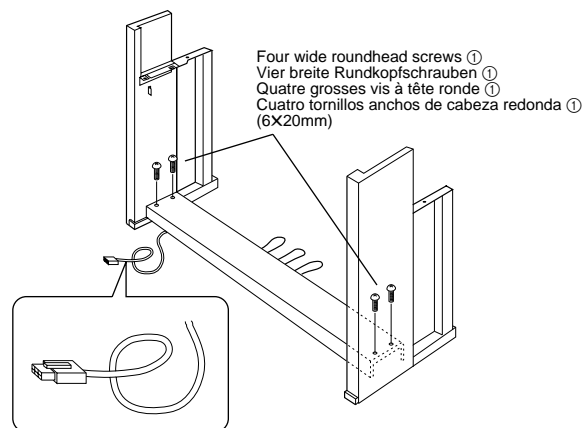

CLP-811 Montage Procédure

REMARQUE

- Veiller à ne pas mélanger les pièces et à les installer dans le sens correct. Veuillez assembler l'instrument dans l'ordre indiqué ci-dessous.
- La présence de deux personnes minimum est nécessaire pour procéder au montage.
- Toujours utiliser des vis aux dimensions correctes, comme indiqué ci-dessus. L'utilisation de vis aux dimensions incorrectes pourrait en effet endommager l'instrument.
- Resserrer convenablement toutes les vis après le montage de chaque élément.
- Pour démonter le Clavinova, inverser l'ordre des indications données ci-dessous.

- 1 Préparer un tournevis Phillips (en croix).
- 2 Ouvrir le carton d'emballage. Sortir les deux coussinets en mousse et les placer sur le sol. Sortir ensuite l'appareil principal (A) et le placer sur les coussinets.

REMARQUE

Placer les coussinets de sorte à protéger les connecteurs pour casques d'écoute, sur la face arrière.

- 3 Retirer toutes les pièces du carton. Vérifier que toutes les pièces indiquées ci-dessus sont présentes.
- 4 Attacher la partie inférieure (E) aux parties latérales gauche et droite du coffret.
Défaire en premier lieu le cordon de la pédale fixé à la partie inférieure (E). Aligner ensuite les extrémités de la partie inférieure (E) sur les extrémités de la partie latérale droite (C) et de la partie latérale gauche (B). Finalement, visser en place à l'aide des quatre vis à tête ronde ①.

Montaje del modelo CLP-811

NOTA

- Observe cuidado para no confundir las piezas, y asegúrese de montar todas ellas en el sentido correcto. Proceda al montaje en el orden indicado a continuación.
- El montaje deberá realizarse al menos por dos personas.
- Procure utilizar los tornillos del tamaño adecuado, según se indica arriba. El empleo de tornillos inadecuados puede ocasionar daños en el instrumento.
- Asegúrese de apretar bien todos los tornillos después de montar cada unidad.
- Para desmontar las unidades, invierta la secuencia de montaje facilitada a continuación.

- 1 Prepare un destornillador de estrella.
- 2 Abra la caja. Retire las dos planchas de poliestireno y colóquelas sobre el suelo. A continuación extraiga la unidad principal (A) y colóquela sobre las planchas.

NOTA

Sitúe las planchas de forma que queden protegidas las tomas de auriculares de la base de la unidad.

- 3 Extraiga todas las piezas de la caja. Compruebe que no falta ninguna de las piezas arriba indicadas.
- 4 Asegure el panel inferior (E) a los laterales derecho e izquierdo.
En primer lugar, desenrolle el cable del pedal fijado en la base del panel inferior (E). Seguidamente, alinee los bordes del panel inferior (E) con los paneles laterales derecho (C) e izquierdo (B). Por último, ensámblelo en su sitio con los cuatro tornillos anchos de cabeza redonda ①.

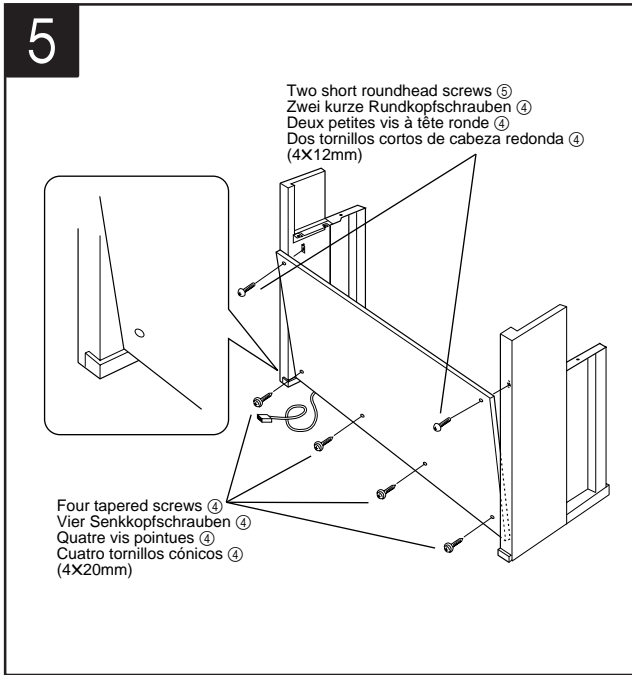

5 Install backboard (D).

Rest the bottom of backboard (D) on the leg ledges (on both sideboards), and pivot the top of the board into place. Fasten the upper part of the backboard to the two sideboards using the short roundhead screws ⑤. Fasten the lower part of the backboard in four places using the tapered screws ④.

6 Install main unit (A).

Lift the main unit, holding it on the bottom as shown in the diagram. Be sure to grasp the board at least 4 inches (10 cm) away from the sides. Slide the unit onto the sideboards from the front, and continue sliding until it is all the way back.

NOTE

Be careful to avoid snagging your hands or clothes when installing the main unit.

7 Fasten main unit (A) into place.

First check from the sides to confirm that there is no gap. Then move to the back and check the gaps between the main unit and the right and left sideboards. Adjust so that these gaps are equivalent, and fasten in place (at both ends of the rear side) with two of the wide flathead screws ②. Next, move to the front and screw in the two thin flathead screws ③, and then the remaining two flathead screws ②.

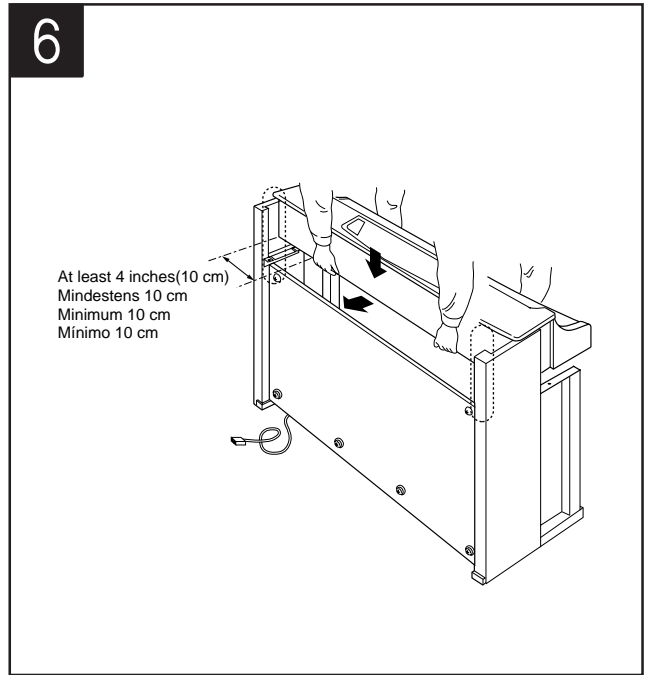

5 Bringen Sie die Rückseite (D) an.

Setzen Sie die Unterkante der Rückseite (D) auf die Fußvorsprünge (auf beiden Seitenteilen), und kippen Sie die Oberkante der Rückseite an die Haupteinheit. Befestigen Sie die Oberkante der Rückseite mit den kurzen Rundkopfschrauben ⑤ an den beiden Seitenteilen. Befestigen Sie den unteren Teil der Rückseite an vier Stellen mit den vier Senkkopfschrauben ④.

6 Montieren Sie die Haupteinheit (A).

Heben Sie die Haupteinheit an, indem Sie darunter greifen, wie in der Abbildung gezeigt. Achten Sie darauf, das Teil mindestens 10 cm von den Seiten entfernt zu greifen. Schieben Sie die Einheit von vorne auf die Seitenteile, bis sie ganz hinten anschlägt.

HINWEIS

Achten Sie darauf, daß Sie während der Installation der Haupteinheit nicht Ihre Hände oder Ihre Kleidung verletzen.

7 Befestigen Sie die Haupteinheit (A).

Überprüfen Sie von der Seite, daß keine Lücke zu sehen ist. Überprüfen Sie dann von hinten aus den Spalt zwischen der Haupteinheit und den linken und rechten Seitenteilen. Richten Sie die Haupteinheit so aus, daß beide Abstände gleich sind, und schrauben Sie die Haupteinheit an den beiden Enden der Rückseite mit zwei breiten Flachkopfschrauben ② fest. Schrauben Sie dann an der Vorderseite die beiden dünnen Flachkopfschrauben ③ und die beiden übrigen Flachkopfschrauben ② fest.

7

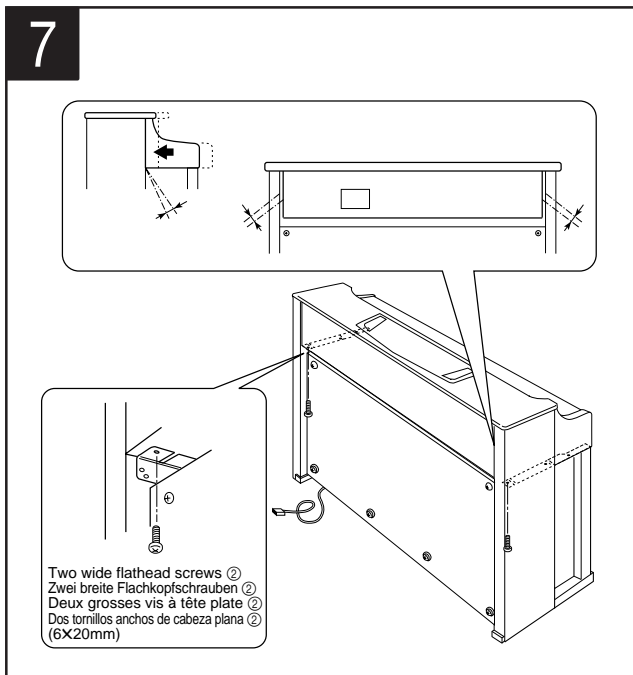

5 Installer le panneau arrière (D)

Reposer le bas du panneau arrière (D) sur le rebord des pieds (des deux panneaux latéraux) et faire pivoter le dessus du panneau pour le mettre en place. Fixer la partie supérieure du panneau arrière aux deux panneaux latéraux à l'aide des petites vis à tête ronde ⑤. Attacher la partie inférieure du panneau arrière à quatre endroits à l'aide des vis pointues ④.

6 Installer la partie principale (A)

Soulever la partie principale, en la soutenant par le fond comme illustré sur le diagramme. Toujours veiller à saisir le panneau à au moins 10 cm des extrémités. Glisser la partie principale sur les panneaux latéraux en commençant par l'avant et la faire glisser jusqu'à ce qu'elle soit insérée à fond.

REMARQUE

Faire attention de ne pas coincer ses mains ou ses vêtements lors de l'installation de la partie principale.

7 Fixer la partie principale (A).

Vérifier tout d'abord de côté pour s'assurer qu'il n'y a pas de vide. Se mettre ensuite derrière et vérifier les espaces entre la partie principale et les panneaux latéraux gauche et droit. Régler l'ensemble de sorte que les espaces soient équivalents de chaque côté et les fixer en place (aux deux extrémités de la partie arrière) avec deux des grosses vis à tête plate ②. Se déplacer ensuite vers l'avant et visser les deux petites vis à tête plate ③ puis les deux grosses vis à tête plate restantes ②.

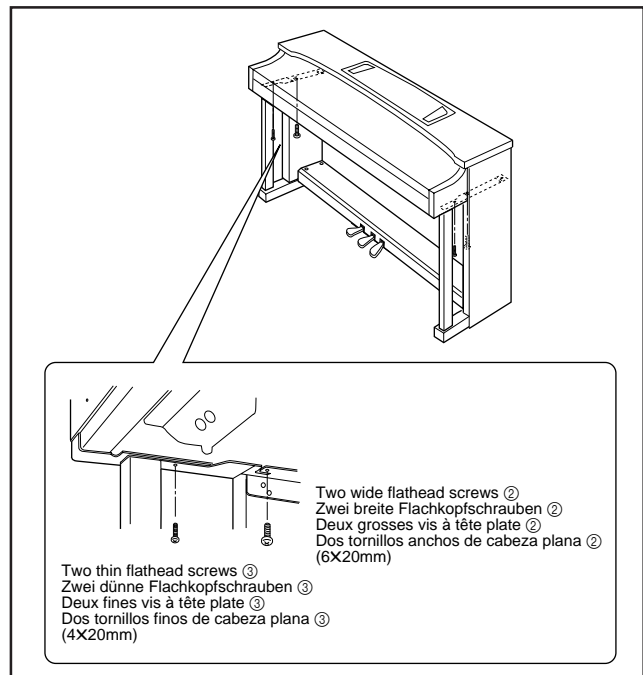

5 Instale el panel posterior (D).

Apoye la base del panel posterior (D) sobre los rebordes de las patas (en ambos paneles laterales), y gire la parte superior del panel para colocarlo en su posición. Asegure la parte alta del panel posterior a los dos paneles laterales utilizando los tornillos cortos de cabeza redonda ⑤. Atornille la parte baja del panel posterior a cuatro puntos empleando los tornillos cónicos ④.

6 Instale la unidad principal (A).

Levante la unidad principal, sosteniéndola por la base como se muestra en la ilustración. Procure sujetar el panel como mínimo a 10 cm de los bordes. Inserte la unidad en los paneles laterales desde la parte frontal, y deslícela hasta el fondo.

NOTA

Tenga cuidado con las manos y la ropa cuando instale la unidad principal.

7 Asegure la unidad principal (A) en su posición.

Primero observe desde los lados para asegurarse de que no queda ninguna abertura. Después sitúese en la parte posterior y revise las aberturas existentes entre la unidad principal y los paneles derecho e izquierdo. Ajustelos para que queden igual y asegúrelos en su posición (en ambos extremos de la parte posterior) con dos de los tornillos anchos de cabeza plana ②.

A continuación, colóquese en la parte frontal y atornille los dos tornillos finos de cabeza plana ③, y después los dos de cabeza plana restantes ②.

8

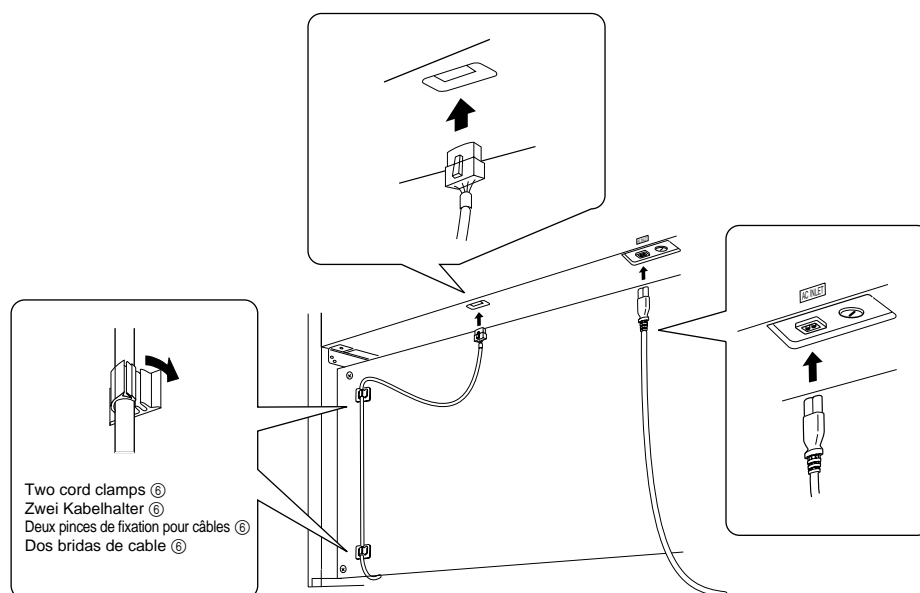

8 Connect up the pedal cord and power cord.

Hold the pedal-cord connector so that the hook is facing away from the backboard, the backboard, and plug it into the main unit. Then adhere the two cord clamps ⑥ to the backboard at the locations shown in the diagram. Set the pedal cord securely into the clamps. Finally, connect the power cord (F) to the main unit.

9 Extend the adjuster.

Turn the adjuster so that it is set firmly against the floor.

10 Set the voltage selector (if applicable), and plug the power cord into a standard wall outlet.

If your unit is equipped with a voltage selector, make sure that the value is set to the voltage level used in your area (110V, 127V, 220V or 240V). To change the setting, turn the selector (with a screwdriver) so that the appropriate value is aligned with the pointer on the panel. Note that the selector is set to 240V at time of shipment.

After completing the adjustment, you can plug the cord into a wall outlet. In some areas you may need to attach a (supplied) adaptor to the plug to enable connection to the standard local outlet.

■ After completing the assembly, please check as follows.

- Are there any parts left over?
 - ➔ Review the assembly procedure and correct any errors.
- Is the Clavinova clear of doors and other movable fixtures?
 - ➔ Move the Clavinova to an appropriate location.
- Does the Clavinova make a rattling noise when you shake it?
 - ➔ Tighten all screws.
- Does the lower board rattle or give way when you step on the pedals?
 - ➔ Turn the adjuster so that it is set firmly against the floor.
- Are the pedal and power cords inserted securely into the inlets?
 - ➔ Check the connections.
- If the main unit creaks or is otherwise unsteady when you play on the keyboard, refer to the assembly diagrams and retighten all screws.

8 Schließen Sie das Pedalkabel und das Netzkabel an.

Halten Sie den Stecker des Pedalkabels so, daß der Haken zur Tastaturseite weist, und stecken Sie ihn an die Haupteinheit. Bringen Sie dann die beiden Kabelhalter ⑥ an der Rückseite an den in der Abbildung gezeigten Positionen an. Stecken Sie das Pedalkabel sicher in die Kabelhalter. Stecken Sie zum Schluß das Netzkabel (F) an die Haupteinheit.

9 Ziehen Sie den Höhenversteller heraus.

Drehen Sie den Höhenversteller so, daß er fest gegen den Fußboden drückt.

10 Stellen Sie den Spannungsumschalter ein (wenn nötig), und stecken Sie dann das Netzkabel in eine Netzsteckdose.

Wenn Ihr Gerät mit einem Spannungsumschalter ausgestattet ist, vergewissern Sie sich, daß der eingestellte Wert auf die Versorgungsspannung Ihrer Gegend eingestellt ist (110 V, 127 V, 220 V oder 240 V). Um die Einstellung zu ändern, drehen Sie den Schalter (mit einem Schraubendreher), so der korrekte Wert mit dem Zeiger auf dem Panel übereinstimmt. Beachten Sie, daß der Schalter zur Zeit der Auslieferung auf 240 V eingestellt ist.

Wenn Sie die Einstellung vorgenommen haben, können Sie das Kabel in eine Netzsteckdose stecken. In einigen Gegenden müssen Sie evtl. einen (mitgelieferten) Adapter am Stecker anbringen, um diesen in die Netzsteckdose einstecken zu können.

■ Wenn der Zusammenbau beendet ist, prüfen Sie bitte folgende Dinge:

- Sind Teile übrig geblieben?
 - ➔ Gehen Sie den Vorgang des Zusammenbaus noch einmal durch und korrigieren Sie eventuelle Fehler.
- Befindet sich das Clavinova weit genug von Türen und anderen beweglichen Vorrichtungen entfernt?
 - ➔ Bewegen Sie das Clavinova an einen entsprechend sicheren Ort.
- Macht das Clavinova Klappergeräusche, wenn Sie es schütteln?
 - ➔ Ziehen Sie alle Schrauben fest.
- Klappert die Unterseite oder gibt sie nach, wenn Sie das Pedal treten?
 - ➔ Drehen Sie den Höhenversteller, bis er fest auf dem Fußboden steht.
- Sind Pedal- und Netzkabel richtig an den Buchsen angeschlossen?
 - ➔ Prüfen Sie die Verbindung.
- Wenn die Haupteinheit knarrt oder beim Spielen wackelt, betrachten Sie die Abbildungen und ziehen Sie alle Schrauben noch einmal nach.

9

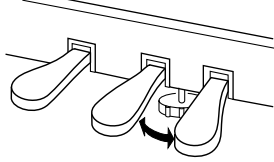

8 Raccorder le cordon des pédales et le cordon d'alimentation

Tenir la fiche du cordon des pédales de telle sorte que le crochet soit tourné à l'opposé du panneau arrière et la brancher dans la partie principale. Appliquer ensuite les deux pinces de fixation du cordon ⑥ sur le panneau arrière aux emplacements marqués sur le diagramme. Faire passer le cordon des pédales fermement entre les pinces de fixation. Finalement, raccorder le cordon d'alimentation (F) à la partie principale.

9 Etendre le stabilisateur

Tourner le stabilisateur afin qu'il repose fermement sur le sol.

10 Régler le sélecteur de tension (le cas échéant) et brancher le cordon d'alimentation dans une prise secteur normale.

Si votre appareil est équipé d'un sélecteur de tension, toujours s'assurer qu'il est bien positionné sur la tension en vigueur dans votre région (110V, 127V, 220V ou 240V). Pour modifier le réglage, tourner le sélecteur (à l'aide d'un tournevis) de sorte que la valeur souhaitée s'aligne sur le pointeur du panneau. Le sélecteur est réglé sur 240V à la sortie d'usine.

Après avoir effectué les réglages, vous pouvez brancher le cordon dans une prise secteur. Dans certaines régions, vous devrez peut-être relier la fiche à un adaptateur (fourni) pour pouvoir raccorder le Clavinova à une prise secteur locale.

■ Lorsque le montage est terminé, veuillez mener à bien les vérifications suivantes.

- Reste-t-il des pièces non utilisées?
 - ➔ Passer en revue la procédure de montage et corriger toute erreur éventuelle.
- Le Clavinova est-il placé à l'écart des portes et de toute autre structure mobile?
 - ➔ Déplacer le Clavinova vers un emplacement approprié.
- Lorsque vous secouez quelque peu le Clavinova, entendez-vous un cliquetis?
 - ➔ Serrer convenablement toutes les vis.
- Le panneau inférieur fait-il du bruit ou s'écarte-t-il lorsque vous appuyez sur les pédales?
 - ➔ Tourner le stabilisateur de sorte que le Clavinova repose fermement sur le sol.
- Les cordons des pédales et d'alimentation sont-ils bien enfoncés dans les prises?
 - ➔ Vérifier toutes les connexions.
- Si la partie principale de l'appareil craque ou est instable lorsque vous jouez sur le clavier, consulter les diagrammes de montage et resserrer toutes les vis.

10

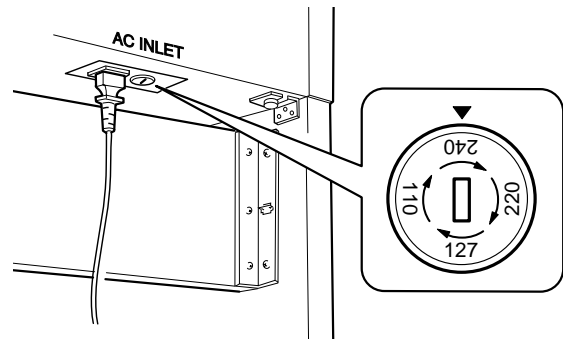

8 Conecte el cable del pedal y el cable de alimentación.

Sostenga el conector del pedal del cable de manera que el gancho quede orientado en sentido contrario al panel de fondo, y conéctelo a la unidad principal. Después adhiera las dos bridas de cable ⑥ al panel de fondo, en las posiciones indicadas en el dibujo. Asegure con decisión el cable del pedal a las bridas. Por último, conecte el cable de alimentación (F) a la unidad principal.

9 Regule el estabilizador.

Gire el estabilizador hasta que apoye firmemente sobre el suelo.

10 Ajuste el selector de tensión (si es necesario), y conecte el cable de alimentación a una toma mural estándar.

Si la unidad está provista de un selector de tensión, asegúrese de que coincide con la tensión de red de su localidad (110 V, 127 V, 220 V o 240 V). Para cambiar el ajuste, gire el selector (con un destornillador) hasta que la aguja del panel esté alineada con el valor adecuado. Observe que el selector viene ajustado a 240 V en el momento de salir de fábrica.

Una vez realizado el ajuste, puede conectar el cable de alimentación a una toma mural. En algunas zonas quizás sea necesario acoplar un adaptador (incluido con el equipo) al enchufe para poder conectarlo a la toma mural.

■ Cuando haya concluido el montaje, compruebe los siguientes puntos:

- ¿Ha quedado alguna pieza sin instalar?
 - ➔ Revise el procedimiento de montaje y corrija cualquier error que se haya podido cometer.
- ¿Está el Clavinova alejado del recorrido de puertas y muebles?
 - ➔ Traslade el Clavinova a una posición adecuada.
- ¿Suena algún ruido de holgura cuando se mueve el Clavinova?
 - ➔ Apriete con firmeza todos los tornillos.
- ¿Vibra o cede el panel inferior cuando se pisan los pedales?
 - ➔ Gire el estabilizador hasta que apoye firmemente sobre el suelo.
- ¿Están perfectamente insertados los cables de pedal y alimentación en los conectores?
 - ➔ Revise las conexiones.
- Si la unidad principal cruje o presenta algún signo de inestabilidad cuando se toca el teclado, consulte los esquemas de montaje y vuelva a apretar todos los tornillos.

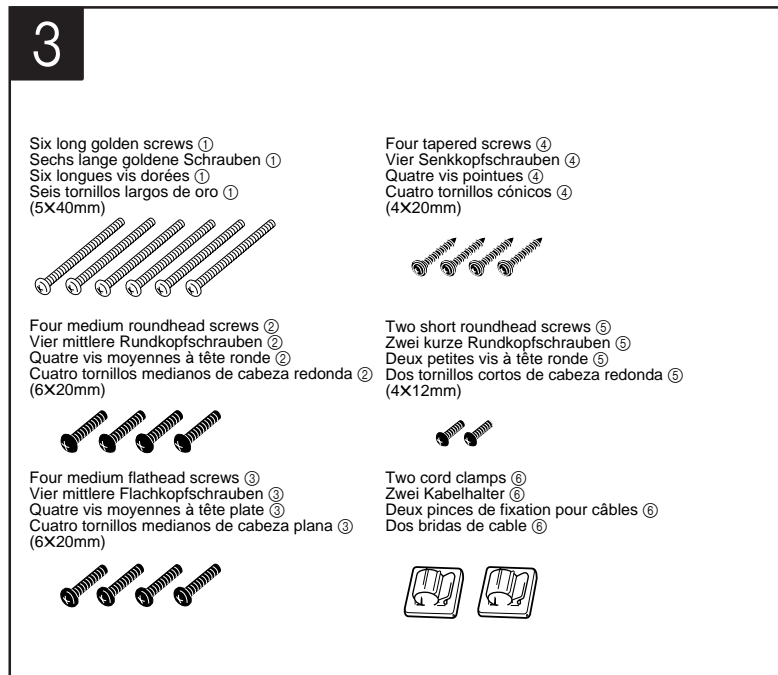
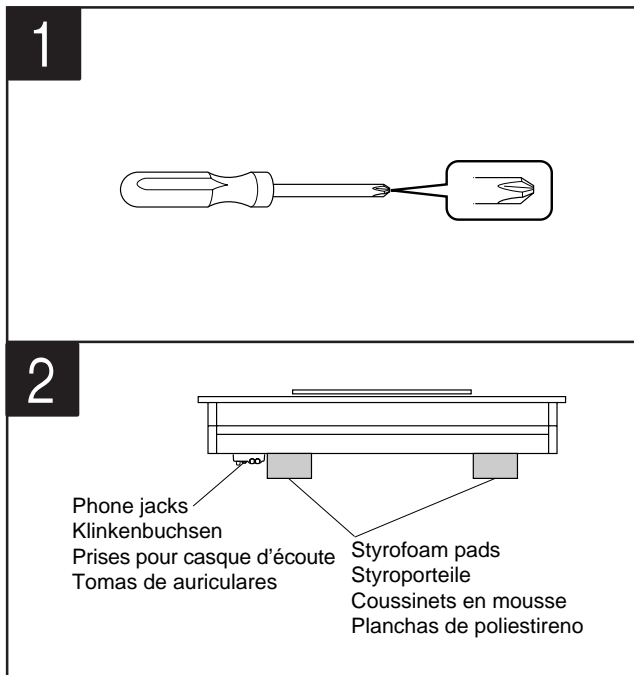

CLP-611 Assembly Procedure

NOTE

- Be careful not to confuse parts, and be sure to install all parts in the correct direction. Please assemble in accordance with the sequence given below.
- Assembly should be carried out by at least two persons.
- Be sure to use the correct screw sizes. Use of incorrect screws can cause damage.
- Be sure to tighten up all screws upon completing assembly of each unit.
- To disassemble, reverse the assembly sequence given below.

- 1 Have a Phillips-head screwdriver ready.
- 2 Open the box. Take out the two styrofoam pads and place them on the floor. Then take out main unit (A) and place it on top of the pads.

NOTE

Position the pads so as to protect the phone jacks on the base of the unit.

- 3 Remove all parts from the box. Confirm that all of the parts indicated above are present.
- 4 Fasten right sideboard (C) to right leg (G), and left sideboard (B) to left leg (F). In each case, join the board to the leg, aligning the notch on the metal fitting with the indentation on the leg. Fasten in place with the long gold screws ①.

Montage des CLP-611

HINWEIS

- Achten Sie darauf, die Teile nicht zu verwechseln, und installieren Sie alle Teile in der richtigen Ausrichtung. Gehen Sie beim Zusammenbau bitte in der angegebenen Reihenfolge vor.
- Die Montage sollte von mindestens zwei Personen vorgenommen werden.
- Achten Sie darauf, die richtige Schraubengröße zu verwenden. Die Verwendung der falschen Schrauben kann zu Schäden führen.
- Achten Sie während der Montage darauf, bei jedem Arbeitgang alle Schrauben festzuziehen.
- Für die Demontage muß die angegebene Reihenfolge umgekehrt befolgt werden.

- 1 Halten Sie einen Kreuzschlitzschraubendreher bereit.
- 2 Öffnen Sie den Karton. Nehmen Sie die beiden Styroporteile heraus und legen Sie sie auf den Boden. Nehmen Sie dann die Haupteinheit (A) heraus, und legen Sie es auf die Styroporteile.

HINWEIS

Positionieren Sie die Styroporteile so, daß die Klinkenbuchsen am Boden des Gerätes geschützt sind.

- 3 Nehmen Sie alle Teile aus dem Karton. Sehen Sie nach, ob alle oben gezeigten Teile vorhanden sind.
- 4 Bringen Sie das rechte Seitenteil (C) am rechten Bein (G), das linke Seitenteil (B) am linken Bein (F) an. Verbinden Sie das Seitenteil mit dem Bein, indem Sie die Aussparung an dem Metallbeschlag mit der Vertiefung im Bein in Übereinstimmung bringen. Befestigen Sie es mit den langen Goldene Schrauben ①.

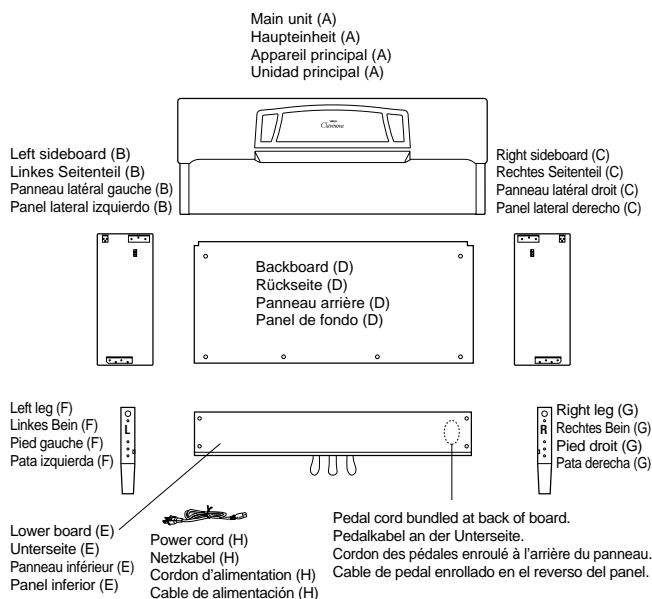

4

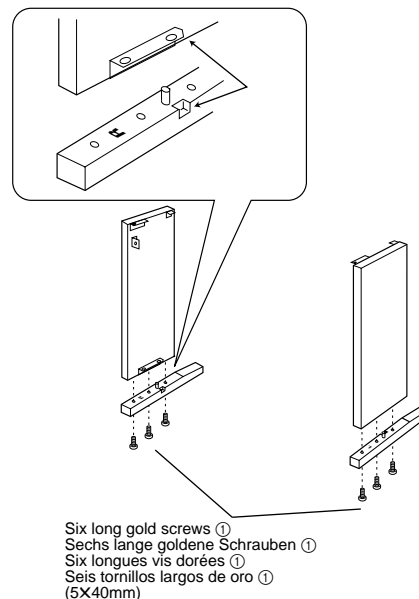

CLP-611 Montage Procédure

REMARQUE

- Veiller à ne pas mélanger les pièces et à les installer dans le sens correct. Veuillez assembler l'instrument dans l'ordre indiqué ci-dessous.
- La présence de deux personnes minimum est nécessaire pour procéder au montage.
- Toujours utiliser des vis aux dimensions correctes, comme indiqué à gauche. L'utilisation de vis aux dimensions incorrectes pourrait en effet endommager l'instrument.
- Resserrer convenablement toutes les vis après le montage de chaque élément.
- Pour démonter le Clavinova, inverser l'ordre des indications données ci-dessous.

- 1 Préparer un tournevis Phillips (en croix).
- 2 Ouvrir le carton d'emballage. Sortir les deux coussinets en mousse et les placer sur le sol. Sortir ensuite l'appareil principal (A) et le placer sur les coussinets.

REMARQUE

Placer les coussinets de sorte à protéger les connecteurs pour casques d'écoute, sur la face arrière.

- 3 Retirer toutes les pièces du carton. Vérifier que toutes les pièces indiquées ci-dessus sont présentes.
- 4 Attacher le panneau latéral droit (C) au pied droit (G) et le panneau latéral gauche (B) au pied gauche (F). Dans chacun des cas, fixer le panneau au pied en alignant l'encoche de la ferrure en métal sur l'indentation du pied. Serrer en place à l'aide des longues vis dorées ①.

Montaje del modelo CLP-611

NOTA

- Observe cuidado para no confundir las piezas, y asegúrese de montar todas ellas en el sentido correcto. Proceda al montaje en el orden indicado a continuación.
- El montaje deberá realizarse al menos por dos personas.
- Procure utilizar los tornillos del tamaño adecuado. El empleo de tornillos inadecuados puede ocasionar daños en el instrumento.
- Asegúrese de apretar bien todos los tornillos después de montar cada unidad.
- Para desmontar las unidades, invierta la secuencia de montaje facilitada a continuación.

- 1 Prepare un destornillador de estrella.
- 2 Abra la caja. Retire las dos planchas de poliestireno y colóquelas sobre el suelo. A continuación extraiga la unidad principal (A) y colóquela sobre las planchas.

NOTA

Sitúe las planchas de forma que queden protegidas las tomas de auriculares de la base de la unidad.

- 3 Extraiga todas las piezas de la caja. Compruebe que no falta ninguna de las piezas arriba indicadas.
- 4 Asegure el panel derecho (C) a la pata derecha (G), y el panel izquierdo (B) a la pata izquierda (F). En ambos casos, acople el panel alineando la entalladura de la parte metálica con los dientes de la pata. Asegúrelo con los tornillos dorados largos ①.

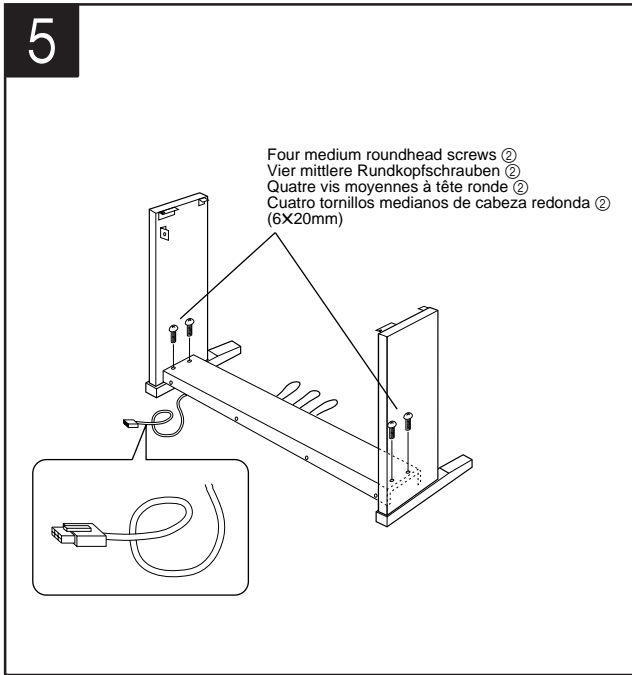

5 Install lower board (E).

Unravel the pedal cord bundled to the bottom of lower board (E). Then align the ends of lower board (E) with the right sideboard (C) and left sideboard (B). Fasten board (E) in place with the four medium roundhead screws ②.

6 Install backboard (D).

Rest the bottom of backboard (D) on the leg ledges (on both sides), and pivot the top of the board into place. Fasten the upper part of the backboard to the two sideboards using the short roundhead screws ⑤. Fasten the lower part of the backboard in four places using the tapered screws ④.

7 Set main unit (A) into place.

Lift the main unit by holding it on the bottom as shown in the diagram. Be sure to grasp the board at least 4 inches (10 cm) away from the sides.

8 Fasten main unit (A).

View the unit from the front, and adjust the position to the right or left as necessary so that the overhang is equivalent at both sides. Then, still working from the front, fasten in place with the four medium flathead screws ③.

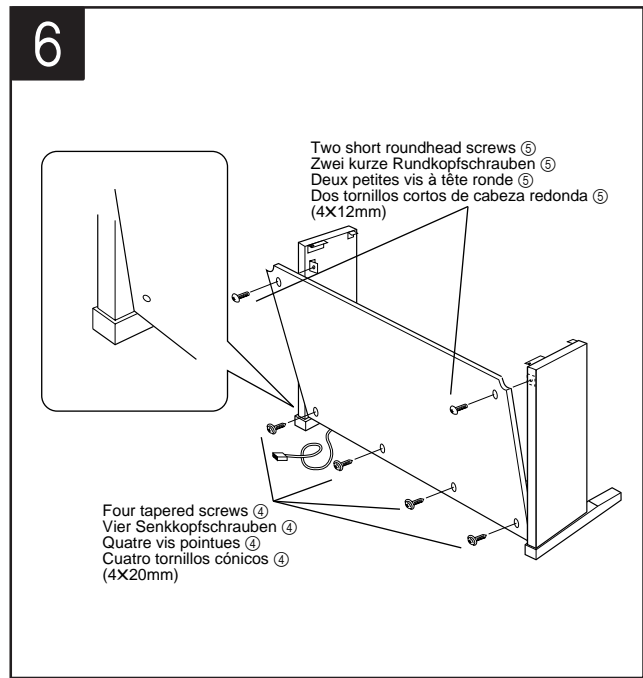

5 Bringen Sie die Unterseite (E) an.

Lösen Sie dazu zunächst das Pedalkabel auf, das unten an der Unterseite zusammengebündelt ist (E). Richten Sie dann die Enden der Unterseite (E) mit dem rechten Seitenteil (C) und dem linken Seitenteil (B) aus. Schrauben Sie die Unterseite schließlich mit den vier mittleren Rundkopfschrauben ② fest.

6 Bringen Sie die Rückseite (D) an.

Setzen Sie die Unterkante der Rückseite (D) auf die Fußvorsprünge (auf beiden Seitenteilen), und kippen Sie die Oberkante der Rückseite an die Haupteinheit. Befestigen Sie die Oberkante der Rückseite mit den kurzen Rundkopfschrauben ⑤ an den beiden Seitenteilen. Befestigen Sie den unteren Teil der Rückseite an vier Stellen mit den vier Senkkopfschrauben ④.

7 Montieren Sie die Haupteinheit (A).

Heben Sie die Haupteinheit an, indem Sie darunter greifen, wie in der Abbildung gezeigt. Achten Sie darauf, das Teil mindestens 10 cm von den Seiten entfernt zu greifen.

8 Befestigen Sie die Haupteinheit (A).

Betrachten Sie das Gerät von vorn, und schieben Sie es in die Position, in der der Überhang an den linken und rechten Seiten gleich ist. Schrauben Sie, immer noch von vorn, die Haupteinheit mit den vier mittleren Flachkopfschrauben ③ fest.

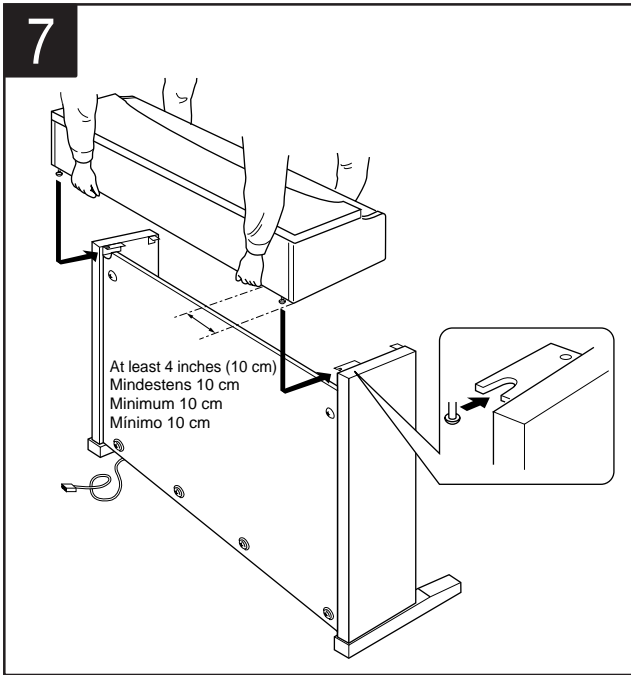

5 Installer le panneau inférieur (E)

Défaire en premier lieu le cordon de la pédale fixé à la partie inférieure (E). Aligner ensuite les extrémités de la partie inférieure (E) sur les extrémités de la partie latérale droite (C) et de la partie latérale gauche (B). Finalement, visser en place à l'aide des quatre vis moyennes à tête ronde ②.

6 Installer le panneau arrière (D)

Reposer le bas du panneau arrière (D) sur le rebord des pieds (des deux panneaux latéraux) et faire pivoter le dessus du panneau pour le mettre en place. Fixer la partie supérieure du panneau arrière aux deux panneaux latéraux à l'aide des petites vis à tête ronde ⑤. Attacher la partie inférieure du panneau arrière à quatre endroits à l'aide des vis pointues ④.

7 Installer la partie principale (A)

Soulever la partie principale, en la soutenant par le fond comme illustré sur le diagramme. Toujours veiller à saisir le panneau à au moins 10 cm des extrémités.

8 Fixer la partie principale.

Regarder l'appareil de face et régler sa position vers la droite ou vers la gauche pour que la partie principale dépasse de manière identique à gauche et à droite. Ensuite, continuer de travailler de face et visser les quatre vis moyennes à tête plate ③.

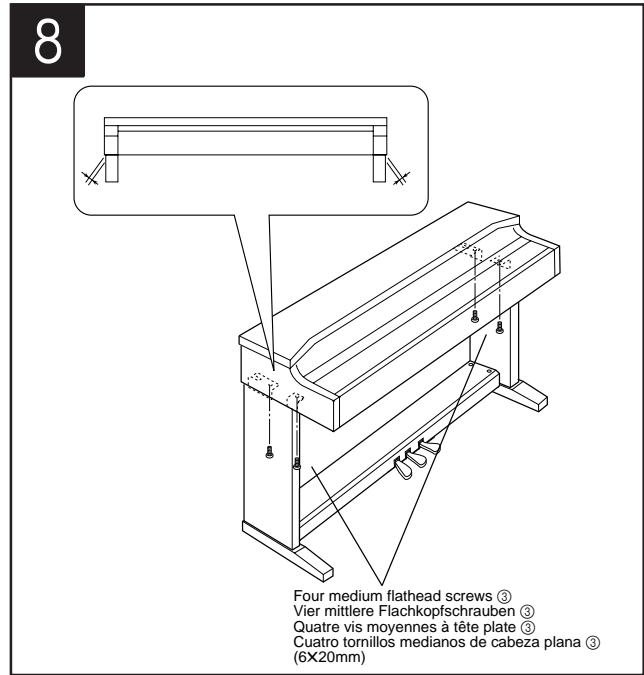

5 Instale el panel inferior (E).

Desenrolle el cable del pedal fijado en la base del panel inferior (E). Seguidamente, alinee los bordes del panel inferior (E) con los paneles laterales derecho (C) e izquierdo (B). Acople el panel (E) con los cuatro tornillos medianos de cabeza redonda ②.

6 Instale el panel de fondo (D).

Apoye la base del panel de fondo (D) sobre los rebordes de las patas (en ambos lados), y gire la parte superior del panel para colocarlo en su posición. Asegure la parte alta del panel de fondo a los dos laterales empleando los tornillos cortos de cabeza redonda ⑤. Atornille la parte baja del panel de fondo a cuatro puntos empleando los tornillos cónicos ④.

7 Instale la unidad principal (A).

Levante la unidad principal, sosteniéndola por la base como se muestra en la ilustración. Procure sujetar el panel como mínimo a 10 cm de los bordes.

8 Asegure la unidad principal (A) en su posición.

Sitúese delante de la unidad y ajuste los laterales derecho e izquierdo de forma que el saliente sea equidistante por ambos lados. A continuación, y también desde la parte frontal, asegúrelos en su posición con los cuatro tornillos medianos de cabeza plana ③.

9

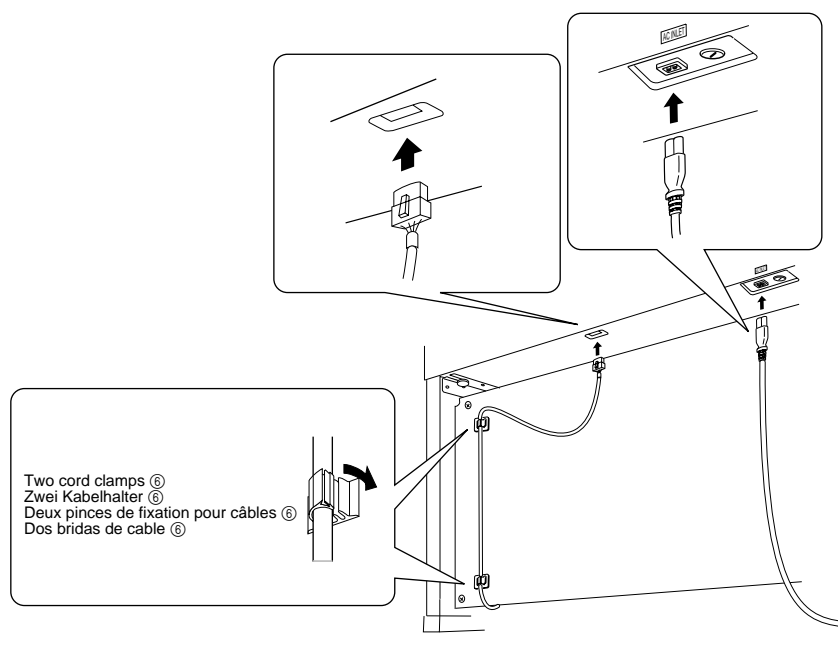

9 Connect up the pedal cord and power cord.

Hold the pedal-cord connector so that the hook is facing away from the backboard, and plug it into the main unit. Then adhere the two cord clamps ⑥ to the backboard at the locations shown in the diagram. Set the pedal cord securely into the clamps. Finally, connect the power cord (F) to the main unit.

10 Extend the adjuster.

Turn the adjuster so that it is set firmly against the floor.

11 Set the voltage selector (if applicable), and plug the power cord into a standard wall outlet.

If your unit is equipped with a voltage selector, make sure that the value is set to the voltage level used in your area (110V, 127V, 220V or 240V). To change the setting, turn the selector (with a screwdriver) so that the appropriate value is aligned with the pointer on the panel. Note that the selector is set to 240V at time of shipment.

After completing the adjustment, you can plug the cord into a wall outlet. In some areas you may need to attach a (supplied) adaptor to the plug to enable connection to the standard local outlet.

■ After completing the assembly, please check as follows.

- Are there any parts left over?
 - ➔ Review the assembly procedure and correct any errors.
- Is the Clavinova clear of doors and other movable fixtures?
 - ➔ Move the Clavinova to an appropriate location.
- Does the Clavinova make a rattling noise when you shake it?
 - ➔ Tighten all screws.
- Does the lower board rattle or give way when you step on the pedals?
 - ➔ Turn the adjuster so that it is set firmly against the floor.
- Are the pedal and power cords inserted securely into the inlets?
 - ➔ Check the connections.
- If the main unit creaks or is otherwise unsteady when you play on the keyboard, refer to the assembly diagrams and retighten all screws.

9 Schließen Sie das Pedalkabel und das Netzkabel an.

Halten Sie den Stecker des Pedalkabels so, daß der Haken zur Tastenseite weist, und stecken Sie ihn an die Haupteinheit. Bringen Sie dann die beiden Kabelhalter ⑥ an der Rückseite an den in der Abbildung gezeigten Positionen an. Stecken Sie das Pedalkabel sicher in die Kabelhalter. Stecken Sie zum Schluß das Netzkabel (F) an die Haupteinheit.

10 Ziehen Sie den Höhenversteller heraus.

Drehen Sie den Höhenversteller so, daß er fest gegen den Fußboden drückt.

11 Stellen Sie den Spannungsumschalter ein (wenn nötig), und stecken Sie dann das Netzkabel in eine Netzsteckdose.

Wenn Ihr Gerät mit einem Spannungsumschalter ausgestattet ist, vergewissern Sie sich, daß der eingestellte Wert auf die Versorgungsspannung Ihrer Gegend eingestellt ist (110 V, 127 V, 220 V oder 240 V). Um die Einstellung zu ändern, drehen Sie den Schalter (mit einem Schraubendreher), so der korrekte Wert mit dem Zeiger auf dem Panel übereinstimmt. Beachten Sie, daß der Schalter zur Zeit der Auslieferung auf 240 V eingestellt ist.

Wenn Sie die Einstellung vorgenommen haben, können Sie das Kabel in eine Netzsteckdose stecken. In einigen Gegenden müssen Sie evtl. einen (mitgelieferten) Adapter am Stecker anbringen, um diesen in die Netzsteckdose einstecken zu können.

■ Wenn der Zusammenbau beendet ist, prüfen Sie bitte folgende Dinge:

- Sind Teile übrig geblieben?
 - ➔ Gehen Sie den Vorgang des Zusammenbaus noch einmal durch und korrigieren Sie eventuelle Fehler.
- Befindet sich das Clavinova weit genug von Türen und anderen beweglichen Vorrichtungen entfernt?
 - ➔ Bewegen Sie das Clavinova an einen entsprechend sicheren Ort.
- Macht das Clavinova Klappergeräusche, wenn Sie es schütteln?
 - ➔ Ziehen Sie alle Schrauben fest.
- Klappert die Unterseite oder gibt sie nach, wenn Sie das Pedal treten?
 - ➔ Drehen Sie den Höhenversteller, bis er fest auf dem Fußboden steht.
- Sind Pedal- und Netzkabel richtig an den Buchsen angeschlossen?
 - ➔ Prüfen Sie die Verbindung.
- Wenn die Haupteinheit knarrt oder beim Spielen wackelt, betrachten Sie die Abbildungen und ziehen Sie alle Schrauben noch einmal nach.

10

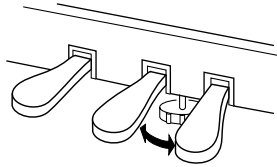

9 Raccorder le cordon des pédales et le cordon d'alimentation

Tenir la fiche du cordon des pédales de telle sorte que le crochet soit tourné à l'opposé du panneau arrière et la brancher dans la partie principale. Appliquer ensuite les deux pinces de fixation du cordon ⑥ sur le panneau arrière aux emplacements marqués sur le diagramme. Faire passer le cordon des pédales fermement dans les pinces de fixation. Finalement, raccorder le cordon d'alimentation (F) à la partie principale.

10 Etendre le stabilisateur

Tourner le stabilisateur afin qu'il repose fermement sur le sol.

11 Régler le sélecteur de tension (le cas échéant) et brancher le cordon d'alimentation dans une prise secteur normale.

Si votre appareil est équipé d'un sélecteur de tension, toujours s'assurer qu'il est bien positionné sur la tension en vigueur dans votre région (110V, 127V, 220V ou 240V). Pour modifier le réglage, tourner le sélecteur (à l'aide d'un tournevis) de sorte que la valeur souhaitée s'aligne sur le pointeur du panneau. Le sélecteur est réglé sur 240V à la sortie d'usine.

Après avoir effectué les réglages, vous pouvez brancher le cordon dans une prise secteur. Dans certaines régions, vous devrez peut-être relier la fiche à un adaptateur (fourni) pour pouvoir raccorder le Clavinova à une prise secteur locale.

■ Lorsque le montage est terminé, veuillez mener à bien les vérifications suivantes.

- Reste-t-il des pièces non utilisées?
 - ➔ Passer en revue la procédure de montage et corriger toute erreur éventuelle.
- Le Clavinova est-il placé à l'écart des portes et de toute autre structure mobile?
 - ➔ Déplacer le Clavinova vers un emplacement approprié.
- Lorsque vous secouez quelque peu le Clavinova, entendez-vous un cliquetis?
 - ➔ Serrer convenablement toutes les vis.
- Le panneau inférieur fait-il du bruit ou s'écarte-t-il lorsque vous appuyez sur les pédales?
 - ➔ Tourner le stabilisateur de sorte que le Clavinova repose fermement sur le sol.
- Les cordons des pédales et d'alimentation sont-ils bien enfoncés dans les prises?
 - ➔ Vérifier toutes les connexions.
- Si la partie principale de l'appareil craque ou est instable lorsque vous jouez sur le clavier, consulter les diagrammes de montage et resserrer toutes les vis.

11

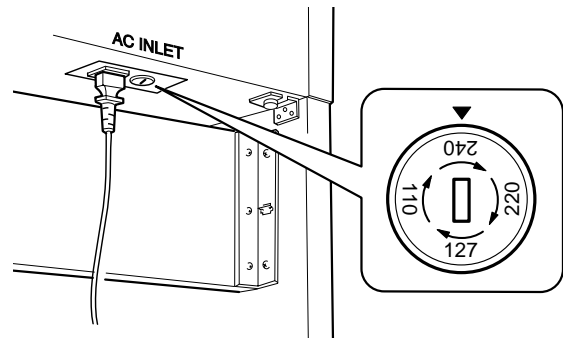

9 Conecte el cable del pedal y el cable de alimentación.

Sostenga el conector del pedal del cable de manera que el gancho quede orientado en sentido contrario al panel de fondo, y conéctelo a la unidad principal. Después adhiera las dos bridas de cable ⑥ al panel de fondo, en las posiciones indicadas en el dibujo. Asegure con decisión el cable del pedal a las bridas. Por último, conecte el cable de alimentación (F) a la unidad principal.

10 Regule el estabilizador.

Gire el estabilizador hasta que apoye firmemente sobre el suelo.

11 Ajuste el selector de tensión (si es necesario), y conecte el cable de alimentación a una toma mural estándar.

Si la unidad está provista de un selector de tensión, asegúrese de que coincide con la tensión de red de su localidad (110 V, 127 V, 220 V o 240 V). Para cambiar el ajuste, gire el selector (con un destornillador) hasta que la aguja del panel esté alineada con el valor adecuado. Observe que el selector viene ajustado a 240 V en el momento de salir de fábrica.

Una vez realizado el ajuste, puede conectar el cable de alimentación a una toma mural. En algunas zonas quizás sea necesario acoplar un adaptador (incluido con el equipo) al enchufe para poder conectarlo a la toma mural.

■ Cuando haya concluido el montaje, compruebe los siguientes puntos:

- ¿Ha quedado alguna pieza sin instalar?
 - ➔ Revise el procedimiento de montaje y corrija cualquier error que se haya podido cometer.
- ¿Está el Clavinova alejado del recorrido de puertas y muebles?
 - ➔ Traslade el Clavinova a una posición adecuada.
- ¿Suena algún ruido de holgura cuando se mueve el Clavinova?
 - ➔ Apriete con firmeza todos los tornillos.
- ¿Vibra o cede el panel inferior cuando se pisan los pedales?
 - ➔ Gire el estabilizador hasta que apoye firmemente sobre el suelo.
- ¿Están perfectamente insertados los cables de pedal y alimentación en los conectores?
 - ➔ Revise las conexiones.
- Si la unidad principal cruje o presenta algún signo de inestabilidad cuando se toca el teclado, consulte los esquemas de montaje y vuelva a apretar todos los tornillos.

FCC INFORMATION (U.S.A.)

1. IMPORTANT NOTICE: DO NOT MODIFY THIS UNIT!

This product, when installed as indicated in the instructions contained in this manual, meets FCC requirements. Modifications not expressly approved by Yamaha may void your authority, granted by the FCC, to use the product.

2. IMPORTANT:

When connecting this product to accessories and/or another product use only high quality shielded cables. Cable/s supplied with this product MUST be used. Follow all installation instructions. Failure to follow instructions could void your FCC authorization to use this product in the USA.

3. NOTE:

This product has been tested and found to comply with the requirements listed in FCC Regulations, Part 15 for Class "B" digital devices. Compliance with these requirements provides a reasonable level of assurance that your use of this product in a residential environment will not result in harmful interference with other electronic devices. This equipment generates/uses radio frequencies and, if not installed and used according to the instructions found in the users manual, may cause interference harmful to the operation of other electronic devices. Compliance with FCC

regulations does not guarantee that interference will not occur in all installations. If this product is found to be the source of interference, which can be determined by turning the unit "OFF" and "ON", please try to eliminate the problem by using one of the following measures:

Relocate either this product or the device that is being affected by the interference.

Utilize power outlets that are on different branch (circuit breaker or fuse) circuits or install AC line filter/s.

In the case of radio or TV interference, relocate/reorient the antenna. If the antenna lead-in is 300 ohm ribbon lead, change the lead-in to co-axial type cable.

If these corrective measures do not produce satisfactory results, please contact the local retailer authorized to distribute this type of product. If you can not locate the appropriate retailer, please contact Yamaha Corporation of America, Electronic Service Division, 6600 Orangethorpe Ave, Buena Park, CA90620

The above statements apply ONLY to those products distributed by Yamaha Corporation of America or its subsidiaries.

* This applies only to products distributed by YAMAHA CORPORATION OF AMERICA.

IMPORTANT NOTICE FOR THE UNITED KINGDOM

Connecting the Plug and Cord

IMPORTANT. The wires in this mains lead are coloured in accordance with the following code:

BLUE : NEUTRAL
BROWN : LIVE

As the colours of the wires in the mains lead of this apparatus may not correspond with the coloured markings identifying the terminals in your plug proceed as follows:

The wire which is coloured BLUE must be connected to the terminal which is marked with the letter N or coloured BLACK.

The wire which is coloured BROWN must be connected to the terminal which is marked with the letter L or coloured RED.

Making sure that neither core is connected to the earth terminal of the three pin plug.

• This applies only to products distributed by Yamaha-Kemble Music (U.K.) Ltd.

CAUTION: TO PREVENT ELECTRIC SHOCK, MATCH WIDE BLADE OF PLUG TO WIDE SLOT, FULLY INSERT.

ATTENTION: POUR ÉVITER LES CHOCS ÉLECTRIQUES, INTRODUIRE LA LAME LA PLUS LARGE DE LA FICHE DANS LA BORNE CORRESPONDANTE DE LA PRISE ET POUSSER JUSQU'AU FOND.

• This applies only to products distributed by Yamaha Canada Music Ltd.
• Ceci ne s'applique qu'aux produits distribués par Yamaha Canada Musique Ltée.

IMPORTANT SAFETY INSTRUCTIONS

INFORMATION RELATING TO PERSONAL INJURY, ELECTRICAL SHOCK, AND FIRE HAZARD POSSIBILITIES HAS BEEN INCLUDED IN THIS LIST.

WARNING- When using any electrical or electronic product, basic precautions should always be followed. These precautions include, but are not limited to, the following:

- 1.** Read all Safety Instructions, Installation Instructions, Special Message Section items, and any Assembly Instructions found in this manual BEFORE making any connections, including connection to the main supply.
- 2.** Main Power Supply Verification: Yamaha products are manufactured specifically for the supply voltage in the area where they are to be sold. If you should move, or if any doubt exists about the supply voltage in your area, please contact your dealer for supply voltage verification and (if applicable) instructions. The required supply voltage is printed on the name plate. For name plate location, please refer to the graphic found in the Special Message Section of this manual.
- 3.** This product may be equipped with a polarized plug (one blade wider than the other). If you are unable to insert the plug into the outlet, turn the plug over and try again. If the problem persists, contact an electrician to have the obsolete outlet replaced. Do NOT defeat the safety purpose of the plug.
- 4.** Some electronic products utilize external power supplies or adapters. Do NOT connect this type of product to any power supply or adapter other than one described in the owners manual, on the name plate, or specifically recommended by Yamaha.
- 5.** **WARNING:** Do not place this product or any other objects on the power cord or place it in a position where anyone could walk on, trip over, or roll anything over power or connecting cords of any kind. The use of an extension cord is not recommended! If you must use an extension cord, the minimum wire size for a 25' cord (or less) is 18 AWG. NOTE: The smaller the AWG number, the larger the current handling capacity. For longer extension cords, consult a local electrician.
- 6.** Ventilation: Electronic products, unless specifically designed for enclosed installations, should be placed in locations that do not interfere with proper ventilation. If instructions for enclosed installations are not provided, it must be assumed that unobstructed ventilation is required.
- 7.** Temperature considerations: Electronic products should be installed in locations that do not significantly contribute to their operating temperature. Placement of this product close to heat sources such as; radiators, heat registers and other devices that produce heat should be avoided.

- 8.** This product was NOT designed for use in wet/damp locations and should not be used near water or exposed to rain. Examples of wet/damp locations are; near a swimming pool, spa, tub, sink, or wet basement.
- 9.** This product should be used only with the components supplied or; a cart, rack, or stand that is recommended by the manufacturer. If a cart, rack, or stand is used, please observe all safety markings and instructions that accompany the accessory product.
- 10.** The power supply cord (plug) should be disconnected from the outlet when electronic products are to be left unused for extended periods of time. Cords should also be disconnected when there is a high probability of lightning and/or electrical storm activity.
- 11.** Care should be taken that objects do not fall and liquids are not spilled into the enclosure through any openings that may exist.
- 12.** Electrical/electronic products should be serviced by a qualified service person when:
 - a. The power supply cord has been damaged; or
 - b. Objects have fallen, been inserted, or liquids have been spilled into the enclosure through openings; or
 - c. The product has been exposed to rain; or
 - d. The product does not operate, exhibits a marked change in performance; or
 - e. The product has been dropped, or the enclosure of the product has been damaged.
- 13.** Do not attempt to service this product beyond that described in the user-maintenance instructions. All other servicing should be referred to qualified service personnel.
- 14.** This product, either alone or in combination with an amplifier and headphones or speaker/s, may be capable of producing sound levels that could cause permanent hearing loss. DO NOT operate for a long period of time at a high volume level or at a level that is uncomfortable. If you experience any hearing loss or ringing in the ears, you should consult an audiologist. IMPORTANT: The louder the sound, the shorter the time period before damage occurs.
- 15.** Some Yamaha products may have benches and/or accessory mounting fixtures that are either supplied as a part of the product or as optional accessories. Some of these items are designed to be dealer assembled or installed. Please make sure that benches are stable and any optional fixtures (where applicable) are well secured BEFORE using. Benches supplied by Yamaha are designed for seating only. No other uses are recommended.

PLEASE KEEP THIS MANUAL



Free Manuals Download Website

<http://myh66.com>

<http://usermanuals.us>

<http://www.somanuals.com>

<http://www.4manuals.cc>

<http://www.manual-lib.com>

<http://www.404manual.com>

<http://www.luxmanual.com>

<http://aubethermostatmanual.com>

Golf course search by state

<http://golfingnear.com>

Email search by domain

<http://emailbydomain.com>

Auto manuals search

<http://auto.somanuals.com>

TV manuals search

<http://tv.somanuals.com>