

YAMAHA Clavinova®

CVP-49

Owner's Manual Bedienungsanleitung Mode d'emploi Manual de instrucciones

IMPORTANT

Check Your Power Supply

Make sure that your local AC mains voltage matches the voltage specified on the name plate on the bottom panel. In some areas a voltage selector may be provided on the bottom panel of the main keyboard unit near the power cord. Make sure that the voltage selector is set for the voltage in your area. The voltage selector is set at 240V when the unit is initially shipped. To change the setting use a "minus" screwdriver to rotate the selector dial so that the correct voltage appears next to the pointer on the panel.

WICHTIG

Netzspannung überprüfen

Vergewissern Sie sich vor dem Anschließen an das Stromnetz, daß die örtliche Netzspannung den Betriebsspannungswerten auf dem Typenschild an der Unterseite des Instruments entspricht. In bestimmten Verkaufsgebieten ist das Instrument mit einem Spannungswähler an der Unterseite neben der Netzkabeldurchführung ausgestattet. Falls vorhanden, muß der Spannungswähler auf die örtliche Netzspannung eingestellt werden. Der Spannungswähler wurde werkseitig auf 240 V voreingestellt. Zum Verstellen drehen Sie den Spannungsregler mit einem Schlitzschraubendreher, bis der Zeiger auf den korrekten Spannungswert weist.

IMPORTANT

Vérifiez la source d'alimentation

Vérifiez que la tension spécifiée sur le panneau arrière correspond à la tension du secteur. Dans certaines régions, l'instrument peut être équipé d'un sélecteur de tension situé sur le panneau inférieur du clavier à proximité du cordon d'alimentation. Vérifiez que ce sélecteur est bien réglé en fonction de la tension secteur de votre région. Le sélecteur de tension est réglé sur 240 V au départ d'usine. Pour modifier ce réglage, utilisez un tournevis à lame plate pour tourner le sélecteur afin de mettre l'indication correspondant à la tension de votre région vis à vis du repère triangulaire situé sur le panneau.

IMPORTANTE

Compruebe la alimentación de su área

Asegúrese de que tensión de alimentación de CA de su área corresponde con la tensión especificada en la placa de características del panel inferior de la unidad del teclado principal, cerca del cable de alimentación. En algunas áreas, el selector de tensión puede estar situado en el panel inferior del teclado principal, cerca del cable de alimentación. Asegúrese de que el selector de tensión esté ajustado a la tensión de su área. El selector de tensión se ajusta a 240V cuando la unidad sale de fábrica. Para cambiar el ajuste, emplee un destornillador de cabeza "recta" para girar el selector de modo que aparezca la tensión correcta al lado del indicador del panel.

SPECIAL MESSAGE SECTION

PRODUCT SAFETY MARKINGS: Yamaha electronic products may have either labels similar to the graphics shown below or molded/stamped facsimiles of these graphics on the enclosure. The explanation of these graphics appears on this page. Please observe all cautions indicated on this page and those indicated in the safety instruction section.

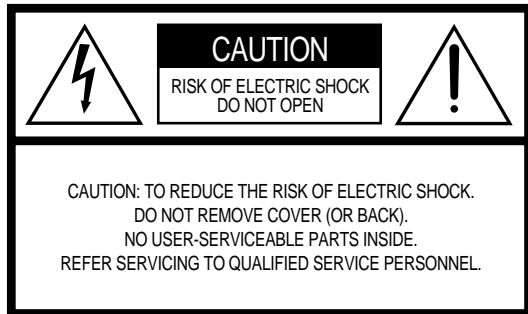

See bottom of Keyboard enclosure for graphic symbol markings



The exclamation point with the equilateral triangle is intended to alert the user to the presence of important operating and maintenance (servicing) instructions in the literature accompanying the product.

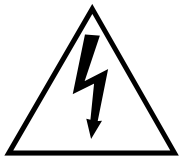

The lightning flash with arrowhead symbol within the equilateral triangle is intended to alert the user to the presence of uninsulated “dangerous voltage” within the product’s enclosure that may be of sufficient magnitude to constitute a risk of electrical shock.

IMPORTANT NOTICE: All Yamaha electronic products are tested and approved by an independent safety testing laboratory in order that you may be sure that when it is properly installed and used in its normal and customary manner, all foreseeable risks have been eliminated. **DO NOT** modify this unit or commission others to do so unless specifically authorized by Yamaha. Product performance and/or safety standards may be diminished. Claims filed under the expressed warranty may be denied if the unit is/has been modified. Implied warranties may also be affected.

SPECIFICATIONS SUBJECT TO CHANGE: The information contained in this manual is believed to be correct at the time of printing. However, Yamaha reserves the right to change or modify any of the specifications without notice or obligation to update existing units.

ENVIRONMENTAL ISSUES: Yamaha strives to produce products that are both user safe and environmentally friendly. We sincerely believe that our products and the production methods used to produce them, meet these goals. In keeping with both the letter and the spirit of the law, we want you to be aware of the following:

Battery Notice: This product MAY contain a small non-rechargeable battery which (if applicable) is soldered in place. The average life span of this type of battery is approximately five years. When replacement becomes necessary, contact a qualified service representative to perform the replacement.

Warning: Do not attempt to recharge, disassemble, or incinerate this type of battery. Keep all batteries away from children. Dispose of used batteries promptly and as regulated by applicable laws. Note: In some areas, the servicer is required by law to return the defective parts. However, you do have the option of having the servicer dispose of these parts for you.

Disposal Notice: Should this product become damaged beyond repair, or for some reason its useful life is considered to be at an end, please observe all local, state, and federal regulations that relate to the disposal of products that contain lead, batteries, plastics, etc.

NOTICE: Service charges incurred due to lack of knowledge relating to how a function or effect works (when the unit is operating as designed) are not covered by the manufacturer’s warranty, and are therefore the owners responsibility. Please study this manual carefully and consult your dealer before requesting service.

NAME PLATE LOCATION: The graphic below indicates the location of the name plate. The model number, serial number, power requirements, etc., are located on this plate. You should record the model number, serial number, and the date of purchase in the spaces provided below and retain this manual as a permanent record of your purchase.

Model _____

Serial No. _____

Purchase Date _____

Introduction

Thank you for choosing a Yamaha Clavinova. Your Clavinova is a fine musical instrument that employs advanced Yamaha music technology. With the proper care, your Clavinova will give you many years of musical pleasure.

- AWM (Advanced Wave Memory) tone generator system offers a range of 60 rich, realistic voices.
- A maximum of 32-note polyphony permits use of sophisticated playing techniques.
- Piano-like touch response provides extensive expressive control and outstanding playability.
- Dual and split play modes allow 2 voices to be played simultaneously or individually with the left and right hands.
- 24 exciting accompaniment styles can be used to provide rhythm-only accompaniment or fully-orchestrated rhythm, bass, and chord accompaniment.
- Full-keyboard ABC (Auto Bass Chord) provides accompaniment as you play across the entire keyboard.
- 24 Solo Styleplay variations make it simple to produce rich, complex harmonies.
- Performance memory (2-track + ABC + Rhythm) records and plays back your keyboard performances.
- MIDI compatibility, GM voices, and a range of MIDI functions make the Clavinova useful in a range of advanced MIDI music systems.

In order to make the most of your Clavinova's performance potential and features, we urge you to read this Owner's Manual thoroughly, and keep it in a safe place for later reference.

Taking Care of Your Clavinova

Your Clavinova will give you years of playing pleasure if you observe the simple rules given below:

1. Avoid Humidity & Heat

Avoid placing the Clavinova in areas that are subject to excessive humidity or heat. Do not leave the instrument near heaters or in a car exposed to direct sunlight, for example.

2. Avoid Dust & Moisture

Avoid locations in which the instrument is likely to be exposed to excessive dust or moisture.

3. Power-off Before Connecting

Connections between the Clavinova and any other device must be made with both pieces of equipment turned off.

4. Handle With Care

Never apply excessive force to the controls, connectors or other parts of your Clavinova, and avoid scratching or bumping it with hard objects. Further, always turn the POWER switch off after use, and cover the instrument with the dust cover provided.

5. Clean Carefully

Clean the cabinet and keys of your Clavinova only with a clean, slightly damp cloth. A neutral cleanser may be used if desired. Never use abrasive cleansers, waxes, solvents or chemical dust cloths since these can dull or damage the finish.

6. Never Tamper With the Internal Circuitry

Never open the Clavinova cabinet and touch or tamper with the internal circuitry. Tampering with the circuitry can result in electrical shock!

7. Electric Interference

Since the Clavinova contains digital circuitry, it may cause interference if placed too close to radio or television receivers. If this occurs, move the instrument further away from the affected equipment.

8. Check Your Power Supply

Make sure that your local AC mains voltage matches the voltage specified on the name plate on the bottom panel. In some areas a voltage selector may be provided on the bottom panel of the main keyboard unit near the power cord. Make sure that the voltage selector is set for the voltage in your area. The voltage selector is set at 240V when the unit is initially shipped. To change the setting use a "minus" screwdriver to rotate the selector dial so that the correct voltage appears next to the pointer on the panel.

9. Name Plate Location

The Clavinova name plate, including the unit's serial number, is located on the bottom panel of the main unit.

Clavinova® CVP-49

Owner's Manual

English

Bedienungsanleitung

Deutsch

Mode d'emploi

Français

Manual de instrucciones

Español

Contents

The Panel Controls	2	Solo Styleplay	23
Preparation	4	<ul style="list-style-type: none"> ■ Using Solo Styleplay 23 ■ Harmonization Variations 23 ■ The Left Pedal & Solo Styleplay 23 	
The Volume Controls	5	Performance Memory	24
Demonstration Playback	6	<ul style="list-style-type: none"> Easy One-pass Recording & Playback 24 Multi-track Recording & Playback 25 ■ Adding New Tracks 26 ■ Playback 27 The Chord Sequence Function 28 	
Voice Selection	7	Utility Mode	29
<ul style="list-style-type: none"> ■ Selecting the 60 Voices 7 ■ Keyboard Percussion 8 		<ul style="list-style-type: none"> U1: Touch Sensitivity 29 U2: Accompaniment Volume Mode 29 	
Dual Mode	9	MIDI Functions	30
<ul style="list-style-type: none"> ■ Engaging the Dual Mode 9 ■ Dual-mode Voice Balance 9 		<ul style="list-style-type: none"> ■ Send and Receive Channel Select 30 ■ Local Control ON/OFF 31 ■ Program Change ON/OFF 31 ■ Control Change ON/OFF 31 ■ The Multi-Timbre Mode 32 ■ The Split Send Mode 32 ■ MIDI Clock Select 33 ■ Panel Data Send 33 ■ MIDI Transpose Transmit 33 ■ The Clavinova Common Voice Mode 33 ■ GM Multi-Timbre Mode 34 ■ Performance Memory Data Send 34 	
Split Mode	10	The Connectors	35
<ul style="list-style-type: none"> ■ Engaging the Split Mode 10 ■ Changing the Split Voices 10 ■ Changing the Split Point 10 ■ Split Balance 11 ■ Damper Pedal Operation in the Split Mode 11 		Troubleshooting	36
Digital Reverb Effects	12	Options	36
<ul style="list-style-type: none"> ■ Selecting a Reverb Effect 12 ■ Reverb Depth Control 12 		Index	37
The Keyboard & Polyphony	13		
Pan	13	Assembly	i
The Pedals	14	MIDI Data Format	vii
<ul style="list-style-type: none"> ■ Right Pedal (Damper Pedal) 14 ■ Left Pedal (Multi-function) 14 		Fingering Chart	xi
Transposition	15	Specifications	xii
Pitch Control	16	MIDI Implementation Chart	xiii
<ul style="list-style-type: none"> ■ The Pitch Display 16 			
Accompaniment	17		
<ul style="list-style-type: none"> ■ Style Selection 17 ■ Tempo Control 17 ■ Starting the Accompaniment 18 ■ Fill-ins 19 ■ Stopping the Accompaniment 19 ■ Metronome 19 			
Auto Bass Chord (ABC)	20		
<ul style="list-style-type: none"> ■ Single-finger Accompaniment 20 ■ Fingered Accompaniment 21 ■ Full-keyboard ABC 22 ■ Volume Control 22 ■ Changing the ABC Split Point 22 			

The Panel Controls

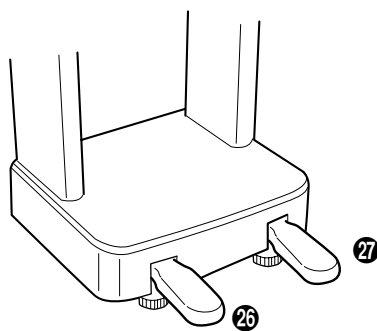
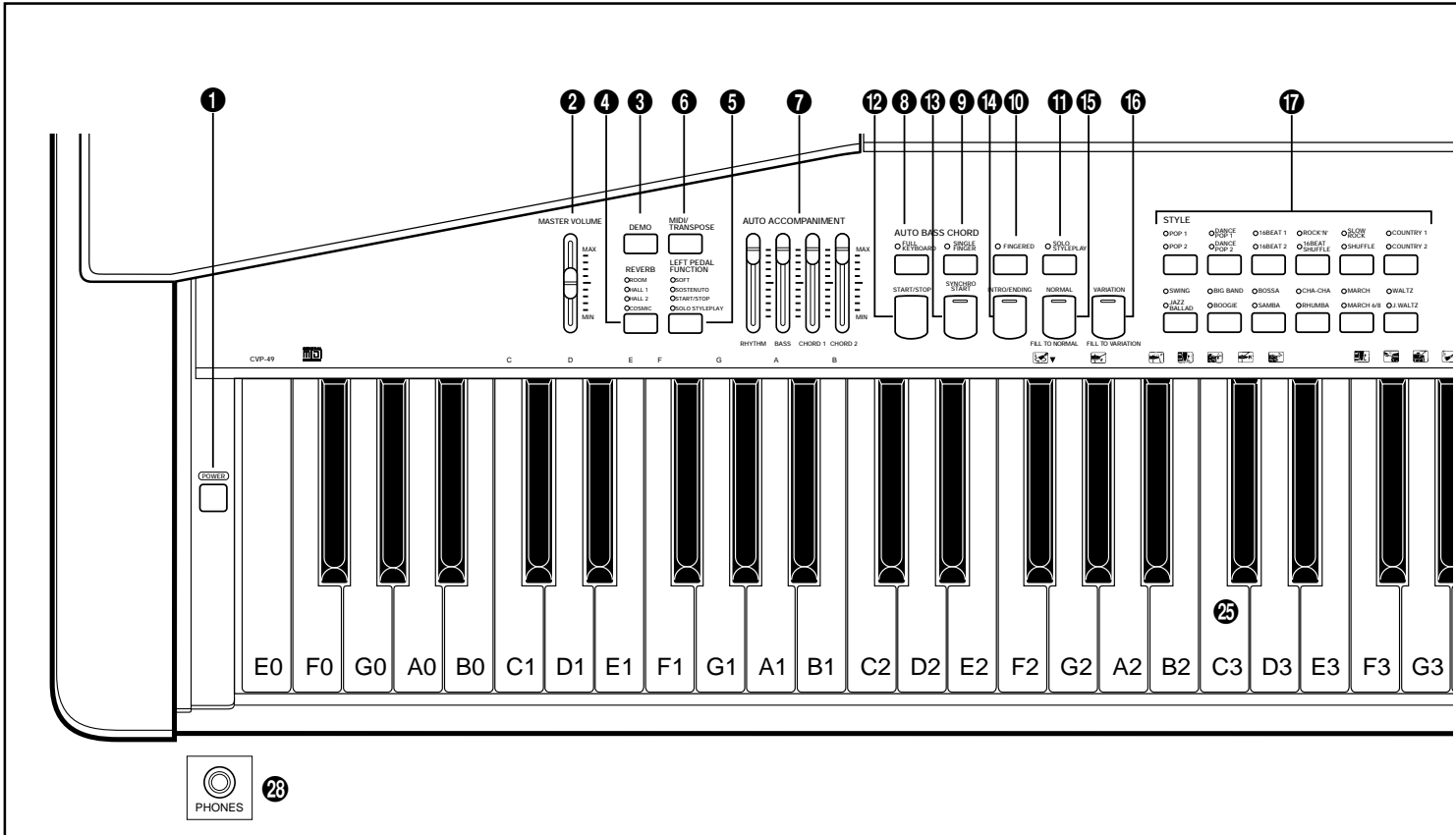
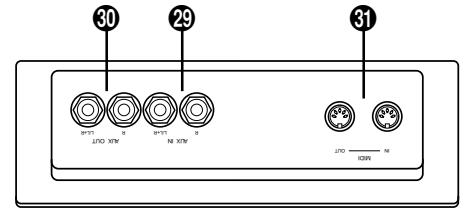

- ❶ POWER Switch page 4
- ❷ MASTER VOLUME Control page 5
- ❸ [DEMO] Button page 6
- ❹ [REVERB] Button page 12
- ❺ [LEFT PEDAL FUNCTION] Button page 14
- ❻ [MIDI/TRANPOSE] Button page 5, 13, 15, 29
- ❼ AUTO ACCOMPANIMENT Volume Controls page 5, 22
- ❽ AUTO BASS CHORD [FULL KEYBOARD] Button . page 22
- ❾ AUTO BASS CHORD [SINGLE FINGER] Button . page 20
- ❿ AUTO BASS CHORD [FINGERED] Button page 21
- ⓫ [SOLO STYLEPLAY] Button page 23

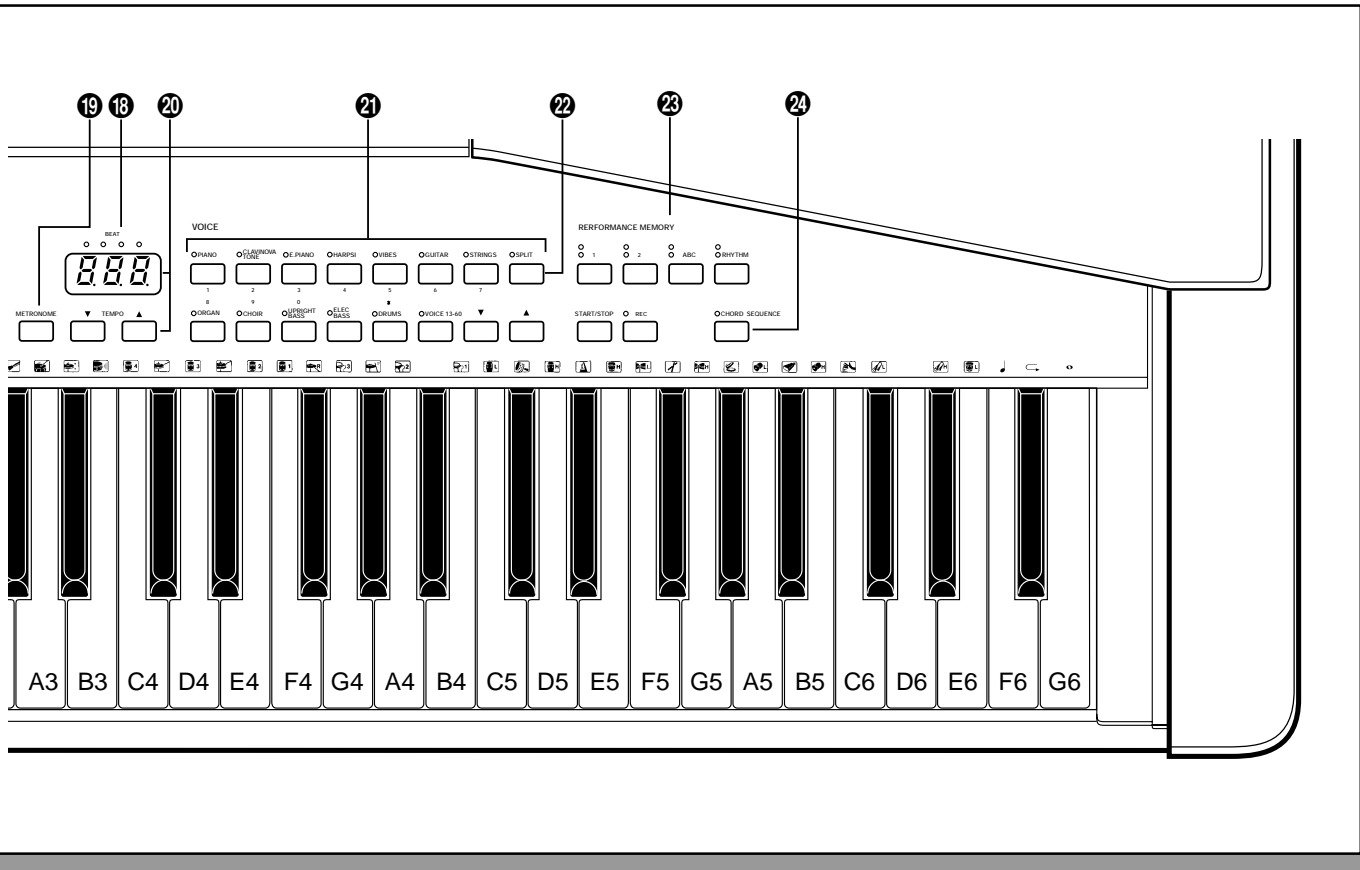

12 [START/STOP] Button page 18, 19	23 PERFORMANCE MEMORY Buttons page 24
13 [SYNCHRO START] Button page 18	24 [CHORD SEQUENCE] Button page 28
14 [INTRO/ENDING] Button page 18, 19	25 Keyboard page 13
15 [NORMAL/FILL TO NORMAL] Button page 18, 19	26 Soft Pedal page 14
16 [VARIATION/FILL TO VARIATION] Button page 18, 19	27 Damper Pedal page 14
17 STYLE Selectors page 17	28 PHONES Jack page 4
18 BEAT Display page 19	29 AUX IN R and L/L+R Jacks page 35
19 [METRONOME] Button page 19	30 AUX OUT R and L/L+R Jacks page 35
20 TEMPO Display and [▲] and [▼] Buttons page 17	31 MIDI Connectors page 35
21 VOICE Selectors page 7	
22 [SPLIT] Button page 10	

Preparation

■ The Music Stand

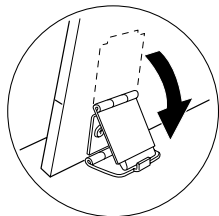
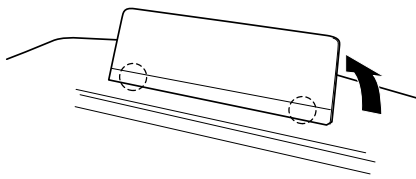

If you will be using sheet music with your Clavinova, raise the music stand built into its top panel by lifting the rear edge of the music stand, flip the support brackets on the rear of the music stand down so that they fit into the corresponding recesses.

The music stand can be lowered after slightly lifting the stand and flipping the two brackets which support it upward.

■ The Power Switch

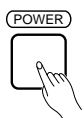

After making sure that the Clavinova's AC plug is properly inserted into a convenient AC wall outlet (a power-plug adaptor may be provided in some areas), press the **[POWER]** switch located to the left of the keyboard once to turn the power on. Press the **[POWER]** switch again to turn the power off.

When the power is initially turned on, the **PIANO** voice selector LED will light, the **POP 1** style selector LED will light, and "78" will appear on the **TEMPO** display.

■ Headphones

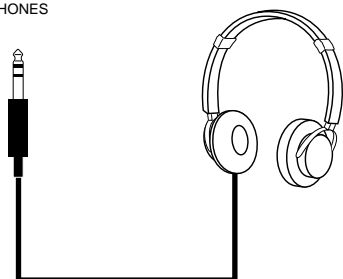

A standard pair of stereo headphones can be plugged in here for private practice or late-night playing. The internal speaker system is automatically shut off when a pair of headphones is plugged into the **PHONES** jack.

The Clavinova has several volume controls that give you extra versatility in creating the required sound.

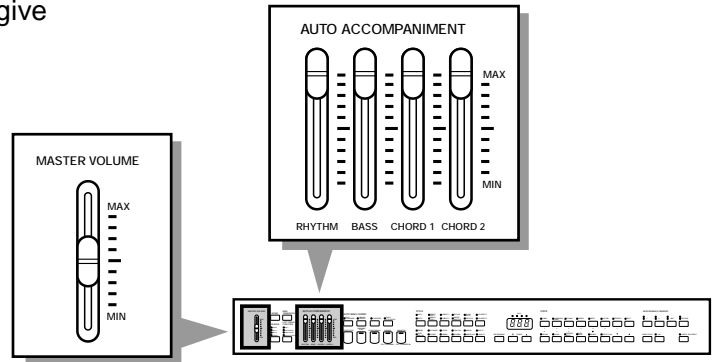

● Master Volume

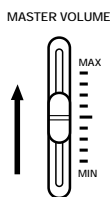

The **MASTER VOLUME** control adjusts the overall volume of sound produced by the Clavinova. It also adjusts headphone volume when a pair of headphones is plugged into the **PHONES** jack.

Initially set the **MASTER VOLUME** control about half way between the “MIN” and “MAX” settings. Then, when you start playing, adjust the control for the most comfortable listening level.

● Auto Accompaniment

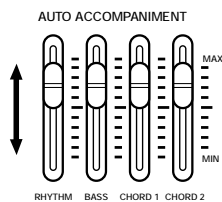

Separate volume controls are provided for the **RHYTHM**, **CHORD 1**, **CHORD 2**, and **BASS** sound. These volume controls let you set up the best balance between the various accompaniment parts when the **AUTO BASS CHORD (ABC)** and Performance Memory features are used, and the **RHYTHM** volume control can be used to balance the keyboard and rhythm sound when only rhythm accompaniment is used.

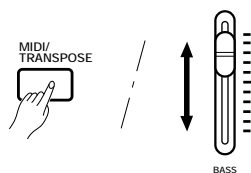

The volume of the keyboard can be independently adjusted by using the **BASS** control while holding the **[MIDI/TRANPOSE]** button — this is particularly handy for adjusting the balance when recording the Clavinova sound.

● Additional Volume Control Mode (Reverb Depth)

Using the “Auto Accompaniment Volume Mode” utility function (page 29), the Auto-Accompaniment volume controls can be assigned to control individual reverb depths for the rhythm, bass, chord 1, and chord 2 parts.



- If any or all of the Auto Accompaniment volume controls are set to their minimum positions, no sound will be produced by the corresponding parts. The maximum control positions produce the normal volume levels.

The Internal Amplifier & Speaker System

The CVP-49 features a powerful stereo amplifier delivering 30 watts per channel to a high-performance speaker system that puts out exceptionally rich sound with natural response from powerful lows to shimmering highs. The CVP-49 speaker systems employ two 13-centimeter speaker units for low-to-midrange reproduction, and two 5-centimeter speaker units for outstanding high-frequency sound.

Demonstration Playback

The Clavinova features 25 demonstration tunes that effectively demonstrate its sound and accompaniment capabilities. Here's how you can select and play the demo tunes.

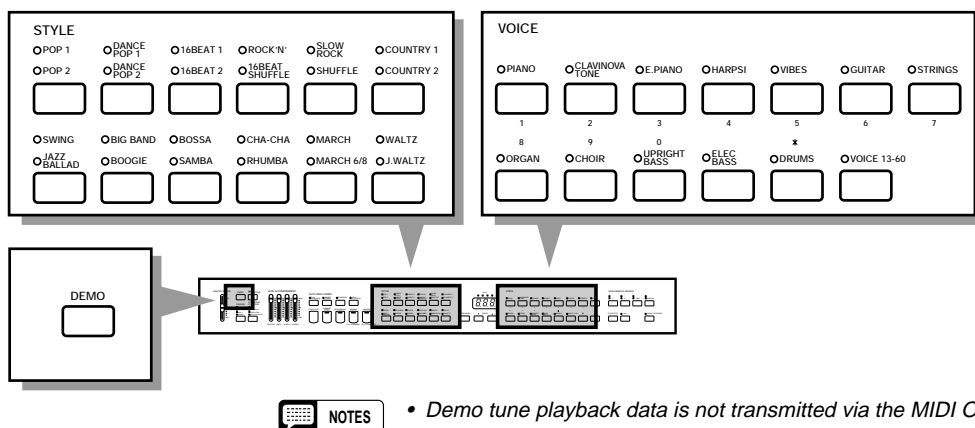

1 Press the [DEMO] button



2 Select a Demo Tune

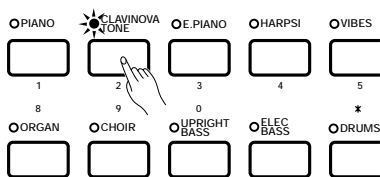

The 25 demo tunes are selected via the **STYLE** and **VOICE** selectors — the style and voice selectors will flash in sequence when the [DEMO] button is pressed. Press a selector to start playback of the corresponding tune. You can also select continuous repeat playback of all demo tunes by pressing the [START/STOP] button.

3 Adjust the Volume

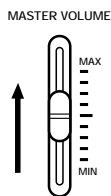

Use the **MASTER VOLUME** control to adjust the volume, and play along on the keyboard if you like.

NOTES • The tempo cannot be adjusted during demo playback.

4 Stop Playback



Demo playback can be stopped temporarily by pressing the [START/STOP] button. Press the [DEMO] button when you want to stop demo playback and return to the normal mode.

The Demo Tunes

VOICE NAME	COMPOSER	SONG TITLE
PIANO	F. F. Chopin	Etude Op.25-1 "Aeolian Harp" or "The Shepherd Boy"
CLAVINOVA TONE	D. Foster	"Water Fountain" from "The Secret of My Success"
HARPSICHORD	J. S. Bach	Italienisches Konzert (Italian Concerto) BWV 971 3rd movement
GUITAR	I. Albeniz	Asturias
STRINGS	A. Vivaldi	The Four Seasons No. 3 "Autumn" 1st movement
ORGAN	J. S. Bach	Sinfonia from Kantate (Cantata) 29 BWV 29
CHOIR	W. A. Mozart	Requiem K. 626 No. 6 "Lacrimosa"

* The demonstration pieces listed above are short excerpts from the original compositions. All other songs are original (© 1995 by Yamaha Corporation).

The CVP-49 has a total of 60 different voices that can be selected in a number of ways. There's also a "Keyboard Percussion" mode that let's you play a range of drums and percussion instruments on the keyboard.

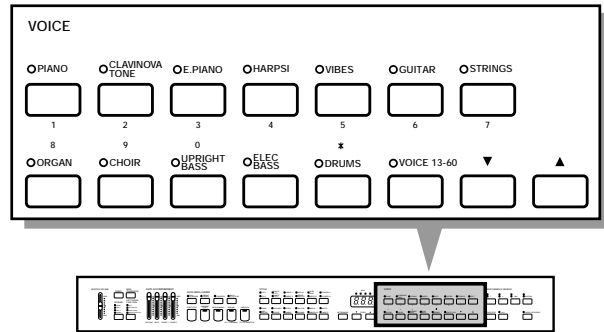

Selecting the 60 Voices

Voices 1-12: Direct Panel Selection

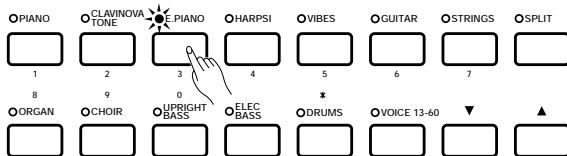

Of the Clavinova's 60 voices, 12 are "panel voices" which can be directly accessed by pressing the corresponding **VOICE** selector. When a voice selector is pressed the corresponding indicator will light and the number of the selected voice will appear on the **TEMPO** display while the voice selector is held.

The PIANO voice is automatically selected when the power is initially turned on.

The VOICE 13-60 [▲] and [▼] Buttons

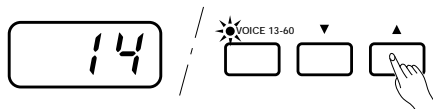

Use the [▲] and [▼] buttons immediately to the right of the [VOICE 13-60] button to select a voice number between 13 and 60. Press either button briefly to select the next voice number in the specified direction, or hold the button for continuous scrolling in the specified direction. The [VOICE 13-60] indicator will light and the voice number will appear on the **TEMPO** display during selection.

If a panel voice (1-12) is selected, the last selected voice in the 13-60 range can be instantly re-selected simply by pressing the [VOICE 13-60] button. The [VOICE 13-60] button will initially select voice number 13 (BRASS) after the power is turned on.



- Voice number 13 can be instantly selected by pressing the [▲] and [▼] buttons simultaneously.

Numeric Selection

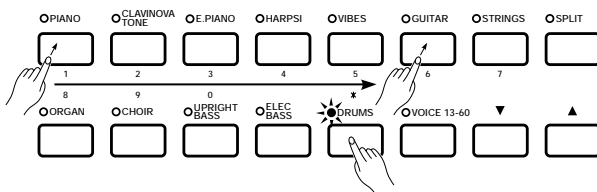

Enter the number of the desired voice via the voice selectors (note that each voice selector has a number between 1 and 0 associated with it) while pressing the [DRUMS] selector.

To select voice number 16, for example, press and hold [DRUMS], press [PIANO/1], then [GUITAR/6], then release the [DRUMS] button. The voice number will appear on the **TEMPO** display while the [DRUMS] button is held. The [VOICE 13-60] button indicator will light whenever a voice number between 13 and 60 is selected.

Panel Voices (1 — 12)

No.	Name	Usable Range
1	PIANO	E0 - G6
2	CLAVINOVA TONE	C1 - G6
3	E. PIANO	C1 - C6
4	HARPSI	C1 - C6
5	VIBES	F2 - F5
6	GUITAR	E1 - F#4
7	STRINGS	E0 - C6
8	ORGAN	E0 - C6
9	CHOIR	E1 - E5
10	UPRIGHT BASS	E0 - F#3
11	ELEC BASS	E0 - F#3
12	DRUMS	—

Voices 13 — 60

No.	Name	Usable Range
13	BRASS	F0 - C6
14	POP BRASS	F0 - C6
15	TRUMPET	F0 - C6
16	MUTE TRUMPET	F#2 - A5
17	HORN	A#0 - F4
18	SAX	A#0 - F#5

No.	Name	Usable Range
19	SAX SOFT	A#0 - F#5
20	CLARINET	D2 - A#5
21	OBOE	A#2 - G5
22	FLUTE	G2 - F#6
23	ACCORDION	F2 - A5
24	HARMONICA	C3 - C6
25	STRINGS SOFT	E0 - C6
26	VIOLIN	E0 - C6
27	VIOLIN HARD	E0 - C6
28	FULL ORGAN	E0 - C6
29	JAZZ ORGAN 1	C1 - C6
30	SYNTH BRASS	C1 - C6
31	SYNTH WOOD	C2 - F#6
32	SYNTH STRINGS	E0 - C6
33	SYNTH CHOIR	E1 - E5
34	PIANO BRIGHT	E0 - G6
35	PIANO SOFT	E0 - G6
36	E. PIANO DX	C1 - C6
37	SYNTH CRYSTAL	C2 - C6
38	CELESTA	C2 - C6
39	MARIMBA	C2 - C6

No.	Name	Usable Range
40	FOLK GUITAR	E1 - A4
41	JAZZ GUITAR 1	E1 - A4
42	JAZZ GUITAR 2	E1 - A4
43	ROCK GUITAR 1	E1 - A4
44	ROCK GUITAR 2	E1 - A4
45	MUTE GUITAR	E1 - A4
46	BANJO	C3 - A5
47	PIZZICATO	C1 - C6
48	HARP	C1 - C6
49	U. BASS SOFT	E0 - F#3
50	E. BASS SOFT	E0 - F#3
51	E. BASS HEAVY	E0 - F#3
52	SYNTH BASS	E0 - F#3
53	TIMPANI & ORCH. HIT	E0 - C2/G2 - C6
54	BASSOON	A#0 - D4
55	CHAMBER STRINGS	C1 - C6
56	JAZZ ORGAN 2	C1 - C6
57	ROCK GUITAR 3	E1 - A4
58	COSMIC 1	G0 - C6
59	COSMIC 2	G0 - C6
60	COSMIC 3	G0 - C6



NOTES

- When the **DRUMS** voice is selected only the keys with drum or percussion symbols printed above them will sound.
- The **PIANO** voice is automatically selected when the power is initially turned on.

Keyboard Percussion



When the [**DRUMS**] voice selector is pressed (its indicator will light), you can play 41 different drum and percussion instruments on the keyboard. The percussion instruments played by the various keys are marked by symbols above the keys (keys with no symbols produce no sound).



NOTES

- The **TRANSPOSE** and **PITCH** functions described on pages 15 and 16 do not affect the **DRUMS** sound.

Drum & Percussion Key Assignments

Key	Instrument
F#2	BRUSH ROLL
G#2	HI-HAT CLOSED HEAVY
A#2	CRASH CYMBAL LIGHT
B2	BASS DRUM LIGHT
C3	SNARE DRUM + RIM HEAVY
C#3	RIDE CYMBAL CUP
D3	SNARE DRUM + RIM LIGHT
F3	BASS DRUM NORMAL
F#3	RIM SHOT
G3	SNARE DRUM HEAVY
G#3	BRUSH SHOT
A3	SNARE DRUM LIGHT
A#3	HI-HAT PEDAL
B3	SNARE DRUM ECHO

Key	Instrument
C4	TOM 4
C#4	HI-HAT CLOSED NORMAL
D4	TOM 3
D#4	HI-HAT OPEN
E4	TOM 2
F4	TOM 1
F#4	RIDE CYMBAL NORMAL
G4	ELECTRIC TOM 3
G#4	CRASH CYMBAL NORMAL
A4	ELECTRIC TOM 2
(A#4)	(CRASH CYMBAL)
B4	ELECTRIC TOM 1
C5	CONGA LOW
C#5	CABASA

Key	Instrument
D5	CONGA HIGH
D#5	METRONOME
E5	BONGO HIGH
F5	TIMBALE LOW
F#5	CLAVES
G5	TIMBALE HIGH
G#5	CASTANETS
A5	CUICA LOW
A#5	COWBELL
B5	CUICA HIGH
C6	HAND CLAP
C#6	AGOGO LOW
D#6	AGOGO HIGH
E6	BONGO LOW

- **HI-HAT OPEN (D#4)** is muted by **HI-HAT CLOSED HEAVY (G#2)**, **HI-HAT CLOSED NORMAL (C#4)** and **HI-HAT PEDAL (A#3)**.
- **BRUSH ROLL (F#2)** is muted by **BRUSH SHOT (G#3)**.

- The instruments listed in parentheses () will not sound when played on the keyboard, but can be recorded using the Performance Memory (page 24) and will sound on playback. These instruments can also be played via MIDI.

The DUAL mode makes it possible to play two voices simultaneously across the entire range of the keyboard. This makes it easy to create exceptionally rich, thick tonal textures.

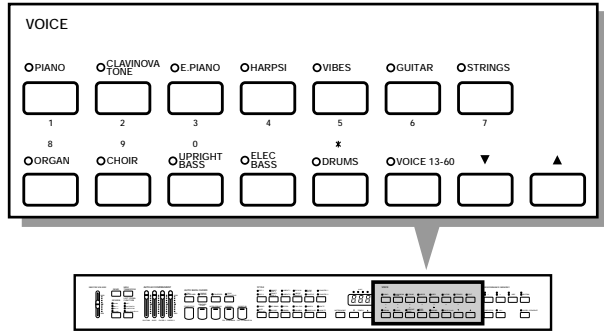

Engaging the Dual Mode

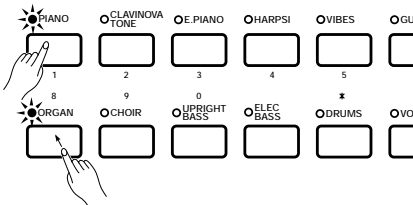

To engage the DUAL mode simply press two voice selectors at the same time — or press one voice selector while holding another. A voice in the 13...60 range can be “dual-ed” with the panel voices by pressing the [VOICE 13-60] button and any other voice selector at the same time (two voices in the 13...60 range cannot be combined). The [▲] and [▼] buttons can then be used to select the desired 13...60 voice. The higher voice number will appear on the TEMPO display during selection.

The voice indicators of both selected voices will light when the DUAL mode is active. To return to the normal single-voice play mode, press any single voice selector.

Dual-mode Voice Balance

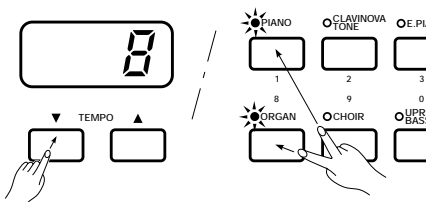

The volume balance between the two voices combined in the DUAL mode can be adjusted by using the TEMPO [▲] and [▼] buttons while pressing both of the active voice selectors. The selected balance value (1 ... 15) will be shown on the TEMPO display while the voice selectors and TEMPO [▲] or [▼] buttons are held.

- A setting of “1” sets the volume of the lowest-numbered voice to maximum and the highest-numbered voice to minimum (no sound).
- A setting of “8” sets both voices to the same volume (this is the default balance setting, and can be recalled by pressing the TEMPO [▲] and [▼] buttons simultaneously).
- A setting of “15” sets the volume of the highest-numbered voice to maximum and the lowest-numbered voice to minimum (no sound).

NOTES

- Hold either the TEMPO [▲] or [▼] button for continuous scrolling in the specified direction.
- The dual mode cannot be used when the DRUMS voice is selected. Also, the dual and split modes cannot be used at the same time.

The split mode lets you play different voices with the left and right hands — bass with the left and piano with the right, for example. You can assign any of the Clavinova's voices to the left and right-hand sections of the keyboard.

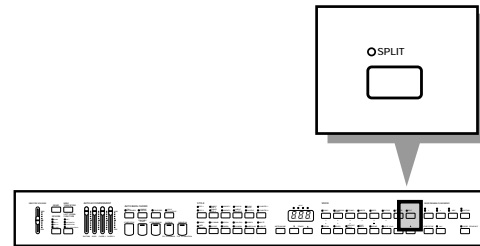

Engaging the Split Mode

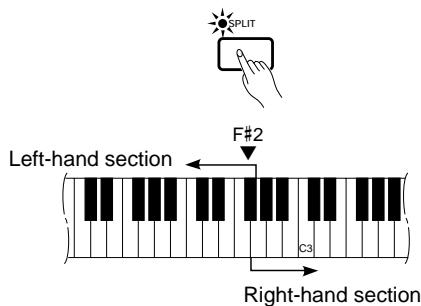

When the [SPLIT] button is pressed and its indicator lights, the keyboard is split into left- and right-hand sections and different voices can be assigned to each. The split point is initially set at the F#2 key when the power is turned on, and the UPRIGHT BASS voice is initially assigned to the left-hand section of the keyboard (all keys up to and including F#2). The voice that was selected when the SPLIT mode was engaged is assigned to the right-hand section of the keyboard. The current settings are retained if the SPLIT mode is turned off (press the [SPLIT] button again) and on while the power remains on.

Changing the Split Voices

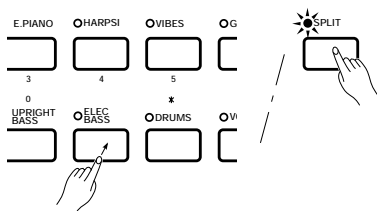

The right-hand voice can be changed simply by pressing the appropriate voice selector.

The left-hand voice can be changed by pressing a voice selector while holding the [SPLIT] button.



- All voices except BASS (voice numbers 10, 11, 49, 50, 51, and 52) and DRUMS (voice number 12) are shifted up one octave when assigned to the lower section of the keyboard.

Changing the Split Point

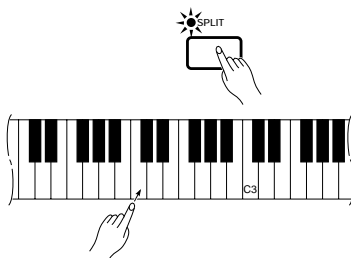

The split point can be set at any key by pressing the desired key while holding the [SPLIT] button. The split point key name will appear on the TEMPO display while the [SPLIT] button is held.

Example: $\left[\begin{array}{c} \text{C} \\ \text{C2} \end{array} \right] \quad \left[\begin{array}{c} \text{C} \\ \text{C\#2} \end{array} \right]$

The default split point — F#2 — will always be set automatically whenever the power is initially turned on.

Split Balance

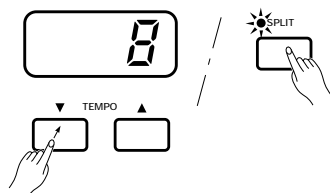

The volume balance between the left-hand and right-hand voices can be adjusted by using the **TEMPO** [▲] and [▼] buttons while holding the [**SPLIT**] button. The selected balance value (1 ... 15) will be shown on the TEMPO display while the [**SPLIT**] and **TEMPO** [▲] or [▼] buttons are held.

- A setting of “1” sets the volume of the left voice to maximum and the right voice to minimum (no sound).
- A setting of “8” sets both voices to the same volume (this is the default balance setting, and can be recalled by pressing the **TEMPO** [▲] and [▼] buttons simultaneously).
- A setting of “15” sets the volume of the right voice to maximum and the left voice to minimum (no sound).



NOTES

- Hold either the **TEMPO** [▲] or [▼] button for continuous scrolling in the specified direction.

Damper Pedal Operation in the Split Mode

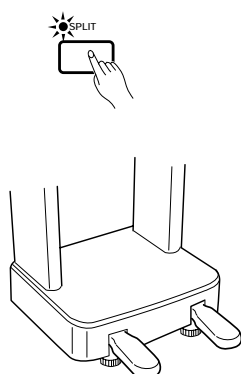

The damper pedal (the right pedal — see “The Pedals” on page 14) can be assigned to the left voice only, the right voice only, or to both voices in the split mode.

- **Right Voice Only (default):** Press the right (damper) pedal while holding the [**SPLIT**] button.
- **Left Voice Only:** Press the left (soft) pedal while holding the [**SPLIT**] button.
- **Both Voices:** Press both the right and left pedals while holding the [**SPLIT**] button.



NOTES

- The dual and split modes cannot be used at the same time.
- In the split the soft and sostenuto pedal functions apply to both the left- and right-hand voices.
- When the ABC Single Finger mode (page 20) and the split mode are used simultaneously, the left-hand voice will be accompanied by the appropriate ABC chord voices.

The [REVERB] button provides a number of digital effects that you can use for extra depth and expressive power.

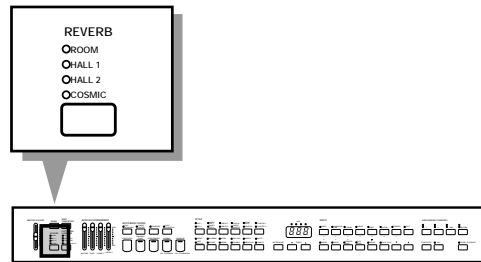

Selecting a Reverb Effect

Each time the [REVERB] button is pressed the next effect on the reverb “list” is selected and the corresponding indicator will light. No effect is selected when no indicator is lit.



OFF (No indicator lit)

No effect is produced.

ROOM

This setting adds a reverb effect to the sound that is similar to the type of acoustic reverberation you would hear in a medium-size room.

HALL 1

For a more spacious reverb sound, use the HALL 1 setting. This effect simulates the natural reverberation of a medium-size concert hall.

HALL 2

HALL 2 simulates the reverb of a very large concert hall.

COSMIC

“COSMIC” is an echo effect in which the sound seems to “bounce” around in the stereo sound field.



- The ROOM effect is automatically selected when the POWER switch is turned on.

Reverb Depth Control

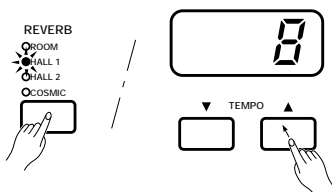

The depth of the selected reverb effect can be increased or decreased by pressing the TEMPO [▲] or [▼] button while holding the [REVERB] button. The reverb depth is shown on the TEMPO display while the [REVERB] and [▲] or [▼] buttons are held. The reverb depth range is from “0” (no effect) to “15” (maximum depth).



- Reverb depth is initially set to “8” when the power is turned on (this setting can be recalled during reverb depth selection by pressing the TEMPO [▲] and [▼] buttons simultaneously).
- Hold either the TEMPO [▲] or [▼] button for continuous scrolling in the specified direction.

The Clavinova has “32-note polyphony” which means you can normally play up to 32 notes at once. This number varies, however, according to the functions being used, as shown in the chart below:

Keyboard only	32 notes.
Keyboard only (dual)	16 notes.
Keyboard + rhythm	24 notes (rhythm uses 8).
Keyboard (dual) + rhythm	12 notes
Keyboard + ABC	12 notes (rhythm 8; ABC 12).
Keyboard (dual) + ABC	6 notes

The following voices are 2-layer:

- No. 31 SYNTH WOOD
- No. 56 JAZZ ORGAN 2
- No. 58 COSMIC 1
- No. 60 COSMIC 3

- The number of available notes is further reduced if the dual mode or the performance memory is being played at the same time. Further variation occurs with “1-layer” and “2-layer” voices: the polyphony is halved with 2-layer voices.

The Clavinova also offers keyboard touch response, so the volume and timbre of notes played can be controlled according to how “hard” you play the keys. The amount of variation available depends on the selected voice.

Pan

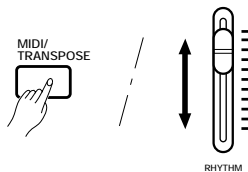

The pan settings are as follows:

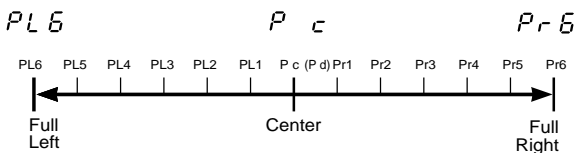

- The pan (stereo) position of the voice played on the keyboard can be adjusted by moving the **RHYTHM** volume control while holding the [MIDI/TRANSPOSE] button. The pan position is shown on the **TEMPO** display, from “PL 6” for full left at the “MIN” control position, through “P c” for center, to “Pr 6” for full right at the “MAX” control position. This can be used to produce a broader ensemble sound with the Performance Memory multitrack recording feature.

Each voice has a preset pan setting (indicated by “P d” on the **TEMPO** display) which is automatically set when the power is first turned on.

NOTES

- The “P d” keyboard scale pan default for some voices places the treble-register sound to the right and the bass-register sound to the left. Using a different PAN setting places the entire voice, low and high notes included, at the same position.
- The DRUMS voice has a preset PAN setting which cannot be changed.

The CVP-49 has two pedals. These offer a range of advanced expressive capabilities.

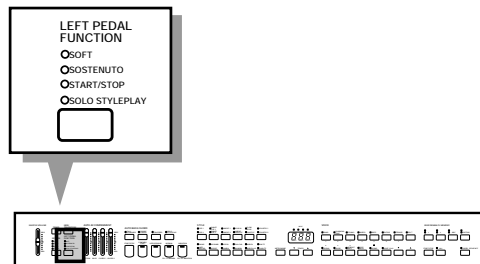
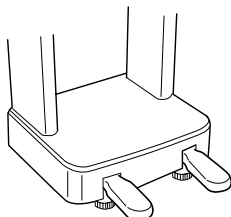

Right Pedal (Damper Pedal)

The damper pedal functions in the same way as a damper pedal on an acoustic piano. When the damper pedal is pressed notes played have a long sustain. Releasing the pedal immediately stops (damps) any sustained notes.

Left Pedal (Multi-function)



The left pedal has a number of functions which can be selected using the [LEFT PEDAL FUNCTION] button and indicators. Each time the [LEFT PEDAL FUNCTION] button is pressed the next function on the LEFT PEDAL function “list” is selected and the corresponding indicator will light.

● Soft

Pressing the soft pedal subtly reduces the volume and slightly changes the timbre of notes played. The **SOFT** function is automatically selected whenever the **POWER** switch is turned on.

● Sostenuto

If you play a note or chord on the keyboard and press the sostenuto pedal while the note(s) are held, those notes will be sustained as long as the pedal is held (as if the damper pedal had been pressed) but all subsequently played notes will not be sustained. This makes it possible to sustain a chord, for example, while other notes are played “staccato.”

The left-pedal **SOSTENUTO** function cannot be selected while the **SOLO STYLEPLAY** feature is operating.

● Start/Stop

The left pedal performs the same function as the panel [START/STOP] buttons. For details on the **START/STOP** function, refer to the “Accompaniment” section on page 18, 19.

● Solo Styleplay

For details on the **SOLO STYLEPLAY** function see “SOLO STYLEPLAY” on page 23 (the **SOLO STYLEPLAY** pedal function can only be selected when the **SOLO STYLEPLAY** feature is in use).



• The damper, soft, and sostenuto pedal functions do not affect the **DRUMS** voice.

The Clavinova's TRANSPOSE function makes it possible to shift the pitch of the entire keyboard up or down in semitone intervals up to a maximum of six semitones. "Transposing" the pitch of the Clavinova keyboard makes it easier to play in difficult key signatures, and you can simply match the pitch of the keyboard to the range of a singer or other instrumentalist.

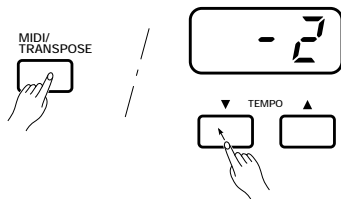
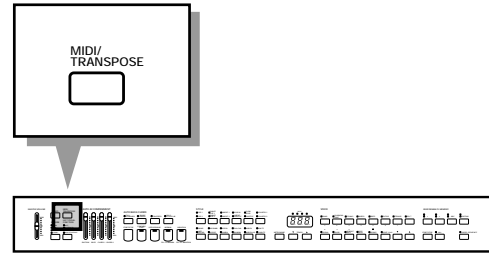

Display	Transposition
-6	-6 semitones
-5	-5 semitones
-4	-4 semitones
-3	-3 semitones
-2	-2 semitones
-1	-1 semitone
0	Normal
1	+1 semitone
2	+2 semitones
3	+3 semitones
4	+4 semitones
5	+5 semitones
6	+6 semitones

- Use the **TEMPO** [▲] and [▼] buttons to select the desired degree of transposition while holding the [MIDI/TRANSPOSE] button. The amount of transposition selected is shown on the **TEMPO** display as follows:

NOTES

- Press the [▲] and [▼] buttons simultaneously while holding the [MIDI/TRANSPOSE] button to restore normal keyboard pitch.
- Transpose is always set to Normal when the power is turned on.
- The TRANSPOSE function does not affect the DRUMS sound.
- Hold either the TEMPO [▲] or [▼] button for continuous scrolling in the specified direction.
- Notes below and above the A-1 — C7 of the Clavinova sound one octave higher and lower, respectively.

Pitch control makes it possible to tune the Clavinova over a ± 50 -cent range (approximate) in approximately 1.2-cent or 1-hertz intervals. A hundred "cents" equals one semitone, so the tuning range provided allows fine tuning of overall pitch over a range of approximately a semitone. Pitch control is useful for tuning the Clavinova to match other instruments or recorded music.

● Tuning Up

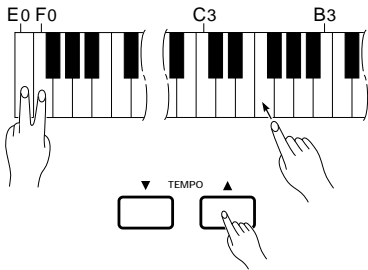

1 To tune up (raise pitch), hold the **E0** and **F0** keys simultaneously (E0 and F0 are the two lowest white keys on the keyboard) and press any key between **C3** and **B3**. Each time a key in this range is pressed the pitch is raised by approximately 1.2 cents, up to a maximum of about 50 cents above standard pitch. To raise the pitch in 1-hertz increments press the **TEMPO [▲]** button instead of the **C3-B3** keys. The **TEMPO [▼]** button can also be used to tune down while the **E0** and **F0** keys are held.

2 Release the **E0** and **F0** keys.

● Tuning Down

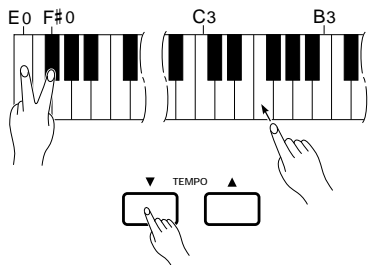

1 To tune down (lower pitch), hold the **E0** and **F#0** keys simultaneously and press any key between **C3** and **B3**. Each time a key in this range is pressed the pitch is lowered by approximately 1.2 cents, up to a maximum of about 50 cents below standard pitch. To lower the pitch in 1-hertz increments press the **TEMPO [▼]** button instead of the **C3-B3** keys. The **TEMPO [▲]** button can also be used to tune up while the **E0** and **F#0** keys are held.

2 Release the **E0** and **F#0** keys.

● To Restore Standard Pitch*

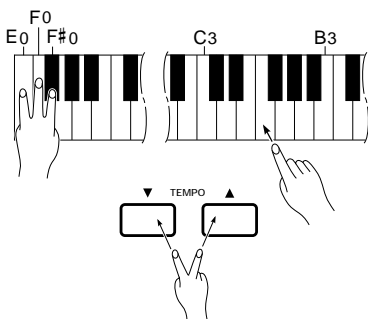

1 To restore standard pitch (A3 = 440 Hz), hold the **E0**, **F0**, and **F#0** keys simultaneously and press any key between **C3** and **B3**, or simultaneously press the **TEMPO [▲]** and **[▼]** buttons.

2 Release the **E0**, **F0**, and **F#0** keys.

* Standard pitch (A3 = 440 Hz) is automatically set whenever the **POWER** switch is initially turned on.



- The **PITCH** function does not affect the **DRUMS** sound.
- Hold either the **TEMPO [▲]** or **[▼]** button for continuous scrolling in the specified direction.

■ The Pitch Display

Example:

442 442.0 442.24
 4.42 442.25 442.49
 44.2 442.5 442.74
 442. 442.75 442.99

The approximate pitch of A3 is shown on the TEMPO display in Hertz while the pitch control function is in operation. The total display range is from approximately 427 hertz (-50 cents) to 453 hertz (+50 cents).

The dots to the right of each figure in the display are used to provide a general idea of fractional pitches.

The CVP-49 has 24 “styles” that can be used as a basis for rhythm accompaniment, or fully orchestrated rhythm, bass, and chord accompaniment (see “Auto Bass Chord” on page 20).



• The Accompaniment Style data is not transmitted via the MIDI OUT connector.

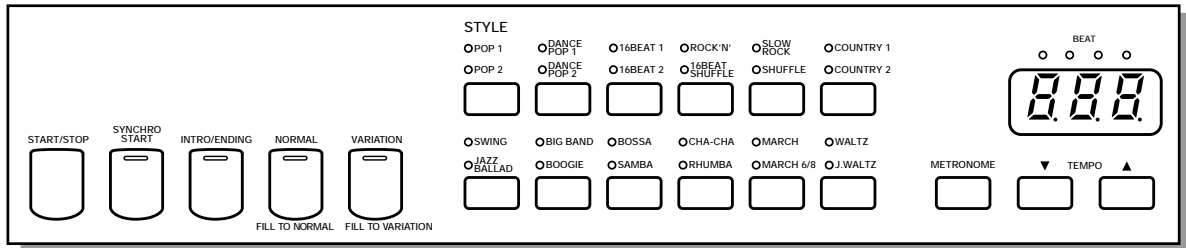

Style Selection

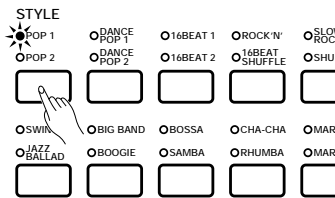

The 24 styles are selected using 12 **STYLE** selectors. Note that each style selector has two indicators and style names above it. These two styles are selected alternately each time the selector is pressed.

The **POP 1** style is automatically selected when the power is initially turned on.



• Use the **RHYTHM** volume control to adjust the volume of the rhythm sound.

Tempo Control

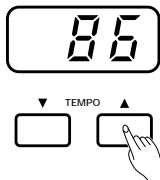

Whenever you select a different style, the “suggested” tempo for that style is also selected, and the tempo is displayed on the **TEMPO** display in quarter-note beats per minute (unless the accompaniment is playing, in which case the same tempo is maintained).

You can change the tempo to any value between 32 and 280 beats per minute, however, by using the **TEMPO** [▲] and [▼] buttons. This can be done either before the accompaniment is started or while it is playing. Press either button briefly to decrement or increment the tempo value by one, or hold the button for continuous decrementing or incrementing.



• The suggested tempo for the selected style can be recalled at any time by pressing both the [▲] and [▼] buttons simultaneously.

Suggested Tempos

Style	Suggested Tempo	Style	Suggested Tempo
POP 1	78	SWING	160
POP 2	98	JAZZ BALLAD	80
DANCE POP 1	138	BIG BAND	152
DANCE POP 2	94	BOOGIE	160
16BEAT 1	78	BOSSA	132
16BEAT 2	98	SAMBA	112
ROCK'N'	160	CHA-CHA	132
16BEAT SHUFFLE	90	RHUMBA	112
SLOW ROCK	72	MARCH	120
SHUFFLE	144	MARCH 6/8	116
COUNTRY 1	184	WALTZ	90
COUNTRY 2	138	J.WALTZ	160

Starting the Accompaniment

There are several ways to start the accompaniment:



- If any Performance Memory track button's green indicator (i.e. [1], [2], [ABC] or [RHYTHM] buttons) is lit, the following start procedure will start playback of the Performance Memory data. To start playback of the panel accompaniment, press the corresponding track buttons so their green indicators go out.
However, the panel accompaniment will be played back instead of the [RHYTHM] track data, even if any Performance Memory track button's green indicator (i.e. [1], [2], [ABC] or [RHYTHM] buttons) is lit, under the following conditions:
* if any of the panel STYLE selectors have been pressed to re-select the style, or
* if the start procedure is executed by the Intro or Fill start (both direct and Synchro) — see below.

● Straight Start



Press the [START/STOP] button.

Each of the styles also has a variation that can be selected by pressing the [VARIATION/FILL TO VARIATION] button (its LED will light) before pressing the [START/STOP] button. Normally the [NORMAL/FILL TO NORMAL] button LED will be lit (or you can select it if the variation is selected), indicating that the normal pattern is selected.

Normal straight start = [NORMAL/FILL TO NORMAL] → [START/STOP]

Variation straight start = [VARIATION/FILL TO VARIATION] → [START/STOP]

● Start With an Introduction



Press the [INTRO/ENDING] button.

If you press the [NORMAL/FILL TO NORMAL] or [VARIATION/FILL TO VARIATION] button while holding the [INTRO/ENDING] button, the rhythm will start with an appropriate fill and then go to the normal rhythm or variation rhythm, respectively.

Intro start = [INTRO/ENDING] (Flashing) → [START/STOP]

Fill start to normal = [INTRO/ENDING] (Flashing) + [NORMAL/FILL TO NORMAL] → [START/STOP]

Fill start to variation = [INTRO/ENDING] (Flashing) + [VARIATION/FILL TO VARIATION] → [START/STOP]

The selected start mode can be disengaged prior to starting the accompaniment by pressing the selected button (flashing indicator) a second time.

● Synchronized Start



Any of the start types described above can be synchronized to the first note or chord played on the keyboard by first pressing the [SYNCHRO START] button so that its indicator lights. When the keyboard is split or Auto Bass Chord Single Finger or Fingered mode is used, the first note played on the left-hand section of the keyboard will start the accompaniment (i.e. keys to the left of and including the split-point key — normally F#2). Once the synchronized start mode has been selected, use the [NORMAL/FILL TO NORMAL], [VARIATION/FILL TO VARIATION] and/or [INTRO/ENDING] buttons to select the type of start you want.

The first dot of the BEAT display will flash at the current tempo when a synchronized start mode has been selected.

After pressing [SYNCHRO START]

Normal start = [NORMAL/FILL TO NORMAL] → Play key

Variation start = [VARIATION/FILL TO VARIATION] → Play key

Intro start = [INTRO/ENDING] → Play key

Fill start to normal = [INTRO/ENDING] + [NORMAL/FILL TO NORMAL] → Play key

Fill start to variation = [INTRO/ENDING] + [VARIATION/FILL TO VARIATION] → Play key

The synchronized start mode can be cancelled by pressing the [SYNCHRO START] button a second time so that its indicator goes out.



- The synchronized start mode is automatically turned on when one of the ABC modes is engaged — see page 20 for details.

● Measure Number



During rhythm playback the current measure number is shown on the TEMPO display.

● The Beat Display

	BEAT			
1st. Beat	●	○	○	○
2nd. Beat	○	●	○	○
3rd. Beat	○	○	●	○
4th. Beat	○	○	○	●

The four LED dots of the **BEAT** display provide a visual indication of the selected tempo. The leftmost (red) dot flashes on the first beat of each measure, the second dot flashes on the second beat, and so on (all dots except the leftmost dot are green). When a 3/4-time rhythm is selected, only the first three dots will flash.

■ Fill-ins

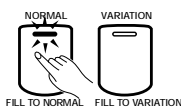

The CVP-49 provides two types of automatic “fill-ins.”

- **Fill To Normal:** Press the [NORMAL/FILL TO NORMAL] button during playback to produce a fill-in and go to the normal rhythm.
- **Fill To Variation:** Press the [VARIATION/FILL TO VARIATION] button during playback to produce a fill-in and go to the variation pattern.

If you hold one of the **FILL** buttons, the fill-in will repeat until the end of the measure in which button is released.

■ Stopping the Accompaniment

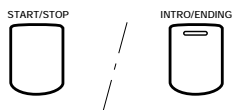

The accompaniment can be stopped at any time by pressing the [START/STOP] button. Press the [INTRO/ENDING] button if you want to go to the ending pattern and then stop.



- If you started with an intro or fill-in, or using the SYNCHRO mode, these selections are maintained even after the accompaniment is stopped.
- If the left pedal is switched to START/STOP operation, it performs the same function as the panel [START/STOP] buttons (press to START, press again to STOP).

■ Metronome



The CVP-49 also offers a metronome function that is ideal for practice.

To start the metronome, simply press the [METRONOME] button. The metronome will play at the currently selected tempo whether a style is playing or not. The metronome volume can be adjusted via the **RHYTHM** volume control.

Press the [METRONOME] button again to stop the metronome sound. The metronome will also stop automatically if the [START/STOP] button is pressed to stop a style in progress.



- The metronome will not normally sound when a style is playing. If the style is started by pressing the [START/STOP] button while the metronome is playing, however, the metronome will continue to sound along with the style.

Auto Bass Chord (ABC)

The CVP-49 includes a sophisticated auto-accompaniment system (Auto Bass Chord — ABC) that can provide automated rhythm, bass and chord backing in a number of ways.

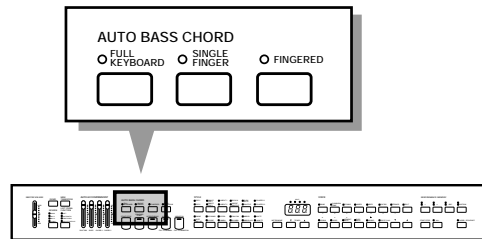

Single-finger Accompaniment

SINGLE FINGER accompaniment makes it simple to produce accompaniment using major, seventh, minor and minor-seventh chords by pressing a minimum number of keys in the ABC section of the keyboard. The automatic accompaniment consists of rhythm, bass and chords.

1 Select SINGLE FINGER



Press the [**SINGLE FINGER**] button to select the **SINGLE FINGER** mode (the **SINGLE FINGER** indicator will light).

2 Select a Style

Select the desired accompaniment using the style selectors (see “Style Selection” on page 17).

3 Set the Tempo

Use the **TEMPO** [**▲**] and [**▼**] buttons to set the desired accompaniment tempo if necessary (see “Tempo Control” on page 17).

4 Play

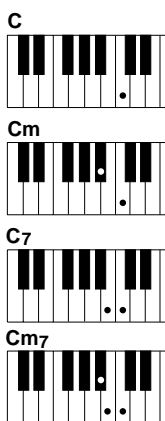

Pressing any key on the ABC section of the keyboard (up to the split point — normally the F#2 key) will cause the automatic chord and bass accompaniment to begin (synchro start is automatically selected in the ABC mode). If you press a “C” key, for example, a C-major accompaniment will be played. Press another key in the ABC section of the keyboard to select a new chord. The key you press will always determine the “root” of the chord played (i.e. “C” for a C chord).

● Playing Minor, Seventh, and Minor-seventh Chords in the Single-finger Mode

- For a minor chord, press the root key and a black key to its left.
- For a seventh chord, press the root key and a white key to its left.
- For a minor-seventh chord, press the root key and both a white and black key to its left.

5 Stop the Accompaniment

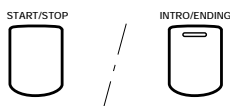

Press the [**START/STOP**] or [**INTRO/ENDING**] button to stop the accompaniment.



- Press the [**SINGLE FINGER**] button so that its indicator goes out when you want to exit from the **SINGLE FINGER** mode.

■ Fingered Accompaniment

The **FINGERED** mode is ideal if you already know how to play chords on a keyboard, since it allows you to supply your own chords for the Auto Accompaniment feature.

1 Select FINGERED



Press the **[FINGERED]** button to select the **FINGERED** mode (the **FINGERED** indicator will light).

2 Select a Style

Select an accompaniment style using the style selectors (see “Style Selection” on page 17).

3 Set the Tempo

Use the **TEMPO** [**▲**] and [**▼**] buttons to set the desired accompaniment tempo if necessary (see “Tempo Control” on page 17 for more details).

4 Play

As soon as you play any chord (up to 4 notes) on the lower keyboard (up to the split point — normally the F#2 key), the Clavinova will automatically begin to play the chord along with the selected rhythm and an appropriate bass line (synchro start is automatically selected in the ABC mode).

The Clavinova will accept the following chord 20 types:

- Major [M]
- Minor [m]
- Major seventh [M7]
- Sixth [6]
- Seventh [7]
- Minor sixth [m6]
- Minor seventh [m7]
- Minor major seventh [mM7]
- Minor seventh flatted fifth [m7b5]
- Minor flatted fifth [mb5]
- Major flatted fifth [b5]
- Seventh flatted fifth [7b5]
- Major seventh flatted fifth [M7b5]
- Seventh suspended fourth [7sus4]
- Suspended fourth [sus4]
- Augmented [aug]
- Seventh sharp fifth [7#5]
- Major seventh sharp fifth [M7#5]
- Diminished [dim]
- Half diminished (minor major seventh flatted fifth) [mM7b5]



- The automatic accompaniment will sometimes not change when related chords are played in sequence (e.g. some minor chords followed by the minor seventh).

- The **[INTRO/ENDING]**, **[NORMAL/FILL TO NORMAL]**, and **[VARIATION/FILL TO VARIATION]** buttons can be used in the ABC mode to create pattern variations in the same way that they are used with rhythm patterns (refer to the “Accompaniment” section on page 18, 19 for details).

Normal start = **[NORMAL/FILL TO NORMAL]** → Lower key
 Variation start = **[VARIATION/FILL TO VARIATION]** → Lower key
 Intro start = **[INTRO/ENDING]** → Lower key
 Fill start to normal = **[INTRO/ENDING]** + **[NORMAL/FILL TO NORMAL]** → Lower key
 Fill start to variation = **[INTRO/ENDING]** + **[VARIATION/FILL TO VARIATION]** → Lower key

5 Stop the Accompaniment

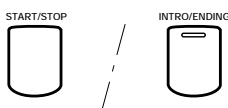

Press the **[START/STOP]** or **[INTRO/ENDING]** button to stop the accompaniment.



- Press the **[FINGERED]** button so that its indicator goes out when you want to exit from the **FINGERED** mode.

Full-keyboard ABC

● Full-keyboard ABC

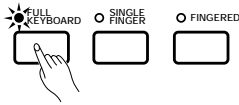

When this advanced auto-accompaniment mode is engaged (press the **[FULL KEYBOARD]** button so that its indicator lights) the Clavinova will automatically create appropriate accompaniment while you play just about anything, anywhere on the keyboard: chords, a bass line, arpeggiated chords, a melody line. You don't have to worry about specifying the accompaniment chords. Although Full-keyboard ABC is designed to work with many songs, some arrangements may not be suitable for use with this feature. Try playing a few simple songs in the Full-keyboard ABC mode to get a feel for its capabilities.



- Chord detection occurs at approximately 8th-note intervals. Extremely short chords — less than an 8th note in length — may therefore not be detected.

● Conventional Full-keyboard ABC

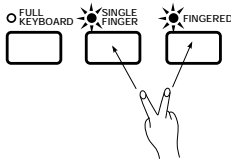

The Conventional Full-keyboard ABC mode can be engaged by pressing the **[SINGLE FINGER]** and **[FINGERED]** buttons simultaneously (both indicators will light). In this mode the split point is de-activated and notes played anywhere on the keyboard are detected and used to determine the harmonization of the accompaniment. In the Conventional Full-keyboard ABC mode, chord detection is possible when at least three notes are played anywhere on the keyboard.



- The Dual or SPLIT mode can be used with Full-keyboard ABC.
- The Full-keyboard and Conventional Full-keyboard ABC modes will be disengaged and the Fingered mode will be engaged if Solo Styleplay is turned on.
- Solo Styleplay will automatically be turned off whenever the Full-keyboard or Conventional Full-keyboard ABC mode is engaged.
- Press the **[FULL KEYBOARD]** button so that its indicator goes out when you want to exit from the FULL-KEYBOARD ABC mode. To exit from the Conventional Full-keyboard ABC mode press the **[SINGLE FINGER]** or **[FINGERED]** button twice.

Volume Control

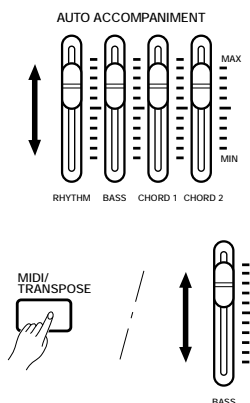

The **RHYTHM**, **CHORD 1**, **CHORD 2**, and **BASS** volume controls can be used to adjust the volume of the corresponding accompaniment parts when using ABC. In general, **CHORD 1** controls rhythmic chords while **CHORD 2** controls more decorative chords (arpeggios, etc.). The volume of the keyboard can be independently controlled by using the **BASS** volume control while holding the **[MIDI/TRANPOSE]** button.



- Some styles may not use all four parts: RHYTHM, CHORD 1, CHORD 2, and BASS.
- Usually the CHORD 1 and CHORD 2 parts will not play simultaneously in the Full-keyboard ABC mode to prevent possible conflict with the melody. The sound of the silent part can be restored by changing the setting of the corresponding volume control — CHORD 1 or CHORD 2.

Changing the ABC Split Point

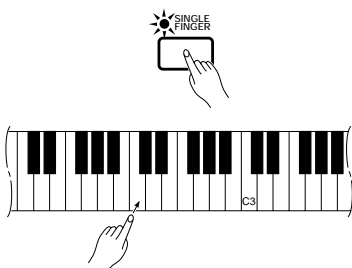

The ABC split point can be set at any key by pressing the desired key while holding the **[SINGLE FINGER]** or **[FINGERED]** button.

The default split point — F#2 — will always be set automatically whenever the power is initially turned on.

This sophisticated feature not only provides automatic rhythm, bass and chord accompaniment, but it also adds appropriate harmony notes (two or three harmonized notes) to a melody you play on the upper keyboard.

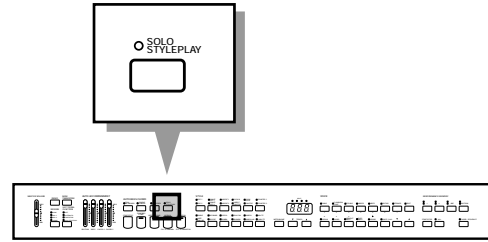

Using Solo Styleplay

1 Turn Solo Styleplay ON



Press the [SOLO STYLEPLAY] button to turn the SOLO STYLEPLAY mode on. The SINGLE FINGER mode is automatically selected when SOLO STYLEPLAY is turned on, unless the FINGERED mode is already selected. If a FULL KEYBOARD mode is selected, the FINGERED mode will automatically be selected since Solo Styleplay cannot be used with the FULL KEYBOARD modes.

2 Select a Style

Select an accompaniment style using the style selectors (see “Style Selection” on page 17). An appropriate voice for the selected style will automatically be selected, but you can also select any other voice after selecting the style.

3 Set the Tempo

Set the desired tempo if necessary using the TEMPO [▲] and [▼] buttons (see “Tempo Control” on page 17).

4 Play

Play the required chords (SINGLE FINGER or FINGERED) on the ABC section of the keyboard while playing a melody line on the upper keyboard (for some styles, only one note can be played at a time on the right-hand section of the keyboard in the Solo Styleplay mode).

5 Stop the Accompaniment

Press [START/STOP] or [INTRO/ENDING] to stop the accompaniment.

6 Turn Solo Styleplay OFF

Press the [SOLO STYLEPLAY] button again to turn the function off.

Harmonization Variations

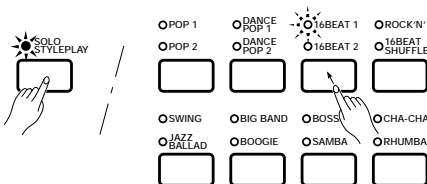

It is possible to apply the harmonization type and voice from a different style to the selected style by pressing the style selector corresponding to the harmonization type you want to use while holding the [SOLO STYLEPLAY] button — the selected STYLE button indicator will flash while the [SOLO STYLEPLAY] button is held. This makes it possible, for example, to use the solo styleplay harmonization type and voice from the 16 BEAT 1 style when actually playing in the POP 1 style.

The Left Pedal & Solo Styleplay



If the LEFT PEDAL FUNCTION is set to SOLO STYLEPLAY after the SOLO STYLEPLAY mode is selected, harmonization of notes played on the right-hand section of the keyboard only occurs while the left pedal is pressed. This allows you to combine normal ABC type performance with SOLO STYLEPLAY as required.

The left pedal SOSTENUTO function can not be selected while SOLO STYLEPLAY is on.



- The SOLO STYLEPLAY mode will be disengaged if the ABC FINGERED or SINGLE FINGER mode is turned off or the FULL KEYBOARD ABC mode is turned on.

The CVP-49 features a built-in “sequencer” which can be used to independently record up to three separate parts of a single musical composition, plus a rhythm track. Each part is recorded on one of the Performance Memory “tracks” accessed via the [1], [2], [ABC], and [RHYTHM] buttons.

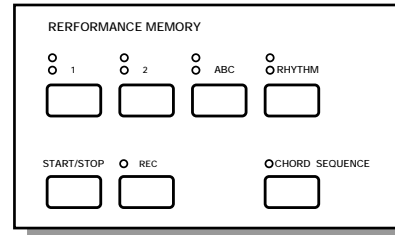

- The Performance Memory playback data is not transmitted via the MIDI OUT connector.



Easy One-pass Recording & Playback

1 Select a Voice

Use the **VOICE** selectors to select the voice you want to record with. You can try out the selected voice on the keyboard before proceeding.

2 Engage the Record Ready Mode

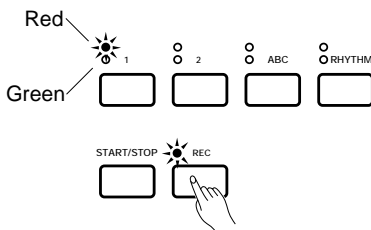

Press the **[REC]** button so that its indicator lights. The red **[1]** indicator should also light at this point, indicating that you are ready to record on track 1.



- You can record up to a maximum of about 8,000 notes (110 kilobytes) depending on pedal usage and other factors. The **[REC]** button indicator will begin to flash when the recorder memory is almost full (“FUL” will appear on the **TEMPO** display) and recording will stop automatically.
- The amount of remaining memory is displayed in kilobytes (approximate) when the **[REC]** button is released.

3 Start Recording

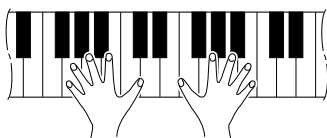

Play on the keyboard. Recording will begin automatically as soon as you start playing.



- You can turn the metronome on before or during recording (the metronome sound will not be recorded).

4 Stop Recording

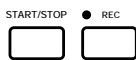

Stop recording by pressing the **[START/STOP]** button or the **[REC]** button. When recording has finished the green indicator of the recorded track will light, indicating that the track is ready for playback.

5 Play Back the Recording



Press the **[START/STOP]** button to play back your recording. Play along on the keyboard if you like. You can also change the playback tempo via the **TEMPO [▲]** and **[▼]** buttons.

6 Stop Playback

Playback will stop automatically when the end of the recording is reached, or you can press the **[START/STOP]** button to stop it at anytime.

Multi-track Recording & Playback

1 Set All Performance Features As Required

Set up all necessary performance features as required: voice, voice mode (normal, dual, or split), style, tempo, left pedal function, etc. Try out the features as you select them to check that you have the right overall sound.

2 Engage the Record Ready Mode

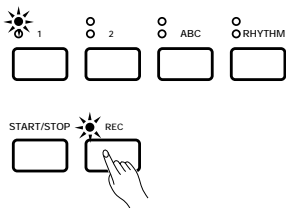

Press the [REC] button so that its indicator lights. The red [1] indicator should also light at this point, indicating that you are ready to record on track 1. As soon as you release the [REC] button the first dot of the beat indicator will begin to flash at the currently set tempo.



- Be careful not to start recording prematurely by either playing the keyboard or pressing the [START/STOP] button before you've completed the following steps.

3 Select the Track(s) to Record

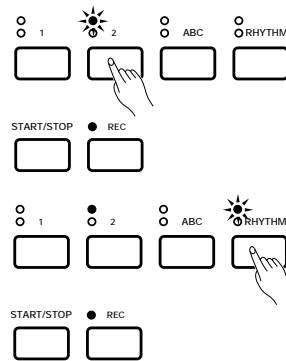

Keyboard parts can only be recorded on one track at a time. If you press [1] you will record on track number 1. If you press [2] you will record on track number 2. When a record track has been selected the corresponding red indicator will light.

● Recording with Rhythm

To record a rhythm in addition to the part you play on the keyboard, select the desired style via the STYLE selectors and press the [RHYTHM] button so that its red indicator lights.

If you only want to record the rhythm track, de-select all other selected tracks by pressing their buttons so that their red indicators go out.

If you select the rhythm track for recording, or the rhythm track already contains data, the metronome will sound at the current tempo.

● Recording with ABC

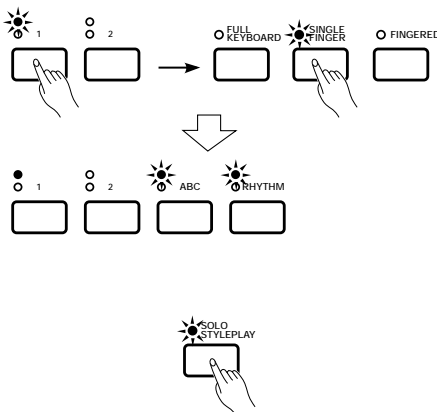

To record using ABC, press either the [1] or [2] button and then engage an ABC mode, or press the [ABC] button. The red [ABC] and [RHYTHM] indicators will light automatically in addition to the [1] or [2] indicator, and the ABC sound will be recorded on ABC track while what you play on the keyboard will be recorded on track 1 or 2.

If you only want to record the ABC sound, de-select track 1 or 2 by pressing the appropriate button so that the indicator goes out. In the same way, de-select the [RHYTHM] track if you don't want to record the rhythm sound.

● Recording with Solo Styleplay

Solo Styleplay can be recorded at the same time as SINGLE FINGER or FINGERED ABC, but not at the same time as FULL KEYBOARD mode ABC.

4 Start Recording

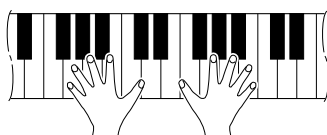

The synchronized start mode is automatically selected when the record ready mode is engaged, so recording will begin automatically as soon as any key on the keyboard is pressed or the [START/STOP] button is pressed (see page 18 for the various synchro start modes). The current measure number is shown on the TEMPO display as you record.

The following parameters will be recorded in addition to notes you play:

Parameters recorded for Each Track

- Voice*
- Dual Voice*
- Split Voice*
- Volume* (Not changeable during recording)
- Pan*
- Damper Pedal*
- Soft Pedal*
- Sostenuto Pedal (Not recorded as an initial setting)
- Reverb Depth* (Not recorded as an initial setting)
- Dual Balance*
- Split Balance*

Parameters Recorded for the Entire Song

- Style
- Rhythm Volume*
- Reverb Type*
- Reverb Depth*
- Tempo*
- Intro Mode (Not changeable during recording)
- Ending Mode (Not recorded as an initial setting)
- Fill-in
- ABC Mode (Not changeable during recording)
- ABC Volume*
- Solo Styleplay Mode (Not changeable during recording)
- Solo Styleplay Variation (Not changeable during recording)

Parameters Recorded for Each Track via MIDI Only

- Pitch Bend Sensitivity (Not recorded as an initial setting)
- Coarse Tune (Not recorded as an initial setting)
- Fine Tune (Not recorded as an initial setting)

5 Stop Recording



Press the [REC] button a second time, or the [START/STOP] button to stop recording.

Adding New Tracks

When you've finished recording the first track, you can simply play it back as described in the previous section or add a new track to your song. To record a new track:

1 Select a Voice

Select a voice and other parameters for the new track. Try out the voice and selected parameters before proceeding.

2 Engage the Record Ready Mode

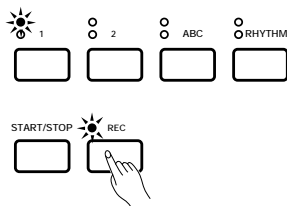

Press the [REC] button to engage the record ready mode.

Monitoring Previously Recorded Tracks

You can turn the playback of all previously recorded tracks on or off as required by pressing the corresponding track button(s) before pressing the [REC] button.

3 Select a Track

Select a track other than the one you used to record the previous track. The red indicator of the track selected for recording should light.



Remember that if you record on a track that has already been recorded, the previous material will be erased and the new material will be recorded in its place.

4 Start Recording

Play on the keyboard or press the [START/STOP] button to start recording.

5 Stop Recording

Press the [START/STOP] button or the [REC] button to stop recording.

Changing the Initial Parameter Values

The initial values of parameters marked with asterisks (*) in the lists given above can be changed for each track or the entire song by engaging the record mode for the desired track, changing the parameters as required, and then disengaging the record mode (press the [REC] button again) without actually recording. To cancel any initial parameter values you've made, select a different track and then press the [REC] button to disengage the record mode.

To change individual ABC part volume settings engage any ABC mode after turning [REC] on, set the RHYTHM, CHORD 1, CHORD 2, and/or BASS volume control as required, then disengage the record mode.

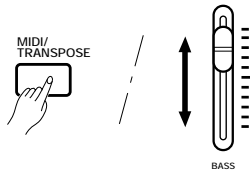

Volume of track 1 or 2

The **BASS** volume control can be used while holding the **[MIDI/TRANSPOSE]** button to independently adjust the volume of track 1 or 2. The volume of the rhythm track is adjusted via the **RHYTHM** volume control. Please note that volume settings can only be decreased.

Individual track reverb depth can be adjusted by using the **BASS** volume while holding the **[REVERB]** button, and the overall reverb depth can be adjusted by using the **TEMPO [▲]** and **[▼]** buttons while holding the **[REVERB]** button.

Also note that the tempo, reverb type, style, style variation, fill-in, and intro/ending settings are common to all tracks and cannot be set independently for different tracks.

● Erasing the Tracks

Individual tracks — except the rhythm track — can be completely erased by starting and stopping recording without actually playing or changing any parameters (i.e. press the **[START/STOP]** button twice). The same procedure can be used to erase the rhythm track if the **RHYTHM** volume control is set to its minimum position.

Another way to erase data in individual tracks is to stop recording within two beats of starting. In this case, any recorded data will be ignored and any previous data will be erased for the selected track.



- All data in all tracks can be simultaneously erased by turning the power on while holding the rightmost (G6) key on the keyboard.

■ Playback



Start playback by pressing either the **PERFORMANCE MEMORY [START/STOP]** button or the **ABC [START/STOP]** button. The song will play through to the end and playback will stop automatically. The current measure number will be shown on the **TEMPO** display during playback.

Playback can be stopped at any time by pressing the **PERFORMANCE MEMORY** or **ABC [START/STOP]** button.



- The playback voice cannot be changed when playing back Performance Memory data (the voice played via the keyboard can be changed).
- All Performance Memory data will be retained in memory for about one week after the power is turned off. If you want to keep your recorded data for longer periods, turn the power on for a few minutes at least once a week. It is also possible to store it to an external MIDI storage device such as the Yamaha DOU-10 Disk Orchestra Unit by using the Performance Memory Data Send function described on page 34.
- The track indicators will not light automatically when the power is turned on even if the Performance Memory contains data. It is therefore necessary to press the track buttons so that the corresponding green indicators light before starting Performance Memory playback. It is also a good idea to press the track buttons to check if the tracks contain data before recording (do this before pressing the **[REC]** button). If the green indicator lights when the corresponding track button is pressed, that track contains data which will be erased and replaced by the newly-recorded data.
- If the green indicator of the data-containing track is not lit (i.e. playback is turned off) before the record ready mode is engaged, the track will remain off even after the record ready mode is engaged. The data-containing track indicator is automatically lit only when the record ready mode is engaged for the first time after the power is turned on (before any track buttons are pressed).
- If the metronome is being used during playback, the metronome will stop when playback is stopped.

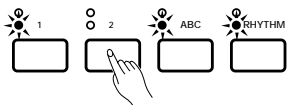

● Playing Back only Specific Parts

The **[1]**, **[2]**, **[ABC]**, and **[RHYTHM]** buttons can be used to select playback of specific parts. When a part is on, the corresponding green indicator lights.

● Volume Control

The **RHYTHM**, **BASS**, **CHORD 1**, and **CHORD 2** volume controls can be used to adjust the volume of the corresponding accompaniment parts when playing back data that was recorded with **ABC**.

When playing back data that was recorded without **ABC**, however, these volume controls have the following track assignments.

- RHYTHM:** RHYTHM track
- BASS:** No assignment
- CHORD 1:** No assignment
- CHORD 2:** 1 & 2 tracks

The Chord Sequence Function

The **CHORD SEQUENCE** function provides a convenient way to enter chord sequences and style changes one at a time.

1 Engage the Chord Sequence Function

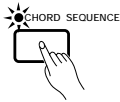

Press the [**CHORD SEQUENCE**] button. The red [**ABC**] and [**RHYTHM**] track button indicators will light, and the **ABC FINGERED** mode will be automatically selected — switch to the **SINGLE FINGER** mode if you prefer. If the **SINGLE FINGER** mode was already selected it will remain engaged.



- The chord sequence data will replace any previous ABC data.
- Up to 200 measures can be recorded using the Chord Sequence function.

2 Enter the Chords and/or Style Changes

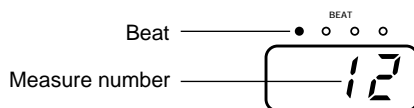
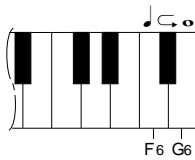

Make the required style changes (style number, normal/variation, fill-in, intro/ending, and tempo, as necessary), play and hold a chord on the left-hand section of the keyboard, and press the [**♪**] key (look for the “♪” symbol above the F6 key) or the [**◻**] key (G6) to enter the chord for a quarter note or whole note, respectively. You can move one beat backward by pressing the [**◀**] key (F#6).

Continue entering chords in this manner until your sequence is complete.



- The number of the measure to be entered is shown on the **TEMPO** display, while the beat to be entered is shown on the **BEAT** display.
- If no chords are entered, the result will be a rhythm-only sequence.

3 Stop Recording

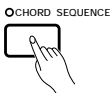

When all the required chords and style changes have been entered, press the [**CHORD SEQUENCE**] button to stop recording.



- The chord sequence data now resides in Performance Memory **ABC** and **RHYTHM** tracks, and can be played back in the normal way. Add melody tracks 1 and 2 as required.

1 Select a Utility Function

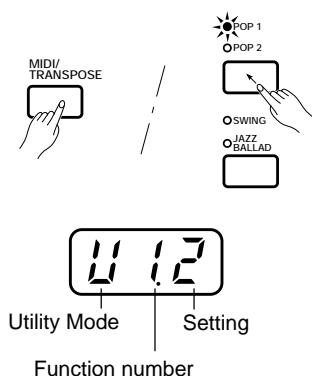

Use the [POP 1/POP 2] and [SWING/JAZZ BALLAD] style selectors while holding the [MIDI/TRANSCOPE] button. The [POP 1/POP 2] style selector increments the utility function number each time it is pressed, and the [SWING/JAZZ BALLAD] button decrements the utility function number.

The Utility Mode functions are indicated on the **TEMPO** display by a tall “U” in the leftmost digit position. The number of the function is displayed by the center digit (“1” or “2”), and the current setting is shown by the right digit.

The [MIDI/TRANSCOPE] button must be held until after you’ve set the function, below.



- You can cancel the selected function at this point and exit from the utility mode simply by releasing the [MIDI/TRANSCOPE] button.

2 Set as Required

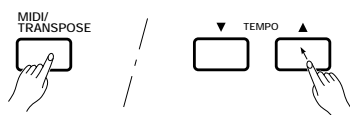

Use the **TEMPO** [▲] and [▼] buttons while still holding the [MIDI/TRANSCOPE] button to select the required setting (the available settings for each utility function are listed below).

3 Release the [MIDI/TRANSCOPE] Button to Exit

Release the [MIDI/TRANSCOPE] button to exit from the Utility Mode when you’ve finished making the required settings.

U 1: Touch Sensitivity

The Clavinova can be set to one of three different types of keyboard touch sensitivity to match different playing styles and preferences.

- 1: Soft. Allows maximum loudness to be produced with relatively light key pressure.
- 2: Medium. Produces a fairly “standard” keyboard response.
- 3: Hard. Requires the keys to be played quite hard to produce maximum loudness.



- The MEDIUM setting (2) is automatically selected whenever the POWER switch is turned on.

U 2: Accompaniment Volume Mode

Normally the Auto Accompaniment volume controls are used to adjust the volume of the Rhythm, Chord 1, Chord 2, and Bass accompaniment parts, as labelled on the Clavinova panel. This function can be used to assign these volume controls to other operations.

- 1: Volume for the Rhythm, Chord 1, Chord 2, and Bass tracks. This applies when playing with the ABC mode engaged or when playing back performance memory data that was recorded with ABC. When playing back performance memory data that was recorded without ABC, the Chord 2 control corresponds to tracks 1 and 2, the Chord 1 and Bass controls are not assigned.
- 2: Reverb depth for the Rhythm, Chord 1, Chord 2, and Bass tracks. This applies when playing with the ABC mode engaged or when playing back performance memory data that was recorded with ABC. When playing back performance memory data that was recorded without ABC, the Chord 2 control corresponds to tracks 1 and 2, the Chord 1 and Bass controls are not assigned.



- The Rhythm, Chord 1, Chord 2, and Bass volume setting (1) is automatically selected whenever the POWER switch is turned on.
- 1 can be recorded and their initial values can be changed as described on page 26.
- 2 applies only to playback.

MIDI, the Musical Instrument Digital Interface, is a world-standard communication interface that allows MIDI-compatible musical instruments and equipment to share musical information and control one another. This makes it possible to create “systems” of MIDI instruments and equipment that offer far greater versatility and control than is available with isolated instruments.

The Clavinova has 13 MIDI functions that are accessed by pressing the appropriate VOICE selector while holding the [MIDI/TRANSCOPE] button. The MIDI functions accessed by the various VOICE selectors are shown in the following chart:

Function	Selector
1. Send Channel Select	PIANO
2. Receive Channel Select	CLAVINOVA TONE
3. Local ON/OFF	E. PIANO
4. Program Change ON/OFF	HARPSI
5. Control Change ON/OFF	VIBES
6. Multi-Timbre Mode ON/OFF	GUITAR
7. Split Send Mode	STRINGS
8. MIDI Clock Select	ORGAN
9. Panel Data Transmit	CHOIR
10. MIDI Transpose Transmit	UPRIGHT BASS
11. Clavinova Common Voice Mode ON/OFF	ELEC BASS
12. GM Multi-Timbre Mode	DRUMS
13. Performance Memory Data Send	VOICE 13-60

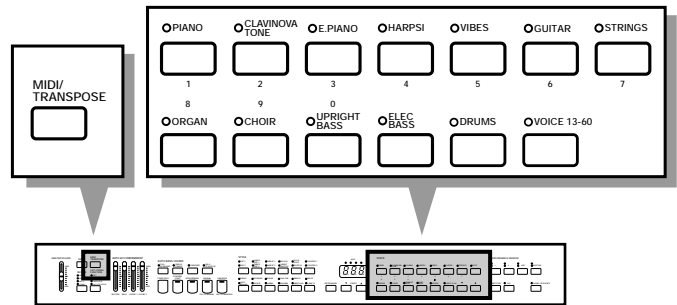

The available settings and procedure for each MIDI function are described below.



NOTES

- Always use a high-quality MIDI cable to connect MIDI OUT to MIDI IN terminals. Never use MIDI cables longer than about 15 meters, since cables longer than this can pick up noise which can cause data errors.
- When using the Clavinova with other MIDI equipment, always refer to the MIDI specifications (implementation chart and MIDI data format) of the equipment used to ensure compatibility.

Send and Receive Channel Select

In any MIDI control setup, the MIDI channels of the transmitting and receiving equipment must be matched for proper data transfer (there are 16 MIDI channels). An “OMNI” receive mode is also available, which allows reception on all 16 MIDI channels. In the OMNI mode it is not necessary to match the receive channel of the receiving device to the transmit channel of the transmitting device.

5 1 5 16

Send channel

r 1 r 16

Receive channel

ALL

OMNI ON

1 Hold [MIDI/TRANSCOPE] and press [PIANO] to set the send channel or [CLAVINOVA TONE] to set the receive channel.

2 Use TEMPO [▲] and [▼] buttons to select the desired channel (the selected channel number is shown on the TEMPO display — the OMNI ON receive mode is indicated by “ALL” on the display).

3 Release [MIDI/TRANSCOPE].



NOTES

- When the power is initially turned ON, MIDI receive is set to the OMNI ON mode and the transmit channel is set to 1.

Local Control ON/OFF

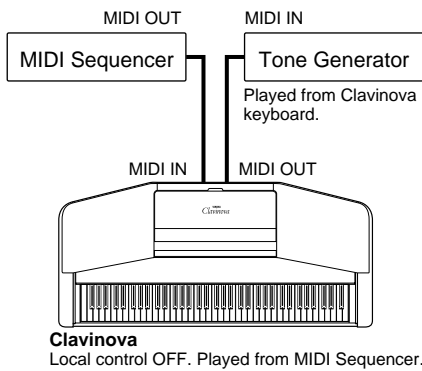

= local control OFF.



= local control ON.

“Local Control” refers to the fact that, normally, the Clavinova keyboard controls its internal tone generator, allowing the internal voices to be played directly from the keyboard. This situation is “Local Control ON” since the internal tone generator is controlled locally by its own keyboard.

Local control can be turned off, however, so that the Clavinova keyboard does not play the internal voices, but the appropriate MIDI information is still transmitted via the MIDI OUT connector when notes are played on the keyboard. At the same time, the internal tone generator responds to MIDI information received via the MIDI IN connector. This means that while an external MIDI sequencer, for example, plays the Clavinova’s internal voices, an external tone generator can be played from the Clavinova keyboard. Local Control is automatically turned ON when the power is initially turned on.

1 Hold [**MIDI/TRANSCOPE**] and press [**E. PIANO**].

2 Release [**MIDI/TRANSCOPE**].

Program Change ON/OFF

Normally the Clavinova will respond to MIDI program change numbers received from an external keyboard or other MIDI device, causing the correspondingly numbered Clavinova voice to be selected. The Clavinova will normally also send a MIDI program change number whenever one of its voices is selected, causing the correspondingly numbered voice or program to be selected on the external MIDI device if the device is set up to receive and respond to MIDI program change numbers.

This function makes it possible to cancel program change number reception and transmission so that voices can be selected on the Clavinova without affecting the external MIDI device, and vice versa. Program Change is automatically turned on when the power is initially turned on.



= program change reception/transmission OFF.



= program change reception/transmission ON.

1 Hold [**MIDI/TRANSCOPE**] and press [**HARPSI**].

2 Release [**MIDI/TRANSCOPE**].

Control Change ON/OFF

Normally the Clavinova will respond to MIDI control change data received from an external MIDI device or keyboard, causing the selected Clavinova voice to be affected by pedal and other “control” settings received from the controlling device. The Clavinova also transmits MIDI control change information when either of its pedals are operated.

This function makes it possible to cancel control change data reception and transmission if you do not want the Clavinova voices to be affected by control change data received from an external device or vice versa. Control Change is automatically turned on when the power is initially turned on.



= control change reception/transmission OFF.



= control change reception/transmission ON.

1 Hold [**MIDI/TRANSCOPE**] and press [**VIBES**].

2 Release [**MIDI/TRANSCOPE**].

■ The Multi-Timbre Mode

The Multi-Timbre mode is a special mode in which the Clavinova voices can be independently controlled on different MIDI channel numbers (1 through 15) by an external MIDI device. The Multi-Timbre mode is off when the power is initially turned on.

The Multi-Timbre mode can be activated as follows:



= Multi-Timbre mode ON.

○GUITAR

= Multi-Timbre mode OFF.

1 Hold [MIDI/TRANPOSE] and press [GUITAR].

2 Release [MIDI/TRANPOSE].

In this mode MIDI program change numbers received by the Clavinova select the corresponding Clavinova voices — i.e. the same voices selected by the panel controls. The Clavinova Common Voice Mode described on page 33 also allows multi-timbre control of the Clavinova, but with different voice assignments.

● Rhythm Instrument Note Assignments

The Clavinova's rhythm instruments are controlled via MIDI channel 15. The note assignments for the various rhythm instruments are given below:

Note	MIDI Note No.	Instrument	Note	MIDI Note No.	Instrument	Note	MIDI Note No.	Instrument
A1	45	(CYMBAL DAMP)	D4	74	TOM 3	F#5	90	CLAVES
F#2	54	BRUSH ROLL	D#4	75	HI-HAT OPEN	G5	91	TIMBALE HIGH
G#2	56	HI-HAT CLOSED HEAVY	E4	76	TOM 2	G#5	92	CASTANETS
A#2	58	CRASH CYMBAL LIGHT	F4	77	TOM 1	A5	93	CUICA LOW
B2	59	BASS DRUM LIGHT	F#4	78	RIDE CYMBAL NORMAL	A#5	94	COWBELL
C3	60	SNARE DRUM + RIM HEAVY	G4	79	ELECTRIC TOM 3	B5	95	CUICA HIGH
C#3	61	RIDE CYMBAL CUP	G#4	80	CRASH CYMBAL NORMAL	C6	96	HAND CLAP
D3	62	SNARE DRUM + RIM LIGHT	A4	81	ELECTRIC TOM 2	C#6	97	AGOGO LOW
F3	65	BASS DRUM NORMAL	A#4	82	CRASH CYMBAL	D#6	99	AGOGO HIGH
F#3	66	RIM SHOT	B4	83	ELECTRIC TOM 1	E6	100	BONGO LOW
G3	67	SNARE DRUM HEAVY	C5	84	CONGA LOW	F6	101	(CUICA LOW)
G#3	68	BRUSH SHOT	C#5	85	CABASA	F#6	102	(TAMBOURINE)
A3	69	SNARE DRUM LIGHT	D5	86	CONGA HIGH	G6	103	(CRASH CYMBAL)
A#3	70	HI-HAT PEDAL	D#5	87	METRONOME	G#6	104	(TRIANGLE CLOSED)
B3	71	SNARE DRUM ECHO	E5	88	BONGO HIGH	A6	105	(BRUSH ROLL)
C4	72	TOM 4	F5	89	TIMBALE LOW	A#6	106	(TRIANGLE OPEN)
C#4	73	HI-HAT CLOSED NORMAL						



NOTES

• Instrument names listed in parentheses can only be controlled by MIDI data received from another keyboard or MIDI control device. It is not possible to play or transmit these instruments directly from the keyboard.

■ The Split Send Mode

In the split send mode notes played on the left-hand section of the keyboard (to the left of and including the split point key — see “Changing the Split Point” on page 10) are transmitted on MIDI channel 2, while the upper keyboard section transmits on the MIDI channel set using the Send Channel Select function described earlier. In this mode the left- and right-hand sections of the keyboard can be used to play separate external keyboards or tone generators set to receive on the appropriate channels. The Split Send Mode is automatically turned off when the power is initially turned on.

☀STRINGS

= Split Send Mode ON.

○STRINGS

= Split Send Mode OFF.

1 Hold [MIDI/TRANPOSE] and press [STRINGS].

2 Release [MIDI/TRANPOSE].

MIDI Clock Select

This function determines whether the Clavinova's rhythm and ABC timing is controlled by the Clavinova's own internal clock or an external MIDI clock signal received from external equipment connected to the MIDI IN connector. The Clock Mode is automatically set to INTERNAL when the power is initially turned on.

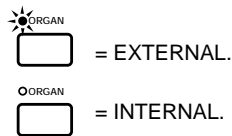

1 Hold [MIDI/TRANSCOPE] and press the [ORGAN].

2 Release [MIDI/TRANSCOPE].

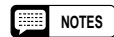

• If the Clock Mode is set to EXTERNAL and a MIDI clock signal is not being received from an external source, the rhythm, ABC and other clock-dependent features will not operate.

Panel Data Send

This function causes all the current Clavinova panel settings (selected voice, etc) to be transmitted via the MIDI OUT connector. This is particularly useful if you will be recording performances to a MIDI sequence recorder which will be used to control the Clavinova on playback. By transmitting the Clavinova panel settings and recording them on the MIDI sequence recorder prior to the actual performance data, the Clavinova will be automatically restored to the same settings when the performance is played back.

1 Hold [MIDI/TRANSCOPE] and press [CHOIR].

2 Release [MIDI/TRANSCOPE].

MIDI Transpose Transmit

This function transposes the pitch of transmitted MIDI note data up or down in semitone intervals up to a maximum of six semitones. The pitch of notes played on the keyboard is not affected.

Display	Transposition
♭ - 6	-6 semitones
♭ - 5	-5 semitones
♭ - 4	-4 semitones
♭ - 3	-3 semitones
♭ - 2	-2 semitones
♭ - 1	-1 semitone
♭ 0	Normal
♭ 1	+1 semitone
♭ 2	+2 semitones
♭ 3	+3 semitones
♭ 4	+4 semitones
♭ 5	+5 semitones
♭ 6	+6 semitones

1 Hold [MIDI/TRANSCOPE] and press [UPRIGHT BASS].

2 Use the TEMPO [▲] and [▼] buttons to select the desired degree of transposition while holding the [MIDI/TRANSCOPE] button.

The amount of transposition selected is shown on the TEMPO display.

3 Release [MIDI/TRANSCOPE].



• Press the TEMPO [▲] and [▼] buttons simultaneously while holding the [MIDI/TRANSCOPE] button to restore normal transmitted pitch.

• Transpose is always set to Normal when the power is turned on.

The Clavinova Common Voice Mode

This mode is similar to the Multi-Timbre Mode described on page 32, but MIDI program change numbers received on all channels are converted to Yamaha Clavinova Common Voice Numbers. MIDI program change numbers transmitted when the panel voice selectors are operated are also converted to the common voice numbers.

The Clavinova Common Voice mode is always off when the power is initially turned on. It can be activated as follows:

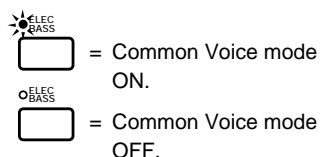

1 Hold [MIDI/TRANSCOPE] and press [ELEC BASS].

2 Release [MIDI/TRANSCOPE].



• The panel voices you play on the keyboard are not converted to the Clavinova Common Voices in this mode.

■ GM Multi-Timbre Mode

The GM Multi-Timbre mode is a special mode in which the Clavinova voices can be independently controlled on different MIDI channel numbers (1 through 16) by an external MIDI device. Also, MIDI program change numbers received on all channels are converted to GM system level 1 voice allocation numbers. With the GM Multi-Timbre mode switched on, you can select any voice from numbers 1 to 128 which are set to the GM voice allocation.

The GM Multi-Timbre mode can be activated as follows:



= GM Multi-Timbre mode ON. **1** Hold [MIDI/TRANSPOSE] and press [DRUMS].

DRUMS



= GM Multi-Timbre mode OFF. **2** Release [MIDI/TRANSPOSE].



NOTES

- The GM Multi-Timbre mode is automatically turned on if the Clavinova receives a GM on message from an external MIDI device.

■ Performance Memory Data Send

This function is used to transmit all data stored in the Performance Memory to a MIDI data storage device such as the Yamaha DOU-10 Disk Orchestra Unit. When Performance Memory data is being transmitted, “Snd” will appear on the display.

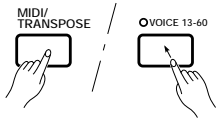

1 Hold [MIDI/TRANSPOSE] and press [VOICE 13-60]. Transmission will begin.

2 Release the buttons.

Although the Clavinova is a self-contained musical instrument that simply be plugged into the AC mains outlet and played, it also features a number of connectors for system expansion.

● AUX IN L/L+R and R Jacks



These jacks are intended primarily for use with external synthesizers or tone generator modules.

For example, the outputs of the synthesizer/tone generator can be to the Clavinova **AUX IN** jacks, allowing the sound of the synthesizer/tone generator to be reproduced via the Clavinova's internal amplifier and speaker system. For monaural signal input (when the connected device is monaural), use only the **L/L+R** jack.



- The input signal from the **AUX IN** jacks is delivered to the **AUX OUT** jacks, but is not affected by the Clavinova's volume control or reverb effect.

● AUX OUT L/L+R and R Jacks

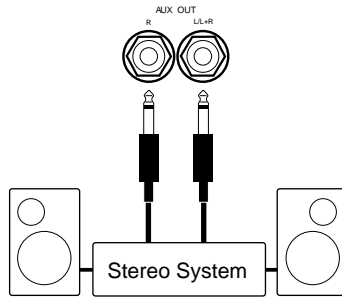

The **AUX OUT L/L+R** and **R** jacks deliver the output of the Clavinova for connection to an instrument amplifier, mixing console, PA system, or recording equipment. If you will be connecting the Clavinova to a monaural sound system, use only the **L/L+R** jack. When a plug is inserted into the **L/L+R** jack only, the left- and right-channel signals are combined and delivered via the **L/L+R** jack so you don't lose any of the Clavinova's sound.



- The **AUX OUT** jack signal must never be returned to the **AUX IN** jacks, either directly or through external equipment.

● MIDI IN and OUT Connectors

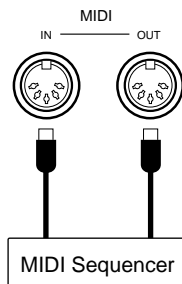

The **MIDI IN** connector receives MIDI data from an external MIDI device (such as a synthesizer, sequencer, music computer, etc.) which can be used to control the Clavinova. The **MIDI OUT** connector transmits MIDI data generated by the Clavinova (e.g. note and velocity data produced by playing the Clavinova keyboard).

More details on MIDI are given in "MIDI Functions" on page 30.

If you encounter what appears to be a malfunction, please check the following points before assuming that your Clavinova is faulty.

1. No Sound When the Power is Turned On

Is the AC plug properly connected to the Clavinova and an AC wall outlet? Check the AC connection carefully. Is the **MASTER VOLUME** control turned up to a reasonable listening level?

2. No Rhythm, ABC, or Performance Memory Sound

Check the Auto Accompaniment volume control settings. No sound is produced if these are set to their minimum positions.

3. The Clavinova Reproduces Radio or TV Sound

This can occur if there is a high-power transmitter in your vicinity. Contact your Yamaha dealer.

4. Intermittent Static Noise

This is usually due to turning on or off a household appliance or other electronic equipment which is fed by the same AC mains line as your Clavinova.

5. Interference Appears On Radio or TV Sets Located Near the Clavinova

The Clavinova contains digital circuitry which can generate radio-frequency noise. The solution is to move the Clavinova further away from the affected equipment, or vice versa.

6. Distorted Sound When the Clavinova is Connected to An External Amplifier/Speaker System

If the Clavinova is connected to a stereo system or instrument amplifier and the sound is distorted, reduce the setting of the Clavinova volume control to a level at which the distortion ceases.

Options

● BC-7 Bench

A stable, comfortable bench styled to match your Yamaha Clavinova.

● HPE-160 Stereo Headphones

High-performance lightweight dynamic headphones with extra-soft ear pads.

● KC-761 Key Cover

A convenient way to keep your keyboard clean and dust-free.



NOTES

• Some items may not be available in certain areas.

A		I		R	
ABC, recording with	25	Initial parameter values, changing	26	Recording and playback, multitrack	25
Accompaniment volume mode	29	Internal amplifier and speaker system	5	Recording and playback, one pass	24
Auto accompaniment volume controls	5	Introductions	18	Reverb	12
Auto Bass Chord	20	K		Rhythm instrument MIDI note assignments	32
Aux in jacks	35	Keyboard	13	Rhythm, recording with	25
Aux out jacks	35	Keyboard percussion	8		
B		L		S	
Balance, dual mode	9	Left pedal	14	Send/receive channel select	30
Balance, split mode	11	Left pedal, Solo Styleplay	23	Single-finger accompaniment	20
C		Local control on/off	31	Soft pedal	14
Chord sequence	28	M		Solo styleplay	23
Chord types	21	Metronome	19	Solo styleplay, recording with	25
Clavinova common voice mode	33	MIDI clock select	33	Sostenuto pedal	14
Connectors	35	MIDI connectors	35	Split mode	10
Control change on/off	31	MIDI functions	30	Split point, ABC	22
Conventional Full-keyboard ABC	22	MIDI transpose transmit	33	Split point, normal	10
D		Monitoring tracks	26	Split send mode	32
Damper pedal	14	Multi-timbre mode	32	Split voices, changing	10
Damper pedal, split mode	11	Music stand	4	Starting the accompaniment	18
Demonstration playback	6	O		Stopping the accompaniment	19
Depth control, reverb	12	Options	38	Style selection	17
Drum and percussion key assignments	8	P		Synchronized start	18
Dual mode	9	Pan	13	T	
E		Panel controls	2	Tempo control	17
Erasing tracks	27	Panel data send	33	Touch sensitivity	29
F		Parameters, performance memory	26	Track selection	25
Fill-ins	19	Pedals	14	Tracks, adding new	26
Fingered accompaniment	21	Performance memory	24	Transposition	15
Full-keyboard ABC	22	Performance memory data send	34	Troubleshooting	36
G		Pitch control	16	U	
GM multi-timbre mode	34	Playback, performance memory	27	Utility mode	29
H		Polyphony	13	V	
Harmonization, Solo Styleplay	23	Power switch	4	Voice list	8
Headphones	4	Precautions	1	Voice selection	7
		Program change on/off	31	Volume controls	5, 22

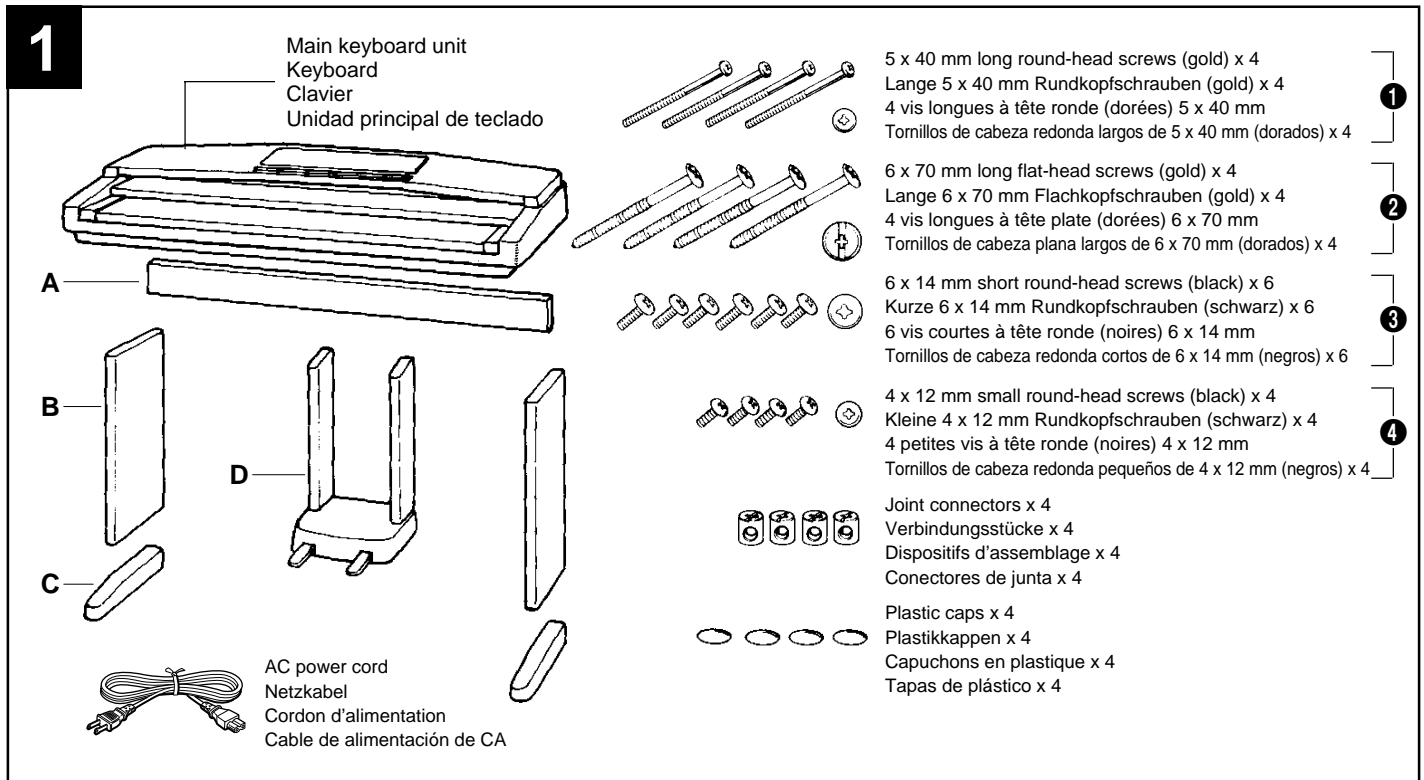

Assembly

NOTES

- We do not recommend attempting to assemble the Clavinova alone. The job can be easily accomplished, however, with only two people.
- Use only the screws provided or replacements of exactly the specified size. Using screws of the wrong size can result in damage to the instrument.

1 Open the box and remove all the parts.

On opening the box you should find the parts shown in the illustration. Check to make sure that all the required parts are provided.

2 Attach the feet (C) to the side panels (B).

Secure the feet (C) to the side panels (B) using two 5 x 40 mm long round-head screws ① for each side. Take a close look at the brackets positions on the side panels in the illustration and assemble the side panels and feet accordingly.

3 Attach the side panels (B) to the center panel (A).

Attach the center panel (A) to the side panels (B) using the four 6 x 70 mm long flat-head screws ② as shown in the illustration.

* When installing the joint connectors in the holes in the center panels (A), make sure that they are rotated to the position shown in the illustration.

Zusammenbau

HINWEISE

- Wir raten Ihnen davon ab, das Clavinova alleine zusammenzubauen und aufzustellen. Zwei Personen können diese Arbeit jedoch problemlos ausführen.
- Verwenden Sie ausschließlich die mitgelieferten Schrauben oder Ersatzschrauben identischer Größe. Die Verwendung von Schrauben mit abweichenden Maßen kann eine Beschädigung des Instruments zur Folge haben.

1 Den Versandkarton öffnen und alle Teile auspacken.

Der Karton sollte alle in der Abbildung gezeigten Teile enthalten. Vergewissern Sie sich, daß alle Teile vollzählig vorhanden sind.

2 Die FüÙe (C) an den Seitenwänden (B) befestigen.

Schrauben Sie die FüÙe (C) mit jeweils zwei langen 5 x 40 mm Rundkopfschrauben ① an den beiden Seitenwänden (B) fest. Richten Sie sich zur besseren Orientierung nach den in der Abbildung gezeigten Halterungspositionen an den Seitenwänden, und schrauben Sie die FüÙe entsprechend an die Seitenwände.

3 Die Seitenwände (B) mit der Verstärkungsstrebe (A) verschrauben.

Schrauben Sie die Verstärkungsstrebe (A) mit den vier langen 6 x 70 mm Flachkopfschrauben ② an den Seitenwänden fest, wie in der Abbildung dargestellt.

* Richten Sie die Verbindungsstücke nach dem Einsetzen in die Bohrungen der Verstärkungsstrebe (A) so aus, wie in der Abbildung gezeigt.

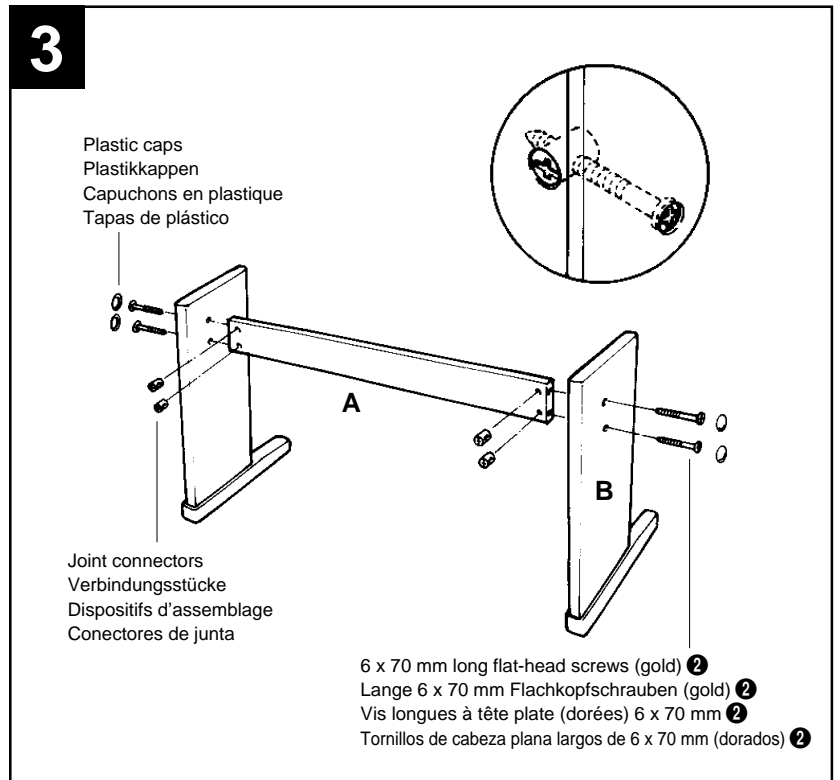
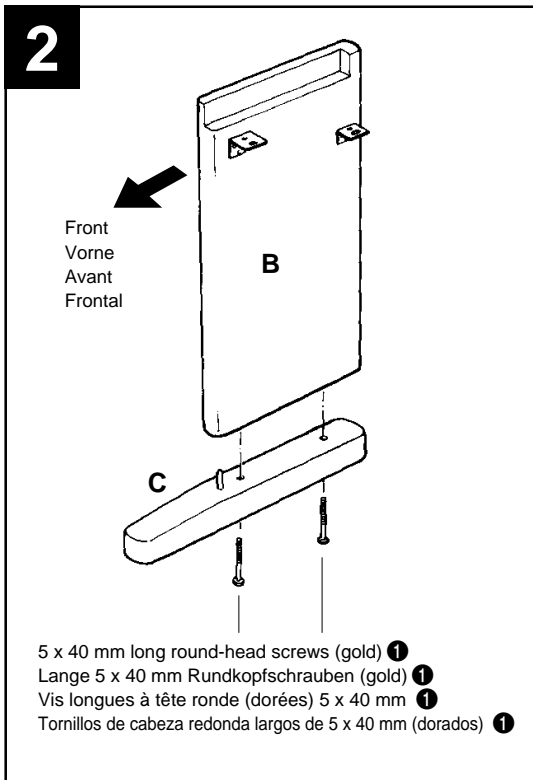

Montage



- Nous ne vous conseillons pas d'essayer d'assembler le Clavinova seul. Toutefois, ce travail peut être facilement exécuté par deux personnes.
- N'utilisez que les vis fournies ou des vis ayant exactement les mêmes dimensions. Le fait d'utiliser des vis de dimensions incorrectes pourrait endommager l'instrument.

1 Ouvrez le carton et retirez toutes les pièces.

Les pièces indiquées sur l'illustration devraient toutes se trouver dans le carton. Vérifiez qu'il n'en manque aucune.

2 Montez les supports inférieurs (C) sur les panneaux latéraux (B).

Fixez les supports inférieurs (C) sur les panneaux latéraux (B) avec deux vis longues à tête ronde de 5 x 40 mm 1 pour chaque côté. Observez bien sur l'illustration la position des ferrures sur les panneaux latéraux et montez les panneaux latéraux et les supports inférieurs en conséquence.

3 Montez les panneaux latéraux (B) sur le panneau central (A).

Montez le panneau central (A) et les panneaux latéraux (B) avec quatre vis longues à tête plate de 6 x 70 mm 2 comme mentionné sur l'illustration.

* Lorsque vous posez les connecteurs de joints dans les trous du panneau central (A), vérifiez qu'ils sont bien tournés dans la position indiquée sur l'illustration.

Montaje



- No le recomendamos que monte la Clavinova usted solo. Sin embargo, el trabajo podrá realizarse con más facilidad entre dos personas solamente.
- Emplee sólo los tornillos suministrados u otros que sean exactamente del mismo tamaño especificado. El empleo de tornillos del tamaño erróneo puede dañar el instrumento.

1 Abra la caja y extraiga todas las partes.

Al abrir la caja, encontrará las partes mostradas en la ilustración de arriba. Compruebe y asegúrese de que no falta ninguna de las partes requeridas.

2 Monte las patas (C) en los paneles laterales (B).

Fije las patas (C) en los paneles laterales (B) usando dos tornillos de cabeza redonda largos de 5 x 40 mm 1 para cada lado. Cerciérese de las posiciones de las ménsulas en los paneles laterales en la ilustración y monte los paneles laterales y las patas de forma consecutiva.

3 Monte los paneles laterales (B) en el panel central (A).

Monte el panel central (A) en los paneles laterales (B) usando los cuatro tornillos de cabeza plana largos de 6 x 70 mm 2 como se muestra en la ilustración.

* Cuando instale los conectores de unión en los orificios de los paneles centrales (A), asegúrese de que se giran a la posición mostrada en la ilustración.

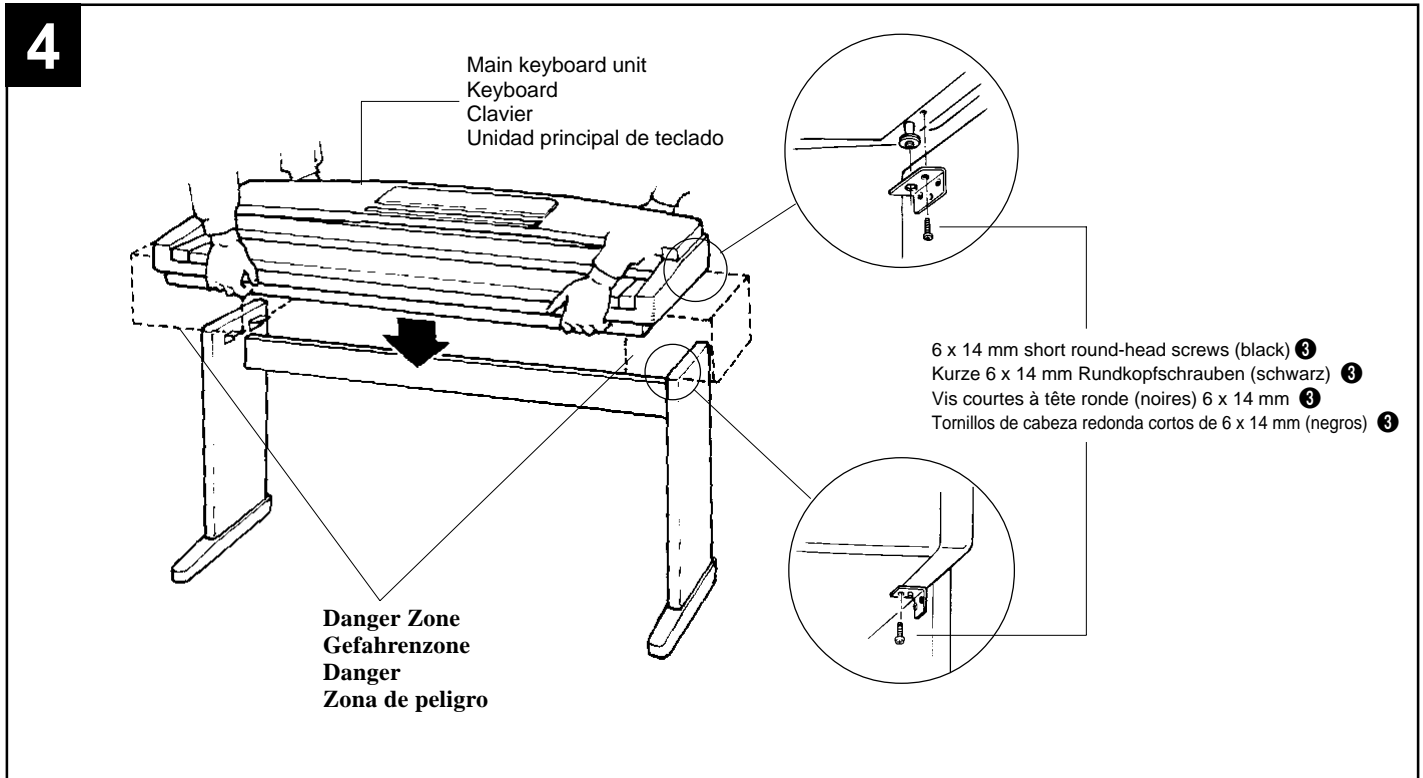

4 Install the main keyboard unit.

As shown in the illustration, gently lower the main keyboard unit onto the stand assembly so that the two black plastic cones protruding from the bottom of the keyboard fit into the larger holes in the brackets near the rear edge of the side panels (B). Secure the main keyboard unit to the stand assembly using two 6 x 14 mm round-head screws ③ screwed through the rear brackets and two 6 x 14 mm round-head screws ③ through the front bracket.

* When disassembling the Clavinova unscrew the black cones using a "+" (Phillips) screwdriver.

* Keep your fingers away from the area marked "Danger Zone" in the illustrations when lowering the main keyboard unit onto the stand assembly.

5 Attach the pedal assembly.

Tilt the main unit as shown in the illustration, align the pedal assembly with the screw holes on the main unit and center panel (A), making sure that the pedal cord passes through the recess in the top of the pedal assembly, and screw the four 4 x 12 small round-head screws ④ into the center panel (A), and the two 6 x 14 mm round-head screws ③ into the main keyboard unit.

Plug the pedal cord connector which is protruding from the top of the pedal assembly into the corresponding connector in the bottom of the main keyboard unit. Note that the connector must be inserted with the protruding clip facing the right end of the keyboard (as seen from the keyboard side).

4 Das Keyboard montieren.

Setzen Sie das Keyboard, wie in der Abbildung gezeigt, vorsichtig so auf das zusammengebaute Untergestell, daß die beiden schwarzen Kunststoffkegel an der Unterseite des Keyboards in die größeren Bohrungen der Halterungen hinten an den Seitenwänden (B) greifen. Schrauben Sie das Keyboard mit zwei 6 x 14 mm Rundkopfschrauben ③ an den hinteren Halterungen und zwei weiteren 6 x 14 mm Rundkopfschrauben ③ an den vorderen Halterungen fest.

* Beim Zerlegen des Clavinova können die beiden schwarzen Kegel mit einem Kreuzschlitzschraubendreher ("+") herausgedreht werden.

* Halten Sie Ihre Hände beim Aufsetzen des Keyboards auf das Untergestell von dem in der Abbildung mit "Gefahrenzone" gekennzeichneten Bereich fern.

5 Den Pedalkasten befestigen.

Kippen Sie das Instrument, wie in der Abbildung gezeigt, und richten Sie den Pedalkasten auf die Schraubenbohrungen an Keyboard und Verstärkungsstrebe (A) aus. Vergewissern Sie sich, daß das Pedalkabel richtig in der Nut der Pedalkastenstrebe liegt, und schrauben Sie den Pedalkasten dann mit den vier kleinen 4 x 12 mm Rundkopfschrauben ④ an der Verstärkungsstrebe und zwei 6 x 14 mm Rundkopfschrauben ③ am Keyboard fest.

Schließen Sie den Stecker des Pedalkabels an die Buchse an der Unterseite des Keyboards an. Beim Einstecken muß das Klemmstück des Steckers zur rechten Seite des Keyboards weisen (von der Seite mit der Tastatur aus gesehen).

5

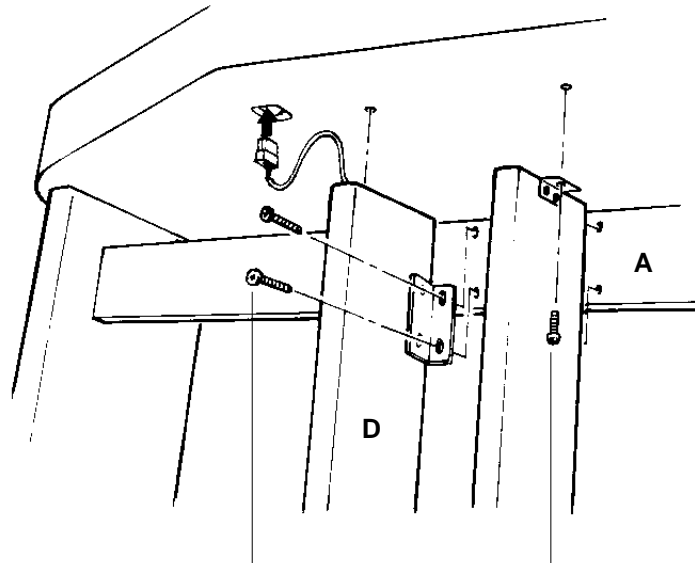
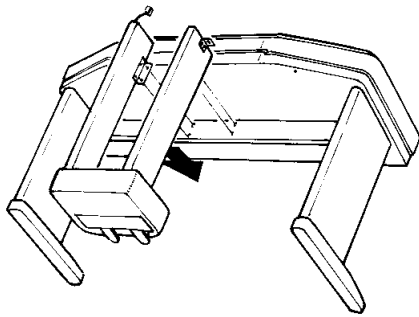

4 x 12 mm small round-head screws (black) ④
 Kleine 4 x 12 mm Rundkopfschrauben (schwarz) ④
 Petites vis à tête ronde (noires) 4 x 12 mm ④
 Tornillos de cabeza redonda pequeños de 4 x 12 mm (negros) ④

6 x 14 mm short round-head screws (black) ③
 Kurze 6 x 14 mm Rundkopfschrauben (schwarz) ③
 Vis courtes à tête ronde (noires) 6 x 14 mm ③
 Tornillos de cabeza redonda cortos de 6 x 14 mm (negros) ③

4 Installation du clavier.

Comme mentionné sur l'illustration, abaissez le clavier avec précaution sur les supports afin que les deux cônes en plastique noir qui dépassent de la semelle du clavier s'insèrent dans les trous plus grands des ferrures près du bord arrière des panneaux latéraux (B). Fixez le clavier sur le support avec deux vis à tête ronde 6 x 14 mm ③ vissées dans les ferrures arrière et deux vis à tête ronde 6 x 14 mm ③ dans les ferrures avant.

* Lors du démontage du Clavinova, dévisser les cônes noirs avec un tournevis cruciforme "+".

* En abaissant le clavier sur le support, éloignez vos doigts de la zone marquée "Danger" sur l'illustration.

5 Fixez le pédalier.

Inclinez le clavier comme illustré, alignez le pédalier sur les trous de vis du clavier et du panneau central (A) en vérifiant que le cordon du pédalier passe bien par l'encoche en haut du pédalier, puis vissez les quatre petites vis à tête ronde 4 x 12 mm ④ dans le panneau central (A) et les deux vis à tête ronde 6 x 14 mm ③ dans le clavier.

Branchez le connecteur de cordon de pédalier, qui dépasse en haut du pédalier, dans le connecteur correspondant au bas du clavier. Il est à noter que le connecteur doit être inséré de manière à ce que sa partie saillante se trouve à l'extrémité droite du clavier (vu du clavier).

4 Instale la unidad principal del teclado.

Como se muestra en la ilustración, baje con cuidado la unidad principal del teclado sobre el conjunto del soporte de modo que los dos conos de plástico negro que sobresalen por la parte inferior del teclado se adapten en los orificios más grandes de las ménsulas, cerca de borde trasero de los paneles laterales (B). Asegure la unidad principal del teclado en el conjunto del soporte usando dos tornillos de cabeza redonda de 6 x 14 mm ③ a través de las ménsulas posteriores y dos tornillos de cabeza redonda de 6 x 14 mm ③ a través de la ménsula frontal.

* Cuando desmonte la Clavinova, desenrosque los conos negros usando un destornillador de cabeza en cruz "+".

* Mantenga los dedos apartados de la parte marcada con "Zona de peligro" en la ilustración cuando baje la unidad principal del teclado sobre el conjunto del soporte.

5 Monte el conjunto de los pedales.

Incline la unidad principal como se muestra en la ilustración, alinee el conjunto de pedales con los orificios de tornillos de la unidad principal y panel central (A), asegurándose de que el cable de los pedales pasa por el hueco de la parte superior del conjunto de pedales, y enrosque los cuatro tornillos de cabeza redonda de 4 x 12 mm ④ en el panel central (A), y los dos tornillos de cabeza redonda de 6 x 14 mm ③ a través de la ménsula frontal.

Enchufe el conector del cable de pedales que sobresale de la parte superior del conjunto de pedales en el conector correspondiente de la parte inferior de la unidad principal del teclado. Tenga presente que el conector debe insertarse con el retenedor saliente orientado hacia el extremo derecho del teclado (mirándolo desde el lado del teclado).

6

- A voltage selector is provided in some areas.
- Spannungswähler
(nur in bestimmten Verkaufsgebieten)
- Un sélecteur de tension est prévu pour certaines régions
- El selector de tensión está provisto para ciertos destinos.

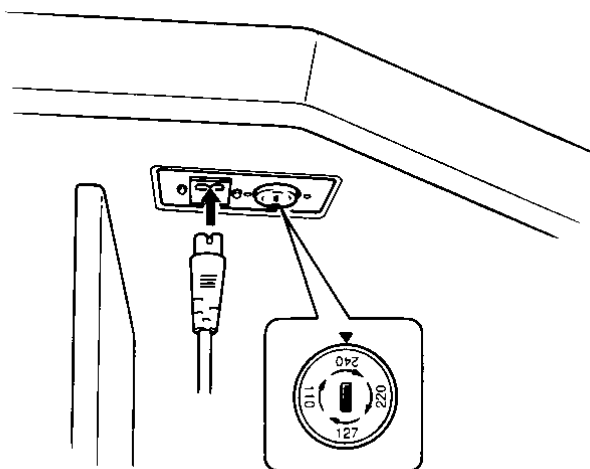

6 Voltage Selector

Before connecting the AC power cord, check the setting of the voltage selector which is provided in some areas. To set the selector for 110V, 127V, 220V or 240V main voltages, use a “minus” screwdriver to rotate the selector dial so that the correct voltage for your region appears next to the pointer on the panel. The voltage selector is set at 240V when the unit is initially shipped.

After the proper voltage has been selected connect the AC power cord. A plug adaptor may be also provided in some areas to match the pin configuration of the AC wall outlets in your area.

7 Set the adjuster.

For stability, two adjusters are provided on the bottom of the pedal assembly (D). Rotate the adjusters until they come in firm contact with the floor surface. The adjusters ensure stable pedal operation and facilitate pedal effect control. If the adjusters are not in firm contact with the floor surface, distorted sound may result.

!! IMPORTANT

- After assembling the Clavinova, check once more to make sure that all screws have been securely fastened.
- If the stand leans to the side, makes unusual noises, or otherwise seems unstable during use, check and tighten all screws while following the assembly instructions given above.

6 Den Spannungswähler einstellen.

Bevor Sie nun das Netzkabel anschließen, müssen Sie den Spannungswähler (falls vorhanden) auf die örtliche Netzspannung einstellen. Zum Verstellen drehen Sie den Spannungswähler mit einem Schlitzschraubendreher, bis der richtige Spannungswert (110, 127, 220 oder 240) an der Pfeilmarkierung steht. Bei der Auslieferung werden alle Instrumente mit Spannungswähler auf “240” voreingestellt.

Nachdem Sie den Spannungswähler richtig eingestellt haben, können Sie nun das Netzkabel anschließen. In manchen Gebieten wird ein Steckeradapter mitgeliefert, um den Anschluß an die evtl. unterschiedlich geformte Steckdose zu ermöglichen.

7 Die Pedalstützen einstellen.

Für bessere Standfestigkeit sind unter dem Pedalkasten (D) zwei verstellbare Pedalstützen vorgesehen. Nachdem Sie das Clavinova an seinem festen Standplatz aufgestellt haben, drehen Sie diese Stützen heraus, bis sie fest auf dem Boden stehen. Die Stützen sorgen beim Spielen für präzise Pedalbetätigung. Wenn die beiden Pedalstützen nicht fest auf dem Boden aufstehen, können Klangverzerrungen auftreten.

!! WICHTIG

- Vergewissern Sie sich nach Zusammenbau und Aufstellung des Clavinova noch einmal davon, daß alle Schrauben fest angezogen sind.
- Wenn das Instrument schief steht, komische Geräusche erzeugt oder sich beim Spielen wackelig anfühlt, prüfen Sie gemäß den obigen Anweisungen, ob das Instrument richtig zusammengesetzt wurde, und ziehen dabei die einzelnen Schrauben noch einmal nach.

7

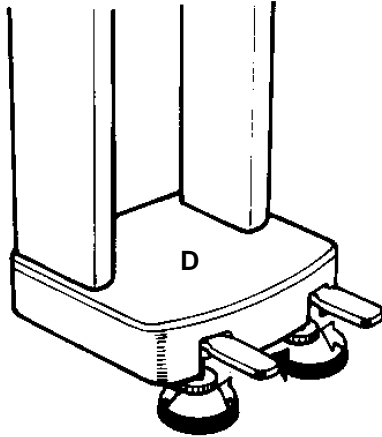

6 Sélecteur de tension

Avant de connecter le cordon d'alimentation, vérifiez le réglage du sélecteur de tension qui est prévu pour certaines régions. Pour régler le sélecteur sur 110 V, 127 V, 220 V ou 240 V, utilisez un tournevis à lame plate pour tourner le cadran du sélecteur afin de mettre l'indication correspondant à la tension de votre région vis à vis du repère triangulaire situé sur le panneau. Le sélecteur de tension est réglé sur 240 V au départ d'usine.

Une fois que vous avez réglé le sélecteur de tension, connectez le cordon d'alimentation. Un adaptateur de prise peut également être fourni dans certaines régions pour pouvoir brancher le cordon à la prise secteur murale.

7 N'oubliez pas de régler la hauteur du pédalier.

Pour assurer la stabilité, deux dispositifs de réglage ont été prévus à la partie inférieure du pédalier (D). Tournez ces dispositifs jusqu'à ce qu'ils soient en contact ferme avec la surface du sol. Ces dispositifs assurent la stabilité du pédalier lors de son utilisation et facilitent la commande au pied des effets. Si ces dispositifs ne sont pas en contact ferme avec le sol, il pourra se produire une distorsion du son.



IMPORTANT

- Après avoir assemblé le Clavinova, vérifiez de nouveau que toutes les vis sont bien serrées à fond.
- Si l'instrument penche d'un côté, s'il fait un bruit inhabituel, ou s'il paraît instable lorsque vous l'utilisez, vérifiez que vous l'avez assemblé correctement et que toutes les vis sont bien serrées en suivant les instructions de montage données ici.

6 Selector de tensión

Antes de conectar el cable de alimentación de CA, compruebe el ajuste del selector de tensión que se incorpora para ciertos destinos. Para ajustar el selector a 110V, 127V, 220V ó 240V de la red de alimentación, emplee un destornillador de cabeza recta "-" para girar el selector de modo que la tensión correcta de su zona aparezca al lado del indicador del panel. El selector de tensión se ajusta a 240V cuando la unidad sale de fábrica.

Después de haber seleccionado la tensión correcta, enchufe el cable de alimentación. En algunas zonas puede suministrarse también un adaptador para adaptar la configuración de las patillas de los tomacorrientes de CA de su localidad.

7 Asegúrese de ajustar los reguladores de los pedales.

Para más estabilidad, se proporcionan dos reguladores en la parte inferior del conjunto de pedales (D). Gire los reguladores hasta que hagan buen contacto con la superficie del piso. Los reguladores aseguran una operación estable de los pedales y facilitan el control de los efectos con los pedales. Si los ajustadores no están en buen contacto con la superficie del piso, el sonido podría distorsionarse.



IMPORTANTE

- Después de haber montado la Clavinova, compruebe una vez más que todos los tornillos se hayan apretado bien.
- Si el soporte se inclina a un lado, hace ruidos anormales, o parece inestable durante la utilización, compruebe y apriete todos los tornillos siguiendo las instrucciones de montaje anteriores.

If you're already very familiar with MIDI, or are using a computer to control your music hardware with computer-generated MIDI messages, the data provided in this section can help you to control the Clavinova.

Falls Sie bereits mit MIDI vertraut sind oder einen Computer zur Hardware-Steuerung einsetzen, werden Ihnen die nachfolgend aufgeführten Daten bei der Steuerung des Clavinovas wahrscheinlich hilfreich sein.

Si vous vous êtes déjà familiarisés avec l'interface MIDI, ou si vous utilisez un ordinateur pour commander votre matériel de musique au moyen de messages MIDI générés par ordinateur, les données suivantes vous aideront à commander le Clavinova.

Si ya está muy familiarizado con MIDI o si está usando una computadora para controlar su música con mensajes MIDI generados por computadora, los datos proporcionados en esta sección le ayudarán a controlar la Clavinova.

1. NOTE ON/OFF

[9nH] [kkH] [vvH]

9nH= Note on/off event
(n= MIDI channel number)

kkH= Note number

(Transmission: 16H~6DH= A#-1~C#7,
Reception= 15H~6CH: A-1~C7)

vvH= Velocity

(Note on= 01H~7FH, Note off= 00H)

[8nH] [kkH] [vvH]

8nH= Note off event
(n= MIDI channel number)

kkH= Note number (15H~6CH: A-1~C7)

vvH= Velocity (Note off= 00H~7FH)

* 8nH (note off) is receive only.

9nH (vvH=00H) used for transmission.

2. CONTROL CHANGE

[BnH] [ccH] [vvH]

BnH= Control event
(n= MIDI channel number)

ccH= Control number

vvH= Control value

• Modulation (Vibrato) (receive only)

[BnH] [01H] [vvH]

n= MIDI channel number

vvH= Modulation

00H~0FH: Off : AM also off.

10H~1FH: 1 : Voice default AM
when greater than 10H

20H~2FH: 2

30H~3FH: 3

40H~4FH: 4

50H~5FH: 5

60H~6FH: 6

70H~7FH: 7

* LFO speed fixed for each voice

• Volume

[BnH] [07H] [vvH]

n= MIDI channel number

vvH= Volume (00H~7FH)

00H: -∞

6FH: -3dB

7FH: ±0dB

• Pan

[BnH] [0AH] [vvH]

n= MIDI channel number

vvH= Pan (00H~7FH)

00H~17H: Left 6

18H~1FH: Left 5

20H~27H: Left 4

28H~2FH: Left 3

30H~37H: Left 2

38H~3FH: Left 1

40H~47H: Center

48H: Voice default Pan

49H: Scaling Pan (Standard) (receive only)

4AH: Scaling Pan (Wide) (receive only)

4BH: Scaling Pan (Narrow L) (receive only)

4CH: Scaling Pan (Narrow C) (receive only)

4DH: Scaling Pan (Narrow R) (receive only)

4EH: Scaling Pan (Half L) (receive only)

4FH: Scaling Pan (Half R) (receive only)

50H~57H: Right 1

58H~5FH: Right 2

60H~67H: Right 3

68H~6FH: Right 4

70H~77H: Right 5

78H~7FH: Right 6

• Expression (receive only)

[BnH] [0BH] [vvH]

n= MIDI channel number

vvH= Expression (00H~7FH)

00H: -∞

6FH: -3dB

7FH: ±0dB

• Damper pedal

[BnH] [40H] [vvH]

n= MIDI channel number

vvH= Control value (00H~7FH)

00H~3FH: off

40H~7FH: on

• Sostenuto pedal

[BnH] [42H] [vvH]

n= MIDI channel number

vvH= Control value (00H~7FH)

00H~3FH: Off

40H~7FH: On

• Soft pedal

[BnH] [43H] [vvH]

n= MIDI channel number

vvH= Control value (00H~7FH)

00H~3FH: Off

40H~7FH: On

• Portamento control

[BnH] [54H] [vvH]

n= MIDI channel number

vvH= Control value (00H~7FH)

15H~6CH: Key Number

• Reverb depth

[BnH] [5BH] [vvH]

n= MIDI channel number

vvH= Reverb Depth (00H~7FH)

Individually adjustable for each channel.

3. MODE MESSAGES (receive only)

[BnH] [ccH] [vvH]

BnH= Control event
(n= MIDI channel number)

ccH= Mode message number

vvH= Mode message value

• All sound off

[BnH] [78H] [00H]

n= MIDI channel number

• Reset all controllers

[BnH] [79H] [00H]

n= MIDI channel number

• Local Control ON/OFF

[BnH] [7AH] [vvH]

n= MIDI channel number

vvH= 00H: Off

7FH: On

• All notes OFF

[BnH] [7BH] [00H]

n= MIDI channel number

• OMNI OFF/All notes OFF

[BnH] [7CH] [00H]

n= MIDI channel number

- OMNI ON/All notes OFF
[BnH] [7DH] [00H]
n= MIDI channel number

4. REGISTERED/NON-REGISTERED PARAMETER NUMBER

- Data entry
[BnH] [06H] [mmH]
[BnH] [26H] [IIH]
n= MIDI channel number
mm/II=RPN
- Data inc
[BnH] [60H] [xxH]
n= MIDI channel number
xx= Dummy, RPN
- Data dec
[BnH] [61H] [xxH]
n= MIDI channel number
xx= Dummy, RPN
- Non-registered parameter number
[BnH] [62H] [IIH]
[BnH] [63H] [mmH]
n= MIDI channel number
* No parameter is received, but the data is recognized because of RPN reception.
- Registered parameter number
[BnH] [64H] [IIH]
[BnH] [65H] [mmH]
n= MIDI channel number
IIH= 00H, mmH= 00H: Pitch bend sensitivity
IIH= 01H, mmH= 00H: Fine tune
IIH= 02H, mmH= 00H: Coarse tune
IIH= 7FH, mmH= 7FH: RPN Reset

5. PROGRAM CHANGE

[CnH] [ppH]
CnH= Program change event
(n= MIDI channel number)
ppH= Program number

Panel Voices

- dd VOICE
- 00H PIANO
- 01H CLAVINOVA TONE
- 02H E. PIANO
- 03H HARPSICHORD
- 04H VIBES
- 05H GUITAR
- 06H STRINGS
- 07H ORGAN
- 08H CHOIR
- 09H UPRIGHT BASS
- 0AH E. BASS
- 0BH DRUMS

Voices 13 — 60

- dd VOICE
- 0CH BRASS
- 0DH POP BRASS
- 0EH TRUMPET
- 0FH MUTE TRUMPET
- 10H HORN
- 11H SAX
- 12H SAX SOFT
- 13H CLARINET
- 14H OBOE
- 15H FLUTE
- 16H ACCORDION
- 17H HARMONICA
- 18H STRINGS SOFT
- 19H VIOLIN
- 1AH VIOLIN HARD
- 1BH FULL ORGAN
- 1CH JAZZ ORGAN 1
- 1DH SYNTH BRASS
- 1EH SYNTH WOOD
- 1FH SYNTH STRINGS
- 20H SYNTH CHOIR
- 21H PIANO BRIGHT
- 22H PIANO SOFT
- 23H E. PIANO DX
- 24H SYNTH CRYSTAL
- 25H CELESTA
- 26H MARIMBA
- 27H FOLK GUITAR
- 28H JAZZ GUITAR 1
- 29H JAZZ GUITAR 2
- 2AH ROCK GUITAR 1
- 2BH ROCK GUITAR 2
- 2CH MUTE GUITAR
- 2DH BANJO
- 2EH PIZZICATO
- 2FH HARP
- 30H U. BASS SOFT
- 31H E. BASS SOFT
- 32H E. BASS HEAVY
- 33H SYNTH BASS
- 34H TIMPANI & ORCH. HIT
- 35H BASSOON
- 36H CHAMBER STRINGS
- 37H JAZZ ORGAN 2
- 38H ROCK GUITAR 3
- 39H COSMIC 1
- 3AH COSMIC 2
- 3BH COSMIC 3

6. PITCH BENDER (receive only)

[EnH] [IIH] [mmH]
EnH= Bender event
(n= MIDI channel number)
IIH= Least significant byte
mmH= Most significant byte

* **Caution:** The bend range is set to a minor third when the power is turned on. RPN data can be used to set the range in semitone increments.

7. SYSTEM REALTIME MESSAGES

[rrH]
F8H: Timing clock
FAH: Start
FCH: Stop
FEH: Active sensing

Data	Transmission	Reception
F8H	Transmitted every 96 clocks	Received as 96-clock tempo timing when MIDI clock is set to External
FAH	Rhythm start	Rhythm start
FCH	Rhythm stop	Rhythm stop
FEH	Transmitted every 200 milliseconds	All notes are turned off if no data is received for more than 400 milliseconds

* **Caution:** If an overrun framing error occurs the Damper, Sostenuto, and Soft effects for all channels are turned off and an All Note Off occurs.

8. SYSTEM EXCLUSIVE MESSAGES

- YAMAHA MIDI format
[F0H] [43H] [xnH] [ffH] [F7H]
43H= YAMAHA ID
xnH= Substatus + MIDI channel number
ffH= Format number

* n specifies the receive channel regardless of whether omni is on or off.

x ff Information
0 7CH Panel data receive
2 7CH Panel data bulk dump request
2 7DH Model ID data bulk dump request

Panel Data Send Format

F0H, 43H, 0xH, 7CH, 00H, 22H
(x: channel number,
data length= Panel data+0cH)
53H, 4BH, 20 H, 20H (SK)
43H, 56H, 50H, 2DH, 34H, 39H (CVP-49)
3xH, 3yH (Version x, y)
[Panel Data]
[Check Sum (1byte)]= 0
(53H+4BH+20H+...
...+Data end)
F7H

[Panel Data Contents]

- (1) ABC ON/OFF
- (2) SSP ON/OFF
- (3) SSP NO.
- (4) MANUAL VOICE
- (5) MANUAL VOLUME
- (6) RHYTHM NO.
- (7) RHYTHM VARIATION
- (8) TEMPO (Absolute value LSB)
- (9) TEMPO (Absolute value MSB)
- (10) RHYTHM VOLUME
- (11) CHORD 1 VOLUME
- (12) CHORD 2 VOLUME
- (13) BASS VOLUME

- (14) SPLIT POINT
- (15) DUAL/SPLIT MODE
- (16) DUAL/SPLIT VOICE
- (17) DUAL/SPLIT BALANCE
- (18) REVERB
- (19) REVERB DEPTH
- (20) PEDAL FUNCTION
- (21) VOICE BANK (Upper 4 bits)
- (22) INTRO

Name Data Send Format

F0H, 43H, 0xH, 7DH, 00H, 10H
 (Data Length= 10H byte)
 53H, 4BH, 20H, 20H (SK)
 43H, 56H, 50H, 2DH, 34H, 39H (CVP-49)
 3xH, 3yH, 20H, 20H, 20H, 20H (Version x,y)
 [CHECK SUM (1byte)]= 0-(53H+4BH+20H+...
 ...+20H)
 F7H

Performance Memory Data Send Format

F0H, 43H, 73H
 3AH (Product ID: CVP-49)
 06H (Bulk ID)
 00H (Bulk No.)
 0uH, 0vH, 0wH, 0xH, 0yH, 0zH
 (Data Length= uvwxyzH byte)
 [BULK DATA] (low, high...low, high)
 [CHECK SUM (1byte)]= 0-sum (BULK DATA)
 F7H

GM Mode Exclusive

GM On: F0H, 7EH, 7FH, 09H, 01H, F7H
 GM Off: F0H, 7EH, 7FH, 09H, 00H, F7H

• Clavinova MIDI Format

[F0H] [43H] [73H] [yyH] [xxH] [F7H]
 43H= YAMAHA ID
 73H= CLAVINOVA ID
 yyH= Product ID (CVP-49= 3AH)
 xxH= Substatus

- xxH Information
- 02H Internal MIDI clock
- 03H External MIDI clock
- 13H Multi-timbre mode off
- 14H Common voice multi-timbre mode on
- 15H Multi-timbre mode on
- 18H Common voice multi-timbre mode individual track reverb depth on
- 7nH All Note Off,
Receive Channel = n+1, Omni off

* When nn = 2, 3, 13, 14, 15, 18, or 7C,
Clavinova common ID (01H) is recognized
as well as 3AH.

* All Control Change values are reset when
[13H], [14H] or [15H] is received. All
voices and other parameters are also
reset when [14H] or [15H] is received in
order to ensure the same initial settings.

• Special Messages

[F0H] [43H] [73H] [yyH] [11H] [0nH]
 [ccH] [vvH] [F7H]
 43H= YAMAHA ID
 73H= CLAVINOVA ID
 yyH= Product ID (CVP-49= 3AH)
 11H= Clavinova Special Control Code
 0nH= Control MIDI Change
 (n= special control change number)
 ccH= Control number
 ddH= Control value

cc	Control	Value [dd]
08H	DUAL/SPLIT Balance	00H= lower MAX 7FH= upper MAX
10H	ABC Mode	00H= Off 01H= ABC Single Finger 02H= ABC Fingered 03H= Conventional Full-Keyboard ABC 04H= Full-Keyboard ABC
11H	Rhythm Variation	00H= Off 01H= Variation number
12H	Fill In Switch Event	00H= Fill to normal Off event 01H= Fill to normal On event 02H= Fill to variation On event 03H= Fill to variation Off event
13H	Intro/Ending Switch Event	00H= Intro/Ending Off 01H= Intro mode On 02H= Ending mode On 03H= Fill to normal mode On 04H= Fill to variation mode On
14H	Split	[ddH]= Split key number (the highest note in the left-hand keyboard range)
15H	Rhythm Number	[ddH]= Rhythm number
19H	Volume	[ddH]= Volume value n= 2 (BASS) 4 (CHORD 1) 5 (CHORD 2)
1AH	Rhythm Volume	[ddH]= Volume value
1BH	Metronome mode (receive only)	00H: Off 01H: On
21H	Solo Styleplay Number	00~17H= Style number
22H	Solo Styleplay	00H~3FH= Off 40H~7FH= On
30H	Drums Parameter Change	See Drum Parameter Expanded Format, below
59H	Reverb	00H= Off 01H= Room 02H= Hall 1 03H= Hall 2 04H= Cosmic

- 5AH Dual/Split mode 00H= Off
01H= Dual
02H= Split (upper damper)
03H= Split (lower damper)
04H= Split (upper/lower damper)
05H= Split & Lower Voice Oct Up (upper damper)
06H= Split & Lower Voice Oct Up (lower damper)
07H= SPLIT & Lower Voice Oct Up (upper/lower damper)

- 5CH Dual/Split Voice [ddH]= Dual/Split voice number
- 5DH Pedal Function [ddH]= Function number

* When cc = 59 (Reverb), SK common ID (01H) is recognized in addition to xxH.

Drum Parameter Expanded Format

[F0H] [43H] [73H] [xxH] [11H] [0nH]
 [30H] [xxH][F7H]
 xxH: Product ID;
 Common product ID also recognized (pattern editor transmits both).

0x30: /* Drum Parameter */ *2 Expanded Format

* This resets all parameters when a different drum kit is selected.

Expands Special Message 30.

• Effect Level

[F0H] [43H] [73H] [xxH] [11H] [0nH]
 [30H] [43H] [knH] [enH] [slH] [F7H]
 11H: Clavinova special control code
 0nH: MIDI Channel Number

* Received only on channel 15 (0EH) in the CVP-49, affecting all tracks.

Received only on channel 10 (09H) n the GM mode, affecting all tracks.

30H: Drums Parameter Change

43H: Effect Send Level

knH: Key Number

* Also included in the panel key code in the Clavinova Common Voice mode (because conversion is not possible). Included in the GM key code in the GM mode.

* When kn = 01 the en for all keys is set to the default.

When kn = 02 the en for all keys is set to s1.

enH: Effect Number

en= 5B: Reverb Depth

slH: Send Level

* This data applies a ± 40H offset to the CH depth parameter of each channel of each instrument.

Example

[F0H] [43H] [73H] [xxH] [11H] [0eH]
 [30H] [43H] [knH] [enH] [slH] [F7H]
 [knH] [enH] [slH]
 [36H] [5bH] [10H]:
 F#0 Brush Roll reverb depth set to -30H.
 [01H] [5bH] [xxH]:
 Reverb depth for all keys set to default (± 0).
 [02H] [5bH] [20H]:
 Reverb depth for all keys set to -20H.

• Pan Set Switching

[F0H] [43H] [73H] [xxH] [11H] [0nH]
 [30H] [47H] [knH] [pnH] [F7H]
 11H: Clavinova special control code
 0nH: MIDI Channel Number
 * Received only on channel 15 (0EH) in
 the CVP-49, affecting all tracks.
 Received only on channel 10 (09H) in
 the GM mode, affecting all tracks.
 30H: Drums Parameter Change
 47H: Panpot
 knH: Key Number
 * Also included in the panel key code in
 the Common Voice mode (because
 conversion is not possible). Included in
 the GM key code in the GM mode.
 * When kn = 01 pan is set to the value
 specified in pn.
 When kn = 02 the pan for all keys is set
 to the pin point specified in pn.
 pnH: Pan
 * When kn = 01 pan is set to the value
 specified in pn.
 pn= 00: Normal DOC Setting
 = 01: Narrow DOC left
 = 02: Narrow DOC center
 = 03: Narrow DOC right
 = 04: Normal GM Setting
 = 05: Narrow GM left
 = 06: Narrow GM center
 = 07: Narrow GM right
 * Normal pan value used when kn is other
 than 01.
 However, values 48...4F are also set to
 pin-point center.

• Absolute Tempo

[F0H] [43H] [73H] [yyH] [11H] [1nH]
 [ccH] [ddH] [F7H]
 43H= YAMAHA ID
 73H= CLAVINOVA ID
 yyH= Product ID (CVP-49= 3AH)
 11H= Clavinova special control code
 1nH= Control MIDI Change
 (Transmit: n = Control Change number)
 (Receive: any channel OK)
 cc= Absolute tempo low byte
 dd= Absolute tempo high byte
 Tempo= $dd \times 128 + ccH$

• Beat, Tempo LED ON/OFF

[F0H] [43H] [73H] [yyH] [11H] [4FH]
 [ccH] [ddH] [F7H]
 43H= YAMAHA ID
 73H= CLAVINOVA ID
 yyH= Product ID
 (CVP-49= 3AH, or common 01H)
 11H= Clavinova special control code
 4FH= Control MIDI Change
 ccH= 00H: Beat lamp on/off
 01H: Tempo lamp on/off
 ddH= 00H: On
 7FH: Off

• All MIDI data available for general use are
 given above.

Fingering Chart/Akkordliste/Tablature/Gráfica de digitado

* All fingerings shown are simple root-position types.

* Die hier gezeigten Akkorde sind jeweils die Grundakkorde.

* Tous les doigtés indiqués sont du type à position fondamentale simple.

* Todos los digitados se muestran como tipos de posición de raíz sencilla.

Example for "C" chords

Beispiele für "C"-Akkorde

Exemples d'accords en "C"

Ejemplo de acordes "C"

C

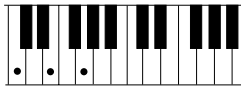

Cm

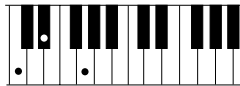

CM7



C6

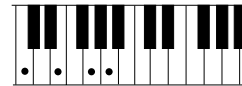

C7



Cm6

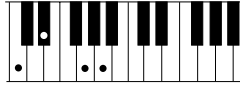

Cm7



CmM7

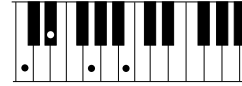

CM7 (b5)

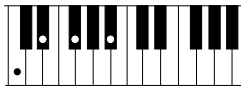

Cm (b5)

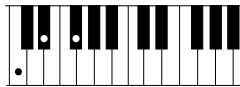

C (b5)

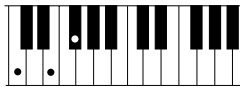

C7 (b5)

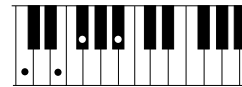

CM7 (b5)



C7sus4



Csus4



Caug



C7(#5)



CM7 (#5)



Cdim



CmM7 (b5)



		CVP-49
KEYBOARD	76 KEYS (E0 — G6)	
tone generator	AWM (Advanced Wave Memory)	
VOICE SELECTORS & CONTROLS	PIANO, CLAVINOVA TONE, E. PIANO, HARPSI, VIBES, GUITAR, STRINGS, ORGAN, CHOIR, UPRIGHT BASS, ELEC BASS, DRUMS, VOICE 13 - 60, ▲/▼, SPLIT	
AUTO BASS CHORD & CONTROLS	FULL KEYBOARD, SINGLE FINGER, FINGERED, SOLO STYLEPLAY, RHYTHM VOLUME, CHORD 1 VOLUME, CHORD 2 VOLUME, BASS VOLUME	
STYLE SELECTORS & CONTROLS	POP 1/2, DANCE POP 1/2, 16 BEAT 1/2, ROCK'N', 16 BEAT SHUFFLE, SLOW ROCK, SHUFFLE, COUNTRY 1/2, SWING, JAZZ BALLAD, BIG BAND, BOOGIE, BOSSA, SAMBA, CHA-CHA, RHUMBA, MARCH, MARCH 6/8, WALTZ, J. WALTZ START/STOP, SYNCHRO START, INTRO/ENDING, NORMAL/FILL TO NORMAL, VARIATION/ FILL TO VARIATION, TEMPO ▲/▼, TEMPO Display, BEAT LED, METRONOME	
KEYBOARD PERCUSSION	41 instruments (refer to page 8)	
REVERB	ROOM, HALL 1, HALL 2, COSMIC	
PERFORMANCE MEMORY	1, 2, ABC, RHYTHM, START/STOP, REC, CHORD SEQUENCE	
PEDAL CONTROLS	RIGHT	DAMPER
	LEFT	SOFT (SOSTENUTO, START/STOP, SOLO STYLEPLAY)
OTHER CONTROLS	MASTER VOLUME, MIDI/TRANPOSE, DEMO, POWER	
JACKS & CONNECTORS	PHONES, AUX OUT R and L/L+R, AUX IN R and L/L+R, MIDI IN/OUT	
INPUT & OUTPUT LEVEL/IMPEDANCE	AUX OUT: Output Impedance 600 Ω AUX IN: Input Impedance 10 kΩ / Input Sensitivity -10dBm	
MAIN AMPLIFIERS	60 W (30 W x 2)	
SPEAKERS	13 cm (5-1/8") x 2, 5 cm (2") x 2	
DIMENSIONS (W x D x H)	Music stand down: 1252 mm x 562 mm x 795 mm (49-1/4" x 22-1/8" x 31-1/4")	
	Music stand up: 1252 mm x 562 mm x 969 mm (49-1/4" x 22-1/8" x 38-1/8")	
WEIGHT	44.0 kg (97 lbs.)	

- * Specifications subject to change without notice.
- * Änderungen ohne Vorankündigung vorbehalten.
- * Sous toute réserve de modification des caractéristiques sans préavis.
- * Especificaciones sujetas a cambios sin previo aviso.

FCC INFORMATION (U.S.A.)

1. IMPORTANT NOTICE: DO NOT MODIFY THIS UNIT!

This product, when installed as indicated in the instructions contained in this manual, meets FCC requirements. Modifications not expressly approved by Yamaha may void your authority, granted by the FCC, to use the product.

2. IMPORTANT: When connecting this product to accessories and/or another product use only high quality shielded cables. Cable/s supplied with this product MUST be used. Follow all installation instructions. Failure to follow instructions could void your FCC authorization to use this product in the USA.

3. NOTE: This product has been tested and found to comply with the requirements listed in FCC Regulations, Part 15 for Class "B" digital devices. Compliance with these requirements provides a reasonable level of assurance that your use of this product in a residential environment will not result in harmful interference with other electronic devices. This equipment generates/uses radio frequencies and, if not installed and used according to the instructions found in the users manual, may cause interference harmful to the operation of other electronic devices.

Compliance with FCC regulations does not guarantee that interference will not occur in all installations. If this product is found to be the source of interference, which can be determined by turning the unit "OFF" and "ON", please try to eliminate the problem by using one of the following measures:

Relocate either this product or the device that is being affected by the interference.

Utilize power outlets that are on different branch (circuit breaker or fuse) circuits or install AC line filter/s.

In the case of radio or TV interference, relocate/reorient the antenna. If the antenna lead-in is 300 ohm ribbon lead, change the lead-in to co-axial type cable.

If these corrective measures do not produce satisfactory results, please contact the local retailer authorized to distribute this type of product. If you can not locate the appropriate retailer, please contact Yamaha Corporation of America, Electronic Service Division, 6600 Orangethorpe Ave, Buena Park, CA90620

The above statements apply ONLY to those products distributed by Yamaha Corporation of America or its subsidiaries.

* This applies only to products distributed by YAMAHA CORPORATION OF AMERICA.

IMPORTANT NOTICE FOR THE UNITED KINGDOM

Connecting the Plug and Cord

IMPORTANT. The wires in this mains lead are coloured in accordance with the following code:

BLUE : NEUTRAL
BROWN : LIVE

As the colours of the wires in the mains lead of this apparatus may not correspond with the coloured markings identifying the terminals in your plug proceed as follows:

The wire which is coloured BLUE must be connected to the terminal which is marked with the letter N or coloured BLACK.

The wire which is coloured BROWN must be connected to the terminal which is marked with the letter L or coloured RED.

Making sure that neither core is connected to the earth terminal of the three pin plug.

• This applies only to products distributed by Yamaha-Kemble Music (U.K.) Ltd.

CANADA

THIS DIGITAL APPARATUS DOES NOT EXCEED THE "CLASS B" LIMITS FOR RADIO NOISE EMISSIONS FROM DIGITAL APPARATUS SET OUT IN THE RADIO INTERFERENCE REGULATION OF THE CANADIAN DEPARTMENT OF COMMUNICATIONS.

LE PRESENT APPAREIL NUMERIQUE N'EMET PAS DE BRUITS RADIOELECTRIQUES DEPASSANT LES LIMITES APPLICABLES AUX APPAREILS NUMERIQUES DE LA "CLASSE B" PRESCRITES DANS LE REGLEMENT SUR LE BROUILLAGE RADIOELECTRIQUE EDICTE PAR LE MINISTERE DES COMMUNICATIONS DU CANADA.

CAUTION: TO PREVENT ELECTRIC SHOCK, MATCH WIDE BLADE OF PLUG TO WIDE SLOT, FULLY INSERT.

ATTENTION: POUR ÉVITER LES CHOCS ÉLECTRIQUES, INTRODUIRE LA LAME LA PLUS LARGE DE LA FICHE DANS LA BORNE CORRESPONDANTE DE LA PRISE ET POUSSER JUSQU'AU FOND.

• This applies only to products distributed by Yamaha Canada Music Ltd.
• Ceci ne s'applique qu'aux produits distribués par Yamaha Canada Musique Ltée.

IMPORTANT SAFETY INSTRUCTIONS

INFORMATION RELATING TO PERSONAL INJURY, ELECTRICAL SHOCK, AND FIRE HAZARD POSSIBILITIES HAS BEEN INCLUDED IN THIS LIST.

WARNING- When using any electrical or electronic product, basic precautions should always be followed. These precautions include, but are not limited to, the following:

- 1.** Read all Safety Instructions, Installation Instructions, Special Message Section items, and any Assembly Instructions found in this manual **BEFORE** making any connections, including connection to the main supply.
- 2.** Main Power Supply Verification: Yamaha products are manufactured specifically for the supply voltage in the area where they are to be sold. If you should move, or if any doubt exists about the supply voltage in your area, please contact your dealer for supply voltage verification and (if applicable) instructions. The required supply voltage is printed on the name plate. For name plate location, please refer to the graphic found in the Special Message Section of this manual.
- 3.** This product may be equipped with a polarized plug (one blade wider than the other). If you are unable to insert the plug into the outlet, turn the plug over and try again. If the problem persists, contact an electrician to have the obsolete outlet replaced. Do **NOT** defeat the safety purpose of the plug.
- 4.** Some electronic products utilize external power supplies or adapters. Do **NOT** connect this type of product to any power supply or adapter other than one described in the owners manual, on the name plate, or specifically recommended by Yamaha.
- 5.** **WARNING:** Do not place this product or any other objects on the power cord or place it in a position where anyone could walk on, trip over, or roll anything over power or connecting cords of any kind. The use of an extension cord is not recommended! If you must use an extension cord, the minimum wire size for a 25' cord (or less) is 18 AWG. **NOTE:** The smaller the AWG number, the larger the current handling capacity. For longer extension cords, consult a local electrician.
- 6.** Ventilation: Electronic products, unless specifically designed for enclosed installations, should be placed in locations that do not interfere with proper ventilation. If instructions for enclosed installations are not provided, it must be assumed that unobstructed ventilation is required.
- 7.** Temperature considerations: Electronic products should be installed in locations that do not significantly contribute to their operating temperature. Placement of this product close to heat sources such as; radiators, heat registers and other devices that produce heat should be avoided.
- 8.** This product was **NOT** designed for use in wet/damp locations and should not be used near water or exposed to rain. Examples of wet/damp locations are; near a swimming pool, spa, tub, sink, or wet basement.
- 9.** This product should be used only with the components supplied or; a cart, rack, or stand that is recommended by the manufacturer. If a cart, rack, or stand is used, please observe all safety markings and instructions that accompany the accessory product.
- 10.** The power supply cord (plug) should be disconnected from the outlet when electronic products are to be left unused for extended periods of time. Cords should also be disconnected when there is a high probability of lightning and/or electrical storm activity.
- 11.** Care should be taken that objects do not fall and liquids are not spilled into the enclosure through any openings that may exist.
- 12.** Electrical/electronic products should be serviced by a qualified service person when:
 - a. The power supply cord has been damaged; or
 - b. Objects have fallen, been inserted, or liquids have been spilled into the enclosure through openings; or
 - c. The product has been exposed to rain; or
 - d. The product does not operate, exhibits a marked change in performance; or
 - e. The product has been dropped, or the enclosure of the product has been damaged.
- 13.** Do not attempt to service this product beyond that described in the user-maintenance instructions. All other servicing should be referred to qualified service personnel.
- 14.** This product, either alone or in combination with an amplifier and headphones or speaker/s, may be capable of producing sound levels that could cause permanent hearing loss. **DO NOT** operate for a long period of time at a high volume level or at a level that is uncomfortable. If you experience any hearing loss or ringing in the ears, you should consult an audiologist. **IMPORTANT:** The louder the sound, the shorter the time period before damage occurs.
- 15.** Some Yamaha products may have benches and/or accessory mounting fixtures that are either supplied as a part of the product or as optional accessories. Some of these items are designed to be dealer assembled or installed. Please make sure that benches are stable and any optional fixtures (where applicable) are well secured **BEFORE** using. Benches supplied by Yamaha are designed for seating only. No other uses are recommended.

PLEASE KEEP THIS MANUAL

YAMAHA
YAMAHA CORPORATION

Free Manuals Download Website

<http://myh66.com>

<http://usermanuals.us>

<http://www.somanuals.com>

<http://www.4manuals.cc>

<http://www.manual-lib.com>

<http://www.404manual.com>

<http://www.luxmanual.com>

<http://aubethermostatmanual.com>

Golf course search by state

<http://golfingnear.com>

Email search by domain

<http://emailbydomain.com>

Auto manuals search

<http://auto.somanuals.com>

TV manuals search

<http://tv.somanuals.com>