



DTX

drums

DRUM TRIGGER MODULE
CONVERTISSEUR DE SONS POUR BATTERIE

DTX502

Owner's Manual
Mode d'emploi

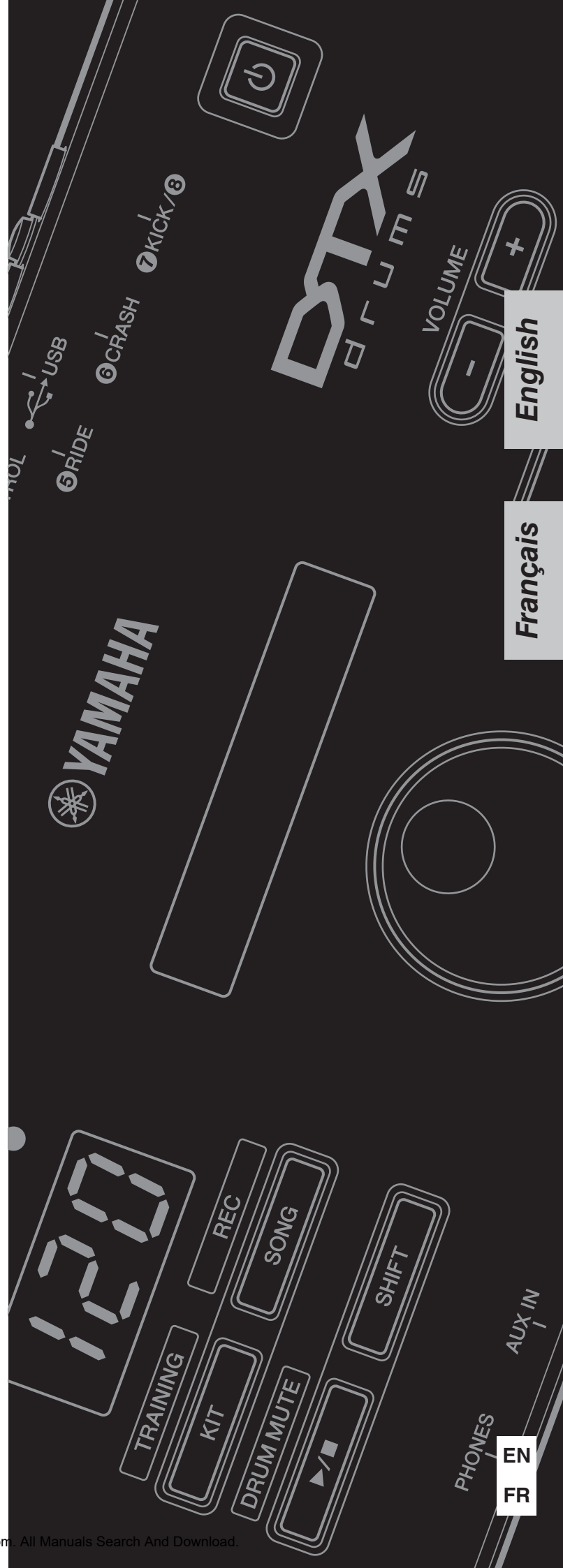

English

Français

EN
FR

Contents

Welcome	6	Customizing the Metronome	32
Product Manuals	6	Selecting a Click Set	32
<hr/>		Setting the Tempo	33
Setup		Setting the Time Signature	33
First Steps	7	Setting the Timer	33
Quick Start Guide	8	Setting Individual Volumes	34
Choosing Drum Sounds	8	Changing Sounds for All Subdivisions	34
Playing Along with a Song	8	Changing Sounds for Individual Subdivisions	35
Practicing with the Metronome	8	Tuning Click-Set Sounds	36
Practicing in Training Mode	9	Tapping the Tempo on the Pads	36
Recording Your Performances	9	Storing a Customized Click Set	37
Component Names & Functions	10	Practicing in Training Mode	38
Control Panel	10	1. Groove Check	38
Rear Panel	11	2. Rhythm Gate	40
Setting Up for Sound	12	3. Measure Break	41
Connecting the Power	12	4. Tempo Up/Down	42
Connecting Headphones or Speakers	12	5. Change Up	44
Connecting a Music Player	12	6. Pad Gate	46
Turning On the Drum Module	13	7. Part Mute	47
Initial Setup	13	8. Fast Blast	49
Quickly Disabling Auto Power-Off	13	Recording Your Performances	51
Turning Off the Drum Module	14	Getting Ready	51
Restoring the Default Settings	14	Recording	52
<hr/>		Playing Back a Performance	52
Basic Techniques		Naming a User Song	53
Basic DTX502 Operations	15	Deleting a Recorded Performance	54
Striking the Drum Pads	16	<hr/>	
Snare	16	Advanced Techniques	
Hi-hats	17	Setting Parameters using Menu Mode	55
Cymbals	18	Setting Procedure	56
Selecting & Playing a Kit	19	Storing your settings	56
Selecting a Kit	19	Integrating Separately Sold Accessories	76
Adjusting Pad Sensitivity	19	Adding a PCY90AT Cymbal Pad	76
Balancing Instrument Volumes	19	Using a KU100 Kick Unit as a Kick Pedal	76
Building Your Own Unique Kits	20	Integrating Electronic & Acoustic Drums	77
Assigning Voices to Instruments	21	Adding Drum Pads to an Acoustic Drum Set	77
Tuning & Changing Cymbal Sizes	22	Playing the DTX502 Using Acoustic Drums	77
Customizing Instrument Voices	23	Mounting the DTX502 on a Hi-Hat Stand	78
Adjusting Instrument Volumes	24	Connecting to a Computer	79
Adjusting the Stereo Panning of Instruments	24	Making Connections	79
Saving Customized Kits	25	DTX502 Reference Manual	79
Performing with a Song	26	<hr/>	
Selecting a Song	26	Reference	
Adjusting the Song Volume	26	Error Messages	80
Adjusting the Song Tempo	27	Troubleshooting	81
Muting a Song's Drum Parts	27	Data List	83
Looping a Song	28	Specifications	88
Playing with Count-In	28	Index	89
Playing Pad Songs	29	<hr/>	
Using the Metronome	31		
Starting & Stopping	31		
Adjusting the Tempo	31		
Setting the Overall Volume	31		

SPECIAL MESSAGE SECTION

This product utilizes batteries or an external power supply (adapter). DO NOT connect this product to any power supply or adapter other than one described in the manual, on the name plate, or specifically recommended by Yamaha.

This product should be used only with the components supplied or; a cart, rack, or stand that is recommended by Yamaha. If a cart, etc., is used, please observe all safety markings and instructions that accompany the accessory product.

SPECIFICATIONS SUBJECT TO CHANGE:

The information contained in this manual is believed to be correct at the time of printing. However, Yamaha reserves the right to change or modify any of the specifications without notice or obligation to update existing units.

This product, either alone or in combination with an amplifier and headphones or speaker/s, may be capable of producing sound levels that could cause permanent hearing loss. DO NOT operate for long periods of time at a high volume level or at a level that is uncomfortable. If you experience any hearing loss or ringing in the ears, you should consult an audiologist.

IMPORTANT: The louder the sound, the shorter the time period before damage occurs.

NOTICE:

Service charges incurred due to a lack of knowledge relating to how a function or effect works (when the unit is operating as designed) are not covered by the manufacturer's warranty, and are therefore the owners responsibility. Please study this manual carefully and consult your dealer before requesting service.

ENVIRONMENTAL ISSUES:

Yamaha strives to produce products that are both user safe and environmentally friendly. We sincerely believe that our products and the production methods used to produce them, meet these goals. In keeping with both the letter and the spirit of the law, we want you to be aware of the following:

Battery Notice:

This product MAY contain a small non-rechargeable battery which (if applicable) is soldered in place. The average life span of this type of battery is approximately five years. When replacement becomes necessary, contact a qualified service representative to perform the replacement.

This product may also use "household" type batteries. Some of these may be rechargeable. Make sure that the battery being charged is a rechargeable type and that the charger is intended for the battery being charged.

When installing batteries, never mix old batteries with new ones, and never mix different types of batteries. Batteries MUST be installed correctly. Mismatches or incorrect installation may result in overheating and battery case rupture.

Warning:

Do not attempt to disassemble, or incinerate any battery. Keep all batteries away from children. Dispose of used batteries promptly and as regulated by the laws in your area. Note: Check with any retailer of household type batteries in your area for battery disposal information.

Disposal Notice:

Should this product become damaged beyond repair, or for some reason its useful life is considered to be at an end, please observe all local, state, and federal regulations that relate to the disposal of products that contain lead, batteries, plastics, etc. If your dealer is unable to assist you, please contact Yamaha directly.

NAME PLATE LOCATION:

The name plate is located on the bottom of the product. The model number, serial number, power requirements, etc., are located on this plate. You should record the model number, serial number, and the date of purchase in the spaces provided below and retain this manual as a permanent record of your purchase.

Model

Serial No.

Purchase Date

92-BP (bottom)

PLEASE KEEP THIS MANUAL

FCC INFORMATION (U.S.A.)

1. IMPORTANT NOTICE: DO NOT MODIFY THIS UNIT!

This product, when installed as indicated in the instructions contained in this manual, meets FCC requirements. Modifications not expressly approved by Yamaha may void your authority, granted by the FCC, to use the product.

2. IMPORTANT: When connecting this product to accessories and/or another product use only high quality shielded cables. Cable/s supplied with this product MUST be used. Follow all installation instructions. Failure to follow instructions could void your FCC authorization to use this product in the USA.

3. NOTE: This product has been tested and found to comply with the requirements listed in FCC Regulations, Part 15 for Class "B" digital devices. Compliance with these requirements provides a reasonable level of assurance that your use of this product in a residential environment will not result in harmful interference with other electronic devices. This equipment generates/uses radio frequencies and, if not installed and used according to the instructions found in the users manual, may cause interference harmful to the operation of other electronic devices. Compliance with FCC regulations does not guar-

antee that interference will not occur in all installations. If this product is found to be the source of interference, which can be determined by turning the unit "OFF" and "ON," please try to eliminate the problem by using one of the following measures:

Relocate either this product or the device that is being affected by the interference.

Utilize power outlets that are on different branch (circuit breaker or fuse) circuits or install AC line filter/s.

In the case of radio or TV interference, relocate/reorient the antenna. If the antenna lead-in is 300 ohm ribbon lead, change the lead-in to co-axial type cable.

If these corrective measures do not produce satisfactory results, please contact the local retailer authorized to distribute this type of product. If you can not locate the appropriate retailer, please contact Yamaha Corporation of America, Electronic Service Division, 6600 Orangethorpe Ave, Buena Park, CA90620

The above statements apply ONLY to those products distributed by Yamaha Corporation of America or its subsidiaries.

* This applies only to products distributed by YAMAHA CORPORATION OF AMERICA.

(class B)

COMPLIANCE INFORMATION STATEMENT (DECLARATION OF CONFORMITY PROCEDURE)

Responsible Party : Yamaha Corporation of America
Address : 6600 Orangethorpe Ave., Buena Park, Calif. 90620
Telephone : 714-522-9011
Type of Equipment : DRUM TRIGGER MODULE
Model Name : DTX502

This device complies with Part 15 of the FCC Rules. Operation is subject to the following two conditions:
1) this device may not cause harmful interference, and
2) this device must accept any interference received including interference that may cause undesired operation.
See user manual instructions if interference to radio reception is suspected.

* This applies only to products distributed by YAMAHA CORPORATION OF AMERICA.

(FCC DoC)

PRECAUTIONS

PLEASE READ CAREFULLY BEFORE PROCEEDING

Please keep this manual in a safe and handy place for future reference.



WARNING

Always follow the basic precautions listed below to avoid the possibility of serious injury or even death from electrical shock, short-circuiting, damages, fire or other hazards. These precautions include, but are not limited to, the following:

Power supply/AC power adaptor

- Do not place the power cord near heat sources such as heaters or radiators. Also, do not excessively bend or otherwise damage the cord, or place heavy objects on it.
- Only use the voltage specified as correct for the instrument. The required voltage is printed on the name plate of the instrument.
- Use the specified adaptor (page 88) only. Using the wrong adaptor can result in damage to the instrument or overheating.
- Check the electric plug periodically and remove any dirt or dust which may have accumulated on it.

Do not open

- This instrument contains no user-serviceable parts. Do not open the instrument or attempt to disassemble or modify the internal components in any way. If it should appear to be malfunctioning, discontinue use immediately and have it inspected by qualified Yamaha service personnel.

Water warning

- Do not expose the instrument to rain, use it near water or in damp or wet conditions, place on it any containers (such as vases, bottles or glasses) containing liquids which might spill into any openings. If any liquid such as water seeps into the instrument, turn off the power immediately and unplug the power cord from the AC outlet. Then have the instrument inspected by qualified Yamaha service personnel.
- Never insert or remove an electric plug with wet hands.

Fire warning

- Do not put burning items, such as candles, on the unit. A burning item may fall over and cause a fire.

If you notice any abnormality

- When one of the following problems occur, immediately turn off the power switch and disconnect the electric plug from the outlet. Then have the device inspected by Yamaha service personnel.
 - The power cord or plug becomes frayed or damaged.
 - It emits unusual smells or smoke.
 - Some object has been dropped into the instrument.
 - There is a sudden loss of sound during use of the instrument.



CAUTION

Always follow the basic precautions listed below to avoid the possibility of physical injury to you or others, or damage to the instrument or other property. These precautions include, but are not limited to, the following:

Power supply/AC power adaptor

- Do not connect the instrument to an electrical outlet using a multiple-connector. Doing so can result in lower sound quality, or possibly cause overheating in the outlet.
- When removing the electric plug from the instrument or an outlet, always hold the plug itself and not the cord. Pulling by the cord can damage it.
- Remove the electric plug from the outlet when the instrument is not to be used for extended periods of time, or during electrical storms.

Location

- Do not place the instrument in an unstable position where it might accidentally fall over.
- Before moving the instrument, remove all connected cables, to prevent damage to the cables or injury to anyone who might trip over them.
- When setting up the product, make sure that the AC outlet you are using is easily accessible. If some trouble or malfunction occurs, immediately turn off the power switch and disconnect the plug from the outlet. Even when the power switch is turned off, electricity is still flowing to the product at the minimum level. When you are not using the product for a long time, make sure to unplug the power cord from the wall AC outlet.
- Use only the stand/rack specified for the instrument. When attaching the stand or rack, use the provided screws only. Failure to do so could cause damage to the internal components or result in the instrument falling over.

Connections

- Before connecting the instrument to other electronic components, turn off the power for all components. Before turning the power on or off for all components, set all volume levels to minimum.
- Be sure to set the volumes of all components at their minimum levels and gradually raise the volume controls while playing the instrument to set the desired listening level.

Handling caution

- Do not insert a finger or hand in any gaps on the instrument.
- Never insert or drop paper, metallic, or other objects into the gaps on the panel. This could cause physical injury to you or others, damage to the instrument or other property, or operational failure.
- Do not rest your weight on, or place heavy objects on the instrument, and do not use excessive force on the buttons, switches or connectors.
- Do not use the instrument/device or headphones for a long period of time at a high or uncomfortable volume level, since this can cause permanent hearing loss. If you experience any hearing loss or ringing in the ears, consult a physician.

Yamaha cannot be held responsible for damage caused by improper use or modifications to the instrument, or data that is lost or destroyed.

Always turn the power off when the instrument is not in use.

Even when the [] (Standby/On) switch is in standby status (display is off), electricity is still flowing to the instrument at the minimum level.

When you are not using the instrument for a long time, make sure you unplug the power cord from the wall AC outlet.

NOTICE

To avoid the possibility of malfunction/ damage to the product, damage to data, or damage to other property, follow the notices below.

■ Handling and Maintenance

- Do not use the instrument in the vicinity of a TV, radio, stereo equipment, mobile phone, or other electric devices. Otherwise, the instrument, TV, or radio may generate noise.
- Do not expose the instrument to excessive dust or vibrations, or extreme cold or heat (such as in direct sunlight, near a heater, or in a car during the day) to prevent the possibility of panel disfiguration, damage to the internal components or unstable operation.
- Do not place vinyl, plastic or rubber objects on the instrument, since this might discolor the panel or keyboard.
- When cleaning the instrument, use a soft, dry cloth. Do not use paint thinners, solvents, cleaning fluids, or chemical-impregnated wiping cloths.

Information

■ About copyrights

- Copying of the commercially available musical data including but not limited to MIDI data and/or audio data is strictly prohibited except for your personal use.
- This product incorporates and bundles computer programs and contents in which Yamaha owns copyrights or with respect to which it has license to use others' copyrights. Such copyrighted materials include, without limitation, all computer software, style files, MIDI files, WAVE data, musical scores and sound recordings. Any unauthorized use of such programs and contents outside of personal use is not permitted under relevant laws. Any violation of copyright has legal consequences. **DON'T MAKE, DISTRIBUTE OR USE ILLEGAL COPIES.**

■ About this manual

- The illustrations and LCD screens as shown in this manual are for instructional purposes only, and may appear somewhat different from those on your instrument.
- The company names and product names in this manual are the trademarks or registered trademarks of their respective companies.

■ Optional Pads

Within this Owner's Manual, the optional external pads that may be connected to the drum module are referred to by model name. Please note that these model names were up-to-date as of printing of this manual. Details regarding any subsequently released models will be made available via the following web site.

<http://www.yamaha.com/>

Welcome

Thank you for purchasing a Yamaha DTX502 Electronic Drum Module.
In order to get the most out of your new instrument, please be sure to read this owner's manual carefully.
And after doing so, be sure to store this manual in a safe place
so that you can refer back to it again as needed.

Product Manuals

■ Owner's Manual (this booklet)—Setup, Basic Techniques, Advanced Techniques, and Reference sections.

Setup:

Describes how to get your DTX502 drum module set up for playing and making initial settings.

Basic Techniques:

Describes the basic techniques used when operating and playing the DTX502.

Advanced Techniques:

Describes the setting of parameters and other more advanced modes of use.

Reference:

Describes troubleshooting techniques and contains other reference materials.

■ Reference Manual

*: **The Reference Manual is not bundled together with the drum module. See page 79 for more details.**

The Reference Manual for the DTX502 is made available as a PDF document and contains the following.

- Instructions on how to transfer kit data, song data, and audio data from your computer to the drum module.
- Reference material that will prove useful when making music using the drum module and a computer
- MIDI-related reference information

● Using PDF Manuals

The Reference Manual for your DTX502 is made available in digital format as a PDF document. As such, a computer and suitable software will be required in order to read it. We recommend that Adobe® Reader® be used for this purpose as it allows you to quickly and easily search for keywords, to print out specific sections, and to conveniently jump from page to page by clicking embedded links. Keyword searching and link-based navigation in particular are extremely useful functions available only with digital-type documents.

The most-recent version of Adobe® Reader® can be downloaded from the following web page.

<http://www.adobe.com/products/reader/>

Package contents

- Power adaptor
 - * May not be included depending on your particular area. Please check with your Yamaha dealer.
- Module holder
- Module-holder screw (x2)
- Owner's Manual (this booklet)

First Steps

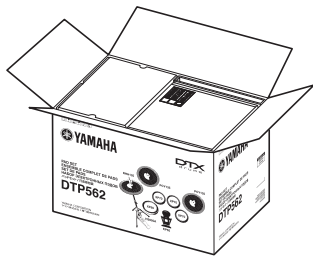

1. Open the packages to reveal their contents.

- DTX502 Drum Trigger Module
- Rack (i.e., RS502)
- Pad set (i.e., DTP522, DTP532, DTP542, or DTP562)

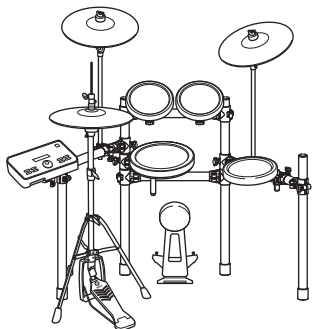

2. Assemble the parts

- Assemble the rack.
 - Refer to the Owner's Manual that came with your rack (i.e., RS502).
- Mount the pads and the DTX502 module on the rack.
 - Refer to the Assembly Manual that came with your pad set.

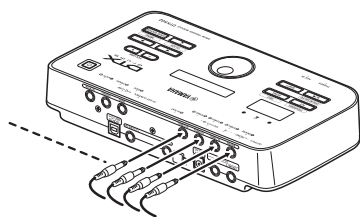

3. Make the required connections.

- Connect the pads and the DTX502 using the cable provided.
 - Refer to the Assembly Manual that came with your pad set.
- Connect the power adaptor to the DTX502 module and turn on the module.
 - See page 12 of this booklet.

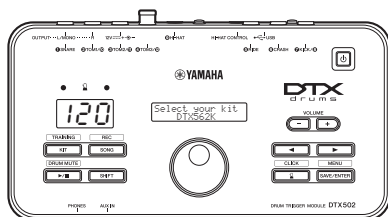

4. Complete the initial setup process.

- See Initial Setup on page 13.

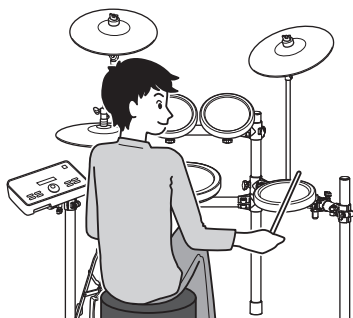

5. Play your electronic drum kit.

- Basic techniques used when operating and playing the electronic drum kit are described in the Basic Techniques section (pages 15 to 54).
- More complex methods are described in the Advanced Techniques section (pages 55 to 79).

Quick Start Guide

Choosing Drum Sounds (page 19)

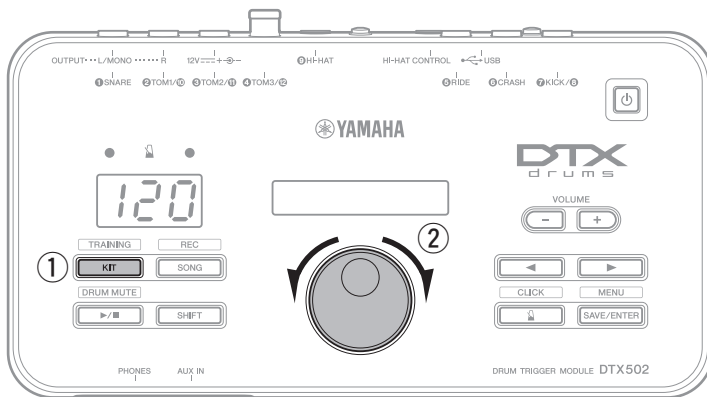

- ① Press the [KIT] button.
- ② Turn the Data Dial to select a different drum kit.

You can also assign sounds to individual pads. (See page 20.)

Playing Along with a Song (page 26)

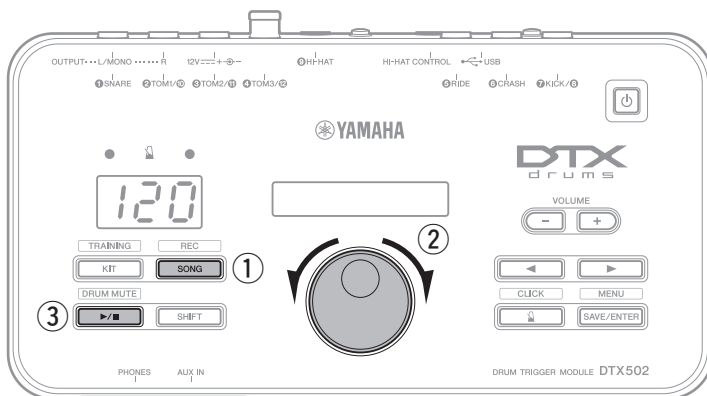

- ① Press the [SONG] button.
- ② Turn the Data Dial to select a different song.
- ③ Press the [▶/■] button to start playback of the song.

To mute the song's drum parts, hold down the [SHIFT] button and press the [▶/■] button once again.

Practicing with the Metronome (page 31)

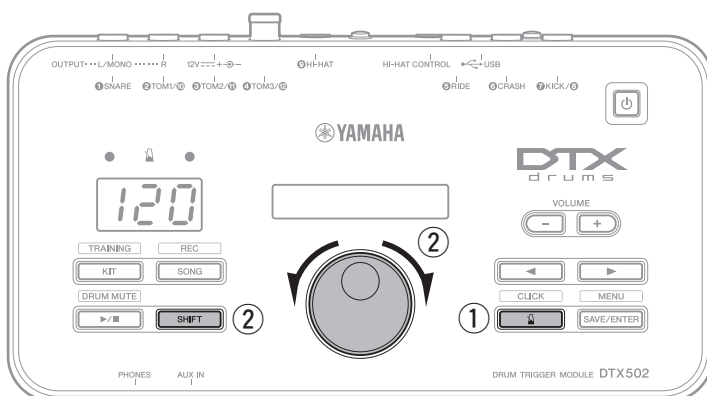

- ① Press the [M] button.
- ② To adjust the tempo, hold down the [SHIFT] button and turn the Data Dial.

Practicing in Training Mode (page 38)

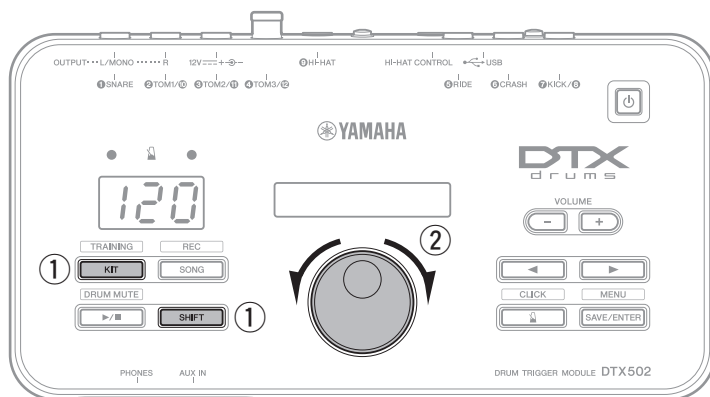

- ① Hold down the [SHIFT] button and press the [KIT] button.
- ② Turn the Data Dial to select one of the drum module's training options.
- ③ Press the flashing button ([▶/■] or [▶]) when you are ready to go.

Eight different training options are available on your DTX502. See page 38 for more details of each.

Recording Your Performances (page 51)

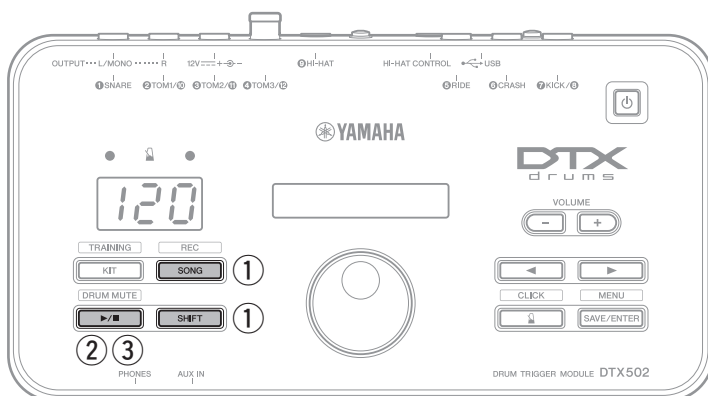

- ① Hold down the [SHIFT] button and press the [SONG] button.
- ② Press the [▶/■] button to start recording.
- ③ When you are finished drumming, press the [▶] button to stop recording.

You can use the [▶/■] button to start and stop the playback of your recording. (See page 52.)

Component Names & Functions

Control Panel

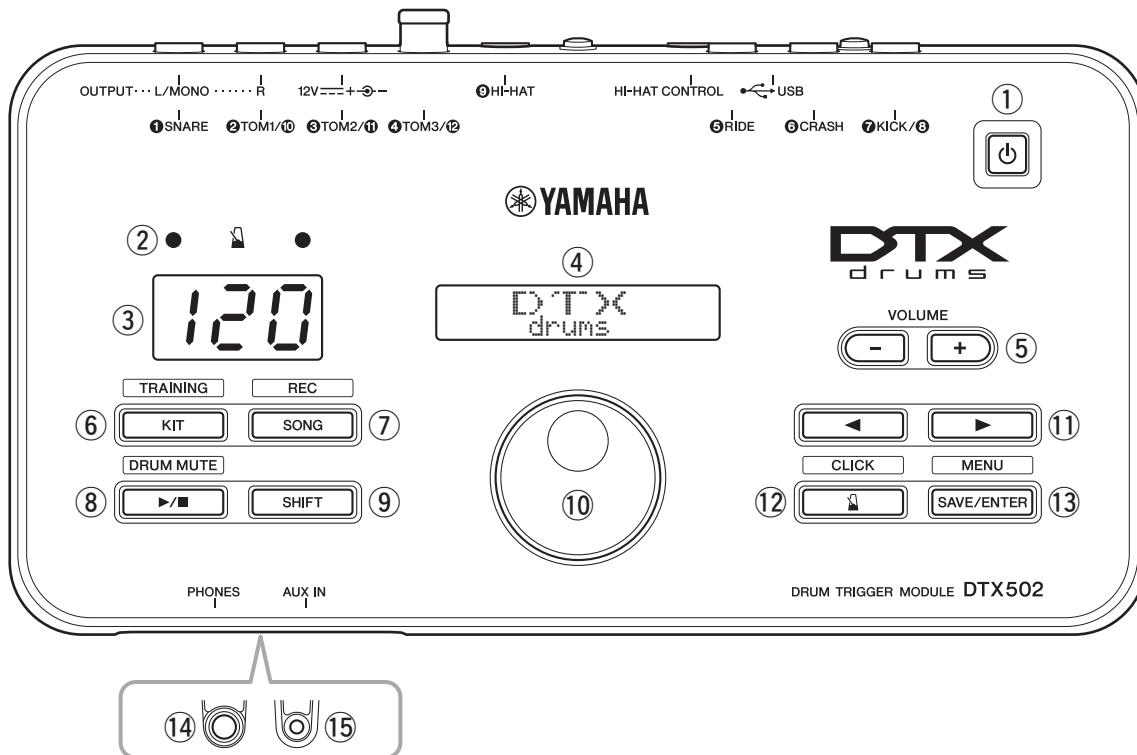

① [⏻] (Standby/On) button (page 13)

Use this button to turn the drum module on and off.

② Metronome lights

When the metronome is playing, the red light flashes on the start of each measure; the green light flashes on every other beat.

③ Number display

The number display is used to indicate the tempo, mode-specific numbers, and timer values. (See page 74.)

④ LCD screen

The LCD screen presents information needed to operate the DTX502.

⑤ VOLUME [+] and [-] buttons (page 15)

These buttons are used to adjust the overall DTX502 volume—that is, the volume of sound output via the OUTPUT and [PHONES] jacks.

⑥ [KIT] button (page 19)

- Press the [KIT] button to open the page for selecting different drum kits.
- Hold down the [SHIFT] button and press the [KIT] button to access Training Mode.
- You can also immediately silence all sounds by pressing the [KIT] button.

⑦ [SONG] button (page 26)

- Press the [SONG] button to open the page for selecting different songs.
- Hold down the [SHIFT] button and press the [SONG] button to put the drum module on standby for recording.

⑧ [▶/■] button (page 26)

- Press the [▶/■] button to start and stop song playback.
- You can also start and stop training using the [▶/■] button.
- Hold down the [SHIFT] button and press the [▶/■] button to mute and unmute a song's drum parts.

⑨ [SHIFT] button

To access the setting area or function indicated above any button, press it while holding down the [SHIFT] button.



⑩ Data Dial

- Turn the Data Dial to change the value selected by the flashing cursor. To increase values, turn it clockwise and vice-versa.
- Hold down the [SHIFT] button and turn the Data Dial to change the tempo.

⑪ [◀/▶] buttons

- Press the [◀/▶] buttons to move the flashing cursor between on-screen items. If a setting area has more parameters than will fit on a single page, these buttons can be used to move between the area's pages.
- Hold down the [SHIFT] button and press the [◀/▶] buttons to select the pad to be set.

⑫ [] button (page 31)

- Press the [] button to start and stop the built-in metronome.
- In Training Mode, you can use the [] button to start and stop practice sessions.
- Hold down the [SHIFT] button and press the [] button to access the area for advanced metronome settings.

⑬ [SAVE/ENTER] button

- Press the [SAVE/ENTER] button when you want to store your data.
- Hold down the [SHIFT] button and press the [SAVE/ENTER] button to access Menu Mode for advanced DTX502 settings.

⑭ [PHONES] jack

Use this standard audio jack to connect a pair of stereo headphones.

⑮ [AUX IN] jack (page 12)

The Auxiliary Input stereo mini-jack is used to input audio from an external source into the DTX502. For example, you can use this jack to connect a portable music player, a CD player, or another similar device and play along with your favorite tunes.

Rear Panel

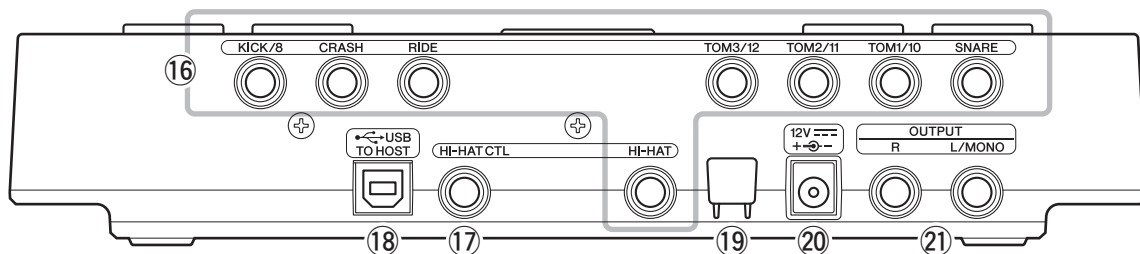

⑯ Trigger input jacks ([①SNARE] to [⑨HI-HAT])

These trigger input jacks are used to connect pads and/or drum triggers (such as the Yamaha DT10 or DT20) to your DTX502 so that it may produce sounds in response to the trigger signals they output.

• [①SNARE]

This jack supports three-zone pads and pad controllers.

• [②TOM1/⑩], [③TOM2/⑪], [④TOM3/⑫], and [⑦KICK/⑧]

- Each of these jacks comprises a pair of mono trigger inputs. Using a separately-sold Y-cable*, you can route trigger signals from mono pads into inputs ⑧, ⑩, ⑪, and ⑫. (*: For converting a stereo plug into two mono jacks; see the illustration below.) When a KP65 Kick Pad is connected here, an additional mono pad can be connected via the input jack on the back of the kick pad.

- These jacks also support dual piezo pads.

• [⑤RIDE] and [⑥CRASH]

These trigger input jacks support three-zone pads

• [⑨HI-HAT]

This trigger input jack supports three-zone pads and stereo pads.

● Y-cable

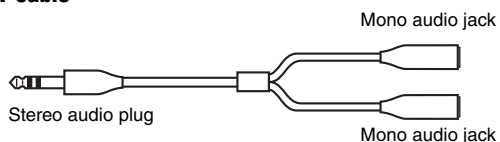

⑰ [HI-HAT CONTROL] jack

This jack is used to connect an HH65 Hi-hat Controller or the [HI-HAT CONTROL] output jack of an RHH135 Real Hi-hat Pad.

⑱ [USB TO HOST] terminal (page 79)

This terminal is used to connect the DTX502 to a computer's USB terminal via a USB cable.

⑲ Cord clip (page 12)

Wrap the power adaptor's DC cord around this clip to prevent accidental unplugging during use.

⑳ [12V + -] connector (page 12)

Use this connector for the power adaptor that came with your drum module.

㉑ OUTPUT [L/MONO] and [R] jacks (page 12)

These standard jacks are used to output audio from the DTX502. If mono output is required, only the [L/MONO] jack should be connected.

Setting Up for Sound

Connecting the Power

1. Ensure that your drum module is turned off (i.e., nothing is visible on the LCD screen).
2. Insert the power adaptor's DC plug into the [12V \equiv + \ominus -] connector on the rear panel.
3. Hook the power adaptor's DC cord around the cord clip to prevent it from being accidentally pulled out.

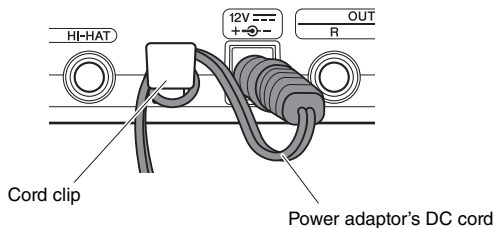

CAUTION

Excessive bending can damage the power adaptor cord and create a fire hazard. Ensure, therefore, that the power cord is not bent at an extreme angle when wrapped around the clip.

4. Plug the power adaptor's AC power cord into a domestic wall socket.

WARNING

Use only the specified adaptor. The use of other adaptors may result in irreparable damage to both the adaptor and the instrument.

CAUTION

Even when the power of this instrument is in the Standby status, electricity is still flowing to the instrument at the minimum level. When you are not using the instrument for a long time, make sure you unplug the power adaptor from the wall AC outlet.

Connecting Headphones or Speakers

Your DTX502 does not feature built-in speakers. In order to hear it, therefore, you will need to connect headphones or a DTX-series monitor system, such as the MS40DR. You can adjust the output volume using the VOLUME [+] and [-] buttons on the control panel.

● Connecting headphones

Plug your headphones into the [PHONES] jack (for standard stereo audio).

● Connecting speakers

Connect your speakers to the OUTPUT [L/MONO] and [R] jacks (for standard mono audio).

CAUTION

To prevent hearing loss, avoid using headphones at a high volume for extended periods of time.

Connecting a Music Player

You can connect a portable music player or another similar source of audio to your drum module via the [AUX IN] (auxiliary input) stereo mini-jack. This makes it possible to play along with your favorite tunes.

NOTICE

- Whenever connecting other devices, ensure that the cables you use have plugs that match the input or output connectors on those devices.
- Before making connections, furthermore, you should also turn the volume on the other devices fully down.
- When all connections have been made, use each device's volume controller to balance its output with that of the drum module.

● Control panel

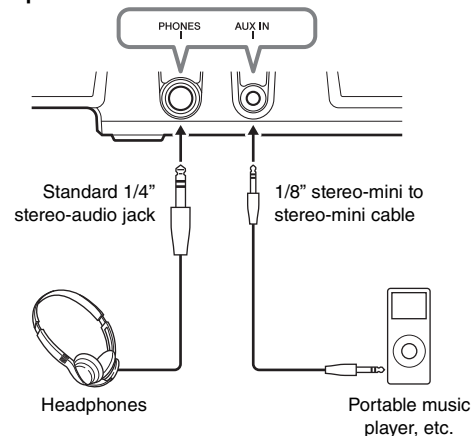

● Rear panel

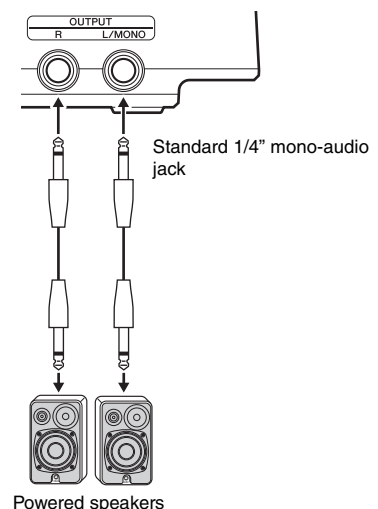

Turning On the Drum Module

1. If you have connected your drum module to other audio devices such as powered speakers, ensure that the volume on those devices is turned down fully.
2. Press the [] (Standby/On) button.



Initial Setup

When you turn on your DTX502 for the first time, the Initial Setup page will be displayed. On this page, you will be required to specify the following.

● Your drum kit's model number

When you specify the model number, the DTX502 will automatically optimize the trigger output levels for all of your pads.

● Auto Power-Off time

The Auto Power-Off function automatically turns off the DTX502 after a certain period of inactivity. This helps to conserve energy should you forget to turn it off yourself.

1. Identify your drum kit using the Data Dial and press the [SAVE/ENTER] button.

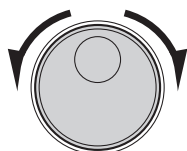

Select your kit
DTX562K



[SAVE/ENTER]

Settings	DTX522K, DTX532K, DTX542K, DTX562K, DTX500K, DTX520K, DTX530K, DTX540K, DTX550K, DTX560K, DTXP4STD (DTX-PRESS IV STD SET), DTXP4SP (DTX-PRESS IV SP SET), DTXPL (DTXPLOER), DrumTrig, and UserTrig
-----------------	--

NOTE

- Your drum kit's model number is indicated on the box it came in.
- You can change the specified drum kit at any time after completing Initial Setup. For details, see the description of the Trigger Setup page from Menu Mode (page 66).

2. Using the Data Dial, select how long the DTX502 should wait before turning off automatically, and then press the [SAVE/ENTER] button.

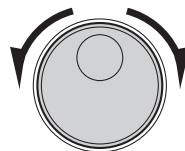

Auto Power Off
Timer= 30min



[SAVE/ENTER]

Settings	off (i.e., Auto Power-Off function disabled), 5min, 10min, 15min, 30min, 60min, and 120min
-----------------	--

NOTICE

- Any unsaved changes to parameters will be lost when the drum module is turned off by the Auto Power-Off function. Remember to store modified settings regularly.
- In certain modes of operation, the Auto Power-Off function will not turn off the drum module when the set time has elapsed. We recommend, therefore, that you always turn off the drum module manually when you are finished using it.
- If you expect your DTX502 to be inactive for a certain length of time while connected to other audio equipment, we recommend that you turn the volume on the other equipment fully down. Alternatively, you can disable the Auto Power-Off function to ensure that the drum module stays on.

NOTE

- Settings for the Auto Power-Off function do not represent exact times and there may be some variation.
- By default, the Auto Power-Off time is set to 30 minutes.
- You can change the Auto Power-Off setting at any time after completing Initial Setup. For details, see the description of the Auto Power-Off page from Menu Mode (page 75).

Quickly Disabling Auto Power-Off

To quickly disable the Auto Power-Off function, turn on the drum module while holding down the [] button.



Hold

Auto power off
disabled.

Turning Off the Drum Module

1. If you have connected your DTX502 to other audio equipment, ensure that the volume on those devices is turned down fully.
2. Press the [] (Standby/On) button.



The Shutdown page will be displayed on the LCD screen, and the drum module will turn off.

```
>>> Shutdown <<<
Please wait.
```

NOTICE

The drum module automatically stores its system settings before turning off. For this reason, please do not unplug the power adaptor until the LCD screen is no longer lit. Unsaved settings from kits, trigger setups, and the like will be lost when the drum module is turned off. Be sure to store any modified settings before doing so.

Restoring the Default Settings



Your drum module's default settings—collectively known as the Factory Set—can be conveniently restored at any time if you have accidentally overwritten them or wish to delete all of your own settings. To do so, use the Factory Set function as follows.

NOTICE

When you reset parameters as described below, any changes you have made to them will be lost. Before proceeding, therefore, you should ensure that they contain no irreplaceable settings.

1. Press the [] (Standby/On) button and turn off the DTX502.



2. Turn the DTX502 back on while holding down the [] and [] buttons.



The Factory Set page will be displayed on the LCD screen, and the drum module's default settings will be restored.

```
Factory Set
initialized.
```

After this, the Initial Setup page will be displayed (page 13).

Basic DTX502 Operations

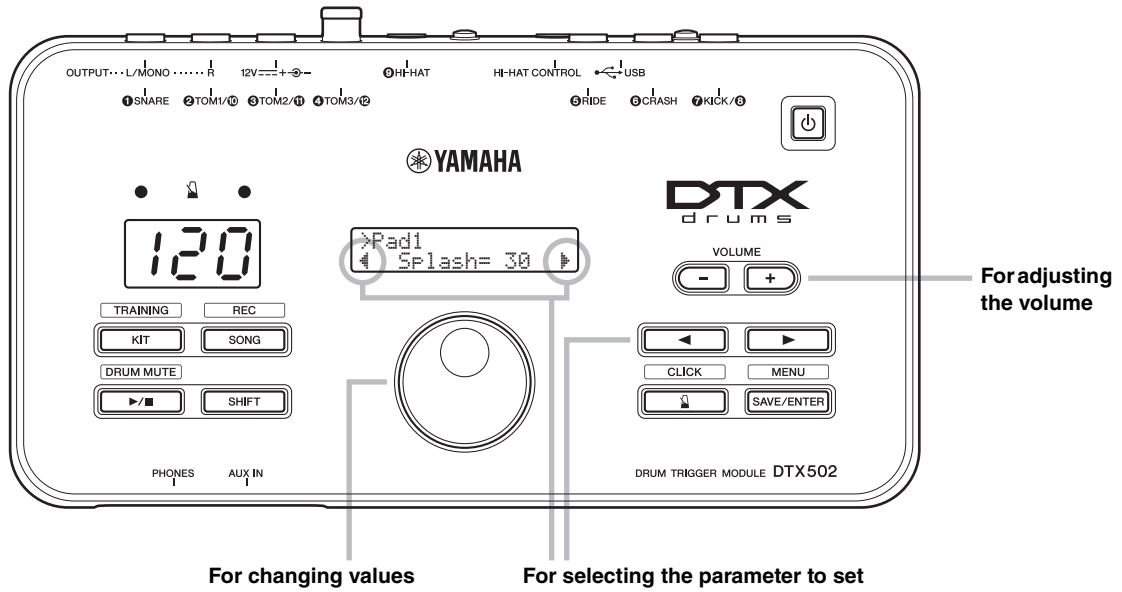

■ Adjusting the volume

Press the VOLUME [+] button to increase the volume.
Press the VOLUME [-] button to decrease the volume.

■ Selecting the parameter to set

Use the [◀]/[▶] buttons to select different parameters on the screen by moving the flashing cursor.

A “▶” symbol at the bottom-right of the screen indicates that you can move right to another page. Similarly, a “◀” symbol at the bottom-left of the screen indicates that you can move left to another page.

■ Changing values

Move the flashing cursor to the parameter you want to edit, and then turn the Data Dial to change its value. Turn it clockwise to increase values and vice-versa.

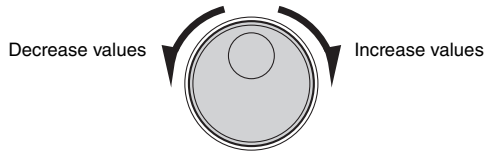

NOTE

- To adjust the song volume, hold down the [SONG] button and press the VOLUME [+] or [-] button accordingly (page 26).
- To adjust the metronome volume, hold down the [M] button and press the VOLUME [+] or [-] button accordingly (page 31).

NOTE

To adjust the tempo, hold down the [SHIFT] button and turn the Data Dial (page 31).

Striking the Drum Pads

Snare

When using a three-zone snare pad such as the XP80, you can produce three distinct sounds (i.e., head, open rim, and closed rim) depending on where you strike it, much the same as if you were playing an acoustic snare.

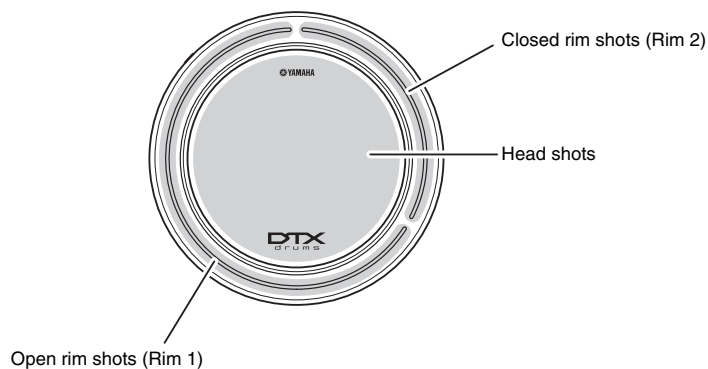

■ Head shots

Striking the main surface of the pad produces a head shot sound.

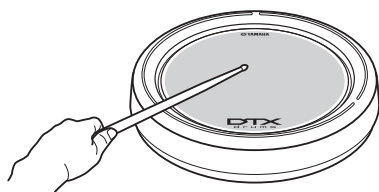

■ Closed rim shots (cross sticking)

Striking the closed-rim zone produces a closed rim-shot sound.

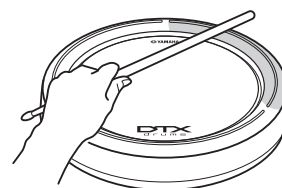

■ Open rim shots

Striking the open-rim zone produces an open rim-shot sound.

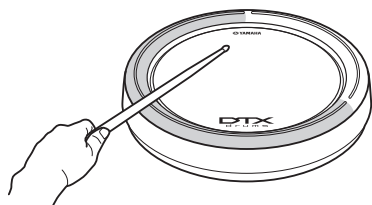

Hi-hats

When using a two-zone hi-hat pad such as the RHH135, you can produce a number of distinct sounds, much the same as if you were playing an acoustic hi-hat cymbal.

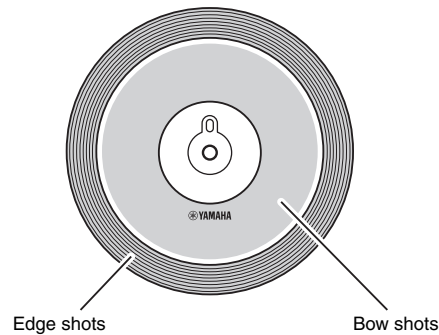

■ Open and closed sounds

- You can produce an open hi-hat sound by striking the hi-hat pad with the hi-hat controller's pedal not depressed.
- You can produce a closed hi-hat sound by striking the hi-hat pad with the hi-hat controller's pedal depressed.
- Using a hi-hat pedal, you can recreate the sound of a closing hi-hat.

■ Bow shots

Striking the main surface of the hi-hat pad (i.e., the bow section located between the cup and edge) produces a bow shot sound.

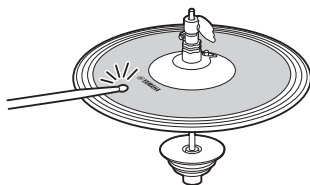

■ Edge shots

Striking the outside edge of the hi-hat pad produces an edge shot sound.

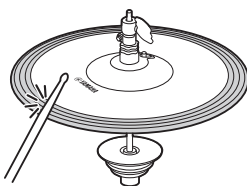

■ Foot-close sounds

You can depress the hi-hat controller's pedal to create a foot-close sound without having to strike the hi-hat pad.

■ Hi-hat splash sounds

Depressing the hi-hat controller's pedal and then immediately releasing it produces a hi-hat splash sound.

■ Cup shots (PCY100 only)

When using a PCY100 as your hi-hat, you can produce a cut shot sound by striking the cup section of the pad.

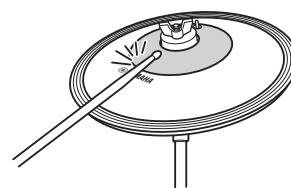

In order to do so, you will need to set the cup switch (CUP SW) on the rear of the pad to the ON position.

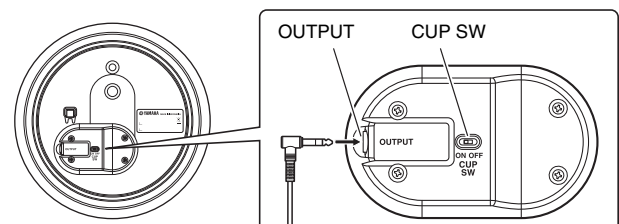

Cymbals

When using a three-zone cymbal pad such as the PCY135, you can produce a number of distinct sounds, much the same as if you were playing an acoustic ride cymbal.

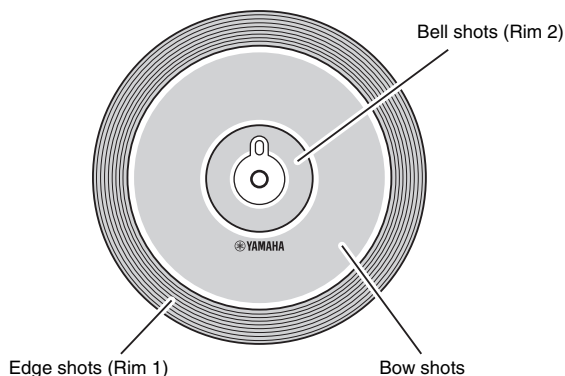

■ Bow shots

Striking the main surface of the cymbal pad (i.e., the bow section located between the cup and edge) produces a bow shot sound.

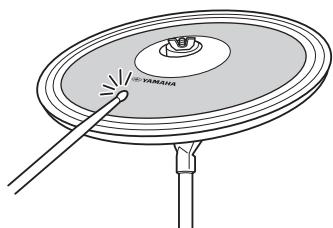

■ Choking

Grabbing the edge of a cymbal pad immediately after striking it will silence the sound being produced.

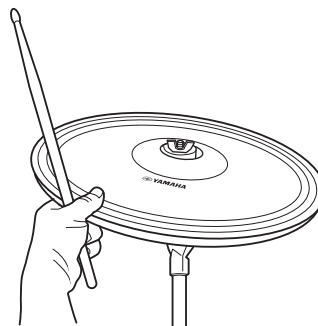

■ Edge shots

Striking the outside edge of the cymbal pad produces an edge shot sound.

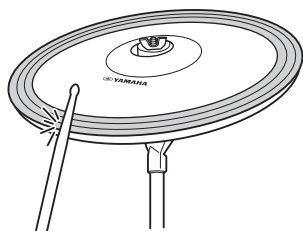

■ Muting

Striking the pad while holding the edge will produce a muted sound.

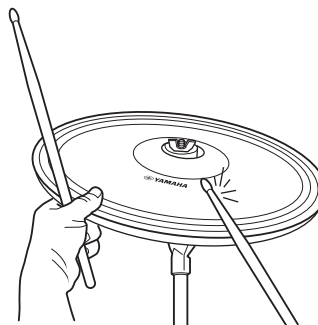

■ Bell shots

Striking the cup produces a bell shot sound.

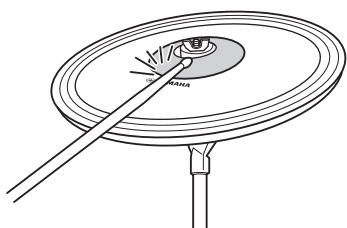

Selecting & Playing a Kit

In terms of the DTX502, a “kit” is a full set of drum-sound assignments for all of the pads. Your drum module comes with 50 different drum and percussion kits already set up.

KIT1

Selecting a Kit

1. Press the [KIT] button to access the Kit area.

Verify that “KIT1” is displayed at the top-left of the screen.



2. Turn the Data Dial to select a different kit.

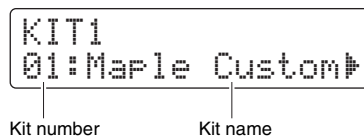
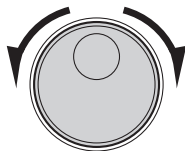

3. Play the pads and see how the kit sounds.

NOTE

Your kit selection will be retained even when the DTX502 is turned off.

NOTE

With certain drum kits, the Pad Song function (page 29) will automatically start playing a song when you strike a pad.

Adjusting Pad Sensitivity

A pad’s sensitivity determines how the loudness (or power) of its drum sounds changes depending on how hard you strike it. You can adjust the sensitivity of all pads as follows to make them more accurately reflect the dynamics of your drumming.

Hold down the [KIT] button and press either the VOLUME [+] or [-] button.

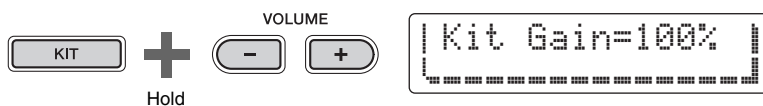

- Pressing the VOLUME [+] button increases the gain setting, making all of the pads more sensitive. This means that louder sounds can be more easily produced with softer drumming.
- Pressing the VOLUME [-] button decreases the gain setting, making all of the pads less sensitive. This means that louder sounds can only be produced by drumming hard.

NOTE

- Adjusting the sensitivity as shown on the left affects the entire kit.
- If you wish to set sensitivities on an individual pad basis, see the description of the Gain page from Menu Mode (page 68).

Balancing Instrument Volumes

If necessary, you can change the volumes of individual instruments (page 20). For example, you may need to lower the volume of the kick while increasing the volume of the snare. For details on how to do so, see the description of the Mixer settings page from Menu Mode (page 57).

Building Your Own Unique Kits

It's easy to build your own unique drum kits with the DTX502—simply change the drum sounds assigned to the individual pads on pages KIT2 to KIT6 as described below.

NOTE

The KIT1 page is used only for selecting different kits.

Tip

Voices, instruments, and kits

Pads such as the snare, hi-hat, and cymbals (pages 16 to 18) have been designed to trigger different voices (or sounds) depending on the zone of the pad that is struck (see Input Sources on page 29). In terms of the DTX502, an "instrument" is a collection of the voices assigned to the various zones of a specific pad. A kit comprises a full set of instruments—one for each pad.

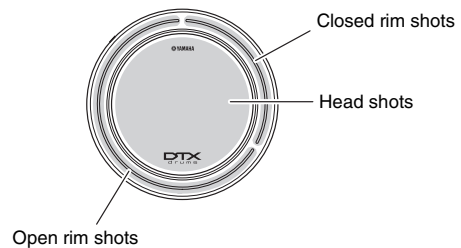

NOTICE

When any of a kit's parameters have been changed but not yet saved, an asterisk (*) will appear beside the page name at the top-left of the screen. The asterisk will disappear when you save your settings. (See page 25.) If you select another kit without saving your changes, they will be lost.



To edit a kit, you must first carry out the following two steps.

1. Press the [KIT] button to access the Kit area.



2. Turn the Data Dial to select the kit you wish to edit.

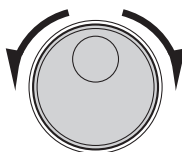

The changes that can be made on each of pages KIT2 to KIT6 are described below.

KIT2

Assigning Voices to Instruments

1. Navigate to the KIT2 page using the [◀]/[▶] buttons.



2. Strike the pad whose instrument voice you wish to change.

3. If necessary, move the cursor to the voice category using the [◀]/[▶] buttons.



4. If necessary, turn the Data Dial to select a different voice category.

Voices are organized into the following categories on the DTX502.

K	Kick	H	Hi-hat
S	Snare	P	Percussion
T	Tom	E	Effect
C	Cymbal	W	Wave Voice

5. Move the cursor to the voice number using the [◀]/[▶] buttons.



6. Turn the Data Dial to select a different voice.

NOTE

As an alternative to selecting a pad by striking it, you can change the current selection by pressing the [◀]/[▶] buttons with the [SHIFT] button held down.

NOTE

The term "Wave Voice" refers to an audio file transferred from a computer to your DTX502 via USB (page 79).

NOTE

- When voice number 0 ("No Assign") is selected for an instrument, it will not produce any sound when struck.
- To assign a voice to a specific zone, strike the zone while holding down the [SHIFT] button. For details, see Tip: Input Sources on page 29.
- Two different voices can be simultaneously assigned to each pad or zone. For details, see the description of the Layers page from Menu Mode (page 57).

KIT3

Tuning & Changing Cymbal Sizes

1. Navigate to the KIT3 page using the [◀]/[▶] buttons.



2. Strike the pad whose instrument tuning or cymbal size you wish to change.

3. Turn the Data Dial to change the tuning or cymbal size.

The content of the page will vary depending on the voice category selected for the instrument in question.

- **Kick (K), Snare (S), Tom (T), Percussion (P), Effect (E), or Wave Voice (W):**

```
KIT3*      Kick
◀ Tuning=+ 0.0 ▶
```

Raise or lower the parameter value to change the tuning (i.e., pitch) of the voice.

- **Cymbal (C) or Hi-hat (H):**

```
KIT3*      Ride
◀   Size=+ 0 ▶
```

Raise or lower the parameter value to simulate the effect of changing the cymbal size.

NOTE

As an alternative to selecting a pad by striking it, you can change the current selection by pressing the [◀]/[▶] buttons with the [SHIFT] button held down.

KIT4

Customizing Instrument Voices

1. Navigate to the KIT4 page using the [◀]/[▶] buttons.



2. Strike the pad whose instrument voice you wish to customize.

3. Turn the Data Dial to customize the voice.

The way in which the voice can be customized varies depending on the voice category selected for the instrument in question.

- **Kick (K), Snare (S), and Tom (T):**

```
KIT4*      Kick
◀ Muffling=+ 0 ▶
```

Raise or lower the parameter value to simulate the effect of changing the degree of muffling (i.e., head muting).

- **Cymbal (C):**

```
KIT4*      Ride
◀ Sustain=+ 0 ▶
```

Raise or lower the parameter value to change the cymbal's sustain time (i.e., how quickly the sound decays to silence).

- **Hi-hat (H):**

```
KIT4*      Hihat
◀ Clutch=+ 0 ▶
```

Raise or lower the parameter value to simulate the effect of changing the hi-hat's clutch position. The smaller the setting, the quicker an open hi-hat sound will decay to silence.

- **Percussion (P), Effect (E), or Wave Voice (W):**

```
KIT4*      Pad12
◀ Decay=+ 0 ▶
```

Raise or lower the parameter value to change how quickly the sound decays to silence.

NOTE

As an alternative to selecting a pad by striking it, you can change the current selection by pressing the [◀]/[▶] buttons with the [SHIFT] button held down.

NOTE

The hi-hat clutch position setting applies to all kits.

KIT5

Adjusting Instrument Volumes

1. Navigate to the KIT5 page using the [◀]/[▶] buttons.



2. Strike the pad whose instrument volume you wish to adjust.

3. Turn the data dial to change the instrument volume.

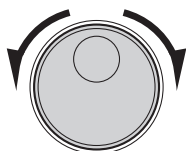

```
KIT5*      Snare
4  Volume=110 ▶
```

NOTE

As an alternative to selecting a pad by striking it, you can change the current selection by pressing the [◀]/[▶] buttons with the [SHIFT] button held down.

KIT6

Adjusting the Stereo Panning of Instruments

1. Navigate to the KIT6 page using the [◀]/[▶] buttons.



2. Strike the pad whose instrument panning you wish to change.

3. Turn the Data Dial to change the pan setting.

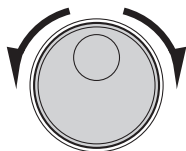

```
KIT6*      Snare
4  Pan= 0
```

NOTE

As an alternative to selecting a pad by striking it, you can change the current selection by pressing the [◀]/[▶] buttons with the [SHIFT] button held down.

Saving Customized Kits

You can now save your customized kit as one of the drum module's User kits, which are numbered 51 to 100. User kits are retained in memory even when the DTX502 is turned off.

1. Press the [SAVE/ENTER] button.

The button will start to flash and the following page will be displayed.



```
KIT save to 51
: [MaPle Custom]
```

2. Turn the Data Dial to select the User kit (51 to 100) in which you wish to save your settings.

3. If necessary, name your new drum kit.

Press the [◀]/[▶] buttons to move the cursor to the character you wish to change, and then turn the Data Dial to change it.

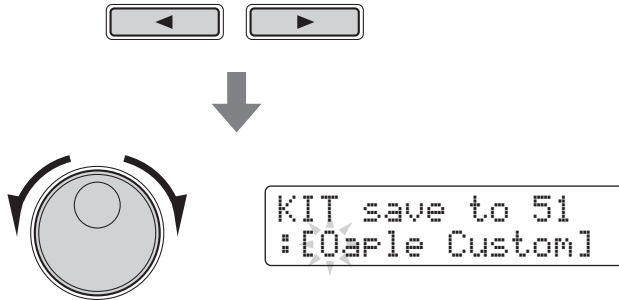

4. Press the [SAVE/ENTER] button once again.



```
KIT save to 51
Are you sure?
```

To cancel the process without saving any settings, press the [EXIT] button.

5. Press the [SAVE/ENTER] button to save your settings.

User kit data can be transferred between your DTX502 and a computer via USB. For details, refer to Connecting to a Computer (page 79) and the Reference Manual (PDF).

NOTE

Customized kits cannot be saved to the drum module's Preset kits, which are numbered 1 to 50.

NOTICE

When you save new settings to a User kit, its current settings will be overwritten. Before proceeding, therefore, you should ensure that the kit in question contains no irreplaceable settings.

Performing with a Song

Your DTX502 comes complete with a full complement of practice songs. Covering a wide range of genres, they provide a convenient, enjoyable way to practice drumming.

Songs are selected on the SONG1 page.

Press the [SONG] button to open the SONG1 page.

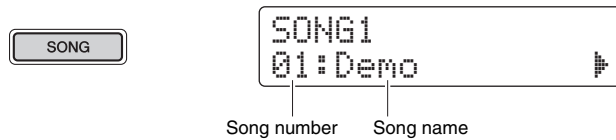

SONG1

Selecting a Song

1. Verify that “SONG1” is displayed at the top-left of the screen.
2. Turn the Data Dial to choose a song to play along with.
3. Press the [▶/■] button.

The song will start to play. You can stop the song by pressing the [▶/■] button once again.

NOTE

- Your song selection will be retained even when the DTX502 is turned off.
- The most appropriate drum kit is pre-assigned to each of the drum module’s songs, so whenever you select another song, the current kit will also change. You can, however, use the Kit Lock function to prevent this if you wish to keep the current kit when practicing with different songs. (See page 73.)

Adjusting the Song Volume

1. Press the [▶/■] button to start the song.
2. To adjust the song’s volume, hold down the [SONG] button and press either the VOLUME [+] or [-] button.

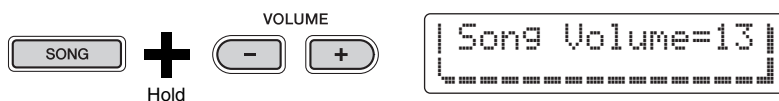

Adjusting the Song Tempo

1. Press the [▶/■] button to start the song.
2. To adjust the tempo, hold down the [SHIFT] button and turn the Data Dial.

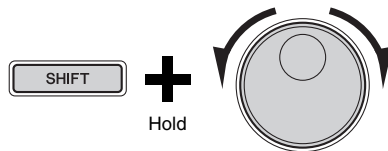

NOTE

- The tempo can be freely set between 30 and 300 BPM.
- You can also use the Tap Tempo function (page 36) to set the tempo by striking pads.

Muting a Song's Drum Parts

1. Press the [▶/■] button to start the song.
2. Hold down the [SHIFT] button and press the [▶/■] button to mute and unmute the song's drum parts.

When the drum parts have been muted, the symbol "M" will be displayed on-screen.

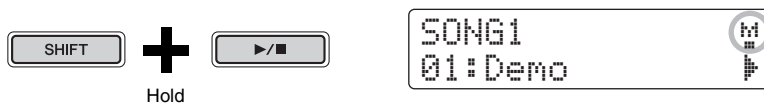

NOTE

You can also mute and unmute individual drum and accompaniment parts. For details, see the description of Part Mute from Training Mode (page 47).

SONG2**Looping a Song**

On the SONG2 page, you can set the current song to be played repeatedly in looped fashion.

1. Press the [SONG] button.
2. Navigate to the SONG2 page using the [◀]/[▶] buttons.



3. Turn the Data Dial to change the loop setting.

- When Loop is set to “off”, the song will stop automatically when it has played to the end.
- When Loop is set to “on”, the song will start again from the beginning when it has played to the end.

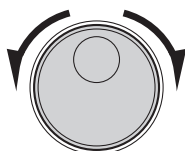
**NOTE**

The loop setting for User songs is retained even when the DTX502 is turned off.

SONG3**Playing with Count-In**

On the SONG3 page, you can set whether or not you would like to be counted in before the song starts.

1. Press the [SONG] button.
2. Navigate to the SONG3 page using the [◀]/[▶] buttons.



3. Turn the Data Dial to change the count-in setting.

- When PlayCount is set to “off”, you will not be counted in.
- When PlayCount is set to “on”, you will be counted in over two measures.

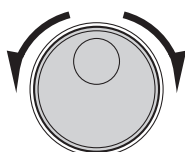
**NOTE**

The count-in setting applies to all songs.

Playing Pad Songs

The term “pad song” refers to songs that can be played by striking a specific drum pad. In the same way as snare sounds are produced by striking a pad to which a snare voice has been assigned, you can start and stop the playback of pad songs by striking the pads to which they are assigned.

■ Assigning a pad song to a pad

1. Press the [KIT] button to access the Kit area.
2. Using the Data Dial, select the kit you wish to edit.

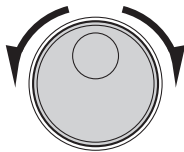

```
KIT1
01:Maple Custom
```

3. Navigate to the KIT2 page using the [◀]/[▶] buttons.



```
KIT2      Snare
◀S01:MapleCustn▶
```

4. To select an input source, hold down the [SHIFT] button and strike the corresponding pad or zone.

Tip

Input Sources

Each zone of an instrument (page 20) corresponds to one of the drum module’s input sources. The snare instrument, for example, combines three distinct input sources—the head, the open rim, and the closed rim. As shown in the table, only the snare, the ride cymbal, the crash cymbal, and the hi-hat have more than one input source.

Instrument	Input sources	Instrument	Input sources
Snare	snare Head	Crash	crash Bow
	snare OpenRim		crash Edge
	snare ClosedRim		crash Cup
	snare(off) Head (*1)	HiHat	hihat Open
	snare(off) OpenRim (*1)		hihat EdgeOpen
	snare(off) ClosedRim (*1)		hihat CupOpen (*2)
Ride	ride Bow		hihat Close
	ride Edge		hihat EdgeClose
	ride Cup		hihat CupClose (*2)
		hihat FootClose	
		hihat FootSplash	

*1: These input sources apply when the Snares parameter from the KitC6 page (page 62) is set to “off”.

*2: These input sources apply when using a PCY100 as a hi-hat.

NOTICE

When any of a kit’s parameters have been changed but not yet saved, an asterisk (*) will appear beside the page name at the top-left of the screen. The asterisk will disappear when you save your settings. (See page 25.)

NOTE

Pad songs are assigned to input sources, not to instruments.

NOTE

Tom 1, Tom 2, Tom 3, Kick, Pad 8, Pad 10, Pad 11, and Pad 12 each have only one input source.

5. If necessary, move the cursor to the voice category using the [◀]/[▶] buttons.



6. Turn the Data Dial to select “♪” (pad song) as the voice category.

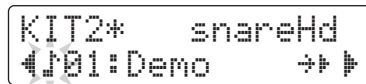

7. Move the cursor to the song number using the [◀]/[▶] buttons.



8. Turn the Data Dial to choose a pad song.

See the Data List section (page 83) for details of the available pad songs.

■ Setting Repeat and Play modes

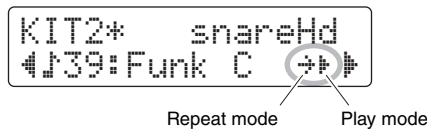

● Setting the pad song's Repeat mode

1. Move the cursor to the Repeat mode symbol using the [◀]/[▶] buttons.

2. Turn the Data Dial to change the mode setting.

- ◻ : Normal play
- ◻ : Repeat play—that is, the song starts again from the beginning after playing to the end

● Setting the pad song's Play mode

1. Move the cursor to the Play mode symbol using the [◀]/[▶] buttons.

2. Turn the Data Dial to change the mode setting.

- ◻ : The pad song will start or stop accordingly whenever the pad is struck.
- ◻ : The pad song will play one measure at a time whenever the pad is struck.
- ◻ : If any other pad song of the same type is already playing, it will be stopped before playing the pad song selected here.

NOTE

- Pad songs are played back independent of the main song selected on the SONG1 page.
- Pad songs cannot be played when recording a song or when practicing in Training Mode.

Using the Metronome

Playing your electronic drum kit along with the built-in metronome is a great way to perfect your rhythm.

Starting & Stopping

Press the  button to start the metronome.



- The red metronome light (left) flashes on the start of each measure; the green light (right) flashes on every other beat.
- The current metronome tempo is shown by the number display.



Press the  button once again to stop the metronome.

Adjusting the Tempo

Hold down the [SHIFT] button and turn the Data Dial.

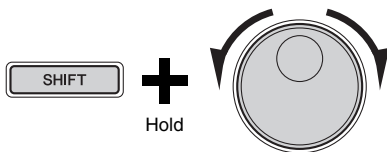

Setting the Overall Volume

Hold down the  button and press either the VOLUME [+] or [-] button.

You can set the overall metronome volume between “0” (off) and “16” (loudest).

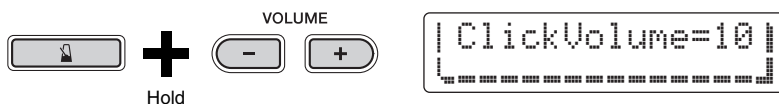

NOTE

The overall volume setting applies to all click sets.

Customizing the Metronome

This section describes how to make advanced metronome settings. A total of six pages (CLK1 to CLK6) are used for this purpose.

NOTICE

When any of a click set's parameters have been changed but not yet stored, an asterisk (*) will appear beside the page name at the top-left of the screen. The asterisk will disappear when you store your settings. (See page 37.)



The individual parameters that can be changed on pages CLK1 to CLK6 will now be described.

The following four metronome settings can be made on the CLK1 page.

- Click set selection
- Tempo
- Time signature
- Timer

To open the CLK1 page, hold down the [SHIFT] button and press the [M] button.

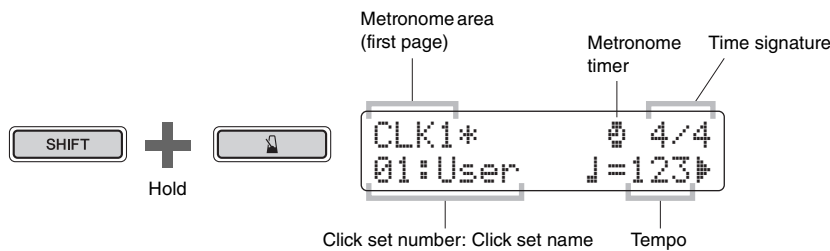

CLK1

Selecting a Click Set

The term “click set” is used to describe a collection of metronome settings. You can customize these click sets as necessary, and your DTX502 can store up to 30 of them. The following describes how to recall a previously stored click set.

1. Move the cursor to the click set number using the [◀]/[▶] buttons.

2. Turn the Data Dial to choose a click set.

Click sets are numbered 1 to 30.

Whenever you change metronome parameters as described on the following pages, it is wise to store them. Details on how to do so can be found in Storing a Customized Click Set (page 37).

NOTE

Your click-set selection will be retained even when the DTX502 is turned off.

CLK1

Setting the Tempo

1. Move the cursor to the number to the right of the “” symbol using the [◀]/[▶] buttons.
2. Turn the Data Dial to change the tempo setting.

The tempo can be freely set between 30 and 300 BPM.

NOTE

- If you hold down the [SHIFT] button and turn the Data Dial, you can change the tempo without having to move the cursor to the number to the right of the “” symbol.
- You can also use the Tap Tempo function (page 36) to set the tempo by striking pads.

CLK1

Setting the Time Signature

1. Move the cursor to the time signature display using the [◀]/[▶] buttons.
2. Turn the Data Dial to set the time signature.

The available time signature settings are 1/4 to 16/4, 1/8 to 16/8, and 1/16 to 16/16.

CLK1

Setting the Timer

By setting the metronome's timer, you can have it turn off automatically after the set time has elapsed.

1. Move the cursor to the “” symbol using the [◀]/[▶] buttons.

The “” symbol will be replaced by a number.

2. Turn the Data Dial to set the metronome timer.

The time can be freely set between 0 seconds (i.e., the timer is disabled) and 600 seconds in units of 30 seconds.

NOTE

- The metronome timer setting applies to all click sets.
- The metronome timer does not operate when in Training Mode.

CLK2

Setting Individual Volumes

On the CLK2 page, you can set the volumes of individual metronome subdivisions.

1. Hold down the [SHIFT] button and press the [] button to access the Metronome area.
2. Navigate to the CLK2 page using the []/[] buttons.



3. Move the cursor to “Arr”, “J”, “V”, “W”, or “h” so that you may adjust the volume for that subdivision.
4. Turn the data dial to adjust the volume of the selected subdivision.

The volume for each subdivision may be freely adjusted between “0” (silent) and “9” (loudest). The following shows the timing of the individual metronome subdivisions when there are four beats per measure.

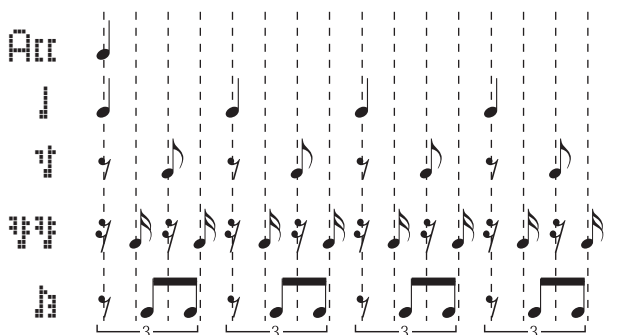

NOTE

“Arr”, “J”, “V”, and “W” subdivision volumes can be set when the time signature is set to 3/8, 6/8, 9/8, 12/8, or 15/8.

CLK3

Changing Sounds for All Subdivisions

On the CLK3 page, you can change the sounds for all metronome subdivisions (i.e., “Arr”, “J”, “V”, “W”, and “h”).

1. Hold down the [SHIFT] button and press the [] button to access the Metronome area.
2. Navigate to the CLK3 page using the []/[] buttons.



3. Turn the Data Dial to choose a metronome sound set.

The following six sets are available on your DTX502.

1	Metronome1	4	Stick
2	Metronome2	5	Human 1
3	Cowbell	6	Human 2

CLK4

Changing Sounds for Individual Subdivisions

On the CLK4 page, you can freely assign different sounds to each of the metronome subdivisions (i.e., “Att”, “↓”, “↑”, “♯♯”, and “h”).

1. Hold down the [SHIFT] button and press the [] button to access the Metronome area.
2. Navigate to the CLK4 page using the [◀]/[▶] buttons.



3. Move the cursor to the subdivision symbol to the right of “Sound=” (i.e., “Att”, “↓”, “↑”, “♯♯”, or “h”), and turn the Data Dial to select the one to set.
4. Move the cursor to the sound category, and if necessary, turn the Data Dial to select a different category.

Voices are organized into the following categories on the DTX502.

K	Kick	P	Percussion
S	Snare	E	Effect
T	Tom	W	Wave Voice
C	Cymbal	♯	Spoken Count
H	Hi-hat		

5. Move the cursor to the sound number, and if necessary, turn the Data Dial to select a different sound.

NOTE

“♯” can be selected only for “Att” and “↓”.

NOTE

When voice number 0 (“No Assign”) is selected, the corresponding metronome subdivision will not produce any sound.

CLK5

Tuning Click-Set Sounds

On the CLK5 page, you can tune the sounds for each of the metronome subdivisions (i.e., “Att”, “↓”, “↑”, “↑↑”, and “↓↓”).

1. Hold down the [SHIFT] button and press the [M] button to access the Metronome area.
2. Navigate to the CLK5 page using the [◀]/[▶] buttons.



3. Move the cursor to the subdivision symbol to the right of “Sound=” (i.e., “Att”, “↓”, “↑”, “↑↑”, or “↓↓”), and turn the Data Dial to select the one to set.
4. Move the cursor to the number to the right of “Tune=”, and turn the Data Dial to change the tuning.

Metronome subdivision sounds can be tuned between -24.0 and +24.0 semitones.

CLK6

Tapping the Tempo on the Pads

On the CLK6 page, you can use the Tap Tempo function to set the tempo by striking pads.

1. Hold down the [SHIFT] button and press the [M] button to access the Metronome area.
2. Navigate to the CLK6 page using the [◀]/[▶] buttons.



3. Strike a pad at least three times at the desired tempo. The tapped tempo will be displayed on-screen.



Storing a Customized Click Set

After you have customized a click set (as described on pages 32 through 36), you should store it to prevent your settings being lost when the DTX502 is turned off.

1. Press the [SAVE/ENTER] button.

The button will start to flash and the following page will be displayed.



2. Turn the Data Dial to select the click set (1 to 30) in which you wish to store your settings.

3. If necessary, name your new click set.

Press the [◀]/[▶] buttons to move the cursor to the character you wish to change, and then turn the Data Dial to change it.

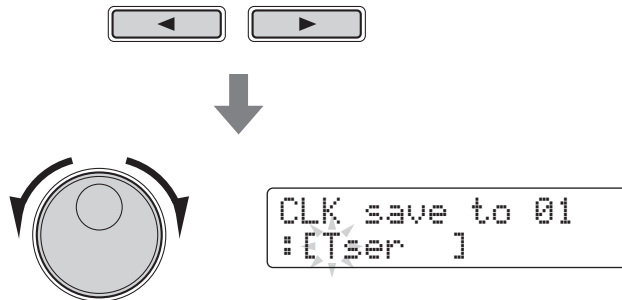

4. Press the [SAVE/ENTER] button once again.



To cancel the process without storing any settings, press the [⏏] button.

5. Press the [SAVE/ENTER] button to store your settings.

NOTICE

When you store new settings to a click set, its current settings will be overwritten. Before proceeding, therefore, you should ensure that the click set in question contains no irreplaceable settings.

Practicing in Training Mode

Your DTX502 comes complete with eight different types of training that allow you to improve various drumming skills while having fun at the same time. You can work on your sense of rhythm, learn drum patterns from a wide range of different musical genres, and even practice playing as wildly as you can.

Training Mode

Improving your sense of rhythm	
1. Groove Check	page 38
2. Rhythm Gate	page 40
3. Measure Break	page 41
4. Tempo Up/Down.....	page 42
5. Change Up	page 44
Learning drum patterns	
6. Pad Gate	page 46
7. Part Mute	page 47
Playing as wildly as you can	
8. Fast Blast	page 49

- If you wish to train along with a specific song, you should select that song in the Song area in advance (page 26).
- To adjust the training tempo before starting, hold down the [SHIFT] button and turn the Data Dial (page 31).

NOTE

The following cannot be used in Training Mode.

- Pad Song
- Pad Function

1. Groove Check

As an aid to improving your timing, Groove Check displays on-screen how early or late you are drumming. Two different training styles are available—the first uses the metronome; the second lets you play along with a song. When you have finished training, your score will be displayed on-screen.

■ **Training procedure**

1. Hold down the [SHIFT] button and press the [KIT] button to access Training Mode.

2. Turn the Data Dial to select “01:Groove Check”

The [▶/■] and [🔊] buttons will start flashing, indicating that the drum module is on standby to start training.

3. Press either the [▶/■] or [🔊] button when you are ready to go.

If you press the [▶/■] button, the current song will be used for training. If you press the [🔊] button, the metronome will be used.

4. Play the pads as tightly as you can along with the metronome or song.

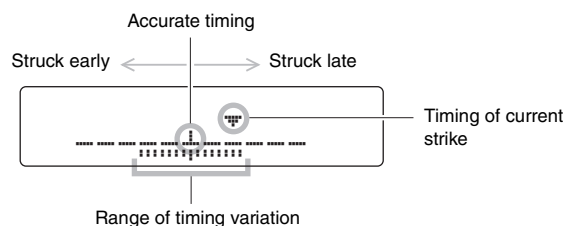

● Display of individual strikes

- The timing of your most recent strike is shown by the “▼” symbol.
- When your timing is accurate, the “▼” symbol will be shown at the center of the scale.
- If you strike the pad too early, the “▼” symbol will be shown to the left of the scale.
- If you strike the pad too late, the “▼” symbol will be shown to the right of the scale.

● Range of timing variation

- The range of variation in the timing of your drumming is shown by the band (▬) at the bottom of the screen.
- The wider the band, the larger the degree of variation in your drumming.

5. To end training, press the button used to start it in Step 3 above.

- Your score will be displayed on-screen. The highest possible score is 100 points.
- If you press the [▶] button while your score is displayed, you will be able to view your individual variation ranges for the hi-hat, snare, kick, toms, and cymbals. The wider the band (▬) at the bottom of the screen, the larger the degree of variation in your drumming.
- Press the [SAVE/ENTER] button to return to the training menu page (TRNG1).

NOTE

You can adjust the training tempo by turning the Data Dial.

NOTE

- If you wish to adjust the duration of training, see the description of the Timer page from Menu Mode (page 72).
- If looping (page 28) is turned off for the selected song, training will finish when the song plays once to the end.

2. Rhythm Gate

As an aid to improving your timing, Rhythm Gate displays on-screen any variation in the timing of your drumming. If you do not strike a pad in time with the metronome or song, it will not produce any sound. Two different training styles are available—the first uses the metronome; the second lets you play along with a song. When you have finished training, your score will be displayed on-screen.

■ Training procedure

1. Hold down the [SHIFT] button and press the [KIT] button to access Training Mode.

2. Turn the Data Dial to select “02:Rhythm Gate”

The [▶/■] and [🔊] buttons will start flashing, indicating that the drum module is on standby to start training.

3. Press either the [▶/■] or [🔊] button when you are ready to go.

If you press the [▶/■] button, the current song will be used for training. If you press the [🔊] button, the metronome will be used.

4. Play the pads as tightly as you can along with the metronome or song.

A pad will only produce a sound if you strike it while the gate is open. The width of the gate represents the difficulty level.

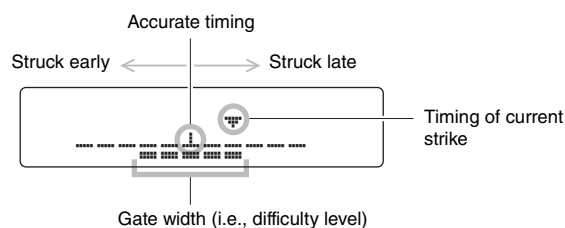

● Display of individual strikes

- The timing of your most recent strike is shown by the “▼” symbol.
- When your timing is accurate, the “▼” symbol will be shown at the center of the scale.
- If you strike the pad too early, the “▼” symbol will be shown to the left of the scale.
- If you strike the pad too late, the “▼” symbol will be shown to the right of the scale.

5. To end training, press the button used to start it in Step 3 above.

- Your score will be displayed on-screen. The highest possible score is 100 points.
- If you press the [▶] button while your score is displayed, you will be able to view the individual percentages of accurately timed strikes for the hi-hat, snare, kick, toms, and cymbals.
- Press the [SAVE/ENTER] button to return to the training menu page (TRNG1).

NOTE

You can adjust the training tempo by turning the Data Dial.

NOTE

- If you wish to adjust the duration of training, see the description of the Timer page from Menu Mode (page 72).
- If looping (page 28) is turned off for the selected song, training will finish when the song plays once to the end.

■ Adjusting the difficulty level

With Rhythm Gate, you can reduce the width of the gate to make training more difficult and vice-versa.

1. With “02:Rhythm Gate” selected on the training menu page (TRNG1), press the [▶] button.

The TRNG2 page will be displayed.

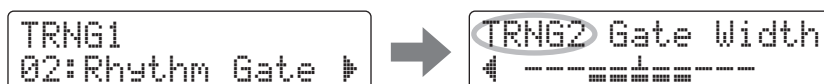

2. Turn the Data Dial to adjust the width of the gate.

The wider the gate, the easier it is to produce a sound by striking the pads and vice-versa.

3. Press the [◀] button to return to the training menu page (TRNG1).

NOTE

The difficulty level cannot be adjusted while training.

3. Measure Break

With Measure Break training, the metronome will be muted for certain measures in a sequence. For example, by setting the measures during which you play fills to be muted in this way, you can check for any deviation in your timing when the metronome returns. This will help you to play at a constant tempo throughout your performances. When you have finished training, your score will be displayed on-screen.

■ Training procedure

1. Hold down the [SHIFT] button and press the [KIT] button to access Training Mode.

2. Turn the Data Dial to select “03:MeasureBreak”

The [▶] button will start flashing, indicating that the drum module is on standby to start training.

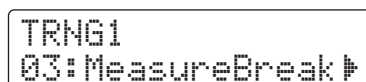

3. Press the [▶] button to move to the TRNG2 page.



4. Set the numbers of measures for which the metronome is to be played and to be silenced.

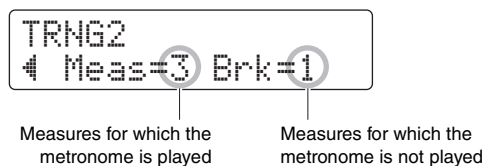

- Using the [◀]/[▶] buttons, move the cursor to the parameter you wish to set.
- Turn the data dial to set the corresponding number of measures between 1 and 8.

5. Press the [M] button when you are ready to go.

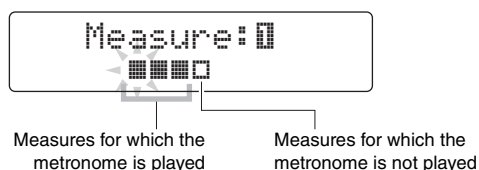

6. To end training, press the [M] button once again.

- Your score will be displayed on-screen. The highest possible score is 100 points.
- Press the [SAVE/ENTER] button to return to the training menu page (TRNG1).

NOTE

You can adjust the training tempo by turning the Data Dial.

NOTE

If you wish to adjust the duration of training, see the description of the Timer page from Menu Mode (page 72).

4. Tempo Up/Down

Use Tempo Up/Down training to see how fast you can go and still maintain accurate timing. As you play along with a metronome, the drum module will automatically increase the tempo if your timing is good and decrease it if not. When you have finished training, your score will be displayed on-screen.

■ Training procedure

1. Hold down the [SHIFT] button and press the [KIT] button to access Training Mode.

2. Turn the Data Dial to select “04:Tempo Up/Down”:

The [M] button will start flashing, indicating that the drum module is on standby to start training.



3. Press the [M] button when you are ready to go.

NOTE

You can adjust the training tempo by turning the Data Dial.

4. Focusing on accurate timing, play the pads along with the metronome.

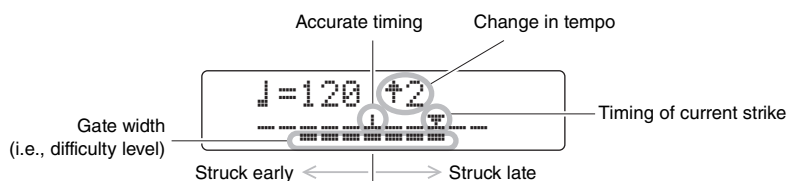

● Display of individual strikes

- The timing of your most recent strike is shown by the “▼” symbol.
- When your timing is accurate, the “▼” symbol will be shown at the center of the scale.
- If you strike the pad too early, the “▼” symbol will be shown to the left of the scale.
- If you strike the pad too late, the “▼” symbol will be shown to the right of the scale.

● Criteria for increasing or decreasing the tempo

The drum module evaluates your timing every four measures. The more accurate the timing of your drumming during those four measures, the more the tempo will be raised. If your timing was not accurate, however, the tempo will be lowered. Similarly, the more inaccurate, the more the tempo will drop.

5. To end training, press the [] button once again.

- Your score will be displayed on-screen. The highest possible score is 100 points.
- Press the [SAVE/ENTER] button to return to the training menu page (TRNG1).

NOTE

- If you wish to adjust the duration of training, see the description of the Timer page from Menu Mode (page 72).
- If you wish to adjust the difficulty level for this training, see the description of the Difficulty Level page from Menu Mode (page 72).
- This training can be set either to mute pads when they are not played in time or to always play pads whenever they are struck. For details, see the description of the Ignore Timing page from Menu Mode (page 72).

5. Change Up

In Change Up training, your aim is to maintain good timing as you play along with up to seven different practice rhythms*. The practice rhythm will change automatically after a certain number of measures, which you can also set. When you have finished training, your score will be displayed on-screen.

*: The seven practice rhythm patterns are .

■ Training procedure

1. Hold down the [SHIFT] button and press the [KIT] button to access Training Mode.

2. Turn the Data Dial to select “05:Change Up”.

The [▶/■] button will flash, indicating that the drum module is on standby to start training.

3. Press the [▶/■] button when you are ready to go.

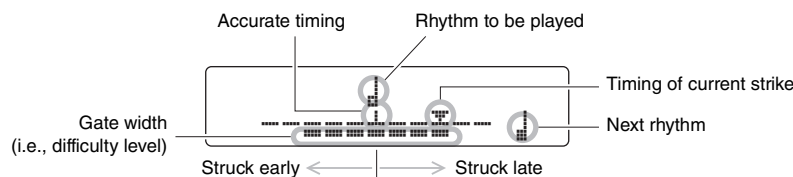

● Display of individual strikes

- The timing of your most recent strike is shown by the “▼” symbol.
- When your timing is accurate, the “▼” symbol will be shown at the center of the scale.
- If you strike the pad too early, the “▼” symbol will be shown to the left of the scale.
- If you strike the pad too late, the “▼” symbol will be shown to the right of the scale.

4. Play the pads along with the practice rhythm.

The practice rhythm will change in the following sequence.

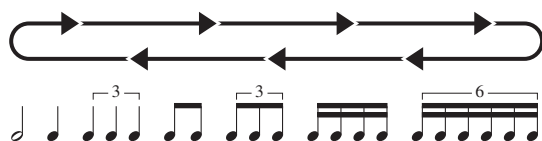

- The rhythm to be played is shown at the center of the screen.
- The next rhythm is shown flashing at the bottom-right of the screen.
- To mute the practice rhythm and play along with only the metronome, hold down the [SHIFT] button and press the [▶/■] button.
- To unmute the practice rhythm, again hold down the [SHIFT] button and press the [▶/■] button.

5. To end training, press the [▶/■] button once again.

- Your score will be displayed on-screen. The highest possible score is 100 points.
- Press the [SAVE/ENTER] button to return to the training menu page (TRNG1).

NOTE

- You can also press the [⏏] button to end training.
- If you wish to adjust the duration of training, see the description of the Timer page from Menu Mode (page 72).
- If you wish to adjust the difficulty level for this training, see the description of the Difficulty Level page from Menu Mode (page 72).
- This training can be set either to mute pads when they are not played in time or to always play pads whenever they are struck. For details, see the description of the Ignore Timing page from Menu Mode (page 72).

■ Selecting which practice rhythms to use

Using the following procedure, you can select which of the seven practice rhythms you wish to use.

1. With “05:Change Up” selected on the training menu page (TRNG1), press the [▶] button.

The TRNG2 page will be displayed.



2. Turn the Data Dial to select whether to play (“on”) or skip (“off”) the ¼ rhythm.

3. Similarly for the other six rhythms, use the [◀]/[▶] buttons to navigate to the corresponding pages, and turn the Data Dial to select whether to play or skip them.

NOTE

Practice rhythms cannot be selected while training.

Page	Rhythm	Page	Rhythm
TRNG2	¼ (¼)	TRNG6	♪♪ (♯ ¼)
TRNG3	¼ (¼)	TRNG7	♪♪♪ (♯ ¼)
TRNG4	♪♪ (♯ ¼)	TRNG8	♪♪♪♪ (♯ ¼)
TRNG5	♪ (♯ ¼)		

■ Changing the number of measures after which the rhythm changes

1. With “05:Change Up” selected on the training menu page (TRNG1), use the [▶] button to navigate to the TRNG9 page.



2. Turn the Data Dial to select 1, 2, or 4 as the number of measures after which the rhythm changes.

NOTE

The above setting cannot be adjusted while training.

6. Pad Gate

In Pad Gate training, the pads will only produce a sound when your drumming precisely matches a practice drum pattern. When you have finished training, your score will be displayed on-screen. In addition, you will be able to view the individual hit ratios for each of the drum parts.

■ Training procedure

1. Hold down the [SHIFT] button and press the [KIT] button to access Training Mode.
2. Turn the Data Dial to select “06:Pad Gate”
The [▶/■] button will flash, indicating that the drum module is on standby to start training.
3. Press the [▶/■] button when you are ready to go.
The currently selected song will start to play.
4. Play the song’s drum pattern on the pads.
 - The pads will not produce a sound if they are struck out of time.
 - In addition, the pads will only produce a sound when you play the same drum pattern as in the song.
5. Use the [◀]/[▶] buttons to view the individual hit ratios for the hi-hat, snare, kick, toms, and cymbals—that is, the percentage of times they were played in time and matching the drum pattern in the song.

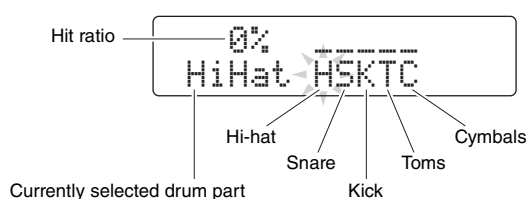

6. To end training, press the [▶/■] button.

- Your score will be displayed on-screen. The highest possible score is 100 points.
- You can also view your hit ratios for individual drum parts after training has ended. Use the [◀]/[▶] buttons to navigate to them from the page displaying the score.
- Press the [SAVE/ENTER] button to return to the training menu page (TRNG1).

NOTE

- If you wish to adjust the duration of training, see the description of the Timer page from Menu Mode (page 72).
- If you wish to adjust the difficulty level for this training, see the description of the Difficulty Level page from Menu Mode (page 72).
- This training can be set either to mute pads when they are not played in time or to always play pads whenever they are struck. For details, see the description of the Ignore Timing page from Menu Mode (page 72).
- You can set which groups of pads the drum module should consider when deciding whether or not you are playing the same drum pattern as in the song. For details, see the description of the Pad Gate Group page from Menu Mode (page 72).
- If looping (page 28) is turned off for the selected song, training will finish when the song plays once to the end.

7. Part Mute

Part Mute training lets you mute any or all of the drum parts (i.e., hi-hat, snare, kick, toms, and cymbals) and also the instrument parts from an accompanying song. You can mute the parts in two different ways—either on-screen or by striking the pad in question. The latter is referred to as auto-play muting. Note that this type of training is not scored.

■ Training procedure

1. Hold down the [SHIFT] button and press the [KIT] button to access Training Mode.

2. Turn the Data Dial to select “07:Part Mute”.

The [▶/■] button will flash, indicating that the drum module is on standby to start training.

3. Press the [▶/■] button to start the currently selected song.

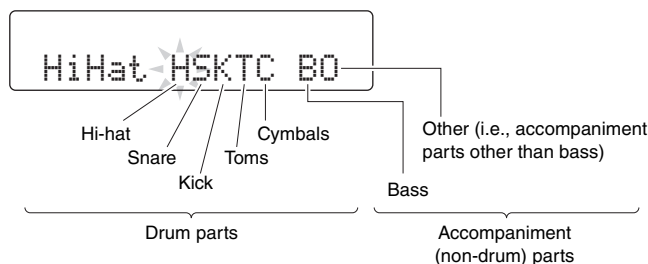

The letters displayed on-screen correspond to the following parts.

- H: Hi-hat
- S: Snare
- K: Kick
- T: Toms
- C: Cymbals
- B: Bass
- O: Other (i.e., accompaniment parts other than bass)

4. Select the parts to be muted.

● Muting on-screen

- 4-1.** Using the [◀]/[▶] buttons, move the cursor to the part you wish to mute (H, S, K, T, C, B, or O).
- 4-2.** Turn the data dial to mute (or unmute) the selected part.
The symbol “” will be displayed above any muted part.



● Muting with the pads

- 4-1.** Hold down the [SHIFT] button and press the [▶/■] button to turn on auto-play muting.



- 4-2.** Strike the pad corresponding to the drum part you wish to mute.
The part will be muted and the symbol “” will be displayed above the corresponding letter.



To turn off auto-play muting, again hold down the [SHIFT] button and press the [▶/■] button.

5. Practice playing the pads along with the song.

6. To end training, press the [▶/■] button.

NOTE

Auto-play muting cannot be used with parts muted on-screen.

NOTE

Auto-play muting of a drum part will be automatically turned off if a pad corresponding to that part is not struck for certain period of time.

NOTE

If looping (page 28) is turned off for the selected song, training will finish when the song plays once to the end.

8. Fast Blast

In a Fast Blast training session, you simply play the drums as wildly as you can over a set period of time. More a game than a form of practice, your aim is to get the highest possible score. When you have finished training, your score will be displayed on-screen.

■ Training procedure

1. Hold down the [SHIFT] button and press the [KIT] button to access Training Mode.

2. Turn the Data Dial to select “08:Fast Blast”

3. Press the [▶/■] button.

The following will be shown on-screen, indicating that the drum module is on standby to start training.



4. Strike a pad when you are ready to go.

Play as many of the pads as often as you can before the time limit.

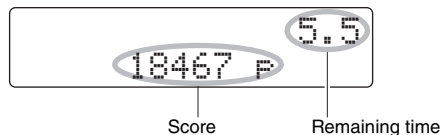

- The timer will start when you strike the first pad.
- Your current score and remaining time will be displayed on-screen.
- To end a training session before the time limit, press the [▶/■] button once again.

5. When the time limit is reached, the message “Finished!” will be displayed on-screen together with your final score.

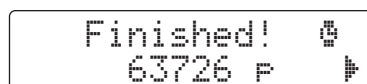

NOTE

If you wish to adjust the duration of training, see the description of the Fast Blast Timer page from Menu Mode (page 73).

● **Viewing your power and activity points**

5-1. With the message “Finished!” displayed on-screen, press the [▶] button.

5-2. The drum module will display your power points (Pwr) and activity points (Act).

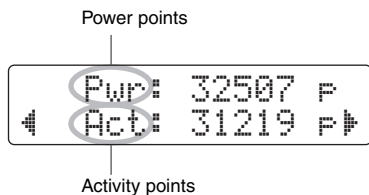

- The more powerfully you played the pads, the higher your power points will be.
- The more pads you played, the higher your activity points will be.

Press the [SAVE/ENTER] button to return to the training menu page (TRNG1).

● **Viewing your high score**

5-1. With the message “Finished!” displayed on-screen, press the [▶] button twice.

5-2. The best score you have recorded so far will be displayed.



Press the [SAVE/ENTER] button to return to the training menu page (TRNG1).

Recording Your Performances

You can record your performances in the DTX502 in the form of User songs.

NOTE

- Performances recorded in the drum module are not saved as audio files. Instead, they are saved in the form of MIDI data, which describes which pads were played and when.
- The following cannot be used while recording.
 - Pad Song
 - Pad Function

Getting Ready

1. Press the [SONG] button.



2. Turn the Data Dial to select the User song (61 to 100) you wish to record into.

If you wish to record your performance while playing along with a Preset song (1 to 60), you should instead select that song. In such a case, your performance will be recorded into the lowest numbered User song containing no data.

NOTICE
You can record into a User song that already contains data; however, that data will be overwritten with your new performance. Before proceeding, therefore, you should ensure that the User song in question contains no irreplaceable data.

3. Hold down the [SHIFT] button and press the [SONG] button to open the REC page.



NOTE
If no space is available for recording in User songs, the message "Seq data is not empty." will be displayed.

4. Move the cursor to the item you want to change using the [◀]/[▶] buttons, and then turn the Data Dial to change its value.

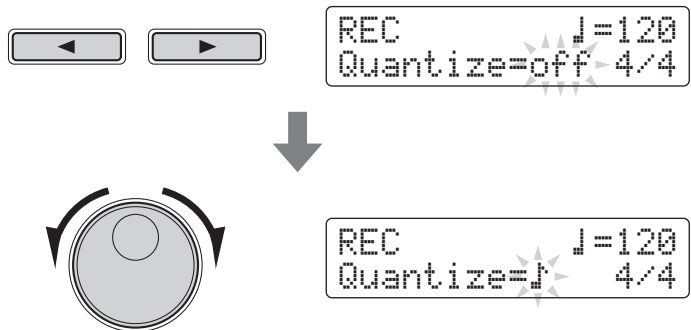

Recording Your Performances

● Tempo

You can set the song tempo at which you wish to record your performance.

● Quantize

Quantization is a function that corrects any small deviations in the timing of your performance. The DTX502 can make recordings quantized based on a specified note length. The available quantization settings are as follows.

- When 3/8, 6/8, 9/8, 12/8, or 15/8 is set as the time signature:

↓, ↓, ↓, ↓, ↓, ↓, or off

- When a time signature other than the above is set:

↓, ↓, ↓, ↓, ↓, ↓, or off

Example of how quantizing works

- These recorded notes were not played exactly in time.



- However, quantization can correct these small deviations in timing as follows.

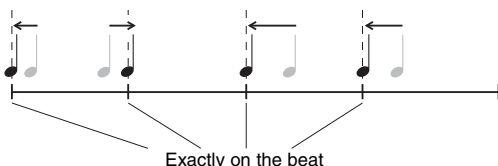

● Time signature

You can also set the time signature for the metronome when recording.

NOTE

When quantization is set to "off", deviations in the timing of your drumming will not be corrected.

Recording

1. Press the [▶/■] button.

You will be counted in and recording will then start.



```
REC Meas=001:01
Now recording...
```

NOTE

If you would like to hear the metronome as you record, be sure to turn it on before you start recording.

2. To stop recording, press the [▶/■] button once again.

Playing Back a Performance

1. Press the [▶/■] button.

2. To stop playback, press the [▶/■] button once again.

NOTE

You cannot record audio input via the [AUX IN] jack.

Naming a User Song

Using the following procedure, you can freely assign a name to the User song you have recorded.

1. Press the [SAVE/ENTER] button on the SONG1 page.

The button will start to flash and the following page will be displayed.



```
SONG save name
: [Untitled]
```

2. Change the displayed name as required.

Press the [◀]/[▶] buttons to move the cursor to the character you wish to change, and then turn the Data Dial to change it.

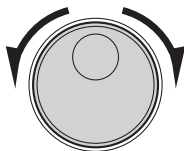

```
SONG save name
: [Tn]titled]
```

3. Press the [SAVE/ENTER] button once again.



```
SONG save name
> Are you sure? <
```

To cancel the process without changing the song name, press the [] button.

4. Press the [SAVE/ENTER] button to save the new song name.

NOTE

- Preset songs cannot be renamed.
- Songs containing no data (i.e., "EmptySng") cannot be renamed.

SONG4**Deleting a Recorded Performance****1. Press the [SONG] button.**

The SONG1 page will be displayed.

2. Turn the data dial to select the song you wish to delete.**3. Navigate to the SONG4 page using the [◀]/[▶] buttons.****4. Press the [SAVE/ENTER] button.**

To cancel the process without deleting the song, press the [] button.

5. Press the [SAVE/ENTER] button to delete the selected song.**NOTE**

Preset songs cannot be deleted.

Setting Parameters using Menu Mode

Menu Mode is used to customize drum-module parameters and functions, which are organized into the following eight areas.

Menu Mode

01: Mixer Area: Mixer settings

- └─ MIXER Mixer settings..... Page 57

02: KitVoice Area: Settings affecting individual voices

- └─ KitV1 Layers Page 57
- └─ KitV2 Voices Page 58
- └─ KitV3 Volume Page 59
- └─ KitV4 Tuning Page 59
- └─ KitV5 Stereo Panning Page 59
- └─ KitV6 Decay Page 59
- └─ KitV7 Cutoff Frequency Page 59
- └─ KitV8 MIDI Note Number Page 60
- └─ KitV9 MIDI Channel Page 60
- └─ KitV10 MIDI Gate Time Page 60
- └─ KitV11 Reverb Send (Source) Page 60
- └─ KitV12 Hold Mode Page 61
- └─ KitV13 Alternate Group Page 61

03: KitCommon Area: Settings affecting entire kits

- └─ KitC1 Double Bass Switch Page 61
- └─ KitC2 Reverb Send (Voices) Page 61
- └─ KitC3 Reverb Type Page 62
- └─ KitC4 Reverb Return Page 62
- └─ KitC5 Pad Control Page 62
- └─ KitC6 Snare Adjustment Page 62
- └─ KitC7 Tempo Page 62
- └─ KitC8 Trigger Setup Link Page 63
- └─ KitC9 MIDI Program Change Page 63
- └─ KitC10 MIDI Control Change Page 63

04: KitJob Area: Kit management

- └─ KitJ1 Copy Pad Page 64
- └─ KitJ2 Clear User Kit Page 65

05: Pad Area: Pad-related settings

- └─ Pad1 Hi-hat Splash Sensitivity Page 65
- └─ Pad2 Foot Close Position Page 65
- └─ Pad3 Pad Function Page 66

06: Trigger Area: Trigger-related settings

- └─ TRG1 Trigger Setup Page 66
- └─ TRG2 Velocity Curve Page 67
- └─ TRG3 Pad Type Page 68
- └─ TRG4 Gain Page 68
- └─ TRG5 Minimum Level Page 68
- └─ TRG6 Minimum Velocity Page 69
- └─ TRG7 Reject Time Page 69
- └─ TRG8 Wait Time Page 69
- └─ TRG9 Noise Filter Page 69
- └─ TRG10 Crosstalk Page 70
- └─ TRG11 Crosstalk Pads Page 70
- └─ TRG12 Copy Trigger Page 71

07: Training Area: Training-related settings

- └─ Trng1 Timer Page 72
- └─ Trng2 Difficulty Level Page 72
- └─ Trng3 Ignore Timing Page 72
- └─ Trng4 Pad Gate Group Page 72
- └─ Trng5 Fast Blast Timer Page 73

08: System Area: System settings

- └─ System1 Kit Lock Page 73
- └─ System2 Muted Volume Page 73
- └─ System3 Master Equalizer Page 74
- └─ System4 Master Tuning Page 74
- └─ System5 Local Control Page 74
- └─ System6 Metronome Output Page 74
- └─ System7 Number Display Function Page 74
- └─ System8 Auto Power-Off Page 75
- └─ System9 Restore Page 75
- └─ System10 Factory Set Page 75

Setting Procedure

Use the following procedure in Menu Mode to select parameters and change their settings.

1. Hold down the [SHIFT] button and press the [SAVE/ENTER] button to access Menu Mode.

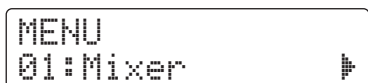

2. Turn the Data Dial to select the area containing the parameter you wish to set.



3. Use the [◀]/[▶] buttons to select the parameter.

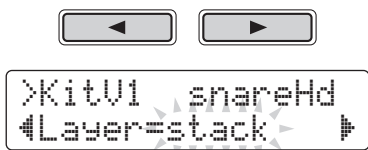

NOTE

When a number of parameters are contained in a single page, you can move the cursor between them using the [◀]/[▶] buttons.

4. Turn the Data Dial to change the parameter's setting.



NOTICE

Whenever you change a parameter setting in the Kit-Voice area, the KitCommon area, the KitJob area, or on one of pages TRG2 to TRG12 from the Trigger area, an asterisk will be displayed after the page name (i.e., "TRG2*"). This is to remind you that parameters have been changed but not yet stored. To store your settings, follow the procedure described in the column on the right. The asterisk will disappear when you store your settings.

Parameter values from pages where an asterisk is not displayed are stored automatically.

Storing your settings

If you change a parameter setting in the KitVoice area, the KitCommon area, the KitJob area, or on one of pages TRG2 to TRG12 from the Trigger area, you will need to store the new setting in the drum module's internal memory as described below.

NOTE

If you switch to another kit or trigger setup or turn off the drum module without storing your new settings, the parameters in question will revert to their previously stored settings.

Procedure

As an example, the following describes how to store modified trigger settings. Note that trigger settings are stored as part of a User trigger setup. Meanwhile, settings from the KitVoice, KitCommon, and KitJob areas are stored as part of one of the User kits, which are numbered 51 to 100 (page 25).

1. After changing trigger parameter settings, press the [SAVE/ENTER] button.
The page for storing trigger setup data will be displayed.

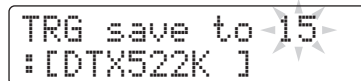

2. Turn the Data Dial to select the User trigger setup (15 to 30) in which you wish to store your settings.

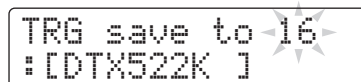

3. To rename the trigger setup, move the cursor using the [◀]/[▶] buttons and turn the Data Dial to change the selected character.

4. Press the [SAVE/ENTER] button once again.
You will be asked to confirm that you wish to store your settings.

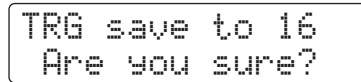

CAUTION

When you store trigger setup data, all of the data in the selected trigger setup will be overwritten with your new settings. Before proceeding, therefore, you should ensure that the trigger setup in question contains no irreplaceable settings.

5. Press the [SAVE/ENTER] button to store your settings.
To cancel the process without storing any settings, press the [] button.
6. When your settings have been successfully stored, the message "Completed." will be displayed.

01: Mixer Area

Mixer settings

The Mixer area is used to adjust the volumes of the various drum kit voices.

MIXER Mixer settings

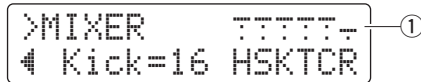

① **Volume**

Use the volume parameters to balance the input group* volumes.

● **Input group indicators**

- H: Hi-hat sound volumes
- S: Snare sound volumes
- K: Kick sound volumes
- T: Tom sound volumes
- C: Cymbal sound volumes
- R: Degree to which reverb is applied

Use the [◀]/[▶] buttons to select an input group, and then turn the Data Dial to adjust its volume. Faders are displayed above each of the input-group indicators to give a general idea of the current volume balance. The reverb (R) setting applies to all of the drum kit's voices.

NOTE

*: **Input groups**

Voices are organized into input groups based on their voice category. For example, when you change the T setting (tom sound volumes), the volume of all sounds from the Tom (T) voice category will change accordingly.

Settings	0 to 16
-----------------	---------

02: KitVoice Area

Settings affecting individual voices

The KitVoice area is used to set drum voices for individual trigger input sources.

KitV1 Layers

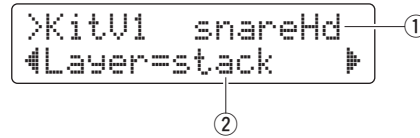

① **Trigger input source**

This item indicates the trigger input source currently selected for editing. Trigger input sources can be selected by striking the corresponding pad or zone. This selection applies to both Layer A and Layer B. (Trigger input sources are not displayed individually for each layer.)

NOTE







You can also select trigger input sources by holding down the [SHIFT] button and pressing the [◀]/[▶] buttons.

Settings	snareHd, snareOp, snareCl, snrOfHd, snrOfOp, snrOfCl, tom1Hd, tom2Hd, tom3Hd, rideBw, rideEg, rideCp, crashBw, crashEg, crashCp, kick, pad8, hhOpBw, hhOpEg, hhOpCp, hhClBw, hhClEg, hhClCp, hhFtCl, hhSplsh, pad10, pad11, pad12, and kick2 For details on the correspondence between trigger input jacks and trigger input sources, refer to page 29.
-----------------	--

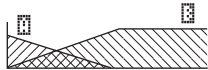
Setting Parameters using Menu Mode

② Layer

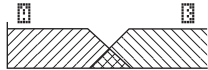
Use this parameter to specify how the voices are to be arranged in the two layers (A and B) for the specified trigger input source.

Settings	Description
off	Layer B is turned off and only the voice from Layer A produces a sound.
stack	The voices from Layer A and Layer B produce sounds at the same velocity over the entire velocity range.
Using the settings "XFade1" to "XFade9", you can crossfade the velocities of Layer A and Layer B in various different ways as shown below.	
XFade1	
XFade2	
XFade3	
XFade4	
XFade5	
XFade6	
XFade7	
XFade8	
XFade9	
VelSw***	The two voices are layered at the velocity indicated in the setting value. For example, with a setting of "VelSw60", the voice from Layer A would produce a sound at velocities from 1 to 59, and the voice from Layer B would produce a sound at velocities from 60 to 127.

KitV2 Voices

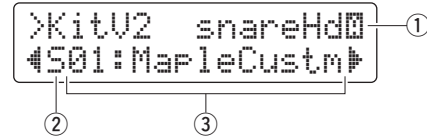

① Trigger input source

This item indicates the trigger input source currently selected for editing. Trigger input sources can be selected by striking the corresponding pad or zone. To switch between Layer A and Layer B, hold down the [SHIFT] button and press the [◀] or [▶] button accordingly.

NOTE

You can also select trigger input sources by holding down the [SHIFT] button and pressing the [◀/▶] buttons.

Settings	Description
snareHd, snareOp, snareCl, snrOfHd, snrOfOp, snrOfCl, tom1Hd, tom2Hd, tom3Hd, rideBw, rideEg, rideCp, crashBw, crashEg, crashCp, kick, pad8, hhOpBw, hhOpEg, hhOpCp, hhClBw, hhClEg, hhClCp, hhFtCl, hhSplsh, pad10, pad11, pad12, and kick2	
	For details on the correspondence between trigger input jacks and trigger input sources, refer to page 29.

② Voice category

Use this parameter to set the category from which a voice will be assigned to the selected layer.

Settings	Description
K	Kick
S	Snare
T	Tom
C	Cymbal
H	Hi-hat
P	Percussion
E	Effect
W	Wave Voice ^{(*)1}
♪	Pad Song ^{(*)2}

NOTE

*1: Wave voices

A wave voice is an audio file containing, for example, an instrument sound, an effect sound, or a sampled phrase. These .WAV format files can be transferred from a computer to your drum module and used as voices for pads. See page 79 for instructions on how to transfer them to the drum module.

*2: Pad Song

Using the Pad Song function, you can play one of the drum module's internal songs simply by striking a pad. In the same way as regular voices, these songs can be assigned to individual pad layers. The Pad Song function can play up to three songs simultaneously. In addition, when you have selected Pad Song as the voice category, you can also set the song's Repeat and Play modes as shown below (page 30).

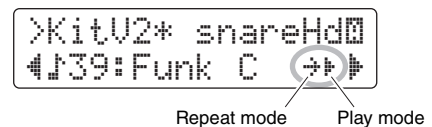

③ **Voice Number: Voice Name**

Use the Voice Number parameter to choose a voice from the selected category.

Settings	The number of available voices varies depending on the selected category. For details on the voices in each, refer to the Voice List (page 85).
-----------------	---

NOTE

When "00:NoAssign" is selected as the voice, the layer in question will not produce any sound.

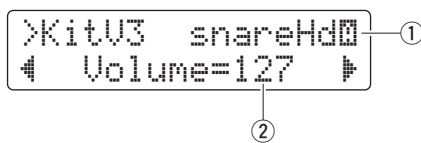
KitV3 Volume① **Trigger input source**

See ① Trigger input source from the description of the KitV2 page.

② **Volume**

Use this parameter to set the volume of the voice assigned to the selected layer.

Settings	0 to 127
-----------------	----------

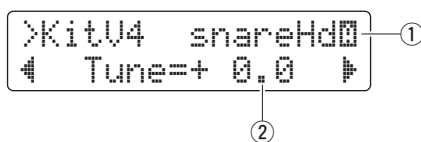
KitV4 Tuning① **Trigger input source**

See ① Trigger input source from the description of the KitV2 page.

② **Tune**

Use this parameter to set the tuning of the voice assigned to the selected layer.

Settings	-24.0 to +24.0 (in 10-cent steps)
-----------------	-----------------------------------

NOTE

This setting has no effect when Pad Song (♪) is selected as the voice category.

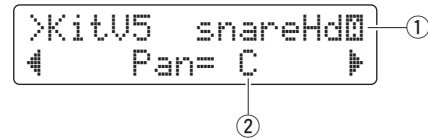
KitV5 Stereo Panning① **Trigger input source**

See ① Trigger input source from the description of the KitV2 page.

② **Pan**

Use this parameter to set the stereo panning of the voice assigned to the selected layer.

Settings	L64 to C to R63
-----------------	-----------------

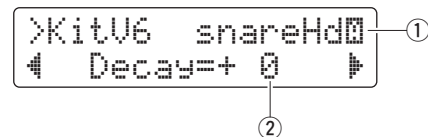
KitV6 Decay① **Trigger input source**

See ① Trigger input source from the description of the KitV2 page.

② **Decay**

The amount of time it takes a voice to fade away to silence is referred to as its "decay". Use this parameter to set the decay for the voice assigned to the selected layer. Positive values produce shorter decay times and crisper sounds.

Settings	-64 to 0 to +63
-----------------	-----------------

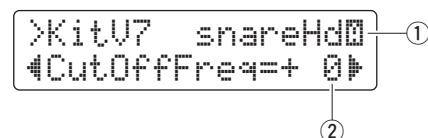
KitV7 Cutoff Frequency① **Trigger input source**

See ① Trigger input source from the description of the KitV2 page.

② **CutOffFreq**

Use this parameter to set the filter cutoff frequency for the voice assigned to the selected layer. Negative values produce darker sounds and vice-versa.

Settings	-64 to 0 to +63
-----------------	-----------------

Setting Parameters using Menu Mode

KitV8 MIDI Note Number

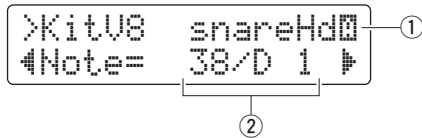

① **Trigger input source**

See ① Trigger input source from the description of the KitV2 page.

② **Note**

Use this parameter to set the MIDI note number that is output whenever a trigger signal is received from the selected trigger input source. Settings can be made individually for Layer A and Layer B, meaning that two MIDI notes with different note numbers can be output simultaneously in response to a single trigger signal. Settings are displayed as “Note number / Note name”.

Settings	0/C-2 to 127/G 8
-----------------	------------------

NOTE

Layer B will not produce any MIDI notes when the Layer parameter from the KitV1 page is set to “off”.

KitV9 MIDI Channel

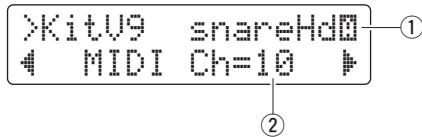

① **Trigger input source**

See ① Trigger input source from the description of the KitV2 page.

② **MIDI Ch**

Use this parameter to set the MIDI channel on which notes are output whenever a trigger signal is received from the selected trigger input source. Settings can be made individually for Layer A and Layer B.

Settings	1 to 16
-----------------	---------

KitV10 MIDI Gate Time

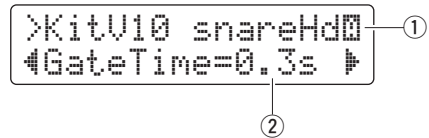

① **Trigger input source**

See ① Trigger input source from the description of the KitV2 page.

② **GateTime**

The time that passes between the output of a MIDI Note On message and the corresponding Note Off message is referred to as the “gate time”. Use this parameter to set the gate time for notes output whenever a trigger signal is received from the selected trigger input source. Settings can be made individually for Layer A and Layer B.

Settings	0.0s to 9.9s
-----------------	--------------

KitV11 Reverb Send (Source)

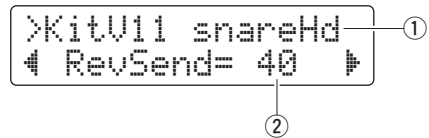

① **Trigger input source**

See ① Trigger input source from the description of the KitV1 page. The setting made on this page applies to both Layer A and Layer B.

② **RevSend**

Use this parameter to specify how much reverb is to be applied to voices produced by the specified trigger input source.

Settings	0 to 127
-----------------	----------

KitV12 Hold Mode

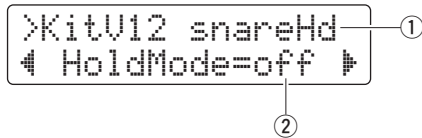

① **Trigger input source**

See ① Trigger input source from the description of the KitV1 page. The setting made on this page applies to both Layer A and Layer B.

② **HoldMode**

Use this parameter to turn Hold mode on or off for voices produced by the specified trigger input source.

Settings	Description
on	MIDI Note On and Note Off messages are output alternately whenever the pad is struck. Note that when Wave Voice (W) has been specified as the voice category, the Wave Voice will be played repeatedly.
off	This setting corresponds to normal operation: A MIDI Note On message is output when the pad is struck, and the corresponding MIDI Note Off message is output automatically after the gate time has elapsed.

KitV13 Alternate Group

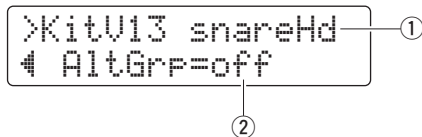

① **Trigger input source**

See ① Trigger input source from the description of the KitV1 page. The setting made on this page applies to both Layer A and Layer B.

② **AltGrp**

Use this parameter to assign the voices produced by the specified trigger input source to an alternate group—that is, a collection of voices that you do not want to play simultaneously, such as open and closed hi-hats. If a voice is triggered while another from the same alternate group is already playing, the earlier voice will be silenced before the new one is played.

Settings	Description
off	Voice is not assigned to an alternate group
HHOpen	Open Hi-hat group
HHClose	Closed Hi-hat group
1 to 9	Numbered alternate groups: Voices that you do not want to play simultaneously can be freely assigned to them.

NOTE

The Open Hi-hat group and the Closed Hi-hat group operate according to the following rules.

- When a voice from the Open Hi-hat group is triggered, other voices from that group and those from the Closed Hi-hat group are not silenced.
- When a voice from the Closed Hi-hat group is triggered, all voices from the Open Hi-Hat group are silenced.

03: KitCommon Area

Settings affecting entire kits

The KitCommon area is used to set parameters that apply to the current kit.

KitC1 Double Bass Switch

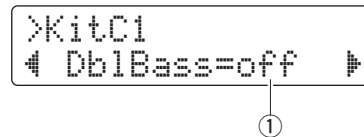

① **DblBass**

By setting this parameter to “on”, you can easily configure your drum module to produce a kick drum sound whenever you operate the pedal connected to the [HI-HAT CONTROL] trigger input jack. This convenient function provides support for double bass drumming techniques.

Settings	off or on
----------	-----------

NOTE

Opening and closing of the hi-hat is not possible when DblBass is set to “on”.

KitC2 Reverb Send (Voices)

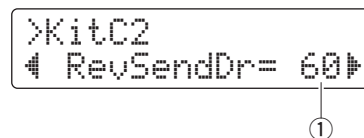

① **RevSendDr**

Use this parameter to specify the level at which all of the current kit’s drum voices are to be sent to the built-in reverb unit.

Settings	0 to 127
----------	----------

NOTE

The RevSendDr parameter affects all of the current kit’s drum voices. To adjust the reverb level for individual pads or trigger input sources, use the Reverb Send (Source) parameter (RevSend) from the KitVoice area (page 60).

KitC3 Reverb Type

```
>KitC3
◀RevType=hall1 ▶
```

①

① RevType

Use this parameter to select the type of reverb to be applied.

Settings	none, hall1, hall2, hall3, room1, room2, room3, stage1, stage2, plate
-----------------	---

KitC4 Reverb Return

```
>KitC4
◀RevMastRet= 64▶
```

①

① RevMastRet

Use this parameter to set the reverb unit's return level.

Settings	0 to 127
-----------------	----------

NOTE

The reverb return level can be adjusted to balance the volumes of the sounds with reverb applied and those without.

KitC5 Pad Control

```
>KitC5
◀PacCtl=snares ▶
```

①

① PacCtl

When a pad unit equipped with a pad controller is connected to the [①SNARE] jack, this parameter can be used to select a function for the controller.

Settings	Description
off	Pad controller performs no function.
snares	Adjustment of snare-wire tension (also affecting open-rim sounds)
tuning	Adjustment of tuning (also affecting open-rim sounds)
tempo	Adjustment of the tempo

KitC6 Snare Adjustment

```
>KitC6
◀ Snares= 4 ▶
```

①

① Snares

Use this parameter to adjust the snare-wire tension for the pad connected to the [①SNARE] jack. An "off" setting simulates the snare wires being fully removed from the head.

Settings	Description
off	Snare wires fully removed
1 to 24	Higher values correspond to tighter snare wires and vice-versa.

KitC7 Tempo

```
>KitC7
◀ Tempo=off ▶
```

①

① Tempo

Use this parameter to specify the tempo to be set automatically upon selection of the current drum kit. When set to "off", the tempo will not change automatically when the current kit is selected.

Settings	off, 30 to 300
-----------------	----------------

KitC8 Trigger Setup Link

```
>KitC8
◀TrgSetupLk=off▶
```

①

① TrgSetupLk

Use this parameter to assign a trigger setup to the currently selected kit. Select “off” if the kit does not need a specific trigger setup.

Settings	off, 01 to 30
-----------------	---------------

KitC9 MIDI Program Change

```
>KitC9 Ch1=off
◀PC001 M000L000▶
```

① ②
③ ④ ⑤

On the MIDI Program Change page, you can specify the MIDI Program Change number to be sent when the current kit is selected, in addition to the corresponding Bank Select MSB and LSB messages.

NOTE

By sending MIDI Program Change messages, you can have the MIDI instrument automatically change its voice when you select the current kit.

① MIDI channel (Ch)

Use this parameter to set the MIDI channel on which to send the Program Change messages.

Settings	1 to 16
-----------------	---------

② Program-change output switch

Use this parameter to turn the output of Program Change messages on or off.

Settings	off or on
-----------------	-----------

③ Program change number

Use this parameter to set the Program Change number to be sent.

Settings	001 to 128
-----------------	------------

④ Bank Select MSB**⑤ Bank Select LSB**

Settings	000 to 127
-----------------	------------

NOTE

In order to set the Bank Select MSB and LSB parameters correctly, you will need to refer to the MIDI instrument's Voice List and MIDI Data Format.

KitC10 MIDI Control Change

```
>KitC10 Ch1=off
◀Vol=100 Pan= C▶
```

① ②
③ ④

On the MIDI Control Change page, you can set values for MIDI Control Change volume and pan messages to be sent when the current kit is selected.

NOTE

By sending these MIDI Control Change messages, you can have the MIDI instrument connected via the MIDI OUT connector automatically set its volume and stereo panning when you select the current kit.

① MIDI channel (Ch)

Use this parameter to set the MIDI channel on which to send the Control Change messages.

Settings	1 to 16
-----------------	---------

② Control Change output switch

Use this parameter to turn the output of Control Change messages on or off.

Settings	off or on
-----------------	-----------

③ Volume

Use this parameter to set a value for the Control Change volume message.

Settings	0 to 127
-----------------	----------

④ Pan

Use this parameter to set a value for the Control Change pan message.

Settings	L64 to C to R63
-----------------	-----------------

04: KitJob Area

Kit management

KitJ1 Copy Pad

```
>KitJ1 CopyPad
#01:Snare→Snare#
```

On the Copy Pad page, you can copy all settings for a specific pad into the current kit from another.

NOTICE

When you copy a pad using the procedure described below, the current kit's settings will be modified but not saved (i.e., the asterisk (*) will be displayed). To make the change permanent, be sure to save your settings (page 25). If you select another kit or turn off the drum module without doing so, the kit will revert to its original settings.

1. Navigate to the Copy Pad page and set both the kit to copy from and the pad to be copied.

```
>KitJ1 CopyPad
#02:Snare→Snare#
```

Number of kit to copy from: Pad to be copied

NOTE

When the pad name is flashing, you can also select a different one by striking it or by holding down the [SHIFT] button and pressing the [◀/▶] buttons.

2. Move the cursor and set the destination pad (from the current kit).

```
>KitJ1 CopyPad
#02:Tom1→Tom2#
```

Destination pad

NOTE

When the destination pad is flashing, you can also select a different one by striking it or by holding down the [SHIFT] button and pressing the [◀/▶] buttons.

3. Press the [SAVE/ENTER] button.
You will be asked to confirm that you wish to copy the pad.

[SAVE/ENTER]

```
>KitJ1 CopyPad
Are you sure?
```

CAUTION

Whenever a pad is copied, all of the destination pad's settings will be overwritten with those of the copied pad. Before proceeding, therefore, you should ensure that the destination pad contains no irreplaceable settings.

Press the [SAVE/ENTER] button once again to copy the pad. To cancel the process without copying any data, press the [] button.

4. When the pad has been successfully copied, the message "Completed." will be displayed.

KitJ2 Clear User Kit

```
>KitJ2 Clear
451:User Kit
```

On the Clear User Kit page, you can restore a User kit to its default settings.

1. Navigate to the Clear User Kit page and specify which of the User kits (numbered 51 to 100) is to be cleared.

```
>KitJ2 Clear
451:User Kit
```

User kit number

2. Press the [SAVE/ENTER] button.
You will be asked to confirm that you wish to clear the User kit.

SAVE/ENTER

```
>KitJ2 Clear
Are you sure?
```

⚠ CAUTION

When a User kit is cleared, all of its settings will be returned to their default conditions. Before proceeding, therefore, you should ensure that the User kit in question contains no irreplaceable settings.

Press the [SAVE/ENTER] button once again to clear the User kit. To cancel the process without clearing any settings, press the [] button.

3. When the User kit has been successfully cleared, the message "Completed." will be displayed.

05: Pad Area**Pad-related settings****Pad1 Hi-hat Splash Sensitivity**

```
>Pad1
4 Splash= 30
```

①

① Splash

Use this parameter to set the degree of sensitivity for detecting hi-hat foot splashes. The higher the value, the easier it will be to produce a foot-splash sound with the hi-hat controller. High values may, however, result in splash sounds being unintentionally produced when, for example, you operate the hi-hat controller lightly as you keep time. It is a good idea to set this parameter to "off" if you do not want to play foot splashes.

Settings	off, 1 to 127
-----------------	---------------

Pad2 Foot Close Position

```
>Pad2
4 ClosePos=28
```

①

① ClosePos

Use this parameter to adjust the position at which the hi-hat switches from open to closed when the hi-hat controller is depressed. The lower the value, the smaller the virtual opening between the top and bottom hi-hats.

Settings	0 to 32
-----------------	---------

Pad3 Pad Function

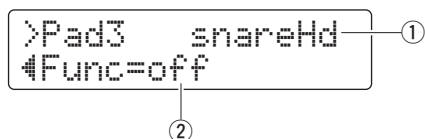

① **Trigger input**

This item indicates the trigger input source to which a function is to be assigned. Trigger input sources can be selected by striking the corresponding pad or zone.

NOTE

You can also select trigger input sources by holding down the [SHIFT] button and pressing the [◀]/[▶] buttons.

② **Func**

Pad Function allows control panel operations and the like to be performed by striking the specified pad or zone. Use this parameter to select the function to be performed.

Settings	Description
off	Voices will be played in the normal way.
inc kitNo	Increase the kit number by 1
dec kitNo	Decrease the kit number by 1
inc songNo	Increase the song number by 1
dec songNo	Decrease the song number by 1
inc clkNo	Increase the Click Set by 1
dec clkNo	Decrease the Click Set by 1
inc tempo	Increase the tempo by 1 BPM
dec tempo	Decrease the tempo by 1 BPM
tap tempo	Tap a new tempo (page 36)
clkOn/Off	Turn the metronome on or off
song▶■	Start or stop an external song
clk&song▶■	Turn the metronome on or off and simultaneously start or stop an external song (synchronized with the metronome)
doubleBass	Turn the Double Bass Switch on or off (page 61)

NOTE

Pad Function cannot be used when in Training Mode.

06: Trigger Area

Trigger-related settings

TRG1 Trigger Setup

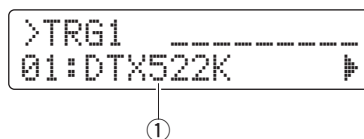

① **Trigger setup**

Use this parameter to select a trigger setup.

Settings	
	01: DTX522K, 02: DTX532K, 03: DTX542K, 04: DTX562K, 05: DTX500K, 06: DTX520K, 07: DTX530K, 08: DTX540K, 09: DTX550K, 10: DTX560K, 11: DTXP4STD (DTXPRESS IV STD SET), 12: DTXP4SP (DTXPRESS IV SP SET), 13: DTXPL (DTXPLOER), 14: DrumTrig, and 15–30: UserTrig

NOTE

The most appropriate trigger setup for your electronic drum kit will be automatically selected during the Initial Setup process (page 13). For this reason, it is usually not necessary to change the setting on this page. However, you may decide to edit trigger parameters after making detailed changes to the settings of individual pads in order, for example, to add another pad or to eliminate crosstalk. In such a case, you should store your settings in a User trigger setup (numbered 15 to 30) as described below.

TRG2 Velocity Curve

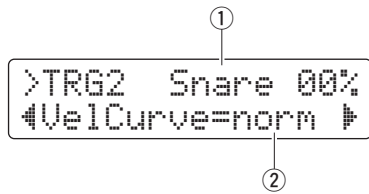

① Trigger input

This item indicates the pad to be edited. If necessary, strike a different pad to select it.

NOTE

- The percentage value at the top-right of the screen indicates the trigger input level when the pad is struck.
- You can also select a pad by holding down the [SHIFT] button and pressing the [◀/▶] buttons.

Settings	Snare, Tom1, Tom2, Tom3, Ride, Crash, Kick, Pad8, Hihat, Pad10, Pad11, and Pad12
-----------------	--

② VelCurve

Use this parameter to select a velocity curve for the selected pad. A velocity curve determines how the velocity (or power) of the sound is affected by how hard you strike the pad.

Settings	loud2, loud1, norm, hard1, hard2, Fix1 to Fix5, Spl11 to Spl15, Spl21 to Spl25, and ofs1 to ofs5
-----------------	--

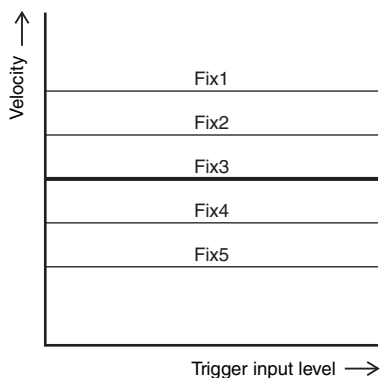
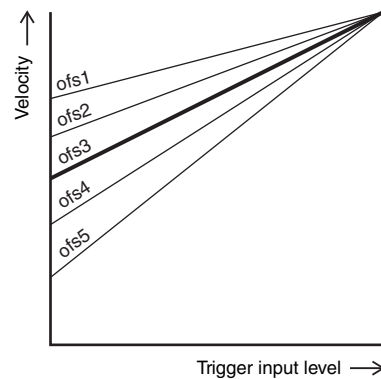
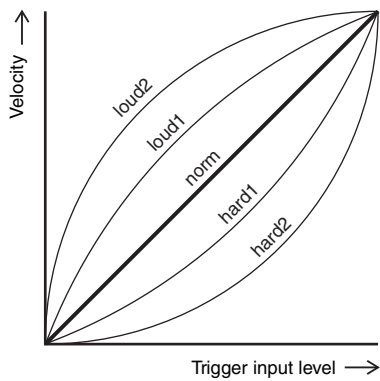
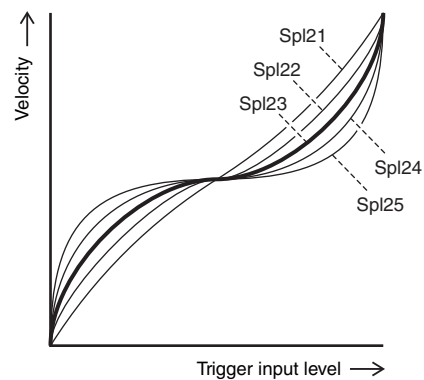
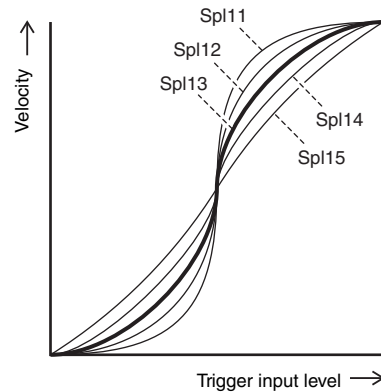

TRG3 Pad Type

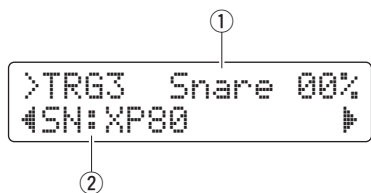

- ① **Trigger input**
See ① Trigger input from the description of the TRG2 page.
- ② **Pad Type**
Use this parameter to specify a type for the selected pad.

Settings	
--	OFF
KK	KP125W/125, KP65, or KU100
SN	XP120/100, XP80, XP70, TP120SD/100, TP70S/70, or TP65S/65
TM	XP120/100, XP80, XP70, TP120SD/100, TP70S/70, or TP65S/65
CY	PCY155, PCY150S, PCY135, PCY130SC, PCY130S/130, PCY100, PCY90, or PCY65S/65
HH	RHH135, RHH130, PCY100, PCY90, or TP65S/65
DT	DT10/20SN (for snare drums), DT10/20tomH (for high toms), DT10/20tomL (for low toms), DT10/20kick (for kick drums), or misc1 to misc4 (for non-Yamaha pads)
2P	<p>For dual piezo pads</p> <p>*: Only selectable when the input source ① is Tom1, Tom2, or Kick.</p> <p>*: Balance settings can be made for the two piezos (H49 to H1, 0, or R1 to R49). If, for example, a dual piezo pad was connected to the [TOM1/10] jack, Tom 1 would be the head (H) and Pad 10 would be the rim (R). If the head sounds when the rim is struck, move the balance further to the R side to ensure that the rim sounds instead. Similarly, if the rim sounds when the head is struck, move the balance further to the H side.</p>

```
>TRG3 Tom1 0%
42P:Balance=R 6▶
```

TRG4 Gain

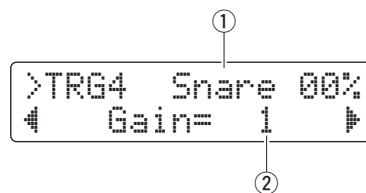

- ① **Trigger input**
See ① Trigger input from the description of the TRG2 page.
- ② **Gain**
Use this parameter to set the level of gain (or amplification) applied to trigger input signals from the selected pad. The higher the gain setting, the louder the sounds produced by light drumming.

Settings	1 to 127
----------	----------

TRG5 Minimum Level

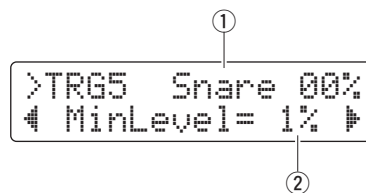

- ① **Trigger input**
See ① Trigger input from the description of the TRG2 page.
- ② **MinLevel**
Use this parameter to set the minimum level of trigger signal that must be received at the selected pad in order for a sound to be produced.

Settings	0 to 99 (%)
----------	-------------

TRG6 Minimum Velocity

```

    ①
    >TRG6 Snare 00%
    ◀ MinVel= 1 ▶
    ②
  
```

① Trigger input

See ① Trigger input from the description of the TRG2 page.

② MinVel

Use this parameter to specify the velocity (or volume) of sounds produced by trigger signals at the minimum level set on the Minimum Level page (TRG5).

Settings	0 to 126
-----------------	----------

TRG7 Reject Time

```

    ①
    >TRG7 Snare 00%
    ◀ RejTime= 5ms ▶
    ②
  
```

① Trigger input

See ① Trigger input from the description of the TRG2 page.

② RejTime

Trigger inputs can be set to accept only the first of a number of trigger signals arriving very close together. Use this parameter to set the reject time for the selected pad—that is, how long it will wait after accepting one trigger signal before accepting another. In this way, you can prevent a rebounding stick or beater from producing more than one sound (i.e., double triggering).

Settings	4 to 500 (ms)
-----------------	---------------

TRG8 Wait Time

```

    ①
    >TRG8 Snare 00%
    ◀ WaitTime= 4ms ▶
    ②
  
```

① Trigger input

See ① Trigger input from the description of the TRG2 page.

② WaitTime

Use this parameter to specify how long the selected pad will wait before detecting a trigger signal. By adjusting this time to ensure that trigger signals are detected at their peak levels, you can ensure that the volume of sounds produced accurately reflects the strength of playing.

Settings	1 to 64 (ms)
-----------------	--------------

TRG9 Noise Filter

```

    ①
    >TRG9 Snare 00%
    ◀ NoiseFilter= 5 ▶
    ②
  
```

① Trigger input

See ① Trigger input from the description of the TRG2 page.

② NoiseFilter

Any noise contained in trigger signals can cause sounds to be produced unintentionally. Use this parameter to filter out such noise. Larger values correspond to a higher level of filtering.

Settings	1 to 10
-----------------	---------

NOTE

Larger noise filter settings can, in cases where the pad is struck multiple times in rapid succession, result in sounds being dropped. Be sure to adjust the setting to best match your style of drumming.

TRG10 Crosstalk

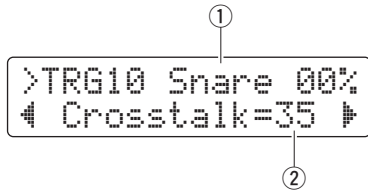

① Trigger input

See ① Trigger input from the description of the TRG2 page.

② Crosstalk

The term “crosstalk” refers to the output of spurious trigger signals from a pad other than the one that was struck as a result of vibration or interference between pads. Use this parameter to specify a level for preventing crosstalk from the pads set on the Crosstalk Pads page (TRG11). If the level of the trigger signal from the pad indicated by ① is lower than this level whenever one of those pads is struck, it will be treated as crosstalk and no sound will be produced. Although higher setting values are more effective in preventing crosstalk, they can also make it difficult to play softly on multiple pads at the same time.

Settings	0 to 99
-----------------	---------

TRG11 Crosstalk Pads

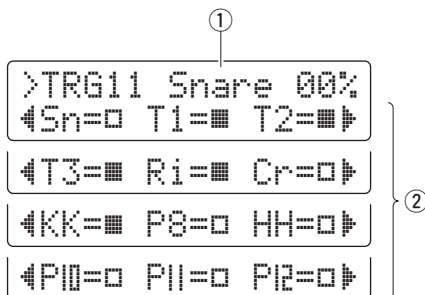

① Trigger input

See ① Trigger input from the description of the TRG2 page.

② Crosstalk pads

Use these parameters to select (■) the pads that tend to produce crosstalk in the pad indicated by ①. The setting from the Crosstalk page (TRG10) will apply to these pads. No crosstalk elimination is performed for unselected pads (□).

Settings	Sn (Snare), T1 (Tom1), T2 (Tom2), T3 (Tom3), Ri (Ride), Cr (Crash), KK (Kick), P8 (Pad8), HH (HiHat), P10 (Pad10), P11 (Pad11), and P12 (Pad12)
-----------------	---

Tip

Eliminating Crosstalk

The following example shows how crosstalk could be eliminated if snare sounds were unintentionally produced when toms 1 and 2 were played.

1. Hold down the [SHIFT] button and press the [SAVE/ENTER] button to access Menu Mode. Select the Trigger area (06:Trigger) and navigate to the Crosstalk page (TRG10).

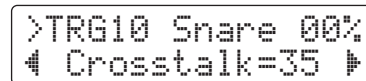

2. Strike the snare pad to select it for crosstalk elimination.

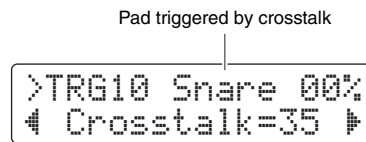

3. Move to the Crosstalk Pads page (TRG11) using the [◀]/[▶] button and select (■) T1 and T2 as the pads causing crosstalk in the snare. The setting made in Step 4 below will now be applied to trigger signals from pads T1 and T2.

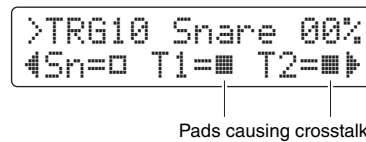

4. Move back to the Crosstalk page (TRG10) using the [◀] button. Play pads T1 and T2 to determine the level of trigger signal they produce in the snare, and set the Crosstalk parameter to this level.

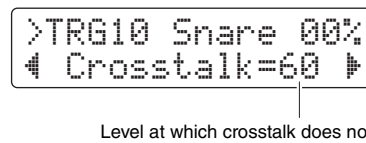

5. Verify that pads T1 and T2 no longer produce crosstalk in the snare. If necessary, store your settings (page 56).

TRG12 Copy Trigger

```
>TRG12 CopyPad
◀ 1:Snare→Snare
```

On the Copy Trigger page, you can copy all settings for a specific pad into the current trigger setup from another.

NOTICE

When you copy pad settings using the procedure described below, the current trigger setup's settings will be modified but not stored (i.e., the asterisk (*) will be displayed). To make the change permanent, be sure to store your settings (page 56). If you select another kit or turn off the drum module without doing so, the trigger setup will revert to its original settings.

1. Navigate to the Copy Trigger page and set both the trigger setup to copy from and the pad to be copied.

```
>TRG12 CopyPad
◀ 1:Snare→Snare
```

Number of trigger setup to copy from: Pad to be copied

NOTE

When the pad name is flashing, you can also select a different one by striking it or by holding down the [SHIFT] button and pressing the [◀/|▶] buttons.

2. Move the cursor and set the destination pad (from the current drum trigger).

```
>TRG12 CopyPad
◀ 2:Tom1→Tom2
```

Destination pad

NOTE

When the destination pad is flashing, you can also select a different one by striking it or by holding down the [SHIFT] button and pressing the [◀/|▶] buttons.

3. Press the [SAVE/ENTER] button.
You will be asked to confirm that you wish to copy the pad.

SAVE/ENTER

```
>TRG12 CopyPad
Are you sure?
```

CAUTION

Whenever a pad is copied, all of the destination pad's settings will be overwritten with those of the copied pad. Before proceeding, therefore, you should ensure that the destination pad contains no irreplaceable settings.

Press the [SAVE/ENTER] button once again to copy the pad. To cancel the process without copying any data, press the [↵] button.

4. When the pad has been successfully copied, the message "Completed." will be displayed.

07: Training Area

Training-related settings

The Training area is used to set training-function parameters.

Trng1 Timer

```
>Trng1
└ Timer=off ┘
```

① **Timer**

Use this parameter to set the practice timer used in Training Mode. The timer is started at the beginning of practice, and when it reaches the set time, the practice session will end automatically.

Settings	off, 30s, 60s, 90s, 120s, 150s, 180s, 300s, 480s, and 600s
-----------------	--

NOTE

The above setting applies only to the following types of training.

- Groove Check
- Rhythm Gate
- Measure Break
- Tempo Up/Down
- Change Up
- Pad Gate

Trng2 Difficulty Level

```
>Trng2
└ Difficulty=3 ┘
```

① **Difficulty**

Use this parameter to set the training difficulty level. The larger the setting, the more difficult the training.

Settings	1 to 5
-----------------	--------

NOTE

The above setting applies only to the following types of training.

- Tempo Up/Down
- Change Up
- Pad Gate

Trng3 Ignore Timing

```
>Trng3
└ IgnrTiming=off ┘
```

① **IgnrTiming**

Use this parameter to specify whether or not the pads are to produce sounds when played out of time. When set to “on”, they will always produce a sound.

Settings	off or on
-----------------	-----------

NOTE

The above setting applies only to the following types of training.

- Tempo Up/Down
- Change Up
- Pad Gate

Trng4 Pad Gate Group

```
>Trng4
└ Group=group1 ┘
```

① **Group**

Use this parameter to set which groups of pads the drum module should consider when deciding whether or not you are playing the song’s drum pattern correctly in Pad Gate training (page 46).

Settings	Description
all pads	Any pad will be scored, as long as the timing of your drumming is correct.
group1	The kit is separated into five groups—kick, snare, toms, cymbals, and hi-hat. In order for your drumming to be scored, you must strike pads from the same group as those from the practice drum pattern and do so in time.
group2	Similar to “group 1”, but all toms and cymbals are treated separately. In addition, the hi-hat pad and the hi-hat controller are also divided into separate groups.
all note	With this setting, you must play the drum pattern exactly as it is in the song.

NOTE

The above setting applies only to Pad Gate training.

Trng5 Fast Blast Timer

```
>Trng5
◀BlastTimer= 10s
```

①

① BlastTimer

Use this parameter to set the practice time for Fast Blast training (page 49). The timer is started at the beginning of practice, and when it reaches the set time, the practice session will end automatically.

Settings	10s, 30s, 60s, 90s, 120s, 150s, 180s, 300s, 480s, and 600s
-----------------	--

NOTE

The above setting applies only to Fast Blast training.

08: System Area**System settings**

The System area is used to configure the drum module's system and also to set parameters that affect all kits and songs.

System1 Kit Lock

```
>System1
◀ KitLock=off ▶
```

①

① KitLock

By default, the drum module automatically chooses the most appropriate drum kit whenever you select a different song. Set the KitLock parameter to "on" if you would like the current kit to be retained when changing songs.

Settings	off or on
-----------------	-----------

NOTE

Regardless of the KitLock setting, you can change kits freely using the control panel.

System2 Muted Volume

```
>System2
◀DrumMuteVol= 0▶
```

①

① DrumMuteVol

Use this parameter to set the volume of the drum parts when muted with [DRUM MUTE].

Settings	0 to 10
-----------------	---------

NOTE

When DrumMuteVol is set to "0", the drum parts will be totally silent when muted.

Setting Parameters using Menu Mode

System3 Master Equalizer

```
>System3 MEQ
◀Lo=+ 2 Hi=+ 2 ▶
```



① **Lo**

The drum module features a two-band shelving equalizer as its master EQ. Use this parameter to set the equalizer's low-end gain in dB. The higher the value, the more the low end will be boosted.

Settings	0 to +12
-----------------	----------

② **Hi**

Use this parameter to set the master equalizer's high-end gain in dB. The higher the value, the more the high end will be boosted.

Settings	0 to +12
-----------------	----------

System4 Master Tuning

```
>System4 MTune
◀ Tune=+ 0 ▶
```



① **Tune**

Use this parameter to set the tuning for songs in steps of one cent.

Settings	-100 to +100
-----------------	--------------

NOTE

The above parameter has no effect on drum kit sounds.

System5 Local Control

```
>System5
◀LocalCtrl=on ▶
```



① **LocalCtrl**

Use this parameter to enable ("on") or disable ("off") playing of the internal tone generator using the pads and songs. When set to "off", the tone generator is essentially disconnected from the pads and controllers, which will be unable to generate any sound.

Settings	off or on
-----------------	-----------

System6 Metronome Output

```
>System6 Click
◀OutSel=mix ▶
```



① **OutSel**

Use this parameter to specify where metronome sounds are to be output.

Settings	Description
mix	The metronome is routed to the OUTPUT [L/MONO] and [R] jacks.
clickL	The metronome is routed to the OUTPUT [L/MONO] jack only; drum and song sounds are output in mono via the OUTPUT [R] jack.
clickR	The metronome is routed to the OUTPUT [R] jack only; drum and song sounds are output in mono via the OUTPUT [L/MONO] jack.

NOTE

The above setting also applies to output from the [PHONES] jack.

System7 Number Display Function

```
>System7 LED
◀ Disp=tempo ▶
```



① **Disp**

Use this parameter to specify what is to be shown by the number display.

Settings	Description
tempo	Current tempo
mode	Mode-specific content as follows. <ul style="list-style-type: none"> • Kit area: Kit number • Training Mode: Current tempo • Song area: Song number • Recording: Current tempo • Metronome area: Click Set number (current tempo on Tap Tempo page only) • Menu Mode: No display (trigger setup number in Trigger area only) • All other times: No display
timer	Metronome timer. Training timer when in Training Mode.

NOTE

In cases where the above parameter is not set to "tempo", the number display will show the tempo for several seconds after it is changed by one of the following actions.

- Turning the Data Dial with the [SHIFT] button held down
- Operating a pad controller whose function has been set to "tempo" (page 62)
- Striking a pad whose pad function has been set to "inc tempo", "dec tempo", or "tap tempo" (page 66)

System8 Auto Power-Off

```
>System8
└─AutoPwrOff=30 ─┘
```

①

① AutoPwrOff

Use this parameter to set the time until the Auto Power-Off function activates (page 13) or to disable (“off”) this function.

Settings	off, 5, 10, 15, 30, 60, and 120 (min)
----------	---------------------------------------

NOTE

- Settings for the Auto Power-Off function do not represent exact times and there may be some variation.
- The drum module automatically stores its system settings before turning off automatically.

System9 Restore

```
>System9
└─Restore ─┘
```

Using the Restore function as described below, you can return all User data (i.e., kits, click sets, trigger setups, and songs) to the settings they had when you last turned on the drum module.

⚠ CAUTION

When you reset parameters using the Restore function, any changes you have made to them since last turning on the drum module will be lost. Before proceeding, therefore, you should ensure that these parameters contain no irreplaceable settings.

1. Press the [SAVE/ENTER] button on the Restore page. You will be asked to confirm that you wish to proceed.

[SAVE/ENTER]

```
>System9 Restore
Are you sure?
```

To cancel the Restore process, press the [] button.

2. Press the [SAVE/ENTER] button to reset the parameters.
3. When the parameters have been successfully reset, the message “Completed.” will be displayed.
4. The drum module will automatically restart.

System10 Factory Set

```
>System10
└─Factory Set ─┘
```

Using the procedure described below, you can return all User data (i.e., kits, click sets, trigger setups, and songs) to the default settings.

⚠ CAUTION

When you reset parameters as described below, any changes you have made to them will be lost. Before proceeding, therefore, you should ensure that they contain no irreplaceable settings.

1. Press the [SAVE/ENTER] button on the Factory Set page. You will be asked to confirm that you wish to proceed.

[SAVE/ENTER]

```
>System10 FactSet
Are you sure?
```

To cancel the process without restoring default settings, press the [] button.

2. Press the [SAVE/ENTER] button to reset the parameters.

```
>System10 FactSet
Executing...
```

3. When the parameters have been successfully reset, the message “Completed.” will be displayed.

NOTE

You can also restore the Factory Set by turning on the drum module with both the [] and [] buttons held down (page 14)

4. When the Factory Set has been restored, the drum module will automatically restart and the Initial Setup page will be displayed (page 13).

Integrating Separately Sold Accessories

You can also expand your electronic drum kit with various accessories* for an even more enjoyable drumming experience. (*: Sold separately)

The following describes how to add a PCY90AT Cymbal Pad and a KU100 Kick Unit. If adding a different accessory, be sure to read the description of the Pad Type page from Menu Mode (page 68).

Adding a PCY90AT Cymbal Pad

1. Turn off the drum module.
2. Assemble the PCY90AT to your drum kit. Using the cable that came with the PCY90AT, connect it to the [PAD▶IN] jack on the KP65 Kick Pad.

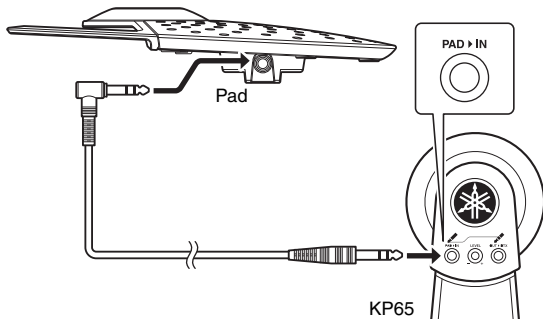

NOTE
The PCY90AT Cymbal Pad can also be connected to the [2]TOM1/[10], [3]TOM2/[11], or [4]TOM3/[12] jack. In order to do so, you will need a Y cable (sold separately). See page 11 for more details.

3. Connect the [OUT▶DTX] jack on the KP65 to the [7]KICK/[8] trigger input jack on the drum module.

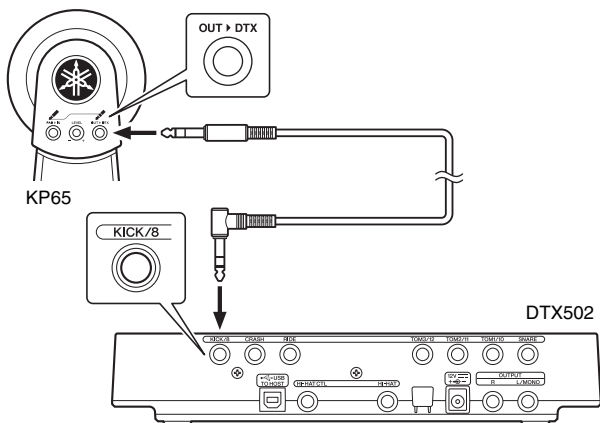

4. Turn on the drum module.
5. Choose the correct pad type for the PCY90AT.
For details on how to do so, see the description of the Pad Type page from Menu Mode (page 68). Specifically, you should set “Pad8” as the trigger input and set the Pad Type parameter to “PCY90”.

Using a KU100 Kick Unit as a Kick Pedal

By connecting a KU100 Kick Unit as described below, you can add a compact, quiet-type kick pedal to your electronic drum kit.

1. Turn off the drum module.
2. Plug one end of the cable that came with the KU100 into its [OUTPUT] jack.

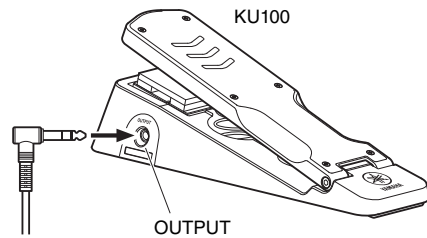

3. Plug the other end of the cable into the drum module's [7]KICK/[8] trigger input jack.

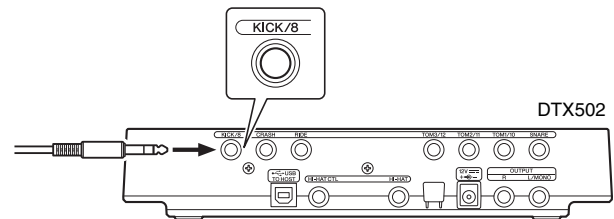

4. Turn on the drum module.
5. Choose the correct pad type for the KU100.
For details on how to do so, see the description of the Pad Type page from Menu Mode (page 68). Specifically, you should set “Kick” as the trigger input and set the Pad Type parameter to “KU100”.

Integrating Electronic & Acoustic Drums

The following describes a couple of examples of how you can integrate electronic and acoustic drums.

Adding Drum Pads to an Acoustic Drum Set

By attaching a CSAT924A Cymbal Stand Attachment and a drum holder to the cymbal stand from an acoustic drum kit, you can easily add an electronic drum pad such as the TP70, XP70, or XP80 to that kit. The following diagram shows a typical example of how the various components can be set up. When assembled, remember to set the Pad Type parameter (page 68) to match the drum pad being used.

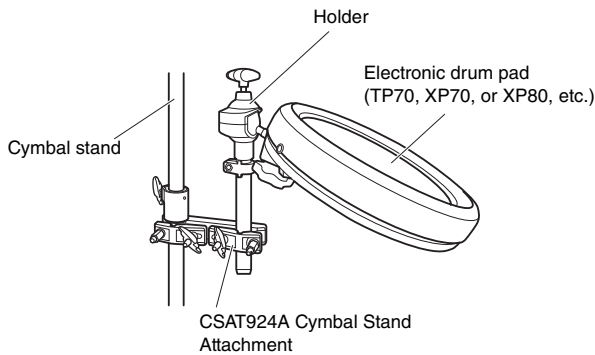

• Typical setup

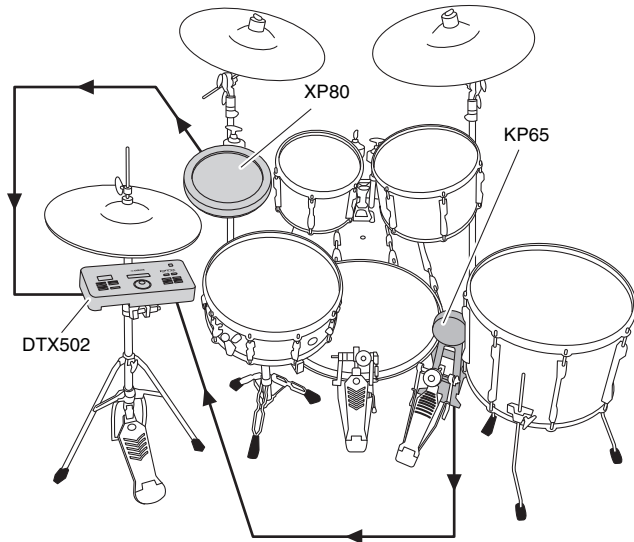

Playing the DTX502 Using Acoustic Drums

You can attach a DT10 or DT20 Drum Trigger to the head or shell of an acoustic drum to send a trigger signal to your drum module whenever the drum is struck.

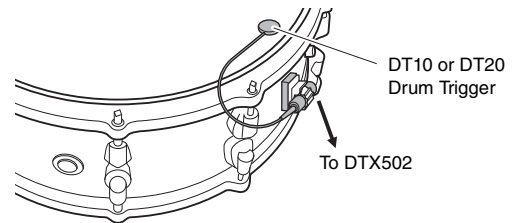

• Typical setup

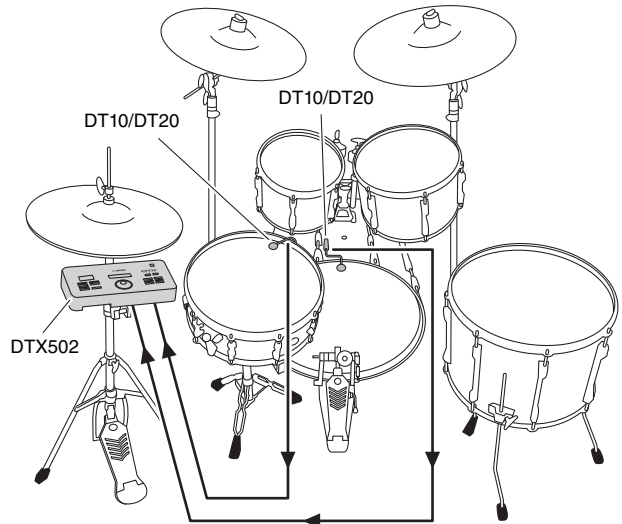

If connecting an acoustic drum via a DT10 or DT20 Drum Trigger in this way, choose the appropriate DT10/DT20 setting for the Pad Type parameter. See page 68 for more details.

NOTE

- If you wish to play User Waves, refer to the Reference Manual (page 79).
- If the acoustic drum produces multiple sounds when hit, adjust the settings of the Minimum Level parameter (page 68), the Reject Time parameter (page 69), and the Noise Filter parameter (page 69).
- If the sensitivity of the drum trigger seems to be low, adjust the settings of the Gain parameter (page 68) and the Wait Time parameter (page 69).

Mounting the DTX502 on a Hi-Hat Stand

The drum module can be conveniently mounted on a hi-hat stand using a CSAT924A Cymbal Stand Attachment. The following diagram shows a typical example of how the various components can be set up.

• Typical setup

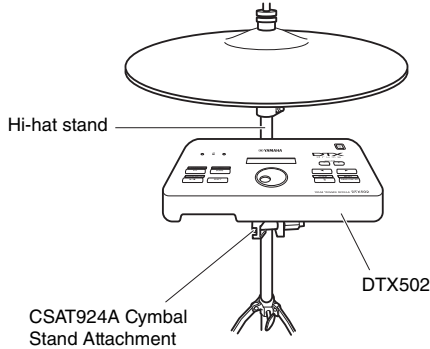
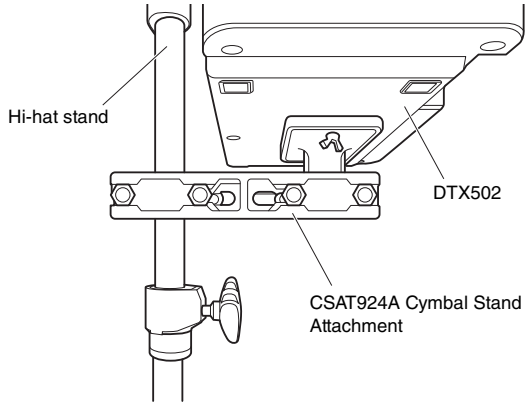

Connecting to a Computer

Making Connections

While your DTX502 is highly powerful and versatile all by itself, you can connect it to a computer via USB for even greater convenience and flexibility. When connected in this way, MIDI and audio-file data can be freely exchanged with the computer, allowing the drum module to be used as an input device for music production applications. In this section, you'll learn how to make the necessary connections.

NOTE

As the drum module has no built-in speakers, you will need to connect headphones or loudspeakers in order to hear it. For details, see page 12.

1. Turn off the drum module.
2. Start up your computer.
Shut down all applications before proceeding to the next step.
3. Connect a USB cable first to the drum module's [USB TO HOST] terminal and then to the computer.

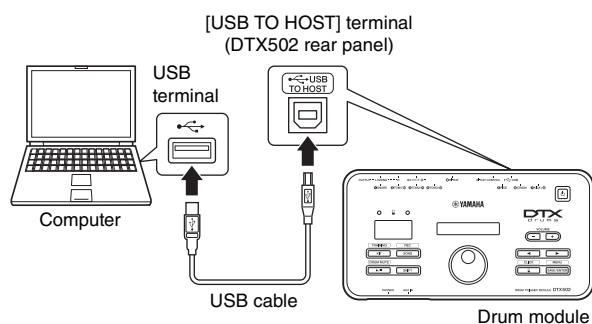

4. Turn on the drum module.
You will now be able to exchange data between the drum module and computer.

Yamaha USB-MIDI driver

In most situations, there is no need to install the Yamaha USB-MIDI driver and the above setup procedure will suffice. If, however, your computer is having difficulty communicating with the drum module, please download the standard Yamaha USB-MIDI driver from the following web page and install it on your computer.

<http://download.yamaha.com/>

NOTE

- Information on system requirements is also provided on the above web page.
- The USB-MIDI driver may be revised and updated without prior notice. Before installing, please visit the above web page to confirm that you have the most up-to-date version.

Precautions when using the [USB TO HOST] terminal

If proper care is not taken when connecting your drum module to a computer via the [USB TO HOST] terminal, either or both of the devices may freeze or data may become corrupted or be permanently lost. Be sure, therefore, to observe the following precautions at this time. If the drum module or computer should freeze, restart the application being used, reboot the computer, or turn the drum module off once and then back on.

NOTICE

- Use a USB A-B cable of less than 3 meters in length. Do not use a USB 3.0 cable.
- Before connecting to a computer via the [USB TO HOST] terminal, restore it from any power-saving mode (such as Suspend, Sleep, or Standby).
- Connect your computer via the [USB TO HOST] terminal before turning on the drum module.
- Be sure to always perform the following steps before turning the drum module on or off and either plugging in or unplugging a USB cable.
 - Shut down all applications.
 - Ensure that no data is being sent from the drum module. (Data is transmitted by striking the pads and by playing songs.)
- Always wait for at least six seconds between turning the drum module on and off and between plugging in and unplugging a USB cable.

DTX502 Reference Manual

The Reference Manual for the DTX502 is made available as a PDF document and contains the following.

- Instructions on how to transfer song and audio data from your computer to the drum module.
- Reference material that will prove useful when making music using the drum module and a computer
- MIDI-related reference information

The Reference Manual is available for download as a PDF file from the following web page.

<http://download.yamaha.com/>

*: Yamaha Corporation reserves the right to modify this URL at any time without prior notice.

Error Messages

<p>Memory full.</p>	<p>No memory is available for User songs. Please delete unneeded User songs before recording.</p>
<p>Seq data is not empty.</p>	<p>Recording was carried out with a Preset song selected, but no memory is available for User songs.</p>
<p>Backup error!</p>	<ul style="list-style-type: none">• User data could not be stored when the drum module was turned off.• After displaying this error message, the Factory Set will be automatically restored.

Troubleshooting

In addition to the following, you can also find troubleshooting tips in the Reference Manual (PDF). See page 79 for details on downloading this manual.

No sound is produced when a pad is struck or the volume is lower than expected.

■ Check connections as follows.

- Ensure that the pads are properly connected to the drum module's trigger input jacks.
- Ensure that the drum module is properly connected to headphones or other audio equipment, such as an amplifier and/or speakers.
- Ensure that the amplifier and/or speakers connected to the drum module are turned on and are not set to the lowest possible volume.
- If you are using a KP65 Kick Pad, try adjusting its Level dial.
- Ensure that the cables you are using are in good condition.

■ Check the drum module's settings as follows.

- Ensure that volumes are set appropriately. (See pages 15, 19, 24, and 59.)
- Ensure that the voice for the pad you are striking is not set to "No Assign". No sound is produced with this setting. (See pages 21 and 59.)
- Ensure that the parameter on the Decay page (KitV6) from Menu Mode is set appropriately. (See page 59.)
- Ensure that the parameter on the Cutoff Frequency page (KitV7) from Menu Mode is set appropriately. (See page 59.)
- Ensure that the parameter on the Pad Function page (Pad3) from Menu Mode is set appropriately. (See page 66.)
- Ensure that the parameter on the Velocity Curve page (TRG2) from Menu Mode is set appropriately. (See page 67.)
- Ensure that the parameter on the Pad Type page (TRG3) from Menu Mode is set appropriately. (See page 68.)
- Ensure that the parameter on the Gain page (TRG4) from Menu Mode is set appropriately. (See page 68.)
- Ensure that the parameter on the Minimum Level page (TRG5) from Menu Mode is set appropriately. (See page 68.)
- Ensure that the parameter on the Crosstalk page (TRG10) from Menu Mode is set appropriately. (See page 70.)
- Ensure that the parameter on the Local Control page (System5) from Menu Mode is set appropriately. (See page 74.)

■ If you cannot play foot closed hi-hat sounds, try the following.

- Ensure that you are operating the hi-hat controller in a firm and full manner.
- Ensure that the parameter on the Double Bass Switch page (KitC1) from Menu Mode is set to "off". (See page 61.)
- Lower the setting of the parameter on the Foot Close Position page (Pad2) from Menu Mode. (See page 65.)

■ If edge and cup sounds cannot be played or the choking technique does not work when using a cymbal pad, try the following.

- Ensure that the parameter on the Pad Type page (TRG3) from Menu Mode is set appropriately. (See page 68.)
- If using a PCY100 Cymbal Pad as the hi-hat, ensure that the cup switch (CUP SW) on the rear of the pad is set to the ON position in order to play cup sounds. (See page 17.)

Sounds or volumes are not as expected.

■ If hi-hat splash sounds are not produced as expected, try the following.

- Adjust the parameter setting on the Hi-hat Hi-hat Splash Sensitivity page (Pad1) from Menu Mode. (See page 65.)

■ If it is difficult to produce closed hi-hat sounds, try the following.

- Adjust the parameter setting on the Foot Close Position page (Pad2) from Menu Mode. (See page 65.)

■ If it is difficult to produce quieter hi-hat sounds, try the following.

- Check whether the parameter on the Double Bass Switch page (KitC1) is set to "on". In certain cases, this setting can make it more difficult to produce quieter hi-hat sounds. (See page 61.)

■ If sounds cannot be produced as expected when playing the pads connected to the [2TOM1/10], [6TOM2/11], [4TOM3/12], and/or [7KICK/8] trigger input jack, try the following.

- Check whether you have connected a two- or three-zone pad to the jack in question. In certain situations, this can result in unexpected sounds being produced. If this is the case, set the parameter on the Pad Type page (TRG3) from Menu Mode to "off". (See page 68.)

■ If sounds are distorted, try the following.

- Lower the drum module's master volume. (See page 15.)

■ If voices play endlessly and do not stop, try the following.

- Press the [KIT] button several times to silence all voices.

■ If pads are producing only sounds at very high volumes (i.e., high velocities), try the following.

- Adjust the sensitivity of the drum module's kits. (See page 19.)
- Adjust the parameter on the Velocity Curve page (TRG2) from Menu Mode. (See page 67.)
- Adjust the parameter on the Gain page (TRG4) from Menu Mode. High settings will result in loud drum sounds. (See page 68.)
- Ensure that you are using only the recommended Yamaha pads. (Products from other manufacturers can output excessively large signals.)

■ If the volumes of sounds produced by different pads are poorly balanced, try the following.

- Adjust the volumes of the various input groups on the Mixer page (MIXER) from Menu Mode. (See page 57.)
- Adjust the volumes of individual input sources on the Volume page (KitV3) from Menu Mode. (See page 59.)

■ If reverb cannot be applied, try the following.

- Ensure that the reverb level on the Mixer page (MIXER) from Menu Mode is not set too low. (See page 57.)
- Ensure that the parameter on the Reverb Send (Source) page (KitV11) from Menu Mode is set appropriately. (See page 60.)
- Ensure that the parameter on the Reverb Send (Voices) page (KitC2) from Menu Mode is set appropriately. (See page 61.)
- Ensure that the parameter on the Reverb Type page (KitC3) from Menu Mode is set appropriately. (See page 62.)
- Ensure that the parameter on the Reverb Return page (KitC4) from Menu Mode is set appropriately. (See page 62.)

■ If the drum module's volume is not well balanced with that of the device connected to the [AUX IN] jack (such as a portable music player), try the following.

- Ensure that the volume of the connected device is set to a suitable level. (See page 12.)

■ If the volume of your drumming is not well balanced with that of a drum-module song, try the following.

- Adjust the song volume. (See page 26.)

If you notice double triggering, crosstalk, or skipped sounds (as described below), try the following.

- **Double triggering—i.e., multiple sounds are produced in response to a single strike:**
 - If the pad or drum trigger in question features a controller for adjusting output or sensitivity, turn it down.
 - Ensure that the parameter on the Gain page (TRG4) from Menu Mode is not set too high. (See page 68.)
- **Crosstalk is occurring—i.e., a sound is produced by a pad other than the one that was struck.**
 - Ensure that the parameter on the Trigger Setup page (TRG1) from Menu Mode is set appropriately. (See page 66.)
 - Ensure that the parameter on the Gain page (TRG4) from Menu Mode is set appropriately. (See page 68.)
 - Ensure that the parameter on the Minimum Level page (TRG5) from Menu Mode is set appropriately. (See page 68.)
 - Ensure that the parameter on the Reject Time page (TRG7) from Menu Mode is set appropriately. (See page 69.)
 - Ensure that the parameter on the Crosstalk page (TRG10) from Menu Mode is set appropriately. (See page 70.)
 - Ensure that the parameters on the Crosstalk Pads page (TRG11) from Menu Mode are set appropriately. (See page 70.)
 - If using a pad featuring a level adjuster, ensure that it is set appropriately.
- **Skipped sounds—i.e., a pad does not produce a sound (usually during rolls or fills):**
 - Ensure that the parameter on the Reject Time page (TRG7) from Menu Mode is set appropriately. (See page 69.)
 - Ensure that the parameter on the Crosstalk page (TRG10) from Menu Mode is set appropriately. (See page 70.)
- **If hi-hat sounds are occasionally produced even though the hi-hat controller is configured to produce a kick drum sound (i.e., Db1Bass is set to “on”), try the following.**
 - Increase the setting of the parameter on the Minimum Level page (TRG5) from Menu Mode. Note that if this setting is too high, it may become difficult to play the hi-hat. (See page 68.)
- **If only one voice is triggered when two pads are played simultaneously, try the following.**
 - Ensure that the parameter on the Trigger Setup page (TRG1) from Menu Mode is set appropriately. (See page 66.)
 - Ensure that the parameter on the Gain page (TRG4) from Menu Mode is set appropriately for the pad that does not trigger a voice. (See page 68.)
 - Ensure that the parameter on the Minimum Level page (TRG5) from Menu Mode is set appropriately for the pad that does not trigger a voice. (See page 68.)
 - Ensure that the parameter on the Crosstalk page (TRG10) from Menu Mode is set appropriately. (See page 70.)
 - Ensure that the parameters on the Crosstalk Pads page (TRG11) from Menu Mode are set appropriately. (See page 70.)
 - Ensure that both pads are not assigned to the same group on the Alternate Group page (KitV13) from Menu Mode. (See page 61.)

Optional add-on products do not operate as expected.

- **If consistent, reliable trigger signals cannot be produced using a drum trigger attached to an acoustic drum, try the following.**
 - Read the section Integrating Electronic & Acoustic Drums. (See page 77.)
 - Mute the head if it is vibrating in an irregular fashion.
 - Ensure that the drum trigger is attached in the vicinity of the rim and not near the center of the head.
 - Ensure that the drum trigger makes contact only with the drum.
- **If a pad controller does not work as expected, try the following.**
 - Ensure that you are using a pad featuring a pad controller.
 - Ensure that the parameter on the Pad Control page (KitC5) from Menu Mode is set appropriately. (See page 62.)
 - Avoid holding the rim while operating the pad controller as this can prevent it from working properly.

Other common questions

- **How do I make the drum module store its settings?**
 - The drum module automatically stores its system settings whenever you turn it off using the [] (Standby/On) button.
 - Do not turn off the drum module by unplugging the power adaptor: It will not be able to store its system settings in such a case.
 - User settings for kits, click sets, and triggers must be stored manually. (See pages 25, 37, and 56.)
- **How do I reset all of the drum module's parameters to their default settings?**
 - Use the function on the Factory Set page (System10) from Menu Mode to restore the default settings. (See page 75.)
- **How do I reset all of the drum module's parameters to the settings they had when I last turned it on?**
 - Use the function on the Restore page (System9) from Menu Mode. (See page 75.)
- **How do I stop the drum module turning off before I'm finished using it?**
 - Set the parameter on the Auto Power-Off page (System8) from Menu Mode to “off”. (See page 75.)
- **Why won't a selected song play?**
 - If the song you selected contains no data, the drum module will not be able to play it.
- **How do I stop the drum module changing the current drum kit when I select a different song?**
 - By default, your drum module always chooses the best kit for each song. To prevent it from doing so, set the parameter on the Kit Lock page (System1) from Menu Mode to “on”. (See page 73.)
- **How do I have my drum module choose the best drum kit for each song?**
 - Set the parameter on the Kit Lock page (System1) from Menu Mode to “off”. (See page 73.)
- **What should I do if I can't hear a song's drum parts?**
 - Ensure that the drum parts have not been muted. (See page 27.)
- **My training scores are strange. Why is this?**
 - Crosstalk could be triggering sounds unintentionally as you drum. See the above section Crosstalk is occurring.

Data List

■ Preset Kit List

No.	Name
1	Maple Custom
2	Modern Rock
3	Elect Dub1
4	Bop Kit
5	Vintage 50s
6	Funk Kit
7	Trance PWR
8	Big Kit
9	Metal Kit
10	Percs Master
11	Oak Custom
12	Birch Custom
13	Beech Custom
14	Vintage 70s
15	Garage Punk
16	Hard Rock
17	Legend RX
18	Funk Master
19	70s NY
20	Jazz Kit
21	Acid Jazz
22	Deep Brush
23	Reggae Kit
24	Elect Dub2
25	Weapon X Dub
26	Electro Pop
27	Gate Kit
28	Digi Rock
29	DNB
30	Chill Out
31	Izzle's R&B1
32	Izzle's R&B2
33	ButiqHipHop1
34	ButiqHipHop2
35	Hexagon
36	Beat Box8
37	Beat Box9
38	MG Kit
39	Deep Kit
40	Vocal Drums
41	Drum Corps
42	Orchestra
43	Cuban
44	Brazil
45	Africa
46	Arabic
47	Indian Pop
48	China
49	Japan
50	GM Kit

■ Song List

No.	Type	Name
1	Demo	Demo
2		Rock Mix
3		FunkRock
4		SkatePnk
5		HardRock
6		HvyMetal
7		5/4PrgRk
8		RckShfle
9		ClsShfle
10		80sShfle
11		8beatFnk
12		R&B Funk
13		CoolFunk
14		MedBlues
15		SlwBlues
16		HipHop 1
17		HipHop 2
18		R&B 1
19		R&B 2
20	Practice	ModnSoul
21		ElecDub1
22		ElecDub2
23		ElecDub3
24		ElecPop
25		Dance
26		TrncePWR
27		Soul Pop
28		6/8 Pop
29		8beatPop
30		16beatRk
31		ModnBald
32		PowerBld
33		MedSwing
34		FstSwing
35		Bossa
36		LatinSmb
37		Songo
38		Reggae
39		Funk C
40		Funk F
41		FunkOrgn
42		Dance 1
43		Dance 2
44		Dance 3
45		DanceSeq
46		ChilOut1
47		ChilOut2
48		ChilOut3
49	Pad Song	DigiRck1
50		DigiRck2
51		DigiRck3
52		RollFill
53		TrancSeq
54		Bongo
55		Conga 1
56		Conga 2
57		Shaker
58		Tambrin
59		Triangle
60		Samba

■ Instrument Name List

● Kick

No.	Name
0	No Assign
1	MapleC 22
2	OakC 22-1
3	OakC 22-2
4	BirchC 22
5	BeechC 22
6	Rock
7	Metal
8	HardRock
9	Vtg70s 24
10	Vtg70s24Mt
11	Vtg50s 22
12	Vtg50s22Mt
13	Jazz
14	RX5
15	T8-1
16	T8-2
17	T8 Down
18	T9-1
19	T9-2
20	T9 Hard
21	Sm
22	ElecComp
23	Trance PWR
24	Gate 1
25	Gate 2
26	Electric 1
27	Electric 2
28	Electric 3
29	Electric 4
30	Electric 5
31	Electric 6
32	Electric 7
33	Electric 8
34	R&B 1
35	R&B 2
36	R&B 3
37	HipHop 1
38	HipHop 2
39	HipHop 3
40	HipHop 4
41	HipHop 5
42	HipHop 6
43	HipHop 7
44	HipHop 8
45	Break 1
46	Break 2
47	DNB 1
48	DNB 2

● Snare

No.	Name
0	No Assign
1	MapleCustm
2	OakCustom
3	BirchCustm
4	BeechCustm
5	Rock
6	Metal
7	HardRock
8	Vintage70s
9	Vintage50s
10	Funk
11	DeepOak
12	Jazz
13	Deep Brush
14	RX
15	T8
16	T9
17	Sm
18	Synth
19	Analog
20	MG Snare
21	TrancePWR1
22	TrancePWR2
23	Gate 1
24	Gate 2
25	Gate 3
26	Gate 4
27	Gate 5
28	Gate 6
29	Gate 7
30	Gate 8
31	Electro 1
32	Electro 2
33	Electro 3
34	Electro 4
35	Electro 5
36	Electro 6
37	Electro 7
38	Electro 8
39	Electro 9
40	Electro 10
41	R&B 1
42	R&B 2
43	R&B 3
44	HipHop
45	Break 1
46	Break 2
47	DNB

Data List

● Tom

No.	Name
0	No Assign
1	MapleC H
2	MapleC M
3	MapleC L
4	OakC H
5	OakC M
6	OakC L
7	BirchC H
8	BirchC M
9	BirchC L
10	BeechC H
11	BeechC M
12	BeechC L
13	Rock H
14	Rock M
15	Rock L
16	Metal H
17	Metal M
18	Metal L
19	HardRock H
20	HardRock M
21	HardRock L
22	Vintg70s H
23	Vintg70s M
24	Vintg70s L
25	Vintg50s H
26	Vintg50s M
27	Vintg50s L
28	Jazz H
29	Jazz M
30	Jazz L
31	Brush H
32	Brush M
33	Brush L
34	Marching H
35	Marching M
36	Marching L
37	RX5 H
38	RX5 M
39	RX5 L
40	T8-1 H
41	T8-1 M
42	T8-1 L
43	T8-2 H
44	T8-2 M
45	T8-2 L
46	T9 H
47	T9 M
48	T9 L
49	Sm H
50	Sm M
51	Sm L
52	Synth H
53	Synth M
54	Synth L
55	Big H
56	Big M
57	Big L
58	Gate 1 H
59	Gate 1 M
60	Gate 1 L
61	Gate 2 H
62	Gate 2 M
63	Gate 2 L
64	Gate 3 H
65	Gate 3 M
66	Gate 3 L
67	Noise H
68	Noise M
69	Noise L
70	Electric 1
71	Electric 2
72	Electric 3
73	Amb Tom
74	DNB H
75	DNB M
76	DNB L

● Cymbal

No.	Name
0	No Assign
1	Bright 18
2	Warm 16
3	Dark 18-1
4	Dark 18-2
5	Vivid 17
6	Thin 16
7	Vintage 18
8	Vintage 16
9	Jazz 18
10	Bright 20
11	WarmRd 20
12	Dark 20-1
13	Dark 20-2
14	VtgRd 22
15	JazzRd 22
16	SzRide 20
17	Bright 18R
18	China 19
19	China 17
20	Splash 1
21	Splash 2
22	Trash
23	RX Cymbal
24	RX Ride
25	T8 Crash
26	T9 Crash
27	T8 Ride
28	T9 Ride
29	MG Ride
30	SynCrash 1
31	SynCrash 2
32	ElecCym 1
33	ElecCym 2
34	ElecCym 3
35	ElecCym 4
36	ElecCym 5
37	ElecCym 6
38	ElecCym 7
39	ElecCym 8
40	ElecRide 1
41	ElecRide 2
42	ElecRide 3
43	ElecRide 4
44	HipHopCr 1
45	HipHopCr 2
46	HipHopCr 3
47	HipHopCr 4
48	HipHopCr 5
49	HipHopRd
50	Lo-Fi Cym
51	NoiseCym 1
52	NoiseCym 2
53	NoiseCym 3
54	RevCym 1
55	RevCym 2
56	Vo China
57	Vo Ride

● Hi-Hat

No.	Name
0	No Assign
1	Bright 14
2	Dark 14-1
3	Dark 14-2
4	Cool 14
5	Vintage 14
6	Jazz 14
7	Brush
8	RX
9	T8
10	T9
11	Electro 1
12	Electro 2
13	Electro 3
14	Dubstep
15	R&B 1
16	R&B 2
17	R&B 3
18	HipHop 1
19	HipHop 2
20	ChillOut
21	DNB
22	Vo HH

● Percussion

No.	Name
0	No Assign
1	Conga H SW
2	Conga L SW
3	Bongo H SW
4	Bongo L SW
5	Timbales H
6	Timbales L
7	Surdo SW
8	PndeiroOp
9	PndeiroTap
10	PndeiroShk
11	PndeiroSld
12	Tamarin 1
13	Tamarin 2
14	Cowbell1SW
15	Cowbell 2
16	Cowbell 3
17	Claves
18	Maracas
19	TriangleOp
20	TriangleMt
21	GuiroShort
22	GuiroLong
23	Agogo H
24	Agogo L
25	WoodBlockH
26	WoodBlockL
27	Shaker 1
28	Shaker 2
29	Caxixi Hit
30	Whistle S
31	Whistle L
32	Djambe Lo
33	Djambe Op
34	Djambe Slp
35	Djambe Mt
36	Cajion Lo
37	Cajion Ft
38	Cajion Slp
39	Cajion Mt
40	TalkDr Op
41	PotDrum Op
42	Dundun Op
43	Dundun Cl
44	Darbuka Op
45	Darbuka Sl
46	Darbuka Mt
47	Sangban Op
48	Kenkeni Op
49	AfricanBlH
50	AfricanBlL
51	Tombak Op
52	Daf Open
53	Daf Slap
54	Daf Mute
55	Riq Open
56	Riq Slap
57	Riq Shake
58	Riq Hit
59	Sagat Op
60	Sagat Cl
61	Sagat SW
62	Tabla Na
63	Bayan Ge
64	Dhol RH Op
65	Dhol RH Cl
66	Dhol LH Op
67	Dhol LH Cl
68	KanjiraHit
69	KanjiraSlp
70	KanjiraShk

No.	Name
71	ZangGu
72	ZangGu Rim
73	BianGu
74	BianGu Rim
75	BianGuHand
76	TangGu
77	TangGu Rim
78	PaiGu 1
79	PaiGu 2
80	PaiGu 3
81	XiaoBo Opn
82	XiaoBo Cls
83	DaBo Opn
84	DaBo Cls
85	XiaoLuo
86	ZhongLuo
87	FengLuo
88	ShangNao 1
89	ShangNao 2
90	Qing H
91	Qing L
92	Taiko Don
93	Taiko Ka
94	KoTaik1Ten
95	KoTaik1Tsu
96	KoTaik2Ten
97	KoTaik2Tsu
98	TsuzumiPon
99	TsuzumiBnd
100	OokawaChon
101	Temple Blk
102	KontikiKon
103	Kontiki Ki
104	Atari Kon
105	Atari Chi
106	Ainote 1
107	Ainote 2
108	GranCasaOp
109	Field Sn
110	FldSn OpRm
111	FldSn ClRm
112	OrchSn
113	OrchSnOpRm
114	OrchSnClRm
115	OrTambHtOp
116	OrTambHtCl
117	OrTambHtSk
118	Castanet
119	Vibraslap
120	SleighBel
121	WindChime
122	HandCym Op
123	HandCym Mt
124	FingrCymOp
125	RibonCrash
126	Timpani
127	Tamtam

■ Voice List

● Effect

No.	Name
0	No Assign
1	ElecPerc 1
2	ElecPerc 2
3	ElecPerc 3
4	ElecPerc 4
5	ElecPerc 5
6	ElecPerc 6
7	ElecPerc 7
8	ElecPerc 8
9	ElecPerc 9
10	ElecPerc10
11	ElecPerc11
12	ElecPerc12
13	ElecPerc13
14	ElecPerc14
15	ElecPerc15
16	ElecPerc16
17	ElecPerc17
18	ElecPerc18
19	ElecPerc19
20	ElecPerc20
21	ElecPerc21
22	ElecPerc22
23	ElecPerc23
24	ElecPerc24
25	An Cowbell
26	An Claves
27	An Shaker
28	ElcClaves1
29	ElcClaves2
30	ElecShaker
31	HiQ
32	Zap
33	NLZap
34	SynPerc
35	ClickDelay
36	An Clap
37	T9 Clap
38	HandClap
39	HHopClap 1
40	HHopClap 2
41	HHopClap 3
42	HHopClap 4
43	HHopClap 5
44	HHopClap 6
45	HHopClap 7
46	HHopClap 8
47	HHopClap 9
48	HHopClap10
49	HHopClap11
50	HHopClap12
51	HHopSnap 1
52	HHopSnap 2
53	HHopSnap 3
54	HipHop FX
55	XfdSnare 1
56	XfdSnare 2
57	XfdSnare 3
58	MG Kick 1
59	MG Kick 2
60	MG Kick 3
61	MG Kick 4
62	MG Kick 5
63	MG Kick 6
64	MG Snare 1
65	MG Snare 2
66	MG FX 1
67	MG FX 2
68	Synth 1
69	Synth 2
70	Synth 3
71	Vo Kick
72	Vo Snare
73	Vo SnOp
74	Vo SnClR
75	Vo Tom H
76	Vo Tom M
77	Vo Tom L

No.	Name
78	Vo HH Op
79	Vo HH OpE
80	Vo HH Cl
81	Vo HH ClE
82	Vo HH Ft
83	Vo HH Sp
84	Vo Ride
85	Vo China
86	Vo Cowbell
87	Vo Clap
88	Lazer 1
89	Lazer 2
90	Noise 1
91	Noise 2
92	WhiteNoise
93	Raspberry
94	SE 1
95	SE 2
96	SE 3
97	SE 4
98	SE 5
99	SE 6
100	SE 7
101	SE 8
102	Uh
103	Hey
104	One
105	Two
106	Three
107	Four
108	Clk 1 Acc
109	Clk 1 4th
110	Clk 1 8th
111	Clk 1 16th
112	Clk 1 Trp
113	Clk 2 Acc
114	Clk 2 Beat
115	Clk 3 Acc
116	Clk 3 Beat
117	Clk 4 Acc
118	Clk 4 Beat

● Kick

No.	Name
0	No Assign
1	MapleC 22
2	OakC 22-1
3	OakC 22-2
4	BirchC 22
5	BeechC 22
6	Rock
7	Metal
8	HardRock
9	Vtg70s 24
10	Vtg70s24Mt
11	Vtg50s 22
12	Vtg50s22Mt
13	Jazz
14	RX5
15	T8-1
16	T8-2
17	T8 Down
18	T9-1
19	T9-2
20	T9 Hard
21	Sm
22	ElecComp
23	Trance PWR
24	Gate 1
25	Gate 2
26	Electric 1
27	Electric 2
28	Electric 3
29	Electric 4
30	Electric 5
31	Electric 6
32	Electric 7
33	Electric 8
34	R&B 1
35	R&B 2
36	R&B 3
37	HipHop 1
38	HipHop 2
39	HipHop 3
40	HipHop 4
41	HipHop 5
42	HipHop 6
43	HipHop 7
44	HipHop 8
45	Break 1
46	Break 2
47	DNB 1
48	DNB 2

● Snare

No.	Name
0	No Assign
1	MapleCustm
2	MapleCOpRm
3	MapleCCIRm
4	MapleCOff
5	MapleCOpOf
6	MapleCCIOf
7	OakCustom
8	OakC OpRm
9	OakC ClRm
10	OakC Off
11	OakC OpOf
12	OakC ClOf
13	BirchCustm
14	BirchCOpRm
15	BirchCCIRm
16	BirchC Off
17	BirchCOpOf
18	BirchCCIOf
19	BeechCustm
20	BeechCOpRm
21	BeechCCIRm
22	BeechC Off
23	BeechCOpOf
24	BeechCCIOf
25	Rock
26	Rock OpRm
27	Rock ClRm
28	Rock Off
29	Rock OpOf
30	Rock ClOf
31	Metal
32	Metal OpRm
33	Metal ClRm
34	Metal Off
35	Metal OpOf
36	Metal ClOf
37	HardRock
38	HRock OpRm
39	HRock ClRm
40	HRock Off
41	HRock OpOf
42	HRock ClOf
43	Vintage70s
44	Vtg70sOpRm
45	Vtg70sClRm
46	Vtg70s Off
47	Vtg70sOpOf
48	Vtg70sClOf
49	Vintage50s
50	Vtg50sOpRm
51	Vtg50sClRm
52	Vtg50s Off
53	Vtg50sOpOf
54	Vtg50sClOf
55	Funk
56	Funk OpRm
57	Funk ClRm
58	Funk Off
59	Funk OpOf
60	Funk ClOf
61	DeepOak
62	DpOak OpRm
63	DpOak ClRm
64	DpOak Off
65	DpOak OpOf
66	DpOak ClOf
67	Jazz
68	Jazz OpRm
69	Jazz ClRm
70	Jazz Off
71	Jazz OpOf
72	Jazz ClOf
73	Brush
74	Brush OpRm
75	Amb Rim

No.	Name
76	RX11-1
77	RX11-2
78	RX5-1
79	RX5-2
80	RX11 Rim
81	RX5 Rim
82	T8-1
83	T8-2
84	T9-1
85	T9-2
86	T8 Rim
87	T9 Rim
88	Sm
89	Synth
90	Analog
91	Analog Rim
92	TrancePWR1
93	TrancePWR2
94	Gate 1
95	Gate 2
96	Gate 3
97	Gate 4
98	Gate 5
99	Gate 6
100	Gate 7
101	Gate 8
102	Gate Rim
103	Electro 1
104	Electro 2
105	Electro 3
106	Electro 4
107	Electro 5
108	Electro 6
109	Electro 7
110	Electro 8
111	Electro 9
112	Electro 10
113	ElectroRim
114	R&B 1
115	R&B 2
116	R&B 3
117	R&B 1 Rim
118	R&B 2 Rim
119	R&B 3 Rim
120	HipHop
121	Break 1
122	Break 2
123	Break Rim
124	DNB 1
125	DNB 2
126	DNB 3

Data List

● Tom

No.	Name
0	No Assign
1	MapleC H
2	MapleC M
3	MapleC L
4	OakC H
5	OakC M
6	OakC L
7	BirchC H
8	BirchC M
9	BirchC L
10	BeechC H
11	BeechC M
12	BeechC L
13	Rock H
14	Rock M
15	Rock L
16	Metal H
17	Metal M
18	Metal L
19	HardRock H
20	HardRock M
21	HardRock L
22	Vintg70s H
23	Vintg70s M
24	Vintg70s L
25	Vintg50s H
26	Vintg50s M
27	Vintg50s L
28	Jazz H
29	Jazz M
30	Jazz L
31	Brush H
32	Brush M
33	Brush L
34	Marching H
35	Marching M
36	Marching L
37	RX5 H
38	RX5 M
39	RX5 L
40	T8-1 H
41	T8-1 M
42	T8-1 L
43	T8-2 H
44	T8-2 M
45	T8-2 L
46	T9 H
47	T9 M
48	T9 L
49	Sm H
50	Sm M
51	Sm L
52	Synth H
53	Synth M
54	Synth L
55	Big H
56	Big M
57	Big L
58	Gate 1 H
59	Gate 1 M
60	Gate 1 L
61	Gate 2 H
62	Gate 2 M
63	Gate 2 L
64	Gate 3 H
65	Gate 3 M
66	Gate 3 L
67	Noise H
68	Noise M
69	Noise L
70	Electric 1
71	Electric 2
72	Electric 3
73	Amb Tom
74	DNB H
75	DNB M
76	DNB L

● Cymbal

No.	Name
0	No Assign
1	Bright18
2	Bright18Eg
3	Bright18Cp
4	Warm 16
5	Warm 16Eg
6	Warm 16Cp
7	Dark18-1
8	Dark18-1Eg
9	Dark18-1Cp
10	Dark18-2
11	Dark18-2Eg
12	Dark18-2Cp
13	Vivid 17
14	Vivid 17Eg
15	Vivid 17Cp
16	Thin 16
17	Thin 16Eg
18	Thin 16Cp
19	Vintage 18
20	Vintg 18Eg
21	Vintg 18Cp
22	Vintage 16
23	Vintg 16Eg
24	Vintg 16Cp
25	Jazz 18
26	Jazz 18Eg
27	Jazz 18Cp
28	Bright20
29	Bright20Eg
30	Bright20Cp
31	WarmRd20
32	WarmRd20Eg
33	WarmRd20Cp
34	Dark20-1
35	Dark20-1Eg
36	Dark20-1Cp
37	Dark20-2
38	Dark20-2Eg
39	Dark20-2Cp
40	VtgRd 22
41	VtgRd 22Eg
42	VtgRd 22Cp
43	JazzRd22
44	JazzRd22Eg
45	JazzRd22Cp
46	SzRide 20
47	SzRd 20Eg
48	SzRd 20Cp
49	Bright18R
50	China 19
51	China 17
52	Splash 1
53	Splash 2
54	Trash
55	RX11 Crash
56	RX5 Crash
57	RX11 Ride
58	RX5 RdEg
59	RX5 RdCp
60	T8 Crash
61	T9 Crash
62	T8 Ride
63	T9 Ride
64	SynCrash 1
65	SynCrash 2
66	ElecCym 1
67	ElecCym 2
68	ElecCym 3
69	ElecCym 4
70	ElecCym 5
71	ElecCym 6
72	ElecCym 7
73	ElecCym 8

No.	Name
74	ElecRide 1
75	ElecRd 1Eg
76	ElecRd 1Cp
77	ElecRd 2Cp
78	ElecRide 3
79	ElecRide 4
80	HipHopCr 1
81	HipHopCr 2
82	HipHopCr 3
83	HipHopCr 4
84	HipHopCr 5
85	HipHopRd
86	HipHopRdCp
87	Lo-Fi Cym
88	NoiseCym 1
89	NoiseCym 2
90	NoiseCym 3
91	RevCym 1
92	RevCym 2

● Hi-Hat

No.	Name
0	No Assign
1	Bright14Op
2	Brt14OpEg
3	Brt14OpCp
4	Bright14Cl
5	Brt14ClEg
6	Brt14ClCp
7	Bright14Ft
8	Bright14Sp
9	Dark14-1Op
10	Dk14-1OpEg
11	Dk14-1OpCp
12	Dark14-1Cl
13	Dk14-1ClEg
14	Dk14-1ClCp
15	Dark14-1Ft
16	Dark14-1Sp
17	Dark14-2Op
18	Dk14-2OpEg
19	Dk14-2OpCp
20	Dark14-2Cl
21	Dk14-2ClEg
22	Dk14-2ClCp
23	Dark14-2Ft
24	Dark14-2Sp
25	Cool14 Op
26	Cool14OpEg
27	Cool14OpCp
28	Cool14 Cl
29	Cool14ClEg
30	Cool14ClCp
31	Cool14 Ft
32	Cool14 Sp
33	Vintg14 Op
34	Vtg14 OpEg
35	Vtg14 OpCp
36	Vintg14 Cl
37	Vtg14 ClEg
38	Vtg14 ClCp
39	Vintg14 Ft
40	Vintg14 Sp
41	Jazz14 Op
42	Jazz14OpEg
43	Jazz14OpCp
44	Jazz14 Cl
45	Jazz14ClEg
46	Jazz14ClCp
47	Jazz14 Ft
48	Jazz14 Sp
49	RX11 Op
50	RX5 Op
51	RX11 Cl
52	RX5 Cl
53	T8 Op
54	T8 Cl
55	T9 Op
56	T9 Cl
57	Elec1 Op
58	Elec1 OpEg
59	Elec1 Cl
60	Elec1 ClEg
61	Elec1 Ft
62	Elec1 Sp
63	Elec2 Op
64	Elec2 OpEg
65	Elec2 Cl
66	Elec2 ClEg
67	Elec2 Ft
68	Elec2 Sp
69	Elec3 Op
70	Elec3 OpEg
71	Elec3 Cl
72	Elec3 ClEg
73	Elec4 Cl

No.	Name
74	R&B1 Op
75	R&B1 Cl
76	R&B1 Ft
77	R&B1 Sp
78	R&B2 Op
79	R&B2 Ft
80	R&B3 Op
81	R&B3 Cl
82	R&B3 Ft
83	HipHop1 Op
84	HHop1 OpEg
85	HipHop1 Cl
86	HHop1 ClEg
87	HipHop1 Ft
88	HipHop2 Op
89	HipHop2 Cl
90	HHop2 ClEg
91	HipHop2 Ft
92	DNB Op
93	DNB Cl
94	DNB Ft
95	Machine 1
96	Machine 2
97	Machine 3
98	Machine 4
99	Analog 1
100	Analog 2
101	Analog 3
102	Analog 4
103	Analog 5
104	FX HiHat

● Percussion

No.	Name
0	No Assign
1	Conga H SW
2	Conga L SW
3	Bongo H SW
4	Bongo L SW
5	Timbales H
6	Timbales L
7	Surdo SW
8	PndeiroOp
9	PndeiroTap
10	PndeiroShk
11	PndeiroSld
12	Tambarin 1
13	Tambarin 2
14	Cowbell1SW
15	Cowbell 2
16	Cowbell 3
17	Claves
18	Maracas
19	TriangleOp
20	TriangleMt
21	GuiroShort
22	GuiroLong
23	Agogo H
24	Agogo L
25	WoodBlockH
26	WoodBlockL
27	Shaker 1
28	Shaker 2
29	Caxixi Hit
30	Whistle S
31	Whistle L
32	Djambé Lo
33	Djambé Op
34	Djambé Slp
35	Djambé Mt
36	Cajion Lo
37	Cajion Ft
38	Cajion Slp
39	Cajion Mt
40	TalkDr Op
41	PotDrum Op
42	Dundun Op
43	Dundun Cl
44	Darbuka Op
45	Darbuka Sl
46	Darbuka Mt
47	Sangban Op
48	Kenkeni Op
49	AfricanBIH
50	AfricanBIL
51	Tombak Op
52	Daf Open
53	Daf Slap
54	Daf Mute
55	Riq Open
56	Riq Slap
57	Riq Shake
58	Riq Hit
59	Sagat Op
60	Sagat Cl
61	Sagat SW
62	Tabla Na
63	Bayan Ge
64	Dhol RH Op
65	Dhol RH Cl
66	Dhol LH Op
67	Dhol LH Cl
68	KanjiraHit
69	KanjiraSlp
70	KanjiraShk
71	ZangGu
72	ZangGu Rim

● Effect

No.	Name
0	No Assign
1	ElecPerc 1
2	ElecPerc 2
3	ElecPerc 3
4	ElecPerc 4
5	ElecPerc 5
6	ElecPerc 6
7	ElecPerc 7
8	ElecPerc 8
9	ElecPerc 9
10	ElecPerc10
11	ElecPerc11
12	ElecPerc12
13	ElecPerc13
14	ElecPerc14
15	ElecPerc15
16	ElecPerc16
17	ElecPerc17
18	ElecPerc18
19	ElecPerc19
20	ElecPerc20
21	ElecPerc21
22	ElecPerc22
23	ElecPerc23
24	ElecPerc24
25	An Cowbell
26	An Claves
27	An Shaker
28	ElcClaves1
29	ElcClaves2
30	ElecShaker
31	HiQ
32	Zap
33	NLZap
34	SynPerc
35	ClickDelay
36	An Clap
37	T9 Clap
38	HandClap
39	HHopClap 1
40	HHopClap 2
41	HHopClap 3
42	HHopClap 4
43	HHopClap 5
44	HHopClap 6
45	HHopClap 7
46	HHopClap 8
47	HHopClap 9
48	HHopClap10
49	HHopClap11
50	HHopClap12
51	HHopSnap 1
52	HHopSnap 2
53	HHopSnap 3
54	HipHop FX
55	XfdSnare 1
56	XfdSnare 2
57	XfdSnare 3
58	MG Kick 1
59	MG Kick 2
60	MG Kick 3
61	MG Kick 4
62	MG Kick 5
63	MG Kick 6
64	MG Snare 1
65	MG Snare 2
66	MG FX 1
67	MG FX 2
68	Synth 1
69	Synth 2
70	Synth 3

No.	Name
71	Vo Kick
72	Vo Snare
73	Vo SnOp
74	Vo SnClR
75	Vo Tom H
76	Vo Tom M
77	Vo Tom L
78	Vo HH Op
79	Vo HH OpE
80	Vo HH Cl
81	Vo HH ClE
82	Vo HH Ft
83	Vo HH Sp
84	Vo Ride
85	Vo China
86	Vo Cowbell
87	Vo Clap
88	Lazer 1
89	Lazer 2
90	Noise 1
91	Noise 2
92	WhiteNoise
93	Raspberry
94	SE 1
95	SE 2
96	SE 3
97	SE 4
98	SE 5
99	SE 6
100	SE 7
101	SE 8
102	Uh
103	Hey
104	One
105	Two
106	Three
107	Four
108	Clk 1 Acc
109	Clk 1 4th
110	Clk 1 8th
111	Clk 1 16th
112	Clk 1 Trp
113	Clk 2 Acc
114	Clk 2 Beat
115	Clk 3 Acc
116	Clk 3 Beat
117	Clk 4 Acc
118	Clk 4 Beat

Specifications

Tone generator	Type	AWM2
	Maximum polyphony	32 notes
	Effect units	Reverb: 9 types Master equalizer
Kits	Quantity	Preset: 50 User: 50*
	Number of voices	Drums and percussion: 691 Keyboard: 128
Songs	Quantity	Demo songs: 1 Practice songs: 37 Pad songs: 22 User songs: 40
	Sequencer capacity	Approximately 104,000 notes*
	Note resolution	96 subdivisions per quarter note
	Recording method	Real-time recording
	Song format	SMF
Metronome	User click sets	30
	Tempo	30 to 300 BPM; tap tempo supported
	Time signatures	1/4 to 16/4, 1/8 to 16/8, and 1/16 to 16/16
	Subdivisions	Accents, quarter notes, eighth notes, sixteenth notes, and eight-note triplets
Training	Options	8
Triggers	Trigger setups	Preset: 14 User: 16
Audio files	Import limit	20 files*
	Bit depth	16 bits
	Sampling format	WAV or AIFF
Other items	Display elements	Backlit LCD with 2 rows of 16 characters; 3-digit, 7-segment LED; 2 LEDs for tempo display
	Connectors	<ul style="list-style-type: none"> • Trigger inputs 1, 5, 6, and 9: Standard stereo-phone jacks (L: Trigger, R: Rim switch) • Trigger inputs 2, 3, 4, and 7: Standard stereo-phone jacks (L: Trigger, R: Trigger) • [HI-HAT CONTROL]: Standard stereo-phone jack • OUTPUT [L/MONO] and [R]: Standard phone jacks • [PHONES]: Standard stereo-phone jack • [AUX IN]: Mini stereo-phone jack • [USB TO HOST] • DC IN
	Power consumption	4 W
	Dimensions	251 (w) × 130 (d) × 48 (h) mm
	Weight	610 g
	Package contents	Power adaptor (PA-130 or equivalent Yamaha-approved product), Owner's Manual (this document), module holder, and module holder screws (x2)

*: Total memory capacity of 1 MB.

Specifications and descriptions in this owner's manual are for information purposes only. Yamaha Corporation reserves the right to modify products or specifications at any time without prior notice. Since specifications, equipment, and options may not be the same in every locale, please check with your Yamaha dealer.

Index

Symbols

[12V \equiv + \ominus -] connector	11
[\downarrow] button	11
[\blacktriangleleft / \blacktriangleright] buttons	10
[\blacktriangleright / \blacksquare] button	10
[⏻] (Standby/On) button	10
[AUX IN] jack	11
[HI-HAT CONTROL] jack	11
[KIT] button	10
OUTPUT [L/MONO] and [R] jacks	11
[PHONES] jack	11
[SAVE/ENTER] button	11
[SHIFT] button	10
[SONG] button	10
[USB TO HOST] terminal	11, 79
VOLUME [+] and [-] buttons	10

A

Acoustic Drums	77
Alternate Group	61
Auto Power-Off	75
Auto Power-Off time	13

B

Bell shots	18
Bow shots	17, 18

C

Change Up	44
Choking	18
Clear User Kit	65
Click Set	32, 37
Closed sounds	17
Computer	79
Control Panel	10
Copy Pad	64
Copy Trigger	71
Cord clip	11
Count-In	28
Crosstalk	70
Crosstalk Pads	70
CSAT924A	77, 78
Cup shots	17
Cutoff Frequency	59
Cymbal Sizes	22
Cymbals	18

D

Data Dial	10
Decay	59
Default Settings	14
Deleting	54
Difficulty Level	72
Double Bass Switch	61
DT10/DT20	77

E

Edge shots	17, 18
------------------	--------

F

Factory Set	75
Fast Blast	49
Fast Blast Timer	73
Foot Close Position	65
Foot-close sounds	17

G

Gain	68
Groove Check	38

H

Headphones	12
Hi-hat Splash Sensitivity	65
Hi-hat splash sounds	17
Hold Mode	61

I

Ignore Timing	72
Initial Setup	13
Input Sources	29
Instrument	20
Instrument Volumes	19

K

Kit	19, 20
Kit Lock	73
KU100	76

L

Layers	57
LCD screen	10
Looping a Song	28

M

Master Equalizer	74
Master Tuning	74
Measure Break	41
Menu Mode	55
Metronome	31
Metronome lights	10
Metronome Output	74
MIDI Channel	60
MIDI Control Change	63
MIDI Gate Time	60
MIDI Note Number	60
MIDI Program Change	63
Minimum Level	68
Minimum Velocity	69
Mixer settings	57
Music Player	12
Muted Volume	73
Muting	18, 27

N

Noise Filter	69
Number display	10
Number Display Function	74

O

Open sounds	17
-------------------	----

P

Pad Control	62
Pad Function	66
Pad Gate	46
Pad Gate Group	72
Pad set	7
Pad Songs	29
Pad Type	68
Part Mute	47
PCY90AT	76
PDF	6

Play mode	30
Power adaptor	12
Practice songs	26

Q

Quantize	52
----------------	----

R

Rear Panel	11
Recording	51
Reference Manual	79
Reject Time	69
Repeat Mode	30
Restore	75
Reverb Return	62
Reverb Send (Source)	60
Reverb Send (Voices)	61
Reverb Type	62
Rhythm Gate	40

S

Sensitivity	19
Separately Sold Accessories	76
Snare	16
Snare Adjustment	62
Song	26
Speakers	12
Stereo Panning	24, 59
Storing your settings	56

T

Tapping the Tempo	36
Tempo	62
Tempo Up/Down	42
Timer	72
Training Mode	38
Trigger input jacks	11
Trigger Setup	13, 66
Trigger Setup Link	63
Tuning	22, 59

U

USB	79
USB-MIDI driver	79
User kits	25
User songs	51

V

Velocity Curve	67
Voice	20, 58
Volume	15, 59

W

Wait Time	69
Wave Voice	21

Y

Y-cable	11
---------------	----

Important Notice: Guarantee Information for customers in European Economic Area (EEA) and Switzerland

Important Notice: Guarantee Information for customers in EEA* and Switzerland For detailed guarantee information about this Yamaha product, and Pan-EEA* and Switzerland warranty service, please either visit the website address below (Printable file is available at our website) or contact the Yamaha representative office for your country. * EEA: European Economic Area	English
Wichtiger Hinweis: Garantie-Information für Kunden in der EWR* und der Schweiz Für nähere Garantie-Information über dieses Produkt von Yamaha, sowie über den Pan-EWR*- und Schweizer Garantieservice, besuchen Sie bitte entweder die folgend angegebene Internetadresse (eine druckfähige Version befindet sich auch auf unserer Webseite), oder wenden Sie sich an den für Ihr Land zuständigen Yamaha-Vertrieb. *EWR: Europäischer Wirtschaftsraum	Deutsch
Remarque importante: informations de garantie pour les clients de l'EEE et la Suisse Pour des informations plus détaillées sur la garantie de ce produit Yamaha et sur le service de garantie applicable dans l'ensemble de l'EEE ainsi qu'en Suisse, consultez notre site Web à l'adresse ci-dessous (le fichier imprimable est disponible sur notre site Web) ou contactez directement Yamaha dans votre pays de résidence. * EEE : Espace Economique Européen	Français
Belangrijke mededeling: Garantie-informatie voor klanten in de EER* en Zwitserland Voor gedetailleerde garantie-informatie over dit Yamaha-product en de garantieservice in heel de EER* en Zwitserland, gaat u naar de onderstaande website (u vindt een afdrukbaar bestand op onze website) of neemt u contact op met de vertegenwoordiging van Yamaha in uw land. * EER: Europese Economische Ruimte	Nederlands
Aviso importante: información sobre la garantía para los clientes del EEE* y Suiza Para una información detallada sobre este producto Yamaha y sobre el soporte de garantía en la zona EEE* y Suiza, visite la dirección web que se incluye más abajo (la versión del archivo para imprimir esta disponible en nuestro sitio web) o póngase en contacto con el representante de Yamaha en su país. * EEE: Espacio Económico Europeo	Español
Avviso importante: informazioni sulla garanzia per i clienti residenti nell'EEA* e in Svizzera Per informazioni dettagliate sulla garanzia relativa a questo prodotto Yamaha e l'assistenza in garanzia nei paesi EEA* e in Svizzera, potete consultare il sito Web all'indirizzo riportato di seguito (è disponibile il file in formato stampabile) oppure contattare l'ufficio di rappresentanza locale della Yamaha. * EEA: Area Economica Europea	Italiano
Aviso importante: informações sobre as garantias para clientes da AEE* e da Suíça Para obter uma informação pormenorizada sobre este produto da Yamaha e sobre o serviço de garantia na AEE* e na Suíça, visite o site a seguir (o arquivo para impressão está disponível no nosso site) ou entre em contato com o escritório de representação da Yamaha no seu país. * AEE: Área Económica Européia	Português
Σημαντική σημείωση: Πληροφορίες εγγύησης για τους πελάτες στον ΕΟΧ* και Ελλάδα Για λεπτομερείς πληροφορίες εγγύησης σχετικά με το παρόν προϊόν της Yamaha και την κάλυψη εγγύησης σε όλες τις χώρες του ΕΟΧ και την Ελλάδα, επισκεφτείτε την παρακάτω ιστοσελίδα (Εκτυπώσιμη μορφή είναι διαθέσιμη στην ιστοσελίδα μας) ή απευθυνθείτε στην αντιπροσωπεία της Yamaha στη χώρα σας. * ΕΟΧ: Ευρωπαϊκός Οικονομικός Χώρος	Ελληνικά
Viktigt: Garantiinformation för kunder i EES-området* och Schweiz För detaljerad information om denna Yamahaprodukt samt garantiservice i hela EES-området* och Schweiz kan du antingen besöka nedanstående webbadress (en utskriftsvänlig fil finns på webbplatsen) eller kontakta Yamahas officiella representant i ditt land. * EES: Europeiska Ekonomiska Samarbetsområdet	Svenska
Viktig merknad: Garantiinformasjon for kunder i EØS* og Sveits Detaljert garantiinformasjon om dette Yamaha-produktet og garantiservice for hele EØS-området* og Sveits kan fås enten ved å besøke nettstedene nedenfor (utskriftsversjon finnes på våre nettsider) eller kontakte Yamahas kontoret i landet der du bor. *EØS: Det europeiske økonomiske samarbeidsområdet	Norsk
Vigtig oplysning: Garantioplysninger til kunder i EØO* og Schweiz De kan finde detaljerede garantioplysninger om dette Yamaha-produkt og den fælles garantiserviceordning for EØO* (og Schweiz) ved at besøge det websted, der er angivet nedenfor (der findes en fil, som kan udskrives, på vores websted), eller ved at kontakte Yamahas nationale repræsentationskontor i det land, hvor De bor. * EØO: Det Europæiske Økonomiske Område	Dansk
Tärkeä ilmoitus: Takuutiedot Euroopan talousalueen (ETA)* ja Sveitsin asiakkaille Tämän Yamaha-tuotteen sekä ETA-alueen ja Sveitsin takuuta koskevat yksityiskohtaiset tiedot saatte alla olevasta nettiosoitteesta. (Tulostettava tiedosto saatavissa sivustollamme.) Voitte myös ottaa yhteyttä paikalliseen Yamaha-edustajaan. *ETA: Euroopan talousalue	Suomi
Ważne: Warunki gwarancyjne obowiązujące w EOG* i Szwajcarii Aby dowiedzieć się więcej na temat warunków gwarancyjnych tego produktu firmy Yamaha i serwisu gwarancyjnego w całym EOG* i Szwajcarii, należy odwiedzić wskazaną poniżej stronę internetową (Plik gotowy do wydruku znajduje się na naszej stronie internetowej) lub skontaktować się z przedstawicielstwem firmy Yamaha w swoim kraju. * EOG — Europejski Obszar Gospodarczy	Polski
Důležité oznámení: Záruční informace pro zákazníky v EHS* a ve Švýcarsku Podrobné záruční informace o tomto produktu Yamaha a záručním servisu v celém EHS* a ve Švýcarsku naleznete na níže uvedené webové adrese (soubor k tisku je dostupný na našich webových stránkách) nebo se můžete obrátit na zastoupení firmy Yamaha ve své zemi. * EHS: Evropský hospodářský prostor	Česky
Fontos figyelemzetés: Garancia-információk az EGT* területén és Svájcban élő vásárlók számára A jelen Yamaha termékre vonatkozó részletes garancia-információk, valamint az EGT*-re és Svájcra kiterjedő garanciális szolgáltatás tekintetében keresse fel webhelyünket az alábbi címen (a webhelyen nyomtatható fájl is található), vagy pedig lépjen kapcsolatba az országában működő Yamaha képviselői irodával. * EGT: Európai Gazdasági Térség	Magyar
Oluline märkus: Garantiiteave Euroopa Majanduspiirkonna (EMP)* ja Šveitsi klientidele Täpsemate teabe saamiseks selle Yamaha toote garantii ning kogu Euroopa Majanduspiirkonna ja Šveitsi garantiiteeninduse kohta, külastage palun veebisaiti alljärgneval aadressil (meie saidil on saadaval printitav fail) või pöörduge Teie regioonil Yamaha esinduse poole. * EMP: Euroopa Majanduspiirkond	Eesti keel
Svarīgs paziņojums: garantijas informācija klientiem EEZ* un Šveicē Lai saņemtu detalizētu garantijas informāciju par šo Yamaha produktu, kā arī garantijas apkalpošanu EEZ* un Šveicē, lūdzu, apmeklējiet zemāk norādīto tīmekļa vietnes adresi (tīmekļa vietnē ir pieejams drukājams fails) vai sazinieties ar jūsu valsti apkalpojošo Yamaha pārstāvniecību. * EEZ: Eiropas Ekonomikas zona	Latviešu
Dėmesio: informacija dėl garantijos pirkėjams EEE* ir Šveicarijoje Jei reikia išsamios informacijos apie šį „Yamaha“ produktą ir jo techninę priežiūrą visoje EEE* ir Šveicarijoje, apsilankykite mūsų svetainėje toliau nurodytu adresu (svetainėje yra spausdintinas failas) arba kreipkitės į „Yamaha“ atstovybę savo šaliai. *EEE – Europos ekonominė erdvė	Lietuvių kalba
Dôležité upozornenie: Informácie o záruke pre zákazníkov v EHP* a Švajčiarsku Podrobné informácie o záruke týkajúce sa tohto produktu od spoločnosti Yamaha a garančnom servise v EHP* a Švajčiarsku nájdete na webovej stránke uvedenej nižšie (na našej webovej stránke je k dispozícii súbor na tlač) alebo sa obráťte na zástupcu spoločnosti Yamaha vo svojej krajine. * EHP: Európsky hospodársky priestor	Slovenčina
Pomembno obvestilo: Informacije o garanciji za kupce v EGP* in Švici Za podrobnejše informacije o tem Yamahinem izdelku ter garancijskem servisu v celotnem EGP in Švici, obiščite spletno mesto, ki je navedeno spodaj (natisljiva datoteka je na voljo na našem spletnem mestu), ali se obrnite na Yamahinega predstavnika v svoji državi. * EGP: Evropski gospodarski prostor	Slovenščina
Важно съобщение: Информация за гаранцията за клиенти в ЕИП* и Швейцария За подробна информация за гаранцията за този продукт на Yamaha и гаранционното обслужване в паневропейската зона на ЕИП* и Швейцария или посетете посочения по-долу уеб сайт (на нашия уеб сайт има файл за печат), или се свържете с представителния офис на Yamaha във вашата страна. * ЕИП: Европейско икономическо пространство	Български език
Notificare importantă: Informații despre garanție pentru clienții din SEE* și Elveția Pentru informații detaliate privind acest produs Yamaha și serviciul de garanție Pan-SEE* și Elveția, vizitați site-ul la adresa de mai jos (fișierul imprimabil este disponibil pe site-ul nostru) sau contactați biroul reprezentanței Yamaha din țara dumneavoastră. * SEE: Spațiul Economic European	Limba română

<http://europe.yamaha.com/warranty/>

URL_4

Information for Users on Collection and Disposal of Old Equipment



This symbol on the products, packaging, and/or accompanying documents means that used electrical and electronic products should not be mixed with general household waste. For proper treatment, recovery and recycling of old products, please take them to applicable collection points, in accordance with your national legislation and the Directives 2002/96/EC.

By disposing of these products correctly, you will help to save valuable resources and prevent any potential negative effects on human health and the environment which could otherwise arise from inappropriate waste handling.

For more information about collection and recycling of old products, please contact your local municipality, your waste disposal service or the point of sale where you purchased the items.

[For business users in the European Union]

If you wish to discard electrical and electronic equipment, please contact your dealer or supplier for further information.

[Information on Disposal in other Countries outside the European Union]

This symbol is only valid in the European Union. If you wish to discard these items, please contact your local authorities or dealer and ask for the correct method of disposal.

(weee_eu_en_01)

Information concernant la Collecte et le Traitement des déchets d'équipements électriques et électroniques.



Le symbole sur les produits, l'emballage et/ou les documents joints signifie que les produits électriques ou électroniques usagés ne doivent pas être mélangés avec les déchets domestiques habituels. Pour un traitement, une récupération et un recyclage appropriés des déchets d'équipements électriques et électroniques, veuillez les déposer aux points de collecte prévus à cet effet, conformément à la réglementation nationale et aux Directives 2002/96/EC.

En vous débarrassant correctement des déchets d'équipements électriques et électroniques, vous contribuerez à la sauvegarde de précieuses ressources et à la prévention de potentiels effets négatifs sur la santé humaine qui pourraient advenir lors d'un traitement inapproprié des déchets.

Pour plus d'informations à propos de la collecte et du recyclage des déchets d'équipements électriques et électroniques, veuillez contacter votre municipalité, votre service de traitement des déchets ou le point de vente où vous avez acheté les produits.

[Pour les professionnels dans l'Union Européenne]

Si vous souhaitez vous débarrasser des déchets d'équipements électriques et électroniques veuillez contacter votre vendeur ou fournisseur pour plus d'informations.

[Information sur le traitement dans d'autres pays en dehors de l'Union Européenne]

Ce symbole est seulement valable dans l'Union Européenne. Si vous souhaitez vous débarrasser de déchets d'équipements électriques et électroniques, veuillez contacter les autorités locales ou votre fournisseur et demander la méthode de traitement appropriée.

(weee_eu_fr_01)

OBSERVERA!

Apparaten kopplas inte ur växelströmskällan (nätet) så länge som den är ansluten till vägguttaget, även om själva apparaten har stängts av.

ADVARSEL: Netspændingen til dette apparat er IKKE afbrudt, så længe netledningen sidder i en stikkontakt, som er tændt — også selvom der er slukket på apparatets afbryder.

VAROITUS: Laitteen toisiopiiriin kytketty käyttökytkin ei irroita koko laitetta verkosta.

(standby)

The model number, serial number, power requirements, etc., may be found on or near the name plate, which is at the bottom of the unit. You should note this serial number in the space provided below and retain this manual as a permanent record of your purchase to aid identification in the event of theft.

Model No.

Serial No.

(bottom_en_01)

Le numéro de modèle, le numéro de série, l'alimentation requise, etc., se trouvent sur ou près de la plaque signalétique du produit, située dans la partie inférieure de l'unité. Notez le numéro de série dans l'espace fourni ci-dessous et conservez ce manuel en tant que preuve permanente de votre achat afin de faciliter l'identification du produit en cas de vol.

N° de modèle

N° de série

(bottom_fr_01)

For details of products, please contact your nearest Yamaha representative or the authorized distributor listed below.

Pour plus de détails sur les produits, veuillez-vous adresser à Yamaha ou au distributeur le plus proche de vous figurant dans la liste suivante.

NORTH AMERICA

CANADA

Yamaha Canada Music Ltd.
135 Milner Avenue, Scarborough, Ontario,
M1S 3R1, Canada
Tel: 416-298-1311

U.S.A.

Yamaha Corporation of America
6600 Orangethorpe Ave., Buena Park, Calif. 90620,
U.S.A.
Tel: 714-522-9011

CENTRAL & SOUTH AMERICA

MEXICO

Yamaha de México S.A. de C.V.
Avenida Insurgentes número 1647,
Col. San José Insurgentes, C.P. 03900,
Deleg. Benito Juárez, México, D.F.
Tel: 55-5804-0600

BRAZIL

Yamaha Musical do Brasil Ltda.
Rua Joaquim Floriano, 913 - 4° andar, Itaim Bibi,
CEP 04534-013 Sao Paulo, SP. BRAZIL
Tel: 011-3704-1377

ARGENTINA

**Yamaha Music Latin America, S.A.
Sucursal de Argentina**
Olga Cossetini 1553, Piso 4 Norte
Madero Este-C1107CEK
Buenos Aires, Argentina
Tel: 011-4119-7000

PANAMA AND OTHER LATIN AMERICAN COUNTRIES/ CARIBBEAN COUNTRIES

Yamaha Music Latin America, S.A.
Torre Banco General, Piso 7, Urbanización Marbella,
Calle 47 y Aquilino de la Guardia,
Ciudad de Panamá, Panamá
Tel: +507-269-5311

EUROPE

THE UNITED KINGDOM/IRELAND

Yamaha Music Europe GmbH (UK)
Sherbourne Drive, Tilbrook, Milton Keynes,
MK7 8BL, England
Tel: 01908-366700

GERMANY

Yamaha Music Europe GmbH
Siemensstraße 22-34, 25462 Rellingen, Germany
Tel: 04101-3030

SWITZERLAND/LIECHTENSTEIN

**Yamaha Music Europe GmbH
Branch Switzerland in Zürich**
Seefeldstrasse 94, 8008 Zürich, Switzerland
Tel: 044-387-8080

AUSTRIA

Yamaha Music Europe GmbH Branch Austria
Schleiergasse 20, A-1100 Wien, Austria
Tel: 01-60203900

CZECH REPUBLIC/HUNGARY/ ROMANIA/SLOVAKIA/SLOVENIA

**Yamaha Music Europe GmbH
Branch Austria (Central Eastern Europe Office)**
Schleiergasse 20, A-1100 Wien, Austria
Tel: 01-602039025

POLAND/LITHUANIA/LATVIA/ESTONIA

**Yamaha Music Europe GmbH
Branch Poland Office**
ul. Wrotkowa 14 02-553 Warsaw, Poland
Tel: 022-500-2925

BULGARIA

Dinacord Bulgaria LTD.
Bul. Iskarsko Schose 7 Targowski Zentar Ewropa
1528 Sofia, Bulgaria
Tel: 02-978-20-25

MALTA

Olimpus Music Ltd.
The Emporium, Level 3, St. Louis Street Msida
MSD06
Tel: 02133-2144

THE NETHERLANDS/ BELGIUM/LUXEMBOURG

Yamaha Music Europe Branch Benelux
Clarissenhof 5-b, 4133 AB Vianen, The Netherlands
Tel: 0347-358 040

FRANCE

Yamaha Music Europe
7 rue Ambroise Croizat, Zone d'activités Pariest,
77183 Croissy-Beaubourg, France
Tel: 01-64-61-4000

ITALY

Yamaha Music Europe GmbH, Branch Italy
Viale Italia 88, 20020 Lainate (Milano), Italy
Tel: 02-935-771

SPAIN/PORTUGAL

**Yamaha Music Europe GmbH Ibérica, Sucursal
en España**
Ctra. de la Coruna km. 17, 200, 28230
Las Rozas (Madrid), Spain
Tel: 01-639-8888

GREECE

Philippos Nakas S.A. The Music House
147 Skiathou Street, 112-55 Athens, Greece
Tel: 01-228 2160

SWEDEN

**Yamaha Music Europe GmbH Germany filial
Scandinavia**
J. A. Wettergrens Gata 1, Box 30053
S-400 43 Göteborg, Sweden
Tel: 031 89 34 00

DENMARK

**Yamaha Music Europe GmbH, Tyskland - filial
Denmark**
Generatorvej 6A, DK-2730 Herlev, Denmark
Tel: 44 92 49 00

FINLAND

F-Musiikki Oy
Kluuvikatu 6, P.O. Box 260,
SF-00101 Helsinki, Finland
Tel: 09 618511

NORWAY

**Yamaha Music Europe GmbH Germany -
Norwegian Branch**
Grini Næringspark 1, N-1345 Østerås, Norway
Tel: 67 16 77 70

ICELAND

Skifan HF
Skeifan 17 P.O. Box 8120, IS-128 Reykjavik, Iceland
Tel: 525 5000

RUSSIA

Yamaha Music (Russia)
Room 37, bld. 7, Kievskaya street, Moscow,
121059, Russia
Tel: 495 626 5005

OTHER EUROPEAN COUNTRIES

Yamaha Music Europe GmbH
Siemensstraße 22-34, 25462 Rellingen, Germany
Tel: +49-4101-3030

AFRICA

**Yamaha Corporation,
Asia-Pacific Sales & Marketing Group**
Nakazawa-cho 10-1, Naka-ku, Hamamatsu,
Japan 430-8650
Tel: +81-53-460-2313

MIDDLE EAST

TURKEY/CYPRUS

Yamaha Music Europe GmbH
Siemensstraße 22-34, 25462 Rellingen, Germany
Tel: 04101-3030

OTHER COUNTRIES

Yamaha Music Gulf FZE
LOB 16-513, P.O.Box 17328, Jubel Ali,
Dubai, United Arab Emirates
Tel: +971-4-881-5868

ASIA

THE PEOPLE'S REPUBLIC OF CHINA

Yamaha Music & Electronics (China) Co., Ltd.
2F, Yunhedasha, 1818 Xinzha-lu, Jingan-qu,
Shanghai, China
Tel: 021-6247-2211

HONG KONG

Tom Lee Music Co., Ltd.
11/F., Silvercord Tower 1, 30 Canton Road,
Tsimshatsui, Kowloon, Hong Kong
Tel: 2737-7688

INDIA

Yamaha Music India Pvt. Ltd.
Spazedge building, Ground Floor, Tower A, Sector
47, Gurgaon- Sohna Road, Gurgaon, Haryana, India
Tel: 0124-485-3300

INDONESIA

**PT. Yamaha Musik Indonesia (Distributor)
PT. Nusantik**
Gedung Yamaha Music Center, Jalan Jend. Gatot
Subroto Kav. 4, Jakarta 12930, Indonesia
Tel: 021-520-2577

KOREA

Yamaha Music Korea Ltd.
8F, 9F, Dongsung Bldg. 158-9 Samsung-Dong,
Kangnam-Gu, Seoul, Korea
Tel: 02-3467-3300

MALAYSIA

Yamaha Music (Malaysia) Sdn., Bhd.
Lot 8, Jalan Perbandaran, P.O. Box Kelana Jaya,
Petaling Jaya, Selangor, Malaysia
Tel: 03-78030900

PHILIPPINES

Yupangco Music Corporation
339 Gil J. Puyat Avenue, P.O. Box 885 MCPO,
Makati, Metro Manila, Philippines
Tel: 819-7551

SINGAPORE

Yamaha Music (Asia) PRIVATE LIMITED
Blk 202 Hougang Street 21, #02-00,
Singapore 530202, Singapore
Tel: 6747-4374

TAIWAN

Yamaha KHS Music Co., Ltd.
3F, #6, Sec. 2, Nan Jing E. Rd. Taipei.
Taiwan 104, R.O.C.
Tel: 02-2511-8688

THAILAND

Siam Music Yamaha Co., Ltd.
4, 6, 15 and 16th floor, Siam Motors Building,
891/1 Rama 1 Road, Wangmai,
Pathumwan, Bangkok 10330, Thailand
Tel: 02-215-2622

OTHER ASIAN COUNTRIES

**Yamaha Corporation,
Asia-Pacific Sales & Marketing Group**
Nakazawa-cho 10-1, Naka-ku, Hamamatsu,
Japan 430-8650
Tel: +81-53-460-2313

OCEANIA

AUSTRALIA

Yamaha Music Australia Pty. Ltd.
Level 1, 99 Queensbridge Street, Southbank,
Victoria 3006, Australia
Tel: 3-9693-5111

NEW ZEALAND

Music Works LTD
P.O.Box 6246 Wellesley, Auckland 4680,
New Zealand
Tel: 9-634-0099

COUNTRIES AND TRUST TERRITORIES IN PACIFIC OCEAN

**Yamaha Corporation,
Asia-Pacific Sales & Marketing Group**
Nakazawa-cho 10-1, Naka-ku, Hamamatsu,
Japan 430-8650
Tel: +81-53-460-2313

DMI5

Yamaha web site
<http://www.yamaha.com/>

Yamaha Downloads
<http://download.yamaha.com/>

U.R.G., Digital Musical Instruments Division
© 2013 Yamaha Corporation

211POGR*-*-01A0
Printed in Indonesia

ZE12040

Free Manuals Download Website

<http://myh66.com>

<http://usermanuals.us>

<http://www.somanuals.com>

<http://www.4manuals.cc>

<http://www.manual-lib.com>

<http://www.404manual.com>

<http://www.luxmanual.com>

<http://aubethermostatmanual.com>

Golf course search by state

<http://golfingnear.com>

Email search by domain

<http://emailbydomain.com>

Auto manuals search

<http://auto.somanuals.com>

TV manuals search

<http://tv.somanuals.com>