

EF1000iS

⚠ WARNING

The engine exhaust from this product contains chemicals known to the State of California to cause cancer, birth defects or other reproductive harm.

YAMAHA

LIT-CALIF-65-01

INTRODUCTION

Congratulations on your purchase of your new Yamaha.

This manual will provide you with a good basic understanding of the operation and maintenance of this machine.

If you have any questions regarding the operation or maintenance of your machine, please consult a Yamaha dealer.

PRI-I.D. NUMBER

	MODEL	
	<input type="text"/>	
PRI-I.D. CODE		SERIAL No.
<input type="text"/>		<input type="text"/>

AE00012

IDENTIFICATION NUMBER RECORDS

Record your Primary I.D., and serial numbers in the spaces provided, to assist you in ordering spare parts from a Yamaha dealer.

Also record and keep these I.D. numbers in a separate place in case your machine is stolen.

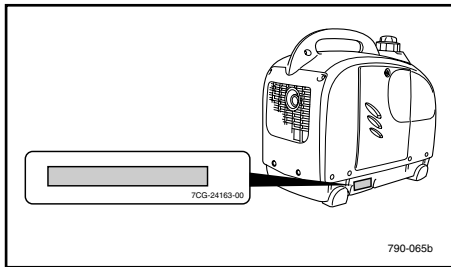

AE00011

MACHINE IDENTIFICATION

The machine serial number is stamped in the location as shown.

NOTE: _____

The first three digits of these numbers are for model identification; the remaining digits are the unit production number. Keep a record of these numbers for reference when ordering parts from a Yamaha dealer.

AE00022

**EF1000iS
OWNER'S MANUAL**
 © 2004 by Yamaha Motor Corporation, U.S.A.
 1st Edition, March 2004
 All rights reserved.
 Any reprinting or unauthorized use
 without the written permission of
 Yamaha Motor Corporation, U.S.A.
 is expressly prohibited.
 Printed in Japan.
 P/N LIT-19626-01-19

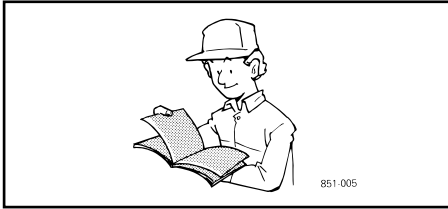

AE00032

⚠ WARNING

PLEASE READ AND UNDERSTAND THIS MANUAL COMPLETELY BEFORE OPERATING THE MACHINE.

NOTE:

- Yamaha continually seeks advancements in product design and quality. Therefore, while this manual contains the most current product information available at the time of printing, there may be minor discrepancies between your engine and this manual. If there is any question concerning this manual, please consult your Yamaha dealer.
- This manual should be considered a permanent part of this engine and should remain with this engine when resold.

Particularly important information is distinguished in this manual by the following notations.



The Safety Alert Symbol means **ATTENTION! BECOME ALERT! YOUR SAFETY IS INVOLVED!**

⚠ WARNING

Failure to follow **WARNING** instructions could result in severe injury or death to the engine operator, a bystander, or a person inspecting or repairing the engine.

CAUTION:

A **CAUTION** indicates special precautions that must be taken to avoid damage to the engine.

NOTE:

A **NOTE** provides key information to make procedures easier or clearer.

CONTENTS

LIMITED WARRANTY (EF- AND EDL-SERIES)	1	SPARK PLUG INSPECTION	22
LOCATION OF IMPORTANT LABELS ..	3	CARBURETOR ADJUSTMENT.....	22
SAFETY INFORMATION	4	ENGINE OIL REPLACEMENT	23
EXHAUST FUMES ARE		MUFFLER SCREEN AND SPARK	
POISONOUS	4	ARRESTER	24
FUEL IS HIGHLY FLAMMABLE AND		AIR FILTER.....	26
POISONOUS	4	FUEL TANK FILTER.....	27
ENGINE AND MUFFLER MAY		TROUBLESHOOTING	28
BE HOT.....	4	STORAGE	30
ELECTRIC SHOCK PREVENTION	5	DRAIN THE FUEL	30
CONNECTION NOTES	6	ENGINE	30
CONNECTION.....	6	EXHAUST EMISSION CONTROL	
EXTENSION CORD NOTES	6	SYSTEM AND COMPONENTS	31
CONTROL FUNCTION	7	SPECIFICATIONS	32
DESCRIPTION	7	DIMENSIONS	32
CONTROL PANEL.....	7	ENGINE	32
OIL WARNING SYSTEM.....	8	GENERATOR	32
ENGINE SWITCH	8	WIRING DIAGRAM	33
ECONOMY CONTROL SWITCH.....	8		
DC PROTECTOR	9		
FUEL TANK CAP AIR VENT KNOB ...	9		
FUEL COCK KNOB	9		
PRE-OPERATION CHECK	10		
FUEL.....	10		
ENGINE OIL	11		
GROUND (Earth)	11		
OPERATION	12		
STARTING THE ENGINE.....	12		
APPLICATION RANGE	14		
CONNECTION.....	15		
STOPPING THE ENGINE	19		
PERIODIC MAINTENANCE	20		
MAINTENANCE CHART	20		

YAMAHA MOTOR CORPORATION U.S.A. EF- AND EDL-SERIES GENERATOR LIMITED WARRANTY

Yamaha Motor Corporation, U.S.A. hereby warrants that new Yamaha consumer generators purchased from an authorized Yamaha consumer generator dealer in the continental United States will be free from defects in material and workmanship for the period of time stated herein, subject to certain stated limitations.

THE PERIOD OF WARRANTY Any new EF-series or EDL-series Yamaha Generator purchased for private, non-commercial use from an authorized Yamaha consumer generator dealer in the continental United States will be warranted against defects in material or workmanship for a period two (2) years from date of purchase, subject to exclusions noted herein. Any Yamaha non-commercial generator purchased and utilized for commercial or rental applications will be warranted for a period one (1) year from the date of purchase, subject to exclusions noted herein.

DURING THE PERIOD OF WARRANTY any authorized Yamaha consumer generator dealer will, free of charge, repair or replace, at Yamaha's option, any part adjudged defective by Yamaha due to faulty workmanship or material from the factory. Parts used in warranty repairs will be warranted for the balance of the product's warranty period. All parts replaced under warranty become property of Yamaha Motor Corporation U.S.A.

GENERAL EXCLUSIONS from this warranty shall include any failures caused by:

- a. Installation of parts or accessories that are not qualitatively equivalent to genuine Yamaha parts.
- b. Abnormal strain, neglect, or abuse.
- c. Lack of proper maintenance.
- d. Accident or collision damage.

SPECIFIC EXCLUSIONS from this warranty shall include parts replaced due to normal wear or routine maintenance.

THE CUSTOMER'S RESPONSIBILITY under this warranty shall be to:

1. Operate and maintain the generator as specified in the appropriate Owner's Manual;

2. Give notice to an authorized Yamaha consumer generator dealer of any and all apparent defects within ten (10) days after discovery, and make the unit available at that time for inspection and repairs at such dealer's place of business.

WARRANTY TRANSFER: To transfer the warranty from the original purchaser to any subsequent purchaser(s), it is imperative that the unit be inspected and registered for warranty by an authorized Yamaha consumer generator dealer. In order for this warranty to remain in effect, this inspection and registration must take place within ten (10) days after transfer. An inspection and registration fee will be charged for this service. In no case will the warranty be extended beyond the original period.

YAMAHA MOTOR CORPORATION, U.S.A. MAKES NO OTHER WARRANTY OF ANY KIND, EXPRESSED OR IMPLIED. ALL IMPLIED WARRANTIES OF MERCHANTABILITY AND FITNESS FOR A PARTICULAR PURPOSE WHICH EXCEED THE OBLIGATIONS AND TIME LIMITS STATED IN THIS WARRANTY ARE HEREBY DISCLAIMED BY YAMAHA MOTOR CORPORATION, U.S.A. AND EXCLUDED FROM THIS WARRANTY.

SOME STATES DO NOT ALLOW LIMITATIONS ON HOW LONG AN IMPLIED WARRANTY LASTS, SO THE ABOVE LIMITATION MAY NOT APPLY TO YOU. ALSO EXCLUDED FROM THIS WARRANTY ARE ANY INCIDENTAL OR CONSEQUENTIAL DAMAGES INCLUDING LOSS OF USE. SOME STATES DO NOT ALLOW THE EXCLUSION OR LIMITATION OF INCIDENTAL OR CONSEQUENTIAL DAMAGES, SO THE ABOVE EXCLUSION MAY NOT APPLY TO YOU.

THIS WARRANTY GIVES YOU SPECIFIC LEGAL RIGHTS, AND YOU MAY ALSO HAVE OTHER RIGHTS WHICH VARY FROM STATE TO STATE.

YAMAHA MOTOR CORPORATION, U.S.A.
Post Office Box 6555
Cypress, California 90630

WARRANTY QUESTIONS AND ANSWERS

Q. What costs are my responsibility during the warranty period?

A. The customer's responsibility includes all costs of normal maintenance service, non-warranty repairs, accident damages, as well as oil and spark plugs.

Q. What are some examples of "abnormal" strain, neglect, or abuse?

A. These terms are general and overlap each other in areas. Specific examples include: Running the machine out of oil; lack of proper maintenance; operating the machine with a broken or damaged part which causes another part to fail; and so on. If you have any specific questions on operation or maintenance, please contact your dealer for advice.

Q. Does the warranty cover incidental costs such as transportation due to a failure?

A. No. The warranty is limited to repair of the machine itself.

Q. May I perform any or all of the recommended maintenance shown in the Owner's Manual instead of having the dealer do them?

A. Yes, if you are a qualified mechanic and follow the procedures specified in the Owner's and Service Manual. We do recommend, however, that items requiring special tools or equipment be done by a Yamaha generator dealer.

Q. Will the warranty be void or cancelled if I do not operate or maintain my new Yamaha exactly as specified in the Owner's Manual?

A. No. The warranty on a new Yamaha cannot be "voided" or "cancelled."

However, if a particular failure is caused by operation or maintenance other than as shown in the Owner's Manual, that failure may not be covered under warranty.

Q. What responsibility does my dealer have under this warranty?

A. Each Yamaha generator dealer is expected to:

1. Check the operation of the generator before sale.
2. Explain the operation, maintenance, and warranty requirements to your satisfaction at the time of sale, and upon your request at any later date.

In addition, each Yamaha generator dealer is held responsible for his setup, service and warranty repair work.

Q. Is the warranty transferable to second owners?

A. Yes. The remainder of the existing warranty can be transferred upon request. The unit has to be inspected and reregistered by an authorized Yamaha generator dealer for the policy to remain effective.

CUSTOMER SERVICE

If your machine requires warranty service, you must take it to any authorized Yamaha generator dealer within the continental United States. Be sure to bring your warranty registration identification or other valid proof of the original date of purchase. If a question or problem arises regarding warranty, first contact the owner of the dealership. Since all warranty matters are handled at the dealer level, this person is in the best position to help you. If you are still not satisfied and require additional assistance, please write:

YAMAHA MOTOR CORPORATION U.S.A.
CUSTOMER RELATIONS DEPARTMENT
P.O. BOX 6555
Cypress, California 90630

CHANGE OF ADDRESS

The federal government requires each manufacturer to maintain a complete, up-to-date list of all first purchasers against the possibility of a safety-related defect and recall. This list is compiled from the purchase registrations sent to Yamaha Motor Corporation, U.S.A. by the selling dealer at the time of your purchase. If you should move after you have purchased your new generator, please advise us of your new address by sending a postcard listing your Yamaha model name, engine number, dealer number (or dealer's name) as it is shown on your warranty identification, your name and new mailing address. Mail to:

YAMAHA MOTOR CORPORATION, U.S.A.
WARRANTY DEPARTMENT
P.O. Box 6555
Cypress, California 90630

This will ensure that Yamaha Motor Corporation, U.S.A. has an up-to-date registration record in accordance with federal law.

LOCATION OF IMPORTANT LABELS

Please read the following labels carefully before operating this machine.

NOTE: _____

Maintain or replace safety and instruction labels, as necessary.

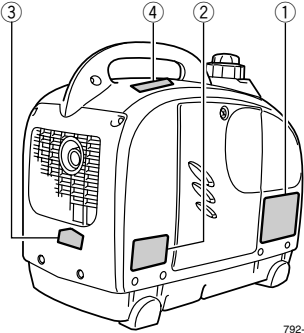

792-050

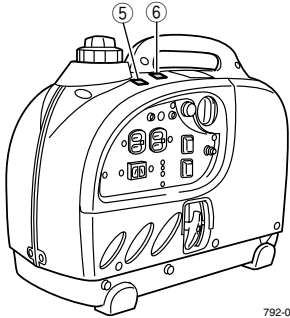

792-051d

①

⚠ WARNING

- READ THE OWNER'S MANUAL AND ALL LABELS BEFORE OPERATING.
- ONLY OPERATE IN WELL-VENTILATED AREAS. EXHAUST GAS CONTAINS POISONOUS CARBON MONOXIDE.
- CHECK FOR SPILLED FUEL OR FUEL LEAKS.
- STOP ENGINE BEFORE REFUELING.
- DO NOT OPERATE NEAR FLAMMABLE MATERIALS.
- ELECTROCUTION CAN OCCUR IF GENERATOR IS USED IN RAIN, SNOW, OR NEAR WATER. KEEP THIS UNIT DRY AT ALL TIMES.
- ELECTROCUTION OR PROPERTY DAMAGE CAN OCCUR. DO NOT CONNECT THIS GENERATOR TO ANY BUILDING'S ELECTRICAL SYSTEM UNLESS AN ISOLATION SWITCH HAS BEEN INSTALLED BY A LICENSED ELECTRICIAN. REFER TO THE OWNER'S MANUAL.

7VV-24162-10

③

HOT EXHAUST

7VV-28176-10

②

OIL	YAMAHA *****
	AC output **Hz Rated ***VA ***V Phase Single DC output **V *A Fuel Gasoline
YAMAHA MOTOR CO., LTD MADE IN JAPAN 7VV-24164-10	

⑥

STARTING INSTRUCTION

- Disconnect all electrical devices.
- Turn ECON. switch to OFF
- Open fuel cap vent
- Turn fuel knob ON
- Turn engine switch to ON
- Pull choke knob out
- Pull recoil starter
- Push choke knob in

7CG-25134-10

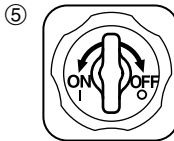

④

IMPORTANT ENGINE INFORMATION

EM ENGINE FAMILY: ***** **YAMAHA**

REFER TO OWNER'S MANUAL FOR MAINTENANCE SPECIFICATIONS AND ADJUSTMENTS.

DISPLACEMENT: * * * ccm	VALVE LASH (mm) IN: * * * * * EX: * * * * *
IGNITION TIMING & IDLE MIXTURE NO OTHER ADJUSTMENTS NEEDED.	
IDLE SPEED: * * * * - * * * * rpm AT NO LOAD	
FUEL: THIS ENGINE IS CERTIFIED TO OPERATE ON UNLEADED GASOLINE.	
ENGINE OIL: SAE 10W-30	TYPE SE

THIS ENGINE MEETS * * * * - * * * * CALIFORNIA EMISSION REGULATIONS FOR SMALL OFF-ROAD ENGINES. THIS ENGINE CONFORMS TO PHASE 2 U.S.EPA REGULATIONS FOR SMALL NONROAD ENGINES. EMISSIONS COMPLIANCE PERIOD: CATEGORY A (EPA)

ENGINE AIR INDEX (California only)

NOTE: THE LOWER THE AIR INDEX, THE LESS THE POLLUTION THIS ENGINE IS CERTIFIED TO BE EMISSION COMPLIANT FOR THE FOLLOWING USE:

MODERATE INTERMEDIATE EXTENDED

CHECK OWNERS MANUAL FOR FURTHER DETAILS
THIS LABEL TO BE REMOVED BY THE ULTIMATE PURCHASER ONLY!
YAMAHA MOTOR CO. LTD 7VV-2179R-00

AE00071

SAFETY INFORMATION

AE00072

EXHAUST FUMES ARE POISONOUS

- Never operate the engine in a closed area or it may cause unconsciousness and death within a short time. Operate the engine in a well ventilated area.

AE01018

FUEL IS HIGHLY FLAMMABLE AND POISONOUS

- Always turn off the engine when refuelling.
- Never refuel while smoking or in the vicinity of an open flame.
- Take care not to spill any fuel on the engine or muffler when refuelling.
- If you swallow any fuel, inhale fuel vapor, or allow any to get in your eye(s), see your doctor immediately. If any fuel spills on your skin or clothing, immediately wash with soap and water and change your clothes.
- When operating or transporting the generator, be sure it is kept upright. If it tilts, fuel may leak from the carburetor or fuel tank. Also, be sure the fuel tank cap air vent knob is tightened when transporting the generator.

AE01019

ENGINE AND MUFFLER MAY BE HOT

- Place the generator in a place where pedestrians or children are not likely to touch the generator.
- Avoid placing any flammable materials near the exhaust outlet during operation.

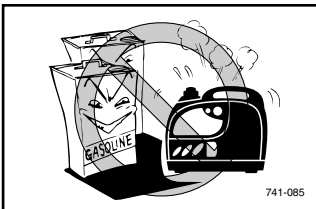
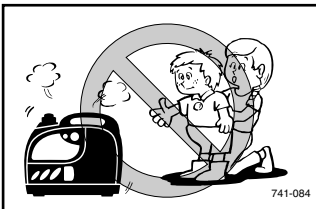
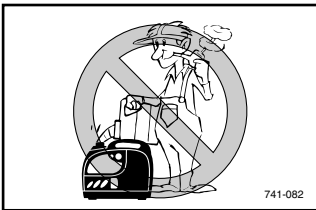
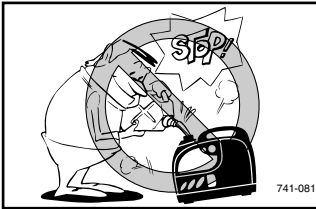

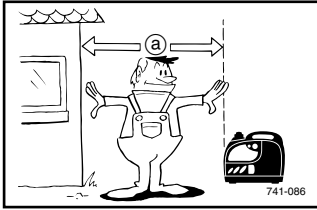

- Keep the generator at least 1 m (3 ft) from buildings or other equipment, or the engine may overheat.

Ⓐ 1 m (3 ft)

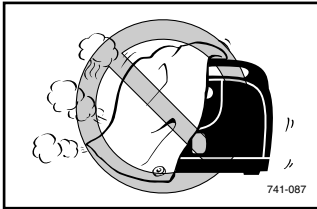

- Avoid operating the engine with a dust cover.

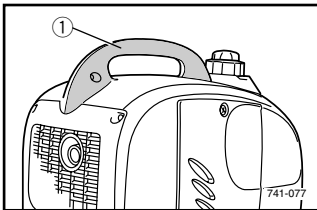

- Be sure to carry the generator only by its carrying handle.

① Carrying handle

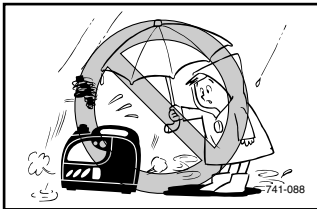

AE01020

ELECTRIC SHOCK PREVENTION

- Never operate the engine in rain or snow.

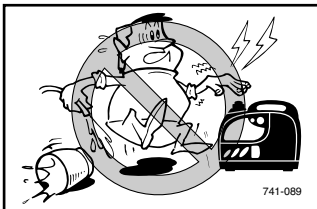

- Never touch the generator with wet hands or electrical shock will occur.

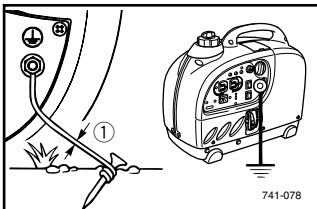

- Be sure to ground (earth) the generator.

NOTE: _____

Use ground (earth) lead of sufficient current capacity.

① Lead diameter

Ground (earth) Lead
 Diameter:
 0.12 mm (0.005 in)/ampere
 EX;
 10 Ampere → 1.2mm (0.05 in)

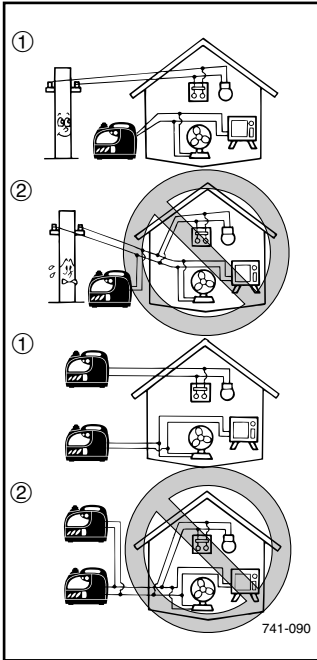

AE00088

CONNECTION NOTES

- Avoid connecting the generator to commercial power outlet.
- Avoid connecting the generator in parallel with any other generator.

- ① Correct
- ② Incorrect

AE00091

CONNECTION

⚠ WARNING

Before the generator can be connected to a building's electrical system, a licensed electrician must install an isolation (transfer) switch in the building's main fuse box. The switch is the connection point for generator power and allows selection of generator or main line power to the building. This will prevent the generator from charging the main power line (backfeeding) when the main power supply has failed or has been turned off for line repair. Backfeeding can electrocute or injure line maintenance personnel. Also, generator and building electrical system damage can occur when normal operating power returns if unit is used without an isolation switch.

AE00086

EXTENSION CORD NOTES

- When using an extension cord, its total length should not exceed
 - 60 meters for cross section of 1.5 mm square and
 - 100 meters for cross section of 2.5 mm square.
- This extension cord should be protected by a tough flexible rubber sheath (IEC 245) or the equivalent to withstand mechanical stresses.

CONTROL FUNCTION

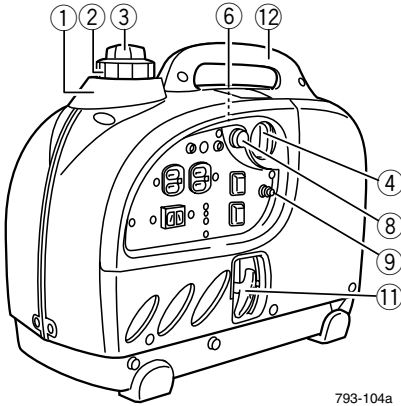

AE00102

DESCRIPTION

- ① Fuel tank
- ② Fuel tank cap
- ③ Fuel tank cap air vent knob
- ④ Fuel cock knob
- ⑤ Air filter cover
- ⑥ Spark plug
- ⑦ Muffler
- ⑧ Choke knob
- ⑨ Ground (Earth) terminal
- ⑩ Oil filler cap
- ⑪ Recoil starter
- ⑫ Carrying handle

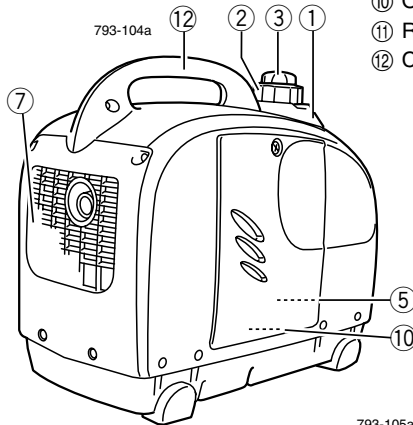

793-105a

AE00103

CONTROL PANEL

- ① Overload indicator light
- ② AC pilot light
- ③ Oil warning light
- ④ Engine switch (Red)
- ⑤ Choke knob
- ⑥ Fuel cock knob
- ⑦ Ground (Earth) terminal
- ⑧ Economy control switch (Black)
- ⑨ DC protector
- ⑩ AC receptacle
- ⑪ DC receptacle

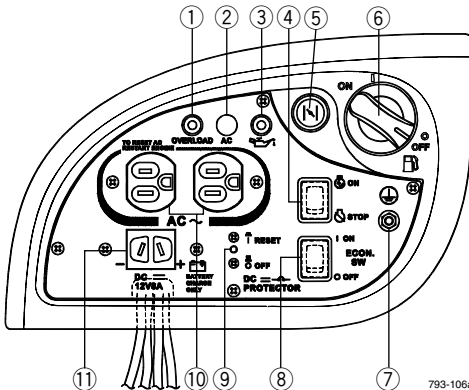

793-106a

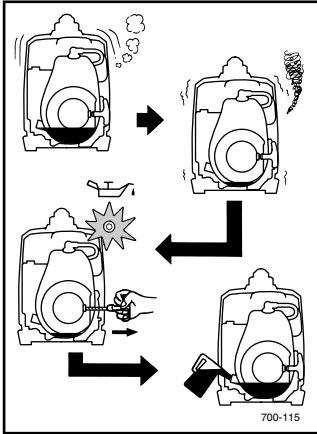

AE00111

OIL WARNING SYSTEM

When the oil level falls below the lower level, the engine stops automatically. Unless you refill with oil, the engine will not start again.

NOTE:

If the engine stalls or does not start, turn the engine switch to "ON" position and then pull the recoil starter. If the oil warning light flickers for a few seconds, the engine oil is insufficient. Add oil and restart.

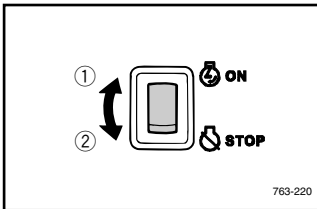

AE00939

ENGINE SWITCH (Red)

The engine switch controls the ignition system.

① "ON"

Ignition circuit is switched on.

The engine can be started.

② "STOP"

Ignition circuit is switched off.

The engine will not run.

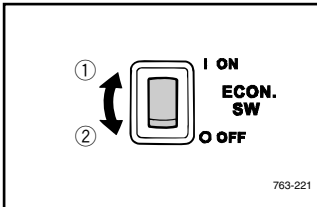

AE00988

ECONOMY CONTROL SWITCH (Black)

① "ON"

When the economy control switch is turned "I", the economy control unit controls the engine speed according to the connected load. The results are better fuel consumption and less noise.

② "OFF"

When the economy control switch is turned "O", the engine runs at the rated r/min (5,000 r/min) regardless of whether there is a load connected or not.

NOTE:

The economy control switch must be turned to "O" (OFF) when using electric devices that require a large starting current, such as a compressor or a submergible pump.

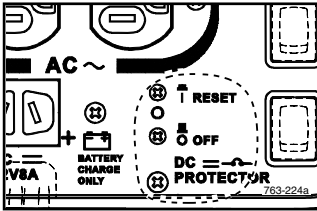

AE01099

DC PROTECTOR

The DC protector turns off automatically when the load exceeds the generator rated output.

CAUTION:

Reduce the load to the specified generator rated output if the DC protector turns off. If it turns off again, consult a Yamaha dealer.

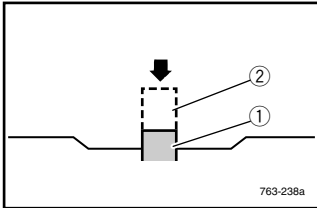

NOTE:

Press to reset the DC protector.

- ① "RESET"
- ② "OFF"

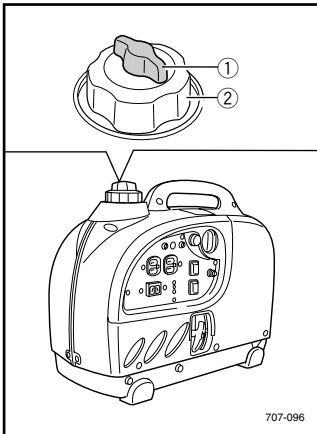

AE01021

FUEL TANK CAP AIR VENT KNOB

The fuel tank cap is provided with an air vent knob to stop fuel flow.

The air vent knob must be turned 1 turn counterclockwise from the tightened position. This will allow fuel to flow to the carburetor and the engine to run.

When the engine is not in use, tighten the air vent knob clockwise until it is finger-tight to stop fuel flow.

- ① Air vent knob
- ② Fuel tank cap

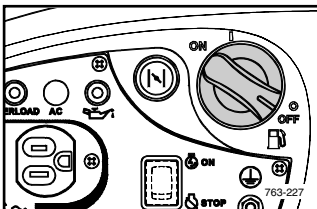

AE01034

FUEL COCK KNOB

The fuel cock knob is used to supply fuel from the fuel tank to the carburetor.

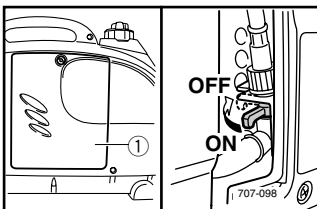

Remove the cover ① and the fuel cock lever can be found inside. If for some reason the fuel cock knob cannot be turned, this lever can be used to supply fuel.

PRE-OPERATION CHECK

NOTE: _____

Pre-operation checks should be made each time the generator is used.



⚠ WARNING _____

The engine and muffler will be very hot after the engine has been run.

Avoid touching the engine and muffler while they are still hot with any part of your body or clothing during inspection or repair.

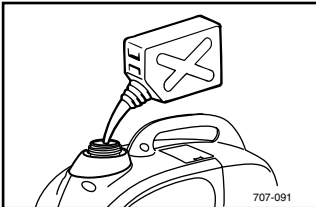

AE00212

FUEL

Make sure there is sufficient fuel in the tank.

Recommended fuel:
Unleaded gasoline
Fuel tank capacity:
Total: 2.5 L (0.55 Imp gal, 0.66 US gal)

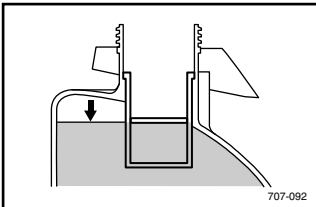

Your Yamaha engine has been designed to use regular unleaded gasoline with a pump octane number ((R + M)/2) of 86 or higher, or research octane number of 91 or higher.

⚠ WARNING _____

- Fuel is highly flammable and poisonous. Check "SAFETY INFORMATION" (See page 4) carefully before refueling.
- Do not fill above the top of the fuel filter or it may overflow when the fuel heats up later and expands.
- Wipe up any spilled fuel immediately.
- After refueling, make sure the tank cap is tightened securely.

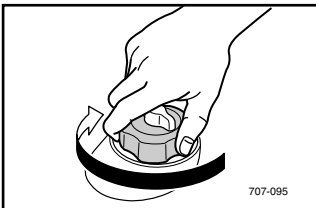

AE01158

ENGINE OIL

Make sure the engine oil is at the upper level of the oil filler hole. Add oil as necessary.

NOTE:

Place the generator on a level surface and check the oil level of the oil filler hole.

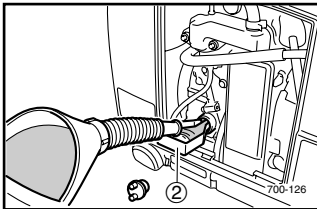
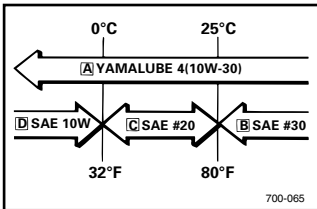
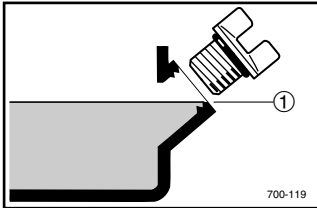
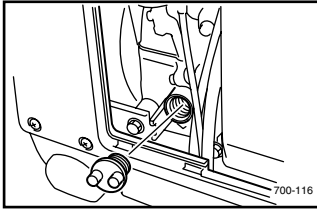

① Upper level

Recommended oil:

- A YAMALUBE 4 (10W-30) or SAE 10W-30 type SE motor oil
- B SAE #30
- C SAE #20
- D SAE 10W

Engine oil quantity:

0.32 L (0.28 Imp qt, 0.34 US qt)

NOTE:

Recommended engine oil classification:
API Service "SE" or "SF".

② Oil filler guide

CAUTION:

- The generator has been shipped without engine oil. Fill with oil or it will not start.
- Do not tilt the generator when adding engine oil. This could result in overfilling and damage to the engine.

AE00241

GROUND (Earth)

Make sure to ground (earth) the generator.
Check "SAFETY INFORMATION" on page 5.

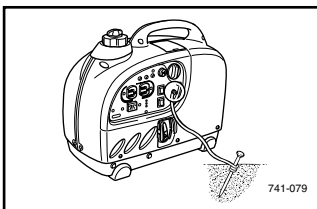

OPERATION

CAUTION:

- The generator has been shipped without engine oil. Fill with oil or it will not start.
- Do not tilt the generator when adding engine oil. This could result in overfilling and damage to the engine.

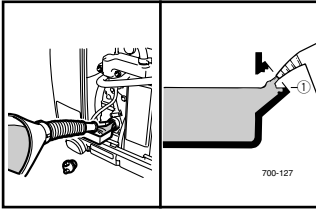

① Upper level

STARTING THE ENGINE

NOTE:

- Before starting the engine, do not connect any electric devices.
- Turn the economy control switch (Black) to the "O" (OFF) position.

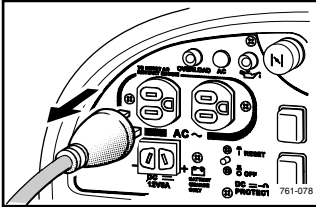

① ○ "OFF"

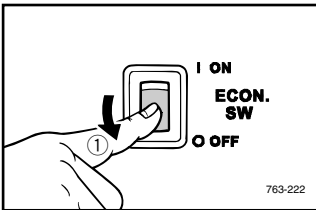

1. While holding the fuel tank cap so that it will not move, turn the air vent knob 1 turn counterclockwise to open the fuel tank air vent.

① Air vent knob

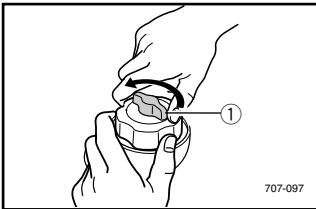

2. Turn the fuel cock knob to the "ON" position.

① "ON"

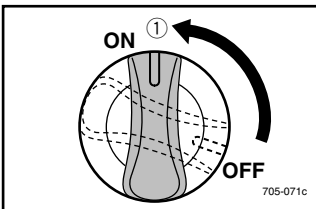

3. Turn the engine switch (Red) to the "ON" position.

① Ⓜ "ON"

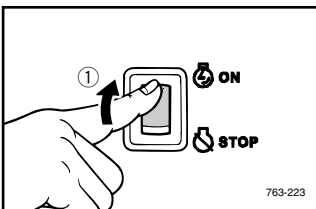

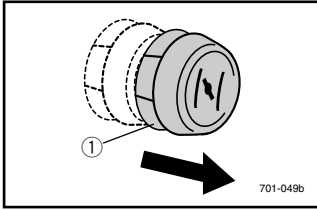

4. Pull the choke knob fully out.

① Choke knob

NOTE: _____

The choke is not required to start a warm engine. Push the choke knob in to the original position.

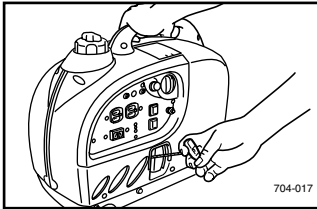

5. Pull slowly on the recoil starter until it is engaged, then pull it briskly.

NOTE: _____

Grasp the carrying handle firmly to prevent the generator from falling over when pulling the recoil starter.

6. After the engine starts, warm up the engine until the engine does not stop when the choke knob is returned to the original position.

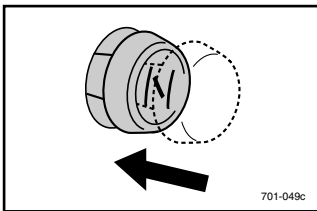

7. Push the choke knob back to the original position.





NOTE: _____

When starting the engine, with the economy control switch "I" (ON), and there is no load on the generator:

- in ambient temperature below 3°C (37°F), the engine will run at the rated r/min (5,000 r/min) for 5 minutes to warm up the engine.
- in ambient temperature above 3°C (37°F), the engine will run at the 4,000 r/min for 3 minutes to warm up the engine.

The economy control unit operates normally after the above time period, while the economy control switch is "I" (ON).

APPLICATION RANGE

AC				DC 
Power factor	1	0.8–0.95	0.4–0.75 (Efficiency 0.85)	
EF1000iS	–900W	–720W	–300W	Rated voltage 12V Rated current 8A

NOTE: _____

- “–” means below.
- Application wattage indicates when each device is used by itself.
- The simultaneous usage of AC and DC power is possible but total wattage should not exceed the rated output.

EX:

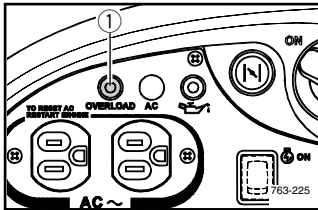

Generator rated output		900VA
Frequency	Power factor	
AC	1.0	–800W
	0.8	–640W
DC	—	96W (12V/8A)

- The overload indicator light ① comes on when total wattage exceeds the application range. (See page 16 for more details.)

CAUTION: _____

Be sure the total load is within generator rated output otherwise generator damage will occur.

NOTE: _____

Some precision equipment is voltage sensitive and may require a more uniform voltage supply than portable generators provide. Examples include some medical equipment, personal computers, and some inverters that sense peak and RMS voltage values. Consult the precision-equipment vendor before relying on any portable generator to provide power to such equipment.

CONNECTION

Alternating Current (AC)

CAUTION:

- Be sure all electric devices including the lines and plug connections are in good condition before connection to the generator.
- Be sure any electric devices are turned off before plugging it in.
- Be sure the total load is within generator rated output.
- Be sure the receptacle load current is within receptacle rated current.

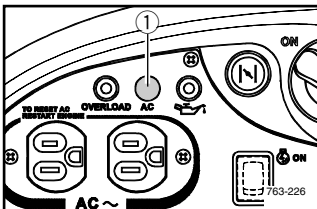
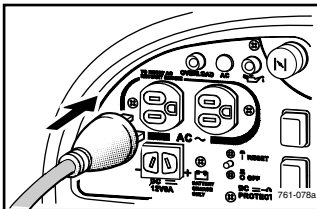
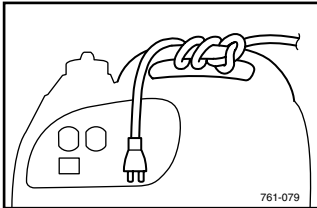

1. Wind the power lead 2 or 3 turns around handle.
2. Start the engine.
3. Plug in to the AC receptacle.

4. Make sure the AC pilot light is on.

① AC pilot light

5. Turn the economy control switch (Black) to the "I" (ON) position and turn on any electric devices.

① "I" (ON)

NOTE:

The economy control switch must be turned to "O" (OFF) when using electric devices that require a large starting current, such as a compressor or a submergible pump.

AE00953

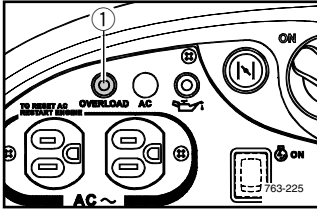

Overload indicator light

The overload indicator light ① comes on when an overload of a connected electrical device is detected, the inverter control unit overheats, or the AC output voltage rises. The electronic breaker will then activate, stopping power generation in order to protect the generator and any connected electric devices. The AC pilot light (green) will go off and the overload indicator light (red) will stay on, but the engine will not stop running.

When the overload indicator light comes on and power generation stops, proceed as follows:

1. Turn off any connected electric devices and stop the engine.
2. Reduce the total wattage of connected electric devices within the application range.
3. Check for blockages in the cooling air inlet and around the control unit. If any blockages are found, remove.
4. After checking, restart the engine.

NOTE:

- The generator AC output automatically resets when the engine is stopped and then restarted.
- The overload indicator light may come on for a few seconds at first when using electric devices that require a large starting current, such as a compressor or a submersible pump. However, this is not a malfunction.

Battery Charging

NOTE: _____

The generator DC rated voltage is 12V.

1. Wind the battery charging lead 2 or 3 turns around the handle and plug into DC receptacle.

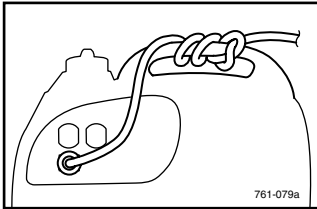

NOTE: _____

- Make connections to the battery after starting the engine.
 - Clamp the red wire to the positive (+) terminal and the black wire to the negative (-) terminal of the battery. Do not reverse these positions.
-

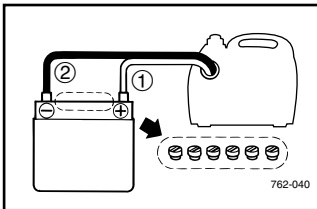

- ① Red
- ② Black

2. Start the engine.
3. Press in the DC protector and install the battery.

CAUTION: _____

- Be sure the economy control switch is turned off while charging the battery.
 - Be sure the battery leads are properly connected.
 - Be sure the breather hose is properly connected and is not damaged or obstructed.
 - Reduce the load to the specified generator rated output if the DC protector turns off. If it turns off again, consult a Yamaha dealer.
-

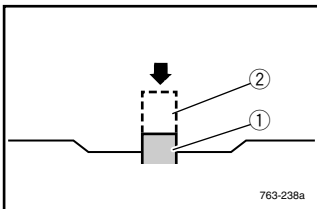
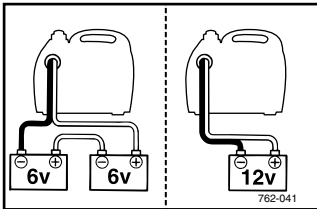

NOTE: _____

Press to reset the DC protector.

- ① "RESET"
- ② "OFF"

NOTE: _____

- At full charge, electrolyte specific gravity is between 1.26 and 1.28.
 - Check specific gravity hourly.
-

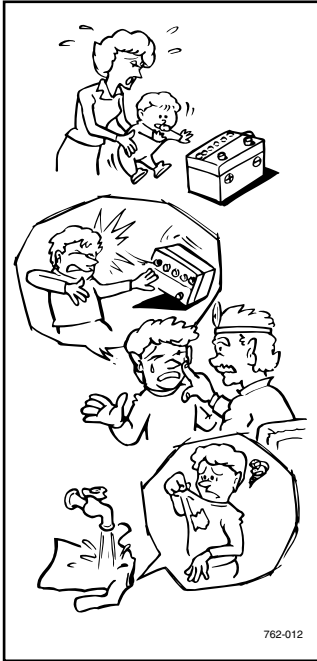

⚠ WARNING

Never smoke or make and break connections at the battery while charging. Sparks may ignite the battery gas.

Battery electrolyte is poisonous and dangerous, causing severe burns, etc. contains sulfuric (sulphuric) acid. Avoid contact with skin, eyes or clothing.

Antidote:

EXTERNAL-Flush with water.

INTERNAL-Drink large quantities of water or milk. Follow with milk of magnesia, beaten egg or vegetable oil. Call physician immediately.

EYES: Flush with water for 15 minutes and get prompt medical attention. Batteries produce explosive gases. Keep sparks, flame, cigarettes, etc., away. Ventilate when charging or using in closed space. Always cover eyes when working near batteries. **KEEP OUT OF REACH OF CHILDREN.**

STOPPING THE ENGINE

NOTE:

- Turn off any electric devices.
- Turn the economy control switch (Black) to the “○” (OFF) position.

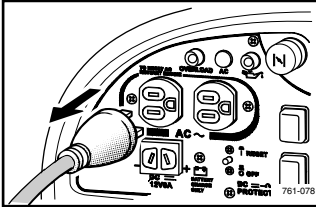
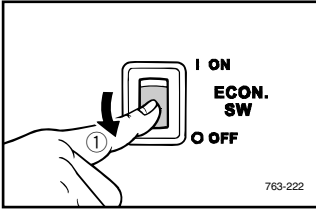

① ○ “OFF”

1. Disconnect any electric devices.

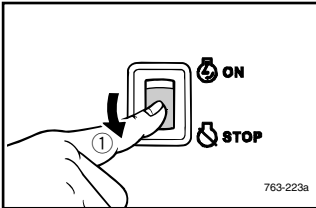

2. Turn the engine switch (Red) to the “⊗” (STOP) position.

① ⊗ “STOP”

3. Turn the fuel cock knob to “OFF”.

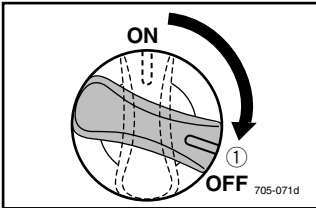

① “OFF”

4. Turn the fuel tank cap air vent knob clockwise until it is finger-tight.

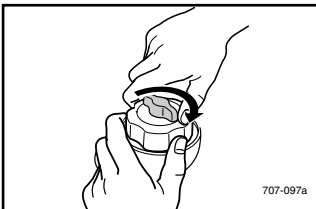

PERIODIC MAINTENANCE

AE00403

MAINTENANCE CHART

Regular maintenance is most important for best performance and safe operation.

⚠ WARNING

Stop the engine before starting maintenance work.

No.	Item	Remarks	Pre-Operation check (daily)	Every			
				1 month or 20 Hr	3 months or 50 Hr	6 months or 100 Hr	12 months or 300 Hr
1.	** Spark Plug	Check condition. Adjust gap and clean. Replace if necessary.			●		
2.*	** Valve Clearance	Check and adjust when engine is cold.					●
3.*	** Crankcase breather system	Check breather hose for cracks or damage. Replace if necessary.					●
4.	** Exhaust System	Check for leakage. Retighten or *replace gasket if necessary.	●				
		Check muffler screen and spark arrester. Clean/replace if necessary.					●
5.	Engine Oil	Check oil level	●				
		Replace		●		●	
6.	** Air Filter	Clean. Replace if necessary.			●		
7.	Fuel Filter	Clean fuel tank filter. Replace if necessary.				●	

* : It is recommended that these items be serviced by a Yamaha dealer.

** : Related to emission control system.

No.	Item	Remarks	Pre-Operation check (daily)	Initial	Every		
				1 month or 20 Hr	3 months or 50 Hr	6 months or 100 Hr	12 months or 300 Hr
8.	Fuel Line	Check fuel hose for crack or damage. *Replace if necessary.	●				
9.	** Choke knob	Check choke operation.	●				
10.	Cooling System	Check for fan damage.					●
11.	Starting System	Check recoil starter operation.	●				
12.*	** Decarbonization	More frequently if necessary.					●
13.	Generation	Check the pilot light comes on.	●				
14.*	Fittings/ Fasteners	Check all fittings and fasteners. Correct if necessary.				●	

* : It is recommended that these items be serviced by a Yamaha dealer.

** : Related to emission control system.

CAUTION: _____

Use only Yamaha specified genuine parts for replacement. Ask an authorized Yamaha dealer for further attention.

AE01026

SPARK PLUG INSPECTION

You should periodically remove and inspect the spark plug.

1. Remove the cover ①.

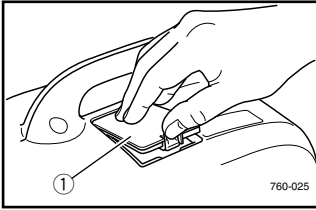

2. Check for discoloration and remove the carbon.

Standard electrode color:
Tan Color

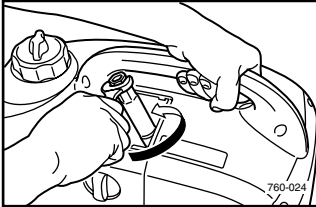

3. Check the spark plug type and gap.

Standard Spark Plug:
CR4HSB (NGK)
Spark Plug Gap:
0.6–0.7 mm (0.024–0.028 in)

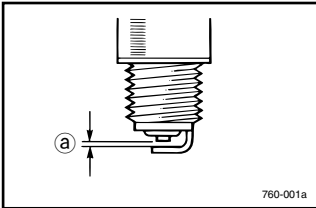

Ⓐ Gap

4. Install the spark plug.

Spark Plug Torque:
12.5 N•m (1.25 kgf•m, 9 lbf•ft)

5. Install the cover.

AE00431

CARBURETOR ADJUSTMENT

The carburetor is a vital part of the engine. Adjusting should be left to a Yamaha dealer with the professional knowledge, specialized data, and equipment to do so properly.

ENGINE OIL REPLACEMENT

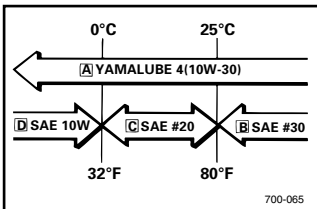
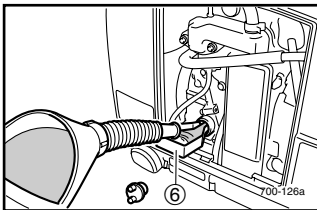
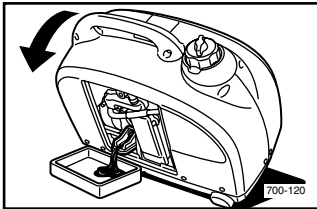
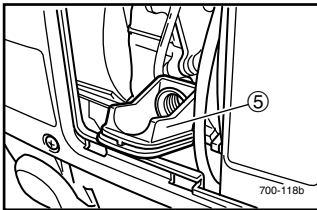
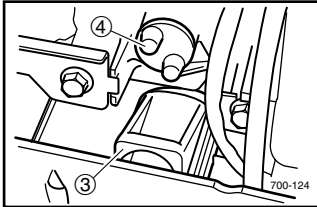
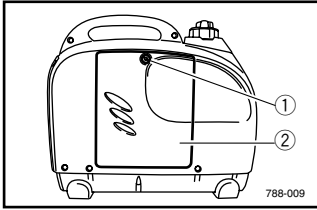

1. Place the generator on a level surface and warm up the engine for several minutes. Then stop the engine and turn the fuel cock knob to "OFF". Turn the fuel tank cap air vent knob clockwise.

2. Loosen the screw ① and remove the cover ②.
 3. Remove the oil drain joint ③ pushing downward from the bottom of the generator and remove the oil filler cap ④.

4. Attach the oil drain joint ⑤ to the oil filler hole.

5. Place an oil pan under the engine. Tilt the generator to drain the oil completely.
 6. Replace the generator on a level surface and remove the oil drain joint.

7. Add engine oil to the upper level of the filler hole using the oil filler guide.

⑥ Oil filler guide

CAUTION:

Do not tilt the generator when adding engine oil. This could result in overfilling and damage to the engine.

Recommended oil:

- Ⓐ YAMALUBE 4 (10W-30) or SAE 10W-30 type SE motor oil
- Ⓑ SAE #30
- Ⓒ SAE #20
- Ⓓ SAE 10W

Engine oil quantity: 0.32 L (0.28 Imp qt, 0.34 US qt)

NOTE: _____

Recommended engine oil classification:
API Service "SE" or "SF".

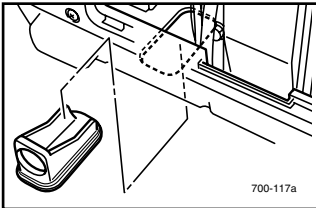

8. Wipe the oil drain joint clean, and wipe up any spilled oil.

CAUTION: _____

Be sure no foreign material enters the crankcase.

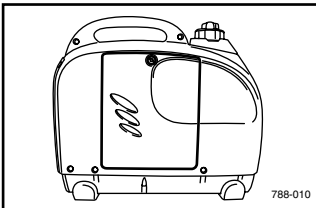

9. Install the oil filler cap.
10. Replace the oil drain joint in its original position.
11. Install the cover and tighten the screw.

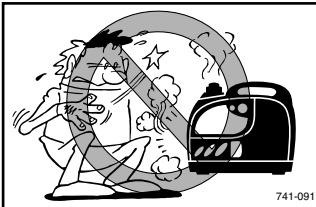

AE01028

MUFFLER SCREEN AND SPARK ARRESTER

⚠ WARNING _____

The engine and muffler will be very hot after the engine has been run.

Avoid touching the engine and muffler while they are still hot with any part of your body or clothing during inspection or repair.

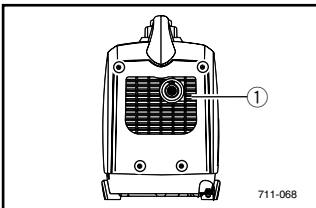

1. Remove the cover ①.

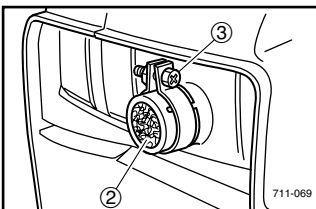

2. Remove the muffler screen.

- ② Muffler screen
③ Screw

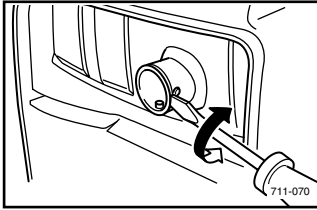

3. Use a flathead screw driver to pry the spark arrester out from the muffler.

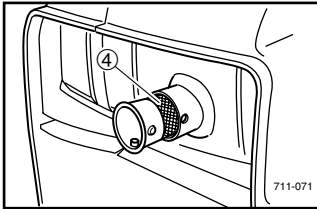

4. Remove the spark arrester.
- ④ Spark arrester

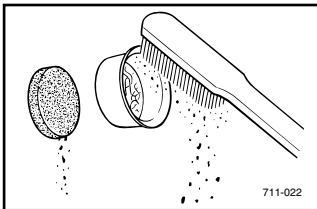

5. Remove the carbon deposits on the muffler screen and spark arrester using a wire brush.

CAUTION: _____

When cleaning, use the wire brush lightly to avoid damaging or scratching of the muffler screen and spark arrester.

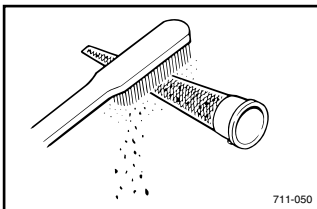

6. Check the muffler screen and spark arrester. Replace them if damaged.

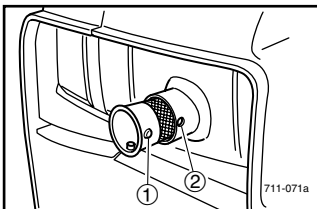

7. Install the spark arrester.

NOTE: _____

Align the spark arrester projection with the hole in the muffler pipe.

- ① Projection
② Hole

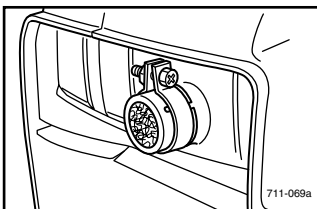

8. Install the muffler screen.

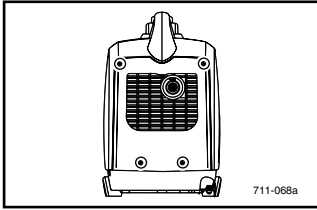

9. Install the cover.

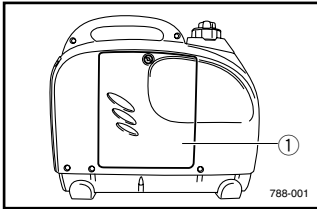

AE01029

AIR FILTER

1. Remove the cover ①.

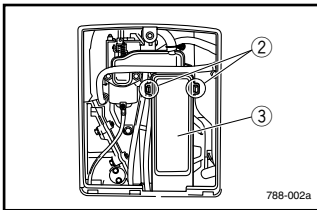

2. Remove the clip ② holding the air filter cover ③.

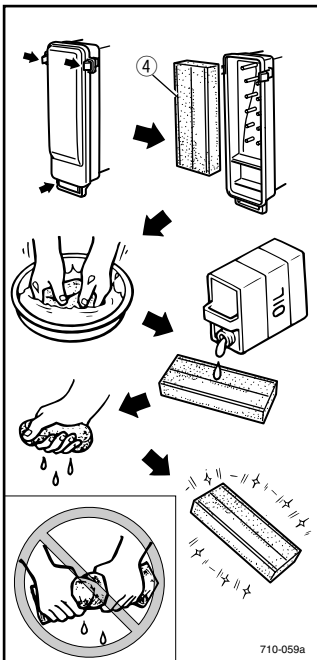

3. Remove the air filter cover and element ④.

4. Wash the element in solvent and dry.

5. Oil the element and squeeze out excess oil.
The element should be wet but not dripping.

Recommended oil:
Foam-air-filter oil
or
SAE #20 motor oil

CAUTION: _____

**Do not wring out the element.
This could cause it to tear.**

6. Insert the element into the air filter.

NOTE: _____

Be sure the element sealing surface matches the air filter so there is no air leak.

CAUTION: _____

The engine should never run without the element; excessive piston and cylinder wear may result.

⚠ WARNING _____

Never use solvent while smoking or in the vicinity of an open flame.

7. Replace the air filter cover in its original position and install the clip.
8. Install the cover.

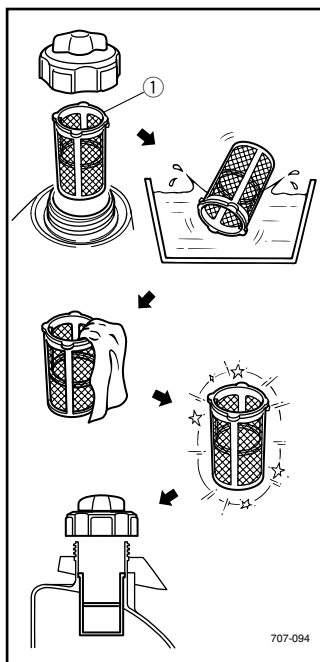

AE00471

FUEL TANK FILTER

1. Remove the fuel tank cap and filter.

① Filter

2. Clean the filter with solvent. If damaged, replace.
3. Wipe the filter and insert it.

⚠ WARNING _____

Be sure the tank cap is tightened securely.

TROUBLESHOOTING**Engine won't start**

1. Fuel systems

No fuel supplied to combustion chamber.

- No fuel in tank Supply fuel.
- Fuel in tank
 - Fuel tank cap air vent knob to "OPEN" (turn it 1 turn counterclockwise).
 - Fuel cock knob to "ON".
- Clogged fuel line Clean fuel line.
- Clogged carburetor Clean carburetor.

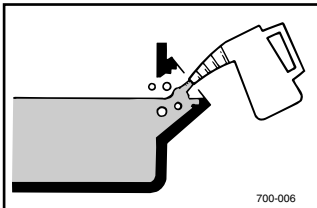
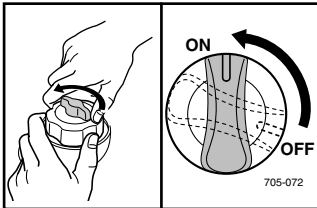
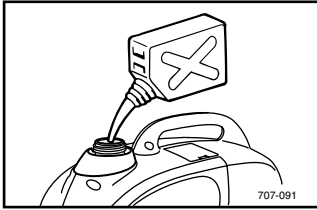

2. Engine oil system

Insufficient

- Oil level is low Add engine oil.

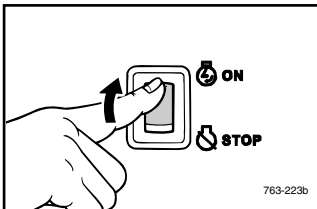

3. Electrical systems

- Engine switch (Red) to "ON".

Poor spark

- Spark plug dirty with carbon or wet Remove carbon or wipe spark plug dry.
- Faulty ignition system Consult dealer.

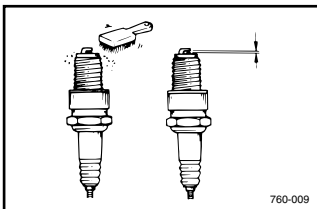

4. Compression

Insufficient

- Worn out piston and cylinder Consult dealer.

Generator won't produce power

- Safety device (AC) to "OFF" Stop the engine, then restart.
- Safety device (DC protector) to "OFF" Press to reset the DC protector.

A ENGINE DOES NOT START

B Turn the engine switch to "ON", then pull the recoil starter and check if the oil warning light flickers.

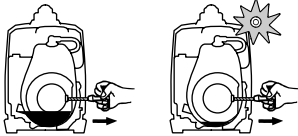

C Does not flicker **D** Flickers.

E Check engine oil level.	
F OK	G Level low
Consult a Yamaha dealer.	Add engine oil.

H Pull the recoil starter and check the spark plug for spark strength. (See "WARNING")



⚠ WARNING

- To prevent **FIRE HAZARDS** be sure fuel is not present in the spark plug area.
- To prevent **FIRE HAZARDS** be sure to place the spark plug as far way as possible from the spark plug hole and carburetor area.
- To prevent **ELECTRIC SHOCK** do not hold spark plug lead with hand while testing.

I Engine does not start. **J** Engine starts.

K Check the spark plug.	
<ul style="list-style-type: none"> • Type: • Gap: 	
L Incorrect	M OK
Replace or Adjust Gap.	Clean the spark plug.

N Check the following	O Clogged
	P OK
<ul style="list-style-type: none"> • Fuel line clogging • Air cleaner element clogging. 	

Q Clean or Replace; Consult a Yamaha dealer.

R Consult a Yamaha dealer.

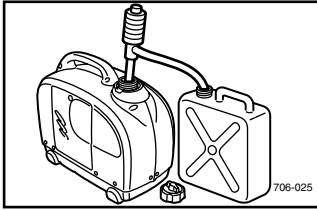

AE00601

STORAGE

Long term storage of your machine will require some preventive procedures to guard against deterioration.

AE01095

DRAIN THE FUEL

1. Remove the fuel tank cap. Drain the fuel from the fuel tank into an approved gasoline container using a commercially available hand siphon. Then, install the fuel tank cap.

WARNING

- Fuel is highly flammable and poisonous. Check "SAFETY INFORMATION" (See page 4) carefully.
- Wipe up any spilled fuel immediately.

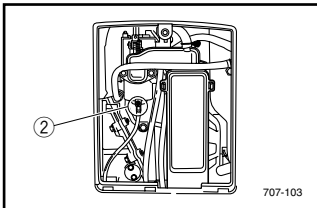
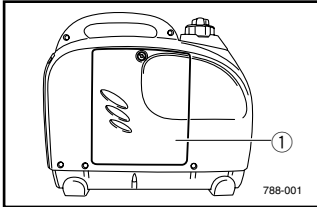

2. Remove the cover ①.
Drain fuel from the carburetor by loosening the drain screw ② on the carburetor float chamber.
3. Turn the fuel cock knob to "OFF".
Start the engine and leave it run until it stops.
This will burn any remaining fuel in the carburetor.

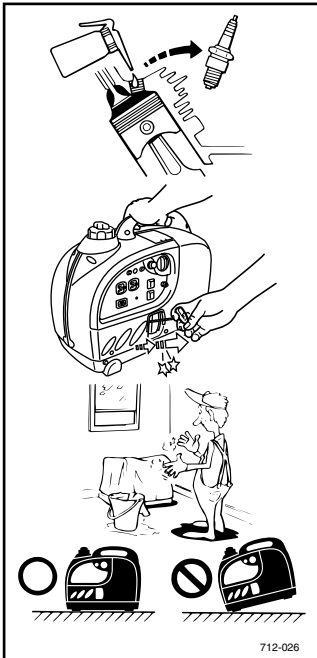

AE00621

ENGINE

1. Remove the spark plug, pour about one tablespoon of SAE 10W30 or 20W40 motor oil into the spark plug hole and reinstall the spark plug. Recoil start the engine by turning over several times (with ignition off) to coat the cylinder walls with oil.
2. Pull the recoil starter until you feel compression. Then stop pulling. (This prevents the cylinder and valves from rusting).
3. Clean exterior of the generator and apply a rust inhibitor.
4. Store the generator in a dry, well-ventilated place, with the cover placed over it.
5. The generator must remain in a vertical position when stored, carried or operated.

EXHAUST EMISSION CONTROL SYSTEM AND COMPONENTS

Item	Acronym
• CARB. ASSY., LH. & JT., CARBURETOR2	CARB (Carburetor)
• T.C.I. MAGNETO ASSY. & PLUG, SPARK	EI (Electronic Ignition)
• CRANKCASE1 & HEAD, CYLINDER1	PCV (Positive Crankcase Ventilation)
• AIR FILTER ASSY.	ACL (Air Cleaner)
• MUFF., 2, CAP, NET, WIRE2 & ARRESTER, SPARK	

The above items and the corresponding acronyms are provided in accordance with U.S. EPA REGULATIONS FOR NEW NONROAD SPARK-IGNITION NONHANDHELD ENGINES and the CALIFORNIA REGULATIONS FOR 1995 AND LATER SMALL OFF-ROAD ENGINES.

The acronyms conform to the latest version of the SAE’s recommended practice document J1930, “Diagnostic Acronyms, Terms, and Definitions For Electrical/Electronic System”.

It is recommended that these items be serviced by a Yamaha dealer.

AE00701

SPECIFICATIONS

AE00702

DIMENSIONS

	Unit	EF1000iS
Overall Length	mm (in)	450 (17.7)
Overall Width	mm (in)	240 (9.4)
Overall Height	mm (in)	380 (15.0)
Dry Weight	kg (lb)	12.7 (28.0)

AE00704

ENGINE

	Unit	EF1000iS
Type		Forced air cooled 4-stroke gasoline OHV
Cylinder Arrangement		Vertical 1 cylinder
Displacement	cm ³	50
Bore × Stroke	mm (in)	41.0 × 38.0 (1.61 × 1.50)
Rated Output	kW(HP)/r/min	1.21 (1.67)/5,000
Operation Hours at rated operation	Hr	4.3
Fuel		Unleaded gasoline
Fuel Tank Capacity	L (Imp gal, US gal)	2.5 (0.55, 0.66)
Engine Oil Quantity	L (Imp qt, US qt)	0.32 (0.28, 0.34)
Ignition System		TCI
Spark Plug: Type Gap	mm (in)	CR4HSB (NGK) 0.6–0.7 (0.024–0.028)
Noise Level*	dB (A)	57

* : Measured at rated operation from 7 m (23 ft) distance.

AE00707

GENERATOR

	Unit	EF1000iS
AC Output		
Rated Voltage	V	120
Rated frequency	Hz	60
Rated current	A	7.5
Rated Output	VA	900
Safety Device: Type		Electronic
DC Output		
Rated voltage	V	12
Rated current	A	8
Safety Device: Type		DC protector

WIRING DIAGRAM

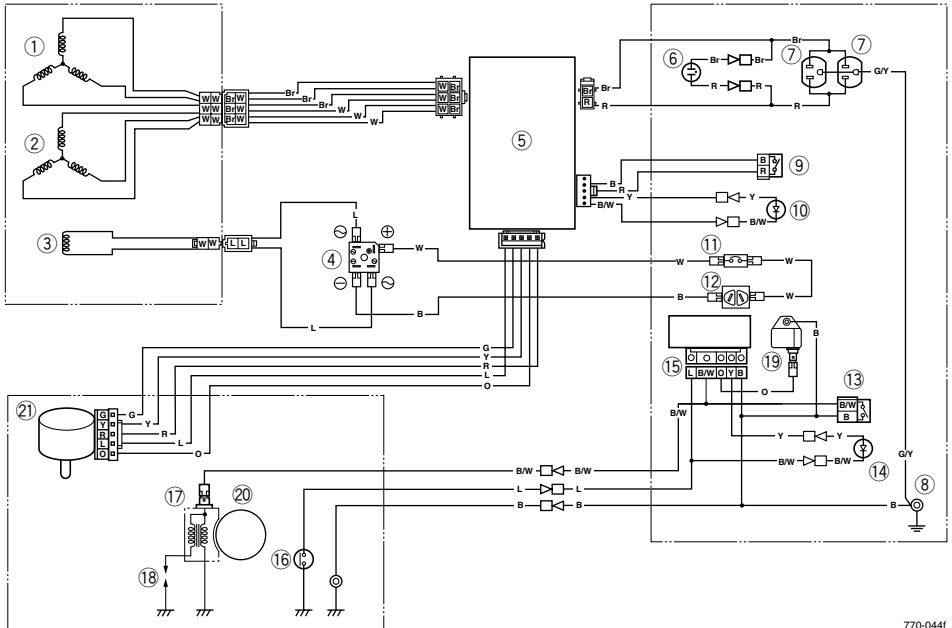

770-0441

- ① Main coil
- ② Sub coil
- ③ DC coil
- ④ DC rectifier
- ⑤ Control unit
- ⑥ AC pilot light
- ⑦ AC receptacle
- ⑧ Ground (Earth) terminal
- ⑨ Economy control switch
- ⑩ Overload indicator light
- ⑪ DC protector (breaker)

- ⑫ DC receptacle
- ⑬ Engine switch
- ⑭ Oil warning light
- ⑮ Speed limiter
- ⑯ Oil level gauge
- ⑰ Ignition coil
- ⑱ Spark plug
- ⑲ TCI unit
- ⑳ Stepping motor

Color code

- B Black
- Br Brown
- G Green
- Gy Gray
- L Blue
- O Orange
- R Red
- W White
- Y Yellow
- B/W Black/White
- G/Y Green/Yellow

PRINTED ON RECYCLED PAPER



YAMAHA

PRINTED IN JAPAN
04 • 04 – 1.2 × 1 

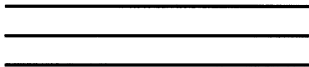

**YAMAHA MOTOR CORPORATION U.S.A.
P.O. BOX 6555
CYPRESS, CALIFORNIA 90630**

ATTN: WARRANTY DEPARTMENT

CUSTOMER WARRANTY REGISTRATION

OWNER'S
NAME _____

DATE SOLD

MODEL

MACHINE SERIAL NUMBER

ADDRESS _____

CITY &
STATE _____

ZIP _____

AREA CODE

PHONE NUMBER () _____

IMPORTANT!

- Please complete and mail this form. It will help ensure that Yamaha has accurately registered your purchase for warranty.
- Manufacturers are required to maintain a complete up-to-date list of all first purchasers of products against the possibility of a safety-related defect and recall.
- Please check the box that best describes the primary area of usage of this product:

Private

Commercial

Rental

MAIL THIS TO YAMAHA MOTOR CORPORATION, U.S.A. d.

Free Manuals Download Website

<http://myh66.com>

<http://usermanuals.us>

<http://www.somanuals.com>

<http://www.4manuals.cc>

<http://www.manual-lib.com>

<http://www.404manual.com>

<http://www.luxmanual.com>

<http://aubethermostatmanual.com>

Golf course search by state

<http://golfingnear.com>

Email search by domain

<http://emailbydomain.com>

Auto manuals search

<http://auto.somanuals.com>

TV manuals search

<http://tv.somanuals.com>