



OWNER'S MANUAL

Generator

EF4000DE  
EF5200DE  
EF6600DE  
YG4000D  
YG5200D  
YG6600D  
YG6600DE

LIT-19626-01-15

7WV-28199-11

**⚠ WARNING**

**The engine exhaust from this product contains chemicals known to the State of California to cause cancer, birth defects or other reproductive harm.**

YAMAHA

LIT-CALIF-65-01

# INTRODUCTION

Congratulations on your purchase of your new Yamaha.

This manual will provide you with a good basic understanding of the operation and maintenance of this machine.

If you have any questions regarding the operation or maintenance of your machine, please consult a Yamaha dealer.

PRI-I.D. NUMBER:

	<b>MODEL</b>	
	[ ]	
<b>PRI-I.D. CODE</b>		<b>SERIAL No.</b>
[ ]		[ ]

AE00012

## IDENTIFICATION NUMBER RECORDS

Record your Primary I.D., and serial numbers in the spaces provided, to assist you in ordering spare parts from a Yamaha dealer.

Also record and keep these I.D. numbers in a separate place in case your machine is stolen.

AE00011

## MACHINE IDENTIFICATION

The machine serial number is stamped in the location as shown.

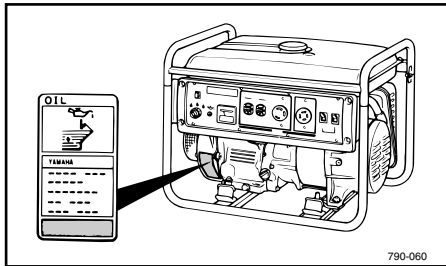

**NOTE:** \_\_\_\_\_

The first three digits of these numbers are for model identification; the remaining digits are the unit production number. Keep a record of these numbers for reference when ordering parts from a Yamaha dealer.

\_\_\_\_\_

AE00022

**EF4000DE/EF5200DE/EF6600DE  
YG4000D/YG5200D/YG6600D/YG6600DE  
OWNER'S MANUAL**

**© 2003 by Yamaha Motor Corporation, U.S.A.  
1st Edition, August 2003  
All rights reserved.**

**Any reprinting or unauthorized use  
without the written permission of  
Yamaha Motor Corporation, U.S.A.  
is expressly prohibited.**

**Printed in Japan.  
P/N LIT-19626-01-15**

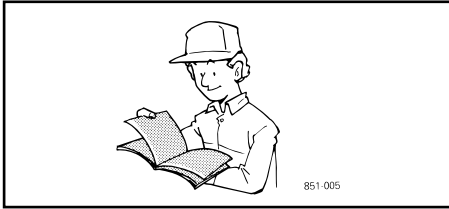

AE00032

## **⚠ WARNING**

**PLEASE READ AND UNDERSTAND THIS MANUAL COMPLETELY BEFORE OPERATING THE MACHINE.**

### **NOTE:**

- Yamaha continually seeks advancements in product design and quality. Therefore, while this manual contains the most current product information available at the time of printing, there may be minor discrepancies between your engine and this manual. If there is any question concerning this manual, please consult a Yamaha dealer.
- This manual should be considered a permanent part of this engine and should remain with this engine when resold.

Particularly important information is distinguished in this manual by the following notations.



The Safety Alert Symbol means **ATTENTION! BECOME ALERT! YOUR SAFETY IS INVOLVED!**

## **⚠ WARNING**

Failure to follow **WARNING** instructions could result in severe injury or death to the engine operator, a bystander, or a person inspecting or repairing the engine.

### **CAUTION:**

A **CAUTION** indicates special precautions that must be taken to avoid damage to the engine.

### **NOTE:**

A **NOTE** provides key information to make procedures easier or clearer.

# CONTENTS

<b>LIMITED WARRANTY (EF- AND EDL-SERIES)</b> .....	1	<b>PERIODIC MAINTENANCE</b> .....	25
<b>LIMITED WARRANTY (EC- AND YG-SERIES)</b> .....	2	MAINTENANCE CHART .....	25
<b>LOCATION OF IMPORTANT LABELS</b> .....	4	SPARK PLUG INSPECTION .....	27
<b>SAFETY INFORMATION</b> .....	6	CARBURETOR ADJUSTMENT .....	27
EXHAUST FUMES ARE		ENGINE OIL REPLACEMENT .....	28
POISONOUS .....	6	AIR FILTER .....	29
FUEL IS HIGHLY FLAMMABLE AND		FUEL COCK .....	30
POISONOUS .....	6	FUEL TANK FILTER.....	30
ENGINE AND MUFFLER MAY		MUFFLER SCREEN AND SPARK	
BE HOT .....	6	ARRESTER .....	31
ELECTRIC SHOCK PREVENTION .....	7	BATTERY .....	34
CONNECTION NOTES .....	8	FUSE REPLACEMENT .....	35
CONNECTION.....	8	G.F.C.I. RECEPTACLE TEST .....	35
EXTENSION CORD NOTES .....	8	TROUBLESHOOTING.....	36
<b>CONTROL FUNCTION</b> .....	9	<b>STORAGE</b> .....	40
DESCRIPTION .....	9	DRAIN THE FUEL .....	40
CONTROL BOX.....	11	ENGINE .....	40
OIL WARNING SYSTEM.....	13	BATTERY .....	41
ENGINE SWITCH.....	13	<b>EXHAUST EMISSION CONTROL</b>	
STARTER SWITCH.....	13	<b>SYSTEM AND COMPONENTS</b> .....	42
AC SWITCH (N.F.B.) .....	14	<b>SPECIFICATIONS</b> .....	43
ECONOMY IDLE SWITCH .....	14	DIMENSIONS .....	43
VOLTAGE ADJUSTER.....	15	ENGINE .....	43
G.F.C.I. RECEPTACLE .....	15	GENERATOR .....	43
<b>PRE-OPERATION CHECK</b> .....	16	<b>WIRING DIAGRAM</b>	
FUEL.....	16	EF4000DE .....	44
ENGINE OIL .....	17	EF5200DE .....	45
GROUND (Earth).....	18	EF6600DE .....	46
BATTERY .....	18	YG4000D .....	47
<b>OPERATION</b> .....	19	YG5200D .....	48
STARTING THE ENGINE.....	19	YG6600D .....	49
APPLICATION RANGE .....	21	YG6600DE.....	50
CONNECTION.....	22	<b>BATTERY TRAY INSTALLATION</b> .....	51
STOPPING THE ENGINE .....	24	<b>ENGINE HANGER INSTALLATION</b> .....	51
		<b>OPTIONAL PARTS INSTALLATION</b> .....	51

## YAMAHA MOTOR CORPORATION U.S.A. EF- AND EDL-SERIES GENERATOR LIMITED WARRANTY

Yamaha Motor Corporation, U.S.A. hereby warrants that new Yamaha consumer generators purchased from an authorized Yamaha consumer generator dealer in the continental United States will be free from defects in material and workmanship for the period of time stated herein, subject to certain stated limitations.

**THE PERIOD OF WARRANTY** Any new EF-series or EDL-series Yamaha Generator purchased for private, non-commercial use from an authorized Yamaha consumer generator dealer in the continental United States will be warranted against defects in material or workmanship for a period two (2) years from date of purchase, subject to exclusions noted herein. Any Yamaha non-commercial generator purchased and utilized for commercial or rental applications will be warranted for a period one (1) year from the date of purchase, subject to exclusions noted herein.

**DURING THE PERIOD OF WARRANTY** any authorized Yamaha consumer generator dealer will, free of charge, repair or replace, at Yamaha's option, any part adjudged defective by Yamaha due to faulty workmanship or material from the factory. Parts used in warranty repairs will be warranted for the balance of the product's warranty period. All parts replaced under warranty become property of Yamaha Motor Corporation U.S.A.

**GENERAL EXCLUSIONS** from this warranty shall include any failures caused by:

- a. Installation of parts or accessories that are not qualitatively equivalent to genuine Yamaha parts.
- b. Abnormal strain, neglect, or abuse.
- c. Lack of proper maintenance.
- d. Accident or collision damage.

**SPECIFIC EXCLUSIONS** from this warranty shall include parts replaced due to normal wear or routine maintenance.

**THE CUSTOMER'S RESPONSIBILITY** under this warranty shall be to:

1. Operate and maintain the generator as specified in the appropriate Owner's Manual;

2. Give notice to an authorized Yamaha consumer generator dealer of any and all apparent defects within ten (10) days after discovery, and make the unit available at that time for inspection and repairs at such dealer's place of business.

**WARRANTY TRANSFER:** To transfer the warranty from the original purchaser to any subsequent purchaser(s), it is imperative that the unit be inspected and registered for warranty by an authorized Yamaha consumer generator dealer. In order for this warranty to remain in effect, this inspection and registration must take place within ten (10) days after transfer. An inspection and registration fee will be charged for this service. In no case will the warranty be extended beyond the original period.

**YAMAHA MOTOR CORPORATION, U.S.A. MAKES NO OTHER WARRANTY OF ANY KIND, EXPRESSED OR IMPLIED. ALL IMPLIED WARRANTIES OF MERCHANTABILITY AND FITNESS FOR A PARTICULAR PURPOSE WHICH EXCEED THE OBLIGATIONS AND TIME LIMITS STATED IN THIS WARRANTY ARE HEREBY DISCLAIMED BY YAMAHA MOTOR CORPORATION, U.S.A. AND EXCLUDED FROM THIS WARRANTY.**

**SOME STATES DO NOT ALLOW LIMITATIONS ON HOW LONG AN IMPLIED WARRANTY LASTS, SO THE ABOVE LIMITATION MAY NOT APPLY TO YOU. ALSO EXCLUDED FROM THIS WARRANTY ARE ANY INCIDENTAL OR CONSEQUENTIAL DAMAGES INCLUDING LOSS OF USE. SOME STATES DO NOT ALLOW THE EXCLUSION OR LIMITATION OF INCIDENTAL OR CONSEQUENTIAL DAMAGES, SO THE ABOVE EXCLUSION MAY NOT APPLY TO YOU.**

**THIS WARRANTY GIVES YOU SPECIFIC LEGAL RIGHTS, AND YOU MAY ALSO HAVE OTHER RIGHTS WHICH VARY FROM STATE TO STATE.**

YAMAHA MOTOR CORPORATION, U.S.A.  
Post Office Box 6555  
Cypress, California 90630

**YAMAHA MOTOR CORPORATION U.S.A.  
EC- AND YG-SERIES INDUSTRIAL GENERATOR LIMITED WARRANTY**

Yamaha Motor Corporation, U.S.A. hereby warrants that new Yamaha EC- and YG-series generators purchased from an authorized Yamaha industrial generator dealer in the continental United States will be free from defects in material and workmanship for the period of time stated herein, subject to certain stated limitations.

**THE PERIOD OF WARRANTY** for Yamaha EC-series and YG-series generators shall be one (1) year from the date of purchase.

**DURING THE PERIOD OF WARRANTY** any authorized Yamaha industrial generator dealer will, free of charge, repair or replace, at Yamaha's option, any part adjudged defective by Yamaha due to faulty workmanship or material from the factory. Parts used in warranty repairs will be warranted for the balance of the product's warranty period. All parts replaced under warranty become property of Yamaha Motor Corporation U.S.A.

**GENERAL EXCLUSIONS** from this warranty shall include any failures caused by:

- a. Installation of parts or accessories that are not qualitatively equivalent to genuine Yamaha parts.
- b. Abnormal strain, neglect, or abuse.
- c. Lack of proper maintenance.
- d. Accident or collision damage.

**SPECIFIC EXCLUSIONS** from this warranty shall include parts replaced due to normal wear or routine maintenance.

**THE CUSTOMER'S RESPONSIBILITY** under this warranty shall be to:

1. Operate and maintain the diesel generator as specified in the appropriate Owner's Manual;
2. Give notice to an authorized Yamaha industrial generator dealer of any and all apparent defects within ten (10) days after discovery, and make the unit available at that time for inspection and repairs at such dealer's place of business.

**WARRANTY TRANSFER:** To transfer the warranty from the original purchaser to any subsequent purchaser(s), it is imperative that the unit be inspected and registered for warranty by an authorized Yamaha industrial generator dealer. In order for this warranty to remain in effect, this inspection and registration must take place within ten (10) days after transfer. An inspection and registration fee will be charged for this service. In no case will the warranty be extended beyond the original period.

**YAMAHA MOTOR CORPORATION, U.S.A. MAKES NO OTHER WARRANTY OF ANY KIND, EXPRESSED OR IMPLIED. ALL IMPLIED WARRANTIES OF MERCHANTABILITY AND FITNESS FOR A PARTICULAR PURPOSE WHICH EXCEED THE OBLIGATIONS AND TIME LIMITS STATED IN THIS WARRANTY ARE HEREBY DISCLAIMED BY YAMAHA MOTOR CORPORATION, U.S.A. AND EXCLUDED FROM THIS WARRANTY.**

**SOME STATES DO NOT ALLOW LIMITATIONS ON HOW LONG AN IMPLIED WARRANTY LASTS, SO THE ABOVE LIMITATION MAY NOT APPLY TO YOU. ALSO EXCLUDED FROM THIS WARRANTY ARE ANY INCIDENTAL OR CONSEQUENTIAL DAMAGES INCLUDING LOSS OF USE. SOME STATES DO NOT ALLOW THE EXCLUSION OR LIMITATION OF INCIDENTAL OR CONSEQUENTIAL DAMAGES, SO THE ABOVE EXCLUSION MAY NOT APPLY TO YOU.**

**THIS WARRANTY GIVES YOU SPECIFIC LEGAL RIGHTS, AND YOU MAY ALSO HAVE OTHER RIGHTS WHICH VARY FROM STATE TO STATE.**

YAMAHA MOTOR CORPORATION, U.S.A.  
Post Office Box 6555  
Cypress, California 90630

## WARRANTY QUESTIONS AND ANSWERS

Q. What costs are my responsibility during the warranty period?

A. The customer's responsibility includes all costs of normal maintenance service, non-warranty repairs, accident damages, as well as oil and spark plugs.

Q. What are some examples of "abnormal" strain, neglect, or abuse?

A. These terms are general and overlap each other in areas. Specific examples include: Running the machine out of oil; lack of proper maintenance; operating the machine with a broken or damaged part which causes another part to fail; and so on. If you have any specific questions on operation or maintenance, please contact your dealer for advice.

Q. Does the warranty cover incidental costs such as transportation due to a failure?

A. No. The warranty is limited to repair of the machine itself.

Q. May I perform any or all of the recommended maintenance shown in the Owner's Manual instead of having the dealer do them?

A. Yes, if you are a qualified mechanic and follow the procedures specified in the Owner's and Service Manual. We do recommend, however, that items requiring special tools or equipment be done by a Yamaha generator dealer.

Q. Will the warranty be void or cancelled if I do not operate or maintain my new Yamaha exactly as specified in the Owner's Manual?

A. No. The warranty on a new Yamaha cannot be "voided" or "cancelled."

**However, if a particular failure is caused by operation or maintenance other than as shown in the Owner's Manual, that failure may not be covered under warranty.**

Q. What responsibility does my dealer have under this warranty?

A. Each Yamaha generator dealer is expected to:

1. Check the operation of the generator before sale.
2. Explain the operation, maintenance, and warranty requirements to your satisfaction at the time of sale, and upon your request at any later date.

In addition, each Yamaha generator dealer is held responsible for his setup, service and warranty repair work.

Q. Is the warranty transferable to second owners?

A. Yes. The remainder of the existing warranty can be transferred upon request. The unit has to be inspected and reregistered by an authorized Yamaha generator dealer for the policy to remain effective.

### CUSTOMER SERVICE

If your machine requires warranty service, you must take it to any authorized Yamaha generator dealer within the continental United States. Be sure to bring your warranty registration identification or other valid proof of the original date of purchase. If a question or problem arises regarding warranty, first contact the owner of the dealership. Since all warranty matters are handled at the dealer level, this person is in the best position to help you. If you are still not satisfied and require additional assistance, please write:

YAMAHA MOTOR CORPORATION U.S.A. CUSTOMER RELATIONS DEPARTMENT  
P.O. BOX 6555  
Cypress, California 90630

### CHANGE OF ADDRESS

The federal government requires each manufacturer to maintain a complete, up-to-date list of all first purchasers against the possibility of a safety-related defect and recall. This list is compiled from the purchase registrations sent to Yamaha Motor Corporation, U.S.A. by the selling dealer at the time of your purchase. If you should move after you have purchased your new generator, please advise us of your new address by sending a postcard listing your Yamaha model name, engine number, dealer number (or dealer's name) as it is shown on your warranty identification, your name and new mailing address. Mail to:

YAMAHA MOTOR CORPORATION, U.S.A.  
WARRANTY DEPARTMENT  
P.O. Box 6555  
Cypress, California 90630

This will ensure that Yamaha Motor Corporation, U.S.A. has an up-to-date registration record in accordance with federal law.



# LOCATION OF IMPORTANT LABELS (For EF4000DE/YG4000D)

Please read the following labels carefully before operating this machine.

**NOTE:** \_\_\_\_\_

Maintain or replace safety and instruction labels, as necessary.

\_\_\_\_\_

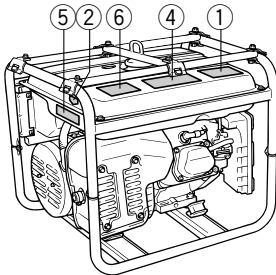
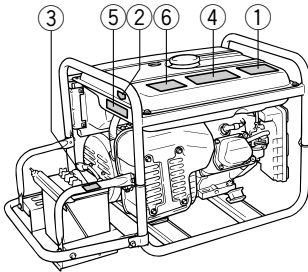

①

## WARNING

Electrocution Or property damage can occur: Do not connect this generator to any building's electrical system unless an isolation switch has been installed by a licensed electrician. Refer to the owner's manual.

②

## HOT EXHAUST

③

WARNING  
**HOT AREA**  
DO NOT TOUCH

④

<p style="text-align: center;"><b>⚠ WARNING</b></p> <ul style="list-style-type: none"> <li>● READ THE OWNER'S MANUAL AND ALL LABELS BEFORE OPERATING.</li> <li>● ONLY OPERATE IN WELL-VENTILATED AREA.</li> <li>● EXHAUST GAS CONTAINS POISONOUS CARBON MONOXIDE.</li> <li>● CHECK FOR SPILLED FUEL OR FUEL LEAKS.</li> <li>● STOP ENGINE BEFORE REFUELING.</li> <li>● DO NOT OPERATE NEAR FLAMMABLE MATERIALS.</li> <li>● ELECTROCUTION CAN OCCUR IF GENERATOR IS USED IN RAIN, SNOW, OR NEAR WATER. KEEP THIS UNIT DRY AT ALL TIMES.</li> </ul>	<p style="text-align: center;"><b>⚠ AVERTISSEMENT</b></p> <ul style="list-style-type: none"> <li>● LISEZ LE MODE D'EMPOI ET TOUTES LES ETIQUETTES AVANT DE FAIRE FONCTIONNER LA MACHINE.</li> <li>● FAITES FONCTIONNER UNIQUEMENT DANS DES LIEUX BIEN AERES. LES GAZ D'ECHAPPEMENT CONTIENNENT DU MONOXYDE DE CARBONE.</li> <li>● VERIFIEZ SI DU CARBURANT A ETE RENVERSE DU S'IL FUT.</li> <li>● ARRETEZ LE MOTEUR AVANT DE FAIRE LE PLEIN DE CARBURANT.</li> <li>● N'UTILISEZ PAS A PROXIMITE DE MATERIAUX INFLAMMABLES.</li> <li>● IL Y A RISQUE D'ELECTROCUTION SI LE GENERATEUR FONCTIONNE SOUS LA PLUIE, DANS LA NEIGE, OU PRES DE L'EAU. GARDEZ LA MACHINE AU SEC EN TOUTES CIRCONSTANCES.</li> </ul> <p style="text-align: right; font-size: small;">7NJ-24162-10</p>
---	---

⑤

<b>IMPORTANT ENGINE INFORMATION</b>		<b>YAMAHA</b>	
ENGINE FAMILY : *****		DISPLACEMENT: *** cil	
REFER TO OWNER'S MANUAL FOR MAINTENANCE SPECIFICATIONS AND ADJUSTMENTS.		VALVE LASH (mm) IN: ***-0.*** EX: ***-0.***	
THIS ENGINE MEETS ****-**** CALIFORNIA EMISSION REGULATIONS FOR SMALL OFF-ROAD ENGINES.		IGNITION TIMING & IDLE MIXTURE NO OTHER ADJUSTMENTS NEEDED.	
THIS ENGINE CONFORMS TO PHASE 2 U.S.EPA EMISSION REGULATIONS FOR SMALL NONROAD ENGINES.		IDLE SPEED: *****-***** rpm AT NO LOAD	
EMISSIONS COMPLIANCE PERIOD: CATEGORY A (EPA)		FUEL: THIS ENGINE IS CERTIFIED TO OPERATE ON UNLEADED GASOLINE.	
YAMAHA MOTOR CO. LTD ***-2179R-***		ENGINE OIL: SAE 10W-30 TYPE SE	

⑥

ENGINE AIR INDEX (California only)

0 2 4 6 8 10

MOST CLEAN LEAST CLEAN

NOTE: THE LOWER THE AIR INDEX, THE LESS THE POLLUTION  
THIS ENGINE IS CERTIFIED TO BE EMISSION COMPLIANT FOR THE FOLLOWING USE:

MODERATE       INTERMEDIATE       EXTENDED  
 CHECK OWNERS MANUAL FOR FURTHER DETAILS  
 THIS LABEL TO BE REMOVED BY THE ULTIMATE PURCHASER ONLY!



AE00071

## SAFETY INFORMATION

AE00072

### EXHAUST FUMES ARE POISONOUS

- Never operate the engine in a closed area or it may cause unconsciousness and death within a short time. Operate the engine in a well ventilated area.

AE00075

### FUEL IS HIGHLY FLAMMABLE AND POISONOUS

- Always turn off the engine when refuelling.
- Never refuel while smoking or in the vicinity of an open flame.
- Take care not to spill any fuel on the engine or muffler when refuelling.
- If you swallow any fuel, inhale fuel vapor, or allow any to get in your eye(s), see your doctor immediately. If any fuel spills on your skin or clothing, immediately wash with soap and water and change your clothes.
- When operating or transporting the machine, be sure it is kept upright. If it tilts, fuel may leak from the carburetor or fuel tank.

AE00843

### ENGINE AND MUFFLER MAY BE HOT

- Place the machine in a place where pedestrians or children are not likely to touch the machine.
- Avoid placing any flammable materials near the exhaust outlet during operation.

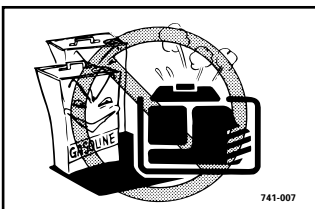
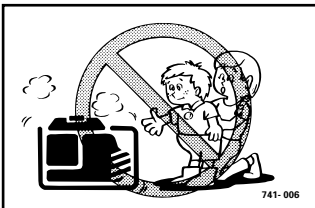
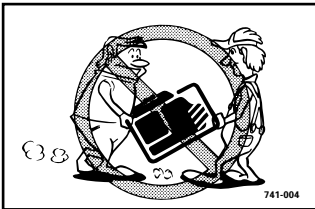
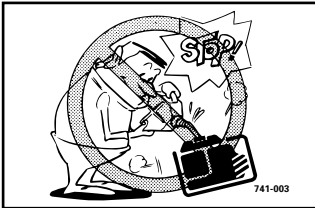
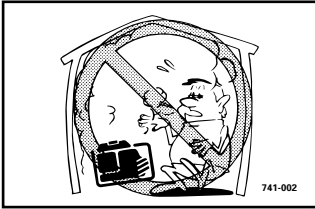

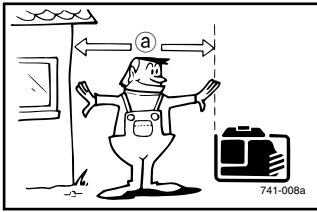

- Keep the machine at least 1 m (3 ft) from buildings or other equipment, or the engine may overheat.

Ⓐ 1 m (3 ft)

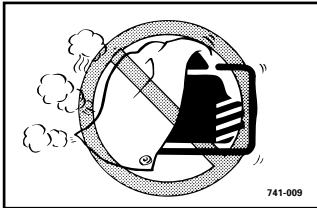

- Avoid operating the engine with a dust cover.

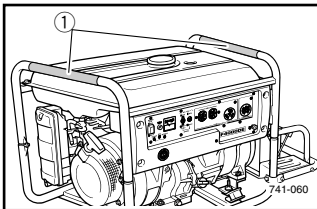

- Be sure to carry the generator only by its carrying handle(s).

① Carrying handle(s) (shaded)

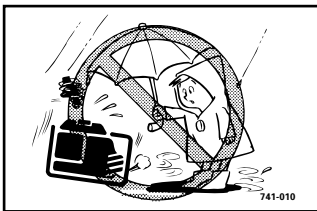

AE00083

### ELECTRIC SHOCK PREVENTION

- Never operate the engine in rain or snow.

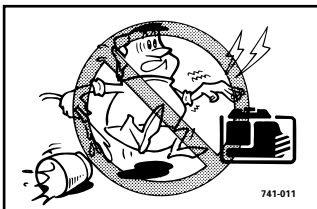

- Never touch the machine with wet hands or electrical shock will occur.

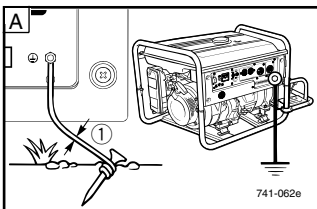

- Be sure to ground (earth) the generator.

### NOTE:

Use ground (earth) lead of sufficient current capacity.

① Lead diameter

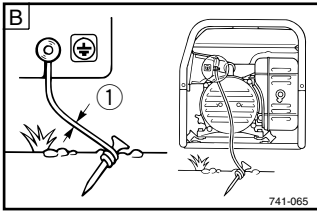

Ground (earth) Lead  
 Diameter:  
 0.12 mm (0.005 in)/ampere  
 EX;  
 10 Ampere → 1.2mm (0.05 in)

- A EF4000DE/YG4000D
- B EF5200DE/EF6600DE/YG5200D/YG6600D/YG6600DE

AE00088

**CONNECTION NOTES**

- Avoid connecting the generator to commercial power outlet.
- Avoid connecting the generator in parallel with any other generator.

- ① Correct
- ② Incorrect

AE00091

**CONNECTION**

**⚠ WARNING**

Before the generator can be connected to a building's electrical system, a licensed electrician must install an isolation (transfer) switch in the building's main fuse box. The switch is the connection point for generator power and allows selection of generator or main line power to the building. This will prevent the generator from charging the main power line (backfeeding) when the main power supply has failed or has been turned off for line repair. Backfeeding can electrocute or injure line maintenance personnel. Also, generator and building electrical system damage can occur when normal operating power returns if unit is used without an isolation switch.

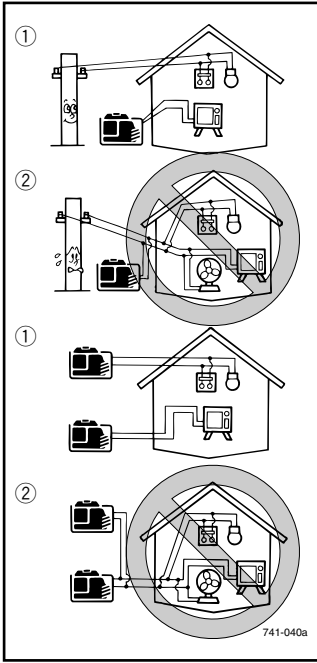

AE00086

**EXTENSION CORD NOTES**

- When using an extension cord, its total length should not exceed
  - { 60 meters for cross section of 1.5 mm square
  - and
  - { 100 meters for cross section of 2.5 mm square.
- This extension cord should be protected by a tough flexible rubber sheath (IEC 245) or the equivalent to withstand mechanical stresses.

## EF4000DE

AE00101

## CONTROL FUNCTION

AE00102

### DESCRIPTION

(for EF4000DE/EF5200DE/EF6600DE)

- ① Fuel tank
- ② Fuel tank cap
- ③ Fuel cock
- ④ Air filter cover
- ⑤ Spark plug
- ⑥ Muffler
- ⑦ Ground (Earth) terminal
- ⑧ Oil filler cap
- ⑨ Oil drain plug
- ⑩ Recoil starter
- ⑪ Voltage adjuster (for EF5200DE/EF6600DE)
- ⑫ Fuel level gauge
- ⑬ Carrying handles (shaded)

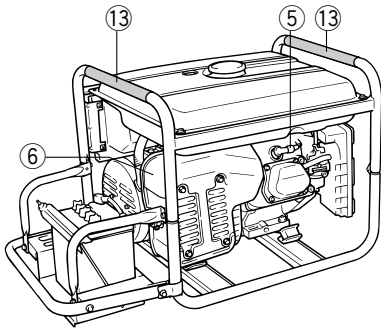
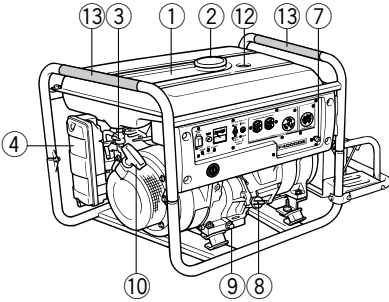

## EF5200DE/EF6600DE

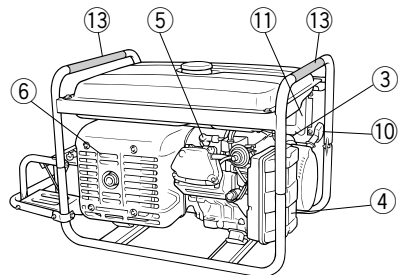
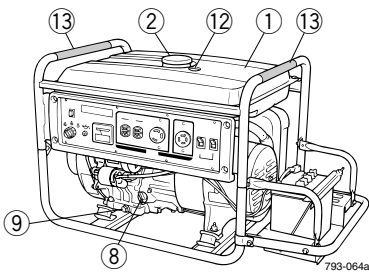

## YG4000D

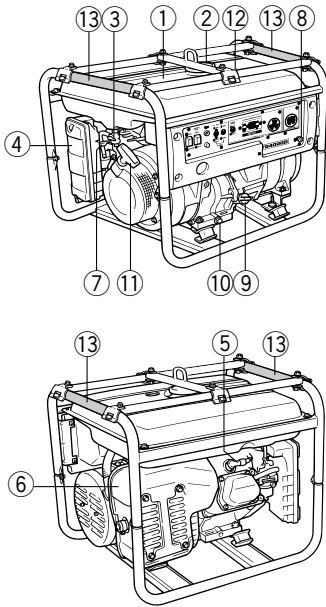

AE00102

## DESCRIPTION

(for YG4000D/YG5200D/YG6600D/  
YG6600DE)

- ① Fuel tank
- ② Fuel tank cap
- ③ Fuel cock
- ④ Air filter cover
- ⑤ Spark plug
- ⑥ Muffler
- ⑦ Choke lever (for YG4000D/YG5200D/YG6600D)
- ⑧ Ground (Earth) terminal
- ⑨ Oil filler cap
- ⑩ Oil drain plug
- ⑪ Recoil starter
- ⑫ Fuel level gauge
- ⑬ Carrying handles (shaded)

## YG5200D/YG6600D

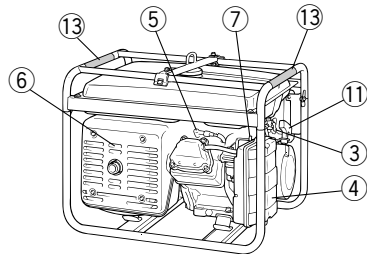
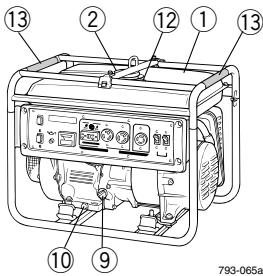

## YG6600DE

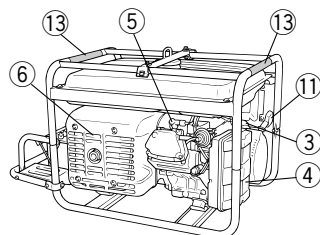
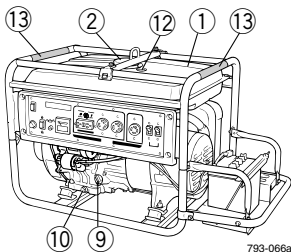

## EF4000DE

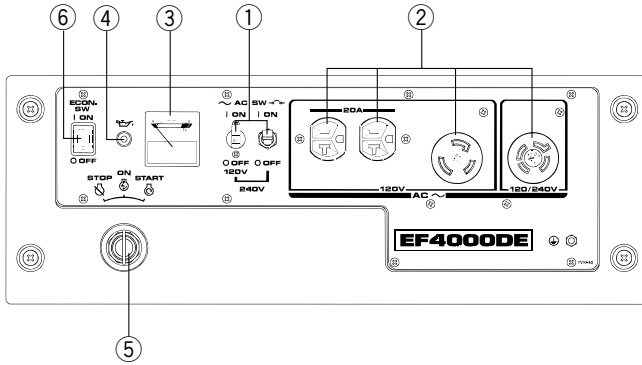

AE00104

## CONTROL BOX (for EF4000DE/ EF5200DE/EF6600DE)

- ① AC switch (N.F.B.)
- ② AC receptacle
- ③ Voltage meter
- ④ Oil warning light
- ⑤ Engine switch
- ⑥ Economy idle switch

## EF5200DE

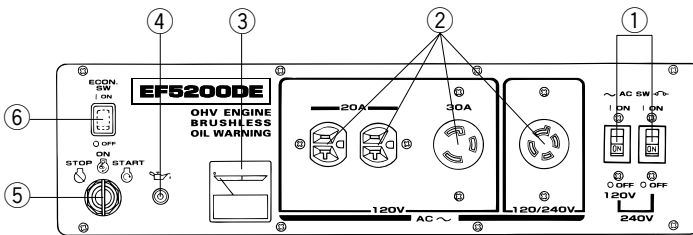

## EF6600DE

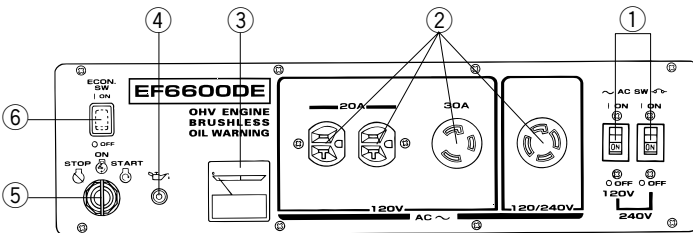

793-067



## YG4000D

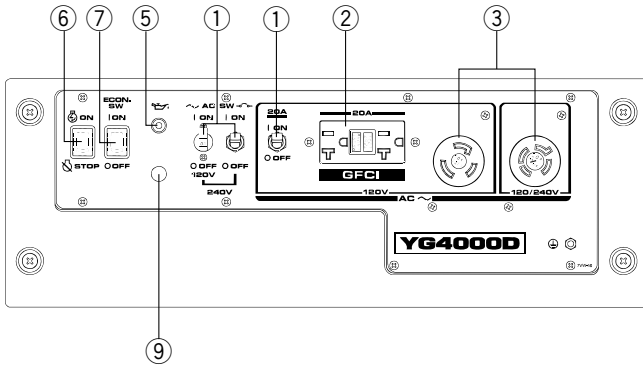

AE00104

## CONTROL BOX (for YG4000D/ YG5200D/YG6600D/ YG6600DE)

- ① AC switch (N.F.B.)
- ② G.F.C.I. receptacle
- ③ AC receptacle
- ④ Voltage meter  
(for YG5200D/  
YG6600D/YG6600DE)
- ⑤ Oil warning light
- ⑥ Engine switch
- ⑦ Economy idle switch
- ⑧ Starter switch  
(for YG6600DE)
- ⑨ Pilot light  
(for YG4000D)

## YG5200D

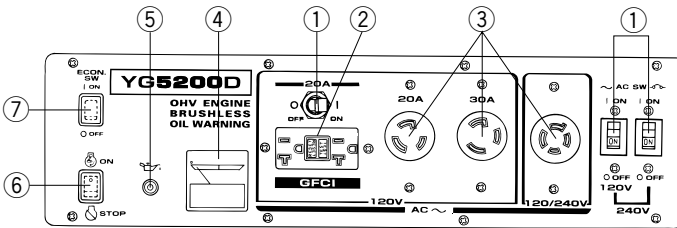

## YG6600D

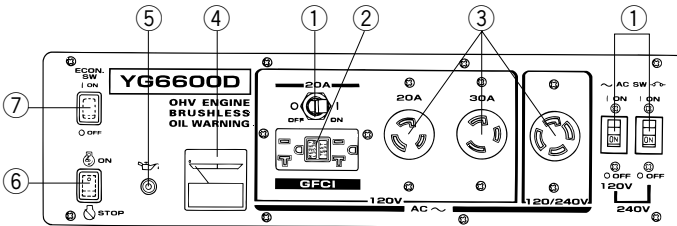

793-068

## YG6600DE

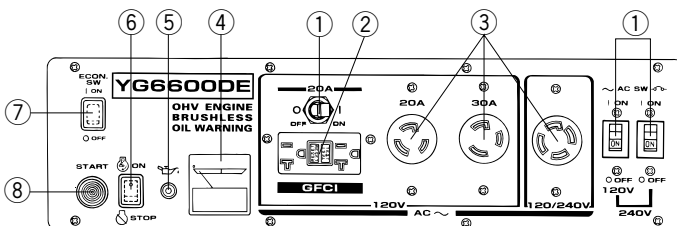

793-069

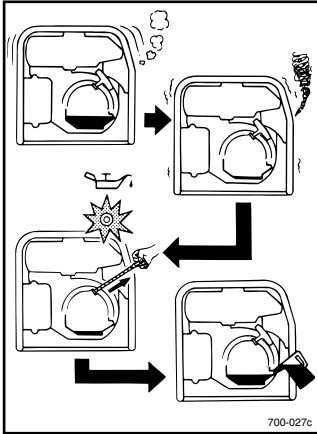

AE00111

## OIL WARNING SYSTEM

When the oil level falls below the lower level, the engine stops automatically. Unless you refill with oil, the engine will not start again.

### NOTE:

If the engine stalls or does not start, turn the engine switch to "ON" position and then pull the recoil starter. If the oil warning light flickers for a few seconds, the engine oil is insufficient. Add oil and restart.

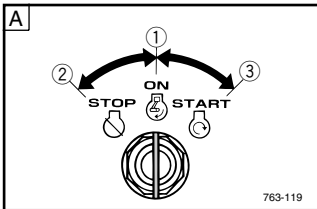

AE00121

## ENGINE SWITCH

The engine switch controls the ignition system.

① "ON"

Ignition circuit is switched on.

The engine can be started.

② "STOP"

Ignition circuit is switched off.

The engine will not run.

③ "START"

Starting circuit is switched on.

The starter motor starts.

**A** EF4000DE/EF5200DE/EF6600DE

**B** YG4000D/YG5200D/YG6600D/YG6600DE

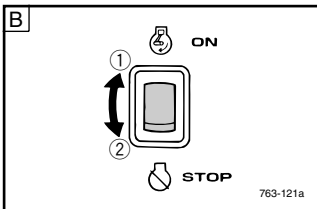

### CAUTION:

**Take your hand off the switch immediately after the engine starts.**

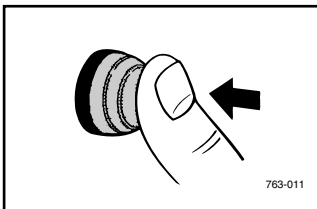

AE00920

## STARTER SWITCH (for YG6600DE)

The starter switch controls the following item.

Push:

Starting circuit is switched on.

Release:

Starting circuit is switched off.

### CAUTION:

**Take your hand off the switch immediately after the engine starts.**

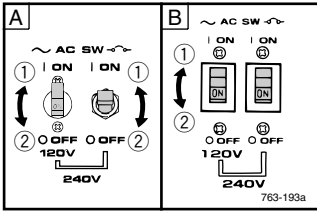

AE00863

### AC SWITCH (N.F.B.)

The AC switch (Non-Fuse Breaker) turns off automatically when the load exceeds the generator rated output.

- ① | "ON"
- ② ○ "OFF"

[A] EF4000DE/YG4000D

[B] EF5200DE/EF6600DE/YG5200D/YG6600D/YG6600DE

[C-1] Supplies AC 120V (EF4000DE/YG4000D)

[C-2] Supplies AC 120V (EF5200DE/EF6600DE/YG5200D/YG6600D/YG6600DE)

[D-1] Supplies AC 120V and 240V (EF4000DE/YG4000D)

[D-2] Supplies AC 120V and 240V (EF5200DE/EF6600DE/YG5200D/YG6600D/YG6600DE)

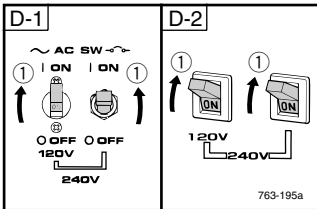
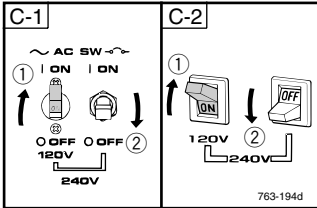

### CAUTION:

Reduce the load to the specified generator rated output if the AC switch (N.F.B.) turns off. If it turns off again, consult a Yamaha dealer.

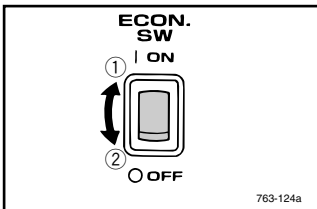

AE00142

### ECONOMY IDLE SWITCH

When the economy idle switch is turned to "ON", the engine speed is automatically reduced to idle when the generator load is reduced to 0.8 A or less. The results are better fuel consumption and less noise.

- ① | "ON"
- ② ○ "OFF"

### NOTE:

The economy idle switch must be turned to "OFF" to increase engine speed to rated rpm when:

- using a load of 0.8 A or less.
- supplying AC 120V only from W with X.

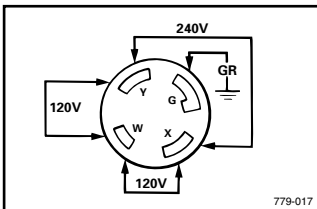

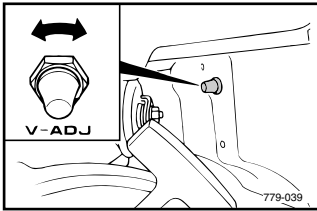

AE00791

### VOLTAGE ADJUSTER (for EF5200DE/EF6600DE)

The adjuster is equipped for adjusting output voltage to rated voltage.

#### NOTE:

Turn the adjuster clockwise or counterclockwise to increase or decrease output voltage.

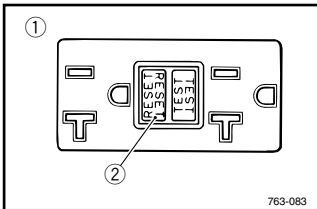
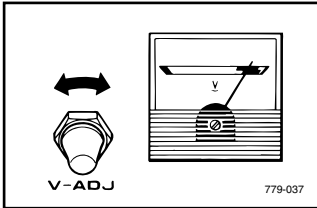

AE00848

### G.F.C.I. RECEPTACLE (for YG4000D/YG5200D/YG6600D/YG6600DE)

The G.F.C.I. (Ground Fault Circuit Interrupter) ① shuts off power to the protected receptacles if a ground fault (electrical leak) is detected.

If the reset button ② pops out ③, the equipment plugged into the receptacle may be faulty. If this happens, check the equipment carefully. If the equipment appears to be in good condition, press the reset button firmly until a click is heard. This will restore power. If the reset button pops out again, unplug the equipment immediately. Have the equipment inspected and repaired by a qualified repairperson before attempting to use it again.

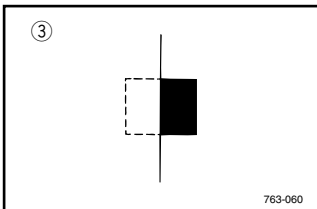

#### **⚠ WARNING**

#### TO REDUCE THE CHANCE OF ELECTRICAL SHOCK:

- Do not attempt to operate equipment if the ground fault circuit interrupter reset button pops out repeatedly during use.
- Test the ground fault circuit interrupter during the pre-operation checks according to the maintenance instructions on page 35.
- Remember that only receptacles labeled "GFCI" have ground fault circuit interrupter protection.

## PRE-OPERATION CHECK

**NOTE:** \_\_\_\_\_

Pre-operation checks should be made each time the generator is used.

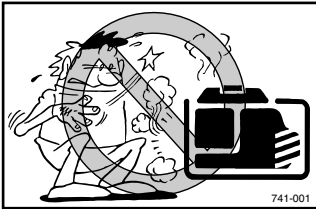

**WARNING** \_\_\_\_\_

The engine and muffler will be very hot after the engine has been run.

**Avoid touching the engine and muffler while they are still hot with any part of your body or clothing during inspection or repair.**

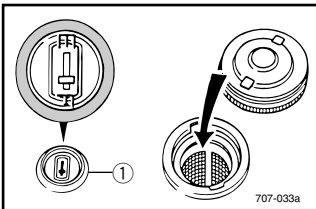

### FUEL

Make sure there is sufficient fuel in the tank.

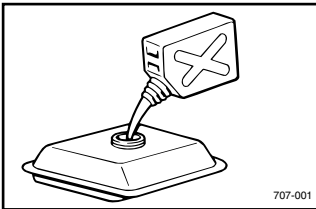

Recommended fuel:

Unleaded gasoline

Fuel tank capacity:

Total:

EF4000DE/YG4000D:

18.5 L (4.07 Imp gal, 4.89 US gal)

EF5200DE/EF6600DE/YG5200D/YG6600D/

YG6600DE:

21.0 L (4.62 Imp gal, 5.55 US gal)

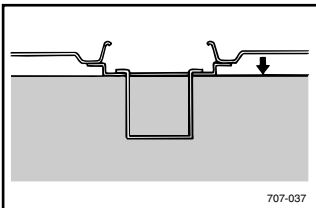

Your Yamaha engine has been designed to use regular unleaded gasoline with a pump octane number ((R + M)/2) of 86 or higher, or research octane number of 91 or higher.

① Fuel level gauge

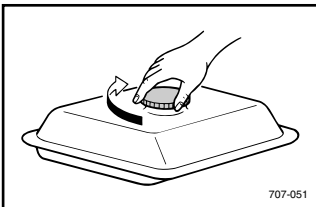

"F"	Full
"E"	Empty

## **⚠ WARNING**

- Fuel is highly flammable and poisonous. Check “SAFETY INFORMATION” (See page 6) carefully before refueling.
- Do not fill above the top of the fuel filter or it may overflow when the fuel heats up later and expands.
- Wipe up any spilled fuel immediately.
- After refueling, make sure the tank cap is tightened securely.

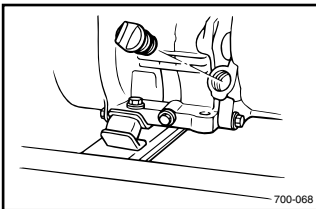

AE00222

### **ENGINE OIL**

Make sure the engine oil is at the upper level of the oil filler hole.

Add oil as necessary.

- ① Upper level

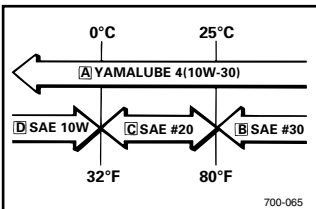
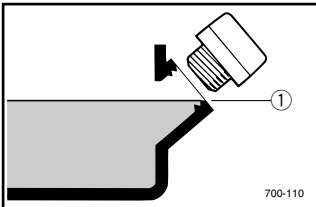

Recommended oil:

- [A] YAMALUBE 4 (10W-30) or SAE 10W-30 type SE motor oil
- [B] SAE #30
- [C] SAE #20
- [D] SAE 10W

Engine oil quantity:

EF4000DE/YG4000D:

1.0 L (0.88 Imp qt, 1.06 US qt)

EF5200DE/EF6600DE/YG5200D/YG6600D/

YG6600DE:

1.1 L (0.97 Imp qt, 1.16 US qt)

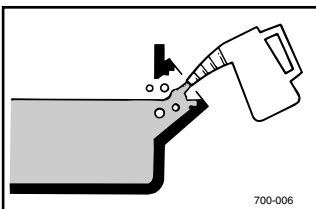

### **NOTE:**

Recommended engine oil classification:

API Service “SE” or “SF”.

### **CAUTION:**

**The generator has been shipped without engine oil. Fill with oil or it will not start.**

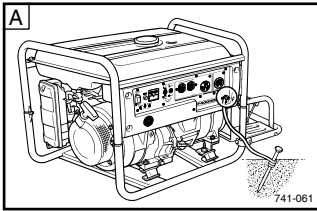

AE00241

## GROUND (Earth)

Make sure to ground (earth) the generator.  
Check "SAFETY INFORMATION" on page 7.

**A** EF4000DE/YG4000D

**B** EF5200DE/EF6600DE/YG5200D/YG6600D/YG6600DE

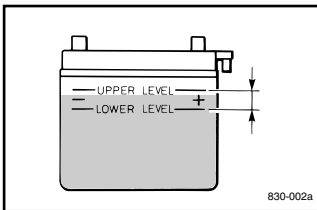
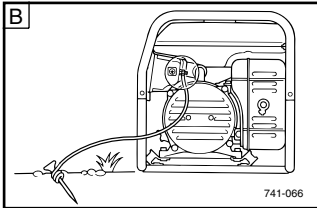

AE00231

## BATTERY

(for EF4000DE/EF5200DE/EF6600DE/YG6600DE)

(See page 34 for more details)

Check the fluid level and fill if necessary.

Use only distilled water if refilling is necessary.

### Installation

1. Turn the engine switch to the "STOP" position to prevent accidental short circuiting.
2. Install the battery on the battery mount tray securely.

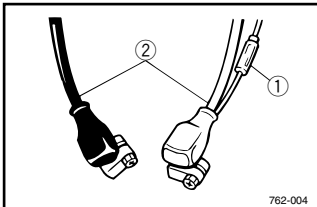

### NOTE:

Clamp the red wire to the positive (+) terminal first, then the black wire to the negative (-) terminal of the battery. Do not reverse these positions.

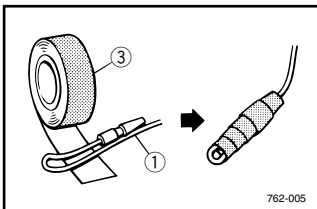

## **⚠ WARNING**

Be sure to service battery leads to prevent arcing when the battery is not installed.

- Disconnect the battery charging output lead. Then insulate the generator side connector by folding it back on itself and carefully wrapping it with electrical tape to prevent electrical contact with ground (earth) or any other leads.
- Remove the battery leads from the generator.

① Connector

② Battery leads

③ Electrical tape

AE00955

## OPERATION

### NOTE:

The generator has been shipped without engine oil. Fill with oil or it will not start.

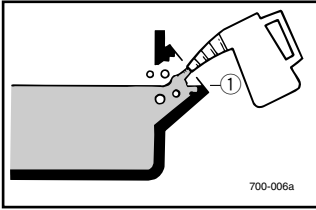

① Upper level

AE00918

## STARTING THE ENGINE

### NOTE:

- Before starting the engine, do not connect any electric devices.
- Turn the AC switch (N.F.B.) and economy idle switch to the "OFF" position.

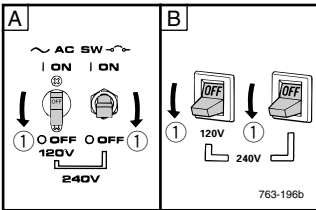
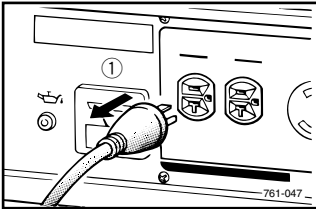

① ○ "OFF"

A AC switch (N.F.B.) for EF4000DE/YG4000D

B AC switch (N.F.B.) for EF5200DE/EF6600DE/YG5200D/YG6600D/YG6600DE

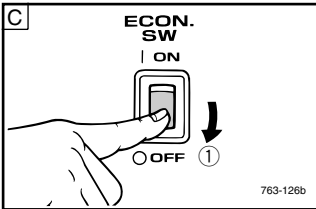

C Economy idle switch

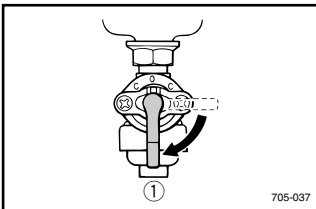

1. Turn the fuel cock lever to the "ON" position.

① "ON"

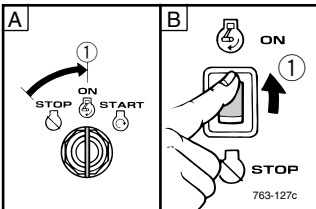

2. Turn the engine switch to the "ON" position.

① Ⓜ "ON"

A EF4000DE/EF5200DE/EF6600DE

B YG4000D/YG5200D/YG6600D/YG6600DE



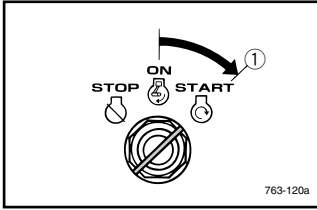

**Electric Starting Model:  
(for EF4000DE/EF5200DE/EF6600DE)**

3. Turn the engine switch to "START".

① "START"

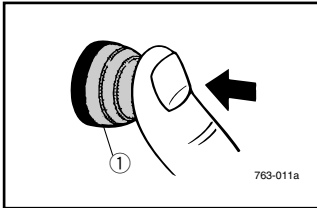

**(for YG6600DE)**

3. Push the starter switch to start the engine.

① Starter switch

**CAUTION:** \_\_\_\_\_

- Take your hand off the switch immediately after the engine starts.
- If the engine fails to start, release the switch, wait a few seconds, then try again. Each attempt should be as short as possible to preserve the battery. Do not crank the engine more than 10 seconds on any one attempt.

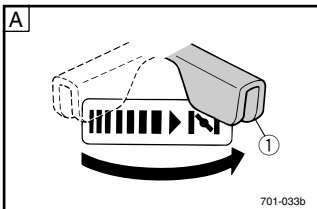

**Manual Starting Model:**

**(for YG4000D/YG5200D/YG6600D)**

3. Turn the choke lever to the "1" position.

① Choke lever

A YG4000D

B YG5200D/YG6600D

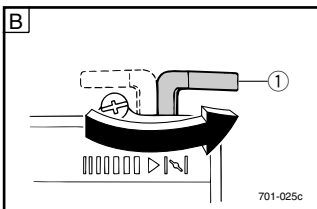

**NOTE:** \_\_\_\_\_

The choke is not required to start a warm engine. Turn the choke lever to the operating position.

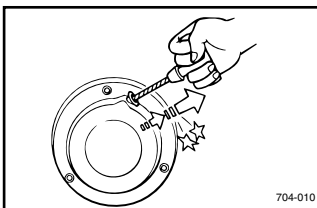

4. Pull slowly on the recoil starter until it is engaged, then pull it briskly.
5. After the engine starts, warm up the engine until the engine does not stop when the choke lever is returned to the operating position.

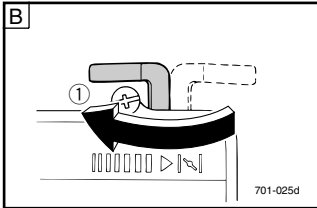
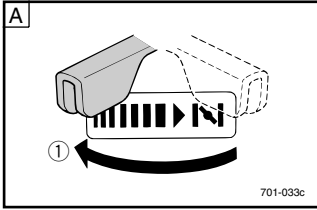

**NOTE:** \_\_\_\_\_

Especially in areas below freezing point, keep the choke lever at the halfway position until the engine is warmed up.

6. When the engine is warm, turn the choke lever back to the operating position (fully to the left).



① Operating position

**A** YG4000D

**B** YG5200D/YG6600D

AE00970

**APPLICATION RANGE**

AC			
Power factor	1	0.8–0.95	0.4–0.75 (Efficiency 0.85)
EF4000DE/YG4000D	–3,500W	–2,800W	–1,190W
EF5200DE/YG5200D	–4,500W	–3,600W	–1,530W
EF6600DE YG6600D YG6600DE	–6,000W	–4,800W	–2,040W

**NOTE:** \_\_\_\_\_

- “\_” means below.
- Application wattage indicates when each device is used by itself.

**CAUTION:** \_\_\_\_\_

**Be sure the total load is within generator rated output otherwise generator damage will occur.**

**NOTE:** \_\_\_\_\_

Some precision equipment is voltage sensitive and may require a more uniform voltage supply than portable generators provide. Examples include some medical equipment, personal computers, and some inverters that sense peak and RMS voltage values. Consult the precision-equipment vendor before relying on any portable generator to provide power to such equipment.

## CONNECTION

### Alternating Current (AC)

#### CAUTION:

- Be sure all electric devices including the lines and plug connections are in good condition before connection to the generator.
- Be sure any electric devices are turned off before plugging it in.
- Be sure the total load is within generator rated output.
- Be sure the receptacle load current is within receptacle rated current.

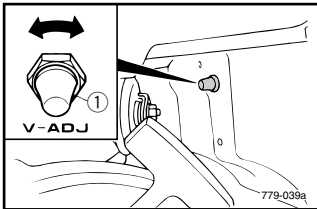
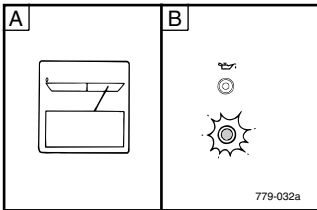
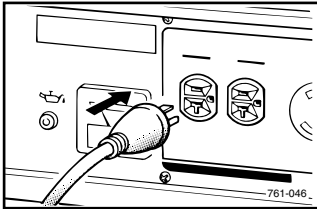
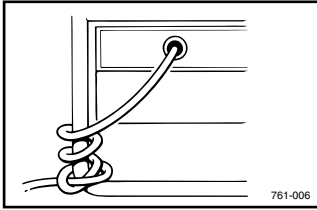

1. Wind the power lead 2 or 3 turns around frame.
2. Start the engine.
3. Plug into AC receptacle.
4. Make sure the voltage meter indicates the rated voltage (except for YG4000D) or the pilot light is on (for YG4000D).

- [A] Voltage meter  
[B] Pilot light

If the voltage meter does not indicate the rated voltage, adjust output voltage to rated voltage (for EF5200DE/EF6600DE).

- ① Voltage adjuster

#### NOTE:

Turn the adjuster clockwise or counterclockwise to increase or decrease output voltage.

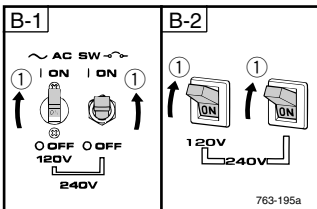
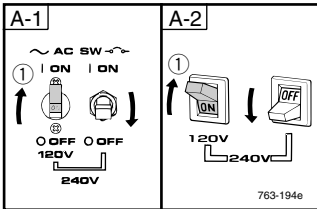

5. Turn the AC switch (N.F.B.) and economy idle switch to the "ON" and turn on any electric devices.

- ① | "ON"

[A-1] AC120V can be used. (EF4000DE/YG4000D)

[A-2] AC120V can be used. (EF5200DE/EF6600DE/  
YG5200D/YG6600D/YG6600DE)

[B-1] AC120V and 240V can be used. (EF4000DE/YG4000D)

[B-1] AC120V and 240V can be used. (EF5200DE/  
EF6600DE/YG5200D/YG6600D/YG6600DE)

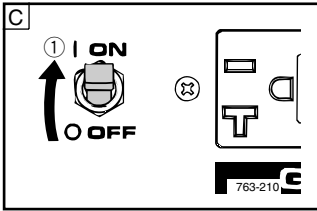

For YG4000D, YG5200D and YG6600D(E), also turn the individual AC switch (N.F.B.) to the “ON” position.

① | “ON”

Ⓒ | Individual AC switch (YG4000D)

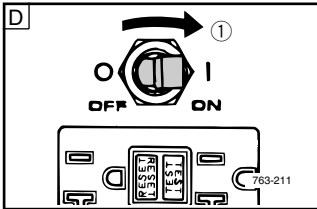

Ⓓ | Individual AC switch (YG5200D and YG6600D(E))

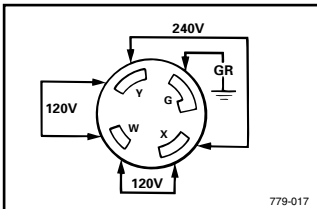

**CAUTION:** \_\_\_\_\_

**Reduce the load to the specified generator rated output if an AC switch turns off. If it turns off again, consult a Yamaha dealer.**

**NOTE:** \_\_\_\_\_

- The 4-blade plug receptacle can supply both 120V and 240V power sources.
- The economy idle switch must be turned to “OFF” to increase engine speed to rated rpm when:
  - using a load of 0.8A or less.
  - supplying AC120V only from W with X.

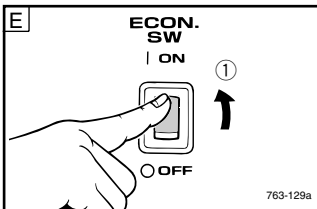

Ⓔ | Economy idle switch

① | “ON”

## STOPPING THE ENGINE

### NOTE:

- Turn off any electric devices.
- Turn the AC switch (N.F.B.) and economy idle switch to the “OFF” position.

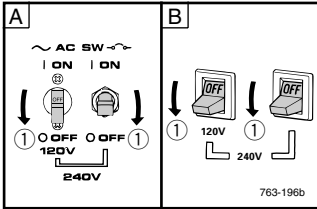

① ○ “OFF”

A AC switch (N.F.B.) (for EF4000DE/YG4000D)

B AC switch (N.F.B.) (for EF5200DE/EF6600DE/YG5200D/YG6600D/YG6600DE)

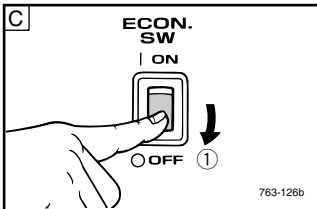

C Economy idle switch

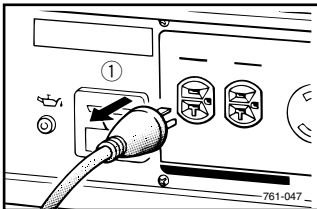

1. Disconnect any electric devices.

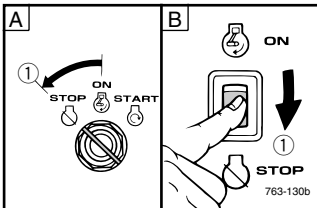

2. Turn the engine switch to the “STOP” position.

① ⏻ “STOP”

A EF4000DE/EF5200DE/EF6600DE

B YG4000D/YG5200D/YG6600D/YG6600DE

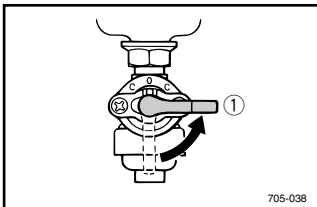

3. Turn the fuel cock lever to “OFF”.

① “OFF”

# PERIODIC MAINTENANCE

## MAINTENANCE CHART

Regular maintenance is most important for best performance and safe operation.

### **⚠ WARNING**

**Stop the engine before starting maintenance work.**

No.	Item	Remarks	Pre-Operation check (daily)	Initial	Every		
				1 month or 20 Hr	3 months or 50 Hr	6 months or 100 Hr	12 months or 300 Hr
1.	** Spark Plug	Check condition. Adjust gap and clean. Replace if necessary.			●		
2.*	** Valve Clearance	Check and adjust when engine is cold.					●
3.*	** Crankcase breather system	Check breather hose for cracks or damage. Replace if necessary.					●
4.*	** Idle speed	Check and adjust engine idle speed.					●
5.	** Exhaust System	Check for leakage. Retighten or *replace gasket if necessary.	●				
		Check muffler screen and spark arrester. Clean/replace if necessary.					●
6.	Engine Oil	Check oil level	●				
		Replace		●		●	
7.	** Air Filter	Clean. Replace if necessary.			●		
8.	Fuel Filter	Clean fuel cock and fuel tank filter. Replace if necessary.				●	

\* : It is recommended that these items be serviced by a Yamaha dealer.

\*\* : Related to emission control system.

No.	Item	Remarks	Pre-Operation check (daily)	Initial	Every		
				1 month or 20 Hr	3 months or 50 Hr	6 months or 100 Hr	12 months or 300 Hr
9.	Fuel Line	Check fuel hose for crack or damage. *Replace if necessary.	●				
10.	**Choke lever (for YG4000D YG5200D YG6600D)	Check choke operation.	●				
11.	Cooling System	Check for fan damage.					●
12.	Starting System	Check recoil starter operation.	●				
13.*	**Decarbonization	More frequently if necessary.					●
14.	Generation	Check the voltage meter indication or pilot light.	●				
15.	G.F.C.I. receptacle (for YG4000D YG5200D YG6600D YG6600DE)	Check operation *Repair if necessary.	●				
16*	Fittings/ Fasteners	Check all fittings and fasteners. Correct if necessary.				●	
17.	Battery (for EF4000DE EF5200DE EF6600DE YG6600DE)	Check battery fluid level. Add distilled water.			●		
		*Check specific gravity and breather pipe operation. Correct if necessary.					●

\* : It is recommended that these items be serviced by a Yamaha dealer.

\*\* : Related to emission control system.

### CAUTION:

**Use only Yamaha specified genuine parts for replacement. Ask an authorized Yamaha dealer for further attention.**

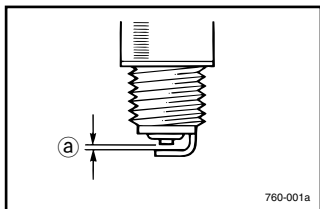
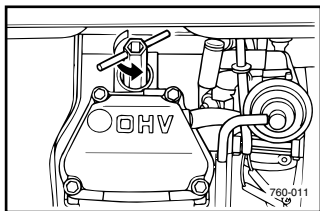

AE00971

## SPARK PLUG INSPECTION

You should periodically remove and inspect the spark plug.

1. Check for discoloration and remove the carbon.

Standard electrode color:  
Tan Color

2. Check the spark plug type and gap.

Standard Spark Plug:  
BPR4ES (NGK)  
Spark Plug Gap:  
0.7–0.8 mm (0.028–0.031 in)

Ⓐ Gap

3. Install the spark plug.

Spark Plug Torque:  
20 N•m (2 kgf•m, 14 lbf•ft)

AE00431

## CARBURETOR ADJUSTMENT

The carburetor is a vital part of the engine. Adjusting should be left to a Yamaha dealer with the professional knowledge, specialized data, and equipment to do so properly.



## ENGINE OIL REPLACEMENT

1. Place the machine on a level surface and warm up the engine for several minutes. Then stop the engine.
2. Remove the oil filler cap.
3. Place an oil pan under the engine. Remove the oil drain plug so that the oil can be completely drained.
4. Check the drain plug, gasket, oil filler cap and O-ring. If damaged, replace.

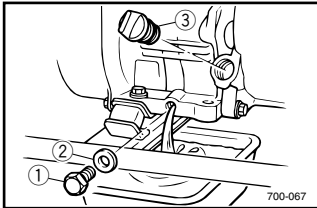

- ① Oil drain plug
- ② Gasket
- ③ O-ring

5. Reinstall the oil drain plug.

Drain Plug Torque:  
30 N•m (3.0 kgf•m, 22 lbf•ft)

6. Add engine oil to the upper level.

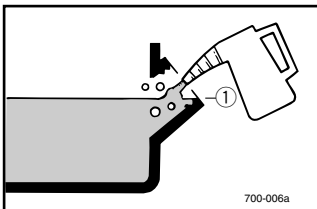

- ① Upper level

- Recommended oil:
- A YAMALUBE 4 (10W-30) or SAE 10W-30 type SE motor oil
  - B SAE #30
  - C SAE #20
  - D SAE 10W

Engine oil quantity:

EF4000DE/YG4000D:  
1.0 L (0.88 Imp qt, 1.06 US qt)

EF5200DE/EF6600DE/YG5200D/YG6600D/  
YG6600DE:  
1.1 L (0.97 Imp qt, 1.16 US qt)

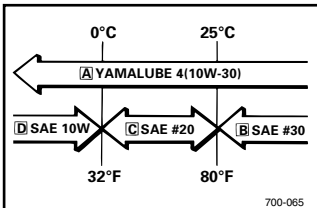

**NOTE:** \_\_\_\_\_

Recommended engine oil classification:  
API Service "SE" or "SF".

\_\_\_\_\_

**CAUTION:** \_\_\_\_\_

**Be sure no foreign material enters the crankcase.**

\_\_\_\_\_

**AIR FILTER**

1. Remove the air filter cover and element.
2. Wash the element in solvent and dry.
3. Oil the element and squeeze out excess oil.  
The element should be wet but not dripping.

Recommended oil:  
Foam-air-filter oil  
or  
SAE #20 motor oil

**CAUTION:** \_\_\_\_\_

**Do not wring out the element.  
This could cause it to tear.**

\_\_\_\_\_

**NOTE:** \_\_\_\_\_

For EF4000DE/YG4000D, the dry foam urethane (sponge) ① is installed to absorb any excessive oil that comes out of the air filter element. Therefore do not apply oil to the sponge ①. If it gets oily, squeeze out the oil.

\_\_\_\_\_

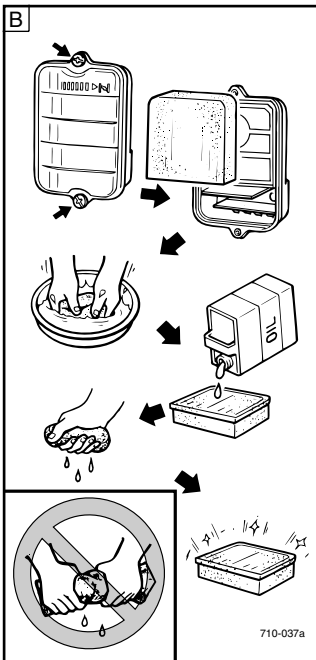
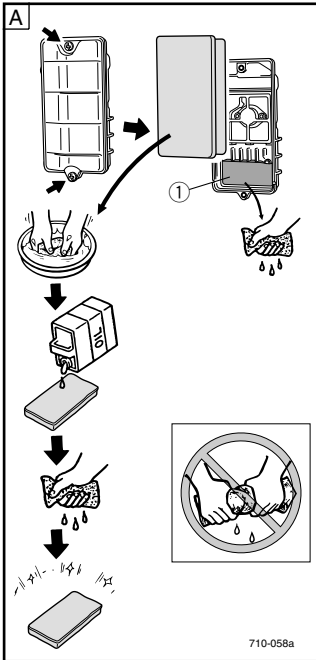

4. Insert the element into the air filter.

**NOTE:** \_\_\_\_\_

Be sure the element sealing surface matches the air filter so there is no air leak.

\_\_\_\_\_

**CAUTION:** \_\_\_\_\_

**The engine should never run without the element;  
excessive piston and cylinder wear may result.**

\_\_\_\_\_

**⚠WARNING** \_\_\_\_\_

**Never use solvent while smoking or in the vicinity  
of an open flame.**

\_\_\_\_\_

**A** EF4000DE/YG4000D

**B** EF5200DE/EF6600DE/YG5200D/YG6600D/YG6600DE

AE00461

## FUEL COCK

### **⚠WARNING**

Never use or be near fuel and solvent while smoking or in the vicinity of an open flame.

1. Stop the engine.
2. Turn the fuel cock lever to "OFF".
3. Remove the fuel cock cup and gasket.
4. Clean the cup with solvent and wipe it off.
5. Check the gasket. Replace it if damaged.
6. Reinstall the gasket and fuel cock cup.

### **⚠WARNING**

Be sure the fuel cock cup is tightened securely.

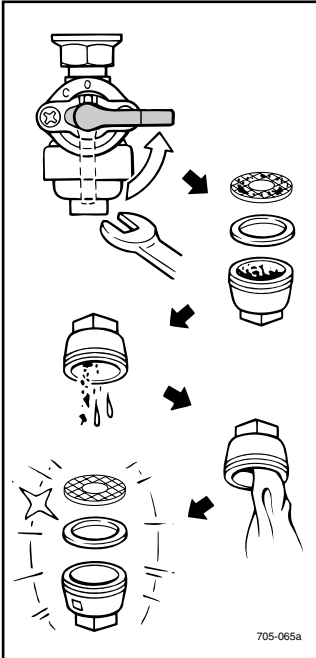

AE00471

## FUEL TANK FILTER

1. Remove the fuel tank cap and filter.

① Filter

2. Clean the filter with solvent.  
If damaged, replace.
3. Wipe the filter and insert it.

### **⚠WARNING**

Be sure the tank cap is tightened securely.

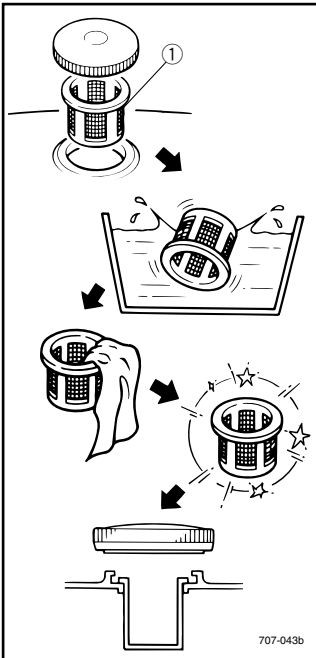

AE00443

## MUFFLER SCREEN AND SPARK ARRESTER (For EF4000DE/YG4000D)

### **⚠ WARNING**

The engine and muffler will be very hot after the engine has been run.  
Avoid touching the engine and muffler while they are still hot with any part of your body or clothing during inspection or repair.

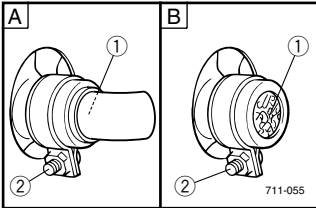
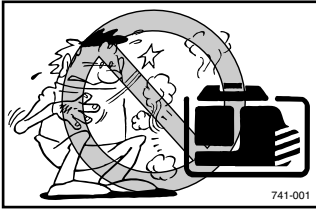

1. Remove the muffler screen.

- ① Muffler screen
- ② Screw
- A EF4000DE
- B YG4000D

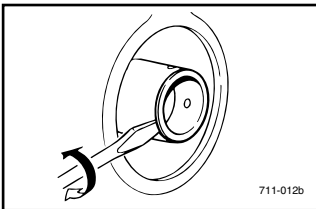

2. Use a flathead screw driver to pry the spark arrester out from the muffler.

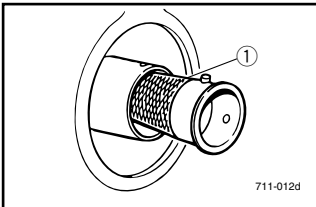

3. Remove the spark arrester.

- ① Spark arrester

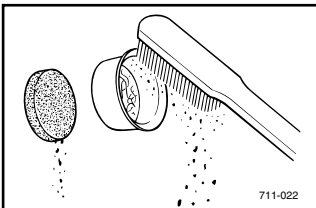

4. Remove the carbon deposits on the muffler screen and spark arrester using a wire brush.

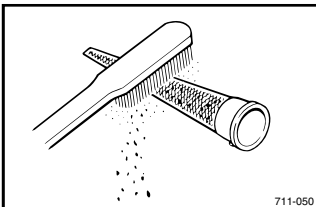

### **CAUTION:**

When cleaning, use the wire brush lightly to avoid damaging or scratching of the muffler screen and spark arrester.

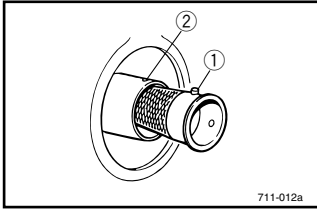

5. Check the muffler screen and spark arrester.  
Replace them if damaged.
6. Install the spark arrester.

**NOTE:** \_\_\_\_\_  
Align the spark arrester projection with the hole in the muffler pipe.

---

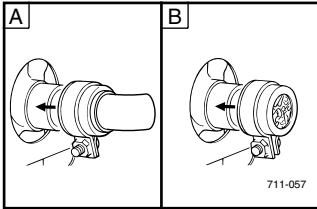

- ① Projection
- ② Hole

7. Install the muffler screen.

- A EF4000DE  
B YG4000D

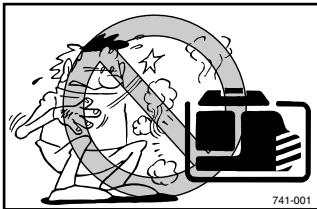

AE00841

**MUFFLER SCREEN AND SPARK ARRESTER**  
(For EF5200DE/EF6600DE/YG5200D/YG6600D/  
YG6600DE)

**⚠ WARNING** \_\_\_\_\_

The engine and muffler will be very hot after the engine has been run.

**Avoid touching the engine and muffler while they are still hot with any part of your body or clothing during inspection or repair.**

---

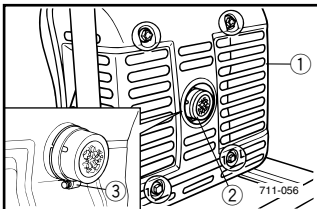

1. Remove the muffler protector and muffler screen.

- ① Muffler protector
- ② Muffler screen
- ③ Screw

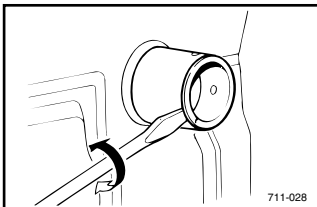

2. Use a flathead screw driver to pry the spark arrester out from the muffler.

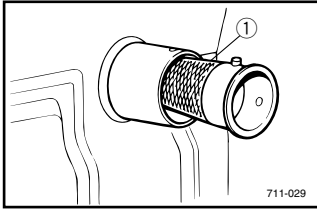

3. Remove the spark arrester.

① Spark arrester

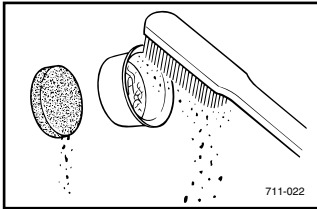

4. Remove the carbon deposits on the muffler screen and spark arrester using a wire brush.

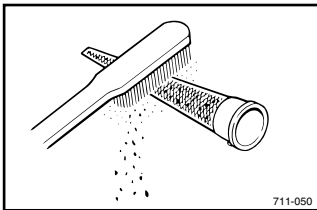

**CAUTION:** \_\_\_\_\_

**When cleaning, use the wire brush lightly to avoid damaging or scratching of the muffler screen and spark arrester.**

5. Check the muffler screen and spark arrester.  
Replace them if damaged.

6. Install the spark arrester.

**NOTE:** \_\_\_\_\_

Align the spark arrester projection with the hole in the muffler pipe.

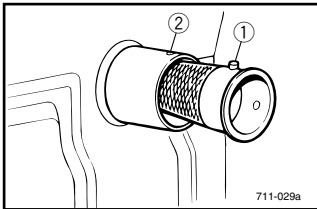

① Projection

② Hole

7. Install the muffler screen and muffler protector.

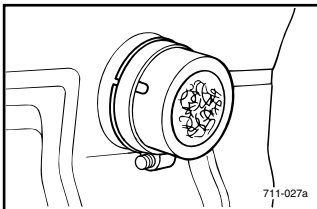

AE00842

## BATTERY

(for EF4000DE/EF5200DE/EF6600DE/YG6600DE)

### Replenishing the battery fluid

1. Check the fluid level. The level should be between the upper and lower level marks.

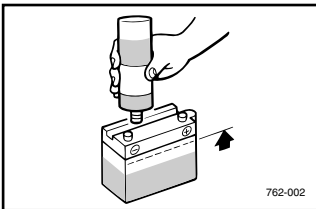
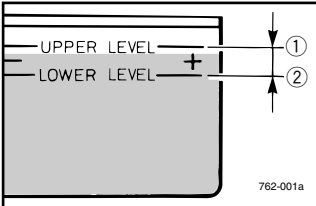
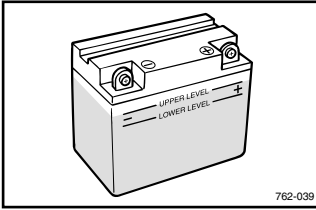

- ① Upper level
- ② Lower level

2. Add only distilled water if necessary.

### CAUTION:

- Normal tap water contains minerals which are harmful to a battery; therefore, refill only with distilled water.
- Do not disconnect the battery during engine operation.
- Avoid operating the generator with the battery removed.

### ⚠ WARNING

Battery electrolyte is poisonous and dangerous, causing severe burns, etc. It contains sulfuric (sulfuric) acid. Avoid contact with skin, EYES or clothing.

Antidote:

**EXTERNAL**-Flush with water.

**INTERNAL**-Drink large quantities of water or milk. Follow with milk of magnesia, beaten egg or vegetable oil. Call physician immediately.

**Eyes:** Flush with water for 15 minutes and get prompt medical attention. Batteries produce explosive gases. Keep sparks, flame, cigarettes, etc. away. Ventilate when charging or using in closed space. Always cover eyes when working near batteries. **KEEP OUT OF REACH OF CHILDREN.**

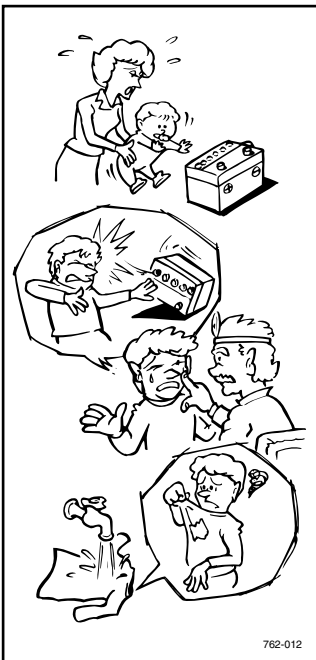

## FUSE REPLACEMENT (for EF4000DE/EF5200DE/EF6600DE/YG6600DE)

### **⚠WARNING**

Be sure to use specified fuse. A wrong fuse will cause electrical system damage and A FIRE HAZARD.

### **CAUTION:**

Be sure the engine switch is turned off to prevent accidental short circuiting.

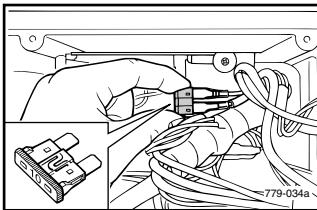
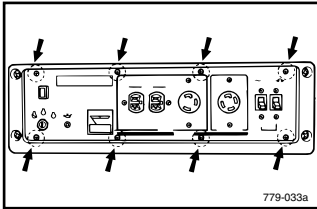

1. Loosen the control panel screws and then remove the control panel.
2. Replace the blown fuse with one of proper amperage.

Specified fuse: 10A

### **NOTE:**

If the fuse immediately blows again, consult a Yamaha dealer.

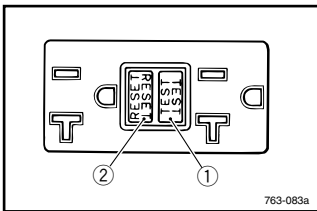

## G.F.C.I. RECEPTACLE TEST (for YG4000D/YG5200D/YG6600D/YG6600DE)

1. Start the engine.
2. Turn the AC switch (N.F.B.) to the "ON" position.
3. Press the test button ①, then check the position of the reset button ②.

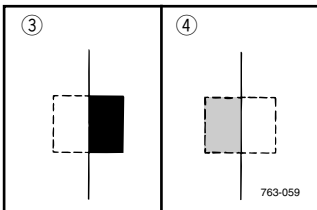

G.F.C.I. Reset Button Position after Test	G.F.C.I. Receptacle Operation
Pop Out ③	Correct
Stay In ④	Incorrect

4. If G.F.C.I. operation is correct, push in the reset button.  
If the G.F.C.I. operates incorrectly, consult a Yamaha dealer.

### **⚠WARNING**

Do not operate the generator with a faulty G.F.C.I. circuit. Electric shock could occur. Have the generator repaired by a qualified mechanic.



**TROUBLESHOOTING****Engine won't start**

## 1. Fuel systems

No fuel supplied to combustion chamber.

- No fuel in tank .... Supply fuel.
- Clogged fuel line .... Clean fuel line.
- Foreign matter in fuel cock .... Clean fuel cock.
- Clogged carburetor .... Clean carburetor.

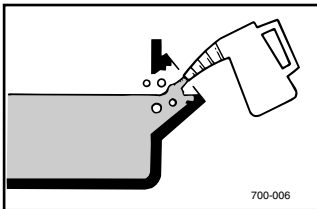
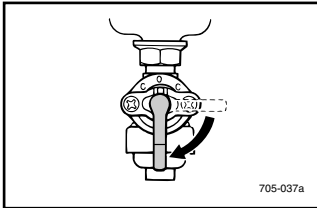
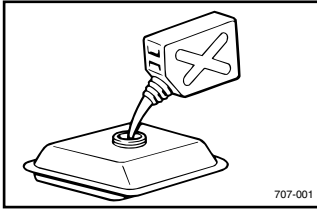

## 2. Engine oil system

Insufficient

- Oil level is low .... Add engine oil.

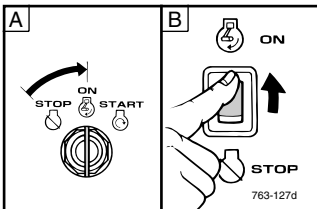

## 3. Electrical systems

- Engine switch to "ON".

Poor spark

- Spark plug dirty with carbon or wet .... Remove carbon or wipe spark plug dry.
- Faulty ignition system .... Consult dealer.

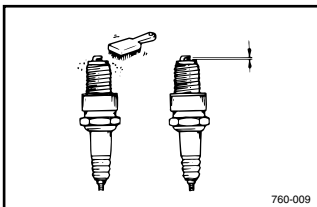

## 4. Compression

Insufficient

- Worn out piston and cylinder .... Consult dealer.
- Loose cylinder head nuts .... Tighten nuts properly.
- Damaged gasket .... Replace gasket.

**FOR EF4000DE/EF5200DE/EF6600DE/YG6600DE**

**A** ENGINE DOES NOT START



**B** Turn the engine switch to "ON", then turn the engine switch to "START" (for EF4000DE/EF5200DE/EF6600DE) or push the starter switch (for YG6600DE). And check if the starter motor cranks.

**C** Cranks      **D** Does not crank



**F** Turn the engine switch to "START" or push the starter switch, and check if the oil warning light flickers.

**G** Does not flicker      **H** Flickers



**L** Turn the engine switch to "START" or push the starter switch, and check the spark plug for spark strength. (See "WARNING").

**⚠ WARNING**

- To prevent **FIRE HAZARDS** be sure fuel is not present in the spark plug area.
- To prevent **FIRE HAZARDS** be sure to place the spark plug as far way as possible from the spark plug hole and carburetor area.
- To prevent **ELECTRIC SHOCK** do not hold spark plug lead with hand while testing.

**M** Engine does not start.      **N** Engine starts.



**R** Check the following

- Fuel cock clogging
- Air cleaner element clogging.

<b>S</b>	Clogged	→	<b>U</b> Clean or Replace; Consult a Yamaha dealer.
<b>T</b>	OK	→	<b>V</b> Consult a Yamaha dealer.

**E** Faulty battery and/or starter motor.  
Consult a Yamaha dealer.

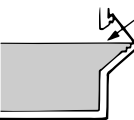
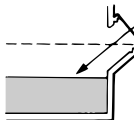
<b>I</b> Check engine oil level.	
	
<b>J</b> OK	<b>K</b> Level low
Consult a Yamaha dealer.	Add engine oil.

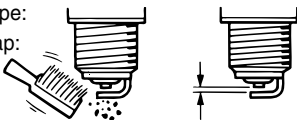
<b>O</b> Check the spark plug.	
<ul style="list-style-type: none"> <li>• Type:</li> <li>• Gap:</li> </ul> 	
<b>P</b> Incorrect	<b>Q</b> OK
Replace or Adjust Gap.	Clean the spark plug.

**FOR YG4000D/YG5200D/YG6600D**

**A** ENGINE DOES NOT START

**B** Turn the engine switch to "ON", then pull the recoil starter and check if the oil warning light flickers.

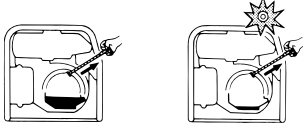

<b>C</b> Does not flicker	<b>D</b> Flickers
---------------------------	-------------------

**E** Check engine oil level.

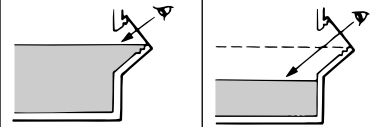

<b>F</b> OK	<b>G</b> Level low
Consult a Yamaha dealer.	Add engine oil.

**H** Pull the recoil starter and check the spark plug for spark strength. (See "WARNING")



**⚠ WARNING**

- To prevent **FIRE HAZARDS** be sure fuel is not present in the spark plug area.
- To prevent **FIRE HAZARDS** be sure to place the spark plug as far way as possible from the spark plug hole and carburetor area.
- To prevent **ELECTRIC SHOCK** do not hold spark plug lead with hand while testing.

<b>I</b> Engine does not start.	<b>J</b> Engine starts.
---------------------------------	-------------------------

**K** Check the spark plug.

- Type:
- Gap:

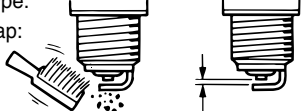

<b>L</b> Incorrect	<b>M</b> OK
Replace or Adjust Gap.	Clean the spark plug.

**N** Check the following

- Fuel cock clogging
- Air cleaner element clogging.

<b>O</b> Clogged	<b>Q</b> Clean or Replace; Consult a Yamaha dealer.
<b>P</b> OK	<b>R</b> Consult a Yamaha dealer.

AE00601

## STORAGE

Long term storage of your machine will require some preventive procedures to guard against deterioration.

AE00611

### DRAIN THE FUEL

1. Drain the fuel tank, fuel cock, and carburetor float bowl.

Ⓐ Carburetor drain plug

2. Pour a cup of SAE 10W30 or 20W40 motor oil into the tank.
3. Shake the tank to coat the inner surfaces thoroughly.
4. Drain off the excess oil.

Ⓐ EF4000DE/EF5200DE/YG4000D/YG5200D

Ⓑ EF6600DE/YG6600D/YG6600DE

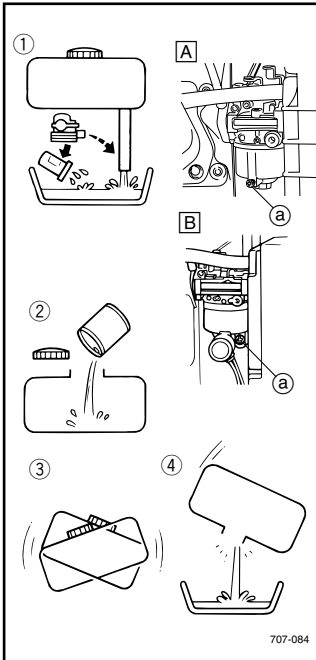

AE00621

### ENGINE

1. Remove the spark plug, pour about one tablespoon of SAE 10W30 or 20W40 motor oil into the spark plug hole and reinstall the spark plug. Recoil start the engine by turning over several times (with ignition off) to coat the cylinder walls with oil.
2. Pull the recoil starter until you feel compression. Then stop pulling. (This prevents the cylinder and valves from rusting).
3. Clean exterior of the generator and apply a rust inhibitor.
4. Store the generator in a dry, well-ventilated place, with the cover placed over it.
5. The generator must remain in a vertical position when stored, carried or operated.

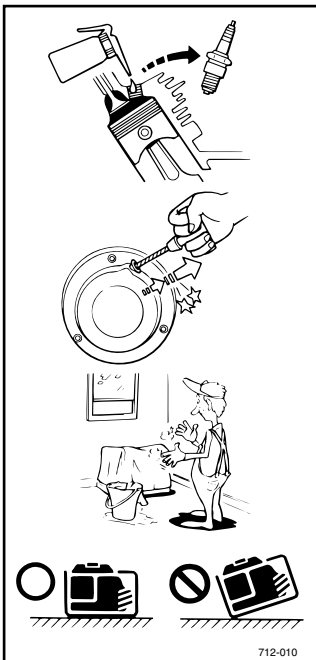

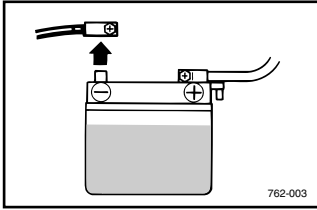

AE00633

## BATTERY

(for EF4000DE/EF5200DE/EF6600DE/YG6600DE)

1. Remove the battery.
2. Check the fluid level. Add only distilled water if necessary. (See page 34; "BATTERY-Replenishing the battery fluid")
3. After checking the fluid level, charge the battery.
4. Store the battery in a cool, dark and dry place and charge it once a month.

Do not store the battery in an excessively warm or cold place [i.e., less than 0°C (30°F) or more than 30°C (90°F)].

### **⚠WARNING**

- **Disconnect the negative lead first, then the positive lead from the battery.**
- **Connect the positive lead first, then the negative lead to the battery when installing the battery.**
- **Never smoke or make and break connections at the battery while charging. Sparks may ignite the battery gas.**
- **Be sure the battery terminals are tight and that the battery vent tube is properly routed and is securely attached to the battery.**

### **CAUTION:**

- **Do not disconnect the battery during engine operation.**
- **Avoid operating the generator with the battery removed.**

AE00632

## RECOMMENDED BATTERY

(for EF4000DE/EF5200DE/EF6600DE/YG6600DE)

Recommended battery:  
Capacity: 12V/26A•h

### **NOTE:**

- **Clamp the red wire to the positive (+) terminal and the black wire to the negative (-) terminal of the battery. Do not reverse these positions.**
- **Be sure the battery is installed on the battery mount tray securely.**

## EXHAUST EMISSION CONTROL SYSTEM AND COMPONENTS

Item	Acronym
• CARB. ASSY., LH. & JT., ..... CARBURETOR2	CARB (Carburetor)
• T.C.I. MAGNETO ASSY. & ..... PLUG, SPARK	EI (Electronic Ignition)
• CRANKCASE1 & HEAD, ..... CYLINDER1	PCV (Positive Crankcase Ventilation)
• AIR FILTER ASSY. ....	ACL (Air Cleaner)
• MUFF., 2, CAP, NET, WIRE2 & ARRESTER, SPARK	

The above items and the corresponding acronyms are provided in accordance with U.S. EPA REGULATIONS FOR NEW NONROAD SPARK-IGNITION NONHANDHELD ENGINES and the CALIFORNIA REGULATIONS FOR 1995 AND LATER SMALL OFF-ROAD ENGINES.

The acronyms conform to the latest version of the SAE's recommended practice document J1930, "Diagnostic Acronyms, Terms, and Definitions For Electrical/Electronic System".

It is recommended that these items be serviced by a Yamaha dealer.

# SPECIFICATIONS

## DIMENSIONS

	Unit	EF4000DE	EF5200DE	EF6600DE	YG4000D	YG5200D	YG6600D	YG6600DE
Overall Length	mm (in)	804 (31.7)	894 (35.2)	894 (35.2)	580 (22.8)	670 (26.4)	670 (26.4)	894 (35.2)
Overall Width	mm (in)	525 (20.7)	520 (20.5)	520 (20.5)	525 (20.7)	510 (20.1)	510 (20.1)	520 (20.5)
Overall Height	mm (in)	510 (20.1)	510 (20.1)	510 (20.1)	560 (22.0)	560 (22.0)	560 (22.0)	560 (22.0)
Dry Weight	kg (lb)	66 (145.5)	90 (198.4)	90 (198.4)	60 (132.3)	85 (187.3)	85 (187.3)	92 (202.8)

## ENGINE

	Unit	EF4000DE/ YG4000D	EF5200DE/ YG5200D	EF6600DE/ YG6600D/ YG6600DE
Type		Air cooled 4-stroke gasoline OHV		
Cylinder Arrangement		Inclined, 1 cylinder		
Displacement	cm <sup>3</sup>	251	301	357
Bore × Stroke	mm (in)	75.0 × 57.0 (2.95 × 2.24)	78.0 × 63.0 (3.07 × 2.48)	85.0 × 63.0 (3.35 × 2.48)
Rated Output	kW (HP)/r/min	4.5 (6.1)/3600	5.8 (7.8)/3600	7.1 (9.5)/3600
Operation Hours	Hr	8.5	7.6	6.6
Fuel		Unleaded gasoline		
Fuel Tank Capacity	L (Imp gal, US gal)	18.5 (4.07, 4.89)	21.0 (4.62, 5.55)	
Engine Oil Quantity	L (Imp qt, US qt)	1.0 (0.88, 1.06)	1.1 (0.97, 1.16)	
Ignition System		TCI		
Spark Plug: Type		BPR4ES (NGK)		
Gap	mm (in)	0.7–0.8 (0.028–0.031)		
Noise Level*	dB (A)	69	73	74

\* : Measured at rated operation from 7 m (23 ft) distance.

## GENERATOR

	Unit	EF4000DE	EF5200DE	EF6600DE	YG4000D	YG5200D	YG6600D	YG6600DE
AC Output								
Rated voltage	V	120/240						
Rated frequency	Hz	60						
Rated current	A	29.2/14.6	37.5/18.8	50.0/25.0	29.2/14.6	37.5/18.8	50.0/25.0	50.0/25.0
Rated output	kVA	3.5	4.5	6.0	3.5	4.5	6.0	6.0
Safety Device: Type		N.F.B.						



# WIRING DIAGRAM

EF4000DE

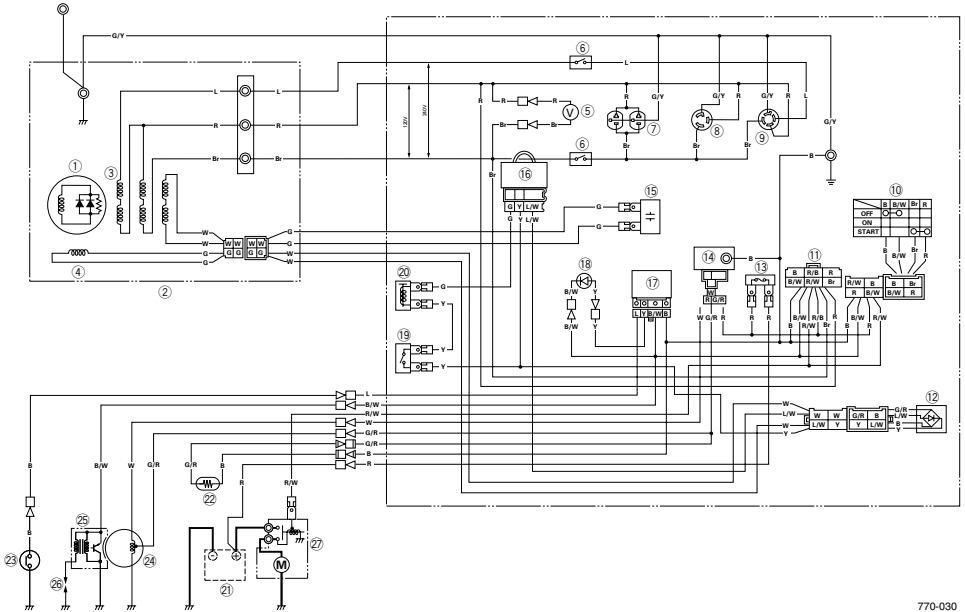

770-030

- ① Rotor assembly
- ② Stator assembly
- ③ Main coil
- ④ Sub coil
- ⑤ Voltage meter
- ⑥ N.F.B.
- ⑦ AC receptacle
- ⑧ AC receptacle
- ⑨ AC receptacle
- ⑩ Engine switch
- ⑪ Remote control terminal
- ⑫ Rectifier
- ⑬ Fuse
- ⑭ Rectifier/regulator

- ⑮ Condenser
- ⑯ Economy idle unit
- ⑰ Oil warning unit
- ⑱ Oil warning light
- ⑲ Economy idle switch
- ⑳ Solenoid valve
- ㉑ Battery
- ㉒ Carburetor heater
- ㉓ Oil level switch
- ㉔ Charging coil
- ㉕ T.C.I. unit
- ㉖ Spark plug
- ㉗ Starter motor

### Color code

- B Black
- Br Brown
- G Green
- L Blue
- R Red
- W White
- B/W Black/White
- G/R Green/White
- G/Y Green/Yellow
- L/W Blue/White
- R/W Red/White
- Y Yellow

# EF5200DE

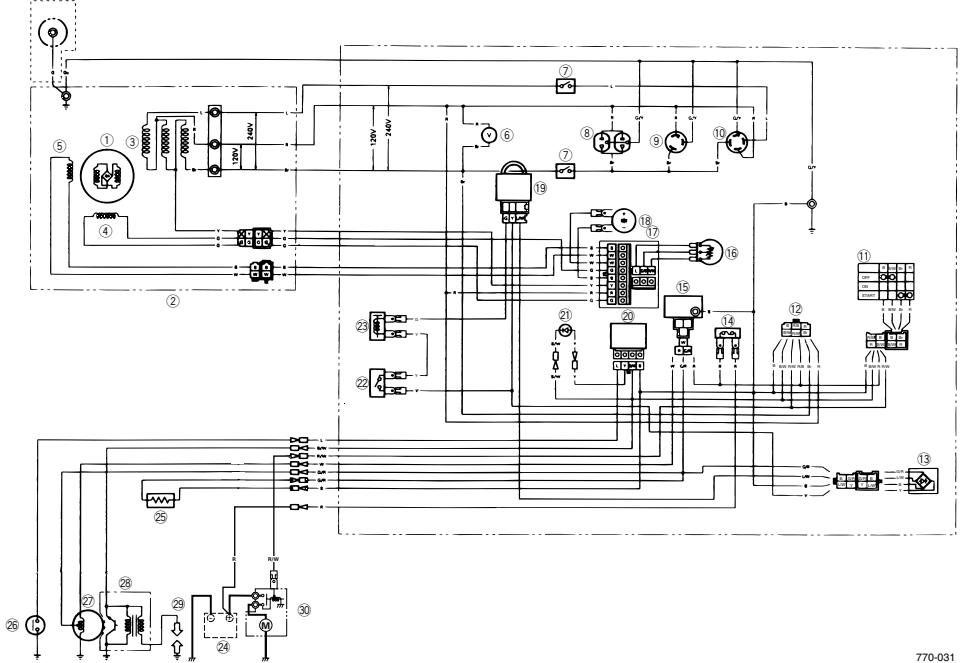

770-031

- ① Rotor assembly
- ② Stator assembly
- ③ Main coil
- ④ Sub coil
- ⑤ Exciter coil
- ⑥ Voltage meter
- ⑦ N.F.B.
- ⑧ AC receptacle
- ⑨ AC receptacle
- ⑩ AC receptacle
- ⑪ Engine switch
- ⑫ Remote control terminal
- ⑬ Rectifier
- ⑭ Fuse
- ⑮ Rectifier/regulator
- ⑯ Voltage adjuster

- ⑰ AVR
- ⑱ Condenser
- ⑲ Economy idle unit
- ⑳ Oil warning unit
- ㉑ Oil warning light
- ㉒ Economy idle switch
- ㉓ Solenoid valve
- ㉔ Battery
- ㉕ Carburetor heater
- ㉖ Oil level switch
- ㉗ Charging coil
- ㉘ T.C.I. unit
- ㉙ Spark plug
- ㉚ Starter motor

### Color code

- |     |              |
|-----|--------------|
| B   | Black        |
| Br  | Brown        |
| G   | Green        |
| L   | Blue         |
| R   | Red          |
| W   | White        |
| B/W | Black/White  |
| G/R | Green/White  |
| G/Y | Green/Yellow |
| L/W | Blue/White   |
| R/W | Red/White    |
| Y   | Yellow       |

# EF6600DE

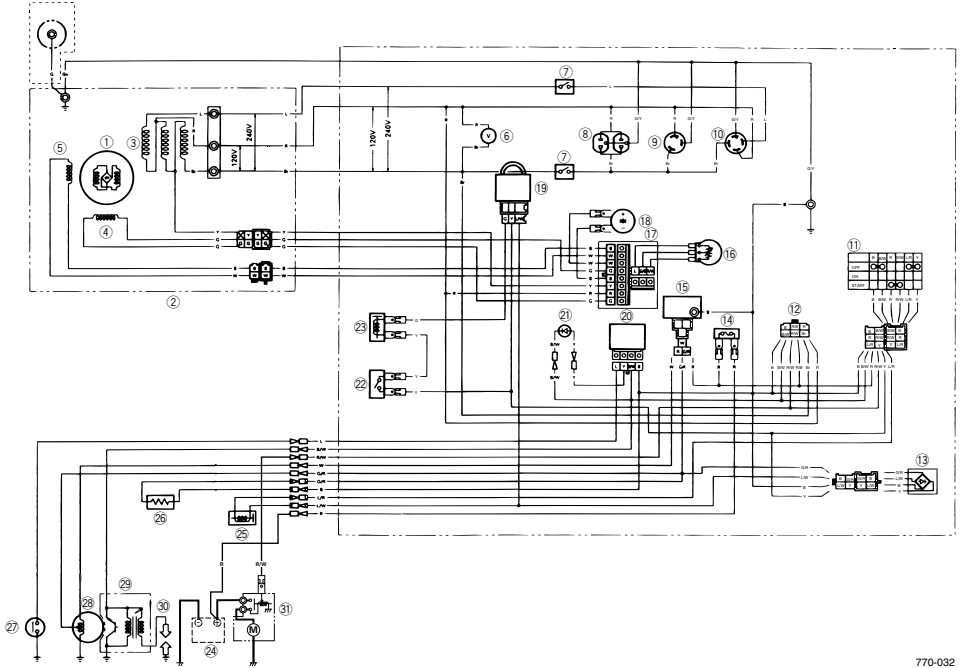

770-032

- ① Rotor assembly
- ② Stator assembly
- ③ Main coil
- ④ Sub coil
- ⑤ Exciter coil
- ⑥ Voltage meter
- ⑦ N.F.B.
- ⑧ AC receptacle
- ⑨ AC receptacle
- ⑩ AC receptacle
- ⑪ Engine switch
- ⑫ Remote control terminal
- ⑬ Rectifier
- ⑭ Fuse
- ⑮ Rectifier/regulator
- ⑯ Voltage adjuster

- ⑰ AVR
- ⑱ Condenser
- ⑲ Economy idle unit
- ⑳ Oil warning unit
- ㉑ Oil warning light
- ㉒ Economy idle switch
- ㉓ Solenoid valve
- ㉔ Battery
- ㉕ Carburetor solenoid valve
- ㉖ Carburetor heater
- ㉗ Oil level switch
- ㉘ Charging coil
- ㉙ T.C.I. unit
- ㉚ Spark plug
- ㉛ Starter motor

### Color code

- |     |              |
|-----|--------------|
| B   | Black        |
| Br  | Brown        |
| G   | Green        |
| L   | Blue         |
| R   | Red          |
| W   | White        |
| B/W | Black/White  |
| G/R | Green/White  |
| G/Y | Green/Yellow |
| L/W | Blue/White   |
| R/W | Red/White    |
| Y   | Yellow       |



# YG5200D

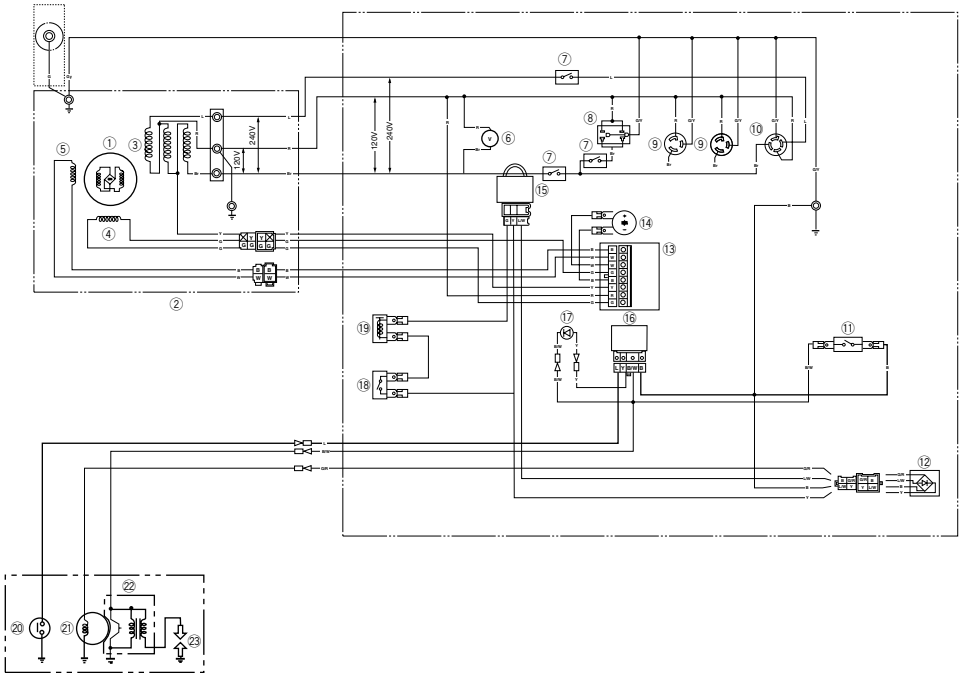

- ① Rotor assembly
- ② Stator assembly
- ③ Main coil
- ④ Sub coil
- ⑤ Exciter field coil
- ⑥ Voltage meter
- ⑦ N.F.B.
- ⑧ GFCI receptacle
- ⑨ AC receptacle
- ⑩ AC receptacle
- ⑪ Engine switch
- ⑫ Rectifier

- ⑬ AVR
- ⑭ Condenser
- ⑮ Economy idle unit
- ⑯ Oil warning unit
- ⑰ Oil warning light
- ⑱ Economy idle switch
- ⑲ Solenoid valve
- ⑳ Oil level switch
- ㉑ Charging coil
- ㉒ T.C.I. unit
- ㉓ Spark plug

### Color code

- |     |              |
|-----|--------------|
| B   | Black        |
| Br  | Brown        |
| G   | Green        |
| L   | Blue         |
| R   | Red          |
| W   | White        |
| B/W | Black/White  |
| G/R | Green/White  |
| G/Y | Green/Yellow |
| L/W | Blue/White   |
| R/W | Red/White    |
| Y   | Yellow       |

# YG6600D

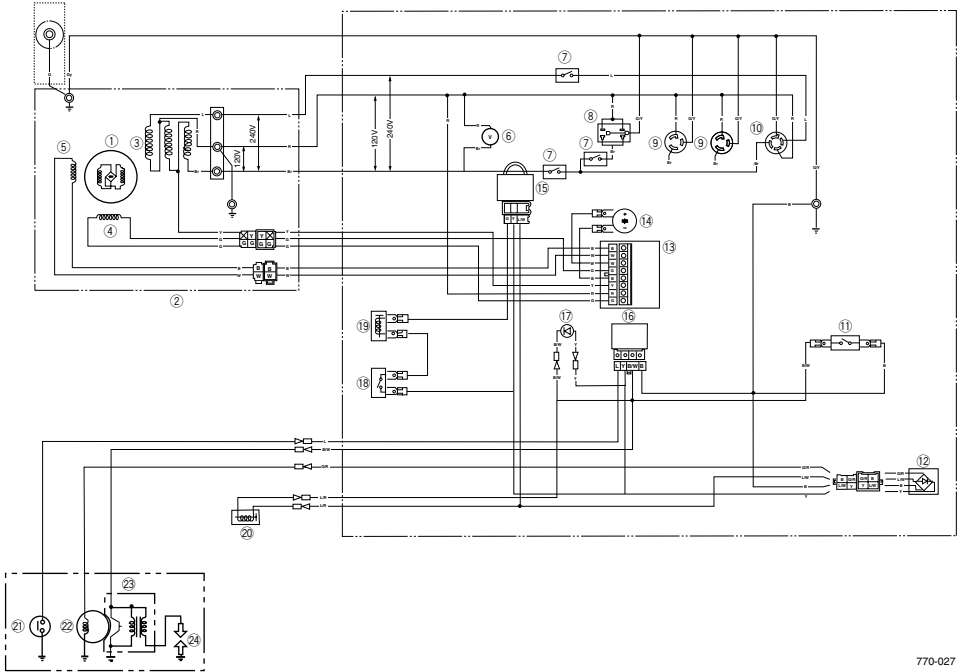

770-027

- ① Rotor assembly
- ② Stator assembly
- ③ Main coil
- ④ Sub coil
- ⑤ Exciter field coil
- ⑥ Voltage meter
- ⑦ N.F.B.
- ⑧ GFCI receptacle
- ⑨ AC receptacle
- ⑩ AC receptacle
- ⑪ Engine switch
- ⑫ Rectifier

- ⑬ AVR
- ⑭ Condenser
- ⑮ Economy idle unit
- ⑯ Oil warning unit
- ⑰ Oil warning light
- ⑱ Economy idle switch
- ⑲ Solenoid valve
- ⑳ Carburetor solenoid valve
- ㉑ Oil level switch
- ㉒ Charging coil
- ㉓ T.C.I. unit
- ㉔ Spark plug

### Color code

- |     |              |
|-----|--------------|
| B   | Black        |
| Br  | Brown        |
| G   | Green        |
| L   | Blue         |
| R   | Red          |
| W   | White        |
| B/W | Black/White  |
| G/R | Green/White  |
| G/Y | Green/Yellow |
| L/W | Blue/White   |
| R/W | Red/White    |
| Y   | Yellow       |

# YG6600DE

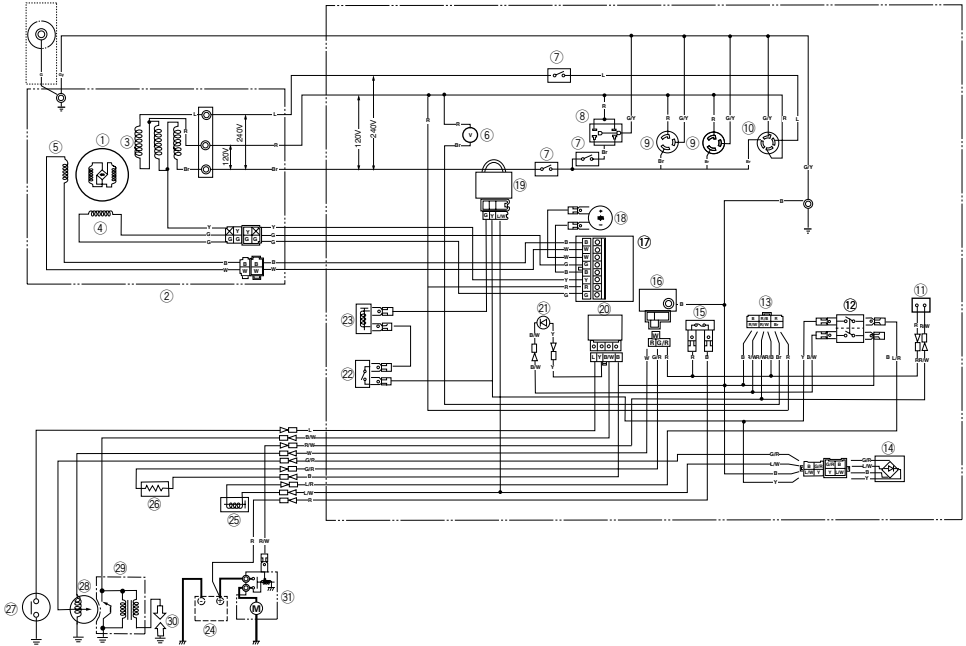

770-028b

- ① Rotor assembly
- ② Stator assembly
- ③ Main coil
- ④ Sub coil
- ⑤ Exciter coil
- ⑥ Voltage meter
- ⑦ N.F.B.
- ⑧ GFCI receptacle
- ⑨ AC receptacle
- ⑩ AC receptacle
- ⑪ Starter switch
- ⑫ Engine switch
- ⑬ Remote control terminal
- ⑭ Rectifier
- ⑮ Fuse
- ⑯ Rectifier/regulator

- ⑰ AVR
- ⑱ Condenser
- ⑲ Economy idle unit
- ⑳ Oil warning unit
- ㉑ Oil warning light
- ㉒ Economy idle switch
- ㉓ Solenoid valve
- ㉔ Battery
- ㉕ Carburetor solenoid valve
- ㉖ Carburetor heater
- ㉗ Oil level switch
- ㉘ Charging coil
- ㉙ T.C.I. unit
- ㉚ Spark plug
- ㉛ Starter motor

## Color code

- B Black
- Br Brown
- G Green
- L Blue
- R Red
- W White
- B/W Black/White
- G/R Green/White
- G/Y Green/Yellow
- L/W Blue/White
- R/W Red/White
- Y Yellow

AE00761

### BATTERY TRAY INSTALLATION (for EF4000DE/EF5200DE/EF6600DE/ YG6600DE)

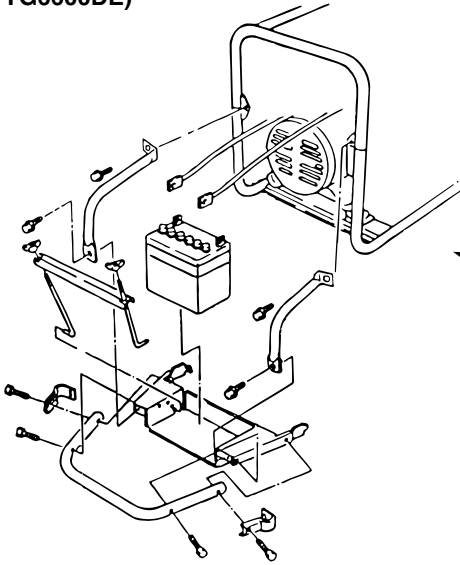

AE00795

### ENGINE HANGER INSTALLATION (for YG4000D/YG5200D/YG6600D/ YG6600DE)

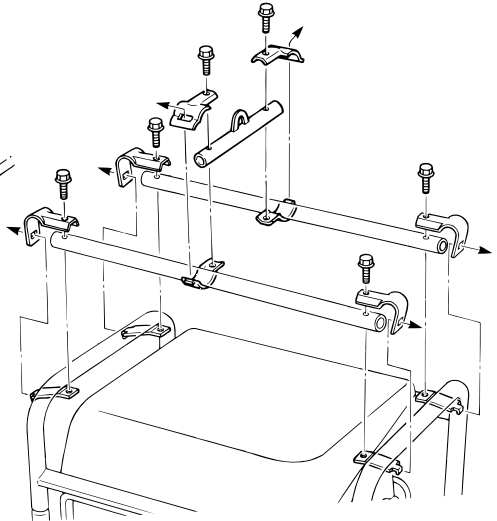

AE00762

### OPTIONAL PARTS INSTALLATION

AE00763

#### Two wheel kit

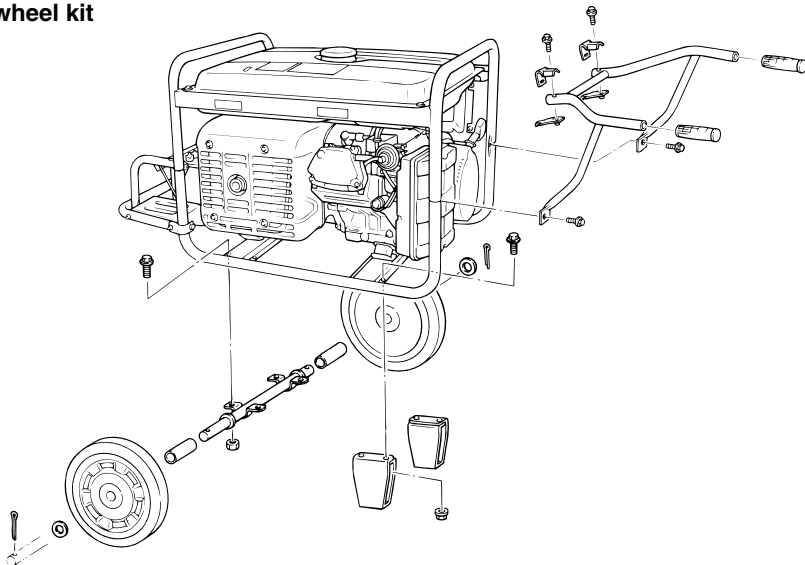



— MEMO —

— MEMO —



PRINTED ON RECYCLED PAPER



PRINTED IN JAPAN  
03 • 08 – 1.1 × 1 

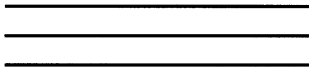

**YAMAHA MOTOR CORPORATION U.S.A.  
P.O. BOX 6555  
CYPRESS, CALIFORNIA 90630**

**ATTN: WARRANTY DEPARTMENT**

# CUSTOMER WARRANTY REGISTRATION

OWNER'S  
NAME \_\_\_\_\_

DATE SOLD

MODEL

MACHINE SERIAL NUMBER

ADDRESS \_\_\_\_\_

CITY &  
STATE \_\_\_\_\_

ZIP \_\_\_\_\_

AREA CODE

PHONE NUMBER (     ) \_\_\_\_\_

## **IMPORTANT!**

- Please complete and mail this form. It will help ensure that Yamaha has accurately registered your purchase for warranty.
- Manufacturers are required to maintain a complete up-to-date list of all first purchasers of products against the possibility of a safety-related defect and recall.
- Please check the box that best describes the primary area of usage of this product:

Private

Commercial

Rental

**MAIL THIS TO YAMAHA MOTOR CORPORATION, U.S.A.** d.

## Free Manuals Download Website

<http://myh66.com>

<http://usermanuals.us>

<http://www.somanuals.com>

<http://www.4manuals.cc>

<http://www.manual-lib.com>

<http://www.404manual.com>

<http://www.luxmanual.com>

<http://aubethermostatmanual.com>

Golf course search by state

<http://golfingnear.com>

Email search by domain

<http://emailbydomain.com>

Auto manuals search

<http://auto.somanuals.com>

TV manuals search

<http://tv.somanuals.com>