

YAMAHA

UTILITY CAR

OWNER'S/
OPERATOR'S
MANUAL

G21A

LIT-19626-11-00

JR6-F8199-00

 **WARNING**

The engine exhaust from this product contains chemicals known to the State of California to cause cancer, birth defects or other reproductive harm.

YAMAHA

LIT-CALIF-65-01

 **WARNING**

The engine exhaust from this product contains chemicals known to the State of California to cause cancer, birth defects or other reproductive harm.

YAMAHA

LIT-CALIF-65-01

INTRODUCTION

Congratulations on your purchase of a Yamaha utility car. This manual contains information you will need for proper operation, maintenance, and care of your utility car. A thorough understanding of these simple instructions will help you to obtain maximum enjoyment from your new Yamaha.

If you have any questions about the operation or maintenance of your utility car, please consult a Yamaha dealer.

**TECHNICAL SERVICE DEPT
GOLF CAR SALES GROUP
YAMAHA MOTOR
MANUFACTURING CORP OF
AMERICA**

**G21A
OWNER'S/OPERATOR'S
MANUAL
© 2000 by Yamaha Motor
Manufacturing Corporation
of America
1st edition**

**All rights reserved. Any reprinting
or unauthorized use without the
written permission of
Yamaha Motor Manufacturing
Corporation of America
is expressly prohibited.
Printed in U.S.A.
P/N LIT-19626-11-00**

IMPORTANT MANUAL INFORMATION

Particularly important information is distinguished in this manual by the following notations:



The Safety Alert Symbol means ATTENTION! BE ALERT! YOUR SAFETY IS INVOLVED!

⚠ WARNING

Failure to follow WARNING instructions could result in severe injury or death to the utility car occupants, a bystander, or a person inspecting or repairing the utility car.

CAUTION

This message describes special precautions that must be taken to avoid damage to the utility car.

NOTE:

This message provides additional key information.

NOTE:

- Yamaha continually seeks advancements in product design and quality; therefore, while this manual contains the most current product information available at the time of printing, there may be minor discrepancies between your utility car and this manual. If you have any questions concerning this manual, please consult your Yamaha dealer.
- This manual should be considered a permanent part of your utility car and should remain with the car when resold.

⚠ WARNING

Read and understand this manual completely before operating your utility car.

CONTENTS

WARRANTY

1

IMPORTANT LABELS

2

OPERATOR SAFETY

3

MAINTENANCE SAFETY PROGRAM

4

CONTROLS

5

PRE-OPERATION CHECKS

6

OPERATION

7

MAINTENANCE

8

STORAGE

9

SPECIFICATIONS

10

WIRING

11

WARRANTY

YAMAHA MOTOR CORPORATION, U.S.A. G21A UTILITY VEHICLE LIMITED WARRANTY

Yamaha Motor Corporation, U.S.A. hereby warrants that any new G21A Utility Vehicle purchased from an authorized Yamaha dealer in the United States, will be free from defects in material and workmanship for the period of time stated herein, subject to the stated limitations.

THE PERIOD OF WARRANTY for any G21A Utility Vehicle will be one year from date of purchase for parts and labor.

The warranty shall cover the entire car except for batteries, tires and rims, which are warranted by their respective manufacturers.

DURING THE PERIOD OF WARRANTY any authorized Yamaha Golf Car Dealer will, free of charge, repair or replace, at Yamaha's option, any part adjudged defective by Yamaha due to faulty workmanship or material from the factory. Parts used in warranty repairs will be warranted for the balance of the machine's warranty period. All parts replaced under warranty become property of Yamaha Motor Corporation, U.S.A.

GENERAL EXCLUSIONS from this warranty shall include any failures caused by:

- a. Abnormal strain, neglect, or abuse, including lack of proper maintenance, and use contrary to the owner's manual instructions.
- b. Accident or collision damage.
- c. Installation of parts or accessories that are not original equipment.
- d. Fading, rust, or deterioration due to exposure or ordinary wear and tear.
- e. Modification or alteration that affects the Utility Vehicle's condition, operation, performance, or durability.
- f. Damage due to improper transportation.
- g. Acts of God (i.e. lightning, hail damage, flooding, fire, etc.)

SPECIFIC EXCLUSIONS from this warranty shall include any parts replaced due to normal wear or routine maintenance, including oil, air filter elements, brake shoes, spark plugs, starter and clutch drive belts, and bed damage such as scratches, dents, or deformation. Any charges incurred in transporting a Utility Vehicle to and from an authorized Yamaha Golf Car Dealer for service or in performing field service is also excluded from this warranty.

THE CUSTOMER'S RESPONSIBILITY under this warranty shall be to:

1. Operate and maintain the Utility Vehicle as specified in the appropriate Owner's/Operator's Manual;
2. Give notice to an authorized Yamaha dealer of any and all apparent defects within ten (10) days after discovery, and make the machine available at that time for inspection and repairs by the dealer's authorized representative.

WARRANTY TRANSFER: To transfer any remaining warranty from the original purchaser to any subsequent purchaser, it is imperative that the machine be inspected and registered for warranty by an authorized Yamaha Golf Car Dealer. In order for this warranty to remain in effect, this inspection and registration must take place within ten (10) days after transfer. An inspection and registration fee will be charged for this service.

YAMAHA MOTOR CORPORATION, U.S.A. MAKES NO OTHER WARRANTY OF ANY KIND, EXPRESSED OR IMPLIED. ALL IMPLIED WARRANTIES OF MERCHANTABILITY AND FITNESS FOR A PARTICULAR PURPOSE WHICH EXCEED THE OBLIGATIONS AND TIME LIMITS STATED IN THIS WARRANTY ARE HEREBY DISCLAIMED BY YAMAHA MOTOR CORPORATION, U.S.A. AND EXCLUDED FROM THIS WARRANTY.

SOME STATES DO NOT ALLOW LIMITATIONS ON HOW LONG AN IMPLIED WARRANTY LASTS, SO THE ABOVE LIMITATION MAY NOT APPLY TO YOU. ALSO EXCLUDED FROM THIS WARRANTY ARE ANY INCIDENTAL OR CONSEQUENTIAL DAMAGES INCLUDING LOSS OF USE. SOME STATES DO NOT ALLOW THE EXCLUSION OR LIMITATION OF INCIDENTAL OR CONSEQUENTIAL DAMAGES, SO THE ABOVE EXCLUSION MAY NOT APPLY TO YOU.

THIS WARRANTY GIVES YOU SPECIFIC LEGAL RIGHTS, AND YOU MAY ALSO HAVE OTHER RIGHTS WHICH VARY FROM STATE TO STATE.

YAMAHA MOTOR MANUFACTURING
CORPORATION OF AMERICA
Newnan, Georgia 30265-1320

Effective Date: 10/1/00

YAMAHA MOTOR MANUFACTURING CORPORATION OF AMERICA SPECIALTY VEHICLE ENGINES EMISSION CONTROL WARRANTY

YOUR WARRANTY RIGHTS AND OBLIGATIONS

In compliance with the California Air Resources Board, Yamaha Motor Manufacturing Corporation of America is pleased to explain the emission control system warranty on your 1996 or later specialty vehicle engine. New Yamaha specialty vehicle engines must be designed, built and equipped to meet stringent anti-smog standards. Yamaha must warrant the emission control system on your specialty vehicle engine for the periods of time listed below provided there has been no abuse, neglect or improper maintenance of your specialty vehicle engine.

Your emission control system may include parts such as the carburetor or fuel-injection system, the ignition system, and catalytic converter. Also included may be hoses, belts, connectors and other emission-related assemblies.

Where a warrantable condition exists, Yamaha will repair your specialty vehicle engine at no cost to you including diagnosis, parts and labor.

MANUFACTURER'S WARRANTY COVERAGE

The 1996 and later specialty vehicle engines are warranted for two years. If any emissions-related part on your engine is defective, the part will be repaired or replaced by Yamaha.

OWNER'S WARRANTY RESPONSIBILITIES

- As the specialty vehicle engine owner, you are responsible for the performance of the required maintenance listed in your owner's manual. Yamaha recommends that you retain all receipts covering maintenance on your specialty vehicle engine, but Yamaha cannot deny warranty solely for the lack of receipts or for your failure to ensure the performance of all scheduled maintenance.
- As the specialty vehicle engine owner, you should also be aware that Yamaha may deny you warranty coverage if your specialty vehicle engine or a part has failed due to abuse, neglect, improper maintenance or unapproved modifications.

- You are responsible for presenting your specialty vehicle engine to a Yamaha dealer as soon as a problem exists. The warranty repairs should be completed in a reasonable time, not to exceed 30 days.

If you have any questions regarding your warranty rights and responsibilities, you should contact the Yamaha Customer Relations Department at (770) 254-4164.

Yamaha Motor Manufacturing Corporation of America warrants to the ultimate purchaser and each subsequent purchaser thereafter that each new 1996 and later model year specialty vehicle engine certified for sale is:

1. Designed, built, and equipped so as to conform, at the time of sale, with all applicable regulations adopted by the California Air Resources Board, and
2. All warranted parts are free from defects in material and workmanship for the warranty period of the specialty vehicle engine or the period prior to the first scheduled replacement point of the warranted part as required by the maintenance schedule, if applicable, whichever is less. A defect exists when a deficiency in material or workmanship is such that an emission-related warranted part does not function as designed.

The warranty period begins on the date that the specialty vehicle engine is delivered to an ultimate purchaser or on the date it is first placed in service.

WARRANTED PARTS INCLUDE the following:

1. Fuel Metering System
Carburetor and internal parts (or fuel injection)
Air/fuel ratio feedback and control system
Cold start enrichment system
2. Air Induction System
Controlled hot air intake system
Intake manifold

WARRANTY

1

3. Ignition System
 - Spark plugs *
 - Magneto or electronic ignition system
 - Spark advance/retard system
4. Exhaust Gas Recirculation (EGR) System
 - EGR valve body, and carburetor spacer if applicable
 - EGR rate feedback and control system
5. Air Injection System
 - Air pump or pulse valve
 - Valves affecting distribution of flow
 - Distribution manifold
6. Catalyst or Thermal Reactor System
 - Catalytic converter
 - Thermal reactor
 - Exhaust manifold
7. Particulate Controls
 - Traps, filters, precipitators, and any other device used to capture particulate emissions
8. Miscellaneous Items Used in Above Systems
 - Vacuum, temperature, and time sensitive valves and switches
 - Electronic controls
 - Hoses, belts, connectors, and assemblies
9. Engine components damaged due to a failure under warranty of a warranted part.

* The original spark plug(s) are warranted for the period of replacement indicated in the Owner's/Operator's Manual and not the useful life of the specialty vehicle engine (see your Owner's Manual).

DURING THE PERIOD OF THIS WARRANTY

Yamaha Motor Manufacturing Corporation of America will repair or replace any warranted part deemed defective by Yamaha during the scope of the warranty without charge to the owner, including parts, labor, and diagnosis. This work must be done at an authorized Yamaha dealer. Give notice to an authorized Yamaha dealer of any apparent defect(s) within a reasonable period of time after discovery. The specialty vehicle engine must be made available for inspection by an authorized Yamaha dealer.

OWNER'S RESPONSIBILITY: The owner of the specialty vehicle engine is responsible for the performance of required maintenance (see your Owner's/Operator's Manual). Receipts and maintenance records covering the performance of regular maintenance should be retained in the event questions arise concerning maintenance. The receipts should be transferred to each subsequent owner of this specialty vehicle engine.

The emission control systems of your Yamaha specialty vehicle engine were designed, built, tested, and certified as being in conformity with California emission control regulations using genuine Yamaha parts. Accordingly, it is recommended that any replacement part(s) used for maintenance, replacement, or repair of emission control systems be Yamaha parts. The owner may elect to have maintenance, replacement, or repair of the emission control devices and systems performed by any repair establishment or individual, and may elect to use parts other than Yamaha parts for such maintenance, replacement, or repair without invalidating this warranty. However, the cost of such service or parts will not be covered under the warranty.

EXCLUSIONS: No warranty coverage will be allowed if the part(s) failure was caused by owner/operator abuse, neglect, tampering, improper adjustment unless performed by a dealer during warranty repair work, modification, misuse, alteration, or improper maintenance (see your Owner's/Operator's Manual).

Use of parts which are not qualitatively equivalent to genuine Yamaha parts, improper service, or lack of required maintenance which causes failure of a warranted part may constitute abuse and/or improper service, thereby invalidating warranty liability hereunder.

This warranty does not cover damage resulting from accidents, acts of nature, or other events or occurrences beyond the control of Yamaha. Yamaha Motor Manufacturing Corporation of America expressly disclaims responsibility for any and all consequential damages, such as loss of time, inconvenience, loss of use of the specialty vehicle, or commercial loss.

Yamaha Motor Manufacturing Corporation of America
1000 Hwy. 34 East
Newnan, GA 30265

IMPORTANT LABELS

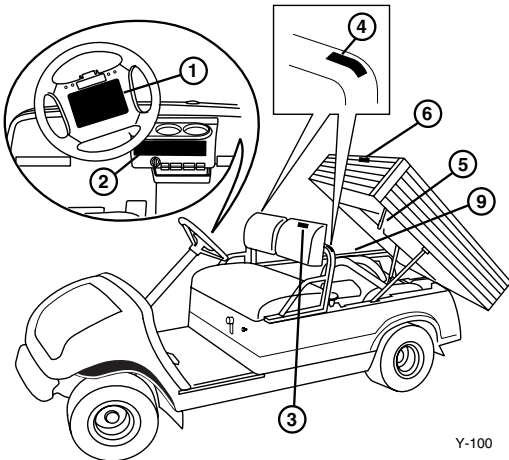

⚠ SAFETY AND INSTRUCTION LABELS

⚠ WARNING

Please read the following labels carefully before operating your utility car, and promptly replace any labels which become damaged or removed.

1

OPERATING INSTRUCTIONS

- Read the warning label on the beverage holder panel before operating.
- Be sure occupants are seated.
- Select "FORWARD" or "REVERSE" then turn main switch to "ON".
- Press the accelerator pedal to start moving. The motor will start and the parking brake will release automatically.
- To stop, release the accelerator pedal and press the brake pedal.
- Never travel at speeds too fast for the terrain, visibility conditions, or your experience.
- Drive with extra caution in congested areas, when operating in reverse, and when driving on wet, rough, or loose surfaces.
- Come to a complete stop before reversing direction.
- Press the parking brake pedal until it locks, and turn the main switch to "OFF" before leaving the vehicle.
- Read the Owner's/Operator's Manual for more information.

Parking Brake Pedal

Accelerator Pedal

ATTENTION

- This vehicle was not manufactured for use on public streets and does not comply with federal motor vehicle safety standards applicable to passenger cars.

YAMAHA JJ3-K7762-01

2

VEHICLE LOADING CAUTION

- Read owner's manual before loading or towing a trailer.
- Maximum cargo bed load - 800 lbs.
- Vehicle rated capacity (driver, passenger, cargo, trailer, and load) 1300 lbs. on level surface.
- Do not operate on steep hills when fully loaded.
- Cargo should be evenly spread in cargo bed as far forward as possible.
- Secure loads to prevent shifting.
- Keep load as low as possible. Drive slowly when loaded. No top heavy loads.
- Maximum trailer hitch tongue weight - 100 lbs.

⚠ WARNING

Failure to follow these instructions can result in severe personal injury or death.

- Operation by authorized adults only and only in designated areas.
- This vehicle is restricted to two occupants.
- Do not start the vehicle until all occupants are seated.
- Remain seated and hold on while in motion.
- Keep entire body inside vehicle.
- Drive slowly in turns.
- Drive slowly straight up and down slopes.
- Set parking brake before leaving vehicle.
- Turn main switch to "OFF" and remove key when not in use.
- Read operating instructions on steering wheel before operation.
- Do not operate while under the influence of alcohol or drugs.

YAMAHA JJ3-K7763-00

3

⚠ WARNING

Do not open / close bed with seat occupied

JJ3-K7762-00

4

⚠ WARNING

Pinch point

JJ3-K7763-00

5

⚠ WARNING

▲ OPEN

▲ LATCHED

- Keep hands, body, other persons, away when closing bed.
- Do not operate the vehicle with bed up.

YAMAHA JJ3-K7764-01

6

⚠ WARNING

No persons in cargo bed

YAMAHA JJ3-K7766-01

IMPORTANT LABELS

2

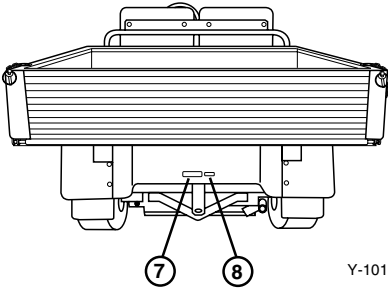

Y-101

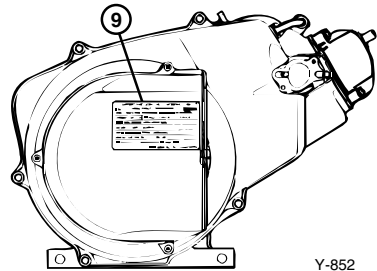

Y-852

⑦

MAXIMUM TOWING CAPACITY - 1000 LB

MAXIMUM TONGUE CAPACITY - 150 LB

YAMAHA

JJ3-K7768-00

⑧

CAUTION

JACK UNDER AXLE

JJ3-K7765-00

⑨

IMPORTANT ENGINE INFORMATION				YAMAHA	
EM ENGINE FAMILY : *****					
REFER TO OWNER'S MANUAL FOR MAINTENANCE SPECIFICATIONS AND ADJUSTMENTS.					
DISPLACEMENT:	*** cm ³	VALVE LASH(mm)	IN: **~**	EX: **~**	
IGNITION TIMING & IDLE MIXTURE	NO OTHER ADJUSTMENTS NEEDED.				
IDLE SPEED:	****	rpm	AT NO LOAD		
FUEL: THIS ENGINE IS CERTIFIED TO OPERATE ON UNLEADED GASOLINE.					
ENGINE OIL:	SAE 10W-30	TYPE	SD		
<small>THIS ENGINE MEETS 1986-1998 CALIFORNIA EMISSION REGULATIONS FOR SPECIALTY VEHICLES BELOW 23HP. THIS ENGINE CONFORMS TO ***** U.S. EPA REGULATIONS FOR SMALL NONROAD ENGINES.</small>					
YAMAHA MOTOR CO.,LTD. JR3-2179R-00					

Y-851

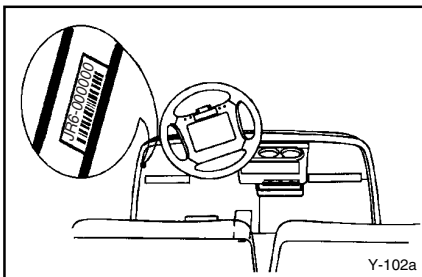

Y-102a

UTILITY CAR SERIAL NUMBER

The utility car serial number is stamped in the location shown.

NOTE: _____

The first three digits of the serial number are for model identification; the remaining digits are the unit production number. Keep a record of these numbers for reference when ordering parts from a Yamaha dealer.



OPERATOR SAFETY

Yamaha utility cars are designed to be simple to operate. However, be sure to observe the following:

BEFORE OPERATING THE UTILITY CAR



Y-8



Y-68

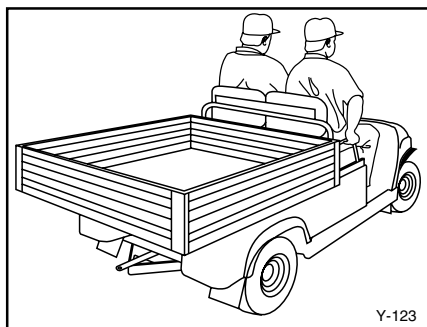

Y-123

- Read this Owner's/Operator's manual and all safety and instruction labels on the utility car before operating.
- Perform the pre-operation checks found in Section 6 of this manual.
- Only authorized people should drive the utility car, from the driver's side only, and only in designated areas.
- Do not allow more than two people to ride in the utility car. This utility car is restricted to two occupants.
- Do not operate the utility car while under the influence of alcohol or drugs; their affect on vision and judgment make operating a utility car dangerous.
- Do not operate the utility car on public streets, roads or highways. Such use is prohibited by law, and dangerous. Operation on public roads can result in collision with other vehicles.

WHILE OPERATING THE UTILITY CAR

- Keep your entire body inside the utility car, remain seated, and hold on when the car is in motion.
- Do not start the utility car until all occupants are seated.



OPERATOR SAFETY

3

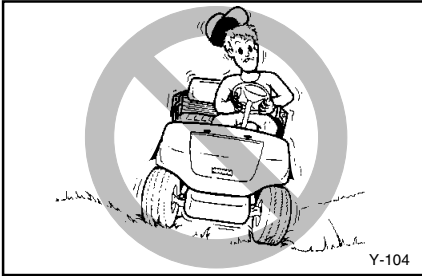

- Keep your hands on the steering wheel and your eyes on the path ahead.
- Use extra care in congested areas or when backing up. Always back up slowly, and watch carefully.
- Avoid starting or stopping abruptly.
- Vary the speed of the utility car to match the terrain of your surroundings.
- Avoid turning the steering wheel too sharply at higher speeds.
- Always drive slowly straight up or straight down slopes – never at an angle.
- Do not run the engine indoors. Exhaust gas is poisonous.
- Do not make any modification or addition which affects capacity or safe operation, or make any changes not in accordance with the owner's/operator's manual.
- All occupants should remain inside the vehicle. Remain seated, and hold on when the car is in motion.



OPERATOR SAFETY

LOADING/TOWING

- Do not drive across the face of slope.
- Avoid poor driving conditions such as wet lawns and rough surfaces. Vehicle handling and stability may be reduced.

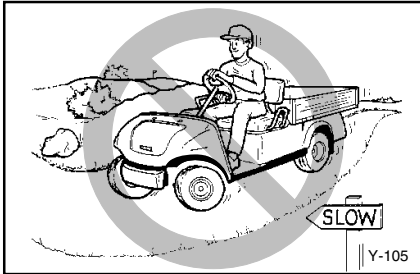

- Stop the engine, remove ignition key and make sure trailer is correctly installed before towing trailer.
- Do not allow people to ride in cargo bed or trailer.
- Reduce speed and exercise extreme caution when carrying cargo or towing a trailer, which could affect handling, control, stability, and braking performance.

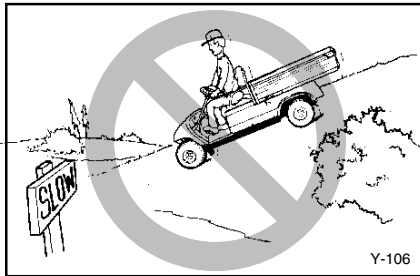

- When driving on slopes, reduce speed and avoid sudden starts or stops.

Excessive speed or sudden starts or stops could cause loss of control and could lead to vehicle overturning. Abrupt starts going uphill or abrupt braking backing down a slope could cause the front wheels to lift off the ground, reducing control and increasing the chance of an accident.

- Do not tow with any point except specified hitch point and never exceed maximum specified weight on hitch point.
- Do not operate on steep hills when fully loaded.
- Do not exceed the maximum load limit.

⚠ WARNING

Be sure to check "LOADING/TRAILER TOWING" carefully before loading or towing (See page 7-2).

MAINTENANCE SAFETY PROGRAM

MAINTENANCE REQUIRED FOR UTILITY CAR SAFETY

Practice the following to help ensure the safety of utility car operators:

- **Preventative Maintenance.** Perform all scheduled maintenance in accordance with manufacturer's recommendations to provide the user with a safe, properly operating utility car.
- **Personnel.** Allow only qualified, trained, and authorized personnel to inspect, adjust, and maintain utility cars.
- **Parts and Materials.** Use only replacement parts and materials recommended by Yamaha.
- **Ventilation.** Properly ventilate all maintenance and storage areas in accordance with applicable fire codes and ordinances to avoid fire hazards. Ventilation is required to remove flammable vapors and fumes from gasoline powered car storage areas.

SAFETY PRECAUTIONS DURING MAINTENANCE

When performing maintenance, follow all safety instructions contained in the manufacturer's operation and service manuals, as well as the following safety procedures:

- Properly immobilize utility car before beginning any maintenance.

- Properly block chassis before working underneath utility car.
- Before disconnecting any part of the fuel system, drain the applicable part of the system to prevent fuel leaks.
- Avoid fire hazards, and have appropriate fire protection equipment available.
- Maintain all safety devices including brakes, steering mechanisms, warning devices, and governors, in a safe operating condition. Do not modify these safety devices as supplied by the manufacturer.
- After each maintenance or repair, the car must be driven by a qualified, trained, and authorized person – in an area free of pedestrian traffic – to ensure proper operation and adjustment.
- Record all maintenance performed in a maintenance record log by date, name of person performing maintenance, and type of maintenance. Periodically inspect maintenance log to ensure accurate and complete entries.
- Maintain in a legible condition all nameplates, warnings, and instructions provided by the manufacturer.
- If new nameplates, warnings, or instructions are needed, contact your Yamaha dealer.

MAINTENANCE SAFETY PROGRAM

FUEL HANDLING/ STORAGE AND BATTERY CHARGING

Take the following precautions to ensure maintenance worker safety:

- Supervise the storage and handling of liquid fuels in accordance with applicable fire and safety requirements.
- Only use battery changing and charging facilities and procedures that are in accordance with applicable ordinances and regulations.
- Periodically inspect fueling and charging facilities and procedures to be certain that applicable safety codes, regulations, and procedures are being followed.

CONTROLS

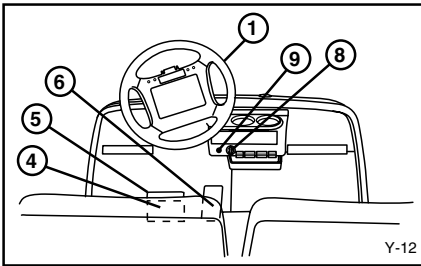

FEATURES

- ① Steering wheel
- ② Seat
- ③ Battery
- ④ Brake pedal
- ⑤ Parking brake pedal
- ⑥ Accelerator pedal
- ⑦ Drive selector lever
- ⑧ Main switch
- ⑨ Oil warning light
- ⑩ Choke knob
- ⑪ Front cowl
- ⑫ Front tire
- ⑬ Front bumper
- ⑭ Rear cowl
- ⑮ Rear tire
- ⑯ Fuel cap

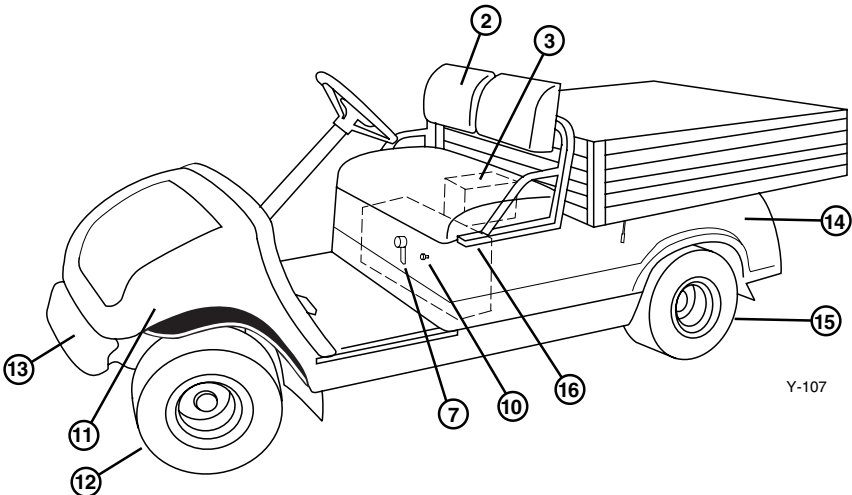

CONTROLS

MAIN SWITCH

The main switch controls the following items:

OFF

Ignition circuit is switched off.
The key can be removed only in this position.

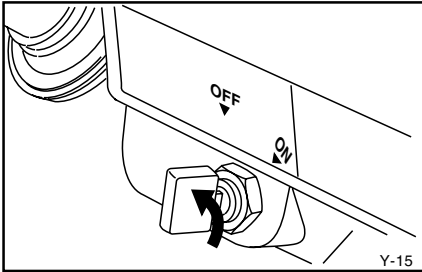

ON

Electrical circuits are switched on.
The utility car can be driven.

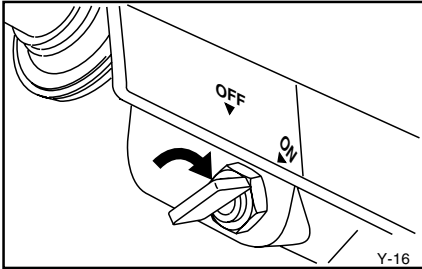

OIL WARNING LIGHT

When the engine oil level falls below an acceptable level, this light comes on. **If the light comes on, stop the engine, check the engine oil level, and add oil as necessary. (See page 6-4).**

(A) Oil warning light

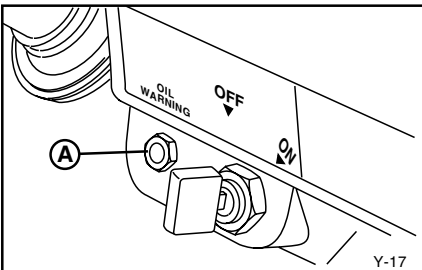

CONTROLS

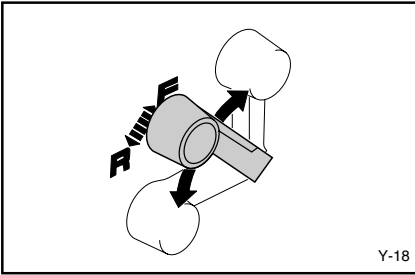

DRIVE SELECT LEVER

The drive select lever is used to shift the utility car into forward or reverse. After coming to a complete stop, move the lever to the desired position.

Lever Position	Car Movement
F	FORWARD
R	REVERSE

NOTE:

The back-up buzzer will sound when the drive select lever is turned to "R."

5

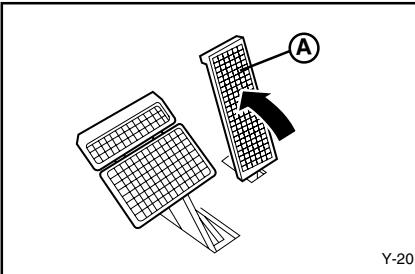
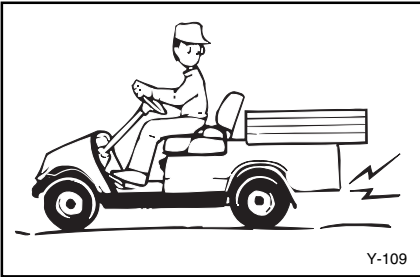

ACCELERATOR PEDAL

The accelerator pedal controls the utility car's speed.

Action	Car Speed
Depress pedal	Increase
Release pedal	Decrease

(A) Accelerator pedal

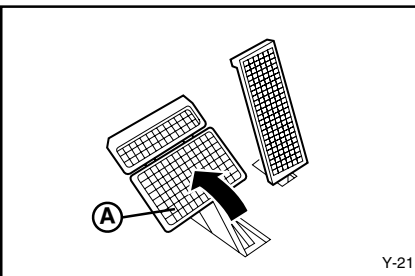

BRAKE PEDAL

Press down on the brake pedal to stop the utility car.

(A) Brake pedal

CONTROLS

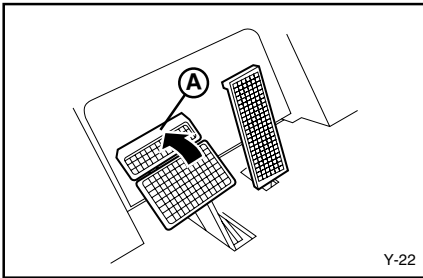

PARKING BRAKE PEDAL

Press down on the parking brake pedal whenever parking the utility car.

- Ⓐ Parking brake pedal

NOTE:

Release the parking brake by depressing the accelerator pedal.

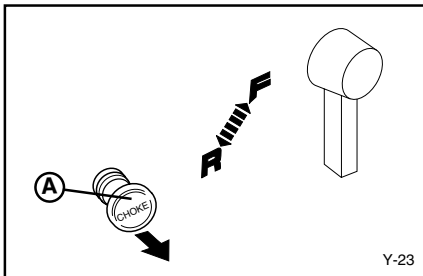

CHOKE KNOB

Pull and hold out choke knob when starting a cold engine. Release the knob after the engine starts.

- Ⓐ Choke knob

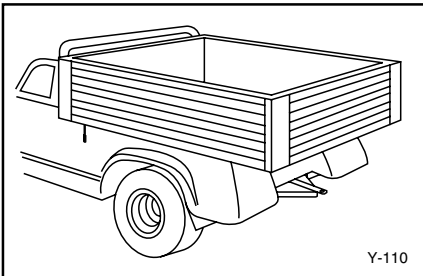

TOW HITCH

Use the tow point within the specified weight limits.

- ① Tow point

* Tow weight	590 kg (1300 lb)
Tongue weight	68 kg (150 lb)

⚠ WARNING

Do not drive the machine over a walking speed of 5 km/h (3 mph) while towing. Otherwise, an accident could result.

- * Including driver, passenger, vehicle cargo and trailer cargo, on level ground.

PRE-OPERATION CHECKS

Pre-operation checks should be made each time you use your utility car. Get in the habit of performing the following checks in the same way so that they become second nature.

⚠ WARNING

- **Be sure the main switch key is removed before performing the pre-operation checks to prevent accidental starting, and apply the parking brake to keep the car from moving.**
- **During the pre-operation checks, avoid touching engine parts or the muffler while they are still hot.**

PRE-OPERATION CHECKLIST

Before each use check the following:

- ✓ Fuel system
- ✓ Engine oil level
- ✓ Battery
- ✓ Tire condition
- ✓ Steering system
- ✓ Back-up buzzer
- ✓ Pedal operation
- ✓ Body and chassis

SEAT

Open the seat and lift the cargo bed for checking and servicing.

- (A) Seat
- (B) Prop rod

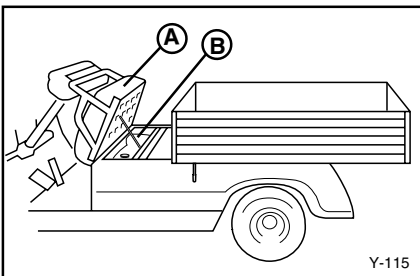

Y-115

PRE-OPERATION CHECKS

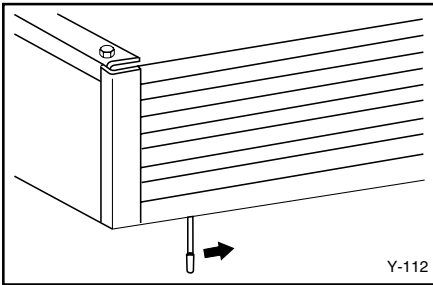

CARGO BED

Lift the cargo bed for engine servicing.

1. Pull the bed latch towards the rear with right hand.
2. Lift the cargo bed with left hand.
3. Lift the cargo bed up until the prop rod latches in place.

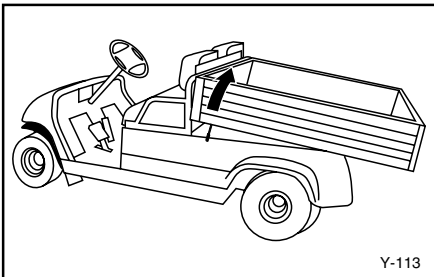

⚠ WARNING

- Remove the main switch key and apply the parking brake before lifting the cargo bed. Otherwise the vehicle could unexpectedly move.
- Never drive the car with the bed in the up position. Injury could occur if the bed fell accidentally.
- Before closing the bed, be sure others are standing away from the car and that no one is sitting on the seat. Keep hands and fingers away from the pinch point between the bed and seat back.

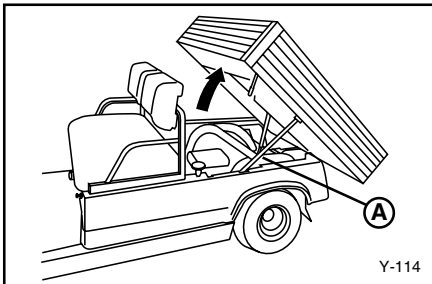

Ⓐ Prop rod

PRE-OPERATION CHECKS

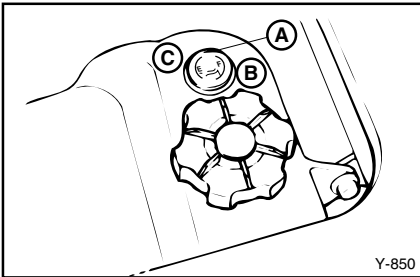

FUEL SYSTEM

Make sure there is sufficient fuel in the tank, and check fuel line and connections for leakage.

- (A) Fuel level gauge
- (B) "F" Full
- (C) "E" Empty

⚠ WARNING

Gasoline and its vapors are highly flammable and explosive.

- Do not smoke when refueling and keep away from sparks, flames, or other sources of ignition.
- Stop engine and allow it to cool for several minutes before refueling.
- Refuel in a well-ventilated area.
- Take care not to spill gasoline. If gasoline spills, wipe it up immediately with dry rags. Always dispose of gasoline-soaked rags properly.
- Tighten the filler cap securely after refueling.
- If you swallow gasoline, inhale a lot of gasoline vapor, or get gasoline in your eyes, get immediate medical attention.
- If any gasoline gets on your skin, immediately wash with soap and water. Change clothing if gasoline spills on it.

Recommended fuel:
Unleaded gasoline

Fuel tank capacity:
6.3 US gal
(24.0 L, 5.3 Imp gal)

CAUTION

Avoid using gasoline blended with methyl alcohol which can damage fuel system parts.

PRE-OPERATION CHECKS

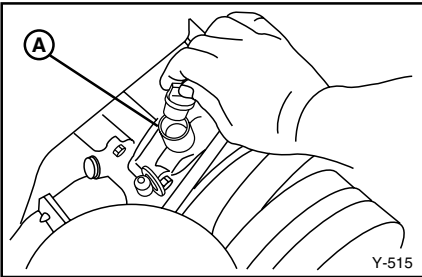
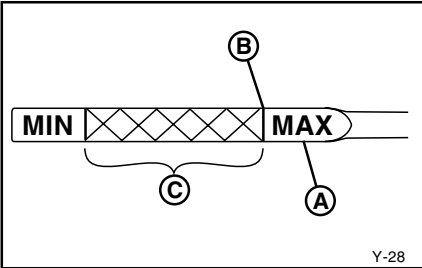
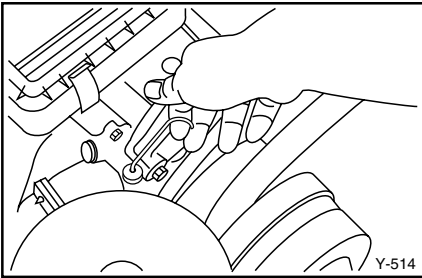

Recommended oil:
YAMALUBE 4-cycle oil or
SAE 10W-30

Engine oil capacity:
1.16 US qt
(1.1 L, 0.24 Imp gal)

Oil change quantity:
1.0 US qt
(0.9 L, 0.19 Imp gal)

ENGINE OIL

With the utility car parked on level ground, remove the dipstick and make sure the engine oil is between the MIN and MAX marks (the crosshatched area on the end of the dipstick).

- (A) Oil level dipstick
- (B) Maximum oil level
- (C) Safe operating range

If the oil level is **below** the MIN mark on the dipstick, add oil through the oil filler hole until the oil level is between the MIN and MAX marks.

- (A) Oil filler hole

CAUTION

- Use care not to fill past the MAX dipstick mark, and be sure no foreign material enters the crankcase.
- Use care not to get oil on the starter belt.

NOTE:

The distance between the dipstick marks represents approx. 1/2 US qt (1/2 L) of oil.

NOTE:

Recommended engine oil classification: API Service SE, SF, or SG. Engine oils labeled "Energy Conserving II" are recommended.

PRE-OPERATION CHECKS

BATTERY

Check that the battery is held securely in place to prevent the battery from being damaged from vibration or jarring. Also check that no battery caps are missing to prevent battery acid from spilling from the battery. Check the battery terminals for corrosion.

TIRE CONDITION

Tire Air Pressure

Check the tire air pressure before operating the utility car.

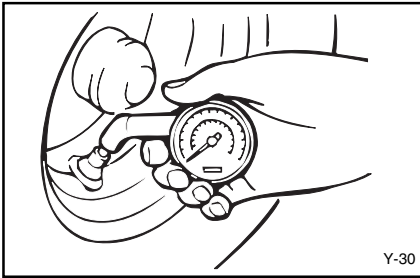

Tire pressure:
For G21-A:
Front Tires
20 - 23 psi
(140 - 160 kPa, 1.4 - 1.6 kgf/cm²)
Rear Tires
29 - 31 psi
(197 - 217 kPa, 2.0 - 2.2 kgf/cm²)

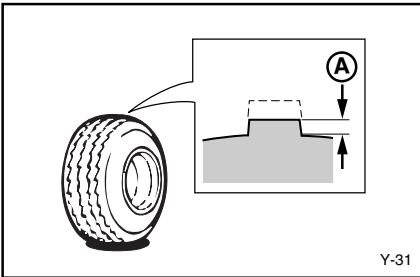

Tire Wear Limit

Check the tire surface for damage, cracks or embedded objects. When tire tread wears down to 0.04 in. (1 mm), replace the tire.

Ⓐ Wear limit

PRE-OPERATION CHECKS

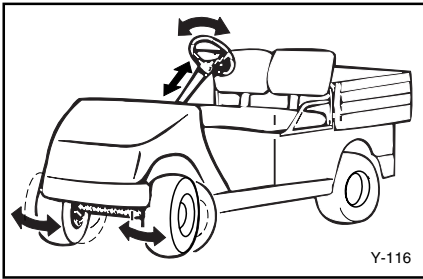

STEERING SYSTEM

Check the steering system for excessive freeplay by:

- moving the steering wheel up and down, and back and forth.
- turning the steering wheel slightly to the right and left.

If you feel excessive freeplay, or hear rattling sounds which may indicate loose steering components, consult a Yamaha dealer.

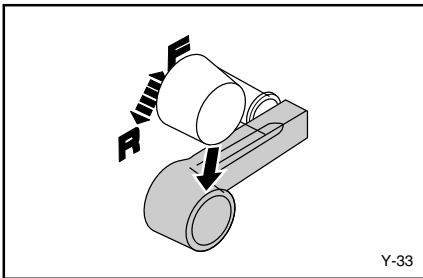

BACK-UP BUZZER

Check the back up buzzer by moving the drive select lever to "R" for reverse. The buzzer should sound.

6

PEDAL OPERATION

Check the following pedal controls for proper operation. If a pedal does not work properly, consult a Yamaha dealer.

Brake Pedal

Make sure the brake pedal feels firm when pressed and returns to its original position when released.

- Ⓐ Brake pedal

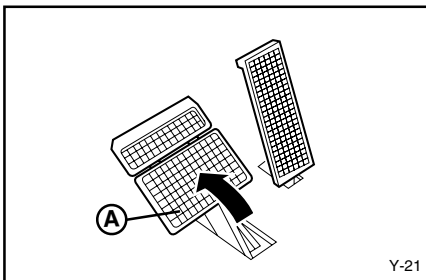

PRE-OPERATION CHECKS

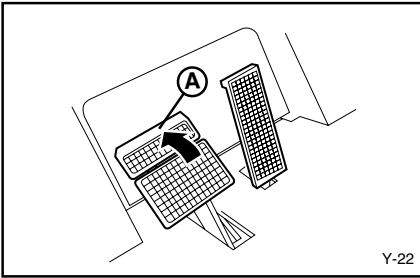

Parking Brake Pedal

Make sure the parking brake pedal locks in place with a positive click, and releases when the accelerator pedal is pressed.

Ⓐ Parking brake pedal

NOTE:

Release the parking brake by depressing the accelerator pedal.

Accelerator Pedal

⚠ WARNING

Before checking operation of the accelerator pedal, be sure the main switch is in the "OFF" position.

Make sure the accelerator pedal operates smoothly.

Ⓐ Accelerator pedal

6

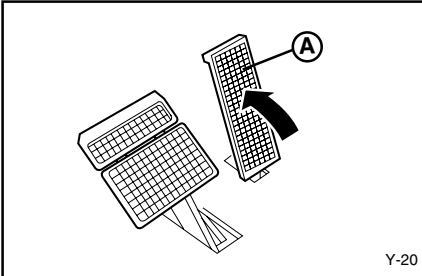

BODY AND CHASSIS

Before each use, visually inspect the utility car body and chassis for damage and/or missing parts.

OPERATION

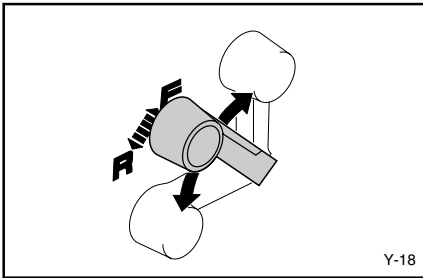

STARTING

1. With the parking brake applied, turn the drive select lever to "F" for forward, or "R" for reverse.

CAUTION

Do not shift from "F" forward to "R" reverse while the utility car is moving.

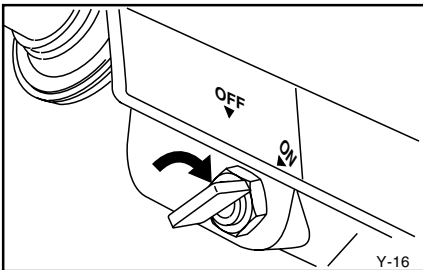

2. Turn the main switch to "ON."

WARNING

Do not depress the accelerator pedal when turning on the main switch or the utility car may suddenly start moving.

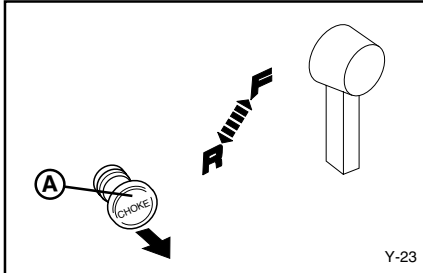

3. Pull the choke knob out and hold it while starting. Release the choke knob after the engine starts.

(A) Choke knob

NOTE:

The choke is not required when the engine is warm.

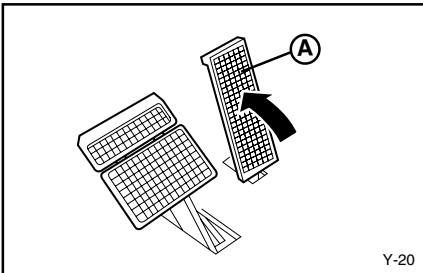

4. Check that your path is clear in the direction you plan to go, and slowly depress the accelerator pedal. The utility car will start to move.

(A) Accelerator pedal

NOTE:

The parking brake automatically releases when the accelerator pedal is depressed.

OPERATION

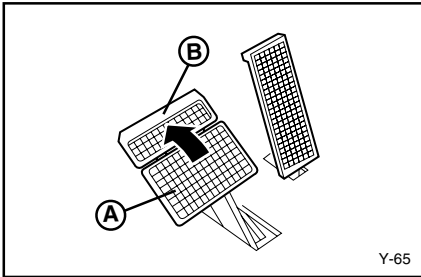

STOPPING

To stop the utility car, gradually press down on the brake pedal.

(A) Brake pedal

When the car has come to a stop, apply the parking brake pedal and turn the main switch to "OFF."

(B) Parking brake pedal

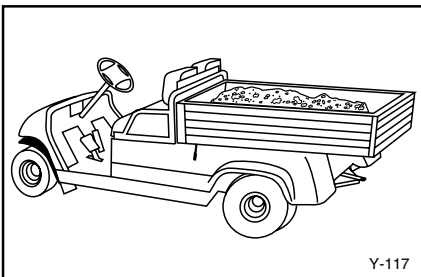

CAUTION

Do not hold the utility car on an incline with the accelerator – use the brake.

LOADING/TRAILER TOWING

⚠ WARNING

Be sure to check "SAFETY INFORMATION" carefully before loading or towing. (See page 3-3)

⚠ WARNING

- Do not exceed the maximum loading limits. An overloaded vehicle can be unstable.
- Keep load as low as possible. Drive slowly when cargo is loaded. No top heavy loads.
- Secure loads to prevent shifting.
- Cargo should be evenly spread in cargo bed as far forward as possible the center of gravity may affect the handling, steering, and braking performance.
- Make sure cargo in the trailer cannot move around. A shifting load can cause an accident.

7

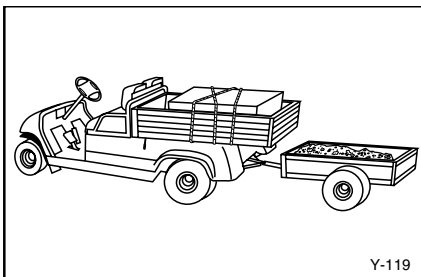

MAXIMUM LOADING LIMIT

- Maximum cargo bed load:
363 kg (800 lb)
- Tow hitch
Tow weight (Including driver, passenger, vehicle cargo and trailer and trailer cargo):
590 kg (1300 lb)
Tongue weight:
68 kg (150 lb)

MAINTENANCE

PERIODIC MAINTENANCE CHARTS

Regular maintenance is required for the best performance and safe operation of your utility car.

⚠ WARNING

Be sure to turn off the main switch and apply the parking brake when you perform maintenance unless otherwise specified. If the owner is not familiar with machine servicing, this work should be done by a Yamaha dealer or other qualified mechanic.

FOR G21A

C - CHECK CA - CHECK AND ADJUST R - REPLACE S - SERVICE CL - CLEAN AND LUBRICATE L - LUBRICATE

	Remarks	Pre-Operation	20 Rounds 20 hrs 100 miles 160 kms (Every month)	125 rds 125 hrs 600 mls 1000 kms (Every 6 months)	250 rds 250 hrs 1200 mls 2000 kms (Every year)	500 rds 500 hrs 2500 mls 4000 kms (Every 2 years)	1000 rds 1000 hrs 5000 mls 8000 kms (Every 4 years)	Page
PRE-OPERATION CHECKS	Check engine oil	C	C	C				6-4
	Check air cooling duct	C	C	C	C	C	C	*
	Check fuel lines for leakage	C	C	C	C	C	C	6-3
	Check fuel level	C	C	C	C	C	C	6-3
	Check for looseness and corrosion of battery terminals and hold downs	C	C	C	C	C	C	6-5
	Check brake pedal freeplay and adjust if necessary	C	CA	CA	CA	CA	CA	8-12
	Check steering operation	C	C	C	C	C		6-6
	Check tire pressure, tread depth, tire surface for damage	C	CA	CA	CA	CA	CA	6-5
	Check body and chassis for damage	C	C	C	C	C	C	6-7
EVERY MONTH	Check tightness of all bolts, nuts, and screws	C	C	C	C	C	C	*
	Check reverse buzzer operation	C	C	C	C	C	C	6-6
	Check fuel filter for clogging		C	C	C	C	C	*
	Check wear of drive belt		C	C	C	C	C	8-8
EVERY 6 MONTHS	Check operation of Forward / Reverse shifting		C	C	C	C	C	-
	Clean / Lube pedal control area		CL					-
	Wash pre-filter, check air cleaner element			S	S	S	S	8-6
EVERY 6 MONTHS	Check spark plug and plug cap condition** / Check compression			C	C	C	C	8-4/*
	Check shock absorbers for oil leaks and damaged springs			C	C	C		*

* Items with out a page number reference should be serviced by a Yamaha dealer or other qualified mechanic. This manual does not contain these procedures. They are contained in the Service Manual.

**Related to emission control system.

MAINTENANCE

C - CHECK CA - CHECK AND ADJUST R - REPLACE S - SERVICE CL - CLEAN AND LUBRICATE L - LUBRICATE

	Remarks	Pre-Operation	20 Rounds 20 hours 100 miles 160 kms (Every month)	125 rds 125 hrs 600 mis 1000 kms (Every 6 months)	250 rds 250 hrs 1200 mis 2000 kms (Every year)	500 rds 500 hrs 2500 mis 4000 kms (Every 2 years)	1000 rds 1000 hrs 5000mis 8000 kms (Every 4 years)	Page
EVERY YEAR	Replace engine oil				R	R	R	8-5
	Adjust throttle cables,** choke cable, check carburetor throttle shaft for wear**				CA	CA	CA	*
	Check starter V-belt for damage and tension				C	C	C	*
	Check drive belt for slippage, wear or scratches				C	C	C	8-8
	Check sliding sheave and ramp shoes; Grease secondary sheave bearing.				CL	CL	CL	*
	Grease primary sheave				L	L	L	*
	Check operation of speed limiter				C	C	C	*
	Apply battery terminal protectant				S	S	S	-
	Check wiring connections and insulation				C	C	C	-
	Check shoe lining thickness and rear axle bearing play				C	C	C	*
	Check kingpin play, seal, and cap / Adjust wheel alignment				CA	CA	CA	*
	Check wheel nut tightness, front wheel bearing play				C	C	C	*
	Check gear box oil level and leakage				C	C	C	8-10
	Check operation and adjust pedal stop if necessary				CA	CA	CA	*
EVERY 2 YEARS	Check brushes for wear and commutator for dirt					C	S	*
EVERY 4 YEARS	Replace fuel filter and fuel hoses						R	*
	Check tightness of cylinder head / Adjust valves						CA	*
	Replace gear box oil						R	8-10
	Check for grease leakage; adjust gearbox if necessary						CA	*

* Items with out a page number reference should be serviced by a Yamaha dealer or other qualified mechanic. This manual does not contain these procedures. They are contained in the Service Manual.

** Related to emission control system.

MAINTENANCE

EXHAUST EMISSION CONTROL SYSTEM AND COMPONENTS

Item	Acronym
<ul style="list-style-type: none">CARB. ASSY., LH., JT., CARBURETOR 2 & JT., CARBURETOR 1	CARB (Carburetor)
<ul style="list-style-type: none">T.C.I. MAGNETO ASSY. & PLUG, SPARK	EI (Electronic Ignition)
<ul style="list-style-type: none">CRANKCASE 1 & HEAD, CYLINDER 1	PCV (Positive Crankcase Ventilation)
<ul style="list-style-type: none">AIR FILTER ASSY.	ACL (Air Cleaner)
<ul style="list-style-type: none">MUFF., 2	

The above items and the corresponding acronyms are provided in accordance with U.S. EPA REGULATIONS FOR SMALL NONROAD ENGINES and the CALIFORNIA REGULATIONS FOR NEW 1995 AND LATER OFF-HIGHWAY RECREATIONAL VEHICLES AND ENGINES.

The acronyms conform to the latest version of the SAE's recommended practice document J1930, "Diagnostic Acronyms, Terms, and Definitions For Electrical/Electronic System".

It is recommended that these items be serviced by a Yamaha dealer or other qualified mechanic.

MAINTENANCE

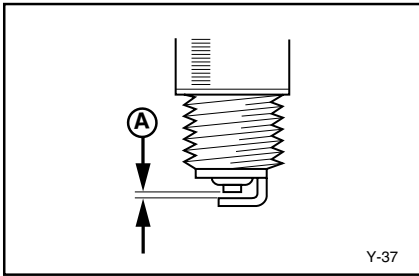
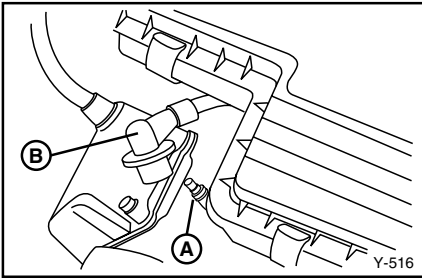

Spark Plug Inspection

You should periodically remove and inspect the spark plug. Dirty or worn spark plugs can cause poor performance.

- Ⓐ Spark plug
- Ⓑ Spark plug cap

1. Check for discoloration and heavy carbon deposits. The normal electrode color will be tan. If it is not, replace it.
2. Check the spark plug type, and check the spark plug gap with a feeler gauge.

Standard spark plug:
BPR2ES or BPR4ES

Spark plug gap:
0.028 ~ 0.031 in (0.7 ~ 0.8 mm)

- Ⓐ Gap

3. Clean the gasket and plug surfaces and install the spark plug finger tight before tightening to the following torque:

Spark plug torque:
14.5 ft·lb
(20 Nm, 2.0 m·kg)

⚠ WARNING

When removing or installing the spark plug, be careful not to damage the insulator. A damaged insulator could allow external sparks, which could lead to explosion or fire.

MAINTENANCE

Engine Oil Replacement

1. Warm up the engine for several minutes, place the utility car on a level surface, then stop the engine.

⚠ WARNING

Use caution not to touch hot engine oil or hot engine parts, during the following procedure.

2. Place an oil pan under the engine drain plug.
3. Remove the oil drain plug and let the oil drain completely.

NOTE:

Dispose of used oil in an environmentally safe way, such as taking oil to an oil collection station.

4. Install the drain plug, along with a new drain plug gasket, finger tight before tightening to the following torque:

Drain plug torque:
23 ft·lb
(31 Nm, 3.1 m·kg)

5. Add the correct quantity of oil through the oil filler hole.

NOTE:

Recommended engine oil classification: API Service SE, SF, or SG. Engine oils labeled "Energy Conserving II" are recommended.

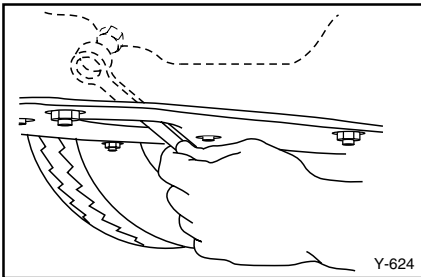

Recommended oil:
YAMALUBE 4-cycle oil or
SAE 10W-30

Engine oil capacity:
1.16 US qt
(1.1 L, 0.24 Imp gal)

Oil change quantity:
1.0 US qt
(0.9 L, 0.19 Imp gal)

MAINTENANCE

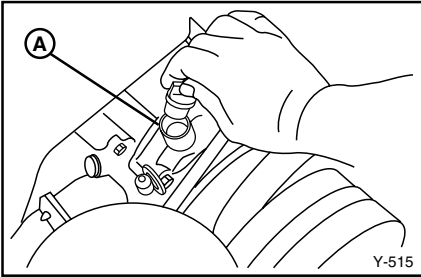

(A) Oil filler hole

CAUTION

Use care not to fill past the MAX dipstick mark, and be sure no foreign material enters the crankcase. After replacing engine oil, check for oil leaks around the drain plug. If oil leaks are found, consult a Yamaha dealer.

Air Filter

To remove the air filter elements:

1. Unlatch the air filter cover clips and remove cover.

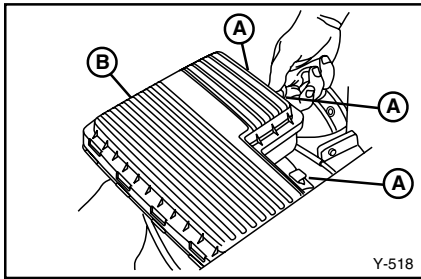

- (A) Air filter cover clips
- (B) Air filter cover

2. Lift the air filter and pre-filter out of the air filter case.

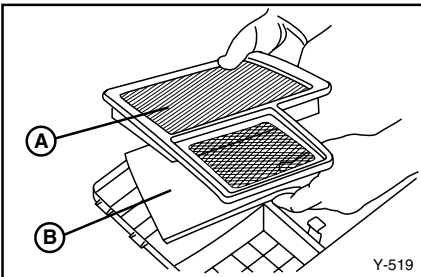

- (A) Air filter
- (B) Pre-filter

CAUTION

Be careful not to drop anything into the air inlet.

MAINTENANCE

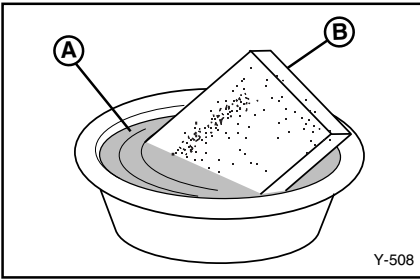

Inspection and cleaning:

3. Wash the foam pre-filter in soap and water. Allow it to dry.
4. Check the filter element. If damaged or dirty, replace it.

- Ⓐ Soap and water
- Ⓑ Foam element

CAUTION

Do not wring out the foam pre-filter, this could cause it to tear.

5. To replace the elements, reverse the above steps.

CAUTION

The pre-filter has a notch on one side. It will only fit in the case one way.

MAINTENANCE

Drive Belt

To remove the drive belt:

1. Set the drive select lever halfway between forward and reverse.
2. Pull up on the drive belt and push it outward over the edge of the secondary sheave.
3. Turn the secondary sheave clockwise and the drive belt will roll off the sheave.
4. Remove the drive belt from the primary sheave.

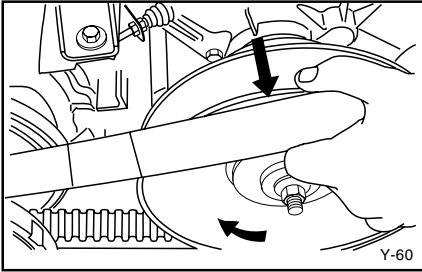

Inspection:

To inspect the drive belt, check for frayed edges or tears, and measure drive belt against the following specification. If the belt shows excessive wear or damage, replace the belt with a new one.

- Ⓐ New: 1.22 in. (31.0 mm)
- Ⓑ Replace when belt reaches: 1.06 in. (27 mm)

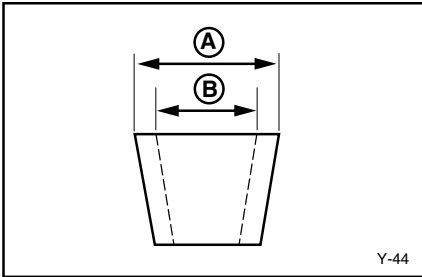

MAINTENANCE

Battery

⚠ WARNING

Battery electrolyte is poisonous and dangerous, causing severe burns, etc. It contains sulfuric acid. Avoid contact with skin, eyes, or clothing.

Antidote:

EXTERNAL: Flush with water.

INTERNAL: Drink large quantities of water or milk. Follow with milk of magnesia, beaten egg, or vegetable oil. Call physician immediately.

EYES: Flush with water for 15 minutes and get prompt medical attention.

Batteries produce explosive gases. Keep sparks, flame, cigarettes, etc., away.

Ventilate when charging or using in enclosed space. Always shield eyes when working near batteries.

KEEP OUT OF REACH OF CHILDREN.

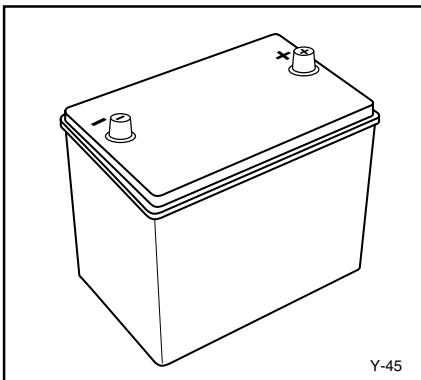

The 12-volt battery that provides starting power to your gas car normally doesn't require the addition of water during the one year warranty period provided by the battery manufacturer. If the battery loses its charge, have an experienced mechanic charge it.

MAINTENANCE

Fuse Replacement

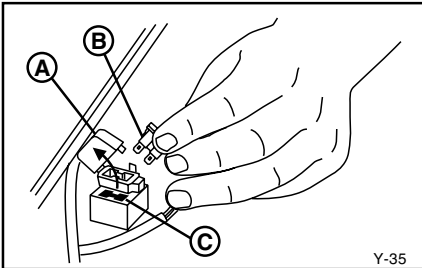

Replacement Fuse:
10 Amp, Blade Style

⚠ WARNING

Be sure to use the specified fuse. Using a wrong fuse can cause electrical system damage and create a fire hazard.

CAUTION

When replacing a fuse be sure the main switch is turned off to prevent accidental short-circuiting.

- (A) Fuse case
- (B) Fuse
- (C) Replacement fuse

Gear Box Oil

To check gear box oil level:

1. Place the utility car on a level surface.
2. Lift the seat and cargo bed.
3. Remove the oil plug (A).

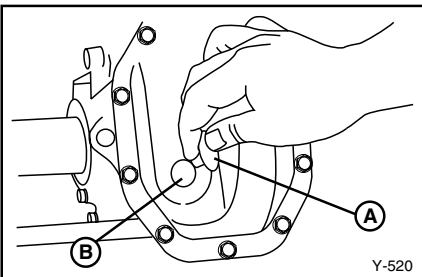
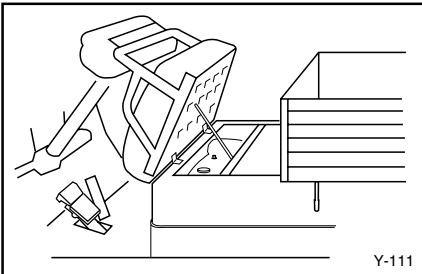

Recommended oil:
SAE 90 gear oil

Gearcase capacity:
0.44 US qt
(0.42 L, 0.09 Imp gal)

MAINTENANCE

- Add gear oil little by little until oil flows from the plug hole (B).
4. Allow excess gear oil to flow out until it stops.

CAUTION

Do not allow foreign material to enter the gear box.

5. Reinstall the oil plug.

NOTE:

For gear oil replacement, consult a Yamaha dealer or other qualified mechanic.

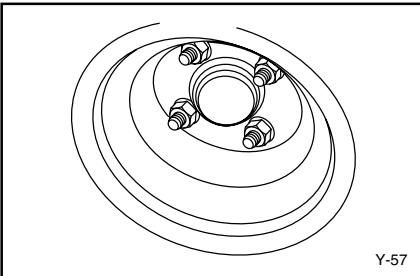

Wheel nut tightening torque:
58 ft·lb (80 Nm, 8.0 m·kg)

⚠ WARNING

Consult your Yamaha dealer before using your utility car if you suspect brake problems. Brake failure could result in a serious accident.

Wheel Replacement

To remove and install a wheel on your utility car:

1. With the wheels blocked to prevent the utility car from moving, loosen the wheel nuts.
2. Elevate the utility car with a jack and remove the wheel nuts and the wheel.
3. Reverse the removal steps when installing the wheel.

Brake Adjustment

The brakes on your utility car are self-adjusting.

Before you operate the car, press down on the brake pedal several times to make sure the brakes are functioning properly.

MAINTENANCE

Brake Pedal Free Play Adjustment

CAUTION

Before adjusting brake pedal free play, pump the brake pedal several times to self-adjust the brakes.

To adjust the brake pedal free play:

1. Remove the service lid from the floor of the utility car.
2. Check the brake pedal free play by pressing against the pedal with two fingers (using light force) and measuring the distance the pedal travels before resistance is felt.

Brake pedal free play:
25-30 mm (0.98-1.18 in.)

3. If the free play distance needs adjusting, loosen the lock nut and turn the adjusting nut in or out (in 180° increments only, due to the cam shape of adjuster), until the free play specification is met. Then tighten the lock nut in place.

⚠ WARNING

Do not overtighten the brake cables. The self adjusters may not operate properly, reducing braking performance.

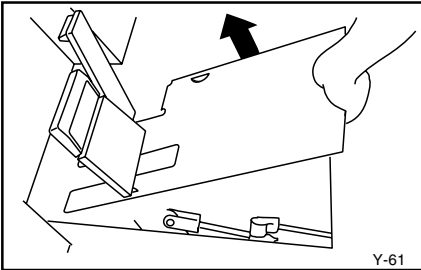

Y-61

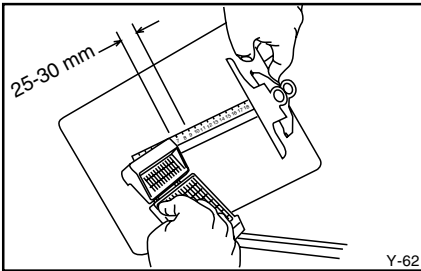

Y-62

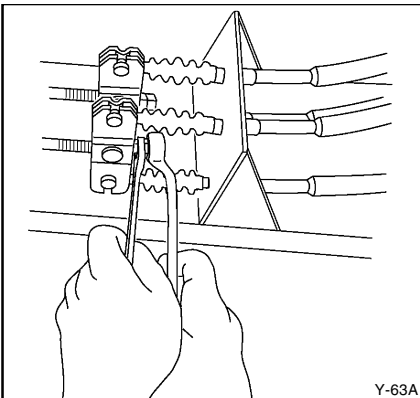

Y-63A

STORAGE

Perform the following preparations when storing your utility car for extended periods of time:

NOTE: _____

Turn main switch key to "OFF" position, remove key, and store key in a safe place.

DRAINING FUEL

⚠ WARNING _____

Gasoline and its vapors are highly flammable and explosive.

- Do not smoke when refueling and keep away from sparks, flames, or other sources of ignition.
 - Stop engine and allow it to cool for several minutes before refueling.
 - Refuel in a well-ventilated area.
 - Take care not to spill gasoline. If gasoline spills, wipe it up immediately with dry rags. Always dispose of gasoline-soaked rags properly.
 - Tighten the filler cap securely after refueling.
 - If you swallow gasoline, inhale a lot of gasoline vapor, or get gasoline in your eyes, get immediate medical attention.
 - If any gasoline gets on your skin, immediately wash with soap and water. Change clothing if gasoline spills on it.
-

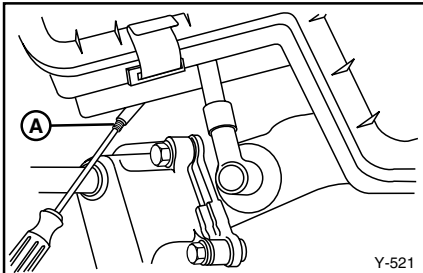

1. Fill the fuel tank.
- Ⓐ Float bowl drain screw
2. Drain the carburetor float bowl into a suitable container by turning the screw located on the bottom of the carburetor.

STORAGE

ENGINE PREPARATION

With the key removed and the spark plug lead disconnected, turn the clutch by hand until compression is felt. This puts the valves in the closed position.

CHASSIS PREPARATION

1. Increase the front tire pressure to 23 psi (160 kPa, 1.6 kgf/cm²) and increase the rear tire pressure to 31 psi (217 kPa, 2.2 kgf/cm²).
2. Clean exterior of the utility car and apply a rust inhibitor.
3. Cover the utility car with a breathable cover and store it in a dry, well-ventilated area.

BATTERY PREPARATION

1. Remove the battery from the utility car and store it in a cool, dry place that stays between 32°F (0°C) and 90°F (30°C).
2. Have the battery recharged every 60-90 days to keep it fully charged. The battery must be kept fully charged to avoid damage.

NOTE: _____

Batteries like the one supplied with your car normally do not require you to check the water level inside the battery for the one year warranty period provided by the manufacturer.

SPECIFICATIONS

GENERAL SPECIFICATIONS

Items	G21A
Dimensions:	
Overall length	120.0 in. (3050 mm)
Overall width	51.5 in. (1308 mm)
Overall height (steering height)	47.2 in. (1200 mm)
Height of floor	11.8 in. (300 mm)
Wheelbase	74.8 in. (1900 mm)
Tread:	
Front	38.6 in. (980 mm)
Rear	38.6 in. (980 mm)
Min. ground clearance	4.5 in. (115 mm)
Weight:	
Dry weight (without battery)	851 lb (386 kg)
Performance:	
Maximum speed	12 mph (19 km/h)
Minimum turning radius	129.92 in. (3.3 m)
Seating capacity	2 persons
Hill climbing ability	22° (40% grade) on pavement

SPECIFICATIONS

ENGINE

Items	G21A
Description:	
Engine type	4-stroke, Gasoline, OHV
Number of cylinders	Single
Displacement	357 cm ³
Bore x stroke	3.30 x 2.48 in. (85 x 63 mm)
Compression ratio	8.1:1
Rated output	11.4 hp (8.5 kw)/3500 rpm
Cooling system	Forced air cooled
Starting system	Starter
Ignition system	TCI Magneto
Spark plug type	BPR2ES
Spark plug gap	0.028-0.031 in. (0.7-0.8 mm)
Lubrication system	Splash
Engine oil type	YAMALUBE 4 cycle oil or SAE 10W30
Engine oil capacity	1.16 US qt (1.1 L, 0.24 Imp gal)
Oil change quantity	1.0 US qt (0.9 L, 0.19 Imp gal)

TRANSMISSION

Items	G21A
Transmission:	
Type	V-belt automatic centrifugal engagement
V-belt width and outer line length	1.22 x 39.76 in. (31 x 1010 mm)
V-belt wear limit	1.06 in. (27 mm)
Governor:	
Type	Oil bath flyweight
Factory speed setting	12 mph (19 km/h)
Differential/reduction gear:	G21A
Differential type	Bevel gear
Lubricant/capacity	SAE 90 gear oil/0.44 US qt (0.42 L, 0.09 Imp gal)

BATTERIES

Items	G21A
Battery:	BCI group 24, RC: minimum 75 min CCA: minimum 400A

SPECIFICATIONS

CHASSIS

Items	G21A
Steering system: Type Steering angle (L.H.) Steering angle (R.H.) Lubricant/capacity	Worm and pin 1.5 turn 1.5 turn Grease/3.0 US oz (0.09 L, 3.17 Imp oz)
Brakes: Brake system Type of brake Brake pedal freeplay linkage adjustment (Brake cable end play)	Mechanical drum brake on front and rear wheels with self-adjusters. Dual internal expanding shoe. Leading/trailing shoes (self-adjusting) 25-30 mm 0.004-0.02 in. (0.1-0.5 mm)
Parking brake: Type	Foot type; parking brake with automatic release.
Release timing (Bolt heads round parallel to arm)	0.04 in. (1 mm)
Wheel: Tire size: Front Rear Rim size: Tire pressure: Front Rear	18 x 8.50-8.00/4 PR 18 x 8.50-8.00/TURF 7.00-1-8.00 For G21A: 20 - 23 psi (140 - 160 kPa, 1.4 - 1.6 kgf/cm ²) 29 - 31 psi (197 - 217 kPa, 2.0 - 2.2 kgf/cm ²)

WIRING

G21A WIRING DIAGRAM

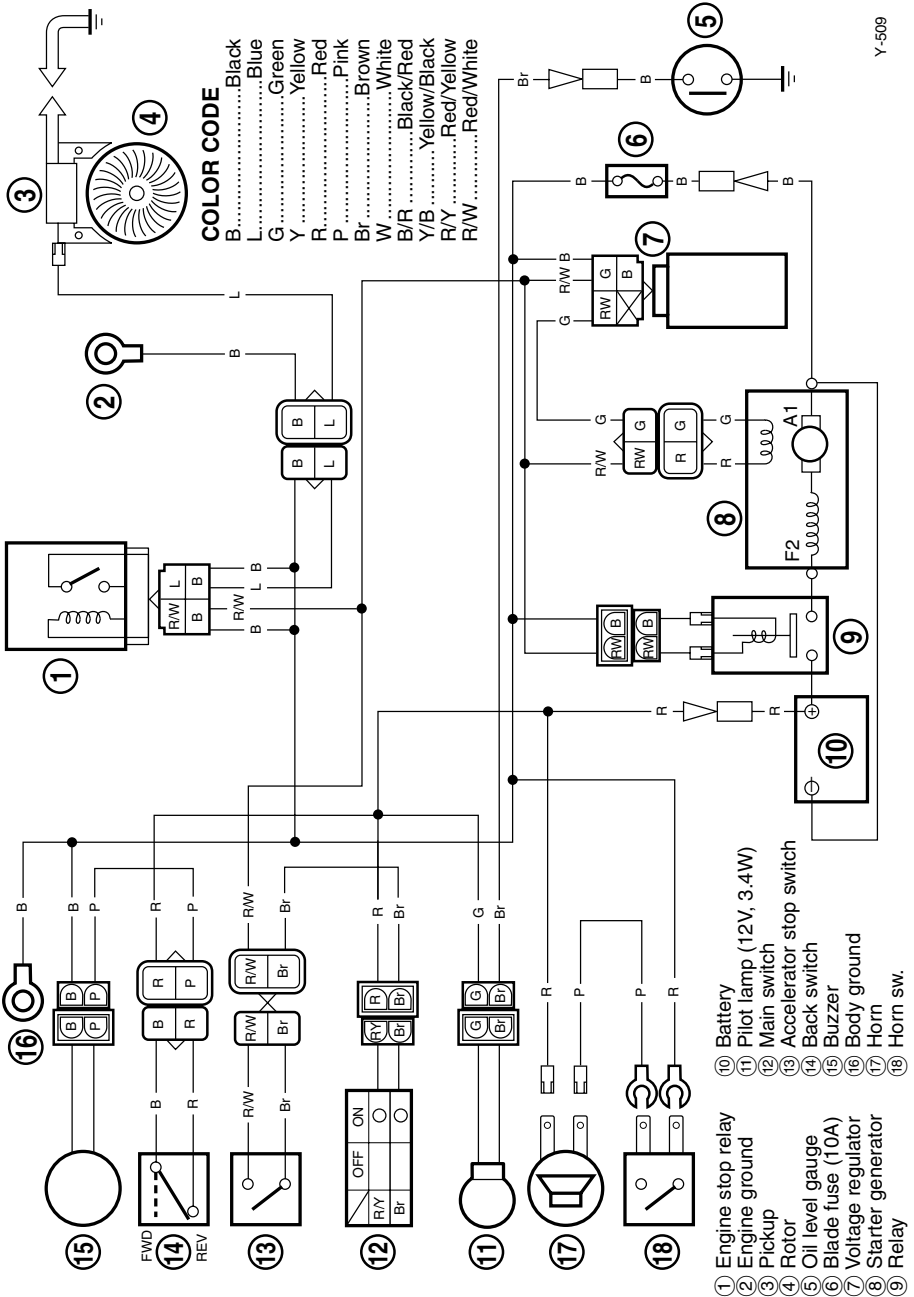

Y-509

YAMAHA
GENUINE
Parts & Accessories

10/31/00
1PC - G21A O/M

LIT196261100



Yamaha Motor Corp., USA
Cypress, California

YAMAHA YAMAHA YAMAHA YAMAHA YAMAHA YAMAHA YAMAHA YAMAHA YAMAHA YAMAHA YAMAHA YAMAHA YAMAHA YAMAHA YAMAHA YAMAHA
MADE IN JAPAN YAMAHA YAMAHA YAMAHA YAMAHA YAMAHA YAMAHA YAMAHA YAMAHA YAMAHA YAMAHA YAMAHA YAMAHA YAMAHA YAMAHA YAMAHA
YAMAHA YAMAHA YAMAHA YAMAHA YAMAHA YAMAHA YAMAHA YAMAHA YAMAHA YAMAHA YAMAHA YAMAHA YAMAHA YAMAHA YAMAHA YAMAHA
MADE IN JAPAN YAMAHA YAMAHA YAMAHA YAMAHA YAMAHA YAMAHA YAMAHA YAMAHA YAMAHA YAMAHA YAMAHA YAMAHA YAMAHA YAMAHA YAMAHA
made in USA

YAMAHA

YAMAHA MOTOR
MANUFACTURING CORP.
OF AMERICA

Printed in U.S.A.
KCC

Free Manuals Download Website

<http://myh66.com>

<http://usermanuals.us>

<http://www.somanuals.com>

<http://www.4manuals.cc>

<http://www.manual-lib.com>

<http://www.404manual.com>

<http://www.luxmanual.com>

<http://aubethermostatmanual.com>

Golf course search by state

<http://golfingnear.com>

Email search by domain

<http://emailbydomain.com>

Auto manuals search

<http://auto.somanuals.com>

TV manuals search

<http://tv.somanuals.com>