



OWNER'S MANUAL

Generator

EF6300iSDE

PLEASE READ AND UNDERSTAND THIS MANUAL
COMPLETELY BEFORE OPERATING THE MACHINE.

LIT-19626-01-52
7CK-28199-10

⚠ WARNING

The engine exhaust from this product contains chemicals known to the State of California to cause cancer, birth defects or other reproductive harm.

YAMAHA

LIT-CALIF-65-01

INTRODUCTION

Congratulations on your purchase of your new Yamaha.

This manual will provide you with a good basic understanding of the operation and maintenance of this machine.

If you have any questions regarding the operation or maintenance of your machine, please consult a Yamaha dealer.

**EF6300iSDE
OWNER'S MANUAL
© 2008 by Yamaha Motor Corporation, U.S.A.
1st Edition, September 2008
All rights reserved.
Any reprinting or unauthorized use
without the written permission of
Yamaha Motor Corporation, U.S.A.
is expressly prohibited.
Printed in Japan
P/N LIT-19626-01-52**

IMPOTANT MANUAL INFORMATION

Particularly important information is distinguished in this manual by the following notations.



The Safety Alert Symbol means ATTENTION! BECOME ALERT! YOUR SAFETY IS INVOLVED!

WARNING

Failure to follow **WARNING** instructions could result in severe injury or death to the engine operator, a bystander or a person inspecting or repairing the engine.

CAUTION:

A **CAUTION** indicates special precautions that must be taken to avoid damage to the engine.

NOTE:

A **NOTE** provides key information to make procedures easier or clearer.

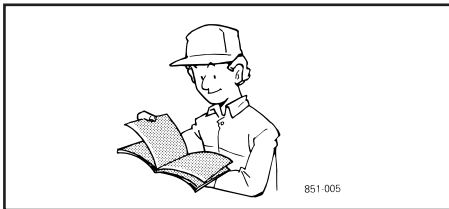

AE00032

WARNING

PLEASE READ AND UNDERSTAND THIS MANUAL COMPLETELY BEFORE OPERATING THE MACHINE.

NOTE:

- Yamaha continually seeks advancements in product design and quality. Therefore, while this manual contains the most current product information available at the time of printing, there may be minor discrepancies between your engine and this manual. If there is any question concerning this manual, please consult a Yamaha dealer.
- This manual should be considered a permanent part of this engine and should remain with this engine when resold.

* Product and specifications are subject to change without notice.

CONTENTS

SAFETY INFORMATION	1	Starting the engine	18
EXHAUST FUMES ARE		Stopping the engine.....	20
POISONOUS.....	1	Connection	21
FUEL IS HIGHLY FLAMMABLE AND		Application range.....	23
POISONOUS.....	1	PERIODIC MAINTENANCE	25
ENGINE AND MUFFLER MAY BE		Maintenance chart.....	25
HOT.....	1	Spark plug inspection	27
ELECTRIC SHOCK PREVENTION.....	2	Carburetor adjustment.....	28
CONNECTION NOTES.....	3	Engine oil replacement.....	28
CONNECTION	3	Air filter	29
EXTENSION CORD NOTES.....	3	Muffler screen and spark arrester.....	31
LOCATION OF IMPORTANT		Fuel tank filter	33
LABELS	4	Battery	34
DESCRIPTION	6	Recommended battery	34
Control Panel.....	6	Fuse replacement.....	35
CONTROL FUNCTION	7	G.F.C.I. receptacle test.....	36
Engine switch	7	STORAGE	37
Oil warning light (red)	7	Drain the fuel	37
AC protector	8	Engine	39
Economy control switch.....	8	Battery	40
G.F.C.I. receptacle	9	TROUBLESHOOTING	42
Voltage select switch.....	9	Engine won't start.....	42
Hour meter.....	10	Generator won't produce power	43
Power meter	10	SPECIFICATIONS	45
AC pilot light (green).....	10	Dimensions.....	45
Overload indicator light (red)	11	Engine	45
Fuel tank cap.....	11	Generator	45
Fuel cock knob	12	Battery	45
Ground (Earth) terminal.....	12	CONSUMER INFORMATION	46
Caster lock lever.....	12	Identification number records	46
PREPARATION	13	Machine identification	46
Fuel.....	13	LIMITED WARRANTY (EF- AND	
Engine oil.....	14	EDL-SERIES)	47
Battery preparation.....	15	EXHAUST EMISSION CONTROL	
PRE-OPERATION CHECK	17	SYSTEM AND COMPONENTS	49
Pre-operation check	17	WIRING DIAGRAM	51
OPERATION	18		

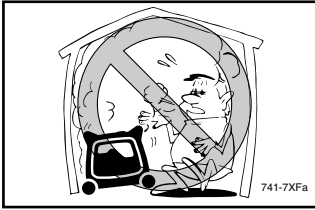

AE00071

SAFETY INFORMATION

AE00072

EXHAUST FUMES ARE POISONOUS

- Never operate the engine in a closed area or it may cause unconsciousness and death within a short time. Operate the engine in a well ventilated area.

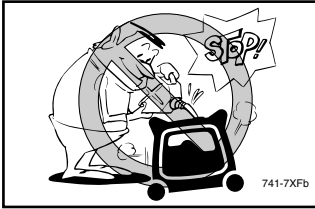

AE00075

FUEL IS HIGHLY FLAMMABLE AND POISONOUS

- Always turn off the engine when refuelling.
- Never refuel while smoking or in the vicinity of an open flame.
- Take care not to spill any fuel on the engine or muffler when refueling.
- If you swallow any fuel, inhale fuel vapor, or allow any to get in your eye(s), see your doctor immediately. If any fuel spills on your skin or clothing, immediately wash with soap and water and change your clothes.

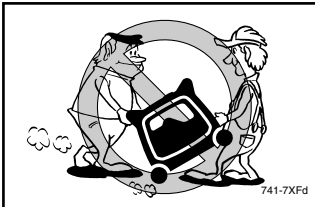
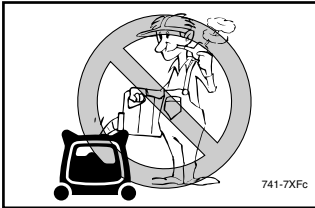

- When operating or transporting the machine, be sure it is kept upright. If it tilts, fuel may leak from the carburetor or fuel tank.

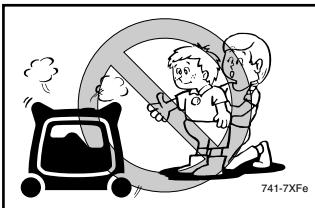

AE00843

ENGINE AND MUFFLER MAY BE HOT

- Place the machine in a place where pedestrians or children are not likely to touch the machine.



- Avoid placing any flammable materials near the exhaust outlet during operation.

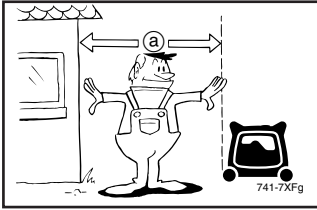

- Keep the machine at least 1 m (3 ft) from buildings or other equipment, or the engine may overheat.

Ⓐ 1 m (3 ft)

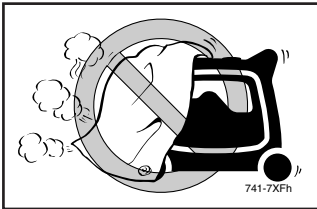

- Avoid operating the engine with a dust cover.

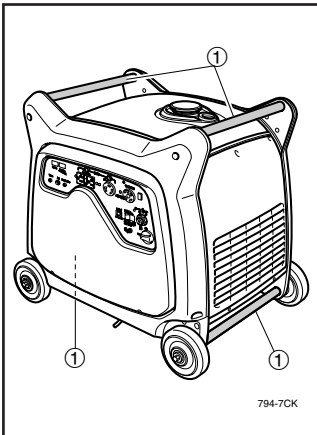

- Be sure to carry the generator only by its carrying handles ①.

AE00083

ELECTRIC SHOCK PREVENTION



- Never operate the engine in rain or snow.

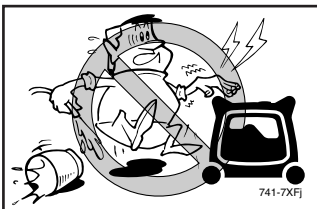

- Never touch the machine with wet hands or electrical shock will occur.

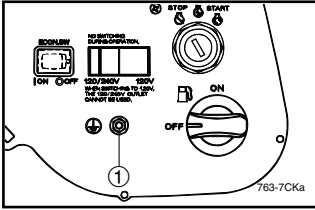

- Connect the ground lead of the machine to the ground (earth) terminal ① and connect the end to the ground electrode buried in the ground.

AE00088

CONNECTION NOTES

- Avoid connecting the generator to commercial power outlet.
- Avoid connecting the generator in parallel with any other generator.

- ① Correct
- ② Incorrect

AE00091

CONNECTION

⚠ WARNING

Before the generator can be connected to a building's electrical system, a licensed electrician must install an isolation (transfer) switch in the building's main fuse box. The switch is the connection point for generator power and allows selection of generator or main line power to the building. This will prevent the generator from charging the main power line (backfeeding) when the main power supply has failed or has been turned off for line repair. Backfeeding can electrocute or injure line maintenance personnel. Also, generator and building electrical system damage can occur when normal operating power returns if unit is used without an isolation switch.

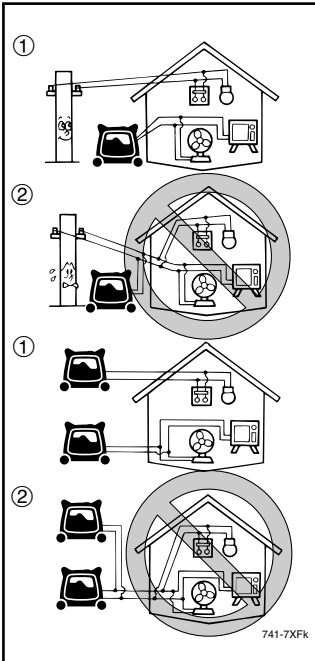

AE00086

EXTENSION CORD NOTES

Extension cords should be protected by a tough flexible rubber sheath (IEC 245) or the equivalent to withstand mechanical stresses.

LOCATION OF IMPORTANT LABELS

Please read the following labels carefully before operating this machine.

NOTE: _____
 Maintain or replace safety and instruction labels, as necessary.

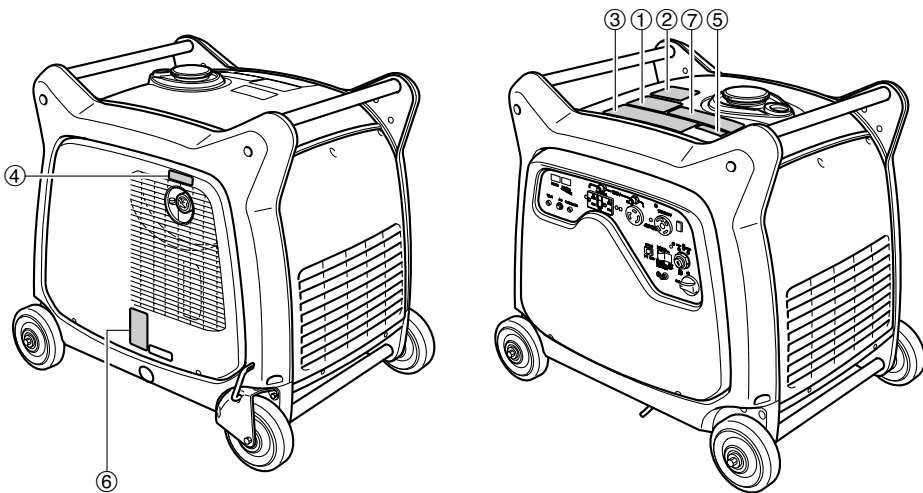

①

⚠ DANGER

Using a generator indoors **CAN KILL YOU IN MINUTES.**
 Generator exhaust contains carbon monoxide.
 This is a poison you cannot see or smell.

<p>NEVER use inside a home or garage, EVEN IF doors and windows are open.</p>	<p>Only use OUTSIDE and far away from windows, door, and vents.</p>

②

WARNING

Electrocution or property damage can occur: **Do not connect this generator to any building's electrical system unless an isolation switch has been installed by a licensed electrician. Refer to the owner's manual.**

7XF-2415A-00

③

<h2>⚠ WARNING</h2>	<h2>⚠ AVERTISSEMENT</h2>
<ul style="list-style-type: none"> ● READ THE OWNER'S MANUAL AND ALL LABELS BEFORE OPERATING. ● ONLY OPERATE IN WELL-VENTILATED AREAS. EXHAUST GAS CONTAINS POISONOUS CARBON MONOXIDE. ● CHECK FOR SPILLED FUEL OR FUEL LEAKS. ● STOP ENGINE BEFORE REFUELING. ● DO NOT OPERATE NEAR FLAMMABLE MATERIALS. ● ELECTROCUTION CAN OCCUR IF GENERATOR IS USED IN RAIN, SNOW, OR NEAR WATER. KEEP THIS UNIT DRY AT ALL TIMES. 	<ul style="list-style-type: none"> ● LISEZ LE MODE D'EMPLOI ET TOUTES LES ETIQUETTES AVANT DE FAIRE FONCTIONNER LA MACHINE. ● FAITES FONCTIONNER UNIQUEMENT DANS DES LIEUX BIEN AERES. LES GAZ D'ECHEPPEMENT CONTIENNENT DU MONOXYDE DE CARBONE. ● VERIFIEZ SI DU CARBURANT A ETE RENVERSE DU S'IL FUT. ● ARRETEZ LE MOTEUR AVANT DE FAIRE LE PLEIN DE CARBURANT. ● N'UTILISEZ PAS A PROXIMITE DE MATERIAUX INFLAMMABLES. ● IL Y A RISQUE D'ELECTROCUTION SI LE GENERATEUR FONCTIONNE SOUS LA PLUIE, DANS LA NEIGE, OU PRES DE L'EAU. GARDEZ LA MACHINE AUSEC EN TOUTES CIRCONSTANCES.
	7CF-24162-10

④

HOT EXHAUST

7WL-28176-10

⑥

OIL



YAMAHA * * * * *

AC output	**Hz
Rated	* * * * VA
	* * * * v
Phase	Single
Fuel	Gasoline

YAMAHA MOTOR POWERED PRODUCTS CO.,LTD.
MADE IN JAPAN

7CF-24162-10

⑤

⚠ CAUTION

Use the specified spark plug only.
Specified plug: BPR4ES(NGK)

⑦

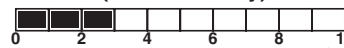
<h3 style="text-align: center;">Important Emissions Information</h3> <p style="text-align: center;">YAMAHA MOTOR POWERED PRODUCTS CO.,LTD.</p> <p>This engine meets **** California exhaust and evaporative emission regulations for small off-road engines. This engine conforms to Phase 2 U.S.EPA regulations for small nonroad engines.</p> <p>EMISSIONS COMPLIANCE PERIOD : CATEGORY A(EPA) EF: *YMXS.3572EA DISPLACEMENT: 357cc EVAP F: CMYMX23A EMISSION CONTROL SYSTEM: EM</p> <p>This engine is certified to operate on unleaded gasoline. ENGINE OIL: SAE10W-30 TYPE: SE No other adjustments needed.</p>	<h3 style="text-align: center;">The air index of this engine is 3 (California only)</h3> <div style="text-align: center;">  </div> <p>Note: The lower the air index, the less the pollution. This engine is certified to be emissions compliant for the following use:</p> <p> <input type="checkbox"/> MODERATE (250 HOURS) <input type="checkbox"/> INTERMEDIATE (500 HOURS) <input checked="" type="checkbox"/> EXTENDED (1000 HOURS) </p> <p style="text-align: center; font-size: small;">Check owner's manual for further details.</p>
---	---

DESCRIPTION

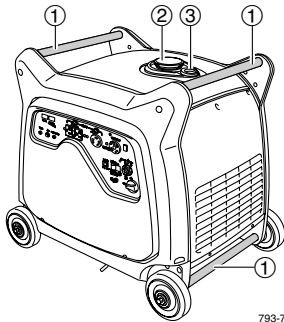

AE00102

- ① Carrying handles (shaded)
- ② Fuel tank cap
- ③ Fuel gauge
- ④ Muffler
- ⑤ Caster lock lever
- ⑥ Oil filler cap
- ⑦ Oil drain bolt
- ⑧ Battery

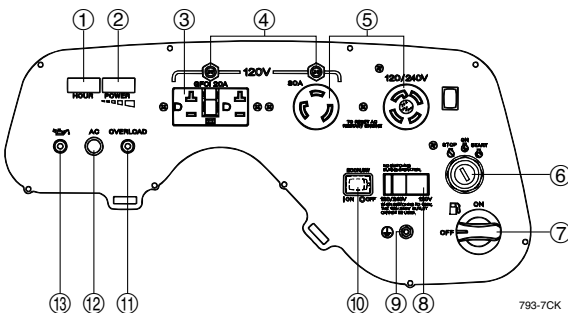
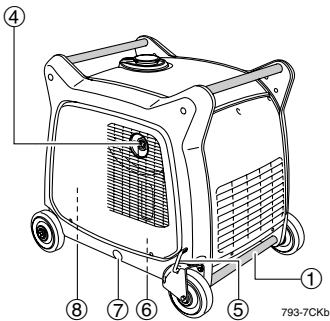

AE00103

Control panel

- ① Hour meter
- ② Power meter
- ③ G.F.C.I. receptacle
- ④ AC protector
- ⑤ AC receptacle
- ⑥ Engine switch
- ⑦ Fuel cock knob
- ⑧ Voltage select switch
- ⑨ Ground (Earth) terminal
- ⑩ Economy control switch
- ⑪ Overload indicator light
- ⑫ AC pilot light
- ⑬ Oil warning light

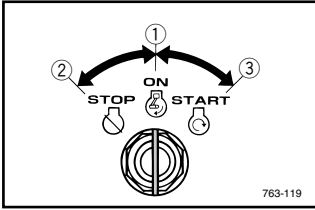

AE00101

CONTROL FUNCTION

AE00121

Engine switch

The engine switch controls the ignition system.

①  "ON"

Ignition circuit is switched on.
The engine can be started.

②  "STOP"

Ignition circuit is switched off.
The engine will not run.

③  "START"

Starting circuit is switched on.
The starter motor starts and the engine can be started.
Take your hand off the switch immediately after the engine starts.

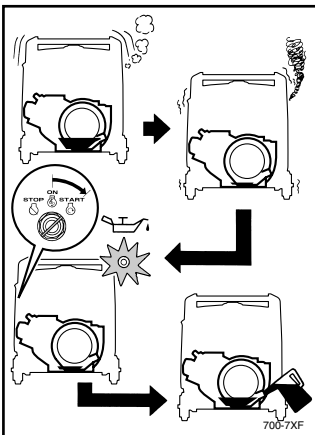

AE00111

Oil warning light (red)

When the oil level falls below the lower level, the oil warning light comes on and then the engine stops automatically. Unless you refill with oil, the engine will not start again.

NOTE: _____

If the engine stalls or does not start, turn the engine switch to "START". If the oil warning light comes on, the engine oil is insufficient. Add oil and restart.

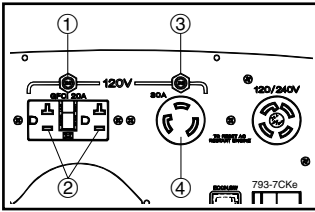

AE00134

AC protector

The AC protector ① trips when total amount of the receptacles ② loads exceed 20A.

The AC protector ③ trips when the receptacle ④ loads exceed 30A.

Press the switches to reset the AC protectors.

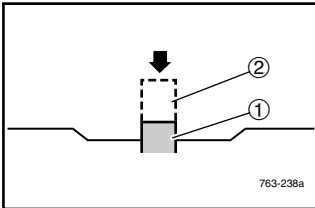

- ① ■ | "Set"
- ② ○ | "Reset"

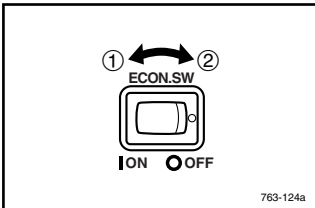

AE00142

Economy control switch

- ① | "ON"

When the economy control switch is turned to "ON", the economy control unit controls the engine speed according to the connected load. The results are better fuel consumption and less noise.

- ② ○ "OFF"

When the economy control switch is turned to "OFF", the engine runs at the rated r/min (3,400 r/min) regardless of whether is a load connected or not.

NOTE: _____

The economy control switch must be turned to "OFF" when using electric devices that require a large starting current, such as a compressor of a submergible pump.

G.F.C.I. receptacle**⚠ WARNING****TO REDUCE THE CHANCE OF ELECTRICAL SHOCK:**

- Do not attempt to operate electric devices if the ground fault circuit interrupter reset button pops out repeatedly during use.
- Test the ground fault circuit interrupter during the pre-operation checks according to the maintenance instructions on page 36.
- Remember that only receptacle labeled “GFCI” have ground fault circuit interrupter protection.

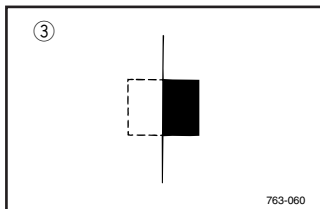
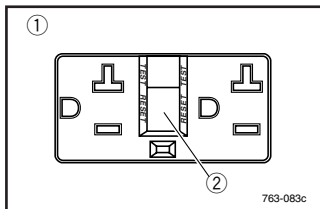

The G.F.C.I. (Ground Fault Circuit Interrupter) ① shuts off power to the protected receptacles if a ground fault (electrical leak) is detected.

If the reset button ② pops out ③, the electric devices connected into the receptacle may be faulty. If this happens, check the electric devices carefully. If the electric devices appears to be in good condition, press the reset button firmly until a click is heard. This will restore power. If the reset button pops out again, disconnect all the electric devices immediately. Have the electric devices inspected and repaired by a qualified repairperson before attempting to use them again.

Voltage select switch**CAUTION:**

Do not operate the voltage select switch while the engine is running.

① “120/240V”

When the voltage select switch is turned to “120/240V” ①, the generator supplies both 120V and 240V.

② “120V”

When the voltage select switch is turned to “120V” ②, the generator supplies 120V only.

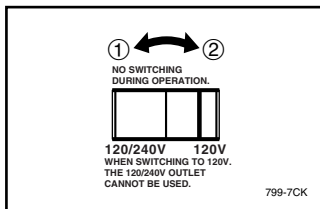

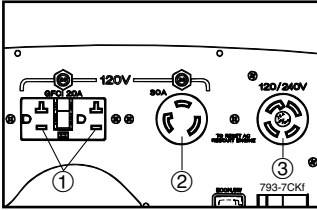

NOTE: _____

If you operate the generator with the voltage select switch in the 120/240V-position, the electric current will be limited for the 120V-receptacles.

When you use either receptacle ① or ② AND receptacle ③ at the same time, the total electric current provided will be equal to or even less than 22.9A.

For example:

If the 240V-receptacle provides 10A, the 120V-receptacles ① and ② can be used up to 12.9A each.

In case the load exceeds 22.9A, the overload indicator light will turn on and the generator will stop. (At this moment the segments of the powermeter may not reach 10)

If you operate the generator with the voltage select switch in the 120V-position, the receptacles ① and ② can supply rated current (45.8A).

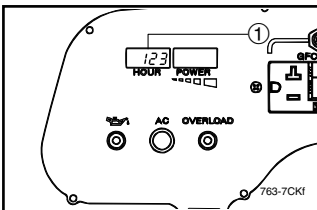

Hour meter

The hour meter ① shows the total number of hours the generator has been run.

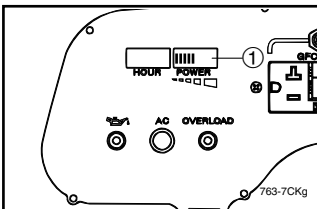

Power meter

The power meter ① shows the amount of electric current used by a barmeter.

The generator output is normal when the segments of the barmeter appear.

NOTE: _____

When 10 segments appear, the generator has almost reached its rated output.

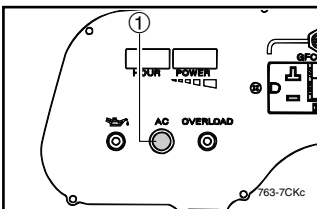

AC pilot light (green)

The AC pilot light ① comes on when the engine starts and produces power.

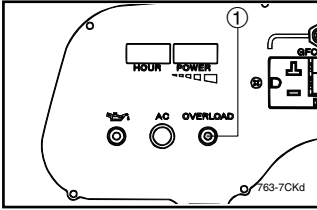

AE01087

Overload indicator light (red)

The overload indicator light ① comes on when an overload of a connected electrical device is detected, the inverter control unit overheats, or the AC output voltage rises. Then, the AC protector will trip, stopping power generation in order to protect the generator and any connected electric devices. The AC pilot light (green) will go off and the overload indicator light (red) will stay on, but the engine will not stop running.

When the overload indicator light comes on and power generation stops, proceed as follows:

1. Turn off any connected electric devices and stop the engine.
2. Reduce the total wattage of connected electric devices within the rated output.
3. Check for blockages in the cooling air inlet and around the control unit. If any blockages are found, remove.
4. After checking, restart the engine.

NOTE:

The overload indicator light may come on for a few seconds at first when using electric devices that require a large starting current, such as a compressor or a submergible pump. However, this is not a malfunction.

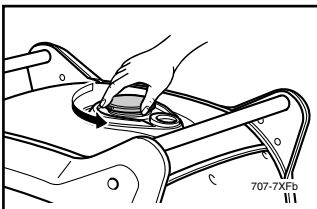

Fuel tank cap

Remove the fuel tank cap by turning it counterclockwise.

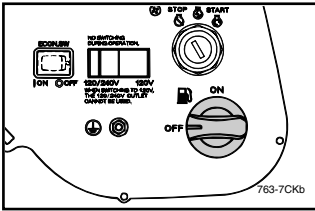

Fuel cock knob

The fuel cock supplies fuel from the fuel tank to the carburetor.

The fuel cock has two positions.

① "ON"

With the knob in this position, fuel flows to the carburetor. Normal using is done with the knob in this position.

② "OFF"

With the knob in this position, fuel will not flow. Always turn the knob to this position when the engine is not running.

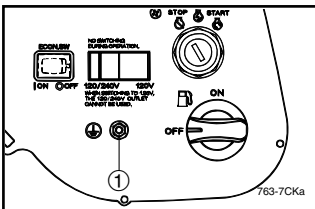
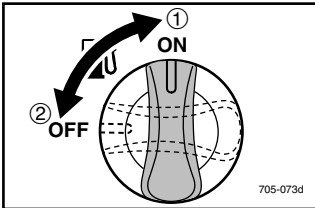

Ground (Earth) terminal

Ground (Earth) terminal ① connects the earth line for prevention of electric shock.

When the electric device is earthed, always the generator must be earthed.

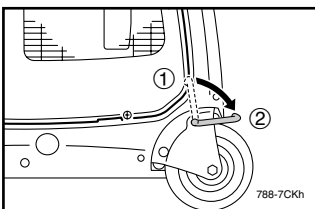

Caster lock lever

The caster lock lever stops moving the generator.

① "Release"

② "Lock"

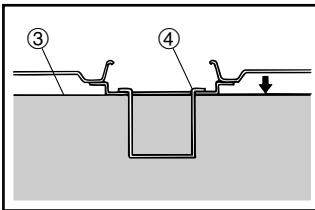
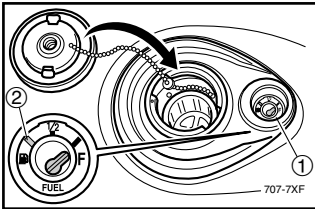
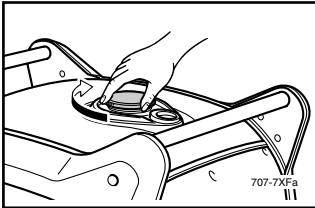
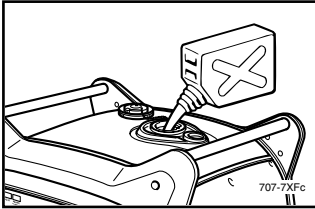

PREPARATION

AE00856

Fuel

⚠ WARNING

- Fuel is highly flammable and poisonous. Check “SAFETY INFORMATION” (See page 1) carefully before filling.
- Do not overfill the fuel tank, otherwise it may overflow when the fuel warms up and expands.
- After fill the fuel, make sure the fuel tank cap is tightened securely.

CAUTION:

- Immediately wipe off spilled fuel with a clean, dry, soft cloth, since fuel may deteriorate painted surfaces or plastic parts.
- Use only unleaded gasoline. The use of leaded gasoline will cause severe damage to internal engine parts.

Make sure there is sufficient fuel in the tank. When refueling, be sure to fill the tank to the bottom edge of the fuel filter (4).

- ① Fuel level gauge
- ② Red line

“F”	Full
Red line ②	Empty

- ③ Fuel level

<p>Recommended fuel: Unleaded gasoline</p> <p>Fuel tank capacity: Total: 17.0 L (3.17 US gal, 2.64 Imp gal)</p>

Your Yamaha engine has been designed to use regular unleaded gasoline with a pump octane number ((R + M)/2) of 86 or higher, or research octane number of 91 or higher.

Engine oil

CAUTION:

The generator has been shipped without engine oil. Do not start the engine till fill with the sufficient engine oil.

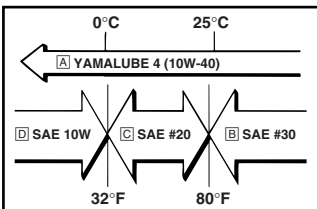
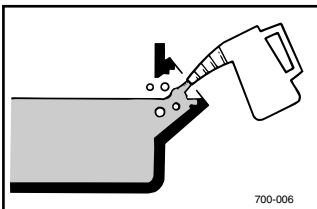
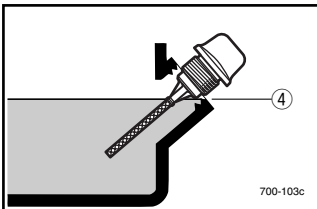
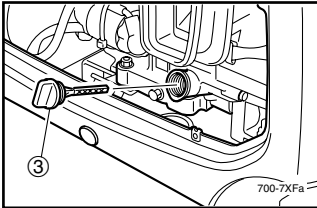
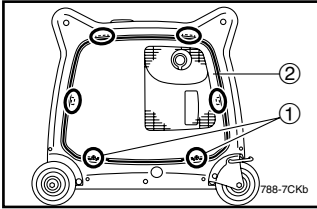

1. Place the generator on a level surface.
2. Remove the bolts ①, and then pull outward on the areas of rear cover ② shown.

3. Remove the oil filler cap ③.
4. Fill the specified amount of the recommended engine oil, and then install and tighten the oil filler cap.

④ Upper level

Recommended engine oil:

Ⓐ YAMALUBE 4 (10W-40),
SAE 10W-30 or 10W-40

Ⓑ SAE #30

Ⓒ SAE #20

Ⓓ SAE 10W

Recommended engine oil grade:

API Service SE type or higher

Engine oil quantity:

1.3 L (1.37 US qt, 1.14 Imp qt)

5. Install the rear cover and tighten the bolts.

Battery preparation (See page 34)

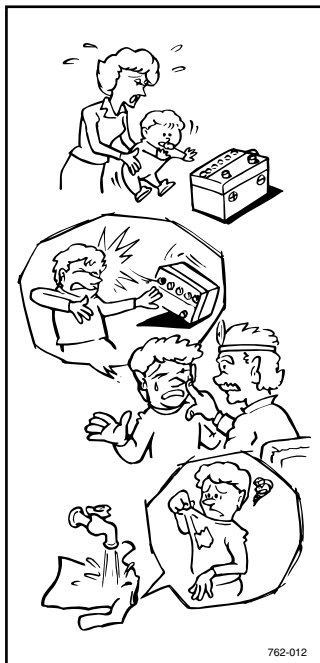

⚠ WARNING

- Electrolyte is poisonous and dangerous since it contains sulfuric acid, which causes severe burns. Avoid any contact with skin, eyes or clothing and always shield your eyes when working near batteries. In case of contact, administer the following FIRST AID.
 - **EXTERNAL:** Flush with plenty of water.
 - **INTERNAL:** Drink large quantities of water or milk and immediately call a physician.
 - **EYES:** Flush with water for 15 minutes and seek prompt medical attention.
- Batteries produce explosive hydrogen gas. Therefore, keep sparks, flames, cigarettes, etc., away from the battery and provide sufficient ventilation when charging it in an enclosed space.
- **KEEP THIS AND ALL BATTERIES OUT OF THE REACH OF CHILDREN.**

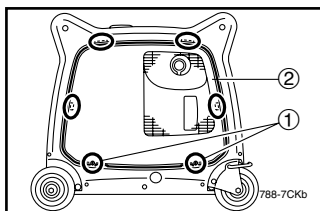

1. Remove the bolts ①, and then pull outward on the areas of rear cover ② shown.

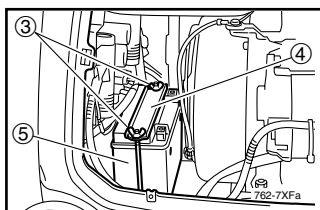

2. Remove the wing nuts ③ and battery plate ④.
3. Remove the battery ⑤.
4. Fill the battery with the electrolyte. Refer to the instruction sheet included with the electrolyte for filling instructions.

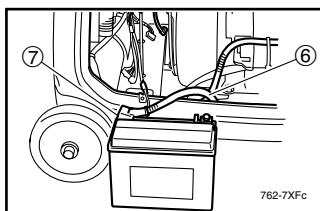

5. Connect the positive lead (red) ⑥ to the positive (+) battery terminal ⑦.
6. Install the battery onto the tray.
7. Install the battery plate and tighten the wing nuts.

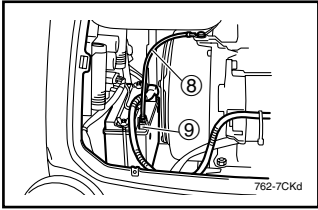

8. Connect the negative lead (black) ⊖ to the negative (-) battery terminal ⊖.

9. Install the rear cover and tighten the bolts.

PRE-OPERATION CHECK

⚠ WARNING

If any item in the Pre-operation check is not working properly, have it inspected and repaired before operating the generator.

The condition of a generator is the owner's responsibility. Vital components can start to deteriorate quickly and unexpectedly, even if the generator unused.

NOTE:

Pre-operation checks should be made each time the generator is used.

Pre-operation check

Fuel (See page 13)

- Check fuel level in fuel tank.
- Refuel if necessary.

Fuel line

- Check fuel hose for crack or damage.
- Replace if necessary.

Engine oil (See page 14)

- Check oil level in engine.
- If necessary, add recommended oil to specified level.
- Check generator for oil leakage.

The point where abnormality was recognized by use

- Check operation.
- If necessary, consult a Yamaha dealer.

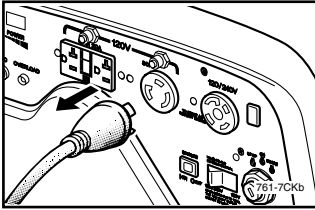

AE00846

OPERATION

WARNING

- Never operate the engine in a closed area or it may cause unconsciousness and death within a short time. Operate the engine in a well ventilated area.
- Before starting the engine, do not connect any electric devices.

CAUTION:

The generator has been shipped without engine oil. Do not start the engine till fill with the sufficient engine oil.

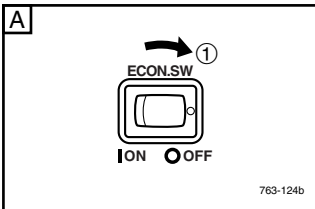

AE00918

Starting the engine

NOTE:

- Turn the economy control switch to "OFF".
- Select the voltage select switch position according to the operating voltage of the electric device.

① ○ "OFF"

A Economy control switch

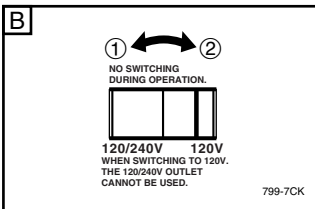

① 120/240V

② 120V

B Voltage select switch

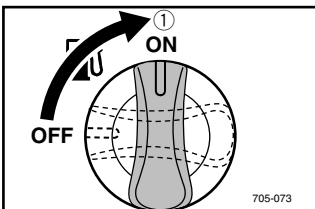

1. Turn the fuel cock knob to "ON".

① "ON"

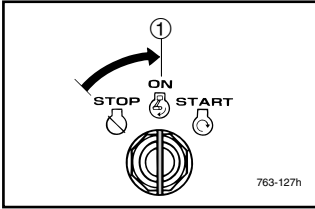

2. Turn the engine switch to "ON".

①  "ON"

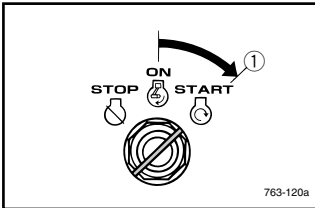

3. Turn the engine switch to "START".

Take your hand off the switch immediately after the engine starts.

①  "START"

CAUTION: _____

If the engine fails to start, release the switch, wait a few seconds, then try again. Each attempt should be as short as possible to preserve the battery. Do not crank the engine more than 5 seconds on any one attempt.

AE00840

Stopping the engine

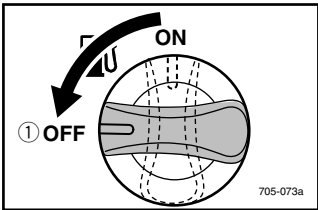
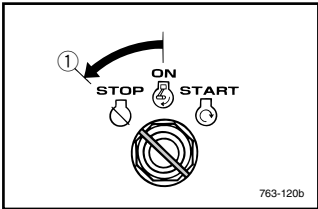
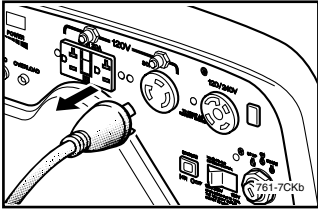

1. Turn off any electric devices.
2. Disconnect any electric devices.
3. Turn the engine switch to "STOP".
①  "STOP"
4. Turn the fuel cock knob to "OFF".
① "OFF"

Connection Alternating Current (AC)

⚠WARNING

Be sure any electric devices are turned off before plugging them in.

CAUTION:

- Be sure all electric devices including the lines and plug connections are in good condition before connection to the generator.
- Be sure the total load is within generator rated output.
- Be sure the receptacle load current is within receptacle rated current.
- Do not operate the voltage select switch while the engine is running.

NOTE:

Make sure to ground (earth) the generator. When the electric device is earthed, always the generator must be earthed.

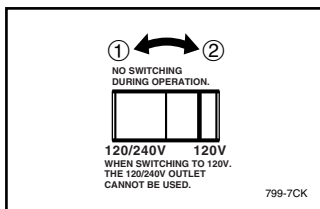

1. Select the voltage select switch position according to the operating voltage of the electric device.

- ① 120/240V
- ② 120V

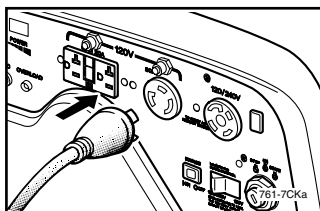

2. Start the engine.
3. Plug in to AC receptacle.

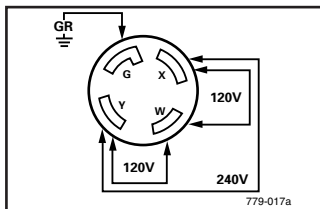

NOTE:

To supply both 120V and 240V power sources from the 4-blade plug receptacle needs special knowledge of the wiring plug. Please contact a trained electrician for the wiring of the plugs.

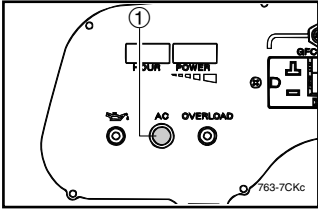

4. Make sure the AC pilot light ① is on.

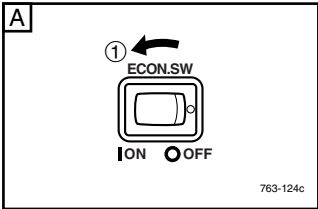

5. Turn the economy control switch to “ON”

① I “ON”



A Economy control switch

6. Turn on any electric devices.

NOTE: _____
 The economy control switch must be turned to “OFF”
 to increase engine speed to rated rpm.

Application range

When using the generator, make sure the total load is within rated output of a generator. Otherwise, generator damage may occur.

AC			
Power factor	1	0.8 ~ 0.95	0.4 ~ 0.75 (Efficiency 0.85)
EF6300iSDE	- 5,500W	- 4,400W	- 1,870W

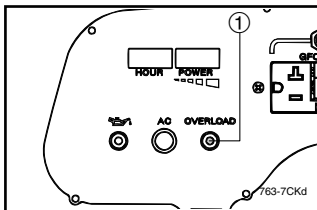

NOTE:

- “_” means below.
- Application wattage indicates when each device is used by itself.
- The overload indicator light ① comes on when total wattage exceeds the application range. (See page 11 for more details.)

CAUTION:

- **Do not overload.** The total load of all electrical appliances must not exceed the supply range of the generator. Overloading will damage the generator.
- When supplying precision equipment, electronic controllers, PCs, electronic computers, microcomputerbased equipment or battery chargers, keep the generator a sufficient distance away to prevent electrical interference from the engine. Also ensure that electrical noise from the engine does not interfere with any other electrical devices located near the generator.
- If the generator is to supply medical equipment, advice should first be obtained from the manufacturer, a medical professional or hospital.
- Some electrical appliances or general-purpose electric motors have high starting currents, and cannot therefore be used, even if they lie within the supply ranges given in the above table. Consult the equipment manufacturer for further advice.

— MEMO —

PERIODIC MAINTENANCE

Safety is an obligation of the owner. Periodic inspection, adjustment and lubrication will keep your generator in the safest and most efficient condition possible. The most important points of generator inspection, adjustment, and lubrication are explained on the following pages.

⚠ WARNING

If you are not familiar with maintenance work, have a Yamaha dealer do it for you.

Maintenance chart

⚠ WARNING

Stop the engine before starting maintenance work.

CAUTION:

Use only Yamaha specified genuine parts for replacement. Ask an authorized Yamaha dealer for further attention.

Item	Routine	Pre-operation check	Every	
			6 months or 100 Hr	12 months or 300 Hr
Spark plug	<ul style="list-style-type: none"> • Check condition. • Clean and replace if necessary. 		○	
Fuel	<ul style="list-style-type: none"> • Check fuel level and leakage. 	○		
Fuel hose	<ul style="list-style-type: none"> • Check fuel hose for cracks or damage. Replace if necessary. 	○		
Engine oil	<ul style="list-style-type: none"> • Check oil level in engine. 	○		
	<ul style="list-style-type: none"> • Replace 		○(*1)	
Air filter element	<ul style="list-style-type: none"> • Check condition. 		○(*2)	
	<ul style="list-style-type: none"> • Clean 			
Muffler screen	<ul style="list-style-type: none"> • Check condition. 		○	
	<ul style="list-style-type: none"> • Clean and replace if necessary. 			
Spark arrester	<ul style="list-style-type: none"> • Check condition. 		○	
	<ul style="list-style-type: none"> • Clean and replace if necessary. 			
Fuel filter	<ul style="list-style-type: none"> • Clean and replace if necessary. 			○

Item	Routine	Pre-operation check	Every	
			6 months or 100 Hr	12 months or 300 Hr
Crankcase breather hose	<ul style="list-style-type: none"> • Check breather hose for cracks or damage. • Replace if necessary. 			○
Cylinder head	<ul style="list-style-type: none"> • Decarbonize cylinder head. • More frequently if necessary. 			★
Valve clearance	<ul style="list-style-type: none"> • Check and adjust when engine is cold. 			★
Fittings / fasteners	<ul style="list-style-type: none"> • Check all fittings and fasteners. • Correct if necessary. 			★
The point where abnormality was recognized by use		○		

*1.....Initial replacement of the engine oil is after one month or 20 hours of operation.

*2.....The air filter element needs to be cleaned more frequently when using in unusually wet or dusty areas.

★..... Since these items require special tools, data and technical skills, have a Yamaha dealer perform the service.

AE01051

Spark plug inspection

The spark plug is important engine components, which should be checked periodically.

1. Remove the bolts ①, and then pull outward on the areas of front cover ② shown.
2. Remove the spark plug cap and then remove the spark plug.
3. Check for discoloration and remove the carbon. The porcelain insulator around the center electrode of spark plug should be a medium-to-light tan color.
4. Check the spark plug type and gap ①a.

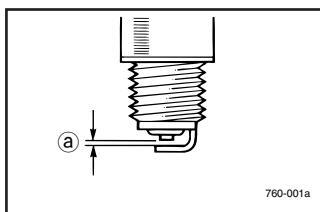
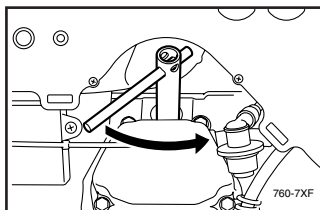
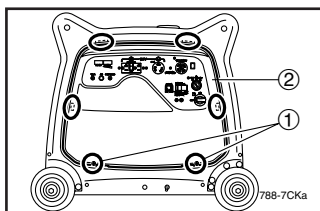

Standard Spark Plug:

BPR4ES (NGK)

Spark Plug Gap:

0.7–0.8 mm (0.028–0.031 in)

NOTE:

The spark plug gap should be measured with a wire thickness gauge and, if necessary, adjusted to specification.

5. Install the spark plug.

Spark Plug Torque:

20.0 N•m (2.0 kgf•m, 14.8 lbf•ft)

NOTE:

If a torque wrench is not available when installing a spark plug, a good estimate of the correct torque is 1/4-1/2 turn past finger tight. However, the spark plug should be tightened to the specified torque as soon as possible.

6. Install the spark plug cap.
7. Install the front cover and tighten the bolts.

AE00431

Carburetor adjustment

The carburetor is a vital part of the engine. Adjusting should be left to a Yamaha dealer with the professional knowledge, specialized data, and equipment to do so properly.

AE00412

Engine oil replacement

⚠WARNING

Avoid draining the engine oil immediately after stopping the engine. The oil is hot and should be handled with care to avoid burns.

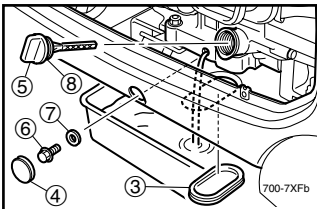
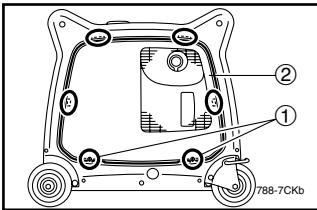

1. Place the machine on a level surface and warm up the engine for several minutes. Then stop the engine.
2. Remove the bolts ①, and then pull outward on the areas of rear cover ② shown.
3. Remove the rubber cap ③, rubber plug ④ and the oil filler cap ⑤.
4. Place an oil pan under the engine. Remove the oil drain bolt ⑥ so that the oil can be completely drained.
5. Check the oil drain bolt, gasket ⑦, oil filler cap and O-ring ⑧. If damaged, replace.
6. Reinstall the oil drain bolt.

Oil drain bolt Torque:
30.0 N•m (3.1 kg•m, 22.2 lbf•ft)

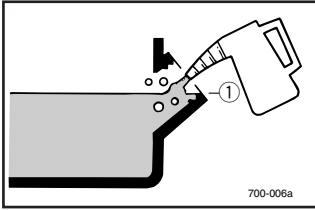

7. Add engine oil to the upper level ①.

Recommended engine oil:

Ⓐ YAMALUBE 4 (10W-40),
SAE 10W-30 or 10W-40

Ⓑ SAE #30

Ⓒ SAE #20

Ⓓ SAE 10W

Recommended engine oil grade:

API Service SE type or higher

Engine oil quantity:

1.3 L (1.37 US qt, 1.14 Imp qt)

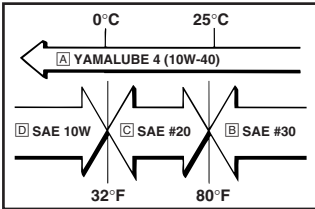

CAUTION:

Be sure no foreign material enters the crankcase.

8. Install the oil filler cap, the rubber cap and the rubber plug.
9. Install the front cover and tighten the bolts.

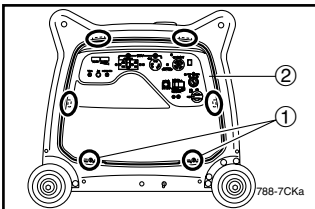

AE01084

Air filter

1. Remove the bolts ①, and then pull outward on the areas of front cover ② shown.
2. Remove the bolts ③.

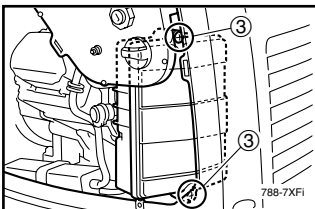

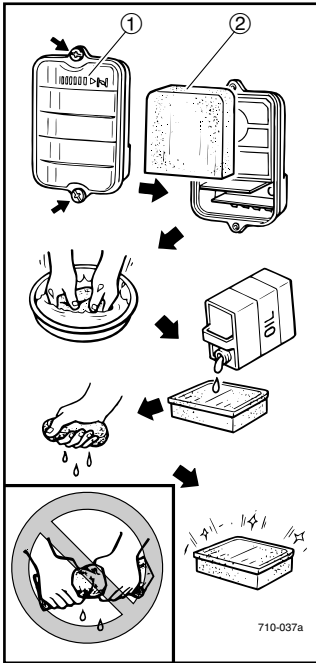

3. Remove the air filter cover ① and foam element ②.
4. Wash the foam element in solvent and dry it.
5. Oil the foam element and squeeze out excess oil. The foam element should be wet but not dripping.

Recommended oil:
Foam-air-filter oil
or
SAE #20 motor oil

CAUTION: _____

Do not wring out the foam element when squeezing it.

This could cause it to tear.

6. Insert the foam element into the air filter case.

NOTE: _____

Be sure the foam element sealing surface matches the air filter so there is no air leak.

CAUTION: _____

The engine should never run without the foam element; excessive piston and cylinder wear may result.

7. Install the air filter cover in its original position and tighten the bolts.
8. Install the front cover and tighten the bolts.

Muffler screen and spark arrester



⚠ WARNING

The engine and muffler will be very hot after the engine has been run.
 Avoid touching the engine and muffler while they are still hot with any part of your body or clothing during inspection or repair.

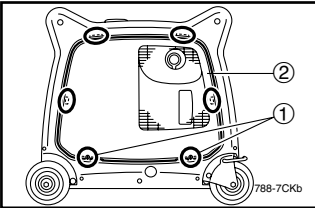

1. Remove the bolts ①, and then pull outward on the areas of rear cover ② shown.

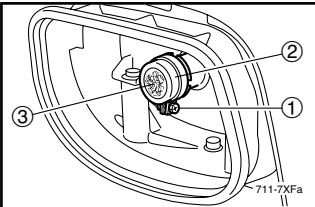

2. Loosen the screw ① and then remove the muffler cap ②, the muffler screen ③ and spark arrester ④.

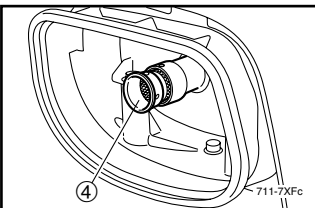
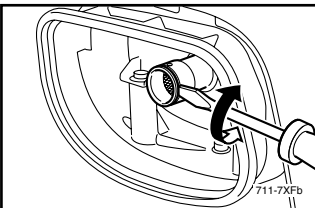

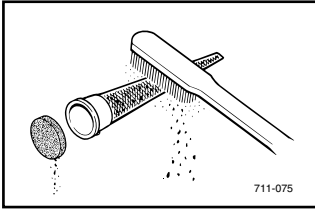

3. Remove the carbon deposits on the muffler screen and spark arrester using a wire brush.

CAUTION: _____

When cleaning, use the wire brush lightly to avoid damaging or scratching of the muffler screen and spark arrester.

4. Check the muffler screen and spark arrester. Replace them if damaged.
5. Install the spark arrester.

NOTE: _____

Align the spark arrester projection ① with the hole ② in the muffler pipe.

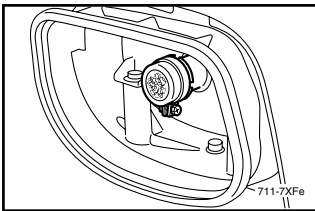
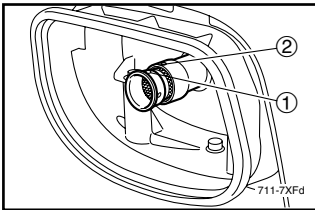

6. Install the muffler screen and the muffler cap.
7. Install the rear cover and tighten the bolts.

AE00471

Fuel tank filter

⚠WARNING

Never use or be near the fuel and solvent while smoking or in the vicinity of an open flame.

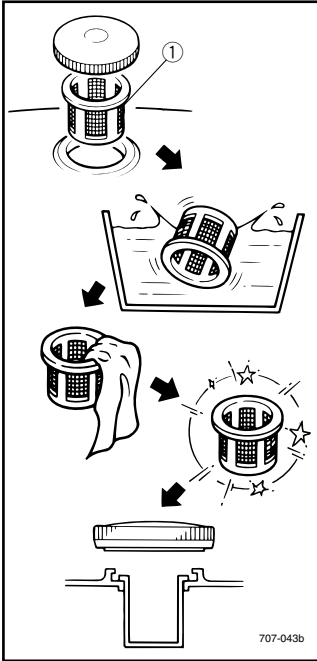

1. Remove the fuel tank cap and filter ①.
2. Clean the filter with gasoline.
If damaged, replace it.
3. Wipe the filter and install it.
4. Install the fuel tank cap.

⚠WARNING

Be sure the fuel tank cap is tightened securely.

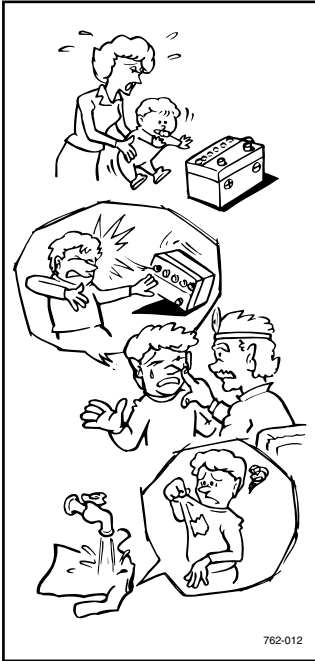

AE00842

Battery

This generator is equipped with a sealed type (MF) battery, which does not require any maintenance. There is no need to check the electrolyte or to add distilled water.

⚠ WARNING

- **Electrolyte is poisonous and dangerous since it contains sulfuric acid, which causes severe burns. Avoid any contact with skin, eyes or clothing and always shield your eyes when working near batteries. In case of contact, administer the following FIRST AID.**
 - **EXTERNAL:** Flush with plenty of water.
 - **INTERNAL:** Drink large quantities of water or milk and immediately call a physician.
 - **EYES:** Flush with water for 15 minutes and seek prompt medical attention.
- **Batteries produce explosive hydrogen gas. Therefore, keep sparks, flames, cigarettes, etc., away from the battery and provide sufficient ventilation when charging it in an enclosed space.**
- **KEEP THIS AND ALL BATTERIES OUT OF THE REACH OF CHILDREN.**

To charge the battery

Have a Yamaha dealer charge the battery as soon as possible if it seems to have discharged.

AE01057

Recommended battery

Recommended battery:
Capacity: 12V/18Ah

Fuse replacement

⚠WARNING

Be sure to use specified fuse. A wrong fuse will cause electrical system damage and A FIRE HAZARD.

CAUTION:

Be sure the engine switch is turned to “STOP” to prevent accidental short circuiting.

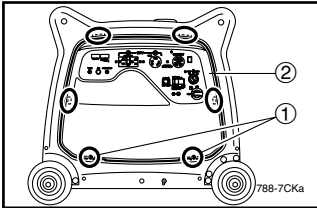

1. Remove the bolts ①, and then pull outward on the areas of front cover ② shown.

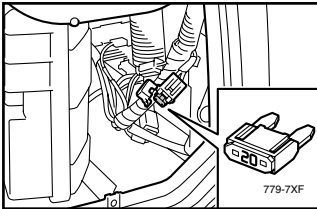

2. Replace the fuse with one of proper amperage.

Specified fuse: 20A

NOTE:

If the fuse immediately blows again, consult a Yamaha dealer.

3. Install the front cover and tighten the bolts.

G.F.C.I. receptacle test

1. Start the engine.

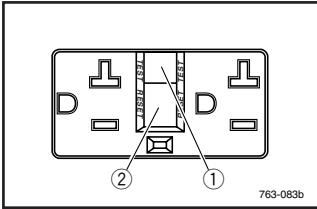

2. Press the test button ①, then check the position of the reset button ②.

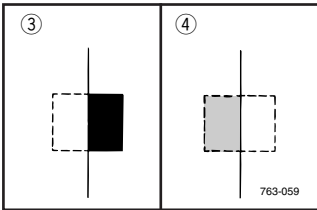

G.F.C.I. Reset Button Position after Test	G.F.C.I. Receptacle Operation
Pop Out ③	Correct
Stay In ④	Incorrect

3. If G.F.C.I. operation is correct, push in the reset button.

If the G.F.C.I. operates incorrectly, consult a Yamaha dealer.

⚠WARNING

Do not operate the generator with a faulty G.F.C.I. circuit. Electric shock could occur. Have the generator repaired by a qualified mechanic.

STORAGE

Long term storage of your machine will require some preventive procedures to guard against deterioration.

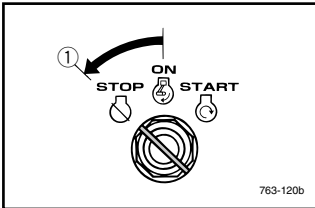

AE01056

Drain the fuel

1. Turn the engine switch to “STOP” ①.
2. Remove the fuel tank cap. Extract the fuel from the fuel tank into an approved gasoline container using a commercially available handsiphon. Then, install the fuel tank cap.

⚠WARNING

Fuel is highly flammable and poisonous. Check “SAFETY INFORMATION” (See page 1) carefully.

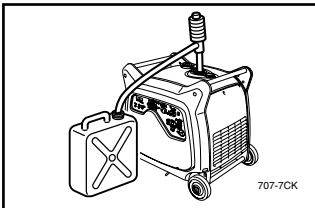

CAUTION:

Immediately wipe off spilled fuel with a clean, dry, soft cloth, since fuel may deteriorate painted surfaces or plastic parts.

3. Turn the engine switch to “ON”

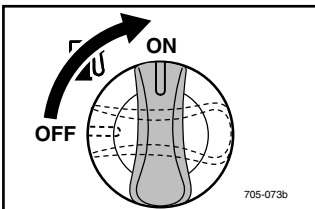

4. Turn the fuel cock knob to “ON”
5. Start the engine and leave it run until it stops. The engine stops in approx. 20 mins. time by running out of fuel.

NOTE:

- Do not connect with any electrical devices. (unloaded operation)
- Duration of the running engine depends on the amount of the fuel left in the tank.

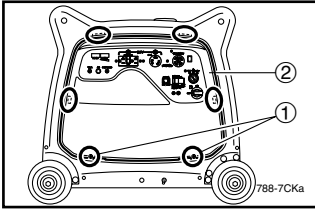

6. Remove the bolts ①, and then pull outward on the areas of front cover ② shown.

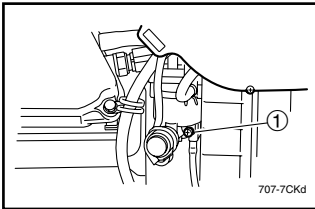

7. Drain the fuel from the carburetor by loosening the drain screw ① on the carburetor float chamber.
8. Turn the engine switch to "OFF".
9. Turn the fuel cock knob to "OFF".
10. Tighten the drain screw.
11. Install the front cover and tighten the bolts.

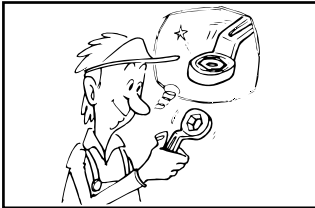

12. Tighten further if any bolts and nuts are loose.
13. Store the generator in a dry, well-ventilated place, with the cover placed over it.

Engine

Perform the following steps to protect the cylinder, piston ring, etc. from corrosion.

1. Remove the spark plug cap and spark plug, pour about one tablespoon of SAE 10W30 or 20W40 motor oil into spark plug hole and reinstall the spark plug only.
2. Turn the engine switch to "START" and crank the engine several seconds with ignition off to coat the cylinder walls with oil.
3. Clean exterior of the generator and apply a rust inhibitor.

4. Store the generator in a dry, well-ventilated place, with the cover placed over it.

5. The generator must remain in a vertical position when stored, carried or operated. The caster lock lever should be in the "Lock" when stored or operated.

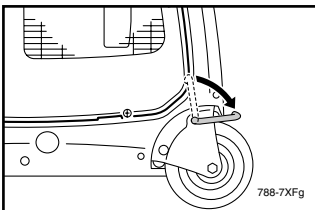
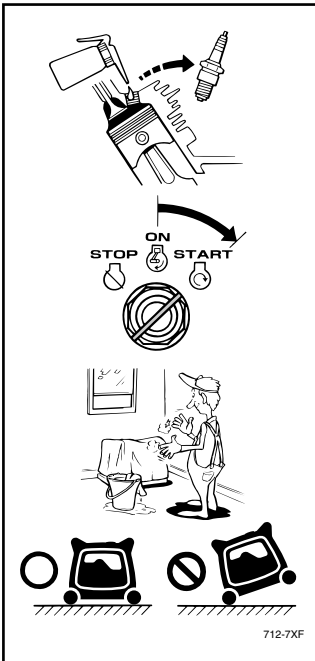

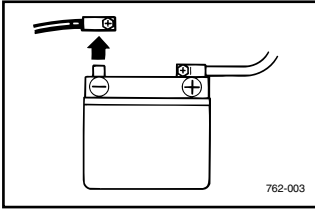

AE01086

Battery

1. Remove the battery.
2. Store the battery in a cool, dark and dry place.

Do not store the battery in an excessively warm or cold place [i.e., less than 0°C (30°F) or more than 30°C (90°F)].

⚠ WARNING

- **Disconnect the negative lead (black) first, then the positive lead (red) from the battery.**
- **Connect the positive lead (red) first, then the negative lead (black) to the battery when installing the battery.**

— MEMO —

TROUBLESHOOTING

Engine won't start

1. Fuel systems

No fuel supplied to combustion chamber.

- No fuel in tank Supply fuel.
- Fuel in tank Fuel cock knob to "ON" ①.
- Clogged fuel line Clean fuel line.
- Clogged carburetor Clean carburetor.

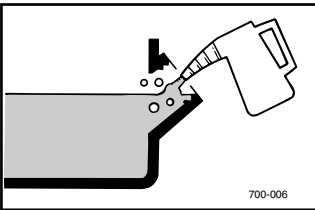
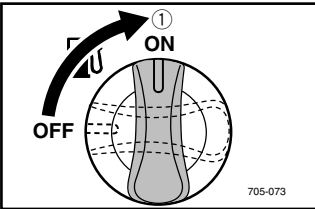
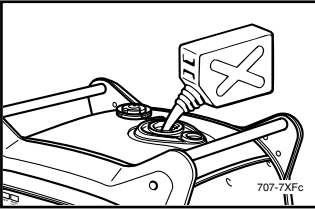

2. Engine oil system

Insufficient

- Oil level is low Add engine oil.

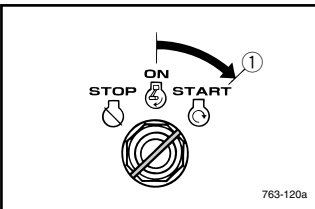

3. Electrical systems

- Engine switch to "START" ①.

Poor spark

- Spark plug dirty with carbon or wet Remove carbon or wipe spark plug dry.
- Faulty ignition system Consult a Yamaha dealer.

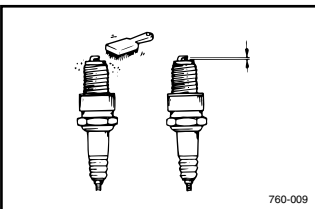

4. Compression

Insufficient

- Worn out piston and cylinder Consult a Yamaha dealer.
- Loose cylinder head nuts Tighten nuts properly.
- Damaged gasket Replace gasket.

Generator won't produce power

- Safety device (AC protector) to "Reset"....Press the AC protector to "Set".
- The voltage select switch in the wrong position....Turn the voltage select switch to the right position.

A ENGINE DOES NOT START



B Turn the engine switch to "ON", then turn the engine switch to "START". And check if the starter motor cranks.

C Cranks	D Does not crank
----------	------------------



F Turn the engine switch to "START", and check if the oil warning light comes on.

G Does not come on	H Comes on
--------------------	------------



L Turn the engine switch to "START" and check the spark plug for spark strength. (See "WARNING").

⚠ WARNING

- To prevent **FIRE HAZARDS** be sure fuel is not present in the spark plug area.
- To prevent **FIRE HAZARDS** be sure to place the spark plug as far way as possible from the spark plug hole and carburetor area.
- To prevent **ELECTRIC SHOCK** do not hold spark plug lead with hand while testing.

M Engine does not start.	N Engine starts.
--------------------------	------------------



<p>R Check the following</p> <ul style="list-style-type: none"> • Fuel cock clogging • Air cleaner element clogging. 	S	Clogged	→	U Clean or Replace; Consult a Yamaha dealer.
	T	OK	→	V Consult a Yamaha dealer.

E Faulty battery and/or starter motor.
Consult a Yamaha dealer.

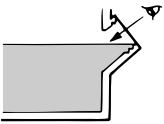
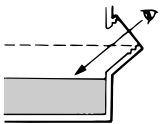
I Check engine oil level.	
	
J OK	K Level low
Consult a Yamaha dealer.	Add engine oil.

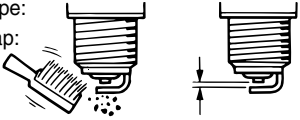
O Check the spark plug.	
<ul style="list-style-type: none"> Type: Gap: 	
P Incorrect	Q OK
Replace or Adjust gap.	Clean the spark plug.

SPECIFICATIONS

Dimensions

	Unit	EF6300iSDE
Overall Length	mm (in)	780 (30.7)
Overall Width	mm (in)	616 (24.3)
Overall Height	mm (in)	692 (27.2)
Dry Weight	kg (lb)	91 (200)

Engine

	Unit	EF6300iSDE
Type		Air cooled 4-stroke gasoline OHV
Cylinder Arrangement		Inclined, 1 cylinder
Displacement	cm ³	357
Bore × Stroke	mm (in)	85.0 × 63.0 (3.35 × 2.48)
Operation Hours	Hr	5.1–13.3 (rated load–1/4 load)
Fuel		Unleaded gasoline
Fuel Tank Capacity	L (US gal, Imp gal)	17.0 (4.49, 3.74)
Engine Oil Quantity	L (US qt, Imp qt)	1.3 (1.37, 1.14)
Ignition System		TCI
Spark Plug: Type		BPR4ES (NGK)
Gap	mm (in)	0.7–0.8 (0.028–0.031)
Noise Level*	dB (A)	64

* : Measured at rated operation from 7 m (23 ft) distance.

Generator

	Unit	EF6300iSDE
AC Output		
Rated voltage	V	120/240
Rated frequency	Hz	60
Rated current	A	45.8/22.9
Rated output	kVA	5.5
Safety Device: Type		Electronic + Mechanical (By metal)

Battery

	Unit	EF6300iSDE
Voltage	V	12
Capacity	Ah	18

CONSUMER INFORMATION

PRI-I.D. NUMBER:

	MODEL	
	<input type="text"/>	
PRI-I.D. CODE		SERIAL No.
<input type="text"/>		<input type="text"/>

AE00012

Identification number records

Record your Primary I.D., and serial numbers in the spaces provided, to assist you in ordering spare parts from a Yamaha dealer.

Also record and keep these I.D. numbers in a separate place in case your machine is stolen.

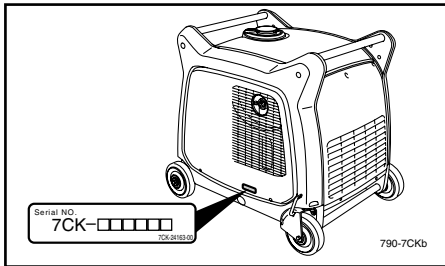

AE00011

Machine identification

The machine serial number is stamped in the location as shown.

NOTE: _____

The first three digits of these numbers are for model identification; the remaining digits are the unit production number. Keep a record of these numbers for reference when ordering parts from a Yamaha dealer.

YAMAHA MOTOR CORPORATION U.S.A. EF- AND EDL-SERIES GENERATOR LIMITED WARRANTY

Yamaha Motor Corporation, U.S.A. hereby warrants that new Yamaha consumer generators purchased from an authorized Yamaha consumer generator dealer in the continental United States will be free from defects in material and workmanship for the period of time stated herein, subject to certain stated limitations.

THE PERIOD OF WARRANTY Any new EF-series or EDL-series Yamaha Generator purchased for private, non-commercial use from an authorized Yamaha consumer generator dealer in the continental United States will be warranted against defects in material or workmanship for a period two (2) years from date of purchase, subject to exclusions noted herein. Any Yamaha non-commercial generator purchased and utilized for commercial or rental applications will be warranted for a period one (1) year from the date of purchase, subject to exclusions noted herein.

DURING THE PERIOD OF WARRANTY any authorized Yamaha consumer generator dealer will, free of charge, repair or replace, at Yamaha's option, any part adjudged defective by Yamaha due to faulty workmanship or material from the factory. Parts used in warranty repairs will be warranted for the balance of the product's warranty period. All parts replaced under warranty become property of Yamaha Motor Corporation U.S.A.

GENERAL EXCLUSIONS from this warranty shall include any failures caused by:

- a. Installation of parts or accessories that are not qualitatively equivalent to genuine Yamaha parts.
- b. Abnormal strain, neglect, or abuse.
- c. Lack of proper maintenance.
- d. Accident or collision damage.

SPECIFIC EXCLUSIONS from this warranty shall include parts replaced due to normal wear or routine maintenance.

THE CUSTOMER'S RESPONSIBILITY under this warranty shall be to:

1. Operate and maintain the generator as specified in the appropriate Owner's Manual;

2. Give notice to an authorized Yamaha consumer generator dealer of any and all apparent defects within ten (10) days after discovery, and make the unit available at that time for inspection and repairs at such dealer's place of business.

WARRANTY TRANSFER: To transfer the warranty from the original purchaser to any subsequent purchaser(s), it is imperative that the unit be inspected and registered for warranty by an authorized Yamaha consumer generator dealer. In order for this warranty to remain in effect, this inspection and registration must take place within ten (10) days after transfer. An inspection and registration fee will be charged for this service. In no case will the warranty be extended beyond the original period.

YAMAHA MOTOR CORPORATION, U.S.A. MAKES NO OTHER WARRANTY OF ANY KIND, EXPRESSED OR IMPLIED. ALL IMPLIED WARRANTIES OF MERCHANTABILITY AND FITNESS FOR A PARTICULAR PURPOSE WHICH EXCEED THE OBLIGATIONS AND TIME LIMITS STATED IN THIS WARRANTY ARE HEREBY DISCLAIMED BY YAMAHA MOTOR CORPORATION, U.S.A. AND EXCLUDED FROM THIS WARRANTY.

SOME STATES DO NOT ALLOW LIMITATIONS ON HOW LONG AN IMPLIED WARRANTY LASTS, SO THE ABOVE LIMITATION MAY NOT APPLY TO YOU. ALSO EXCLUDED FROM THIS WARRANTY ARE ANY INCIDENTAL OR CONSEQUENTIAL DAMAGES INCLUDING LOSS OF USE. SOME STATES DO NOT ALLOW THE EXCLUSION OR LIMITATION OF INCIDENTAL OR CONSEQUENTIAL DAMAGES, SO THE ABOVE EXCLUSION MAY NOT APPLY TO YOU.

THIS WARRANTY GIVES YOU SPECIFIC LEGAL RIGHTS, AND YOU MAY ALSO HAVE OTHER RIGHTS WHICH VARY FROM STATE TO STATE.

YAMAHA MOTOR CORPORATION, U.S.A.
Post Office Box 6555
Cypress, California 90630

WARRANTY QUESTIONS AND ANSWERS

- Q. What costs are my responsibility during the warranty period?
- A. The customer's responsibility includes all costs of normal maintenance service, non-warranty repairs, accident damages, as well as oil and spark plugs.
- Q. What are some examples of "abnormal" strain, neglect, or abuse?
- A. These terms are general and overlap each other in areas. Specific examples include: Running the machine out of oil; lack of proper maintenance; operating the machine with a broken or damaged part which causes another part to fail; and so on. If you have any specific questions on operation or maintenance, please contact your dealer for advice.
- Q. Does the warranty cover incidental costs such as transportation due to a failure?
- A. No. The warranty is limited to repair of the machine itself.
- Q. May I perform any or all of the recommended maintenance shown in the Owner's Manual instead of having the dealer do them?
- A. Yes, if you are a qualified mechanic and follow the procedures specified in the Owner's and Service Manual. We do recommend, however, that items requiring special tools or equipment be done by a Yamaha generator dealer.
- Q. Will the warranty be void or cancelled if I do not operate or maintain my new Yamaha exactly as specified in the Owner's Manual?
- A. No. The warranty on a new Yamaha cannot be "voided" or "cancelled."
However, if a particular failure is caused by operation or maintenance other than as shown in the Owner's Manual, that failure may not be covered under warranty.
- Q. What responsibility does my dealer have under this warranty?
- A. Each Yamaha generator dealer is expected to:
1. Check the operation of the generator before sale.
 2. Explain the operation, maintenance, and warranty requirements to your satisfaction at the time of sale, and upon your request at any later date.
- In addition, each Yamaha generator dealer is held responsible for his setup, service and warranty repair work.

- Q. Is the warranty transferable to second owners?
- A. Yes. The remainder of the existing warranty can be transferred upon request. The unit has to be inspected and reregistered by an authorized Yamaha generator dealer for the policy to remain effective.

CUSTOMER SERVICE

If your machine requires warranty service, you must take it to any authorized Yamaha generator dealer within the continental United States. Be sure to bring your warranty registration identification or other valid proof of the original date of purchase. If a question or problem arises regarding warranty, first contact the owner of the dealership. Since all warranty matters are handled at the dealer level, this person is in the best position to help you. If you are still not satisfied and require additional assistance, please write:

YAMAHA MOTOR CORPORATION U.S.A.
CUSTOMER RELATIONS DEPARTMENT
P.O. BOX 6555
Cypress, California 90630

CHANGE OF ADDRESS

The federal government requires each manufacturer to maintain a complete, up-to-date list of all first purchasers against the possibility of a safety-related defect and recall. This list is compiled from the purchase registrations sent to Yamaha Motor Corporation, U.S.A. by the selling dealer at the time of your purchase. If you should move after you have purchased your new generator, please advise us of your new address by sending a postcard listing your Yamaha model name, engine number, dealer number (or dealer's name) as it is shown on your warranty identification, your name and new mailing address. Mail to:

YAMAHA MOTOR CORPORATION, U.S.A.
WARRANTY DEPARTMENT
P.O. Box 6555
Cypress, California 90630

This will ensure that Yamaha Motor Corporation, U.S.A. has an up-to-date registration record in accordance with federal law.

EXHAUST EMISSION CONTROL SYSTEM AND COMPONENTS

Item	Acronym
• CARB. ASSY., LH. & JT.,	CARB (Carburetor)
• CARBURETOR2	
• T.C.I. MAGNETO ASSY. &	EI (Electronic Ignition)
• PLUG, SPARK	
• CRANKCASE1 & HEAD,	PCV (Positive Crankcase
• CYLINDER1	Ventilation)
• AIR FILTER ASSY.	ACL (Air Cleaner)
• MUFF., 2, CAP, NET, WIRE2 &	
• ARRESTER, SPARK	

The above items and the corresponding acronyms are provided in accordance with U.S. EPA REGULATIONS FOR NEW NONROAD SPARK-IGNITION NONHANDHELD ENGINES and the CALIFORNIA REGULATIONS FOR 1995 AND LATER SMALL OFF-ROAD ENGINES.

The acronyms conform to the latest version of the SAE's recommended practice document J1930, "Diagnostic Acronyms, Terms, and Definitions For Electrical/Electronic System".

It is recommended that these items be serviced by a Yamaha dealer.

— MEMO —

	Color code
① Main coil 1	B Black
② Control unit (Slave)	Br Brown
③ AC pilot light	G Green
④ Voltage select switch	L Blue
⑤ AC protector (breaker)	Or Orange
⑥ G.F.C.I. receptacle	P Pink
⑦ AC receptacle	R Red
⑧ Hour meter/power meter	W White
⑨ Engine switch	Y Yellow
⑩ Diode assembly	Y/W Yellow/White
⑪ Rectifier/regulator	B/R Black/Red
⑫ Economy control switch	B/W Black/White
⑬ Overload indicator light	B/Y Black/Yellow
⑭ Ground (Earth) terminal	Br/W Brown/White
⑮ Speed limiter assembly	G/R Green/Red
⑯ Oil warning light	G/W Green/White
⑰ Rectifier	G/Y Green/Yellow
⑱ Diode assembly	L/G Blue/Green
⑲ Control unit (Master)	L/R Blue/Red
⑳ Interface unit	LW Blue/White
㉑ Fuse	L/Y Blue/Yellow
㉒ Oil level gauge	Or/W Orange/White
㉓ Starter relay	R/B Red/Black
㉔ Starter motor	R/L Red/Blue
㉕ Battery	R/W Red/White
㉖ T.C.I magneto	R/Y Red/Yellow
㉗ Spark plug	
㉘ T.C.I unit	
㉙ Fuel cut solenoid valve	
㉚ Main coil 2	
㉛ Thermo sencer	
㉜ Auto choke	
㉝ Throttle motor	

— MEMO —

PRINTED ON RECYCLED PAPER



YAMAHA

PRINTED IN JAPAN
2008 • 09 – 1.0 × 1 

Free Manuals Download Website

<http://myh66.com>

<http://usermanuals.us>

<http://www.somanuals.com>

<http://www.4manuals.cc>

<http://www.manual-lib.com>

<http://www.404manual.com>

<http://www.luxmanual.com>

<http://aubethermostatmanual.com>

Golf course search by state

<http://golfingnear.com>

Email search by domain

<http://emailbydomain.com>

Auto manuals search

<http://auto.somanuals.com>

TV manuals search

<http://tv.somanuals.com>