

# ZANUSSI

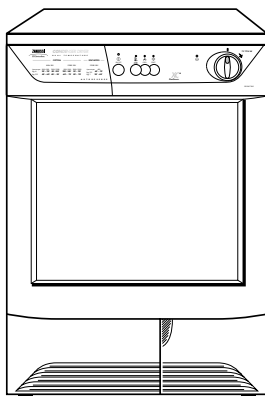

## TUMBLE DRYER TC 7114 W TC 7114 S



 **Unpacking:** see page 14



# Important Safety Information

It is most important that this instruction book should be retained with the appliance for future reference. Should the appliance be sold or transferred to another owner, or should you move house and leave the appliance, always ensure that the book is supplied with the appliance in order that the new owner can get to know the functioning of the appliance and the relevant warnings.

These warnings have been provided in the interest of safety. You **MUST** read them carefully before installing or using the appliance.

## Installation

- This appliance is heavy. Care should be taken when moving it.
- It is dangerous to alter the specifications or attempt to modify this product in any way.
- Any electrical work required to install this appliance should be carried out by a qualified electrician or competent person.
- Care must be taken to ensure that the appliance does not stand on the electrical supply cable.
- If the machine is situated on a carpeted floor, please adjust the feet in order to allow air to circulate freely.
- If the tumble dryer is placed on top of a washing machine, it is compulsory to use the stacking kit (optional accessory).

## Child Safety

- This appliance is designed to be operated by adults. Children should not be allowed to tamper with the controls or play with the product.
- Pets and children have been known to climb into tumble dryers. Please check your drum before use.
- Keep all packaging well away for children.

## Use

- Do not overload the appliance (see programme chart).
- Clothes which are dripping wet should not be placed in the dryer.
- As some bulky items such as duvets and eiderdowns should be dried in large commercial machines because of their bulk, check with the manufacturer of the item if it is suitable for drying in a domestic machine, even if the dry weight of the item is within the limit advised.
- Please make sure that no gas lighters have accidentally been left in pockets of garments to be loaded into appliance.
- **Danger of explosion:** Never tumble dry items that have been in contact with inflammable solvents (petrol, methylated spirits, dry cleaning fluid and the like). As these substance are volatile, they could cause an explosion. Tumble dry only items washed with water.
- In order to avoid danger of fires caused by excessive drying, do not use appliance to dry the following items:  
Cushions, quilts and the like (these items accumulate heat).  
Items containing rubber foam or materials similar to rubber foam.
- Leave the door slightly ajar when the appliance is not being used. This will allow the seal to be preserved.
- Clean fluff filters after using tumble dryer. To prevent fire risks, do not use the appliance if the fluff filters are damaged.
- Do not allow fluff to accumulate around the dryer.
- Under no circumstances should you attempt to repair the machine yourself. Repairs carried out by inexperienced persons may cause injury or serious malfunctioning. Contact your local Service Centre. Always insist on genuine Zanussi spare parts.

# Contents

## For the User

<b>Important Safety Information</b>	2
• Installation	2
• Child Safety	2
• Use	2
<b>Your New Tumble Dryer</b>	4
<b>Description of the Appliance</b>	4
<b>The Control Panel</b>	5
• Programme Chart	5
• Mains-on Light	5
• On/Off Button	5
• Low Temperature Button	5
• Cool Tumble Button	5
• Start Button	5
• Water Full Indicator Light	5
• Time Selector Dial	5
<b>Programme Chart</b>	6
<b>Operating Sequence</b>	7
<b>Hints &amp; Tips on Drying</b>	8
<b>Maintenance and Cleaning</b>	9
• External cleaning	9
• Cleaning the door	9
• Cleaning fluff filters	9
• Cleaning the condenser unit	9
• Emptying the water reservoir	10
• Cleaning the air intake grille	10
<b>Something Not Working</b>	11
<b>Customer Care</b>	11
<b>Guarantee Conditions</b>	12

## For the Installer

<b>Installation Instructions</b>	13
<b>Technical Specifications</b>	13
• Unpacking	14
• Positioning	14
• Stacking kit (optional accessory)	14
• Door reversal	14
• Electrical connection	14-15

## Guide to use the Instruction Book

The following symbols will be found in the text to guide you throughout the instructions:



**Safety instructions**



**Hints and tips**



**Environmental information**

# **i** Your New Tumble Dryer

This tumble dryer will give your wash that soft, relaxed feel whatever the weather.

Extremely high quality standards both during development and manufacturing guarantee a long service life for your appliance.

Maximum economy in the operation of your dryer is achieved through very frugal electricity consumption and short drying times.

## Energy saving tips

To save energy we recommend that you follow these hints:

- Try to load the maximum capacity of the machine as small loads are **uneconomical**.
- Always load well spun laundry. The higher the spin speed, the lower the electricity consumption and the shorter the drying times.
- Do not over-dry laundry, this avoids creasing and saves energy.
- Clean the filters regularly to avoid excessive drying times and high electricity consumption.
- Ventilate the room well. The room temperature should not exceed +35°C during drying.

## In the interest of the environment

- Materials marked with the symbol  are recyclable.
- Check with your local Council or Environmental Health Office to see if there are facilities in your area for re-cycling this appliance.
- When the appliance is to be scrapped, cut off the power supply cable and make the door closing device unusable to prevent young children from being trapped inside.
- Help to keep your country tidy - use authorised disposal sites for your old appliance.

How do we help to protect the environment? We use recycled paper!

# Description of the Appliance

- 1 Worktop
- 2 Programme chart
- 3 Control panel
- 4 Fluff filters
- 5 Rating Plate
- 6 Condenser unit
- 7 Water reservoir
- 8 Adjustable feet

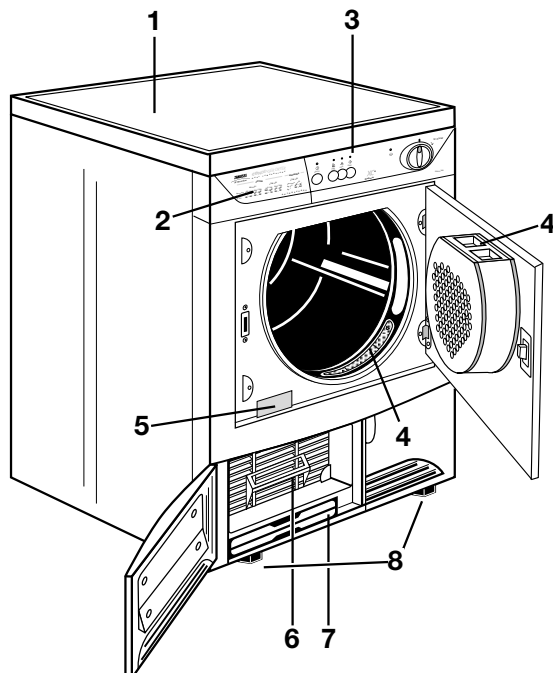

# The Control Panel

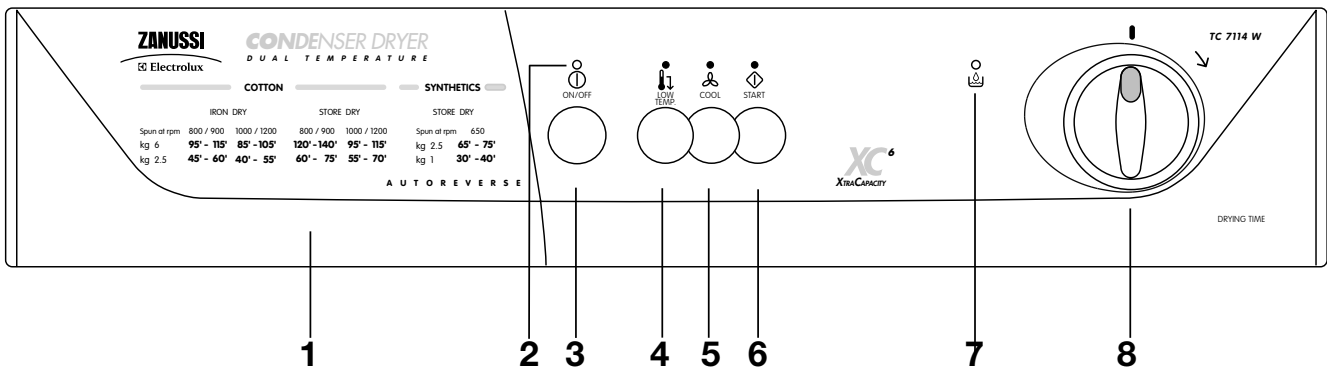

## 1 Programme Chart

This will help you to select the correct time for drying.

## 2 Mains-On Light

Comes on when the appliance is switched on (ON/OFF button pressed down) and goes out when this button is released.

## 3 ON/OFF Button

This button is used to switch the dryer on. At the end of the programme, release this button by pressing it again to switch the dryer off.

## 4 Low Temperature Button

Press this button to reduce the temperature when drying particularly delicate cotton or linen items. In this case you should select a longer drying time.

## 5 Cool Tumble Button

By depressing this button the heat is cut off. This is particularly useful to freshen the laundry (e.g. to remove a persistent odour of moth balls) or to dry extremely delicate items.

## 6 Start button

Press this button to start the dryer after having selected the programme.

**If the door of the appliance is opened while the programme is running, this button must be pressed again after closing the door in order to restart the programme from the point at which it was interrupted.**

## 7 Water Full Indicator Light

This light illuminates when the reservoir is full or improperly fitted.

## 8 Time Selector Dial

The selector dial incorporates two drying cycles, one of up to 150 minutes at a high temperature for cotton and linen, and one of up to 100 minutes at a low temperature for synthetic fabrics. To set the machine to the selected time, turn the dial clockwise until the time you want coincides exactly with the pointer.

**NEVER attempt to turn the dial in an anticlockwise direction.**

When selecting the drying time you should remember that it includes a 10 minute cooling phase (position on the dial).

This phase should not be shortened, stopped or avoided, as this could cause skin burns or damages to the laundry.

# Programme Chart

## Cottons

Selector dial up to 150 minutes (high temperature section)

Type of laundry	Degree of drying	Amount of laundry	Drying time in minutes for laundry spun at	
			800/900 rpm	1000/1200 rpm
Cotton Towelling Shirts Sheets	Store dry (wardrobe dry)	6 kg	120 - 140	95 - 115
		2.5 kg	60 - 75	55 - 70
Hand towels Tablecloths Table napkins	Iron dry (not completely dry; suitable for ironing)	6 kg	95 - 115	85 - 105
		2.5 kg	45 - 60	40 - 55

## Synthetics

Selector dial up to 100 minutes (low temperature section)

Type of laundry	Degree of drying	Amount of laundry	Drying time in minutes for laundry spun at a minimum speed of 650 rpm
Synthetics or mixed fabrics which do not require ironing.	Store dry	2.5 kg	65 - 75
		1 kg	30 - 40

**Attention!** Please follow the instructions on labels when drying mixed fabrics.

Drying times are given as a guide only and vary according to the size of the load, the type of laundry, the degree of spinning prior to drying.

Start by selecting a short drying time. If necessary, perform an additional drying cycle afterwards.

Experience will soon enable you to estimate the drying time needed for your usual laundry loads. It is advisable to take note of them.

### Size of load

It is not necessary to weigh the laundry, if these instructions are followed:

- Cottons, linen: full drum, but not overloaded.
- Synthetics: half drum.

For a mixed load (cotton and synthetics, for example) select the drying time suitable for the most delicate fabrics and then increase it by approx 10 mins.





# Operating Sequence

Before using your tumble dryer for the first time, we recommend you place a few damp cloths inside the appliance and dry for 20 minutes. There may be dust inside a brand new tumble dryer.

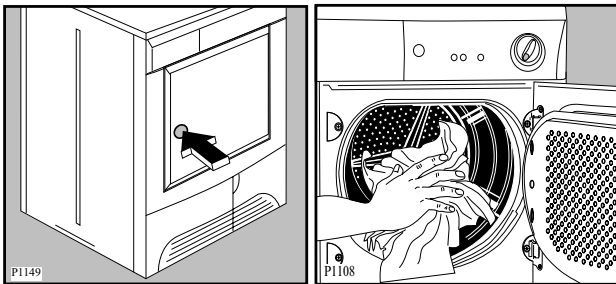
## Drying

1. Connect the appliance.
2. Open the door.



3. Load the items one at a time, shaking them out loosely.
4. Close the door. Please check the laundry does not get caught between the door and filter.
5. Press the ON/OFF button : the mains-ON light comes on.
6. Select the drying time.
7. If required, press the low temperature button  or the Cool Tumble button .
8. Press the Start button : the machine starts operating.

The drum turns alternately in both directions during drying.

All drying programmes end with a 10 minute cooling phase (position  on selector dial). The machine stops automatically at the end of this phase.

9. Release the ON/OFF button (the mains-ON light goes out) and immediately remove the laundry.

## After each use

- Switch the appliance off by releasing the ON/OFF button . The mains-ON light goes out.
- Clean the filters (see page 9).
- Empty the water reservoir (see page 10).

## Important!

If the drying programme has to be stopped before it reaches the end, we recommend that you turn the programme selector dial to position  (cooling) and wait until the end of this phase before removing the laundry. This will avoid a build-up of heat inside the appliance.

## Modifying the programme

To change a programme which is running without opening the door, first depress the ON/OFF button  and then turn the time selector dial to the required time. Press the ON/OFF button again.

# Hints & Tips on Drying

Before placing articles of laundry in your tumble dryer, check the care labels to ensure they are recommended for tumble drying.

## Care Labels you may find on your laundry

- may be tumble dried
- normal drying (high temperature)
- delicate drying (low temperature)
- do not tumble dry

 **Do not overload the appliance.**

Here is a list of the approximate weight of some common laundry items.

Sheet	700 to 1000 g
Pillowcase	100 to 200 g
Tablecloth	400 to 500 g
Table Napkin	50 to 100 g
Kitchen Towel	70 to 120 g
Linen Hand Towel	100 to 150 g
Hand Towel	150 to 250 g
Bath Towel	700 to 1000 g
Bathrobe	1000 to 1500 g
Shirt	200 to 300 g
Apron	150 to 200 g

- Always load well spun laundry. The higher the spin speed the lower the electricity consumption and the shorter the drying time.
- **DO NOT** load dripping wet laundry into the dryer. Roll the article in a towel or spin to remove excess water.
- Close poppers and zips and fasten any buttons.
- Sort the laundry. Separate synthetics from cotton/linens, and dry separately.
- Remove the laundry immediately after the programme has finished.
- Use a fabric conditioning sheet to reduce static. We recommend the sheet is pinned to an article of laundry (using a safety pin).
- Mix the load i.e. large and small articles.
- When drying large items such as sheets, we recommend you periodically stop the dryer to redistribute the load.

## **DO NOT use the tumble dryer to dry the following:**

- Articles contaminated with inflammable substances e.g. petrol, cleaning solvents, cooking oil, fats or hair lacquer.
- Woollen and synthetic/wool mixtures unless the item is labelled as suitable for tumble drying.
- Very delicate articles such as silk.
- Very large and bulky items such as duvets or sleeping bags.



# Maintenance and Cleaning

You must **disconnect** the appliance from the electricity supply, before you can carry out any cleaning or maintenance work.

## External cleaning

Use only soap and water and then dry thoroughly.

**Important:** do not use methylated spirit, diluents or similar products.

## Cleaning the door

Clean periodically the interior part of the door to remove any fluff from the seals around the filter. Regular cleaning ensures correct drying.

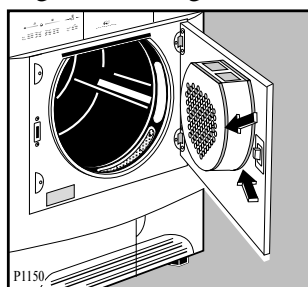

## Cleaning the filters

Your dryer will only function well if the filters are clean.

The filters collect all the fluff which accumulates during drying and they must therefore be cleaned at the end of each programme, before removing the laundry, with a damp cloth.

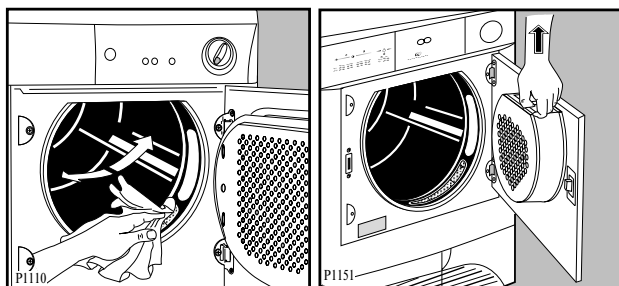

The filter in the inner door must be removed for cleaning.

Do not be alarmed by the amount of fluff. It is not due to excessive wear caused by the dryer. All fabric loses fluff when drying but it goes un-noticed in the air. In a tumble dryer it simply collects in the filter.

After a while, a whitish film due to detergent residue on laundry forms on the filters. When this occurs, clean the filters (specially the filter in the door opening) with warm water using a brush. Remove it as per picture (it can be positioned with the tooth facing to the left or to the right).

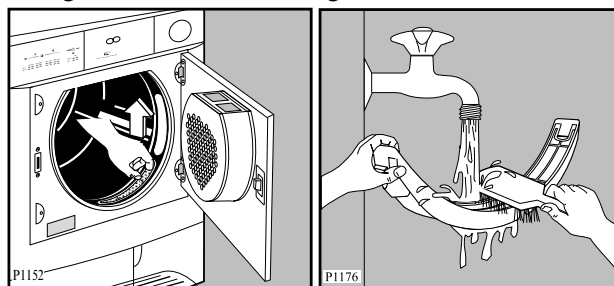

 **Do not use the appliance without filters.**

## Cleaning the condenser unit

Clean the air condenser periodically, 3 or 4 times a year depending on how frequently the dryer is used. The condenser is situated at the lower part of the cabinet behind a small door. To open the door, push the catch as per picture.

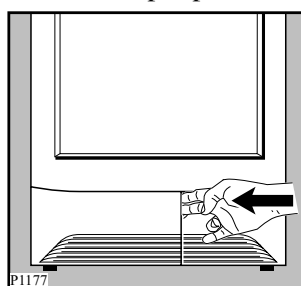

To pull out the condenser, first turn the two red stops inwards as shown and then remove the condenser unit holding it at the handle.

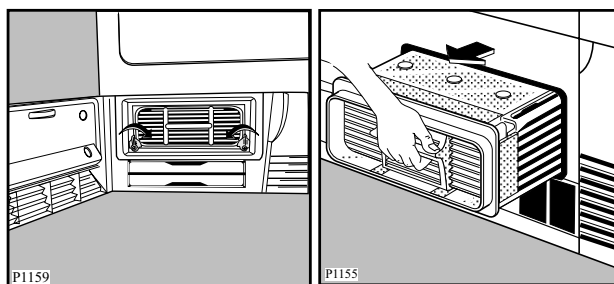

 It is quite normal to find droplets of water on top of or at the front of the condenser unit. This is not a fault with the appliance.

Clean it with a brush and rinse it under the shower if necessary.

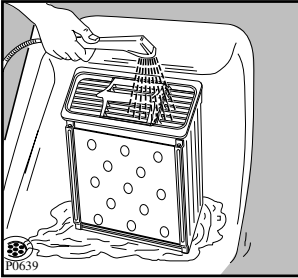

Also clean the outside, removing all fluff.

Clean the rubber seal round the condenser cabinet and in the inner part of the small door with a damp cloth.

**Important!** Do not use pointed objects or utensils to clean the spaces between the plates, as this could damage the condenser and make it permeable.

Re-fit the condenser, turn the red stops upwards and close the door.



**Do not use this appliance if the condenser has not been fitted.**

---

## Emptying the water reservoir

Water extracted from the laundry condenses inside the machine and is collected in a reservoir.

The reservoir must be emptied after each drying cycle to ensure efficient operation when the machine is next used.

If this is not done a safety device trips: pilot light  on the control panel comes on and the programme stops, leaving the laundry damp.

The reservoir can be emptied even in the middle of a programme.

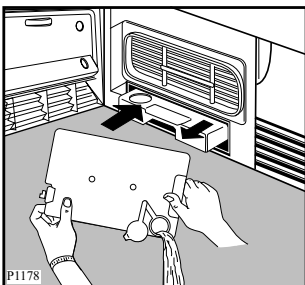

**The reservoir must be re-inserted correctly. Push it until it clicks.**

After inserting the reservoir the programme will continue after about 20 seconds.

**Handy tip:** The condensed water may be used in a steam iron or to top up a battery, etc. In this case it must be filtered (e.g. through a coffee filter).

## Cleaning the air intake grille



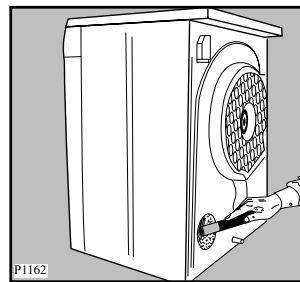

Using a vacuum cleaner remove the fluff from the air intake grille at the back of the appliance.



# Something Not Working

Certain problems are due to lack of simple maintenance or oversights, which can be solved easily without calling out an engineer. Before contacting your local Service Centre, please carry out the checks listed below.

**IMPORTANT:** if you call out an engineer to a fault listed below, or to repair a fault caused by incorrect use or installation, a charge will be made even if the appliance is under guarantee.

Symptom	Possible causes
<b>The tumble dryer does not start</b>	<ul style="list-style-type: none"> <li>• The door(s) has(have) not been closed.</li> <li>• The plug is not properly inserted in the power socket.</li> <li>• There is no current at the socket.</li> <li>• The main fuse or the fuse in the plug has blown.</li> <li>• The selector dial is not set correctly.</li> <li>• The water reservoir is full or not properly inserted (the pilot light  is on).</li> <li>• The Start Button  has not been depressed.</li> </ul>
<b>Drying takes too long or laundry is not dry enough.</b>	<ul style="list-style-type: none"> <li>• The laundry has not been spun properly.</li> <li>• The filters and/or the condenser are clogged up.</li> <li>• The water reservoir is full.</li> <li>• The room temperature is too high.</li> <li>• The selected time or sector was not suitable for the laundry.</li> <li>• The low temperature  or cool tumble  function has been selected.</li> <li>• There is too much laundry inside the appliance.</li> <li>• The dryer is not correctly installed.</li> </ul>

If after the above checks, there is still a fault, call your local Service Force Centre.

## Service & Spare Parts **SERVICEFORCE**

In the event of your appliance requiring service, or if you wish to purchase spare parts, please contact your local Service Force Centre by telephoning:

**0870 5 929929**

Your telephone call will be automatically routed to the Service Force Centre covering your post code area.

For the address of your local Service Force Centre and further information about Service Force, please visit the website at [www.serviceforce.co.uk](http://www.serviceforce.co.uk).

For Customer Service in Ireland please contact us at the address below:

Zanussi Electrolux  
Electrolux Group (Irl) Ltd  
Long Mile Road  
Dublin 12  
Republic of Ireland

Tel: +353 (0)1 4090751

Email: [service.eid@electrolux.ie](mailto:service.eid@electrolux.ie)

Before calling out an engineer, please ensure you have read the details under the heading "Something Not Working".

When you contact the Service Force Centre you will need to give the following details:

1. Your name, address and post code
2. Your telephone number
3. Clear and concise details of fault
4. The model and serial number of the appliance (found on the rating plate)
5. The purchase date.

**Please note that a valid purchase receipt or guarantee documentation is required for in-guarantee service calls.**

## Customer Care Department

For general enquiries concerning your Zanussi Electrolux appliance or for further information on Zanussi Electrolux products, please contact our Customer Care Department by letter or telephone at the address below or visit our website at [www.zanussi.co.uk](http://www.zanussi.co.uk)

Customer Care Department  
Zanussi Electrolux  
55-77 High Street  
Slough  
Berkshire  
SL1 1DZ  
Tel 08705 727727\*

\* calls to this number may be recorded for training purposes.

# Guarantee Conditions

## Standard guarantee conditions

We, Zanussi Electrolux, undertake that if, within 12 months of the date of the purchase, this ZANUSSI ELECTROLUX appliance or any part thereof is proved to be defective by reason only of faulty workmanship or materials, we will, at our option repair or replace the same FREE OF ANY CHARGE for labour, materials or carriage on condition that:

- The appliance has been correctly installed and used only on the electricity supply stated on the rating plate.
- The appliance has been used for normal domestic purposes only, and in accordance with the manufacturer's instructions.
- The appliance has not been serviced, maintained, repaired, taken apart or tampered with, by any person not authorised by us.
- All service work under this guarantee must be undertaken by a Service Force Centre.
- Any appliance or defective part replaced shall become the Company's property.
- This guarantee is in addition to your statutory and other legal rights.

Home visits are made between **8.30am** and **5.30pm** Monday to Friday. Visits may be available outside these hours in which case a **premium** will be charged.

## Exclusions

### This guarantee does not cover:

- Damage or calls resulting from transportation, improper use or neglect, the replacement of any light bulbs or removable parts of glass or plastic.
- Costs incurred for calls to put right an appliance which is improperly installed or calls to appliances outside the United Kingdom.

- Appliances found to be in use within a commercial environment, plus those which are subject to rental agreements.
- Products of Zanussi Electrolux manufacture which are NOT marketed by Zanussi Electrolux.

## European guarantee



If you should move to another country within Europe then your guarantee moves with you to your new home subject to the following qualifications:

- The guarantee starts from the date you first purchased your product.
- The guarantee is for the same period and to the same extent for labour and parts as exists in the new country of use for this brand or range of products.
- The guarantee relates to you and cannot be transferred to another user.
- Your new home is within the European Community (EC) or European Free Trade Area.
- The product is installed and used in accordance with our instructions and is only used domestically, i.e. a normal household.
- The product is installed taking into account regulations in your new country.

Before you move please contact your nearest Customer Care Centre, listed below, to give them details of your new home. They will then ensure that the local Service Organisation is aware of your move and able to look after you and your appliances.

France	Senlis	+33 (0) 344 62 29 29
Germany	Numberg	+49 (0) 800 234 7378
Italy	Pordenone	+39 0434 39 4700
Sweden	Stockholm	+46 (0) 8 672 53 90
UK	Slough	+44 (0) 1753 219897
Ireland	Dublin	+353 (0)1 4090751

# Installation Instructions

-  It is dangerous to alter the specifications or attempt to modify this product in any way.
-  Care must be taken to ensure that the appliance does not stand on the electrical supply cable.

-  Any electrical work required to install this appliance should be carried out by a qualified electrician or competent person.

# Technical Specifications

DIMENSIONS	Height Width Depth	85 cm (33.5") 60 cm (23.6") 58 cm (22.8")
POWER SUPPLY VOLTAGE TOTAL POWER ADSORBED		230-240 V/50 Hz 2450 W (13A)
MAX LOAD CAPACITY	Cotton, linen Synthetics	6 kg (13.2 lbs) 2.5 kg ( 5.5 lbs)
DRUM VOLUME		108 l
CONSUMPTIONS	Cotton, linen Cotton, linen Synthetics	4.37 kWh (6 kg store dry) 3.6 kWh (6 kg iron dry) 1.4 kWh (2,5 kg store dry)

- CE** This appliance complies with the following E.E.C. Directives:
- 73/23 EEC of 19.2.73 (Low Voltage Directive) and subsequent modifications;
  - 89/336 EEC of 3.5.89 (Electromagnetic Compatibility Directive) and subsequent modifications.

## Unpacking

### Warning !

 Slide out the polythene bag containing the polystyrene block before using the appliance.

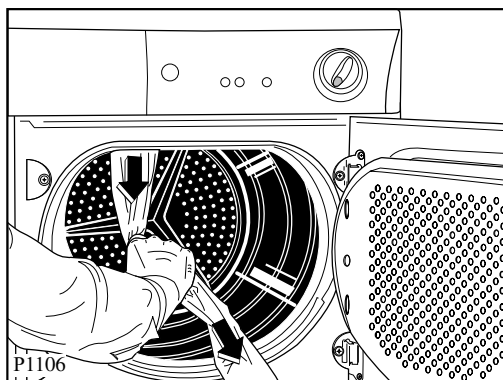

 **Should the appliance be moved, it must be transported vertically.**

## Positioning

It is recommended that, for your convenience, the machine is positioned close to your washing machine.

The tumble dryer must be installed in a clean place, where dirt does not build up.

Air must be able to circulate freely all round the appliance. Do not obstruct the front ventilation grille or the air intake grilles at the back of the machine.

To keep vibration and noise to a minimum when the dryer is in use, it should be placed on a firm, level surface.

Once in its permanent operating position, check that the dryer is absolutely level with the aid of a spirit level. If it is not, raise or lower the feet until it is.

**The feet must never be removed.**

**Do not restrict the floor clearance through deep-pile carpets, strips of wood or similar. This might cause heat build-up which would interfere with the operation of the appliance.**

### Important

The hot air emitted by the tumble dryer can reach temperatures of up to 60°C. The appliance must therefore not be installed on floors which are not resistant to high temperatures.

When operating the tumble dryer, the room temperature must not be lower than +5°C and higher than +35°C, as it may affect the performance of the appliance.

## Stacking kit (optional accessory)

It should be possible to stack your new dryer on top of a front loading washing machine with a worktop depth of between 48 and 60 cm.

The instructions are supplied with the kit.

Please contact your local Service Force Centre for further advice.

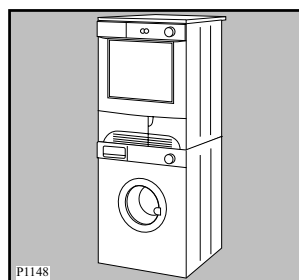

## Door reversal

To make it easier to load or unload the laundry the door can be reversed.

**This operation must be carried out by qualified personnel.**

Please contact the nearest Service Force Centre.

## Electrical connection

Any electrical work required to install this appliance should be carried out by a qualified electrician or competent person.

 **WARNING: THIS APPLIANCE MUST BE EARTHED.**

**The manufacturer declines any liability should this safety measure not be observed. Should the appliance power supply cable need to be replaced, this should be carried out by our Service Centre.**

Before switching on, make sure the electricity supply voltage is the same as that indicated on the appliance's rating plate. (See picture on page 4).

The appliance is supplied with a 13amp plug fitted. In the event of having to change the fuse in the plug supplied, a 13amp ASTA approved (BS 1363/A) fuse must be used.

Should the plug need to be replaced for any reason, proceed as described below.  
The wires in the mains lead are coloured in accordance with the following code:

Green and Yellow - Earth  
Blue - Neutral  
Brown - Live

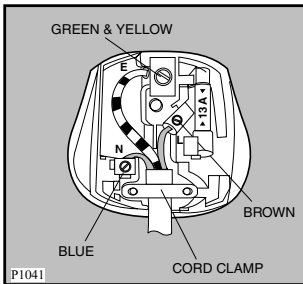

The wire coloured green and yellow must be connected to the terminal marked with the letter «E» or by the earth symbol  $\perp$  or coloured green and yellow.

The wire coloured blue must be connected to the terminal «N» or coloured black.

The wire coloured brown must be connected to the terminal marked «L» or coloured red.

Upon completion there must be no cut, or stray strands of wire present and the cord clamp must be secure over the outer sheath.

---

**WARNING:**



**A cut off plug inserted into a 13 amp socket is a serious safety (shock) hazard. Ensure that the cut off plug is disposed of safely.**

---

## Permanent connection

In the case of permanent connection it is necessary that you install a double pole switch between the appliance and the electricity supply (mains), with a minimum gap of 3mm between the switch contacts and of a type suitable for the required load in compliance with the current electrical regulations.

The switch must not break the yellow and green earth cable at any point.

 **From the Electrolux Group. The world's No. 1 choice.**

*The Electrolux Group is the world's largest producer of powered appliances for kitchen, cleaning and outdoor use. More than 55 million Electrolux Group products (such as refrigerators, cookers, washing machines, vacuum cleaners, chain saws and lawn mowers) are sold each year to a value of approx. USD 14 billion in more than 150 countries around the world.*

© Electrolux plc 2003



## Free Manuals Download Website

<http://myh66.com>

<http://usermanuals.us>

<http://www.somanuals.com>

<http://www.4manuals.cc>

<http://www.manual-lib.com>

<http://www.404manual.com>

<http://www.luxmanual.com>

<http://aubethermostatmanual.com>

Golf course search by state

<http://golfingnear.com>

Email search by domain

<http://emailbydomain.com>

Auto manuals search

<http://auto.somanuals.com>

TV manuals search

<http://tv.somanuals.com>